



# FCC TEST REPORT for CDMA

## (PART 22)

**REPORT NO.:** RF950803L01

**MODEL NO.:** MC7095

**RECEIVED:** Jul. 28, 2006

**TESTED:** Jul. 28 ~ Sep. 01, 2006

**ISSUED:** Sep. 05, 2006

**APPLICANT:** Symbol Technologies, Inc.

**ADDRESS:** One Symbol Plaza, Holtsville, NY 11742, U.S.A.

**ISSUED BY:** Advance Data Technology Corporation

**LAB ADDRESS:** No. 47, 14th Ling, Chia Pau Tsuen, Lin Kou Hsiang  
244, Taipei Hsien, Taiwan, R.O.C.

**TEST LOCATION:** No. 19, Hwa Ya 2<sup>nd</sup> Rd., Wen Hwa Tsuen, Kwei  
Shan Hsiang, Taoyuan Hsien 333, Taiwan, R.O.C.

This test report consists of 48 pages in total. It may be duplicated completely for legal use with the approval of the applicant. It should not be reproduced except in full, without the written approval of our laboratory. The client should not use it to claim product endorsement by CNLA, A2LA or any government agencies. The test results in the report only apply to the tested sample.





## TABLE OF CONTENTS

1	CERTIFICATION .....	4
2	SUMMARY OF TEST RESULTS .....	5
2.1	MEASUREMENT UNCERTAINTY .....	6
3	GENERAL INFORMATION .....	7
3.1	GENERAL DESCRIPTION OF EUT .....	7
3.2	DESCRIPTION OF TEST MODES .....	9
3.3	GENERAL DESCRIPTION OF APPLIED STANDARDS .....	10
3.4	DESCRIPTION OF SUPPORT UNITS .....	10
4	TEST TYPES AND RESULTS .....	11
4.1	OUTPUT POWER MEASUREMENT .....	11
4.1.1	LIMITS OF OUTPUT POWER MEASUREMENT .....	11
4.1.2	TEST INSTRUMENTS .....	12
4.1.3	TEST PROCEDURES .....	13
4.1.4	TEST SETUP .....	14
4.1.5	EUT OPERATING CONDITIONS .....	15
4.1.6	TEST RESULTS .....	16
4.2	FREQUENCY STABILITY MEASUREMENT .....	18
4.2.1	LIMITS OF FREQUENCY STABILITY MEASUREMENT .....	18
4.2.2	TEST INSTRUMENTS .....	18
4.2.3	TEST PROCEDURE .....	19
4.2.4	TEST SETUP .....	19
4.2.5	TEST RESULTS .....	20
4.3	OCCUPIED BANDWIDTH MEASUREMENT .....	21
4.3.1	LIMITS OF OCCUPIED BANDWIDTH MEASUREMENT .....	21
4.3.2	TEST INSTRUMENTS .....	21
4.3.3	TEST SETUP .....	21
4.3.4	TEST PROCEDURES .....	22
4.3.5	EUT OPERATING CONDITION .....	22
4.3.6	TEST RESULTS .....	22
4.4	BAND EDGE MEASUREMENT .....	25
4.4.1	LIMITS OF BAND EDGE MEASUREMENT .....	25
4.4.2	TEST INSTRUMENTS .....	25
4.4.3	TEST SETUP .....	25
4.4.4	TEST PROCEDURES .....	26
4.4.5	EUT OPERATING CONDITION .....	26
4.4.6	TEST RESULTS .....	27
4.5	CONDUCTED SPURIOUS EMISSIONS .....	28
4.5.1	LIMITS OF CONDUCTED SPURIOUS EMISSIONS MEASUREMENT .....	28
4.5.2	TEST INSTRUMENTS .....	28
4.5.3	TEST PROCEDURE .....	29
4.5.4	TEST SETUP .....	29
4.5.5	EUT OPERATING CONDITIONS .....	29
4.5.6	TEST RESULTS .....	30



4.6	RADIATED EMISSION MEASUREMENT (BELOW 1GHz).....	36
4.6.1	LIMITS OF RADIATED EMISSION MEASUREMENT .....	36
4.6.2	TEST INSTRUMENTS.....	37
4.6.3	TEST PROCEDURES .....	38
4.6.4	DEVIATION FROM TEST STANDARD .....	38
4.6.5	TEST SETUP.....	39
4.6.6	EUT OPERATING CONDITIONS .....	39
4.6.7	TEST RESULTS .....	40
4.7	RADIATED EMISSION MEASUREMENT (ABOVE 1GHz) .....	41
4.7.1	LIMITS OF RADIATED EMISSION MEASUREMENT .....	41
4.7.2	TEST INSTRUMENTS.....	42
4.7.3	TEST PROCEDURES .....	43
4.7.4	DEVIATION FROM TEST STANDARD .....	43
4.7.5	TEST SETUP .....	44
4.7.6	EUT OPERATING CONDITIONS .....	44
4.7.7	TEST RESULTS .....	45
5	INFORMATION ON THE TESTING LABORATORIES .....	48



# 1 CERTIFICATION

**PRODUCT :** Enterprise Digital Assistant  
**MODEL :** MC7095  
**BRAND :** Symbol  
**APPLICANT :** Symbol Technologies, Inc.  
**TESTED :** Jul. 28 ~ Sep. 01, 2006  
**TEST SAMPLE :** PROTOTYPE  
**TEST STANDARDS :** FCC Part 22, Subpart H  
ANSI C63.4-2003

The above equipment has been tested by **Advance Data Technology Corporation**, and found compliance with the requirement of the above standards. The test record, data evaluation & Equipment Under Test (EUT) configurations represented herein are true and accurate accounts of the measurements of the sample's EMC characteristics under the conditions specified in this report.

**PREPARED BY :** Rennie Wang , **DATE:** Sep. 05, 2006  
Rennie Wang

**TECHNICAL ACCEPTANCE :** Long Chen , **DATE:** Sep. 05, 2006  
Responsible for RF Long Chen

**APPROVED BY :** Gary Chang , **DATE:** Sep. 05, 2006  
Gary Chang / Supervisor

## 2 SUMMARY OF TEST RESULTS

The EUT has been tested according to the following specifications:

APPLIED STANDARD: FCC Part 22 & Part 2 / IC RSS-132			
STANDARD SECTION	TEST TYPE AND LIMIT	RESULT	REMARK
2.1046 22.913 (a)	Maximum Peak Output Power Limit: max. 7 watts e.r.p peak power	PASS	Meet the requirement of limit. Minimum passing margin is 20.86dBm at 824.70MHz.
2.1055	Frequency Stability AFC Freq. Error vs. Voltage AFC Freq. Error vs. Temperature Limit: max. $\pm 2.5$ ppm	PASS	Meet the requirement of limit.
2.1049 (h)	Occupied Bandwidth	PASS	Meet the requirement of limit.
22.917	Band Edge Measurements	PASS	Meet the requirement of limit.
2.1051 22.917	Conducted Spurious Emissions	PASS	Meet the requirement of limit.
2.1053 22.917	Radiated Spurious Emissions	PASS	Meet the requirement of limit. Minimum passing margin is $-34.56$ dB at 887.25MHz.

## 2.1 MEASUREMENT UNCERTAINTY

Where relevant, the following measurement uncertainty levels have been estimated for tests performed on the EUT as specified in CISPR 16-4:

MEASUREMENT	FREQUENCY	UNCERTAINTY
Conducted emissions	9kHz ~ 30MHz	2.44 dB
Radiated emissions	30MHz ~ 200MHz	3.62 dB
	200MHz ~1000MHz	3.64 dB
	1GHz ~ 18GHz	2.26 dB
	18GHz ~ 40GHz	1.94 dB

This uncertainty represents an expanded uncertainty expressed at approximately the 95% confidence level using a coverage factor of  $k=2$ .



### 3 GENERAL INFORMATION

#### 3.1 GENERAL DESCRIPTION OF EUT

<b>PRODUCT</b>	Enterprise Digital Assistant
<b>MODEL NO.</b>	MC7095
<b>FCC ID</b>	H9PMC7095
<b>POWER SUPPLY</b>	3.7Vdc from rechargeable lithium battery 5.4Vdc from power adapter for charger 12.0Vdc from power adapter for cradle
<b>MODULATION TYPE</b>	HPSK
<b>FREQUENCY RANGE</b>	Tx Frequency: 824MHz ~ 849MHz Rx Frequency: 869MHz ~ 894MHz
<b>NUMBER OF CHANNEL</b>	788
<b>MAX. CONDUCTED PEAK OUTPUT POWER</b>	24.30dBm (0.26915Watts)
<b>MAX. ERP POWER</b>	23.01dBm (0.19999Watts)
<b>ANTENNA TYPE</b>	Monopole antenna with 0.79dBi gain for CDMA850 Monopole antenna with 1.11dBi gain for CDMA1900
<b>DATA CABLE</b>	0.92m non-shielded cable for earphone
<b>I/O PORTS</b>	Refer to user's manual
<b>ASSOCIATED DEVICES</b>	Earphone, cradle
<b>EUT EXTREME VOL. RANGE</b>	3.3Vdc to 4.2Vdc

**NOTE:**

1. The EUT is an EDA (Enterprise Digital Assistant) with Wireless LAN, bluetooth and mobile phone functions. This report is only covered the functions of CDMA850. The Wireless LAN and bluetooth functions are covered in another test report, which standard used is FCC Part 15. And the CDMA1900 mobile phone function is covered in another test report, which standard used is FCC Part 24.
2. The EUT have two lithium batteries listed as below:

<b>HEAVY BATTERY:</b>	
<b>BRAND:</b>	Symbol
<b>MODEL:</b>	82-71364-02
<b>RATING:</b>	3.7Vdc, 3800mAh

MAIN BATTERY:	
<b>BRAND:</b>	Symbol
<b>MODEL:</b>	82-71363-02
<b>RATING:</b>	3.7Vdc, 1900mAh

3. The cradle was operated with following power adapter:

<b>BRAND:</b>	HIPRO
<b>MODEL:</b>	HP-O2040D43
<b>INPUT:</b>	100-240Vac, 50-60Hz, 1.5A
<b>OUTPUT:</b>	12Vdc, 3.33A
<b>POWER LINE:</b>	AC 1.8m non-shielded cable without core DC 1.8m non-shielded cable with one core

4. The charging cable was operated with following power adapter:

<b>BRAND:</b>	Delta
<b>MODEL:</b>	ADP-16GB A
<b>INPUT:</b>	100-240Vac, 50-60Hz, 0.4A
<b>OUTPUT:</b>	5.4Vdc, 3A
<b>POWER LINE:</b>	AC 0.7m non-shielded cable without core DC 1.87m non-shielded cable with one core

5. Emission of Inter-modulation has been evaluated and is compliance with related rule.
6. Standalone has been investigated in the pretest and final test represent the worst case.
7. Software version: 02.24.0000.
8. Hardware version:
  - ◆ IPL version: 01.39.412.
  - ◆ Power Micro: 11.27.0005.
  - ◆ CPLD version: 02.00.
9. The above EUT information was declared by manufacturer and for more detailed features description, please refer to the manufacturer's specifications or User's Manual.



### 3.2 DESCRIPTION OF TEST MODES

788 channels are provided to this EUT in the CDMA850 band. Therefore, the low, middle and high channels are chosen for testing.

	CHANNEL	FREQUENCY	TX MODE
LOW	1013	824.12 MHz	CDMA
MIDDLE	384	836.58 MHz	CDMA
HIGH	777	848.76 MHz	CDMA

**NOTE:**

1. Below 1 GHz, the channel 1013, 384 and 777 were pre-tested in chamber. The channel 1013 was chosen for final test.
2. Above 1 GHz, the channel 1013, 384 and 777 were tested individually.
3. The channel space is 0.03MHz.
4. Since the EUT is considered a portable unit, it was pre-tested on the positioned of each 3 axis. The worst case was found when positioned on Y-plane. Therefore only the test data of this Y-plane was used for radiated emission measurement test.
5. The EDA supports two battery options, Heavy (high capacity) and Main (normal). Both options were assessed and the heavy battery was found to be worst case and was selected for the final test configuration.
6. In this report, CDMA2000 1xEV-DO was the worst case, therefore, only the data was recorded in the following section.



### 3.3 GENERAL DESCRIPTION OF APPLIED STANDARDS

The EUT is a Enterprise Digital Assistant. According to the specifications of the manufacturer, it must comply with the requirements of the following standards:

**FCC 47 CFR Part 2**

**FCC 47 CFR Part 22**

**IC RSS-132**

**ANSI C63.4-2003**

**ANSI/TIA/EIA-603-A**

**NOTE:** All test items have been performed and recorded as per the above standards.

### 3.4 DESCRIPTION OF SUPPORT UNITS

The EUT has been tested as an independent unit together with other necessary accessories or support units. The following support units or accessories were used to form a representative test configuration during the tests.

NO.	PRODUCT	BRAND	MODEL NO.	SERIAL NO.	CAL. DATE
1	Universal Radio Communication Tester	R&S	CMU200	104484	Jan. 23, 2007

NO.	SIGNAL CABLE DESCRIPTION OF THE ABOVE SUPPORT UNITS
1	NA

**NOTE:** All power cords of the above support units are non shielded (1.8m).

## **4 TEST TYPES AND RESULTS**

### **4.1 OUTPUT POWER MEASUREMENT**

#### **4.1.1 LIMITS OF OUTPUT POWER MEASUREMENT**

The radiated peak output power shall be according to the specific rule Part 22.913 (a) that "Mobile / Portable station are limited to 7 watts e.r.p".



#### 4.1.2 TEST INSTRUMENTS

DESCRIPTION & MANUFACTURER	MODEL NO.	SERIAL NO.	CALIBRATED UNTIL
Test Receiver ROHDE & SCHWARZ	ESI7	838496/016	Jan. 01, 2007
Spectrum Analyzer ROHDE & SCHWARZ	FSP40	100041	Dec. 04, 2006
BILOG Antenna SCHWARZBECK	VULB9168	9168-155	Jan. 15, 2007
HORN Antenna SCHWARZBECK	BBHA 9120D	9120D-404	Jan. 01, 2007
HORN Antenna SCHWARZBECK	BBHA 9170	BBHA9170242	Jan. 19, 2007
Preamplifier Agilent	8449B	3008A01960	Nov. 09, 2006
RF signal cable HUBER+SUHNNER	SUCOFLEX 104	219268/4	Dec. 20, 2006
RF signal cable HUBER+SUHNNER	SUCOFLEX 104	230129/4	Dec. 20, 2006
Software ADT.	ADT_Radiated_V5.14	NA	NA
Antenna Tower inn-co GmbH	MA 4000	010303	NA
Antenna Tower Controller inn-co GmbH	CO2000	019303	NA
Turn Table ADT.	TT100.	TT93021704	NA
Turn Table Controller ADT.	SC100.	SC93021704	NA

- NOTE:**
1. The calibration interval of the above test instruments is 12 months and the calibrations are traceable to NML/ROC and NIST/USA.
  2. The test was performed in HwaYa Chamber 4.
  3. The horn antenna and HP preamplifier (model: 8449B) are used only for the measurement of emission frequency above 1GHz if tested.
  4. The IC Site Registration No. is IC4924-4.

#### 4.1.3 TEST PROCEDURES

- a. The EUT was set up for the maximum peak power with CDMA link data modulation. The power was measured with R&S Spectrum Analyzer. All measurements were done at 3 channels, 1013, 384 and 777 (low, middle and high operational frequency range.)
- b. The conducted peak output power used the power splitter via EUT RF power connector between simulation base station and spectrum analyzer. The path loss included the splitter loss, cable loss and 20dB pad loss. The spectrum set RB/VB 3MHz, then read peak power value and record to the test. (All transmitted path loss shall be considered in the test report data.)
- c. E.I.R.P peak power measurement. In the fully anechoic chamber, EUT placed on the 1.5m height of Turn Table, rotated the table around 360 degrees to search the maximum radiation power and receiver antenna shall be rotated vertical and horizontal polarization to find the maximum polar radiated power. The “Read Value” is the spectrum reading the maximum power value.
- d. The substitution horn antenna is substituted for EUT at the same position and signals generator export the CW signal to the calibration antenna. Rotated the Turn Table to find the maximum radiation power. “Raw” is the spectrum reading value, “SG” is signal generator export power, “TX Gain” is calibration antenna isotropic gain value, “TX cable” is the transmitted cable loss between the calibration antenna and signal generator. The “Factor” means that the transmission path loss is equal to “SG” - “TX cable” + “TX Gain” – “Raw”.
- e. Actually the real E.I.R.P peak power is equal to “Read Value” + “Factor”
- f. E.R.P power can be calculated form E.I.R.P power by subtracting the gain of dipole, E.R.P power = E.I.P.R power - 2.15dBi.

#### 4.1.4 TEST SETUP

##### EIRP POWER MEASUREMENT:

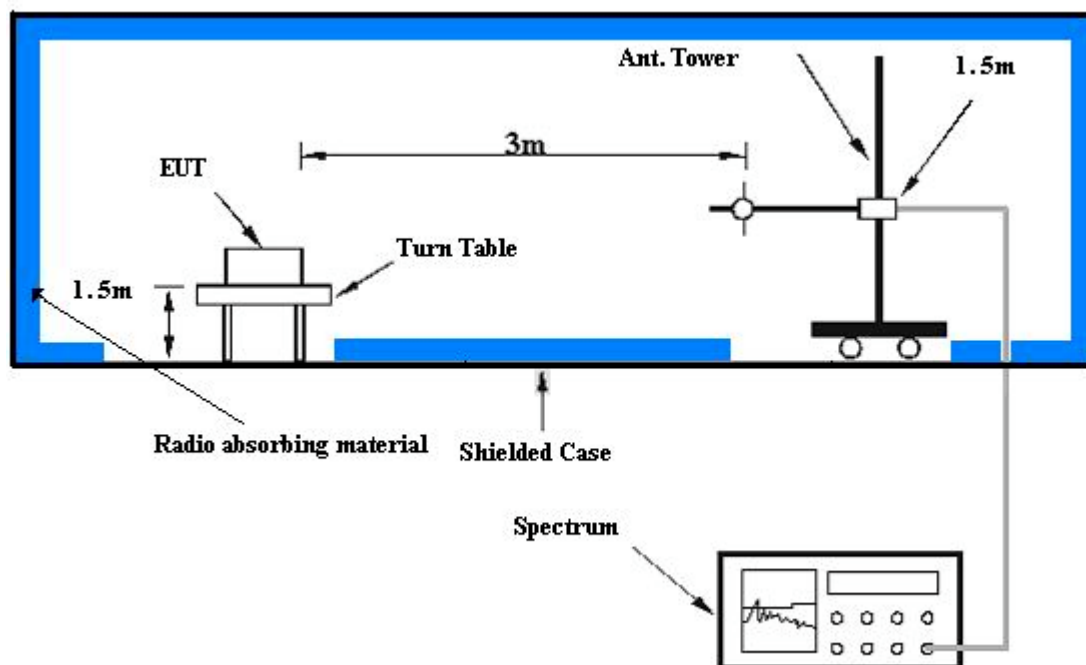

For the actual test configuration, please refer to the related item – Photographs of the Test Configuration.

##### CONDUCTED POWER MEASUREMENT:

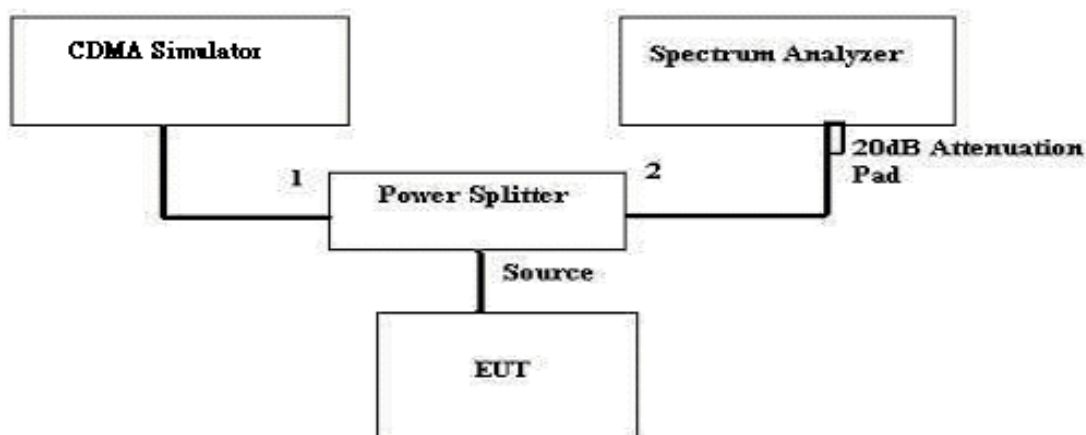

For the actual test configuration, please refer to the related item – Photographs of the Test Configuration.

#### 4.1.5 EUT OPERATING CONDITIONS

- a. The EUT makes a phone call to the CDMA simulator.
- b. The CDMA simulator station system controlled a EUT to export maximum output power under transmission mode and specific channel frequency.



#### 4.1.6 TEST RESULTS

<b>MODE</b>	TX connected	<b>DETECTOR FUNCTION</b>	Average
<b>INPUT POWER (SYSTEM)</b>	120Vac, 60 Hz	<b>ENVIRONMENTAL CONDITIONS</b>	26deg. C, 65%RH, 991hPa
<b>TESTED BY</b>	Long Chen		

CDMA 2000 1x EV-DO CONDUCTED POWER								
CHANNEL	FREQ. (MHz)	RAW VALUE (dBm)		CORR. FACTOR (dB)	PEAK OUTPUT POWER			
					RTAP		FTAP	
		RTAP	FTAP		dBm	Watt	dBm	Watt
1013	824.12	23.50	23.70	0.60	24.10	0.25704	24.30	0.26915
384	836.58	23.40	23.60	0.60	24.00	0.25119	24.20	0.26303
777	848.76	23.50	23.60	0.60	24.10	0.25704	24.20	0.26303

- REMARKS:** 1. Peak Output Power (dBm) = Raw Value (dBm) + Correction Factor (dB).  
 2. Correction Factor (dB) = Power Splitter Loss (dB) + Cable Loss (dB).

CDMA 2000 CONDUCTED POWER									
CHANNEL	FREQ. (MHz)	CDMA 2000	RAW VALUE (dBm)			CORR. FACTOR (dB)	PEAK OUTPUT POWER (dBm)		
			RC	SO2	SO55		TDSO SO32	SO2	SO55
1013	824.12	RC1	23.02	23.21	NA	0.60	23.62	23.81	NA
		RC3	23.24	23.12	23.35	0.60	23.84	23.72	23.95
384	836.58	RC1	22.89	22.94	NA	0.60	23.49	23.54	NA
		RC3	22.98	23.08	23.05	0.60	23.58	23.68	23.65
777	848.76	RC1	23.25	23.37	NA	0.60	23.85	23.97	NA
		RC3	23.36	23.29	22.41	0.60	23.96	23.89	23.01

- REMARKS:** 1. Peak Output Power (dBm) = Raw Value (dBm) + Correction Factor (dB).  
 2. Correction Factor (dB) = Power Splitter Loss (dB) + Cable Loss (dB).





<b>MODE</b>	TX connected	<b>DETECTOR FUNCTION</b>	Average
<b>INPUT POWER (SYSTEM)</b>	120Vac, 60 Hz	<b>ENVIRONMENTAL CONDITIONS</b>	26deg. C, 65%RH, 991hPa
<b>TESTED BY</b>	Long Chen		

ERP POWER					
CHANNEL NO.	FREQUENCY (MHz)	RAW VALUE (dBm)	CORRECTION FACTOR (dB)	PEAK OUTPUT POWER	
				dBm	Watt
1013	824.12	-17.02	40.03	23.01	0.19999
384	836.58	-17.74	40.32	22.58	0.18113
777	848.76	-17.81	40.62	22.81	0.1910

- REMARKS:** 1. Peak Output Power (dBm) = Raw Value (dBm) + Correction Factor (dB).  
 2. Correction Factor (dB) = Receiver Antenna Gain (dBi) + Cable Loss (dB) + Free Space Loss (dB).

FUNDAMENTAL FREQUENCY RADIATED EMISSION						
Channel No.	Freq. (MHz)	Emission Level (dBuV/m)	Antenna Height (m)	Table Angle (Degree)	Raw Value (dBuV)	Correction Factor (dB/m)
1013	824.12	123.60	1.00	218	97.18	26.42
384	836.58	122.74	1.01	220	96.17	26.57
777	848.76	123.20	1.01	227	96.48	26.72



## 4.2 FREQUENCY STABILITY MEASUREMENT

### 4.2.1 LIMITS OF FREQUENCY STABILITY MEASUREMENT

According to the FCC part 2.4235 shall be tested the frequency stability. The rule is defined that "The frequency stability shall be sufficient to ensure that the fundamental emission stays within the authorized frequency block." The frequency error rate is according to the JTC standard that the frequency error rate shall be accurate to within 2.5ppm of the received frequency from the base station. The test extreme voltage is according to the 2.1055(d)(1) Vary primary supply voltage from 85 to 115 percent of the nominal value for other than hand carried battery equipment and the extreme temperature rule is comply with the 2.1055(a)(1)  $-30^{\circ}\text{C} \sim 50^{\circ}\text{C}$ .

### 4.2.2 TEST INSTRUMENTS

DESCRIPTION & MANUFACTURER	MODEL NO.	SERIAL NO.	CALIBRATED UNTIL
* ROHDE & SCHWARZ Spectrum Analyzer	FSP40	100035	Mar. 29, 2007
* Hewlett Packard RF cable	8120-6192	01428251	NA
* Suhner RF cable	Sucoflex104	204850/4	NA
* WIT Standard Temperature & Humidity Chamber	TH-4S-C	W981030	Jul. 10, 2007

- NOTE:**
1. The calibration interval of the above test instruments is 12 months. And the calibrations are traceable to NML/ROC and NIST/USA.
  2. "\*" = These equipments are used for the final measurement.
  3. The test was performed in ADT RF OVEN room.

### 4.2.3 TEST PROCEDURE

- a. Because of the measure the carrier frequency under the condition of the AFC lock, it shall be used the mobile station in the CDMA link mode. This is accomplished with the use of the R&S CMU200 simulator station. The oven room could control the temperatures and humidity. The CDMA link channel is the 1013.
- b. Power must be removed when changing from one temperature to another or one voltage to another voltage. Power warm up is at least 15 min and power applied should perform before recording frequency error.
- c. EUT is connected the external power supply to control the DC input power. The various Volts from the minimum 3.3 Volts to 4.2 Volts. Each step shall be record the frequency error rate.
- d. The temperature range step is 10 degrees in this test items. All temperature levels shall be hold the  $\pm 0.5^{\circ}\text{C}$  during the measurement testing.
- e. The each temperature step shall be at least 0.5 hours, consider the EUT could be test under the stability condition.

**NOTE:** The frequency error was recorded frequency error from the CDMA simulator.

### 4.2.4 TEST SETUP

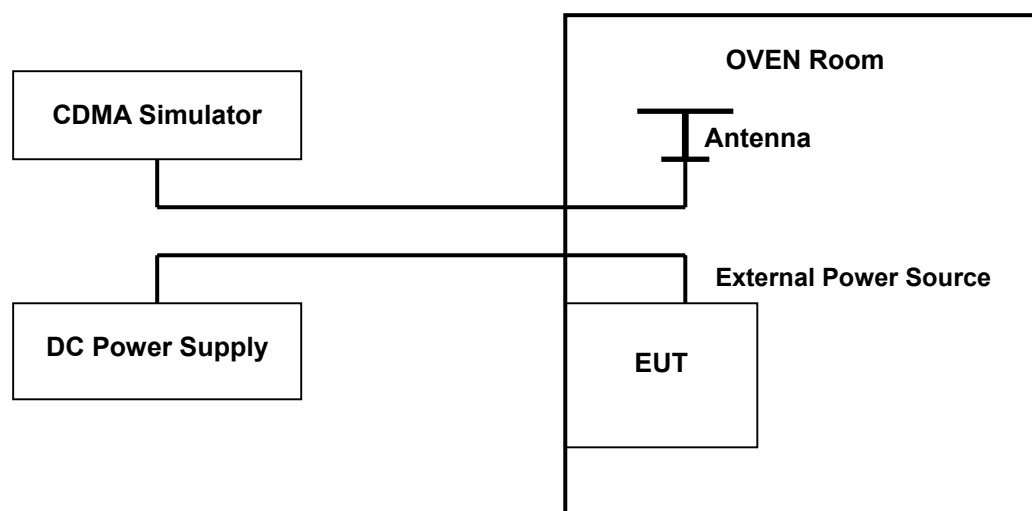



#### 4.2.5 TEST RESULTS

<b>MODE</b>	TX channel 1013	<b>ENVIRONMENTAL CONDITIONS</b>	26deg. C, 65%RH, 991hPa
<b>INPUT POWER (SYSTEM)</b>	120Vac, 60 Hz	<b>TESTED BY</b>	Long Chen

<b>AFC FREQUENCY ERROR vs. VOLTAGE</b>			
<b>VOLTAGE (Volts)</b>	<b>FREQUENCY ERROR (Hz)</b>	<b>FREQUENCY ERROR (ppm)</b>	<b>LIMIT (ppm)</b>
3.3	4	0.004781257	0.1
3.7	5	0.005976572	0.1
4.2	7	0.008367201	0.1

<b>AFC FREQUENCY ERROR vs. TEMP.</b>			
<b>TEMP. (°C)</b>	<b>FREQUENCY ERROR (Hz)</b>	<b>FREQUENCY ERROR (ppm)</b>	<b>LIMIT (ppm)</b>
50	4	0.004781257	0.1
40	3	0.003585943	0.1
30	2	0.002390629	0.1
20	2	0.002390629	0.1
10	-1	-0.001195314	0.1
0	-3	-0.003585943	0.1
-10	-3	-0.003585943	0.1
-20	-4	-0.004781257	0.1
-30	-4	-0.004781257	0.1



### 4.3 OCCUPIED BANDWIDTH MEASUREMENT

#### 4.3.1 LIMITS OF OCCUPIED BANDWIDTH MEASUREMENT

According to FCC 2.1049 (h) specified that emission bandwidth is defined as the width of the signal between two points, one below the carrier center frequency and one above the carrier center frequency, outside of which all emissions are attenuated at least 26 dB below the transmitter power.

#### 4.3.2 TEST INSTRUMENTS

DESCRIPTION & MANUFACTURER	MODEL NO.	SERIAL NO.	CALIBRATED UNTIL
* ROHDE & SCHWARZ Spectrum Analyzer	FSP40	100035	Mar. 29, 2007
* Mini-Circuits Power Splitter	ZAPD-4	400005	NA
* Hewlett Packard RF cable	8120-6192	01428251	NA
* JFW 20dB attenuation	50HF-020-SMA	NA	NA
* Suhner RF cable	Sucoflex104	204850/4	NA

**NOTE:** 1. The calibration interval of the above test instruments is 12 months. And the calibrations are traceable to NML/ROC and NIST/USA.

2. "\*" = These equipments are used for the final measurement.

#### 4.3.3 TEST SETUP

Same as Item 4.2.4 (Conducted Power Setup)

#### 4.3.4 TEST PROCEDURES

- a. The EUT was set up for the maximum peak power with CDMA link data modulation. The power was measured with R&S Spectrum Analyzer. All measurements were done at 3 channels, 1013, 384 and 777 (low, middle and high operational frequency range.)
- b. The conducted occupied bandwidth used the power splitter via EUT RF power connector between simulation base station and spectrum analyzer. This splitter loss and cable loss is the worst loss 3.0dB in the transmitted path track.
- c. FCC 2.1049 (h) required a measurement bandwidth is the fundamental emission below 26dB bandwidth.

#### 4.3.5 EUT OPERATING CONDITION

- a. The EUT makes a phone call to the CDMA simulator.
- b. The CDMA simulator station system controlled a EUT to export maximum and minimum output power under transmission mode and specific channel frequency.

#### 4.3.6 TEST RESULTS

FREQUENCY (MHz)	MAX. OUTPUT POWER -26 dBc BANDWIDTH (MHz)
1013	1.44
384	1.43
777	1.42

### CH 1013 MAX. POWER

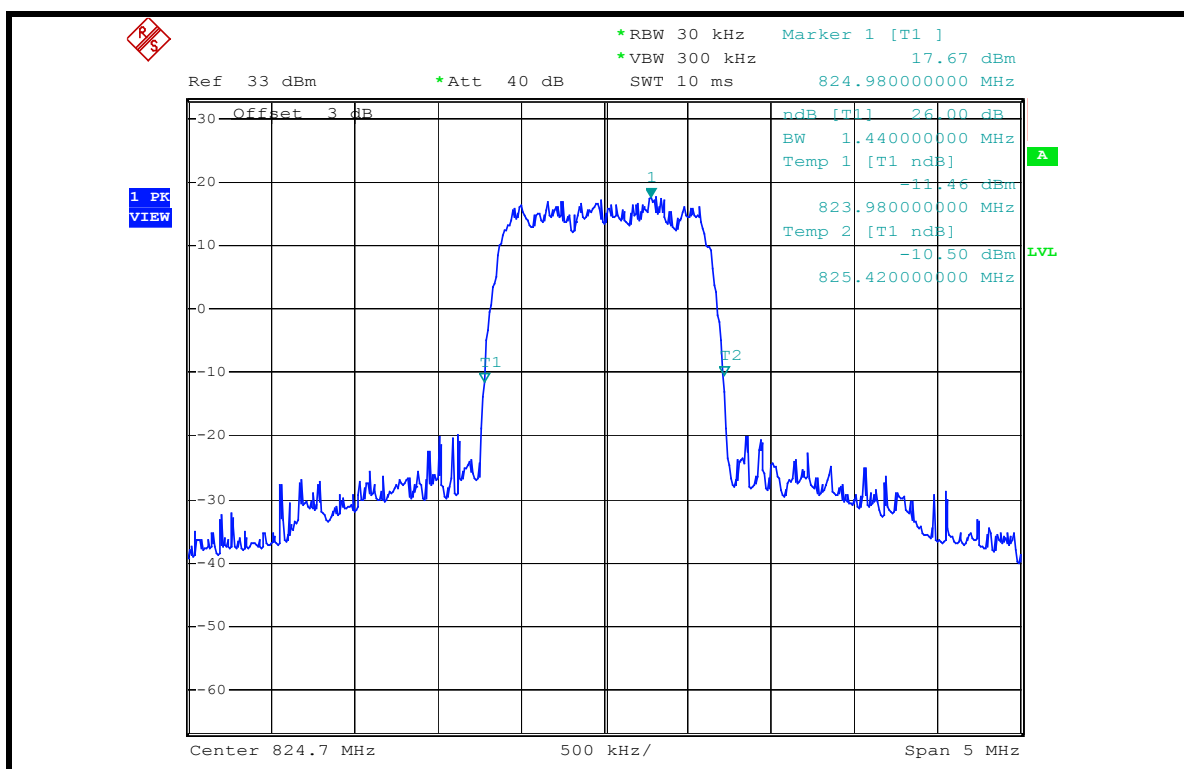

### CH 384 MAX. POWER

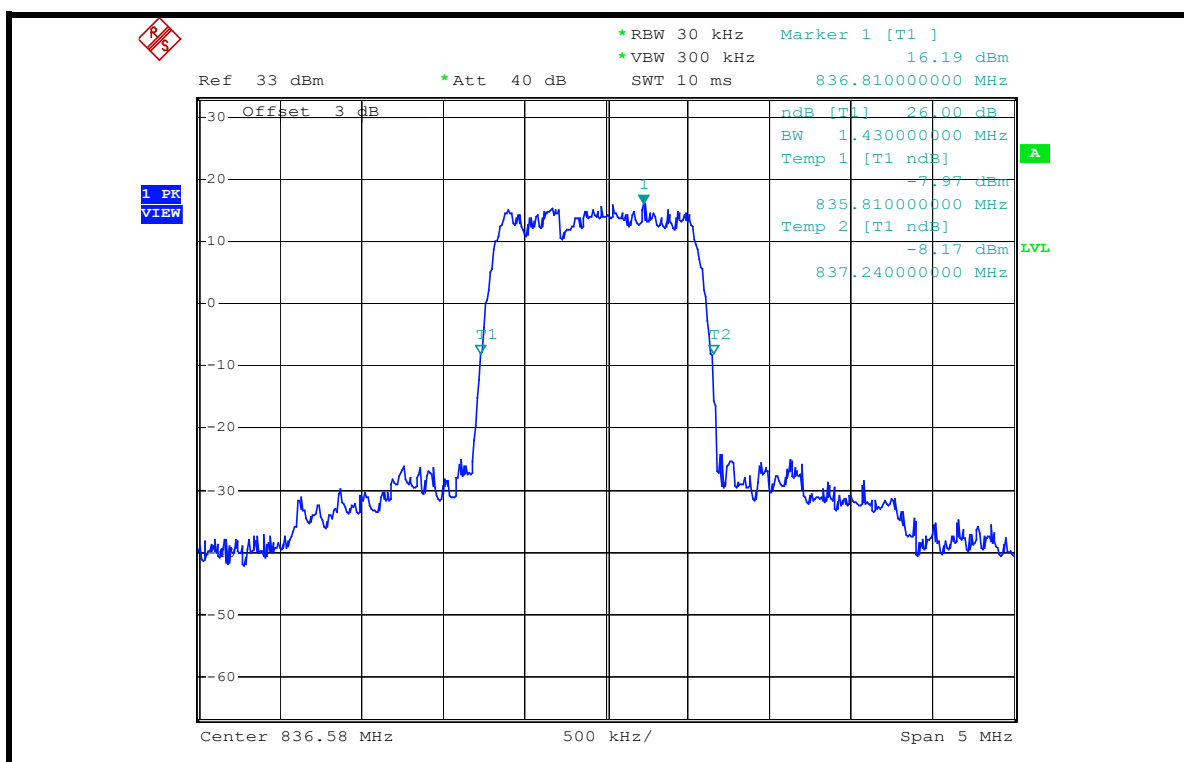

### CH 777 MAX. POWER

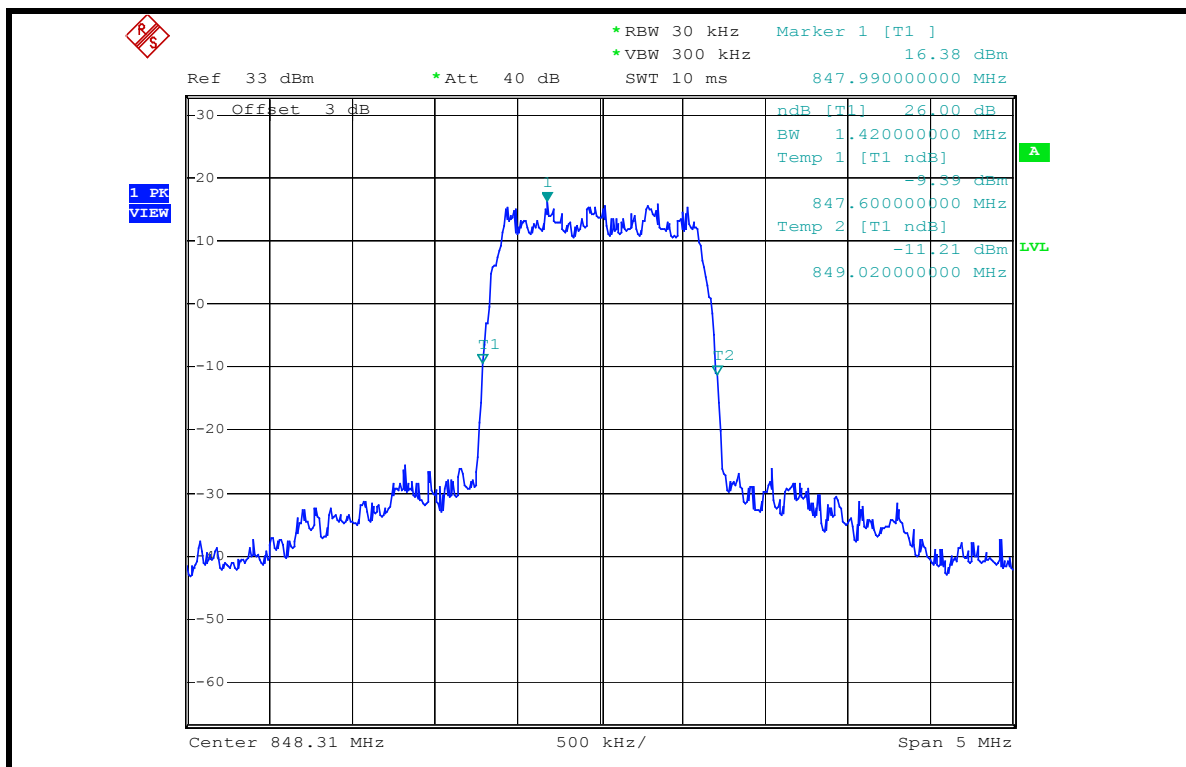



## 4.4 BAND EDGE MEASUREMENT

### 4.4.1 LIMITS OF BAND EDGE MEASUREMENT

According to FCC 22.917 specified that power of any emission outside of the authorized operating frequency ranges must be attenuated below the transmitting power (P) by a factor of at least  $43 + 10 \log(P)$  dB. In the 1 MHz bands immediately outside and adjacent to the frequency block a resolution bandwidth of at least one percent of the emission bandwidth of the fundamental emission of the transmitter may be employed.

### 4.4.2 TEST INSTRUMENTS

DESCRIPTION & MANUFACTURER	MODEL NO.	SERIAL NO.	CALIBRATED UNTIL
* ROHDE & SCHWARZ Spectrum Analyzer	FSP40	100035	Mar. 29, 2007
* Mini-Circuits Power Splitter	ZAPD-4	400005	NA
* Hewlett Packard RF cable	8120-6192	01428251	NA
* JFW 20dB attenuation	50HF-020-SMA	NA	NA
* Suhner RF cable	Sucoflex104	204850/4	NA

**NOTE:** 1. The calibration interval of the above test instruments is 12 months. And the calibrations are traceable to NML/ROC and NIST/USA.

2. "\*" = These equipments are used for the final measurement.

### 4.4.3 TEST SETUP

Same as Item 4.2.4 (Conducted Power Setup)

#### 4.4.4 TEST PROCEDURES

- a. The EUT was set up for the maximum peak power with CDMA link data modulation. The power was measured with R&S Spectrum Analyzer. All measurements were done at 2 channels, 1013 and 777 (low and high operational frequency range.)
- b. The band edge measurement used the power splitter via EUT RF power connector between simulation base station and spectrum analyzer. This splitter loss and cable loss is the worst loss 3.0dB in the transmitted path track.
- c. The center frequency of spectrum is the band edge frequency and span is 3 MHz. RB of the spectrum is 15kHz and VB of the spectrum is 15kHz.
- d. Record the max trace plot into the test report.

#### 4.4.5 EUT OPERATING CONDITION

- a. The EUT makes a phone call to the CDMA simulator.
- b. The CDMA simulator station system controlled a EUT to export maximum output power under transmission mode and specific channel frequency.

## 4.4.6 TEST RESULTS

### LOWER BAND EDGE

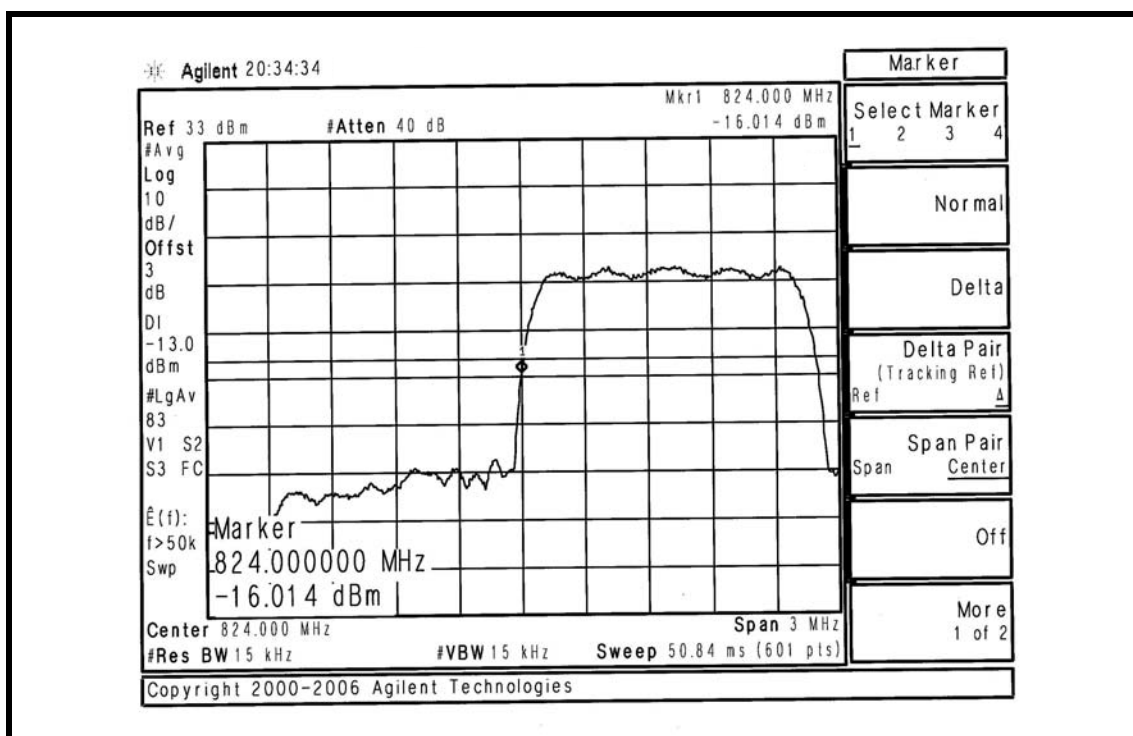

### HIGHER BAND EDGE

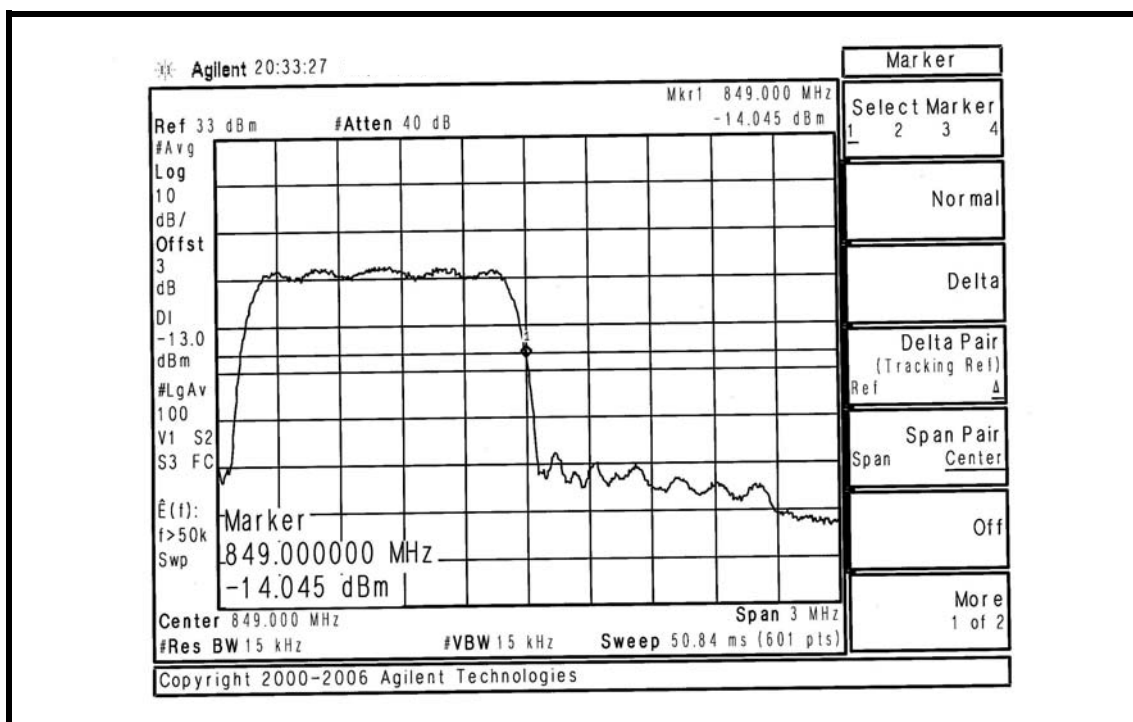



## 4.5 CONDUCTED SPURIOUS EMISSIONS

### 4.5.1 LIMITS OF CONDUCTED SPURIOUS EMISSIONS MEASUREMENT

In the FCC 22.917, On any frequency outside a licensee's frequency block within CDMA spectrum, the power of any emission shall be attenuated below the transmitter power (P) by at least  $43 + 10 \log (P)$  dB. The specified minimum attenuation becomes 43dB and the limit of emission equal to  $-13\text{dBm}$ .

### 4.5.2 TEST INSTRUMENTS

DESCRIPTION & MANUFACTURER	MODEL NO.	SERIAL NO.	CALIBRATED UNTIL
* ROHDE & SCHWARZ Spectrum Analyzer	FSP40	100035	Mar. 29, 2007
* Wainwright Instruments Band Reject Filter	WRCG1850/1910- 1830/1930- 60/10SS	SN1	NA
* Wainwright Instruments High Pass Filter	WHK3.1/18G-10SS	SN1	NA
* Mini-Circuits Power Splitter	ZAPD-4	400005	NA
* Hewlett Packard RF cable	8120-6192	01428251	NA
* JFW 20dB attenuation	50HF-020-SMA	NA	NA
* Suhner RF cable	Sucoflex104	204850/4	NA

- NOTE:**
1. The calibration interval of the above test instruments is 12 months. And the calibrations are traceable to NML/ROC and NIST/USA.
  2. "\*" = These equipments are used for the final measurement.

### 4.5.3 TEST PROCEDURE

- a. The EUT was set up for the maximum peak power with CDMA link data modulation. The power was measured with R&S Spectrum Analyzer. All measurements were done at 3 channels, 1013, 384 and 777(low, middle and high operational frequency range.)
- b. The conducted spurious emission used the power splitter via EUT RF power connector between simulation base station and spectrum analyzer. This splitter loss and cable loss are the worst loss 3.0dB in the transmitted path track.
- c. When the spectrum scanned from 9kHz to 4GHz, it shall be connected to the band reject filter attenuated the carried frequency. The spectrum set RB/VB 1MHz.
- d. When the spectrum scanned from 4GHz to 9GHz, it shall be connected to the high pass filter attenuated the carried frequency. The spectrum set RB/VB 1MHz.

### 4.5.4 TEST SETUP

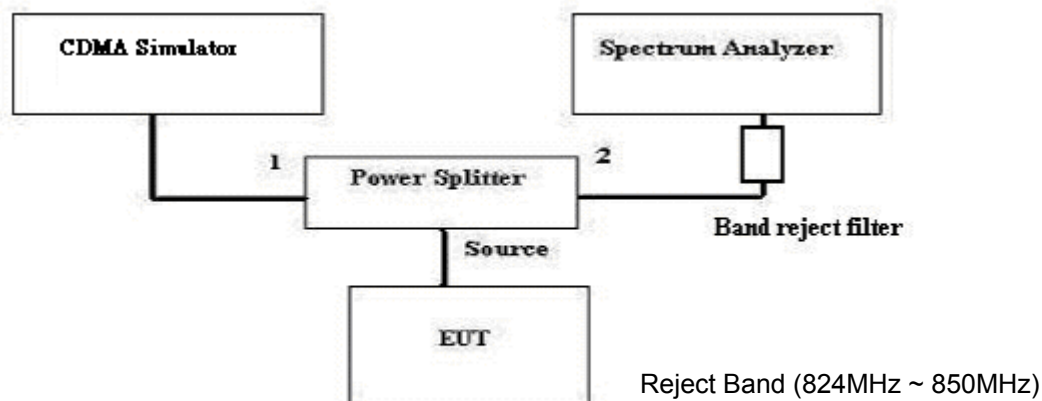

### 4.5.5 EUT OPERATING CONDITIONS

- a. The EUT makes a phone call to the CDMA simulator.
- b. The CDMA simulator station system controlled a EUT to export maximum output power under transmission mode and specific channel frequency.

## 4.5.6 TEST RESULTS

### CH 1013: 9kHz ~ 1GHz

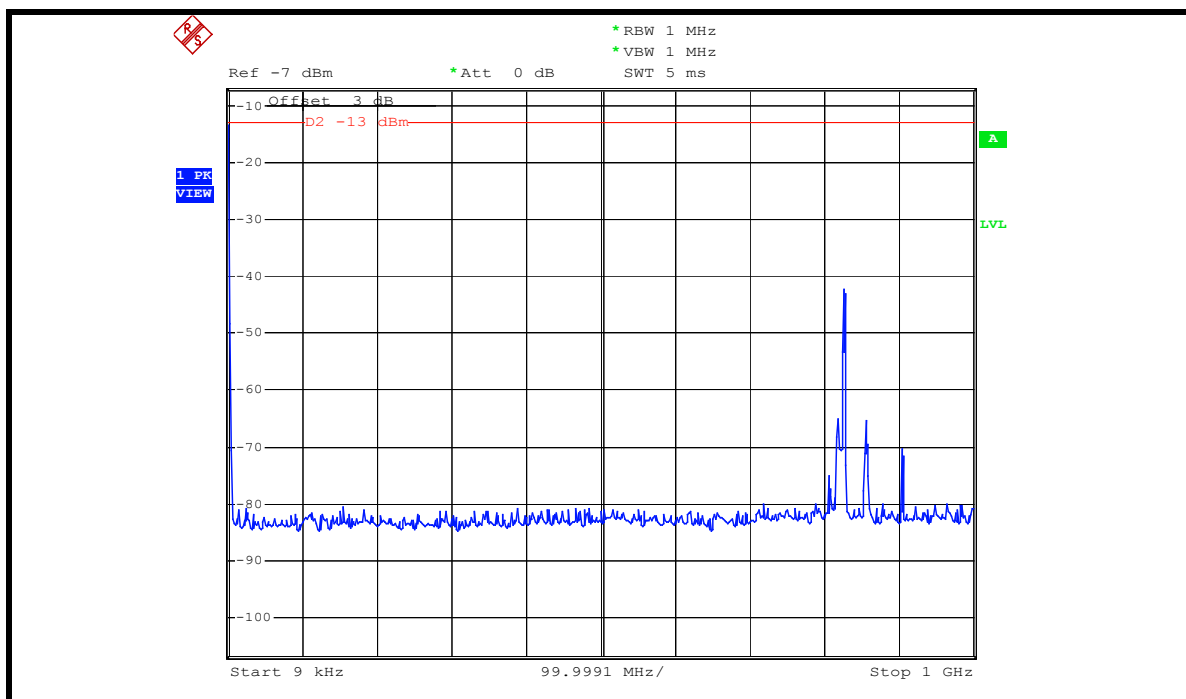

### 1GHz ~ 4GHz

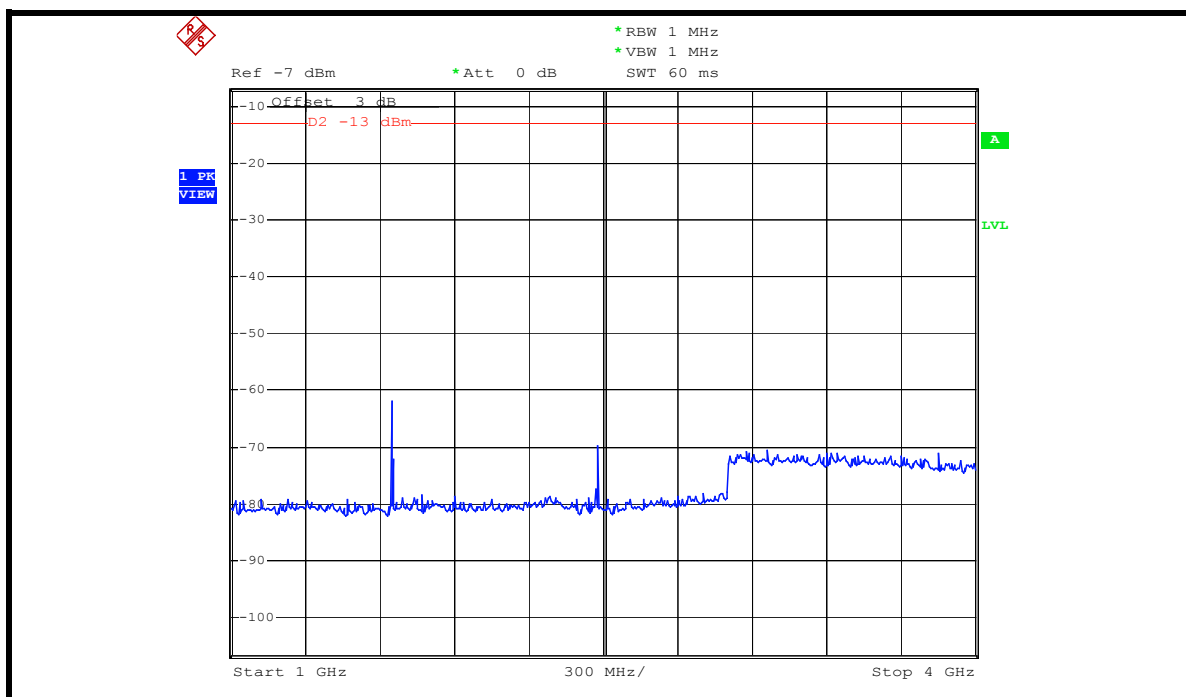

### 4GHz ~ 7GHz

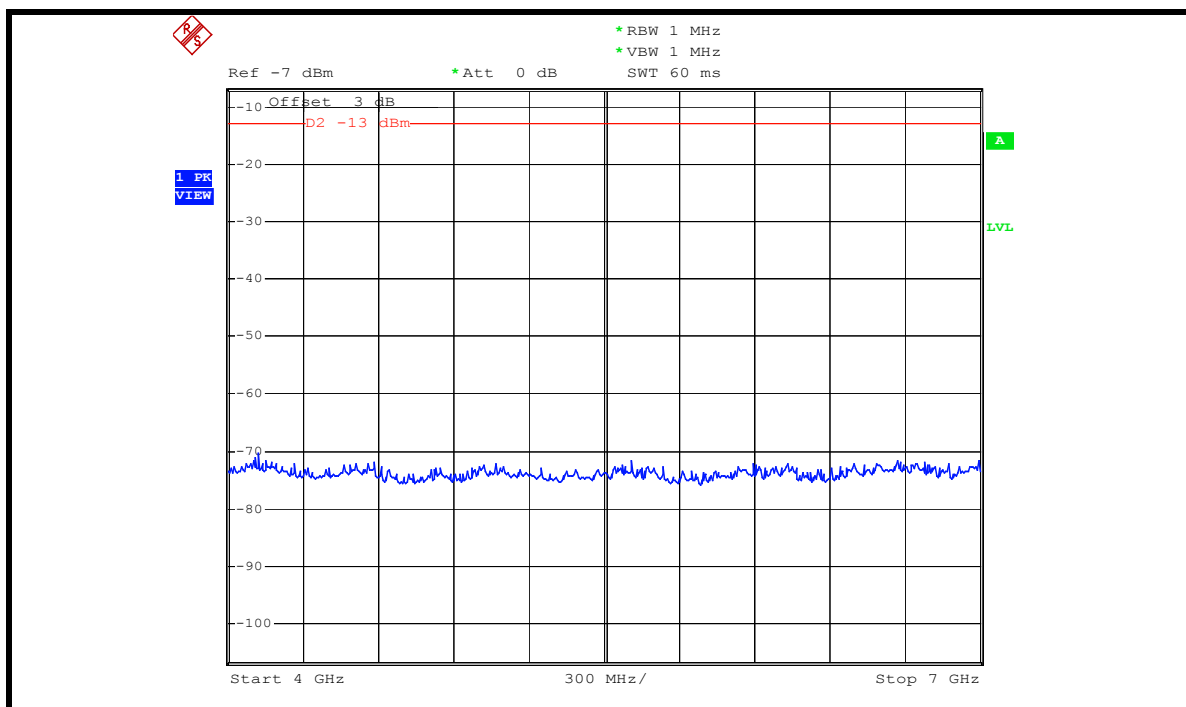

### 7GHz ~ 9GHz

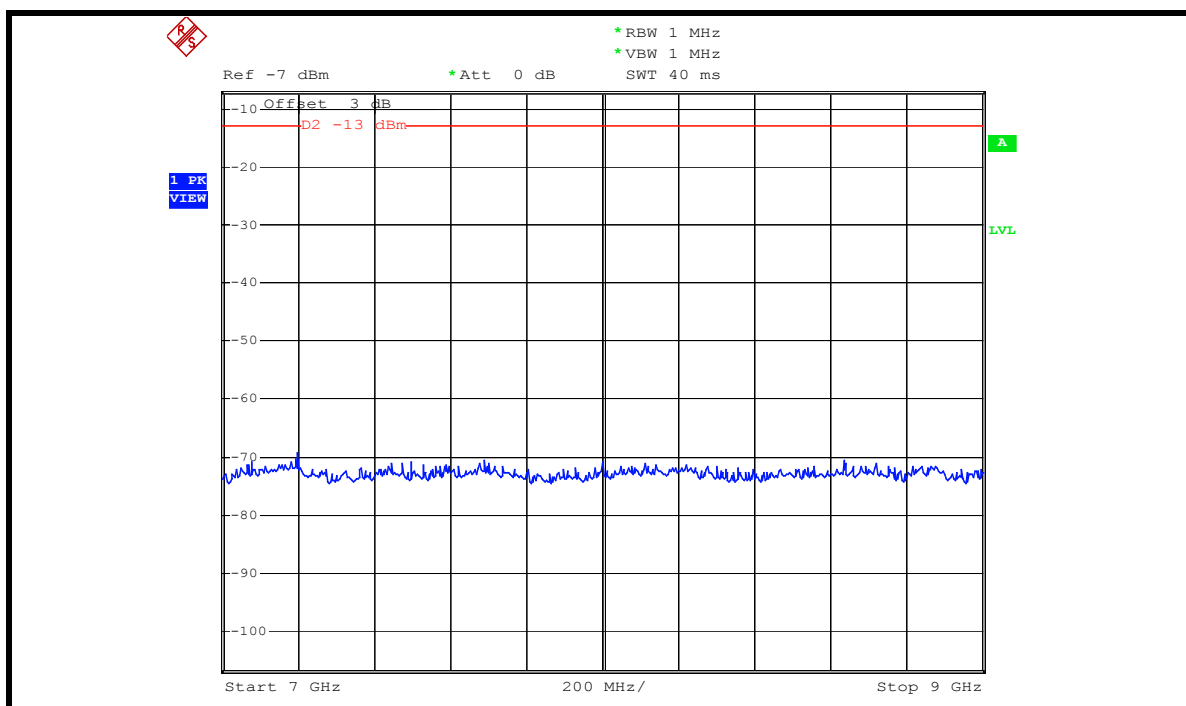

### CH 384: 9kHz ~ 1GHz

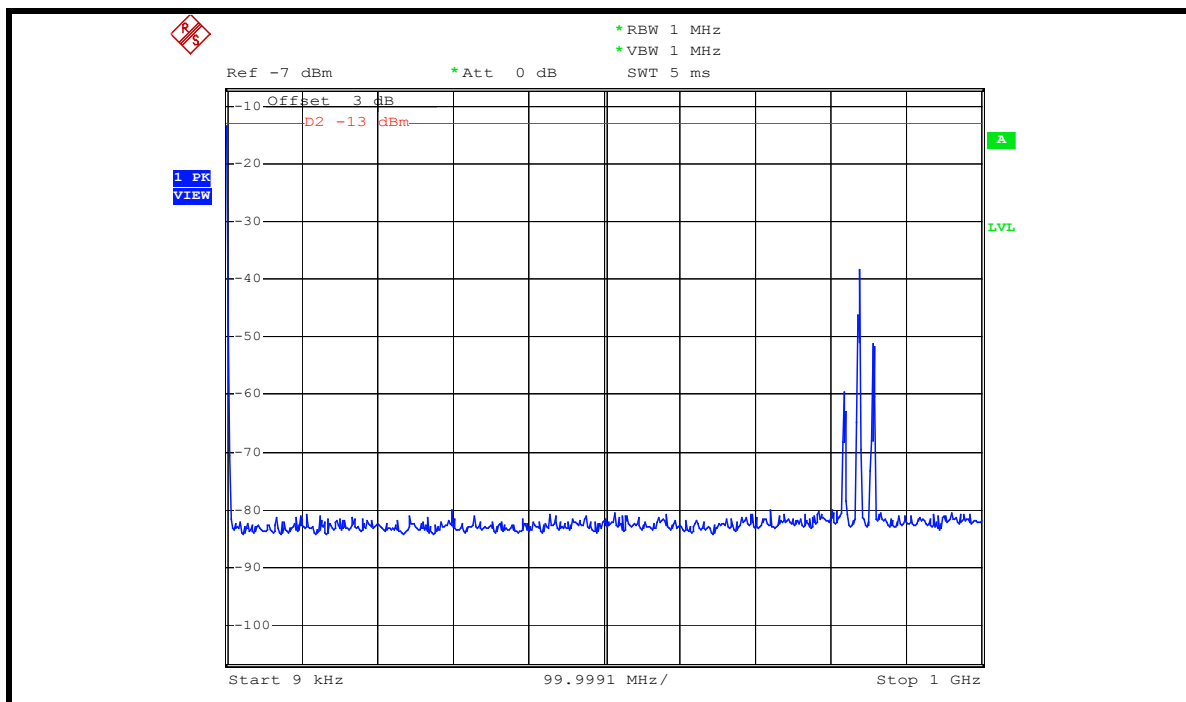

### 1GHz ~ 4GHz

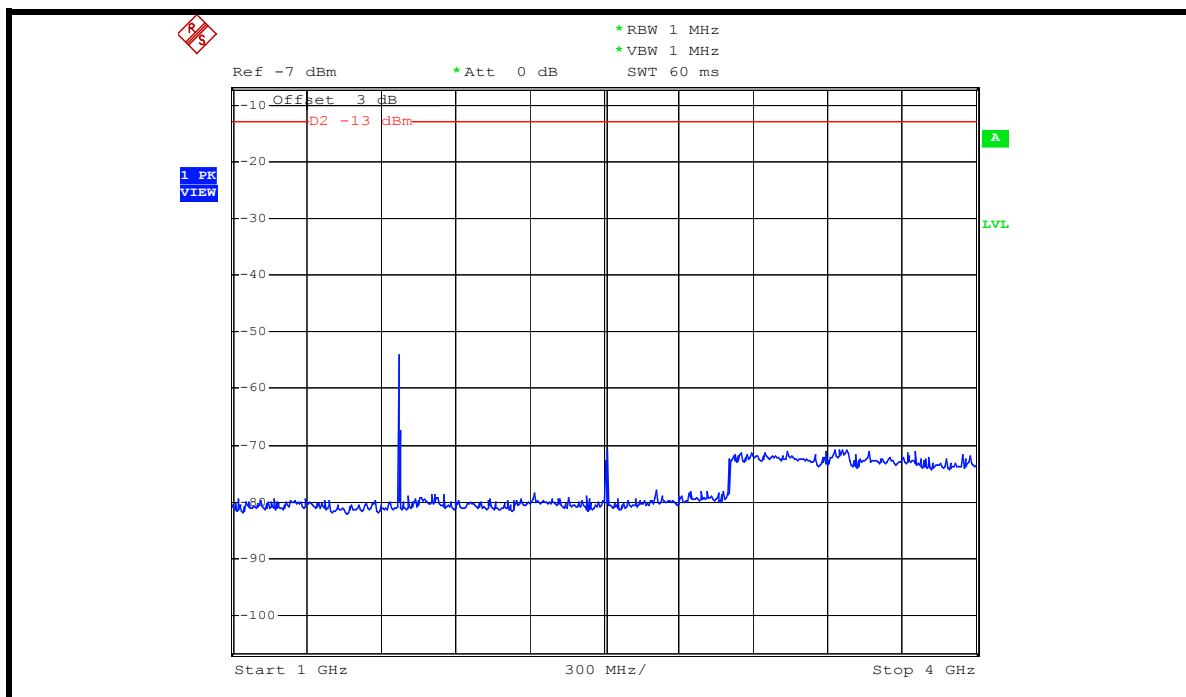



### 4GHz ~ 7GHz

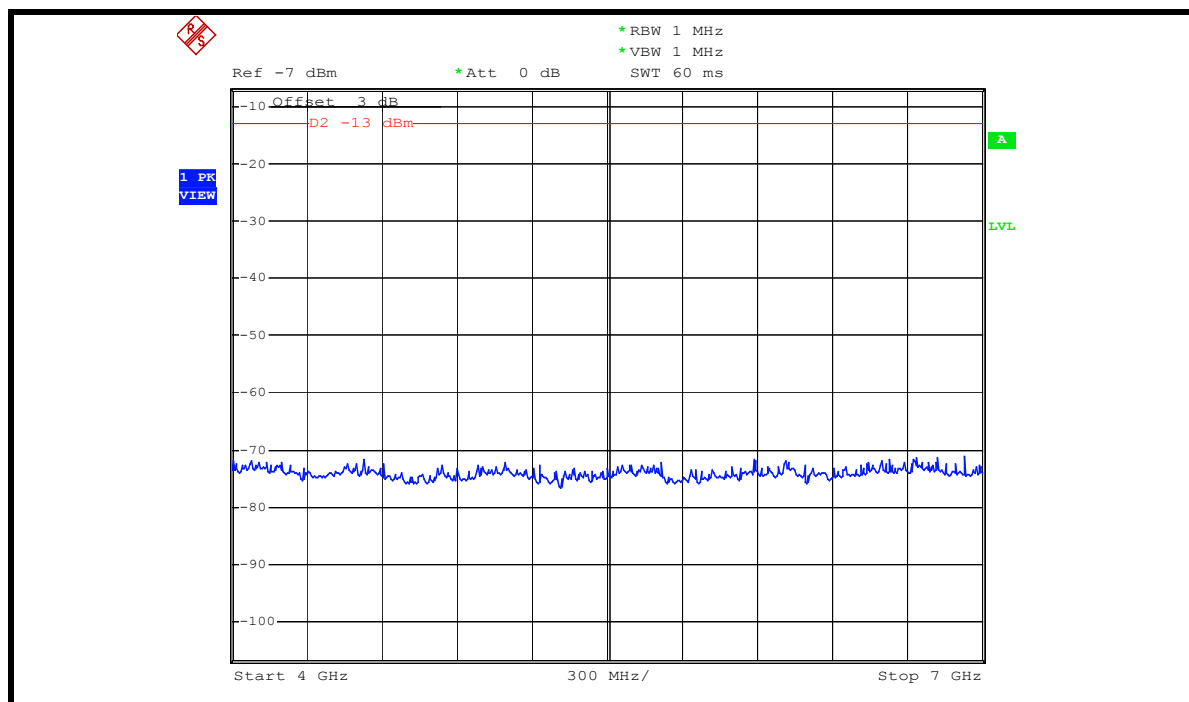

### 7GHz ~ 9GHz

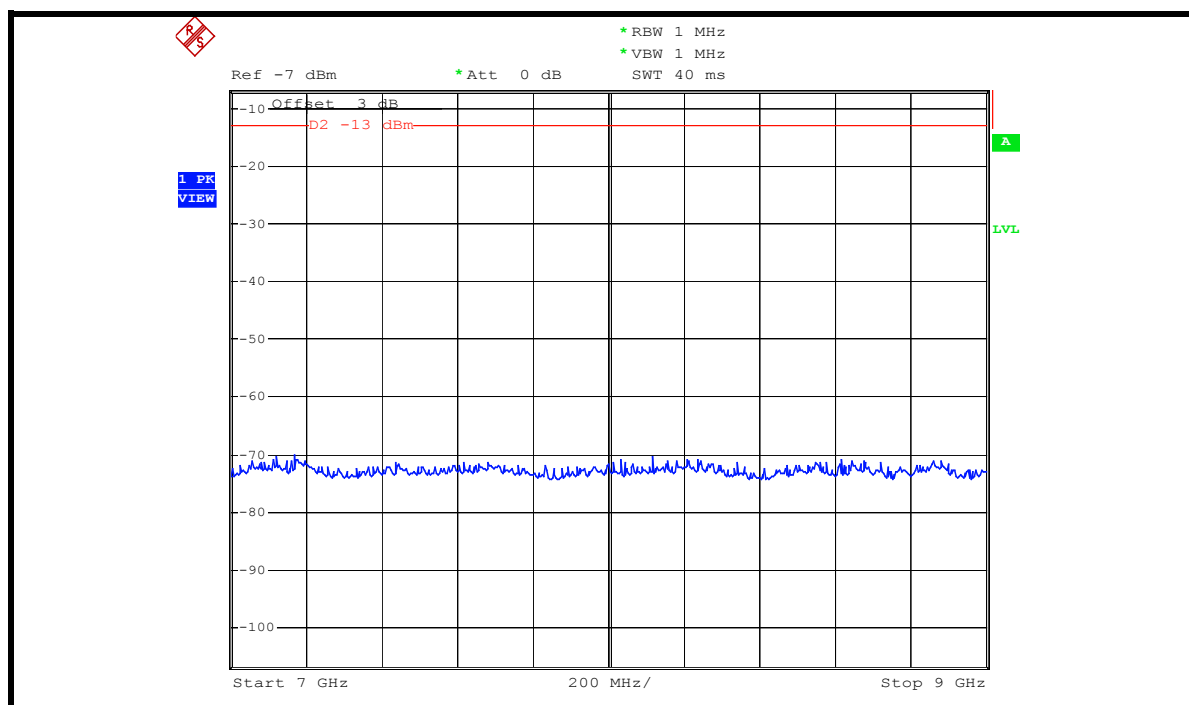

### CH 777: 9kHz ~ 1GHz

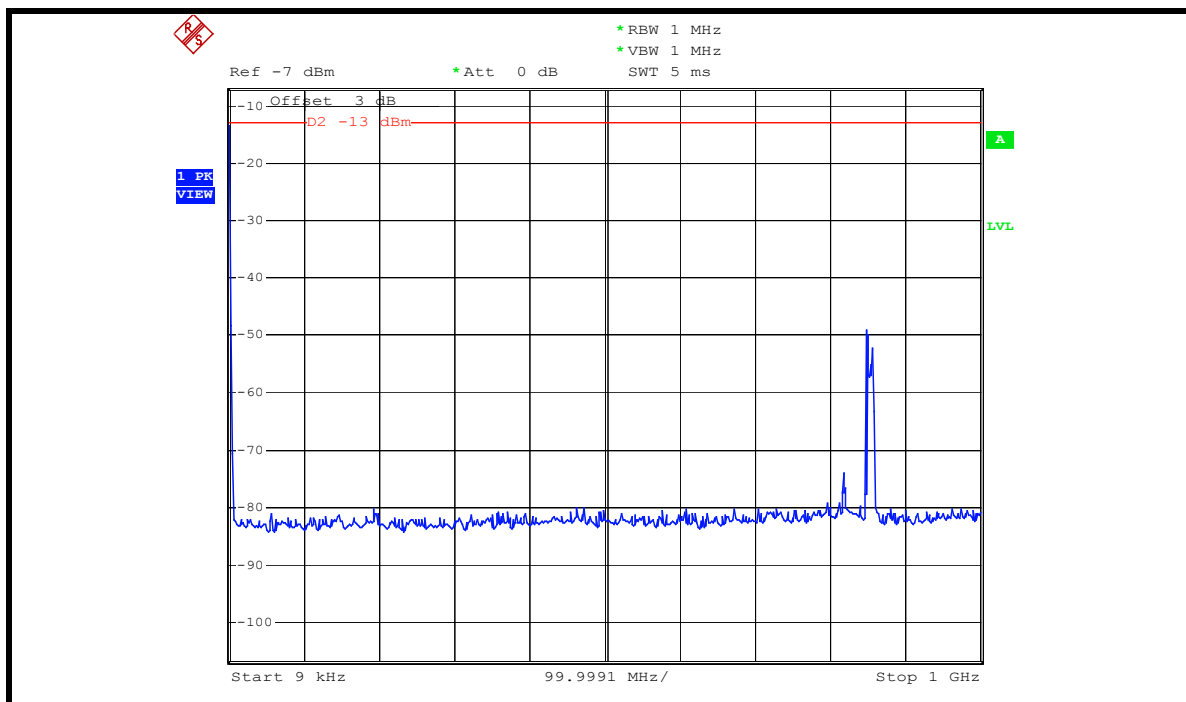

### 1GHz ~ 4GHz

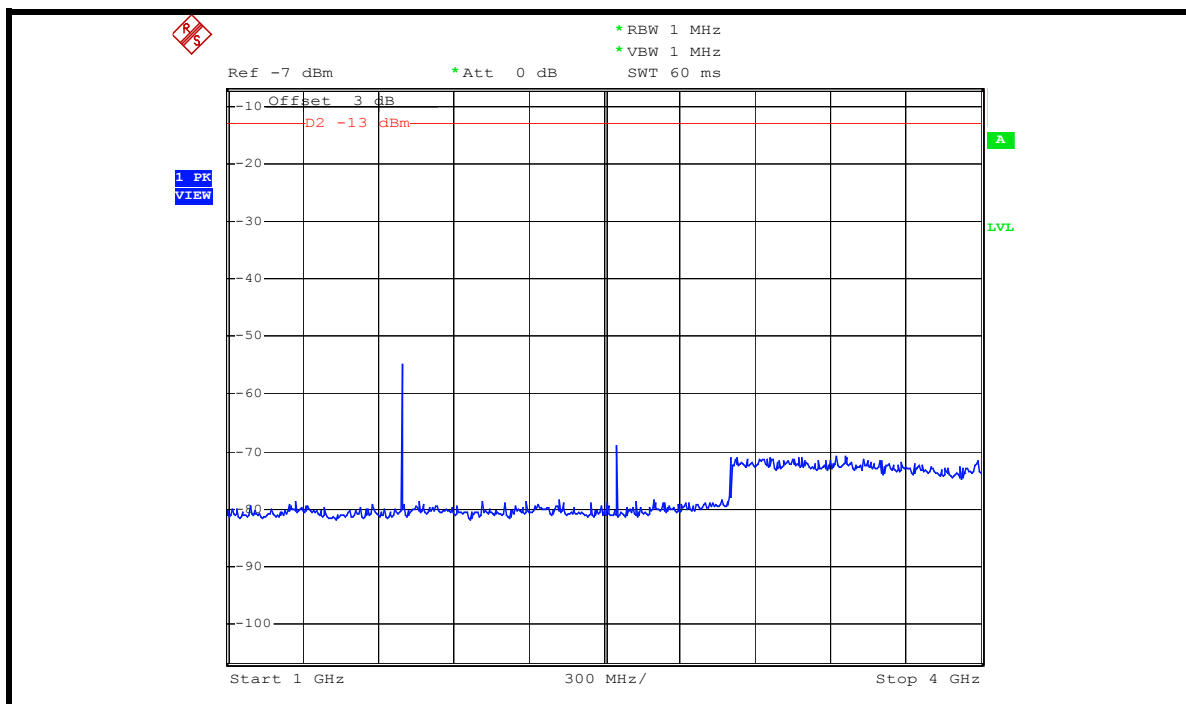

### 4GHz ~ 7GHz

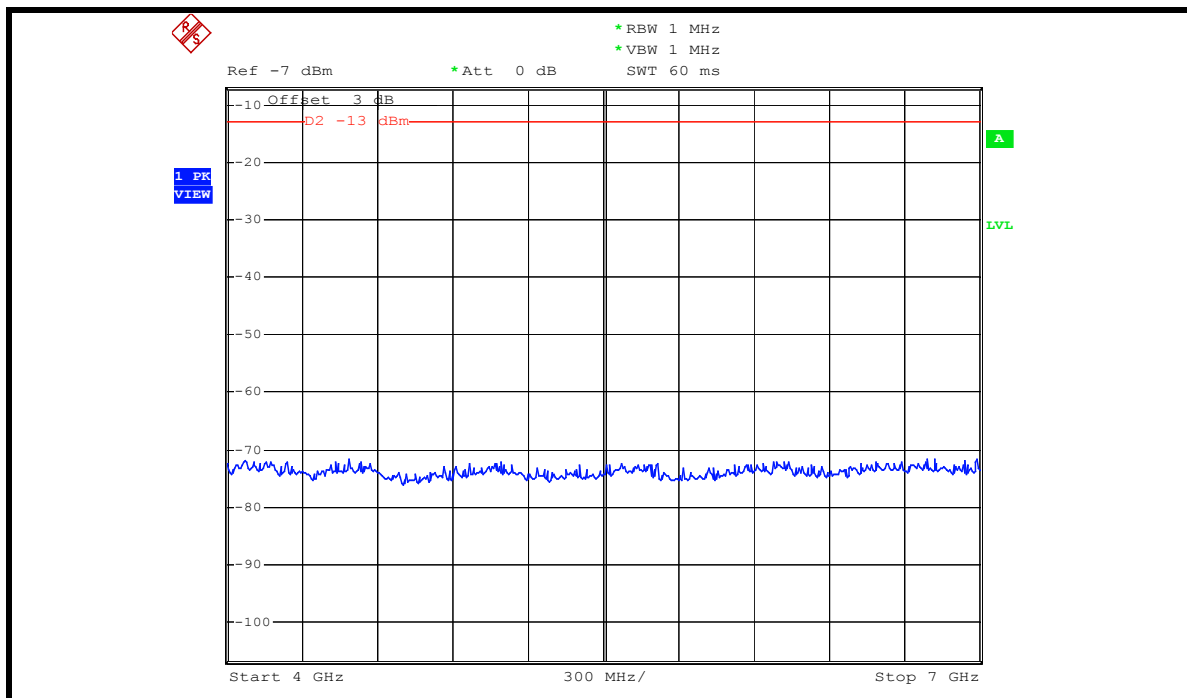

### 7GHz ~ 9GHz

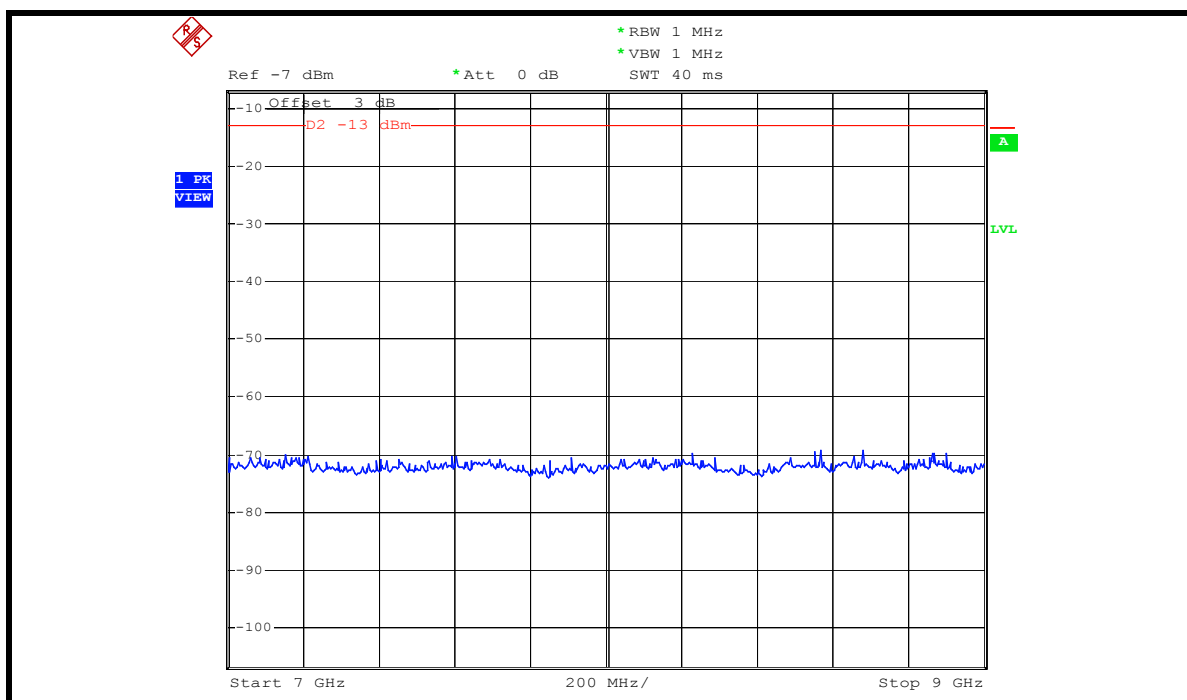

## **4.6 RADIATED EMISSION MEASUREMENT (BELOW 1GHz)**

### **4.6.1 LIMITS OF RADIATED EMISSION MEASUREMENT**

In the FCC 22.917, On any frequency outside a licensee's frequency block within USPCS spectrum, the power of any emission shall be attenuated below the transmitter power (P) by at least  $43 + 10 \log (P)$  dB. The specified minimum attenuation becomes 43dB and the limit of emission equal to  $-13\text{dBm}$ .

#### 4.6.2 TEST INSTRUMENTS

DESCRIPTION & MANUFACTURER	MODEL NO.	SERIAL NO.	CALIBRATED UNTIL
Test Receiver ROHDE & SCHWARZ	ESI7	838496/016	Jan. 01, 2007
Spectrum Analyzer ROHDE & SCHWARZ	FSP40	100041	Dec. 04, 2006
BILOG Antenna SCHWARZBECK	VULB9168	9168-155	Jan. 15, 2007
HORN Antenna SCHWARZBECK	BBHA 9120D	9120D-404	Jan. 01, 2007
HORN Antenna SCHWARZBECK	BBHA 9170	BBHA9170242	Jan. 19, 2007
Preamplifier Agilent	8449B	3008A01960	Nov. 09, 2006
RF signal cable HUBER+SUHNNER	SUCOFLEX 104	219268/4	Dec. 20, 2006
RF signal cable HUBER+SUHNNER	SUCOFLEX 104	230129/4	Dec. 20, 2006
Software ADT.	ADT_Radiated_V5.14	NA	NA
Antenna Tower inn-co GmbH	MA 4000	010303	NA
Antenna Tower Controller inn-co GmbH	CO2000	019303	NA
Turn Table ADT.	TT100.	TT93021704	NA
Turn Table Controller ADT.	SC100.	SC93021704	NA

- NOTE:**
1. The calibration interval of the above test instruments is 12 months and the calibrations are traceable to NML/ROC and NIST/USA.
  2. The test was performed in HwaYa Chamber 4.
  3. The horn antenna and HP preamplifier (model: 8449B) are used only for the measurement of emission frequency above 1GHz if tested.
  4. The IC Site Registration No. is IC4924-4.

#### 4.6.3 TEST PROCEDURES

- a. The EUT was placed on the top of a rotating table 0.8 meters above the ground. The table was rotated 360 degrees to determine the position of the highest radiation.
- b. The EUT was set 3 meters away from the receiving antenna, which was mounted on antenna tower and its position at 0.8 m above the ground.
- c. For each suspected emission, the EUT was arranged to its worst case and the rotatable table was turned from 0 degrees to 360 degrees to find the maximum reading and recorded the value.
- d. Repeat step a ~ c for horizontal polarization.

**NOTE:** The resolution bandwidth of spectrum analyzer is 1 MHz and the video bandwidth is 1 MHz.

#### 4.6.4 DEVIATION FROM TEST STANDARD

No deviation

#### 4.6.5 TEST SETUP

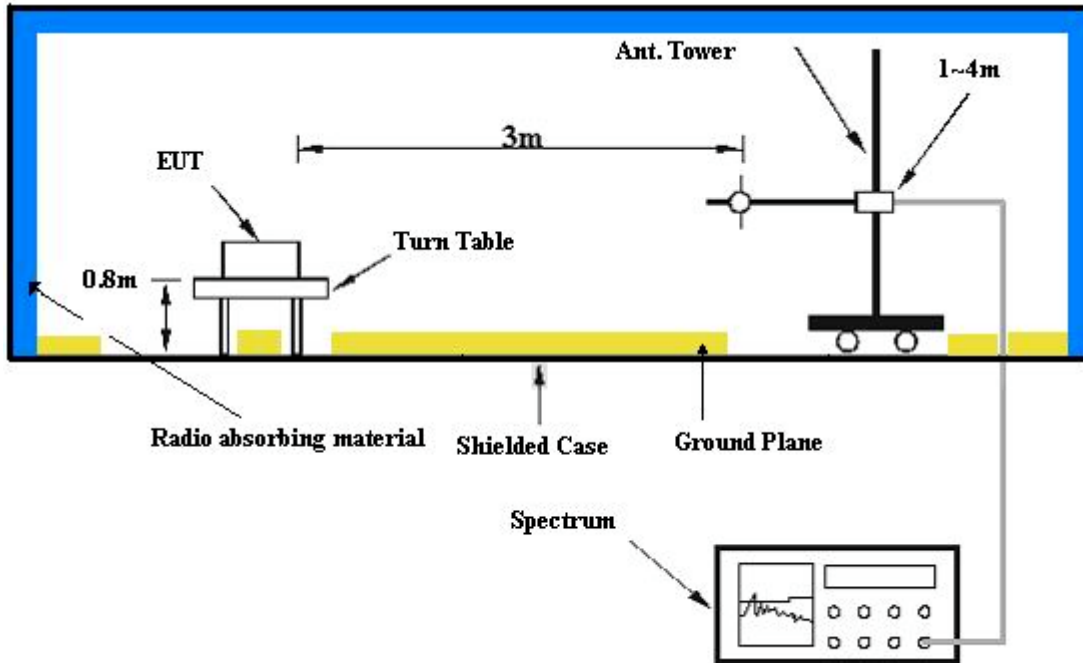

For the actual test configuration, please refer to the related item – Photographs of the Test Configuration.

#### 4.6.6 EUT OPERATING CONDITIONS

- a. The EUT makes a phone call to the CDMA simulator.
- b. The CDMA simulator station system controlled an EUT to export maximum output power under transmission mode and specific channel frequency.



#### 4.6.7 TEST RESULTS

<b>MODE</b>	TX channel 1013	<b>DETECTOR FUNCTION</b>	Quasi-Peak
<b>FREQUENCY RANGE</b>	Below 1000 MHz	<b>INPUT POWER (SYSTEM)</b>	120Vac, 60 Hz
<b>ENVIRONMENTAL CONDITIONS</b>	25deg. C, 65%RH, 991hPa	<b>TESTED BY</b>	Brad Wu

<b>ANTENNA POLARITY &amp; TEST DISTANCE: HORIZONTAL AT 3 M</b>								
No.	Freq. (MHz)	Emission Level (dBuV/m)	Limit (dBuV/m)	Margin (dB)	Antenna Height (m)	Table Angle (Degree)	Raw Value (dBuV)	Correction Factor (dB/m)
1	168.02	29.05 QP	82.22	-53.17	1.00 H	118	16.35	12.70
2	288.54	24.74 QP	82.22	-57.48	1.00 H	85	9.82	14.93
3	455.71	27.66 QP	82.22	-54.56	1.50 H	70	8.82	18.84
4	601.50	33.19 QP	82.22	-49.03	1.50 H	67	10.63	22.57
5	731.74	33.15 QP	82.22	-49.07	1.00 H	40	7.96	25.18
6	<b>887.25</b>	<b>47.66 QP</b>	<b>82.22</b>	<b>-34.56</b>	<b>1.00 H</b>	<b>202</b>	<b>20.39</b>	<b>27.27</b>

<b>ANTENNA POLARITY &amp; TEST DISTANCE: VERTICAL AT 3 M</b>								
No.	Freq. (MHz)	Emission Level (dBuV/m)	Limit (dBuV/m)	Margin (dB)	Antenna Height (m)	Table Angle (Degree)	Raw Value (dBuV)	Correction Factor (dB/m)
1	31.94	31.70 QP	82.22	-50.52	1.25 V	187	19.12	12.58
2	241.88	25.74 QP	82.22	-56.48	1.00 V	262	13.57	12.17
3	432.38	28.06 QP	82.22	-54.16	1.00 V	265	9.68	18.38
4	471.26	30.91 QP	82.22	-51.31	1.50 V	157	11.68	19.23
5	700.64	35.55 QP	82.22	-46.67	1.00 V	238	11.39	24.16
6	887.25	42.83 QP	82.22	-39.39	1.00 V	130	15.56	27.27

**NOTE:**

1. Emission level (dBuV/m) = Raw Value (dBuV) + Correction Factor (dB).
2. Correction Factor (dB/m) = Antenna Factor (dB/m) + Cable Factor (dB).
3. The other emission levels were very low against the limit.
4. Margin value = Emission level – Limit value.
5. This is valid for all 3 channels.



## **4.7 RADIATED EMISSION MEASUREMENT (ABOVE 1GHz)**

### **4.7.1 LIMITS OF RADIATED EMISSION MEASUREMENT**

In the FCC 22.917 (a), On any frequency outside a licensee's frequency block within CDMA spectrum, the power of any emission shall be attenuated below the transmitter power (P) by at least  $43 + 10 \log (P)$  dB. The specified minimum attenuation becomes 43dB and the limit of emission equal to  $-13\text{dBm}$ .

#### 4.7.2 TEST INSTRUMENTS

DESCRIPTION & MANUFACTURER	MODEL NO.	SERIAL NO.	CALIBRATED UNTIL
Test Receiver ROHDE & SCHWARZ	ESI7	838496/016	Jan. 01, 2007
Spectrum Analyzer ROHDE & SCHWARZ	FSP40	100041	Dec. 04, 2006
BILOG Antenna SCHWARZBECK	VULB9168	9168-155	Jan. 15, 2007
HORN Antenna SCHWARZBECK	BBHA 9120D	9120D-404	Jan. 01, 2007
HORN Antenna SCHWARZBECK	BBHA 9170	BBHA9170242	Jan. 19, 2007
Preamplifier Agilent	8449B	3008A01960	Nov. 09, 2006
RF signal cable HUBER+SUHNNER	SUCOFLEX 104	219268/4	Dec. 20, 2006
RF signal cable HUBER+SUHNNER	SUCOFLEX 104	230129/4	Dec. 20, 2006
Software ADT.	ADT_Radiated_V5.14	NA	NA
Antenna Tower inn-co GmbH	MA 4000	010303	NA
Antenna Tower Controller inn-co GmbH	CO2000	019303	NA
Turn Table ADT.	TT100.	TT93021704	NA
Turn Table Controller ADT.	SC100.	SC93021704	NA

- NOTE:**
1. The calibration interval of the above test instruments is 12 months and the calibrations are traceable to NML/ROC and NIST/USA.
  2. The test was performed in HwaYa Chamber 4.
  3. The horn antenna and HP preamplifier (model: 8449B) are used only for the measurement of emission frequency above 1GHz if tested.
  4. The IC Site Registration No. is IC4924-4.

#### 4.7.3 TEST PROCEDURES

- a. The EUT was placed on the top of a rotating table 0.8 meters above the ground. The table was rotated 360 degrees to determine the position of the highest radiation.
- b. The EUT was set 3 meters away from the receiving antenna, which was mounted on antenna tower and its position at 0.8 m above the ground.
- c. For each suspected emission, the EUT was arranged to its worst case and the rotatable table was turned from 0 degrees to 360 degrees to find the maximum reading and recorded the value.
- d. The EUT is replaced by a horn antenna connected to a signal generator tuned to the frequency of emission.
- e. The signal generator level has to be adjusted to have the same emission nature.
- f. The radiated power can be calculated via the factor and antenna gain.
- g. Repeat step a ~ f for horizontal polarization.

**NOTE:** The resolution bandwidth of spectrum analyzer is 1 MHz and the video bandwidth is 1 MHz.

#### 4.7.4 DEVIATION FROM TEST STANDARD

No deviation

#### 4.7.5 TEST SETUP

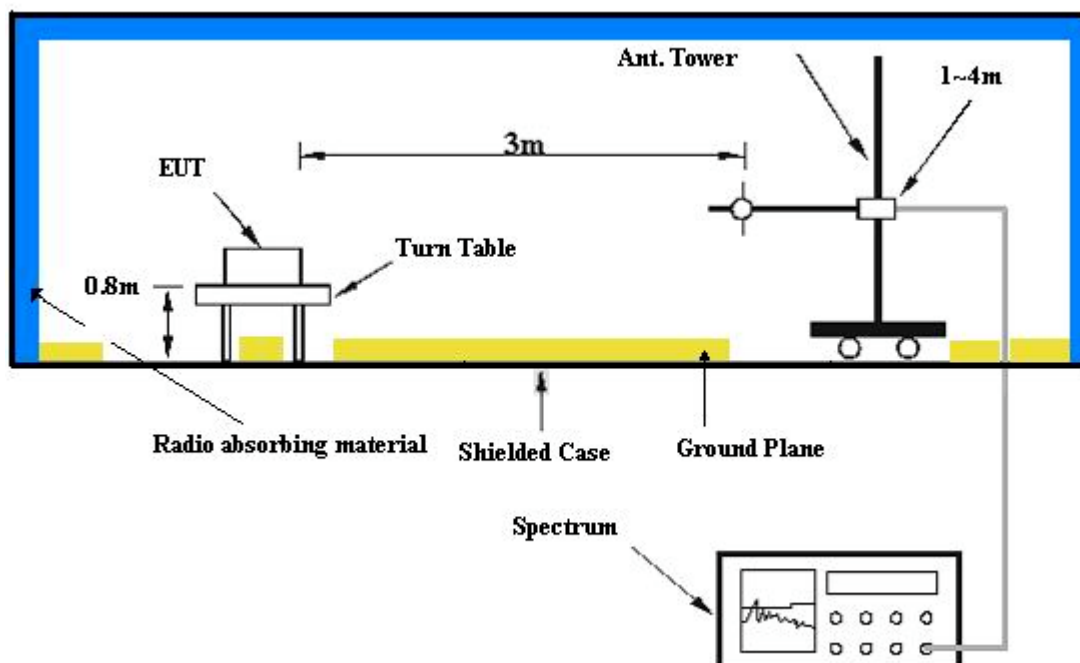

For the actual test configuration, please refer to the related item – Photographs of the Test Configuration.

#### 4.7.6 EUT OPERATING CONDITIONS

- a. The EUT makes a phone call to the CDMA simulator.
- b. The CDMA simulator station system controlled an EUT to export maximum output power under transmission mode and specific channel frequency.



#### 4.7.7 TEST RESULTS

<b>MODE</b>	TX channel 1013	<b>FREQUENCY RANGE</b>	Above 1000 MHz
<b>INPUT POWER (SYSTEM)</b>	120Vac, 60 Hz	<b>ENVIRONMENTAL CONDITIONS</b>	25deg. C, 65%RH, 991hPa
<b>TESTED BY</b>	Brad Wu		

<b>ANTENNA POLARITY &amp; TEST DISTANCE: HORIZONTAL AT 3 M</b>						
No.	Freq. (MHz)	Emission Level (dBuV)	Limit (dBm)	S.G Power Value (dBm)	Correction Factor (dB)	Power Value (dBm)
1	1649.40	41.85	-13.00	-63.50	10.12	-53.38
2	2474.10	48.62	-13.00	-58.10	11.49	-46.61
3	3298.80	46.68	-13.00	-61.05	12.5	-48.55

<b>ANTENNA POLARITY &amp; TEST DISTANCE: VERTICAL AT 3 M</b>						
No.	Freq. (MHz)	Emission Level (dBuV)	Limit (dBm)	S.G Power Value (dBm)	Correction Factor (dB)	Power Value (dBm)
1	1649.40	44.87	-13.00	-60.48	10.12	-50.36
2	2474.10	45.59	-13.00	-61.13	11.49	-49.64
3	3298.80	47.68	-13.00	-60.05	12.5	-47.55

**NOTE:** Power Value (dBum) = S.G Power Value (dBm) + Correction Factor (dB).



<b>MODE</b>	TX channel 384	<b>FREQUENCY RANGE</b>	Above 1000 MHz
<b>INPUT POWER (SYSTEM)</b>	120Vac, 60 Hz	<b>ENVIRONMENTAL CONDITIONS</b>	25deg. C, 65%RH, 991hPa
<b>TESTED BY</b>	Brad Wu		

<b>ANTENNA POLARITY &amp; TEST DISTANCE: HORIZONTAL AT 3 M</b>						
No.	Freq. (MHz)	Emission Level (dBuV)	Limit (dBm)	S.G Power Value (dBm)	Correction Factor (dB)	Power Value (dBm)
1	1673.00	41.95	-13.00	-63.40	10.12	-53.28
2	2510.00	48.87	-13.00	-57.85	11.49	-46.36
3	3346.00	46.52	-13.00	-61.21	12.5	-48.71

<b>ANTENNA POLARITY &amp; TEST DISTANCE: VERTICAL AT 3 M</b>						
No.	Freq. (MHz)	Emission Level (dBuV)	Limit (dBm)	S.G Power Value (dBm)	Correction Factor (dB)	Power Value (dBm)
1	1673.00	44.65	-13.00	-60.70	10.12	-50.58
2	2510.00	45.87	-13.00	-60.85	11.49	-49.36
3	3346.00	47.52	-13.00	-60.21	12.5	-47.71

**NOTE:** Power Value (dBum) = S.G Power Value (dBm) + Correction Factor (dB).



<b>MODE</b>	TX channel 777	<b>FREQUENCY RANGE</b>	Above 1000 MHz
<b>INPUT POWER (SYSTEM)</b>	120Vac, 60 Hz	<b>ENVIRONMENTAL CONDITIONS</b>	25deg. C, 65%RH, 991hPa
<b>TESTED BY</b>	Brad Wu		

<b>ANTENNA POLARITY &amp; TEST DISTANCE: HORIZONTAL AT 3 M</b>						
No.	Freq. (MHz)	Emission Level (dBuV)	Limit (dBm)	S.G Power Value (dBm)	Correction Factor (dB)	Power Value (dBm)
1	1696.60	41.87	-13.00	-63.53	10.17	-53.36
2	2544.90	48.56	-13.00	-58.16	11.49	-46.67
3	3393.20	46.75	-13.00	-61.04	12.56	-48.48

<b>ANTENNA POLARITY &amp; TEST DISTANCE: VERTICAL AT 3 M</b>						
No.	Freq. (MHz)	Emission Level (dBuV)	Limit (dBm)	S.G Power Value (dBm)	Correction Factor (dB)	Power Value (dBm)
1	1696.60	44.28	-13.00	-61.12	10.17	-50.95
2	2544.90	45.28	-13.00	-61.44	11.49	-49.95
3	3393.20	47.63	-13.00	-60.16	12.56	-47.60

**NOTE:** Power Value (dBum) = S.G Power Value (dBm) + Correction Factor (dB).



## 5 INFORMATION ON THE TESTING LABORATORIES

We, ADT Corp., were founded in 1988 to provide our best service in EMC, Radio, Telecom and Safety consultation. Our laboratories are accredited and approved by the following approval agencies according to ISO/IEC 17025.

<b>USA</b>	FCC, UL, A2LA
<b>GERMANY</b>	TUV Rheinland
<b>JAPAN</b>	VCCI
<b>NORWAY</b>	NEMKO
<b>CANADA</b>	INDUSTRY CANADA , CSA
<b>R.O.C.</b>	CNLA, BSMI, DGT
<b>NETHERLANDS</b>	Telefication
<b>SINGAPORE</b>	PSB , GOST-ASIA (MOU)
<b>RUSSIA</b>	CERTIS (MOU)

Copies of accreditation certificates of our laboratories obtained from approval agencies can be downloaded from our web site:

[www.adt.com.tw/index.5/phtml](http://www.adt.com.tw/index.5/phtml). If you have any comments, please feel free to contact us at the following:

**Linko EMC/RF Lab:**  
Tel: 886-2-26052180  
Fax: 886-2-26051924

**Hsin Chu EMC/RF Lab:**  
Tel: 886-3-5935343  
Fax: 886-3-5935342

**Hwa Ya EMC/RF/Safety/Telecom Lab:**  
Tel: 886-3-3183232  
Fax: 886-3-3185050

**Web Site:** [www.adt.com.tw](http://www.adt.com.tw)

The address and road map of all our labs can be found in our web site also.