



# FCC TEST REPORT (15.247)

**REPORT NO.:** RF950803L01  
**MODEL NO.:** MC7095  
**RECEIVED:** Aug. 03, 2006  
**TESTED:** Aug. 07 ~ Aug. 22, 2006  
**ISSUED:** Sep. 01, 2006

**APPLICANT:** Symbol Technologies, Inc.

**ADDRESS:** One Symbol Plaza Holtsville, NY United States 11742-1300

**ISSUED BY:** Advance Data Technology Corporation

**LAB ADDRESS:** No. 47, 14<sup>th</sup> Ling, Chia Pau Tsuen, Lin Kou Hsiang 244, Taipei Hsien, Taiwan, R.O.C.

**TEST LOCATION:** No. 19, Hwa Ya 2<sup>nd</sup> Rd., Wen Hwa Tsuen, Kwei Shan Hsiang, Taoyuan Hsien 333, Taiwan, R.O.C.

This test report consists of 106 pages in total. It may be duplicated completely for legal use with the approval of the applicant. It should not be reproduced except in full, without the written approval of our laboratory. The client should not use it to claim product endorsement by CNLA, A2LA or any government agencies. The test results in the report only apply to the tested sample.



## Table of Contents

1.	CERTIFICATION .....	5
2.	SUMMARY OF TEST RESULTS .....	6
2.1	MEASUREMENT UNCERTAINTY .....	6
3.	GENERAL INFORMATION.....	7
3.1	GENERAL DESCRIPTION OF EUT .....	7
3.2	DESCRIPTION OF TEST MODES.....	9
3.2.1	CONFIGURATION OF SYSTEM UNDER TEST .....	10
3.2.2	TEST MODE APPLICABILITY AND TESTED CHANNEL DETAIL .....	11
3.3	GENERAL DESCRIPTION OF APPLIED STANDARDS .....	13
3.4	DESCRIPTION OF SUPPORT UNITS .....	13
4.	TEST TYPES AND RESULTS (FOR 802.11b & g 2412~2462MHz BAND).....	14
4.1	CONDUCTED EMISSION MEASUREMENT .....	14
4.1.1	LIMITS OF CONDUCTED EMISSION MEASUREMENT.....	14
4.1.2	TEST INSTRUMENTS.....	14
4.1.3	TEST PROCEDURES .....	15
4.1.4	DEVIATION FROM TEST STANDARD .....	15
4.1.5	TEST SETUP .....	16
4.1.6	EUT OPERATING CONDITIONS .....	16
4.1.7	TEST RESULTS .....	17
4.2	RADIATED EMISSION MEASUREMENT .....	29
4.2.1	LIMITS OF RADIATED EMISSION MEASUREMENT.....	29
4.2.2	TEST INSTRUMENTS.....	30
4.2.3	TEST PROCEDURES .....	31
4.2.4	DEVIATION FROM TEST STANDARD .....	31
4.2.5	TEST SETUP .....	32
4.2.6	EUT OPERATING CONDITIONS .....	32
4.2.7	TEST RESULTS .....	33
4.3	6dB BANDWIDTH MEASUREMENT .....	41
4.3.1	LIMITS OF 6dB BANDWIDTH MEASUREMENT .....	41
4.3.2	TEST INSTRUMENTS.....	41
4.3.3	TEST PROCEDURE.....	42
4.3.4	DEVIATION FROM TEST STANDARD .....	42
4.3.5	TEST SETUP .....	42
4.3.6	EUT OPERATING CONDITIONS .....	42
4.3.7	TEST RESULTS .....	43
4.4	MAXIMUM PEAK OUTPUT POWER .....	49
4.4.1	LIMITS OF MAXIMUM PEAK OUTPUT POWER MEASUREMENT .....	49
4.4.2	INSTRUMENTS.....	49
4.4.1	TEST PROCEDURES .....	50
4.4.2	DEVIATION FROM TEST STANDARD .....	50
4.4.3	TEST SETUP .....	50
4.4.4	EUT OPERATING CONDITIONS .....	50
4.4.3	TEST RESULTS .....	51
4.5	POWER SPECTRAL DENSITY MEASUREMENT.....	52
4.5.1	LIMITS OF POWER SPECTRAL DENSITY MEASUREMENT .....	52
4.5.2	TEST INSTRUMENTS.....	52



4.5.3	TEST PROCEDURE.....	53
4.5.4	DEVIATION FROM TEST STANDARD .....	53
4.5.5	TEST SETUP .....	53
4.5.6	EUT OPERATING CONDITION .....	53
4.5.7	TEST RESULTS .....	54
4.6	BAND EDGES MEASUREMENT .....	60
4.6.1	LIMITS OF BAND EDGES MEASUREMENT .....	60
4.6.2	TEST INSTRUMENTS.....	60
4.6.3	TEST PROCEDURE.....	60
4.6.4	DEVIATION FROM TEST STANDARD .....	60
4.6.5	EUT OPERATING CONDITION .....	60
4.6.6	TEST RESULTS .....	61
4.7	ANTENNA REQUIREMENT .....	69
4.7.1	STANDARD APPLICABLE .....	69
4.7.2	ANTENNA CONNECTED CONSTRUCTION.....	69
5.	TEST TYPES AND RESULTS (FOR 802.11a 5745~5825MHz Band) .....	70
5.1	CONDUCTED EMISSION MEASUREMENT .....	70
5.1.1	LIMITS OF CONDUCTED EMISSION MEASUREMENT.....	70
5.1.2	TEST INSTRUMENTS.....	70
5.1.3	TEST PROCEDURES .....	71
5.1.4	DEVIATION FROM TEST STANDARD .....	71
5.1.5	TEST SETUP .....	72
5.1.6	EUT OPERATING CONDITIONS .....	72
5.1.7	TEST RESULTS .....	73
5.2	RADIATED EMISSION MEASUREMENT .....	77
5.2.1	LIMITS OF RADIATED EMISSION MEASUREMENT.....	77
5.2.2	TEST INSTRUMENTS.....	78
5.2.3	TEST PROCEDURES .....	79
5.2.4	DEVIATION FROM TEST STANDARD .....	79
5.2.5	TEST SETUP .....	80
5.2.6	EUT OPERATING CONDITIONS .....	80
5.2.7	TEST RESULTS .....	81
5.3	6dB BANDWIDTH MEASUREMENT .....	86
5.3.1	LIMITS OF 6dB BANDWIDTH MEASUREMENT .....	86
5.3.2	TEST INSTRUMENTS.....	86
5.3.3	TEST PROCEDURE.....	87
5.3.4	DEVIATION FROM TEST STANDARD .....	87
5.3.5	TEST SETUP .....	87
5.3.6	EUT OPERATING CONDITIONS .....	87
5.3.7	TEST RESULTS .....	88
5.4	MAXIMUM PEAK OUTPUT POWER .....	91
5.4.1	LIMITS OF MAXIMUM PEAK OUTPUT POWER MEASUREMENT.....	91
5.4.2	INSTRUMENTS.....	91
5.4.3	TEST PROCEDURES .....	92
5.4.4	DEVIATION FROM TEST STANDARD .....	92
5.4.5	TEST SETUP .....	92
5.4.6	EUT OPERATING CONDITIONS .....	92
5.4.7	TEST RESULTS .....	93
5.5	POWER SPECTRAL DENSITY MEASUREMENT.....	94
5.5.1	LIMITS OF POWER SPECTRAL DENSITY MEASUREMENT .....	94



5.5.2	TEST INSTRUMENTS.....	94
5.5.3	TEST PROCEDURE.....	95
5.5.4	DEVIATION FROM TEST STANDARD .....	95
5.5.5	TEST SETUP .....	95
5.5.6	EUT OPERATING CONDITION .....	95
5.5.7	TEST RESULTS .....	96
5.6	BAND EDGES MEASUREMENT .....	99
5.6.1	LIMITS OF BAND EDGES MEASUREMENT .....	99
5.6.2	TEST INSTRUMENTS.....	99
5.6.3	TEST PROCEDURE.....	99
5.6.4	DEVIATION FROM TEST STANDARD .....	99
5.6.5	EUT OPERATING CONDITION .....	100
5.6.6	TEST RESULTS .....	100
5.7	ANTENNA REQUIREMENT .....	104
5.7.1	STANDARD APPLICABLE .....	104
5.7.2	ANTENNA CONNECTED CONSTRUCTION.....	104
6.	INFORMATION ON THE TESTING LABORATORIES .....	105
	APPENDIX-A.....	A-1



# 1. CERTIFICATION

**PRODUCT:** Enterprise Digital Assistant  
**MODEL:** MC7095  
**BRAND:** Symbol  
**APPLICANT:** Symbol Technologies, Inc.  
**TEST SAMPLE:** ENGINEERING SAMPLE  
**TESTED:** Aug. 07 ~ Aug. 22, 2006  
**STANDARDS:** FCC Part 15, Subpart C (Section 15.247),  
ANSI C63.4-2003

The above equipment has been tested by **Advance Data Technology Corporation**, and found compliance with the requirement of the above standards. The test record, data evaluation & Equipment Under Test (EUT) configurations represented herein are true and accurate accounts of the measurements of the sample's EMC characteristics under the conditions specified in this report.

**PREPARED BY** : Andrea Hsia , **DATE:** Sep. 01, 2006  
Andrea Hsia

**TECHNICAL ACCEPTANCE** : Long Chen , **DATE:** Sep. 01, 2006  
Responsible for RF Long Chen

**APPROVED BY** : Gary Chang , **DATE:** Sep. 01, 2006  
Gary Chang / Supervisor

## 2. SUMMARY OF TEST RESULTS

The EUT has been tested according to the following specifications:

<b>APPLIED STANDARD: FCC Part 15, Subpart C (Section 15.247)</b>			
<b>Standard Section</b>	<b>Test Type and Limit</b>	<b>Result</b>	<b>Remark</b>
15.207	AC Power Conducted Emission	PASS	Meet the requirement of limit. Minimum passing margin is -10.88dB at 4.492MHz
15.247(a)(2)	Spectrum Bandwidth of a Direct Sequence Spread Spectrum System Limit: min. 500kHz	PASS	Meet the requirement of limit.
15.247(b)	Maximum Peak Output Power Limit: max. 30dBm	PASS	Meet the requirement of limit.
15.247(d)	Radiated Emissions Limit: Table 15.209	PASS	Meet the requirement of limit. Minimum passing margin is -3.80dB at 11570.00MHz
15.247(e)	Power Spectral Density Limit: max. 8dBm	PASS	Meet the requirement of limit.
15.247(d)	Band Edge Measurement Limit: 20dB less than the peak value of fundamental frequency	PASS	Meet the requirement of limit.

### 2.1 MEASUREMENT UNCERTAINTY

Where relevant, the following measurement uncertainty levels have been estimated for tests performed on the EUT as specified in CISPR 16-4:

<b>Measurement</b>	<b>Frequency</b>	<b>Uncertainty</b>
Conducted emissions	9kHz~30MHz	2.44 dB
Radiated emissions	30MHz ~ 200MHz	3.62 dB
	200MHz ~1000MHz	3.64 dB
	1GHz ~ 18GHz	2.26 dB
	18GHz ~ 40GHz	1.94 dB

This uncertainty represents an expanded uncertainty expressed at approximately the 95% confidence level using a coverage factor of k=2.

### 3. GENERAL INFORMATION

#### 3.1 GENERAL DESCRIPTION OF EUT

<b>EUT</b>	Enterprise Digital Assistant
<b>MODEL NO.</b>	MC7095
<b>FCC ID</b>	H9PMC7095
<b>POWER SUPPLY</b>	3.7Vdc from rechargeable lithium battery 5.4Vdc from power adapter for charger 12.0Vdc from power adapter for cradle
<b>MODULATION TYPE</b>	Wireless LAN: CCK, DQPSK, DBPSK for DSSS 64QAM, 16QAM, QPSK, BPSK for OFDM Bluetooth: GFSK for FHSS
<b>MODULATION TECHNOLOGY</b>	DSSS, OFDM, FHSS
<b>TRANSFER RATE</b>	Wireless LAN: 802.11b: 11/5.5/2/1Mbps 802.11g: 54/48/36/24/18/12/9/6Mbps 802.11a: 54/48/36/24/18/12/9/6Mbps Bluetooth: 723Kbps
<b>FREQUENCY RANGE</b>	Wireless LAN: 802.11b & 802.11g: 2.412 ~ 2.462GHz 802.11a: 5.180 ~ 5.250GHz , 5.745 ~ 5.825GHz Bluetooth: 2.402 ~ 2.480GHz
<b>NUMBER OF CHANNEL</b>	Wireless LAN: 802.11b & 802.11g: 11 802.11a: 9 Bluetooth: 79
<b>CHANNEL SPACING</b>	Wireless LAN: 802.11b & 802.11g: 5MHz 802.11a: 20MHz Bluetooth: 1MHz
<b>OUTPUT POWER</b>	Wireless LAN: 63.241mW for 802.11b 56.494mW for 802.11g 25.410mW for 5.180 ~ 5.250GHz 56.494mW for 5.745 ~ 5.825GHz Bluetooth: 0.931mW
<b>ANTENNA TYPE</b>	Wireless LAN: PIFA antenna with 2.0dBi gain (for 2.4GHz) PIFA antenna with 2.5dBi gain (for 5.0GHz) Bluetooth: Chip antenna with 2.0dBi gain
<b>DATA CABLE</b>	0.92m non-shielded cable for earphone
<b>I/O PORTS</b>	Refer to user's manual
<b>ASSOCIATED DEVICES</b>	Earphone, cradle

**NOTE:**

1. The EUT is an Enterprise Digital Assistant with wireless LAN, bluetooth and mobile phone functions. This report is only covered the functions of wireless LAN and bluetooth. The mobile phone function is covered in another two test reports, which standards used are FCC Part 24 and FCC Part 22.
2. The EUT have two lithium batteries listed as below:

<b>HEAVY BATTERY:</b>	
<b>BRAND:</b>	Symbol
<b>MODEL:</b>	82-71364-02
<b>RATING:</b>	3.7Vdc, 3800mAh

<b>MAIN BATTERY:</b>	
<b>BRAND:</b>	Symbol
<b>MODEL:</b>	82-71363-02
<b>RATING:</b>	3.7Vdc, 1900mAh

3. The cradle was operated with following power adapter:

<b>BRAND:</b>	HIPRO
<b>MODEL:</b>	HP-O2040D43
<b>INPUT:</b>	100-240Vac, 50-60Hz, 1.5A
<b>OUTPUT:</b>	12Vdc, 3.33A
<b>POWER LINE:</b>	AC 1.8m non-shielded cable without core DC 1.8m shielded cable with one core

4. The charging cable was operated with following power adapter:

<b>BRAND:</b>	Delta
<b>MODEL:</b>	ADP-16GB A
<b>INPUT:</b>	100-240Vac, 50-60Hz, 0.4A
<b>OUTPUT:</b>	5.4Vdc, 3A
<b>POWER LINE:</b>	AC 0.7m non-shielded cable without core DC 1.87m non-shielded cable with one core

5. The EUT operates in both the 5GHz and 2.4GHz Bands and compatibility with 802.11a and 802.11b, 802.11g technology.
6. Standalone has been investigated in the pretest and final test represent the worst case.
7. Emission of Inter-modulation has been evaluated and is compliance with related rule.
8. The above EUT information was declared by the manufacturer and for more detailed features description, please refer to the manufacturer's specifications or User's Manual.



### 3.2 DESCRIPTION OF TEST MODES

Operated in 2400 ~ 2483.5MHz band:

11 channels are provided to the EUT for wireless LAN function:

CHANNEL	FREQUENCY	CHANNEL	FREQUENCY
1	2412 MHz	7	2442 MHz
2	2417 MHz	8	2447 MHz
3	2422 MHz	9	2452 MHz
4	2427 MHz	10	2457 MHz
5	2432 MHz	11	2462 MHz
6	2437 MHz		

Operated in 5745 ~ 5825MHz band:

5 channels are provided to this EUT for wireless LAN function:

CHANNEL	FREQUENCY
1	5745 MHz
2	5765 MHz
3	5785 MHz
4	5805 MHz
5	5825 MHz

### 3.2.1 CONFIGURATION OF SYSTEM UNDER TEST

#### Test Mode A

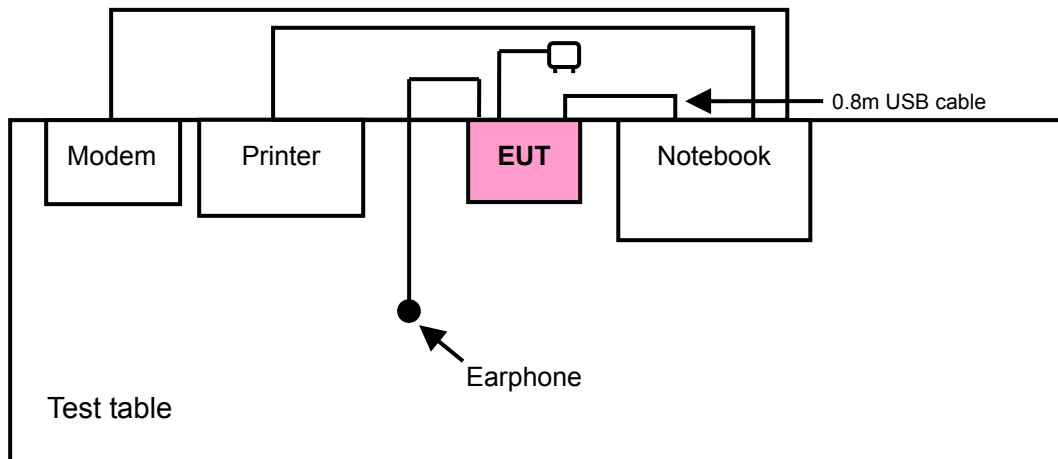

#### Test Mode B

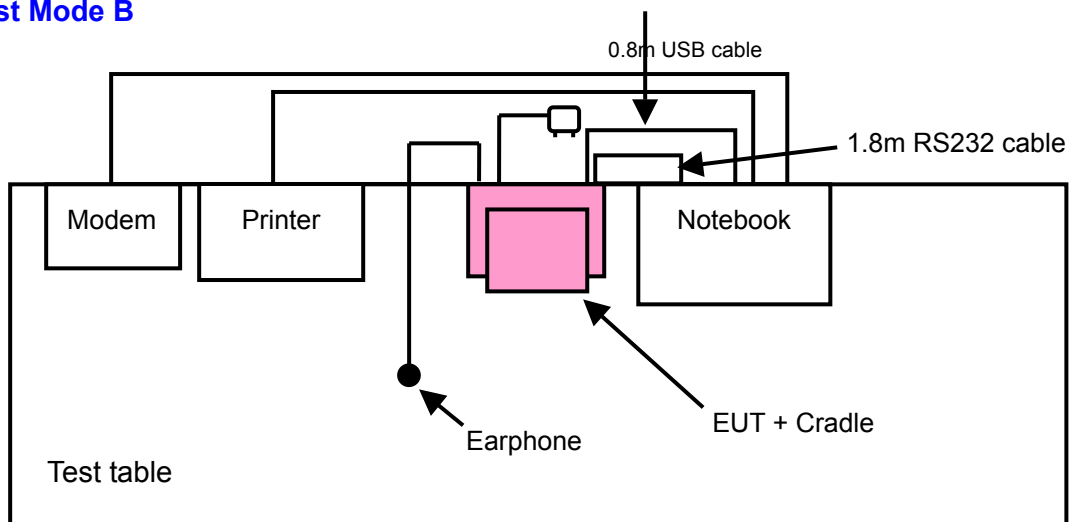

### 3.2.2 TEST MODE APPLICABILITY AND TESTED CHANNEL DETAIL

EUT configure mode	Applicable to				Description
	PLC	RE<1G	RE≥1G	APCM	
A	√	√	√	√	The EUT with heavy battery connected with the earphone, and was powered by the adapter mode: ADP-16GB A
B	√	√	-	-	The EUT with heavy battery connected with the earphone and cradle, and was powered by the adapter model: HP-O2040D43

Where **PLC**: Power Line Conducted Emission  
**RE≥1G**: Radiated Emission above 1GHz

**RE<1G**: Radiated Emission below 1GHz  
**APCM**: Antenna Port Conducted Measurement

**Note:** “-“ means no effect.

#### **Power Line Conducted Emission Test:**

- Pre-Scan has been conducted to determine the worst-case mode from all possible combinations between available modulations, data rates and antenna ports (if EUT with antenna diversity architecture).
- Following channel(s) was (were) selected for the final test as listed below.

EUT CONFIGURE MODE	MODE	AVAILABLE CHANNEL	TESTED CHANNEL	MODULATION TECHNOLOGY	MODULATION TYPE	DATA RATE (Mbps)
A	802.11g	1 to 11	1, 6, 11	OFDM	BPSK	6
A	802.11a	1 to 5	5	OFDM	BPSK	6
B	802.11g	1 to 11	1, 6, 11	OFDM	BPSK	6
B	802.11a	1 to 5	5	OFDM	BPSK	6

#### **Radiated Emission Test (Below 1 GHz):**

- Pre-Scan has been conducted to determine the worst-case mode from all possible combinations between available modulations, data rates, antenna ports (if EUT with antenna diversity architecture), and X, Y and Z Axis.
- Following channel(s) was (were) selected for the final test as listed below.

EUT CONFIGURE MODE	MODE	AVAILABLE CHANNEL	TESTED CHANNEL	MODULATION TECHNOLOGY	MODULATION TYPE	DATA RATE (Mbps)	AXIS
A	802.11g	1 to 11	11	OFDM	BPSK	6	Y
A	802.11a	1 to 5	5	OFDM	BPSK	6	Y
B	802.11g	1 to 11	11	OFDM	BPSK	6	-
B	802.11a	1 to 5	5	OFDM	BPSK	6	-



**Radiated Emission Test (Above 1 GHz):**

- Pre-Scan has been conducted to determine the worst-case mode from all possible combinations between available modulations, data rates, antenna ports (if EUT with antenna diversity architecture) , and X, Y and Z Axis.
- Following channel(s) was (were) selected for the final test as listed below.

MODE	AVAILABLE CHANNEL	TESTED CHANNEL	MODULATION TECHNOLOGY	MODULATION TYPE	DATA RATE (Mbps)	AXIS
802.11b	1 to 11	1, 6, 11	DSSS	DBPSK	1	Y
802.11g	1 to 11	1, 6, 11	OFDM	BPSK	6	Y
802.11a	1 to 5	1, 3, 5	OFDM	BPSK	6	Y

**Bandedge Measurement:**

- Pre-Scan has been conducted to determine the worst-case mode from all possible combinations between available modulations, data rates and antenna ports (if EUT with antenna diversity architecture).
- Following channel(s) was (were) selected for the final test as listed below.

MODE	AVAILABLE CHANNEL	TESTED CHANNEL	MODULATION TECHNOLOGY	MODULATION TYPE	DATA RATE (Mbps)
802.11b	1 to 11	1, 11	DSSS	DBPSK	1
802.11g	1 to 11	1, 11	OFDM	BPSK	6
802.11a	1 to 5	1, 5	OFDM	BPSK	6

**Antenna Port Conducted Measurement:**

- Pre-Scan has been conducted to determine the worst-case mode from all possible combinations between available modulations, data rates and antenna ports (if EUT with antenna diversity architecture).
- Following channel(s) was (were) selected for the final test as listed below.

MODE	AVAILABLE CHANNEL	TESTED CHANNEL	MODULATION TECHNOLOGY	MODULATION TYPE	DATA RATE (Mbps)
802.11b	1 to 11	1, 6, 11	DSSS	DBPSK	1
802.11g	1 to 11	1, 6, 11	OFDM	BPSK	6
802.11a	1 to 5	1, 3, 5	OFDM	BPSK	6



### 3.3 GENERAL DESCRIPTION OF APPLIED STANDARDS

The EUT is a RF Product. According to the specifications of the manufacturer, it must comply with the requirements of the following standards:

#### FCC Part 15, Subpart C. (15.247)

#### ANSI C63.4-2003

All test items have been performed and recorded as per the above standards.

**NOTE:** The EUT is also considered as a kind of computer peripheral, because the connection to computer is necessary for typical use. It has been verified to comply with the requirements of FCC Part 15, Subpart B, Class B (DoC). The test report has been issued separately.

### 3.4 DESCRIPTION OF SUPPORT UNITS

The EUT has been tested as an independent unit together with other necessary accessories or support units. The following support units or accessories were used to form a representative test configuration during the tests.

NO.	PRODUCT	BRAND	MODEL NO.	SERIAL NO.	FCC ID
1	NOTEBOOK COMPUTER	DELL	PP05L	16484462992	E2K24CLNS
2	MODEM	ACEEX	1414V/3	0401008269	IFAXDM1414
3	PRINTER	EPSON	LQ-300+	DCGY054147	FCC DoC Approved

NO.	SIGNAL CABLE DESCRIPTION OF THE ABOVE SUPPORT UNITS
1	NA
2	1.8 m shielded cable without core
3	1.2 m shielded cable without core

**NOTE:** All power cords of the above support units are non shielded (1.8m).



## 4. TEST TYPES AND RESULTS (FOR 802.11b & g 2412~2462MHz BAND)

### 4.1 CONDUCTED EMISSION MEASUREMENT

#### 4.1.1 LIMITS OF CONDUCTED EMISSION MEASUREMENT

FREQUENCY OF EMISSION (MHz)	CONDUCTED LIMIT (dB $\mu$ V)	
	Quasi-peak	Average
0.15-0.5	66 to 56	56 to 46
0.5-5	56	46
5-30	60	50

- NOTE:**
1. The lower limit shall apply at the transition frequencies.
  2. The limit decreases in line with the logarithm of the frequency in the range of 0.15 to 0.50 MHz.
  3. All emanations from a class A/B digital device or system, including any network of conductors and apparatus connected thereto, shall not exceed the level of field strengths specified above.

#### 4.1.2 TEST INSTRUMENTS

DESCRIPTION & MANUFACTURER	MODEL NO.	SERIAL NO.	CALIBRATED UNTIL
Test Receiver ROHDE & SCHWARZ	ESCS30	100288	Nov. 02, 2006
RF signal cable Woken	5D-FB	Cable-HYCO3-01	Jan. 06, 2007
LISN ROHDE & SCHWARZ	ESH2-Z5	100100	Jan. 09, 2007
LISN ROHDE & SCHWARZ	ESH3-Z5	100311	Jan. 22, 2007
Software ADT	ADT_Cond_V3	NA	NA

- NOTE:**
1. The calibration interval of the above test instruments is 12 months and the calibrations are traceable to NML/ROC and NIST/USA.
  2. The test was performed in HwaYa Shielded Room 2.
  3. The VCCI Site Registration No. is C-2047.

#### 4.1.3 TEST PROCEDURES

- a. The EUT was placed 0.4 meters from the conducting wall of the shielded room with EUT being connected to the power mains through a line impedance stabilization network (LISN). Other support units were connected to the power mains through another LISN. The two LISNs provide 50 ohm/ 50uH of coupling impedance for the measuring instrument.
- b. Both lines of the power mains connected to the EUT were checked for maximum conducted interference.
- c. The frequency range from 150kHz to 30MHz was searched. Emission levels under (Limit - 20dB) was not recorded.

#### 4.1.4 DEVIATION FROM TEST STANDARD

No deviation

#### 4.1.5 TEST SETUP

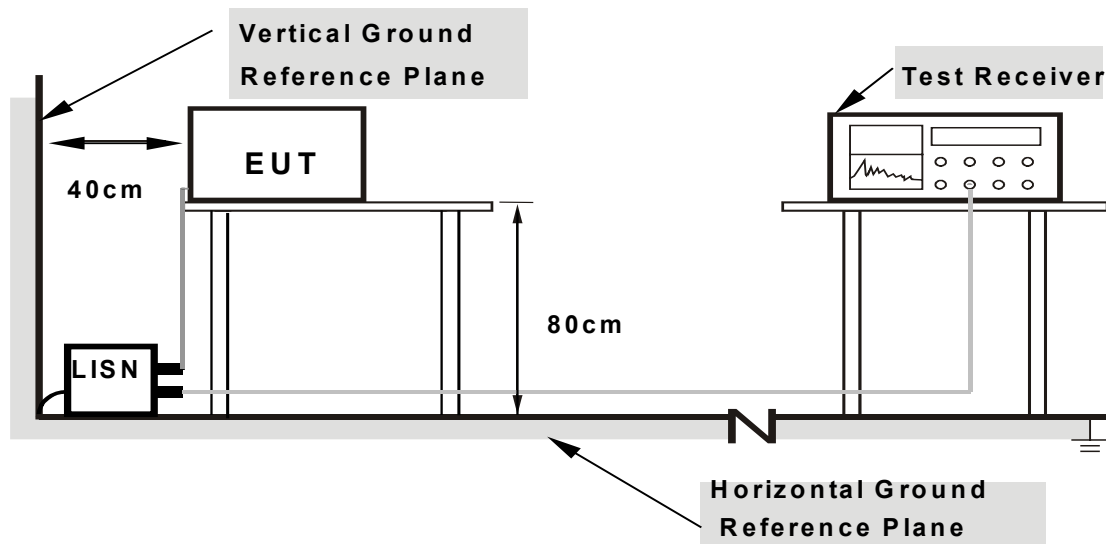

- Note:**
1. Support units were connected to second LISN.
  2. Both of LISNs (AMN) are 80 cm from EUT and at least 80 from other units and other metal planes

For the actual test configuration, please refer to the related item – Photographs of the Test Configuration.

#### 4.1.6 EUT OPERATING CONDITIONS

- a. Connected the EUT to notebook system placed on a testing table.
- b. The EUT ran a test program (provided by manufacturer) to enable EUT under transmission condition continuously at specific channel frequency.
- c. The notebook system sent "H" messages to its screen.
- d. The notebook system sent "H" messages to modem.
- e. The notebook system sent "H" messages to printer, and the printer printed them on paper.
- f. Steps c ~ e were repeated.



#### 4.1.7 TEST RESULTS

##### Conducted Worst-Case Data

EUT TEST CONDITION		MEASUREMENT DETAIL	
CHANNEL	Channel 1	PHASE	Line 1
MODULATION TYPE	BPSK	6dB BANDWIDTH	9 kHz
TRANSFER RATE	6Mbps	ENVIRONMENTAL CONDITIONS	20deg. C, 60%RH, 991hPa
INPUT POWER (SYSTEM)	120Vac, 60 Hz	TEST MODE	A
TESTED BY	Match Tsui		

No	Freq. [MHz]	Corr. Factor [dB]	Reading Value [dB (uV)]		Emission Level [dB (uV)]		Limit [dB (uV)]		Margin (dB)	
			Q.P.	AV.	Q.P.	AV.	Q.P.	AV.	Q.P.	AV.
1	0.189	0.10	47.53	-	47.63	-	64.08	54.08	-16.45	-
2	0.263	0.10	36.25	-	36.35	-	61.33	51.33	-24.98	-
3	0.533	0.10	22.04	-	22.14	-	56.00	46.00	-33.86	-
4	1.867	0.19	18.52	-	18.71	-	56.00	46.00	-37.29	-
5	7.535	0.36	23.23	-	23.59	-	60.00	50.00	-36.41	-
6	29.391	1.28	29.79	-	31.07	-	60.00	50.00	-28.93	-

- REMARKS:**
1. Q.P. and AV. are abbreviations of quasi-peak and average individually.
  2. "-": The Quasi-peak reading value also meets average limit and measurement with the average detector is unnecessary.
  3. The emission levels of other frequencies were very low against the limit.
  4. Margin value = Emission level - Limit value
  5. Correction factor = Insertion loss + Cable loss
  6. Emission Level = Correction Factor + Reading Value.

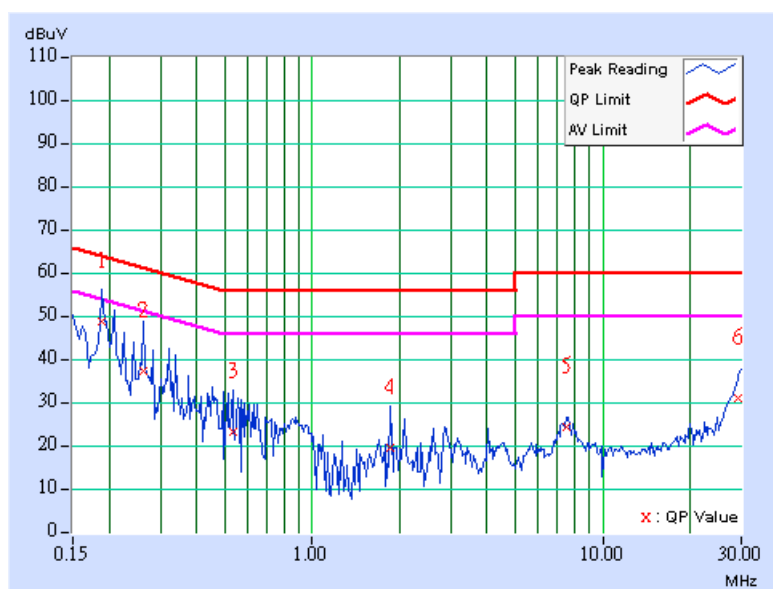

EUT TEST CONDITION		MEASUREMENT DETAIL	
CHANNEL	Channel 1	PHASE	Line 2
MODULATION TYPE	BPSK	6dB BANDWIDTH	9 kHz
TRANSFER RATE	6Mbps	ENVIRONMENTAL CONDITIONS	20deg. C, 60%RH, 991hPa
INPUT POWER (SYSTEM)	120Vac, 60 Hz	TEST MODE	A
TESTED BY	Match Tsui		

No	Freq. [MHz]	Corr. Factor (dB)	Reading Value [dB (uV)]		Emission Level [dB (uV)]		Limit [dB (uV)]		Margin (dB)	
			Q.P.	AV.	Q.P.	AV.	Q.P.	AV.	Q.P.	AV.
1	0.193	0.10	47.57	-	47.67	-	63.91	53.91	-16.24	-
2	0.259	0.10	36.96	-	37.06	-	61.45	51.45	-24.39	-
3	0.326	0.10	32.42	-	32.52	-	59.56	49.56	-27.04	-
4	0.943	0.19	24.89	-	25.08	-	56.00	46.00	-30.92	-
5	2.102	0.21	20.15	-	20.36	-	56.00	46.00	-35.64	-
6	28.977	0.99	25.57	-	26.56	-	60.00	50.00	-33.44	-

- REMARKS:**
1. Q.P. and AV. are abbreviations of quasi-peak and average individually.
  2. "-": The Quasi-peak reading value also meets average limit and measurement with the average detector is unnecessary.
  3. The emission levels of other frequencies were very low against the limit.
  4. Margin value = Emission level - Limit value
  5. Correction factor = Insertion loss + Cable loss
  6. Emission Level = Correction Factor + Reading Value.

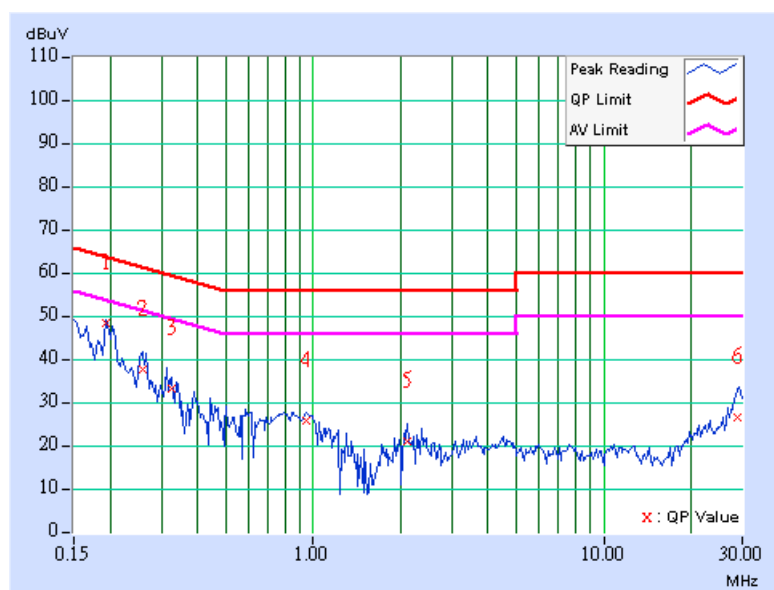

EUT TEST CONDITION		MEASUREMENT DETAIL	
CHANNEL	Channel 6	PHASE	Line 1
MODULATION TYPE	BPSK	6dB BANDWIDTH	9 kHz
TRANSFER RATE	6Mbps	ENVIRONMENTAL CONDITIONS	20deg. C, 60%RH, 991hPa
INPUT POWER (SYSTEM)	120Vac, 60 Hz	TEST MODE	A
TESTED BY	Match Tsui		

No	Freq. [MHz]	Corr. Factor [dB]	Reading Value [dB (uV)]		Emission Level [dB (uV)]		Limit [dB (uV)]		Margin (dB)	
			Q.P.	AV.	Q.P.	AV.	Q.P.	AV.	Q.P.	AV.
1	0.193	0.10	46.21	-	46.31	-	63.91	53.91	-17.60	-
2	0.323	0.10	30.73	-	30.83	-	59.64	49.64	-28.81	-
3	0.517	0.10	22.81	-	22.91	-	56.00	46.00	-33.09	-
4	1.668	0.17	17.79	-	17.96	-	56.00	46.00	-38.04	-
5	7.500	0.36	23.27	-	23.63	-	60.00	50.00	-36.37	-
6	28.652	1.22	28.36	-	29.58	-	60.00	50.00	-30.42	-

- REMARKS:**
1. Q.P. and AV. are abbreviations of quasi-peak and average individually.
  2. "-": The Quasi-peak reading value also meets average limit and measurement with the average detector is unnecessary.
  3. The emission levels of other frequencies were very low against the limit.
  4. Margin value = Emission level - Limit value
  5. Correction factor = Insertion loss + Cable loss
  6. Emission Level = Correction Factor + Reading Value.

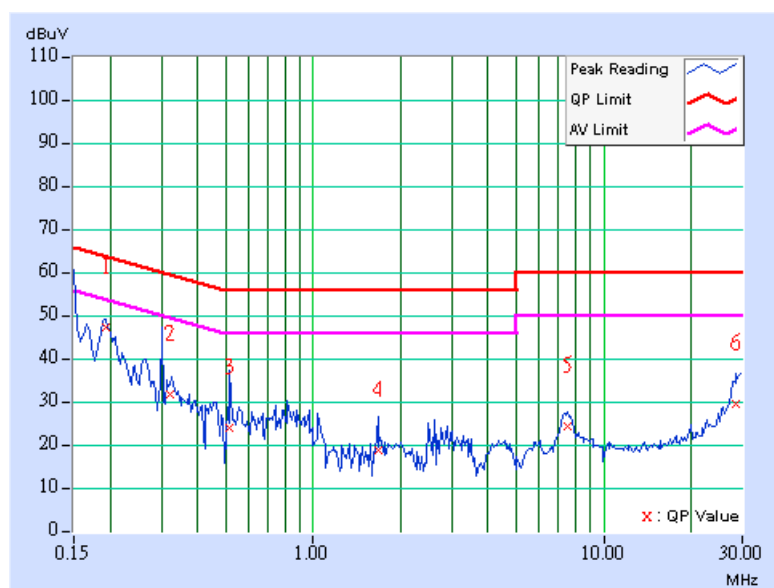

EUT TEST CONDITION		MEASUREMENT DETAIL	
CHANNEL	Channel 6	PHASE	Line 2
MODULATION TYPE	BPSK	6dB BANDWIDTH	9 kHz
TRANSFER RATE	6Mbps	ENVIRONMENTAL CONDITIONS	20deg. C, 60%RH, 991hPa
INPUT POWER (SYSTEM)	120Vac, 60 Hz	TEST MODE	A
TESTED BY	Match Tsui		

No	Freq. [MHz]	Corr. Factor (dB)	Reading Value [dB (uV)]		Emission Level [dB (uV)]		Limit [dB (uV)]		Margin (dB)	
			Q.P.	AV.	Q.P.	AV.	Q.P.	AV.	Q.P.	AV.
1	0.189	0.10	46.83	-	46.93	-	64.08	54.08	-17.15	-
2	0.263	0.10	35.54	-	35.64	-	61.33	51.33	-25.69	-
3	0.517	0.12	22.45	-	22.57	-	56.00	46.00	-33.43	-
4	0.845	0.17	24.86	-	25.03	-	56.00	46.00	-30.97	-
5	2.293	0.22	20.15	-	20.37	-	56.00	46.00	-35.63	-
6	29.695	1.02	25.97	-	26.99	-	60.00	50.00	-33.01	-

- REMARKS:**
1. Q.P. and AV. are abbreviations of quasi-peak and average individually.
  2. "-": The Quasi-peak reading value also meets average limit and measurement with the average detector is unnecessary.
  3. The emission levels of other frequencies were very low against the limit.
  4. Margin value = Emission level - Limit value
  5. Correction factor = Insertion loss + Cable loss
  6. Emission Level = Correction Factor + Reading Value.

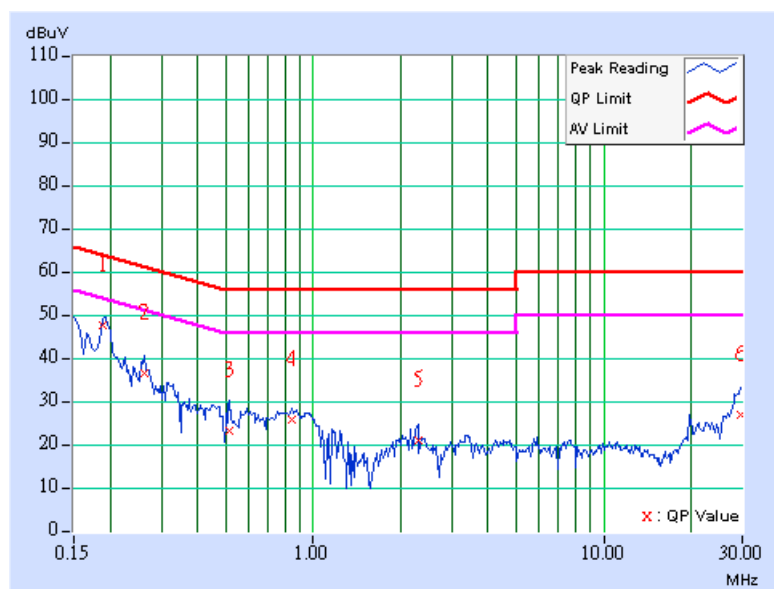

EUT TEST CONDITION		MEASUREMENT DETAIL	
CHANNEL	Channel 11	PHASE	Line 1
MODULATION TYPE	BPSK	6dB BANDWIDTH	9 kHz
TRANSFER RATE	6Mbps	ENVIRONMENTAL CONDITIONS	20deg. C, 60%RH, 991hPa
INPUT POWER (SYSTEM)	120Vac, 60 Hz	TEST MODE	A
TESTED BY	Match Tsui		

No	Freq. [MHz]	Corr. Factor [dB]	Reading Value [dB (uV)]		Emission Level [dB (uV)]		Limit [dB (uV)]		Margin (dB)	
			Q.P.	AV.	Q.P.	AV.	Q.P.	AV.	Q.P.	AV.
			1	0.193	0.10	48.24	-	48.34	-	63.91
2	0.267	0.10	35.60	-	35.70	-	61.20	51.20	-25.50	-
3	0.380	0.10	28.49	-	28.59	-	58.27	48.27	-29.68	-
4	0.923	0.10	21.25	-	21.35	-	56.00	46.00	-34.65	-
5	7.352	0.36	17.83	-	18.19	-	60.00	50.00	-41.81	-
6	28.480	1.21	27.68	-	28.89	-	60.00	50.00	-31.11	-

- REMARKS:**
1. Q.P. and AV. are abbreviations of quasi-peak and average individually.
  2. "-": The Quasi-peak reading value also meets average limit and measurement with the average detector is unnecessary.
  3. The emission levels of other frequencies were very low against the limit.
  4. Margin value = Emission level - Limit value
  5. Correction factor = Insertion loss + Cable loss
  6. Emission Level = Correction Factor + Reading Value.

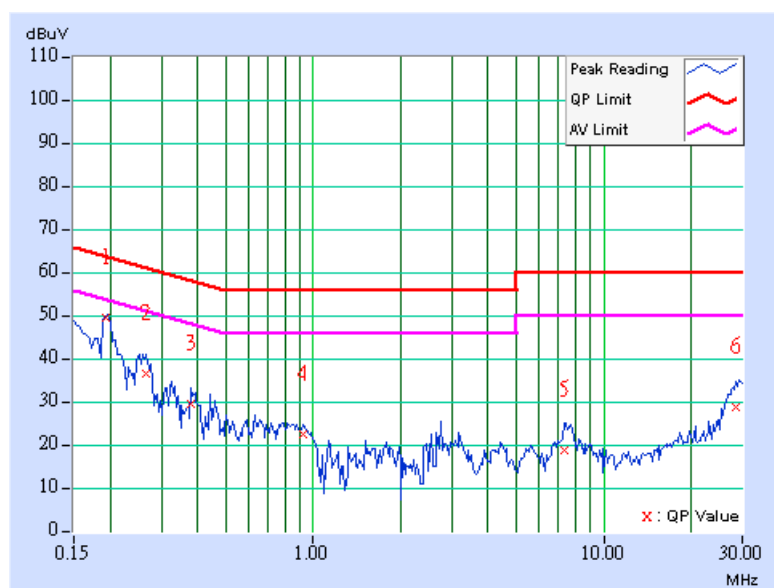

EUT TEST CONDITION		MEASUREMENT DETAIL	
CHANNEL	Channel 11	PHASE	Line 2
MODULATION TYPE	BPSK	6dB BANDWIDTH	9 kHz
TRANSFER RATE	6Mbps	ENVIRONMENTAL CONDITIONS	20deg. C, 60%RH, 991hPa
INPUT POWER (SYSTEM)	120Vac, 60 Hz	TEST MODE	A
TESTED BY	Match Tsui		

No	Freq. [MHz]	Corr. Factor (dB)	Reading Value [dB (uV)]		Emission Level [dB (uV)]		Limit [dB (uV)]		Margin (dB)	
			Q.P.	AV.	Q.P.	AV.	Q.P.	AV.	Q.P.	AV.
1	0.193	0.10	47.09	-	47.19	-	63.91	53.91	-16.72	-
2	0.252	0.10	39.19	-	39.29	-	61.71	51.71	-22.42	-
3	0.396	0.10	27.40	-	27.50	-	57.93	47.93	-30.43	-
4	0.713	0.15	22.08	-	22.23	-	56.00	46.00	-33.77	-
5	2.906	0.28	17.42	-	17.70	-	56.00	46.00	-38.30	-
6	28.820	0.98	20.45	-	21.43	-	60.00	50.00	-38.57	-

- REMARKS:**
1. Q.P. and AV. are abbreviations of quasi-peak and average individually.
  2. "-": The Quasi-peak reading value also meets average limit and measurement with the average detector is unnecessary.
  3. The emission levels of other frequencies were very low against the limit.
  4. Margin value = Emission level - Limit value
  5. Correction factor = Insertion loss + Cable loss
  6. Emission Level = Correction Factor + Reading Value.

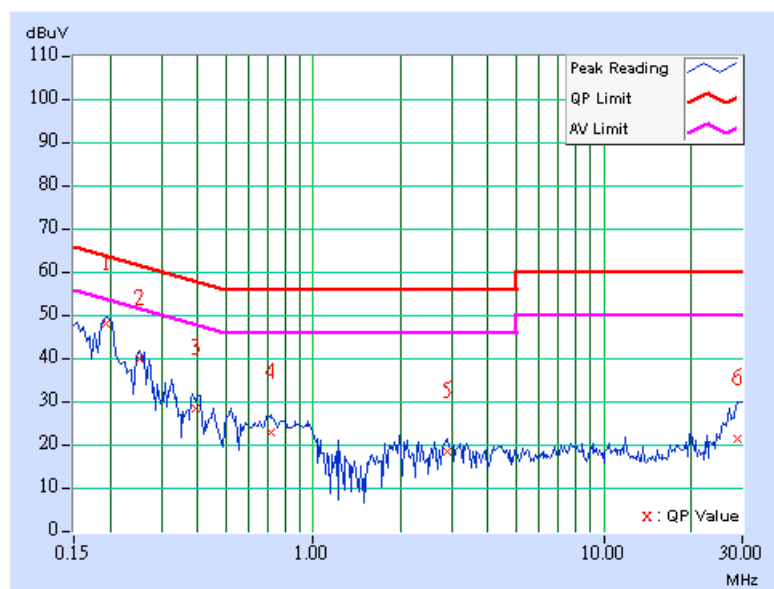

EUT TEST CONDITION		MEASUREMENT DETAIL	
CHANNEL	Channel 1	PHASE	Line 1
MODULATION TYPE	BPSK	6dB BANDWIDTH	9 kHz
TRANSFER RATE	6Mbps	ENVIRONMENTAL CONDITIONS	20deg. C, 60%RH, 991hPa
INPUT POWER (SYSTEM)	120Vac, 60 Hz	TEST MODE	B
TESTED BY	Match Tsui		

No	Freq. [MHz]	Corr. Factor [dB]	Reading Value [dB (uV)]		Emission Level [dB (uV)]		Limit [dB (uV)]		Margin (dB)	
			Q.P.	AV.	Q.P.	AV.	Q.P.	AV.	Q.P.	AV.
1	0.209	0.10	47.82	-	47.92	-	63.26	53.26	-15.34	-
2	0.314	0.10	38.15	-	38.25	-	59.86	49.86	-21.61	-
3	0.420	0.10	33.43	-	33.53	-	57.46	47.46	-23.93	-
4	0.627	0.10	30.65	-	30.75	-	56.00	46.00	-25.25	-
5	5.012	0.37	35.00	-	35.37	-	60.00	50.00	-24.63	-
6	25.996	1.01	26.74	-	27.75	-	60.00	50.00	-32.25	-

- REMARKS:**
1. Q.P. and AV. are abbreviations of quasi-peak and average individually.
  2. "-": The Quasi-peak reading value also meets average limit and measurement with the average detector is unnecessary.
  3. The emission levels of other frequencies were very low against the limit.
  4. Margin value = Emission level - Limit value
  5. Correction factor = Insertion loss + Cable loss
  6. Emission Level = Correction Factor + Reading Value.

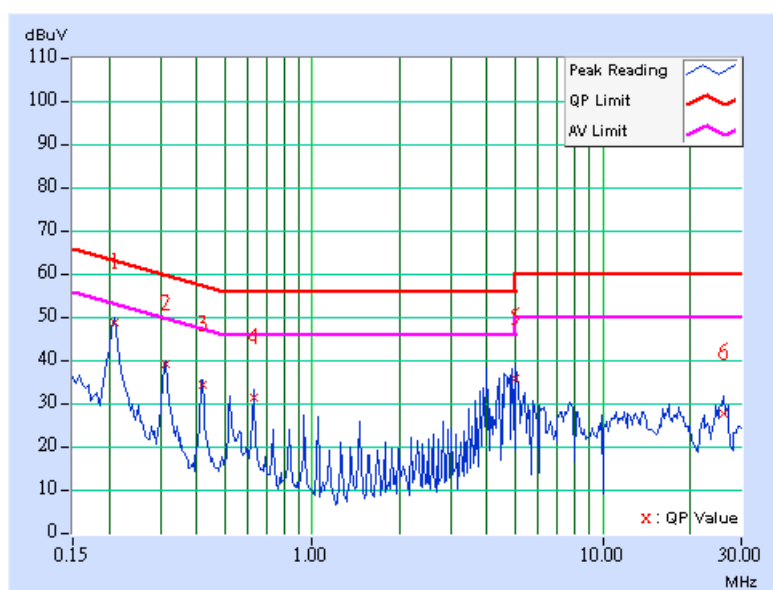

EUT TEST CONDITION		MEASUREMENT DETAIL	
CHANNEL	Channel 1	PHASE	Line 2
MODULATION TYPE	BPSK	6dB BANDWIDTH	9 kHz
TRANSFER RATE	6Mbps	ENVIRONMENTAL CONDITIONS	20deg. C, 60%RH, 991hPa
INPUT POWER (SYSTEM)	120Vac, 60 Hz	TEST MODE	B
TESTED BY	Match Tsui		

No	Freq. [MHz]	Corr. Factor (dB)	Reading Value [dB (uV)]		Emission Level [dB (uV)]		Limit [dB (uV)]		Margin (dB)	
			Q.P.	AV.	Q.P.	AV.	Q.P.	AV.	Q.P.	AV.
1	0.209	0.10	47.21	-	47.31	-	63.26	53.26	-15.95	-
2	0.314	0.10	38.17	-	38.27	-	59.86	49.86	-21.59	-
3	0.420	0.10	33.47	-	33.57	-	57.46	47.46	-23.88	-
4	0.627	0.14	30.11	-	30.25	-	56.00	46.00	-25.75	-
5	4.383	0.38	39.18	-	39.56	-	56.00	46.00	-16.44	-
6	16.176	0.61	24.93	-	25.54	-	60.00	50.00	-34.46	-

- REMARKS:**
1. Q.P. and AV. are abbreviations of quasi-peak and average individually.
  2. "-": The Quasi-peak reading value also meets average limit and measurement with the average detector is unnecessary.
  3. The emission levels of other frequencies were very low against the limit.
  4. Margin value = Emission level - Limit value
  5. Correction factor = Insertion loss + Cable loss
  6. Emission Level = Correction Factor + Reading Value.

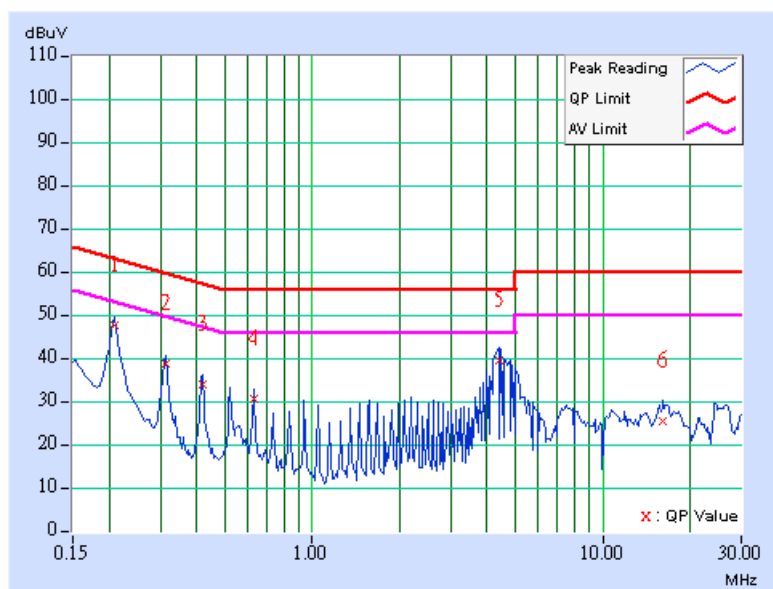



EUT TEST CONDITION		MEASUREMENT DETAIL	
CHANNEL	Channel 6	PHASE	Line 1
MODULATION TYPE	BPSK	6dB BANDWIDTH	9 kHz
TRANSFER RATE	6Mbps	ENVIRONMENTAL CONDITIONS	20deg. C, 60%RH, 991hPa
INPUT POWER (SYSTEM)	120Vac, 60 Hz	TEST MODE	B
TESTED BY	Match Tsui		

No	Freq. [MHz]	Corr. Factor [dB]	Reading Value [dB (uV)]		Emission Level [dB (uV)]		Limit [dB (uV)]		Margin (dB)	
			Q.P.	AV.	Q.P.	AV.	Q.P.	AV.	Q.P.	AV.
			1	0.209	0.10	47.80	-	47.90	-	63.26
2	0.314	0.10	38.10	-	38.20	-	59.86	49.86	-21.66	-
3	0.416	0.10	33.51	-	33.61	-	57.54	47.54	-23.93	-
4	0.627	0.10	30.59	-	30.69	-	56.00	46.00	-25.31	-
5	4.277	0.37	39.20	-	39.57	-	56.00	46.00	-16.43	-
6	25.895	1.00	26.11	-	27.11	-	60.00	50.00	-32.89	-

- REMARKS:**
1. Q.P. and AV. are abbreviations of quasi-peak and average individually.
  2. "-": The Quasi-peak reading value also meets average limit and measurement with the average detector is unnecessary.
  3. The emission levels of other frequencies were very low against the limit.
  4. Margin value = Emission level - Limit value
  5. Correction factor = Insertion loss + Cable loss
  6. Emission Level = Correction Factor + Reading Value.

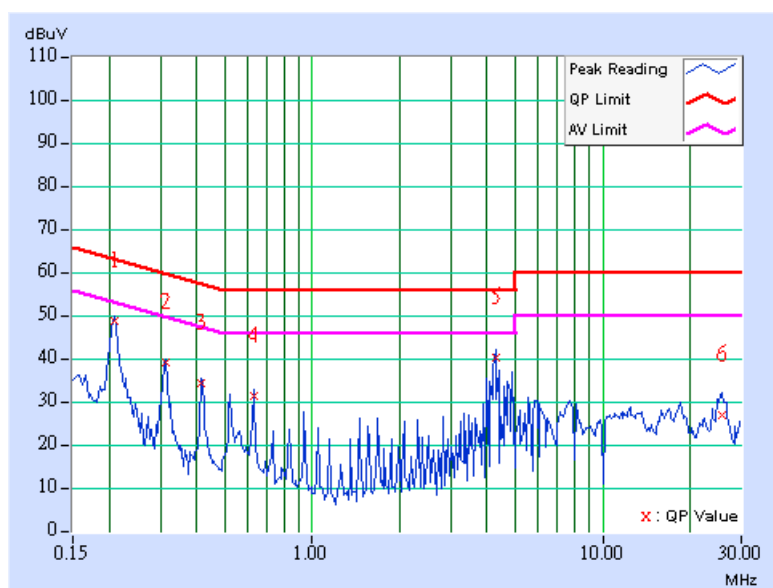

EUT TEST CONDITION		MEASUREMENT DETAIL	
CHANNEL	Channel 6	PHASE	Line 2
MODULATION TYPE	BPSK	6dB BANDWIDTH	9 kHz
TRANSFER RATE	6Mbps	ENVIRONMENTAL CONDITIONS	20deg. C, 60%RH, 991hPa
INPUT POWER (SYSTEM)	120Vac, 60 Hz	TEST MODE	B
TESTED BY	Match Tsui		

No	Freq. [MHz]	Corr. Factor (dB)	Reading Value [dB (uV)]		Emission Level [dB (uV)]		Limit [dB (uV)]		Margin (dB)	
			Q.P.	AV.	Q.P.	AV.	Q.P.	AV.	Q.P.	AV.
1	0.209	0.10	47.15	-	47.25	-	63.26	53.26	-16.01	-
2	0.314	0.10	38.08	-	38.18	-	59.86	49.86	-21.68	-
3	0.420	0.10	33.41	-	33.51	-	57.46	47.46	-23.94	-
4	0.627	0.14	30.07	-	30.21	-	56.00	46.00	-25.79	-
5	4.383	0.38	39.32	-	39.70	-	56.00	46.00	-16.30	-
6	24.535	0.80	23.85	-	24.65	-	60.00	50.00	-35.35	-

- REMARKS:**
1. Q.P. and AV. are abbreviations of quasi-peak and average individually.
  2. "-": The Quasi-peak reading value also meets average limit and measurement with the average detector is unnecessary.
  3. The emission levels of other frequencies were very low against the limit.
  4. Margin value = Emission level - Limit value
  5. Correction factor = Insertion loss + Cable loss
  6. Emission Level = Correction Factor + Reading Value.

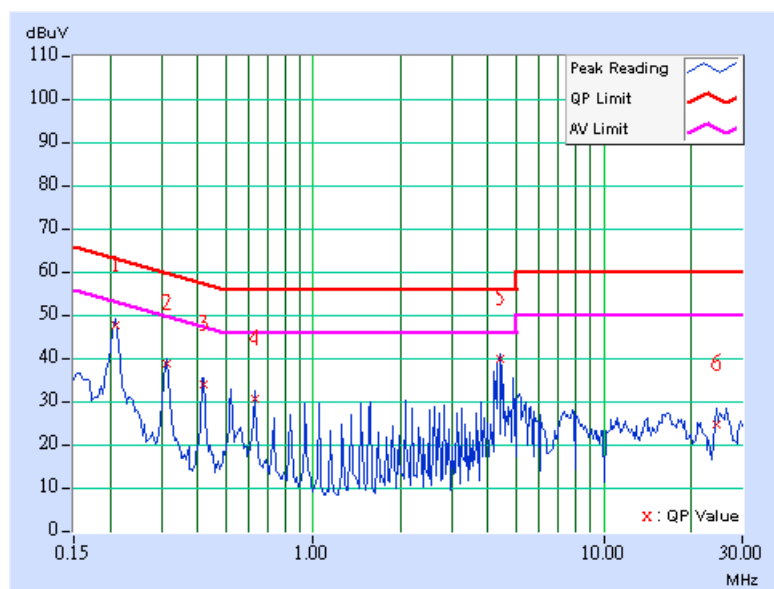

EUT TEST CONDITION		MEASUREMENT DETAIL	
CHANNEL	Channel 11	PHASE	Line 1
MODULATION TYPE	BPSK	6dB BANDWIDTH	9 kHz
TRANSFER RATE	6Mbps	ENVIRONMENTAL CONDITIONS	20deg. C, 60%RH, 991hPa
INPUT POWER (SYSTEM)	120Vac, 60 Hz	TEST MODE	B
TESTED BY	Match Tsui		

No	Freq. [MHz]	Corr. Factor [dB]	Reading Value [dB (uV)]		Emission Level [dB (uV)]		Limit [dB (uV)]		Margin (dB)	
			Q.P.	AV.	Q.P.	AV.	Q.P.	AV.	Q.P.	AV.
1	0.209	0.10	47.71	-	47.81	-	63.26	53.26	-15.45	-
2	0.314	0.10	38.02	-	38.12	-	59.86	49.86	-21.74	-
3	0.416	0.10	33.47	-	33.57	-	57.54	47.54	-23.97	-
4	0.627	0.10	30.47	-	30.57	-	56.00	46.00	-25.43	-
5	4.277	0.37	38.98	-	39.35	-	56.00	46.00	-16.65	-
6	24.430	0.89	26.85	-	27.74	-	60.00	50.00	-32.26	-

- REMARKS:**
1. Q.P. and AV. are abbreviations of quasi-peak and average individually.
  2. "-": The Quasi-peak reading value also meets average limit and measurement with the average detector is unnecessary.
  3. The emission levels of other frequencies were very low against the limit.
  4. Margin value = Emission level - Limit value
  5. Correction factor = Insertion loss + Cable loss
  6. Emission Level = Correction Factor + Reading Value.

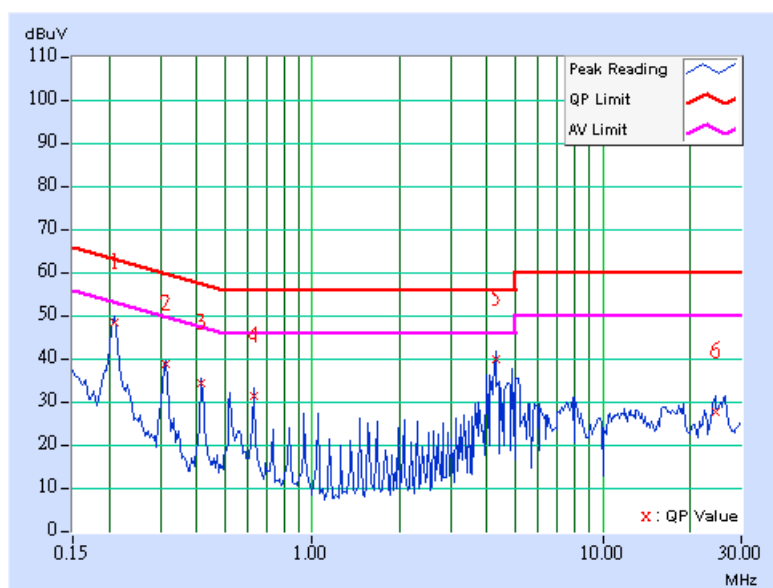

EUT TEST CONDITION		MEASUREMENT DETAIL	
CHANNEL	Channel 11	PHASE	Line 2
MODULATION TYPE	BPSK	6dB BANDWIDTH	9 kHz
TRANSFER RATE	6Mbps	ENVIRONMENTAL CONDITIONS	20deg. C, 60%RH, 991hPa
INPUT POWER (SYSTEM)	120Vac, 60 Hz	TEST MODE	B
TESTED BY	Match Tsui		

No	Freq. [MHz]	Corr. Factor (dB)	Reading Value [dB (uV)]		Emission Level [dB (uV)]		Limit [dB (uV)]		Margin (dB)	
			Q.P.	AV.	Q.P.	AV.	Q.P.	AV.	Q.P.	AV.
1	0.209	0.10	47.07	-	47.17	-	63.26	53.26	-16.09	-
2	0.314	0.10	38.02	-	38.12	-	59.86	49.86	-21.74	-
3	0.416	0.10	33.61	-	33.71	-	57.54	47.54	-23.82	-
4	0.627	0.14	29.99	-	30.13	-	56.00	46.00	-25.87	-
5	4.695	0.38	36.64	-	37.02	-	56.00	46.00	-18.98	-
6	16.698	0.61	24.84	-	25.45	-	60.00	50.00	-34.55	-

- REMARKS:**
1. Q.P. and AV. are abbreviations of quasi-peak and average individually.
  2. "-": The Quasi-peak reading value also meets average limit and measurement with the average detector is unnecessary.
  3. The emission levels of other frequencies were very low against the limit.
  4. Margin value = Emission level - Limit value
  5. Correction factor = Insertion loss + Cable loss
  6. Emission Level = Correction Factor + Reading Value.

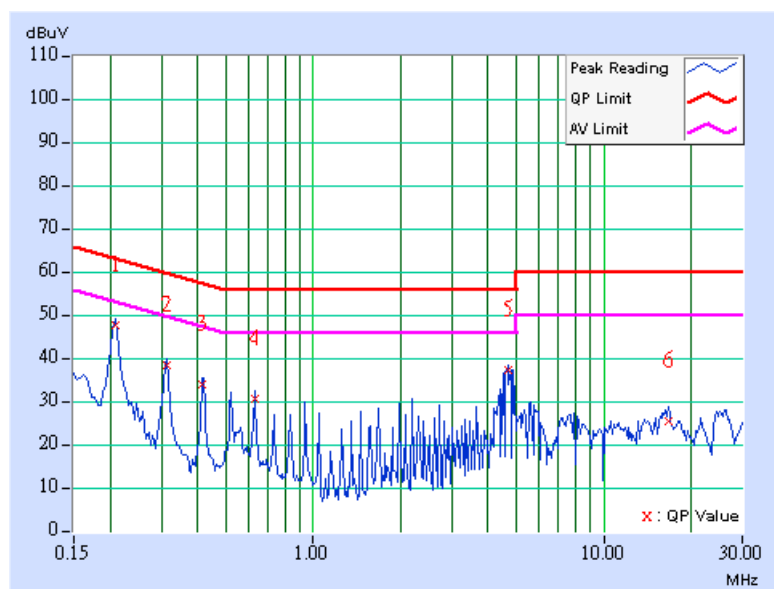

## 4.2 RADIATED EMISSION MEASUREMENT

### 4.2.1 LIMITS OF RADIATED EMISSION MEASUREMENT

Emissions radiated outside of the specified bands, shall be according to the general radiated limits in 15.209 as following:

Frequencies (MHz)	Field strength (microvolts/meter)	Measurement distance (meters)
0.009-0.490	2400/F(kHz)	300
0.490-1.705	24000/F(kHz)	30
1.705-30.0	30	30
30-88	100	3
88-216	150	3
216-960	200	3
Above 960	500	3

**NOTE:**

1. The lower limit shall apply at the transition frequencies.
2. Emission level (dBuV/m) = 20 log Emission level (uV/m).
3. As shown in 15.35(b), for frequencies above 1000MHz, the field strength limits are based on average detector, however, the peak field strength of any emission shall not exceed the maximum permitted average limits, specified above by more than 20dB under any condition of modulation.

#### 4.2.2 TEST INSTRUMENTS

DESCRIPTION & MANUFACTURER	MODEL NO.	SERIAL NO.	CALIBRATED UNTIL
Test Receiver ROHDE & SCHWARZ	ESI7	838496/016	Jan. 01, 2007
Spectrum Analyzer ROHDE & SCHWARZ	FSP40	100041	Dec. 04, 2006
BILOG Antenna SCHWARZBECK	VULB9168	9168-155	Jan. 15, 2007
HORN Antenna SCHWARZBECK	BBHA 9120D	9120D-404	Jan. 01, 2007
HORN Antenna SCHWARZBECK	BBHA 9170	BBHA9170242	Jan. 19, 2007
Preamplifier Agilent	8449B	3008A01960	Nov. 09, 2006
RF signal cable HUBER+SUHNNER	SUCOFLEX 104	219268/4	Dec. 20, 2006
RF signal cable HUBER+SUHNNER	SUCOFLEX 104	230129/4	Dec. 20, 2006
Software ADT.	ADT_Radiated_V5.14	NA	NA
Antenna Tower inn-co GmbH	MA 4000	010303	NA
Antenna Tower Controller inn-co GmbH	CO2000	019303	NA
Turn Table ADT.	TT100.	TT93021704	NA
Turn Table Controller ADT.	SC100.	SC93021704	NA

- NOTE:**
1. The calibration interval of the above test instruments is 12 months and the calibrations are traceable to NML/ROC and NIST/USA.
  2. The test was performed in HwaYa Chamber 3.
  3. The horn antenna and HP preamplifier (model: 8449B) are used only for the measurement of emission frequency above 1GHz if tested.
  4. The IC Site Registration No. is IC4924-4.

#### 4.2.3 TEST PROCEDURES

- a. The EUT was placed on the top of a rotating table 0.8 meters above the ground at a 3 meters semi-anechoic chamber. The table was rotated 360 degrees to determine the position of the highest radiation.
- b. The EUT was set 3 meters away from the interference-receiving antenna, which was mounted on the top of a variable-height antenna tower.
- c. The antenna is a broadband antenna, and its height is varied from one meter to four meters above the ground to determine the maximum value of the field strength. Both horizontal and vertical polarizations of the antenna are set to make the measurement.
- d. For each suspected emission, the EUT was arranged to its worst case and then the antenna was tuned to heights from 1 meter to 4 meters and the rotatable table was turned from 0 degrees to 360 degrees to find the maximum reading.
- e. The test-receiver system was set to Peak Detect Function and Specified Bandwidth with Maximum Hold Mode.
- f. If the emission level of the EUT in peak mode was lower than the limit specified, then testing could be stopped and the peak values of the EUT would be reported. Otherwise the emissions would be re-tested one by one using peak, quasi-peak or average method as specified and then reported in a data sheet.

**NOTE:**

1. The resolution bandwidth and video bandwidth of test receiver/spectrum analyzer is 120kHz for Quasi-peak detection at frequency below 1GHz.
2. The resolution bandwidth and video bandwidth of test receiver/spectrum analyzer is 1 MHz for Peak detection (PK) at frequency above 1GHz.
3. The resolution bandwidth of test receiver/spectrum analyzer is 1 MHz and the video bandwidth is 10Hz for Average detection (AV) at frequency above 1GHz.

#### 4.2.4 DEVIATION FROM TEST STANDARD

No deviation

#### 4.2.5 TEST SETUP

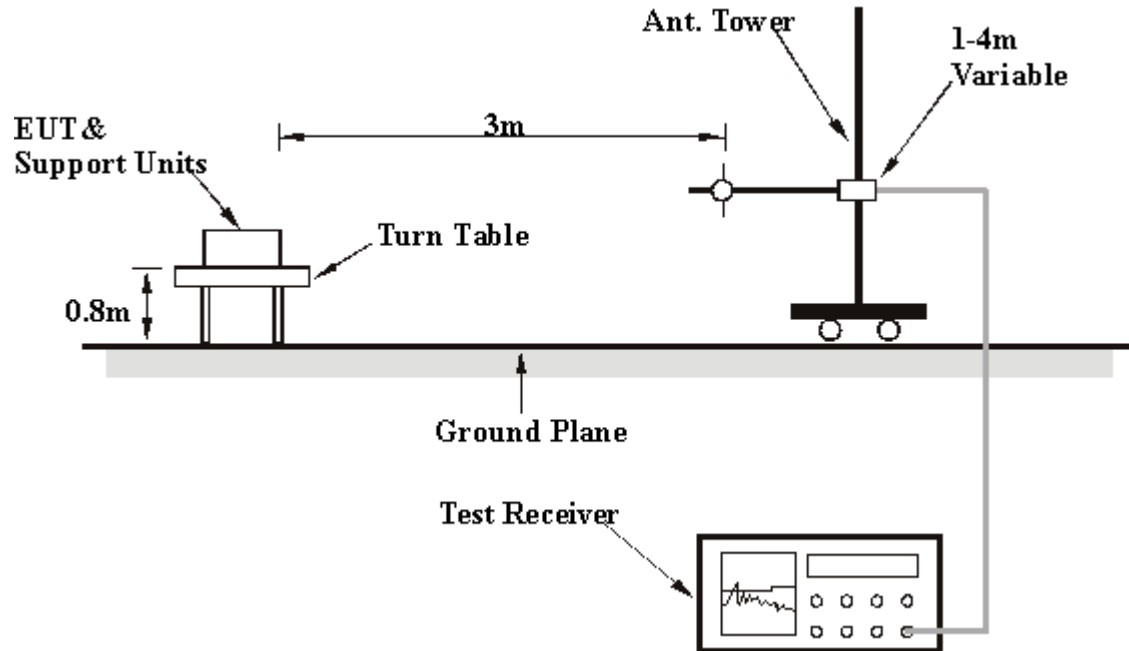

For the actual test configuration, please refer to the related item – Photographs of the Test Configuration.

#### 4.2.6 EUT OPERATING CONDITIONS

Same as 4.1.6





#### 4.2.7 TEST RESULTS

##### Below 1GHz Worst-Case Data

EUT TEST CONDITION		MEASUREMENT DETAIL	
CHANNEL	Channel 11	FREQUENCY RANGE	Below 1000MHz
MODULATION TYPE	BPSK	DETECTOR FUNCTION	Quasi-Peak
TRANSFER RATE	6Mbps	ENVIRONMENTAL CONDITIONS	25deg. C, 65%RH, 991hPa
INPUT POWER (SYSTEM)	120Vac, 60 Hz	TEST MODE	A
TESTED BY	Brad Wu		

ANTENNA POLARITY & TEST DISTANCE: HORIZONTAL AT 3 M								
No.	Freq. (MHz)	Emission Level (dBuV/m)	Limit (dBuV/m)	Margin (dB)	Antenna Height (m)	Table Angle (Degree)	Raw Value (dBuV)	Correction Factor (dB/m)
1	216.61	18.00 QP	46.00	-28.00	1.50 H	256	6.69	11.32
2	294.37	19.34 QP	46.00	-26.66	1.00 H	316	4.16	15.18
3	453.77	21.46 QP	46.00	-24.54	1.00 H	64	2.67	18.79
4	519.86	30.56 QP	46.00	-15.44	1.50 H	121	10.20	20.36
5	564.57	24.19 QP	46.00	-21.81	1.50 H	112	2.73	21.45
6	838.66	31.24 QP	46.00	-14.76	1.50 H	37	4.64	26.60

ANTENNA POLARITY & TEST DISTANCE: VERTICAL AT 3 M								
No.	Freq. (MHz)	Emission Level (dBuV/m)	Limit (dBuV/m)	Margin (dB)	Antenna Height (m)	Table Angle (Degree)	Raw Value (dBuV)	Correction Factor (dB/m)
1	39.72	26.92 QP	40.00	-13.08	1.00 V	259	12.51	14.42
2	129.14	23.41 QP	43.50	-20.09	1.00 V	343	11.36	12.04
3	405.17	19.62 QP	46.00	-26.38	2.00 V	178	1.73	17.89
4	519.86	27.25 QP	46.00	-18.75	1.00 V	85	6.88	20.36
5	826.99	32.44 QP	46.00	-13.56	1.00 V	40	5.99	26.45
6	902.81	32.67 QP	46.00	-13.33	2.00 V	67	5.09	27.58

- REMARKS:**
1. Emission level(dBuV/m)=Raw Value(dBuV) + Correction Factor(dB/m)
  2. Correction Factor(dB/m) = Antenna Factor (dB/m) + Cable Factor (dB)
  3. The other emission levels were very low against the limit.
  4. Margin value = Emission level – Limit value.

EUT TEST CONDITION		MEASUREMENT DETAIL	
<b>CHANNEL</b>	Channel 11	<b>FREQUENCY RANGE</b>	Below 1000MHz
<b>MODULATION TYPE</b>	BPSK	<b>DETECTOR FUNCTION</b>	Quasi-Peak
<b>TRANSFER RATE</b>	6Mbps	<b>ENVIRONMENTAL CONDITIONS</b>	25deg. C, 65%RH, 991hPa
<b>INPUT POWER (SYSTEM)</b>	120Vac, 60 Hz	<b>TEST MODE</b>	B
<b>TESTED BY</b>	Brad Wu		

ANTENNA POLARITY & TEST DISTANCE: HORIZONTAL AT 3 M								
No.	Freq. (MHz)	Emission Level (dBuV/m)	Limit (dBuV/m)	Margin (dB)	Antenna Height (m)	Table Angle (Degree)	Raw Value (dBuV)	Correction Factor (dB/m)
1	86.37	17.83 QP	40.00	-22.17	1.00 H	100	8.27	9.57
2	166.07	19.01 QP	43.50	-24.49	2.00 H	280	6.18	12.83
3	323.53	26.57 QP	46.00	-19.43	1.00 H	265	10.82	15.75
4	519.86	22.22 QP	46.00	-23.78	1.00 H	118	1.85	20.36
5	751.18	25.36 QP	46.00	-20.64	1.50 H	205	-0.43	25.79
6	951.40	29.30 QP	46.00	-16.70	1.00 H	259	-0.46	29.76

ANTENNA POLARITY & TEST DISTANCE: VERTICAL AT 3 M								
No.	Freq. (MHz)	Emission Level (dBuV/m)	Limit (dBuV/m)	Margin (dB)	Antenna Height (m)	Table Angle (Degree)	Raw Value (dBuV)	Correction Factor (dB/m)
1	90.26	25.78 QP	43.50	-17.72	1.50 V	328	16.74	9.04
2	300.20	23.14 QP	46.00	-22.86	1.00 V	13	7.71	15.43
3	407.11	21.20 QP	46.00	-24.80	1.00 V	25	3.28	17.93
4	519.86	34.00 QP	46.00	-12.00	1.50 V	136	13.64	20.36
5	758.96	24.70 QP	46.00	-21.30	1.00 V	286	-1.15	25.84
6	945.57	27.71 QP	46.00	-18.29	1.00 V	178	-1.87	29.58

- REMARKS:**
1. Emission level(dBuV/m)=Raw Value(dBuV) + Correction Factor(dB/m)
  2. Correction Factor(dB/m) = Antenna Factor (dB/m) + Cable Factor (dB)
  3. The other emission levels were very low against the limit.
  4. Margin value = Emission level – Limit value.

**802.11b DSSS modulation**

EUT TEST CONDITION		MEASUREMENT DETAIL	
CHANNEL	Channel 1	FREQUENCY RANGE	1 ~ 25GHz
MODULATION TYPE	DBPSK	DETECTOR FUNCTION	Peak(PK) Average (AV)
TRANSFER RATE	1Mbps	ENVIRONMENTAL CONDITIONS	25deg. C, 65%RH, 991hPa
INPUT POWER (SYSTEM)	120Vac, 60 Hz	TESTED BY	Brad Wu

ANTENNA POLARITY & TEST DISTANCE: HORIZONTAL AT 3 M								
No.	Freq. (MHz)	Emission Level (dBuV/m)	Limit (dBuV/m)	Margin (dB)	Antenna Height (m)	Table Angle (Degree)	Raw Value (dBuV)	Correction Factor (dB/m)
1	2390.00	57.46 PK	74.00	-16.54	1.39 H	168	25.36	32.10
1	2390.00	48.20 AV	54.00	-5.80	1.39 H	168	16.10	32.10
2	*2412.00	102.45 PK			1.39 H	168	70.27	32.18
2	*2412.00	98.79 AV			1.39 H	168	66.61	32.18
3	4824.00	49.59 PK	74.00	-24.41	1.00 H	18	10.96	38.63
3	4824.00	37.41 AV	54.00	-16.59	1.00 H	18	-1.22	38.63

ANTENNA POLARITY & TEST DISTANCE: VERTICAL AT 3 M								
No.	Freq. (MHz)	Emission Level (dBuV/m)	Limit (dBuV/m)	Margin (dB)	Antenna Height (m)	Table Angle (Degree)	Raw Value (dBuV)	Correction Factor (dB/m)
1	2390.00	48.25 PK	74.00	-25.75	1.00 V	211	16.15	32.10
1	2390.00	44.86 AV	54.00	-9.14	1.00 V	211	12.76	32.10
2	*2412.00	98.84 PK			1.00 V	211	66.66	32.18
2	*2412.00	95.45 AV			1.00 V	211	63.27	32.18
3	4824.00	49.29 PK	74.00	-24.71	1.00 V	76	10.66	38.63
3	4824.00	39.08 AV	54.00	-14.92	1.00 V	76	0.45	38.63

- REMARKS:**
1. Emission level(dBuV/m)=Raw Value(dBuV) + Correction Factor(dB/m)
  2. Correction Factor(dB/m) = Antenna Factor (dB/m) + Cable Factor (dB)
  3. The other emission levels were very low against the limit.
  4. Margin value = Emission level – Limit value.
  5. “ \* ” : Fundamental frequency.

EUT TEST CONDITION		MEASUREMENT DETAIL	
CHANNEL	Channel 6	FREQUENCY RANGE	1 ~ 25GHz
MODULATION TYPE	DBPSK	DETECTOR FUNCTION	Peak(PK) Average (AV)
TRANSFER RATE	1Mbps	ENVIRONMENTAL CONDITIONS	25deg. C, 65%RH, 991hPa
INPUT POWER (SYSTEM)	120Vac, 60 Hz	TESTED BY	Brad Wu

ANTENNA POLARITY & TEST DISTANCE: HORIZONTAL AT 3 M								
No.	Freq. (MHz)	Emission Level (dBuV/m)	Limit (dBuV/m)	Margin (dB)	Antenna Height (m)	Table Angle (Degree)	Raw Value (dBuV)	Correction Factor (dB/m)
1	*2437.00	105.69 PK			1.41 H	230	73.42	32.27
1	*2437.00	102.21 AV			1.41 H	230	69.94	32.27
2	4874.00	51.60 PK	74.00	-22.40	1.58 H	6	12.83	38.77
2	4874.00	40.08 AV	54.00	-13.92	1.58 H	6	1.31	38.77

ANTENNA POLARITY & TEST DISTANCE: VERTICAL AT 3 M								
No.	Freq. (MHz)	Emission Level (dBuV/m)	Limit (dBuV/m)	Margin (dB)	Antenna Height (m)	Table Angle (Degree)	Raw Value (dBuV)	Correction Factor (dB/m)
1	*2437.00	102.26 PK			1.04 V	320	69.99	32.27
1	*2437.00	99.07 AV			1.04 V	320	66.80	32.27
2	4874.00	54.86 PK	74.00	-19.14	1.00 V	248	16.09	38.77
2	4874.00	42.95 AV	54.00	-11.05	1.00 V	248	4.18	38.77

- REMARKS:**
1. Emission level(dBuV/m)=Raw Value(dBuV) + Correction Factor(dB/m)
  2. Correction Factor(dB/m) = Antenna Factor (dB/m) + Cable Factor (dB)
  3. The other emission levels were very low against the limit.
  4. Margin value = Emission level – Limit value.
  5. " \* " : Fundamental frequency.



EUT TEST CONDITION		MEASUREMENT DETAIL	
CHANNEL	Channel 11	FREQUENCY RANGE	1 ~ 25GHz
MODULATION TYPE	DBPSK	DETECTOR FUNCTION	Peak(PK) Average (AV)
TRANSFER RATE	1Mbps	ENVIRONMENTAL CONDITIONS	25deg. C, 65%RH, 991hPa
INPUT POWER (SYSTEM)	120Vac, 60 Hz	TESTED BY	Brad Wu

ANTENNA POLARITY & TEST DISTANCE: HORIZONTAL AT 3 M								
No.	Freq. (MHz)	Emission Level (dBuV/m)	Limit (dBuV/m)	Margin (dB)	Antenna Height (m)	Table Angle (Degree)	Raw Value (dBuV)	Correction Factor (dB/m)
1	*2462.00	102.72 PK			1.36 H	155	70.36	32.36
1	*2462.00	99.12 AV			1.36 H	155	66.76	32.36
2	2483.50	57.68 PK	74.00	-16.32	1.36 H	155	25.24	32.44
2	2483.50	48.25 AV	54.00	-5.75	1.36 H	155	15.81	32.44
3	4924.00	49.32 PK	74.00	-24.68	1.00 H	13	10.42	38.90
3	4924.00	38.99 AV	54.00	-15.01	1.00 H	13	0.09	38.90

ANTENNA POLARITY & TEST DISTANCE: VERTICAL AT 3 M								
No.	Freq. (MHz)	Emission Level (dBuV/m)	Limit (dBuV/m)	Margin (dB)	Antenna Height (m)	Table Angle (Degree)	Raw Value (dBuV)	Correction Factor (dB/m)
1	*2462.00	99.26 PK			1.01 V	214	66.90	32.36
1	*2462.00	95.87 AV			1.01 V	214	63.51	32.36
2	2483.50	48.57 PK	74.00	-25.43	1.01 V	214	16.13	32.44
2	2483.50	45.19 AV	54.00	-8.81	1.01 V	214	12.75	32.44
3	4924.00	51.45 PK	74.00	-22.55	1.00 V	74	12.55	38.90
3	4924.00	45.01 AV	54.00	-8.99	1.00 V	74	6.11	38.90

- REMARKS:**
1. Emission level(dBuV/m)=Raw Value(dBuV) + Correction Factor(dB/m)
  2. Correction Factor(dB/m) = Antenna Factor (dB/m) + Cable Factor (dB)
  3. The other emission levels were very low against the limit.
  4. Margin value = Emission level – Limit value.
  5. “ \* “ : Fundamental frequency.

**802.11g OFDM modulation**

EUT TEST CONDITION		MEASUREMENT DETAIL	
CHANNEL	Channel 1	FREQUENCY RANGE	1 ~ 25GHz
MODULATION TYPE	BPSK	DETECTOR FUNCTION	Peak(PK) Average (AV)
TRANSFER RATE	6Mbps	ENVIRONMENTAL CONDITIONS	25deg. C, 65%RH, 991hPa
INPUT POWER (SYSTEM)	120Vac, 60 Hz	TESTED BY	Brad Wu

ANTENNA POLARITY & TEST DISTANCE: HORIZONTAL AT 3 M								
No.	Freq. (MHz)	Emission Level (dBuV/m)	Limit (dBuV/m)	Margin (dB)	Antenna Height (m)	Table Angle (Degree)	Raw Value (dBuV)	Correction Factor (dB/m)
1	2390.00	58.35 PK	74.00	-15.65	1.39 H	166	26.25	32.10
1	2390.00	47.54 AV	54.00	-6.46	1.39 H	166	15.44	32.10
2	*2412.00	104.13 PK			1.39 H	166	71.95	32.18
2	*2412.00	94.79 AV			1.39 H	166	62.61	32.18
3	4824.00	49.97 PK	74.00	-24.03	1.05 H	223	11.34	38.63
3	4824.00	37.28 AV	54.00	-16.72	1.05 H	223	-1.35	38.63

ANTENNA POLARITY & TEST DISTANCE: VERTICAL AT 3 M								
No.	Freq. (MHz)	Emission Level (dBuV/m)	Limit (dBuV/m)	Margin (dB)	Antenna Height (m)	Table Angle (Degree)	Raw Value (dBuV)	Correction Factor (dB/m)
1	2390.00	55.48 PK	74.00	-18.52	1.02 V	219	23.38	32.10
1	2390.00	46.24 AV	54.00	-7.76	1.02 V	219	14.14	32.10
2	*2412.00	102.03 PK			1.02 V	219	69.85	32.18
2	*2412.00	92.84 AV			1.02 V	219	60.66	32.18
3	4824.00	51.14 PK	74.00	-22.86	1.01 V	264	12.51	38.63
3	4824.00	38.39 AV	54.00	-15.61	1.01 V	264	-0.24	38.63

- REMARKS:**
1. Emission level(dBuV/m)=Raw Value(dBuV) + Correction Factor(dB/m)
  2. Correction Factor(dB/m) = Antenna Factor (dB/m) + Cable Factor (dB)
  3. The other emission levels were very low against the limit.
  4. Margin value = Emission level – Limit value.
  5. “ \* “ : Fundamental frequency.

EUT TEST CONDITION		MEASUREMENT DETAIL	
CHANNEL	Channel 6	FREQUENCY RANGE	1 ~ 25GHz
MODULATION TYPE	BPSK	DETECTOR FUNCTION	Peak(PK) Average (AV)
TRANSFER RATE	6Mbps	ENVIRONMENTAL CONDITIONS	25deg. C, 65%RH, 991hPa
INPUT POWER (SYSTEM)	120Vac, 60 Hz	TESTED BY	Brad Wu

ANTENNA POLARITY & TEST DISTANCE: HORIZONTAL AT 3 M								
No.	Freq. (MHz)	Emission Level (dBuV/m)	Limit (dBuV/m)	Margin (dB)	Antenna Height (m)	Table Angle (Degree)	Raw Value (dBuV)	Correction Factor (dB/m)
1	*2437.00	106.24 PK			1.25 H	115	73.97	32.27
1	*2437.00	96.79 AV			1.25 H	115	64.52	32.27
2	4874.00	51.69 PK	74.00	-22.31	1.59 H	64	12.92	38.77
2	4874.00	41.30 AV	54.00	-12.70	1.59 H	64	2.53	38.77

ANTENNA POLARITY & TEST DISTANCE: VERTICAL AT 3 M								
No.	Freq. (MHz)	Emission Level (dBuV/m)	Limit (dBuV/m)	Margin (dB)	Antenna Height (m)	Table Angle (Degree)	Raw Value (dBuV)	Correction Factor (dB/m)
1	*2437.00	104.12 PK			1.20 V	86	71.85	32.27
1	*2437.00	93.16 AV			1.20 V	86	60.89	32.27
2	4874.00	53.28 PK	74.00	-20.72	1.00 V	187	14.51	38.77
2	4874.00	43.99 AV	54.00	-10.01	1.00 V	187	5.22	38.77

- REMARKS:**
1. Emission level(dBuV/m)=Raw Value(dBuV) + Correction Factor(dB/m)
  2. Correction Factor(dB/m) = Antenna Factor (dB/m) + Cable Factor (dB)
  3. The other emission levels were very low against the limit.
  4. Margin value = Emission level – Limit value.
  5. " \* " : Fundamental frequency.

EUT TEST CONDITION		MEASUREMENT DETAIL	
<b>CHANNEL</b>	Channel 11	<b>FREQUENCY RANGE</b>	1 ~ 25GHz
<b>MODULATION TYPE</b>	BPSK	<b>DETECTOR FUNCTION</b>	Peak(PK) Average (AV)
<b>TRANSFER RATE</b>	6Mbps	<b>ENVIRONMENTAL CONDITIONS</b>	25deg. C, 65%RH, 991hPa
<b>INPUT POWER (SYSTEM)</b>	120Vac, 60 Hz	<b>TESTED BY</b>	Brad Wu

ANTENNA POLARITY & TEST DISTANCE: HORIZONTAL AT 3 M								
No.	Freq. (MHz)	Emission Level (dBuV/m)	Limit (dBuV/m)	Margin (dB)	Antenna Height (m)	Table Angle (Degree)	Raw Value (dBuV)	Correction Factor (dB/m)
1	*2462.00	105.10 PK			1.35 H	150	72.74	32.36
1	*2462.00	95.92 AV			1.35 H	150	63.56	32.36
2	2483.50	59.85 PK	74.00	-14.15	1.35 H	150	27.41	32.44
2	2483.50	49.32 AV	54.00	-4.68	1.35 H	150	16.88	32.44
3	4924.00	49.56 PK	74.00	-24.44	1.04 H	216	10.66	38.90
3	4924.00	36.87 AV	54.00	-17.13	1.04 H	216	-2.03	38.90

ANTENNA POLARITY & TEST DISTANCE: VERTICAL AT 3 M								
No.	Freq. (MHz)	Emission Level (dBuV/m)	Limit (dBuV/m)	Margin (dB)	Antenna Height (m)	Table Angle (Degree)	Raw Value (dBuV)	Correction Factor (dB/m)
1	*2462.00	102.99 PK			1.00 V	215	70.63	32.36
1	*2462.00	93.71 AV			1.00 V	215	61.35	32.36
2	2483.50	56.39 PK	74.00	-17.61	1.00 V	215	23.95	32.44
2	2483.50	47.11 AV	54.00	-6.89	1.00 V	215	14.67	32.44
3	4924.00	50.97 PK	74.00	-23.03	1.04 V	226	12.07	38.90
3	4924.00	38.24 AV	54.00	-15.76	1.04 V	226	-0.66	38.90

- REMARKS:**
1. Emission level(dBuV/m)=Raw Value(dBuV) + Correction Factor(dB/m)
  2. Correction Factor(dB/m) = Antenna Factor (dB/m) + Cable Factor (dB)
  3. The other emission levels were very low against the limit.
  4. Margin value = Emission level – Limit value.
  5. “ \* “ : Fundamental frequency.





### 4.3 6dB BANDWIDTH MEASUREMENT

#### 4.3.1 LIMITS OF 6dB BANDWIDTH MEASUREMENT

The minimum of 6dB Bandwidth Measurement is 0.5 MHz.

#### 4.3.2 TEST INSTRUMENTS

Description & Manufacturer	Model No.	Serial No.	Calibrated Until
SPECTRUM ANALYZER	FSP40	100040	Jun. 07, 2007

**NOTE:** The calibration interval of the above test instruments is 12 months and the calibrations are traceable to NML/ROC and NIST/USA.

### 4.3.3 TEST PROCEDURE

The transmitter output was connected to the spectrum analyzer through an attenuator. The bandwidth of the fundamental frequency was measured by spectrum analyzer with 100kHz RBW and 100kHz VBW. The 6dB bandwidth is defined as the total spectrum the power of which is higher than peak power minus 6dB.

### 4.3.4 DEVIATION FROM TEST STANDARD

No deviation

### 4.3.5 TEST SETUP

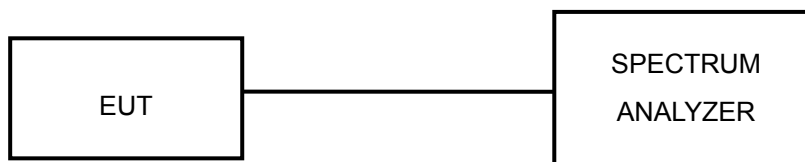

### 4.3.6 EUT OPERATING CONDITIONS

The software provided by client to enable the EUT under transmission condition continuously at lowest, middle and highest channel frequencies individually.



### 4.3.7 TEST RESULTS

#### 802.11b DSSS modulation

<b>MODULATION TYPE</b>	DBPSK	<b>TRANSFER RATE</b>	1Mbps
<b>INPUT POWER (SYSTEM)</b>	120Vac, 60 Hz	<b>ENVIRONMENTAL CONDITIONS</b>	25deg.C, 68%RH, 991hPa
<b>TESTED BY</b>	Brad Wu		

<b>CHANNEL</b>	<b>CHANNEL FREQUENCY (MHz)</b>	<b>6dB BANDWIDTH (MHz)</b>	<b>MINIMUM LIMIT (MHz)</b>	<b>PASS/FAIL</b>
1	2412	13.02	0.5	PASS
6	2437	13.14	0.5	PASS
11	2462	13.14	0.5	PASS

CH 1

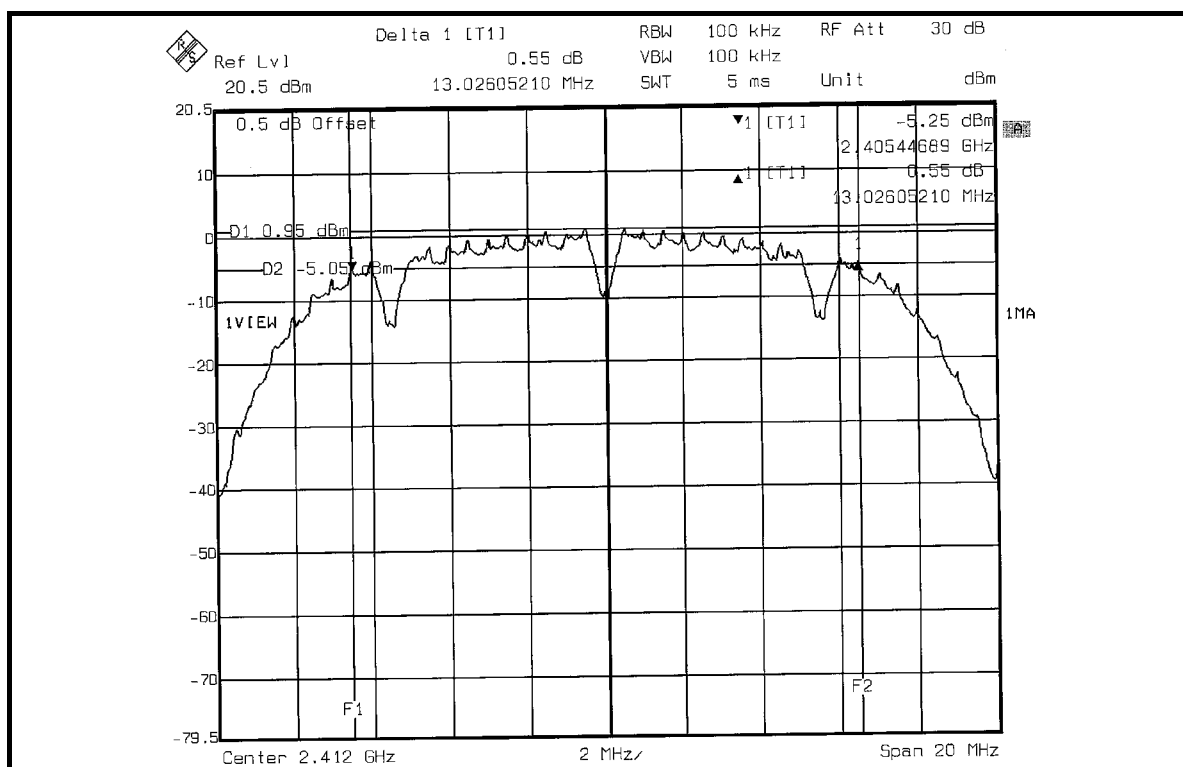

CH 6

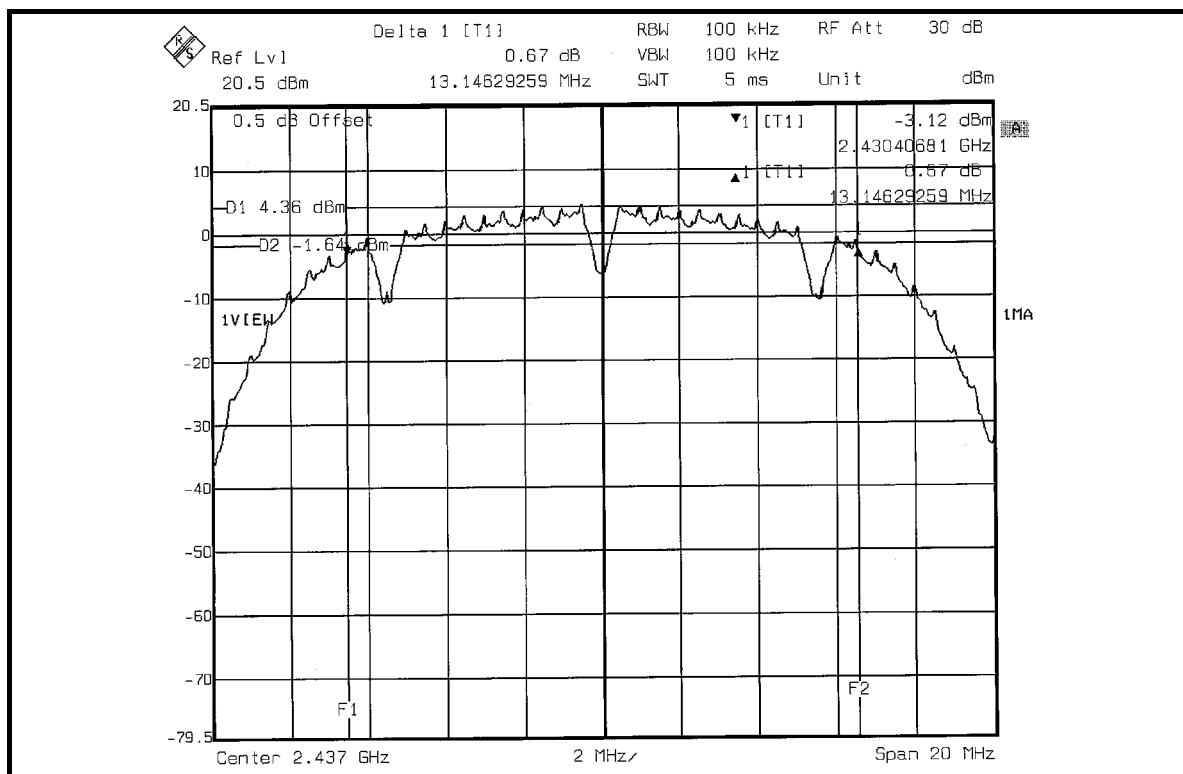

CH 11

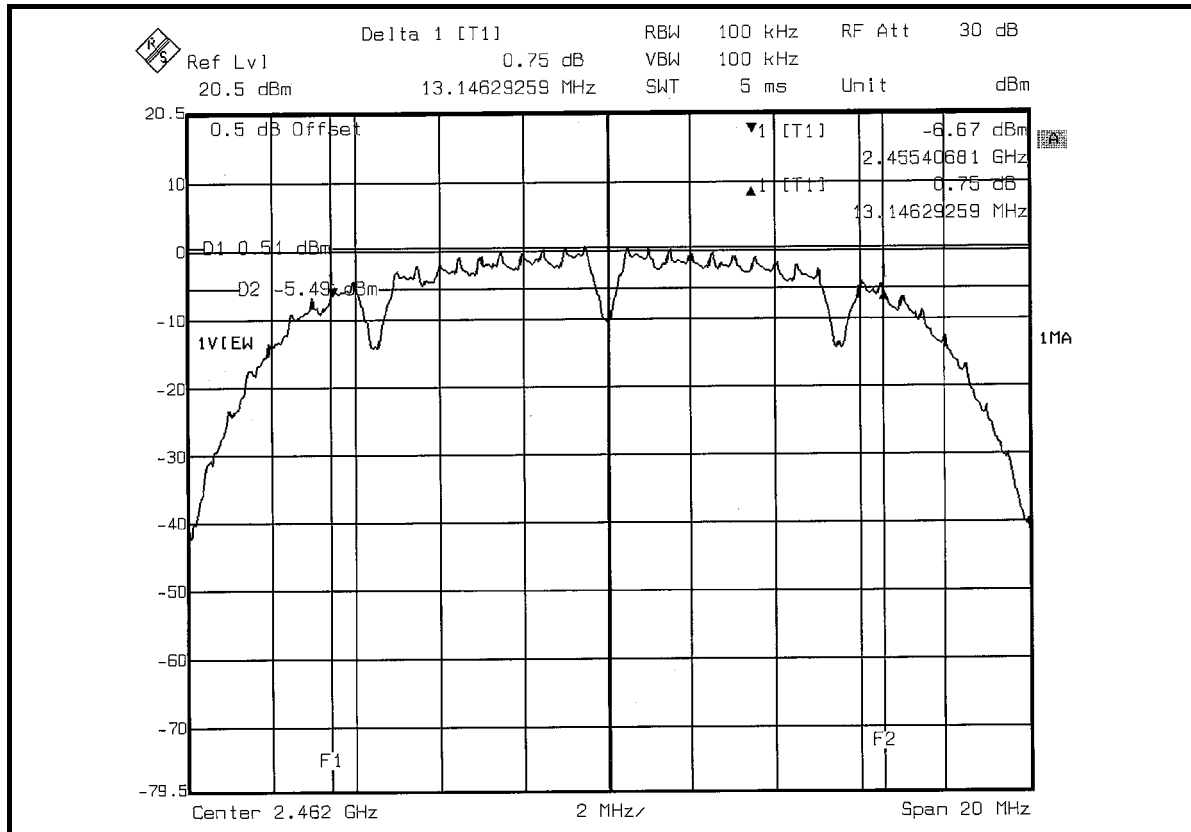



**802.11g OFDM modulation**

<b>MODULATION TYPE</b>	BPSK	<b>TRANSFER RATE</b>	6Mbps
<b>INPUT POWER (SYSTEM)</b>	120Vac, 60 Hz	<b>ENVIRONMENTAL CONDITIONS</b>	25deg.C, 68%RH, 991hPa
<b>TESTED BY</b>	Brad Wu		

<b>CHANNEL</b>	<b>CHANNEL FREQUENCY (MHz)</b>	<b>6dB BANDWIDTH (MHz)</b>	<b>MINIMUM LIMIT (MHz)</b>	<b>PASS/FAIL</b>
1	2412	15.83	0.5	PASS
6	2437	15.87	0.5	PASS
11	2462	15.87	0.5	PASS

### CH 1

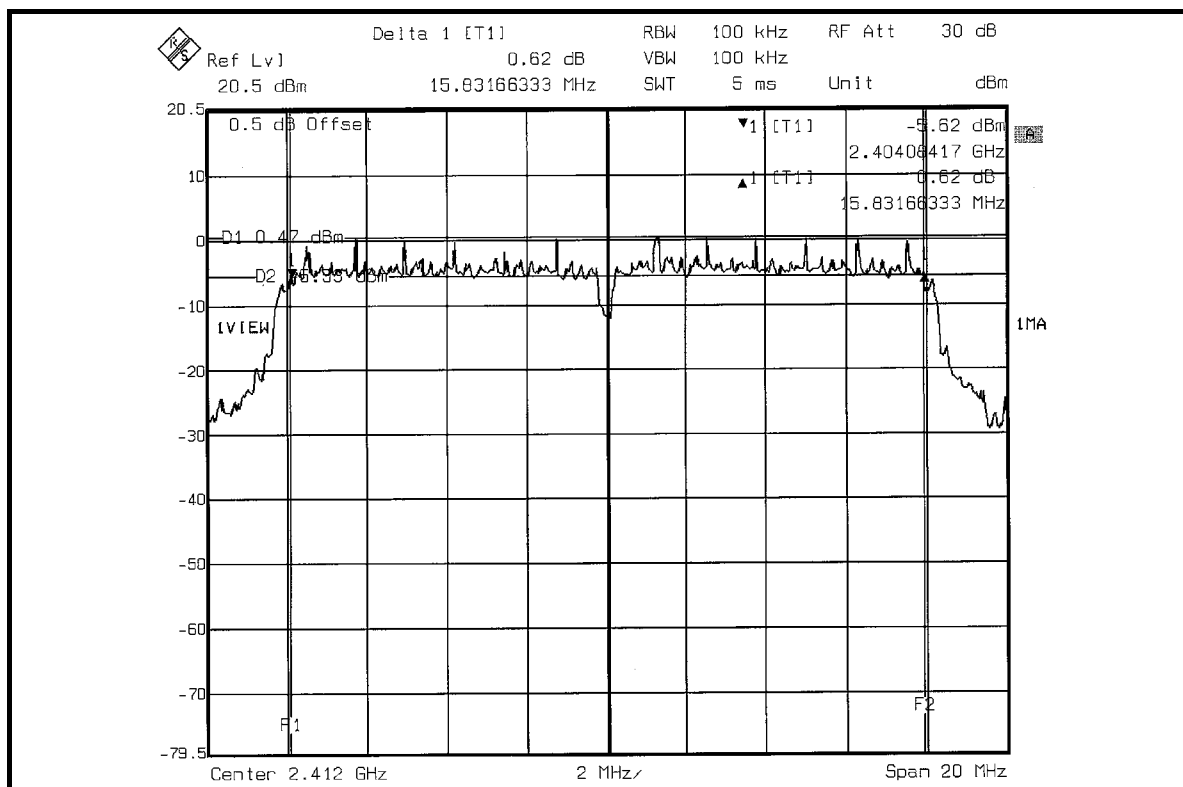

### CH 6

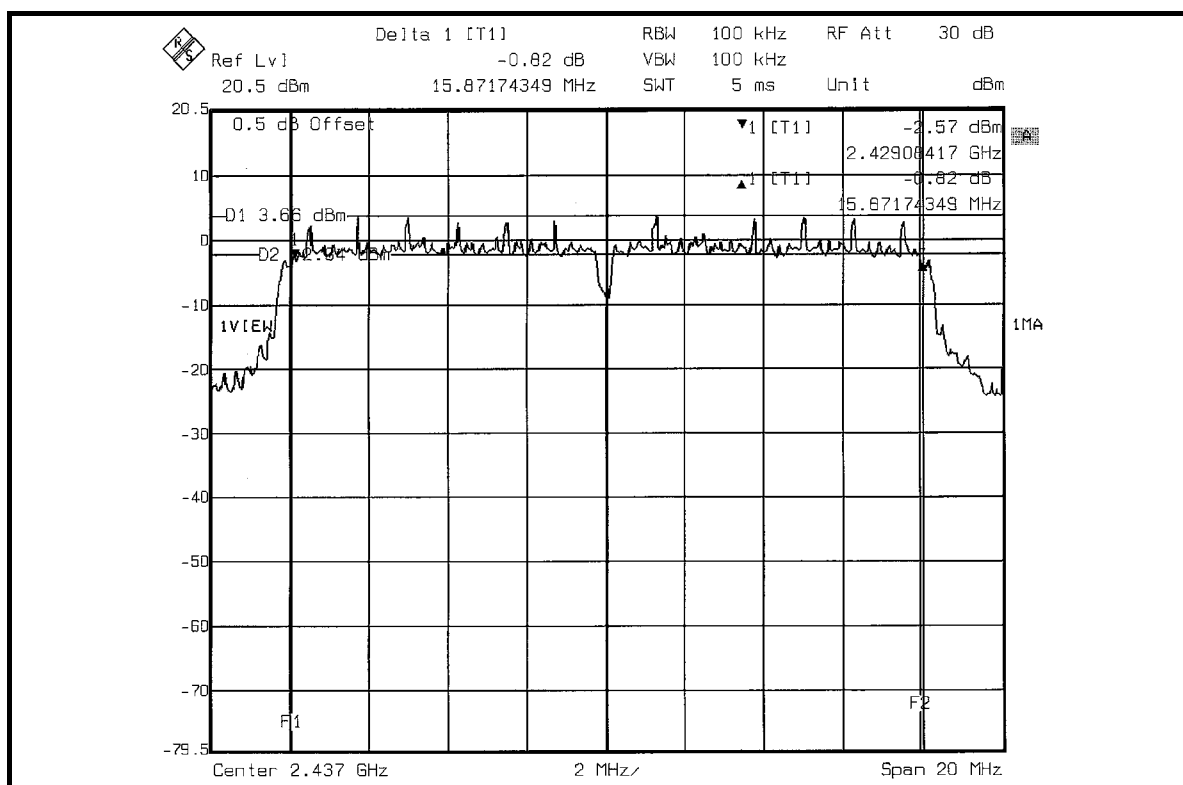

CH 11

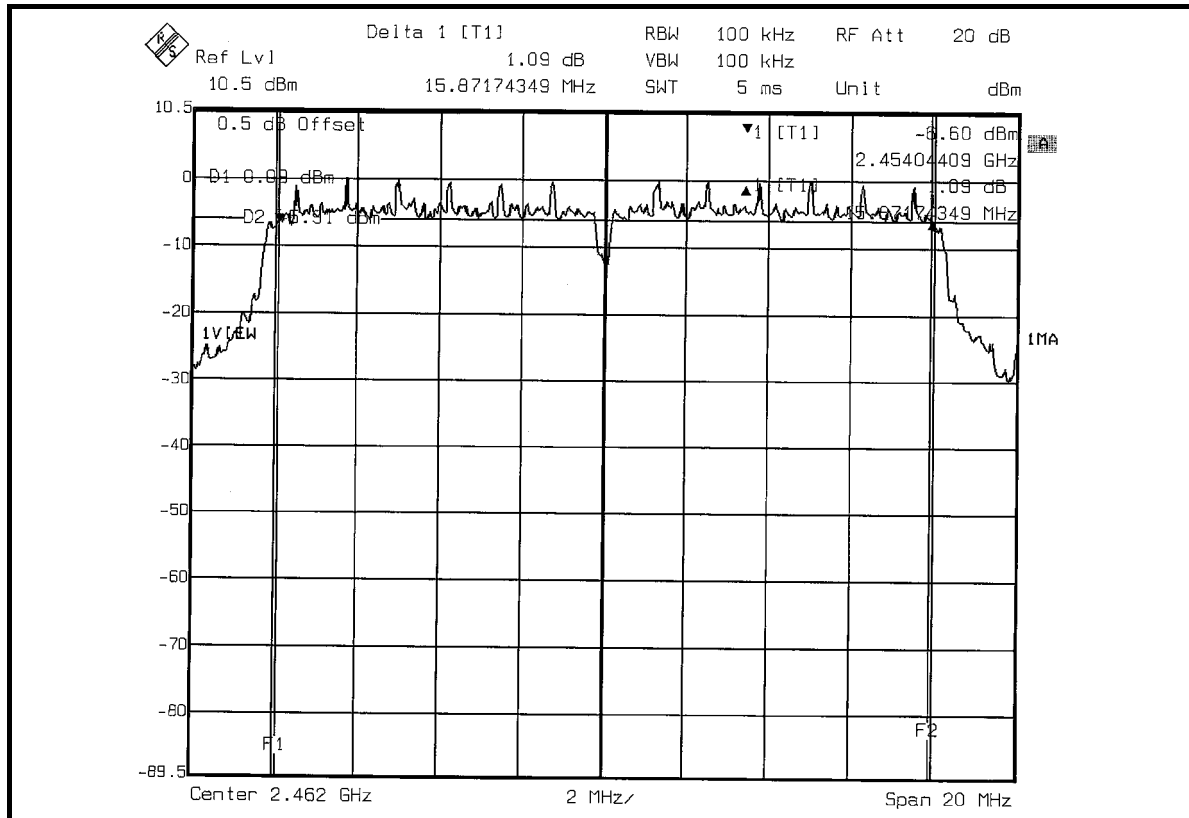





#### 4.4 MAXIMUM PEAK OUTPUT POWER

##### 4.4.1 LIMITS OF MAXIMUM PEAK OUTPUT POWER MEASUREMENT

The Maximum Peak Output Power Measurement is 30dBm.

##### 4.4.2 INSTRUMENTS

Description & Manufacturer	Model No.	Serial No.	Calibrated Until
R&S SPECTRUM ANALYZER	FSP40	100040	Jun. 07, 2007
AGILENT SIGNAL GENERATOR	E8257C	MY43320668	Dec. 30, 2006
TEKTRONIX OSCILLOSCOPE	TDS 1012	C019167	Jan. 16, 2007
NARDA DETECTOR	4503A	FSCM99899	NA

**NOTE:**

The calibration interval of the above test instruments is 12 months and the calibrations are traceable to NML/ROC and NIST/USA.

#### 4.4.1 TEST PROCEDURES

1. A detector was used on the output port of the EUT. An oscilloscope was used to read the response of the detector.
2. Replaced the EUT by the signal generator. The center frequency of the S.G was adjusted to the center frequency of the measured channel.
3. Adjusted the power to have the same reading on oscilloscope. Record the power level.

#### 4.4.2 DEVIATION FROM TEST STANDARD

No deviation

#### 4.4.3 TEST SETUP



#### 4.4.4 EUT OPERATING CONDITIONS

Same as Item 4.3.6



### 4.4.3 TEST RESULTS

#### 802.11b DSSS modulation

<b>MODULATION TYPE</b>	DBPSK	<b>TRANSFER RATE</b>	1Mbps
<b>INPUT POWER (SYSTEM)</b>	120Vac, 60 Hz	<b>ENVIRONMENTAL CONDITIONS</b>	25deg.C, 68%RH, 991hPa
<b>TESTED BY</b>	Brad Wu		

CHANNEL	CHANNEL FREQUENCY (MHz)	PEAK POWER OUTPUT (mW)	PEAK POWER OUTPUT (dBm)	PEAK POWER LIMIT (dBm)	PASS/FAIL
1	2412	28.314	14.52	30	PASS
6	2437	63.241	18.01	30	PASS
11	2462	28.510	14.55	30	PASS

#### 802.11g OFDM modulation

<b>MODULATION TYPE</b>	BPSK	<b>TRANSFER RATE</b>	6Mbps
<b>INPUT POWER (SYSTEM)</b>	120Vac, 60 Hz	<b>ENVIRONMENTAL CONDITIONS</b>	25deg.C, 68%RH, 991hPa
<b>TESTED BY</b>	Brad Wu		

CHANNEL	CHANNEL FREQUENCY (MHz)	PEAK POWER OUTPUT (mW)	PEAK POWER OUTPUT (dBm)	PEAK POWER LIMIT (dBm)	PASS/FAIL
1	2412	36.058	15.57	30	PASS
6	2437	56.494	17.52	30	PASS
11	2462	35.810	15.54	30	PASS



## 4.5 POWER SPECTRAL DENSITY MEASUREMENT

### 4.5.1 LIMITS OF POWER SPECTRAL DENSITY MEASUREMENT

The Maximum of Power Spectral Density Measurement is 8dBm.

### 4.5.2 TEST INSTRUMENTS

Description & Manufacturer	Model No.	Serial No.	Calibrated Until
R&S SPECTRUM ANALYZER	FSP40	100040	Jun. 07, 2007

**NOTE:**

The calibration interval of the above test instruments is 12 months and the calibrations are traceable to NML/ROC and NIST/USA.

#### 4.5.3 TEST PROCEDURE

The transmitter output was connected to the spectrum analyzer through an attenuator, the bandwidth of the fundamental frequency was measured with the spectrum analyzer using 3kHz RBW and 30kHz VBW, set sweep time = span/3kHz. The power spectral density was measured and recorded. The sweep time is allowed to be longer than span/3kHz for a full response of the mixer in the spectrum analyzer.

#### 4.5.4 DEVIATION FROM TEST STANDARD

No deviation

#### 4.5.5 TEST SETUP

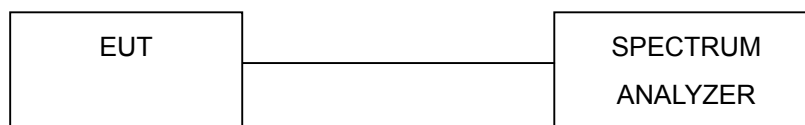

#### 4.5.6 EUT OPERATING CONDITION

Same as Item 4.3.6



#### 4.5.7 TEST RESULTS

##### 802.11b DSSS modulation

<b>MODULATION TYPE</b>	DBPSK	<b>TRANSFER RATE</b>	1Mbps
<b>INPUT POWER (SYSTEM)</b>	120Vac, 60 Hz	<b>ENVIRONMENTAL CONDITIONS</b>	25deg.C, 68%RH, 991hPa
<b>TESTED BY</b>	Brad Wu		

<b>CHANNEL</b>	<b>CHANNEL FREQUENCY (MHz )</b>	<b>RF POWER LEVEL IN 3kHz BW (dBm)</b>	<b>MAXIMUM LIMIT (dBm)</b>	<b>PASS/FAIL</b>
1	2412	-14.65	8	PASS
6	2437	-10.96	8	PASS
11	2462	-14.66	8	PASS

CH 1

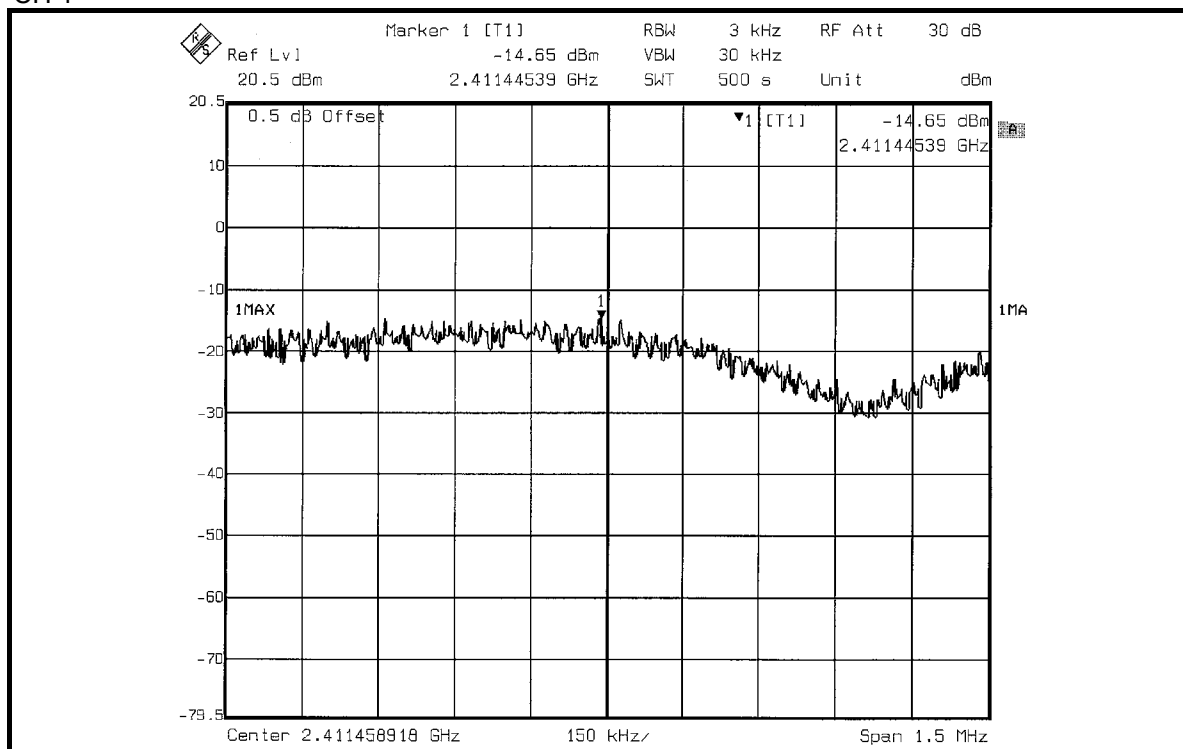

CH 6

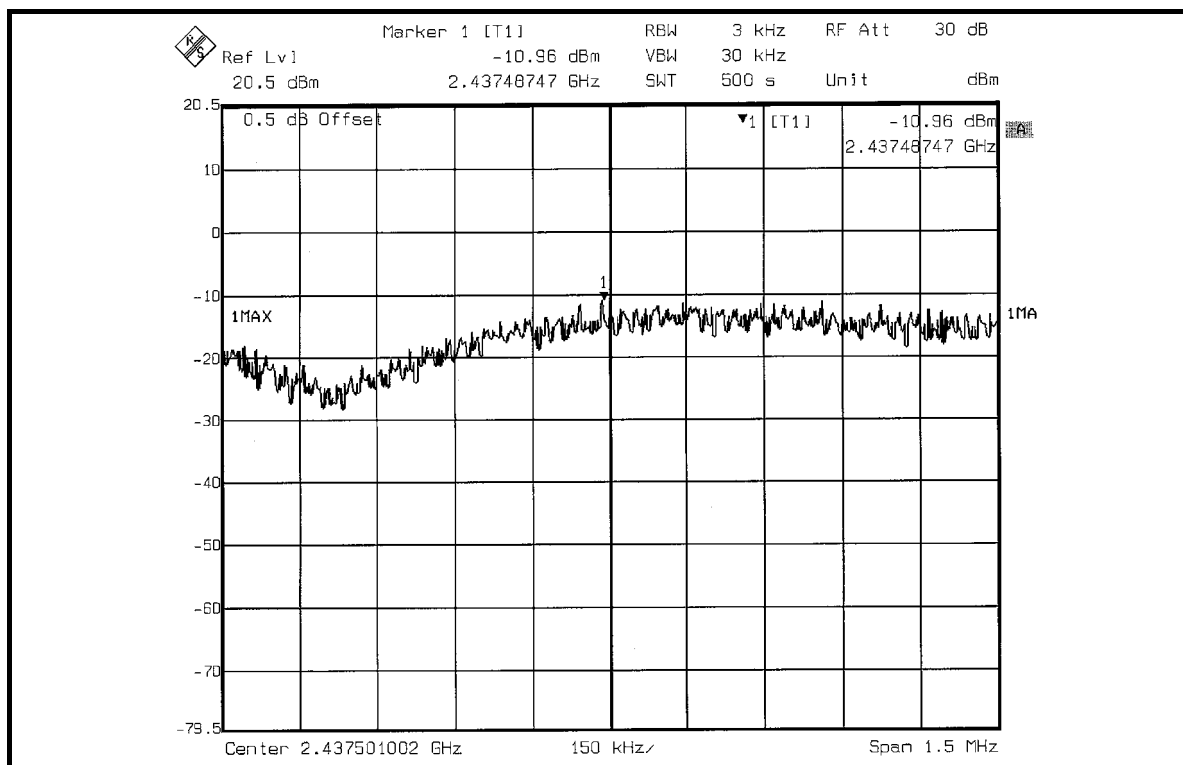

CH 11

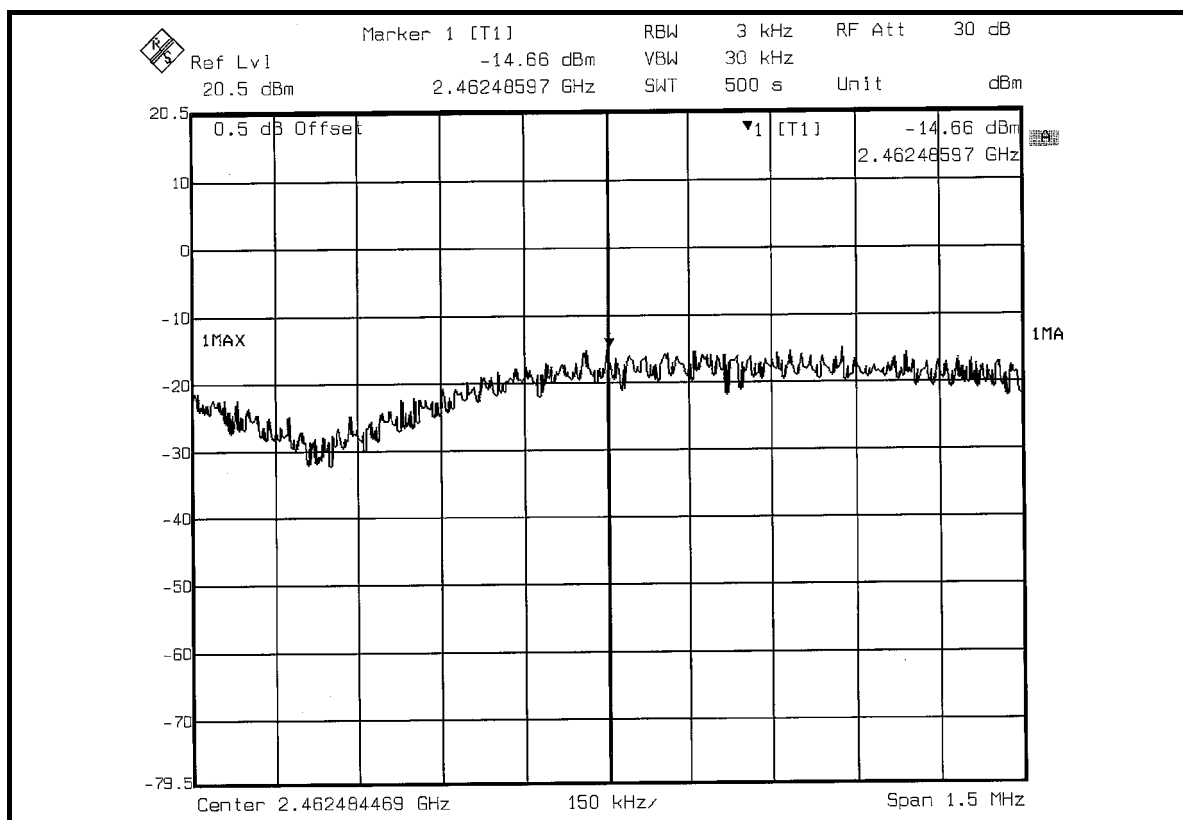





### 802.11g OFDM modulation

<b>MODULATION TYPE</b>	BPSK	<b>TRANSFER RATE</b>	6Mbps
<b>INPUT POWER (SYSTEM)</b>	120Vac, 60 Hz	<b>ENVIRONMENTAL CONDITIONS</b>	25deg.C, 68%RH, 991hPa
<b>TESTED BY</b>	Brad Wu		

<b>CHANNEL</b>	<b>CHANNEL FREQUENCY (MHz )</b>	<b>RF POWER LEVEL IN 3kHz BW (dBm)</b>	<b>MAXIMUM LIMIT (dBm)</b>	<b>PASS/FAIL</b>
1	2412	-14.56	8	PASS
6	2437	-11.74	8	PASS
11	2462	-14.67	8	PASS

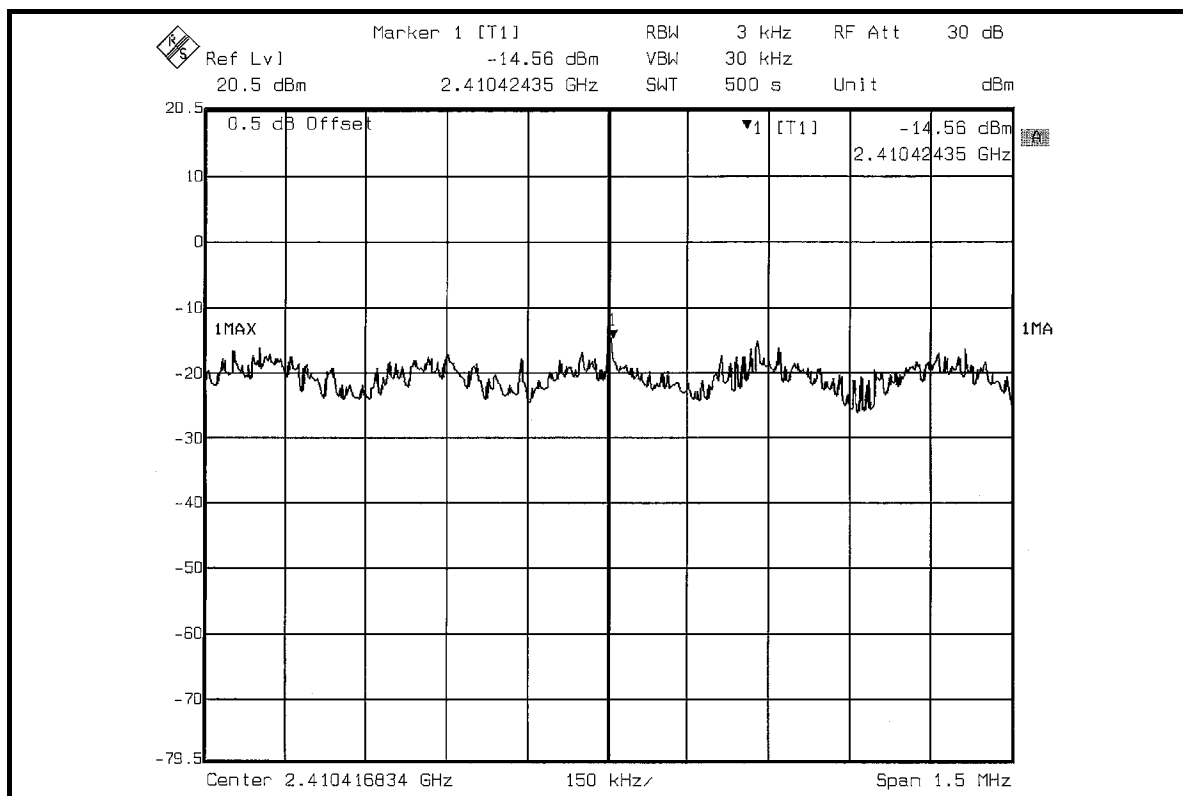
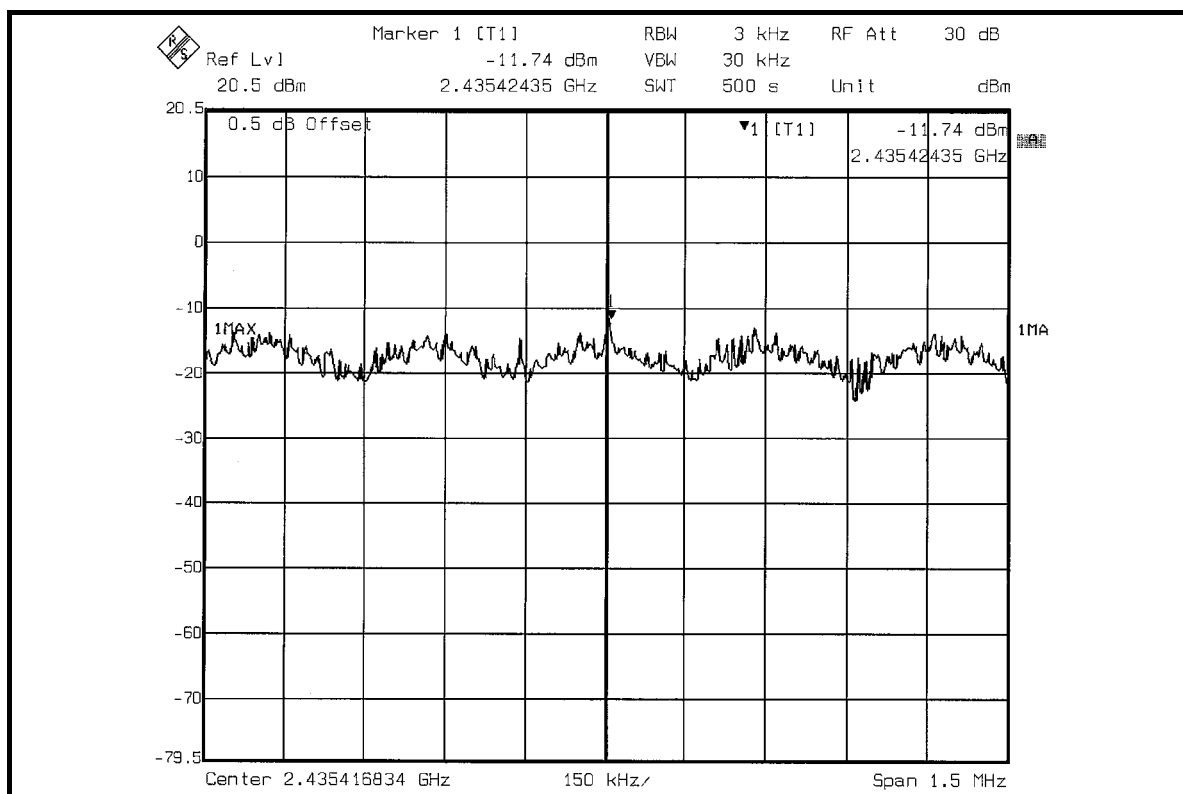
**CH 1**

**CH 6**

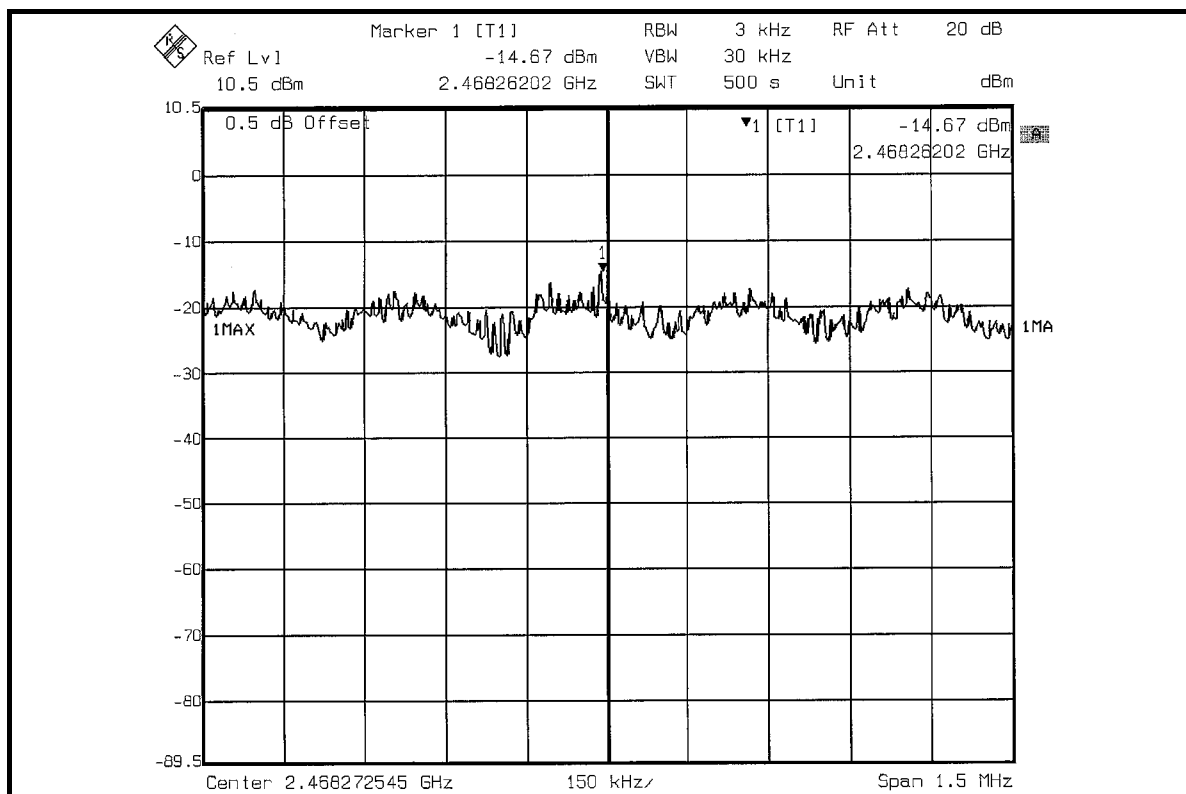
CH 11





## 4.6 BAND EDGES MEASUREMENT

### 4.6.1 LIMITS OF BAND EDGES MEASUREMENT

Below  $-20\text{dB}$  of the highest emission level of operating band (in 100kHz Resolution Bandwidth).

### 4.6.2 TEST INSTRUMENTS

Description & Manufacturer	Model No.	Serial No.	Calibrated Until
R&S SPECTRUM ANALYZER	FSP40	100040	Jun. 07, 2007

**NOTE:** The calibration interval of the above test instruments is 12 months and the calibrations are traceable to NML/ROC and NIST/USA.

### 4.6.3 TEST PROCEDURE

The transmitter output was connected to the spectrum analyzer via a low loss cable. Set both RBW and VBW of spectrum analyzer to 100kHz with suitable frequency span including 100 MHz bandwidth from band edge. The band edges was measured and recorded.

The spectrum plots (Peak RBW=VBW=100kHz; Average RBW=1MHz, VBW= 10Hz are attached on the following pages.

### 4.6.4 DEVIATION FROM TEST STANDARD

No deviation

### 4.6.5 EUT OPERATING CONDITION

Same as Item 4.3.6



#### 4.6.6 TEST RESULTS

The spectrum plots are attached on the following 12 images. D1 line indicates the highest level, and D2 line indicates the 20dB offset below D1. It shows compliance with the requirement in part 15.247(d).

#### 802.11b DSSS modulation

**NOTE 1:** The band edge emission plot on the next page shows 52.31dBc between carrier maximum power and local maximum emission in restrict band (2.38699GHz). The emission of carrier strength list in the test result of channel 1 at the item 4.2.7 is 102.45dBuV/m (Peak), so the maximum field strength in restrict band is  $102.45 - 52.31 = 50.14$ dBuV/m which is under 74dBuV/m limit.

The band edge emission plot of on the next page shows 56.88dBc between carrier maximum power and local maximum emission in restrict band (2.39699GHz). The emission of carrier strength list in the test result of channel 1 at the item 4.2.7 is 98.79dBuV/m (Average), so the maximum field strength in restrict band is  $98.79 - 56.88 = 41.91$ dBuV/m which is under 54dBuV/m limit.

**NOTE 2:** The band edge emission plot on the next second page shows 52.16dBc between carrier maximum power and local maximum emission in restrict band (2.49536GHz). The emission of carrier strength list in the test result of channel 11 at the item 4.2.7 is 102.72dBuV/m (Peak), so the maximum field strength in restrict band is  $102.72 - 52.16 = 50.56$ dBuV/m which is under 74dBuV/m limit.

The band edge emission plot on the next third page shows 55.98dBc between carrier maximum power and local maximum emission in restrict band (2.49893GHz). The emission of carrier strength list in the test result of channel 11 at the item 4.2.7 is 99.12dBuV/m (Average), so the maximum field strength in restrict band is  $99.12 - 55.98 = 43.14$ dBuV/m which is under 54dBuV/m limit.

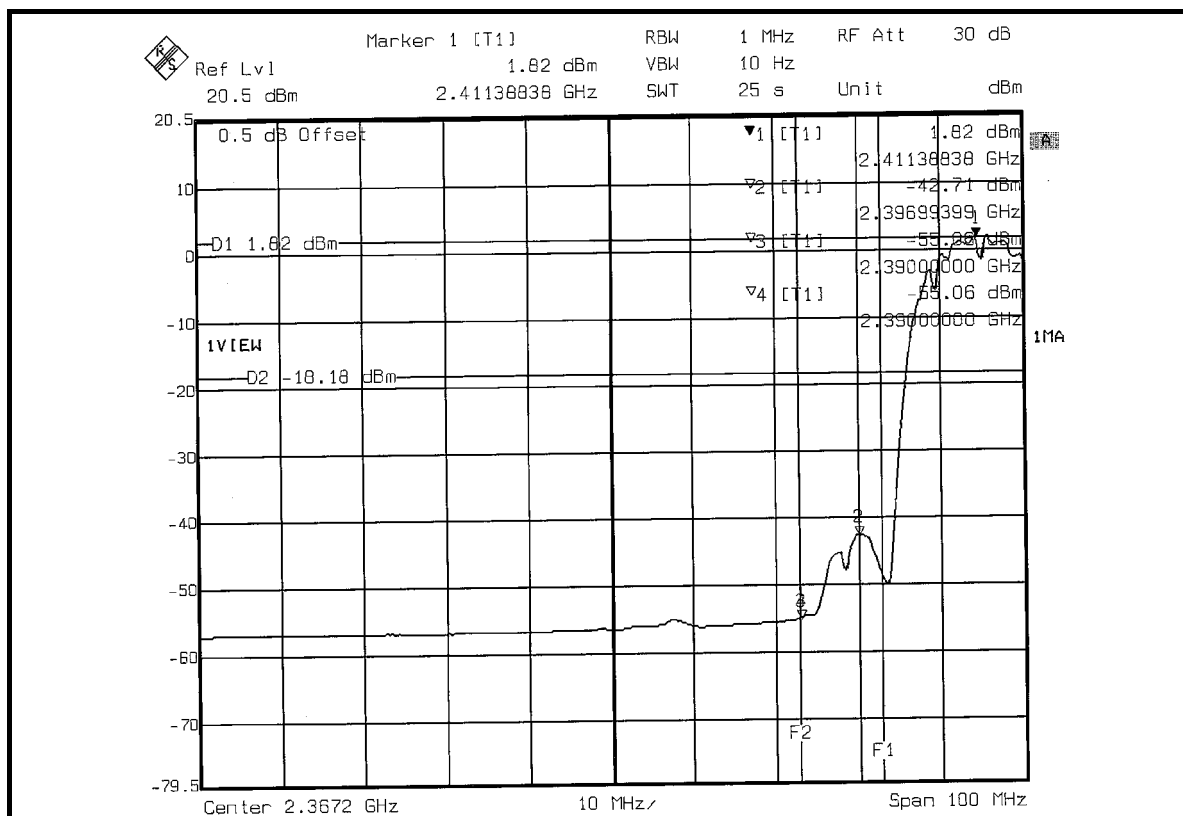
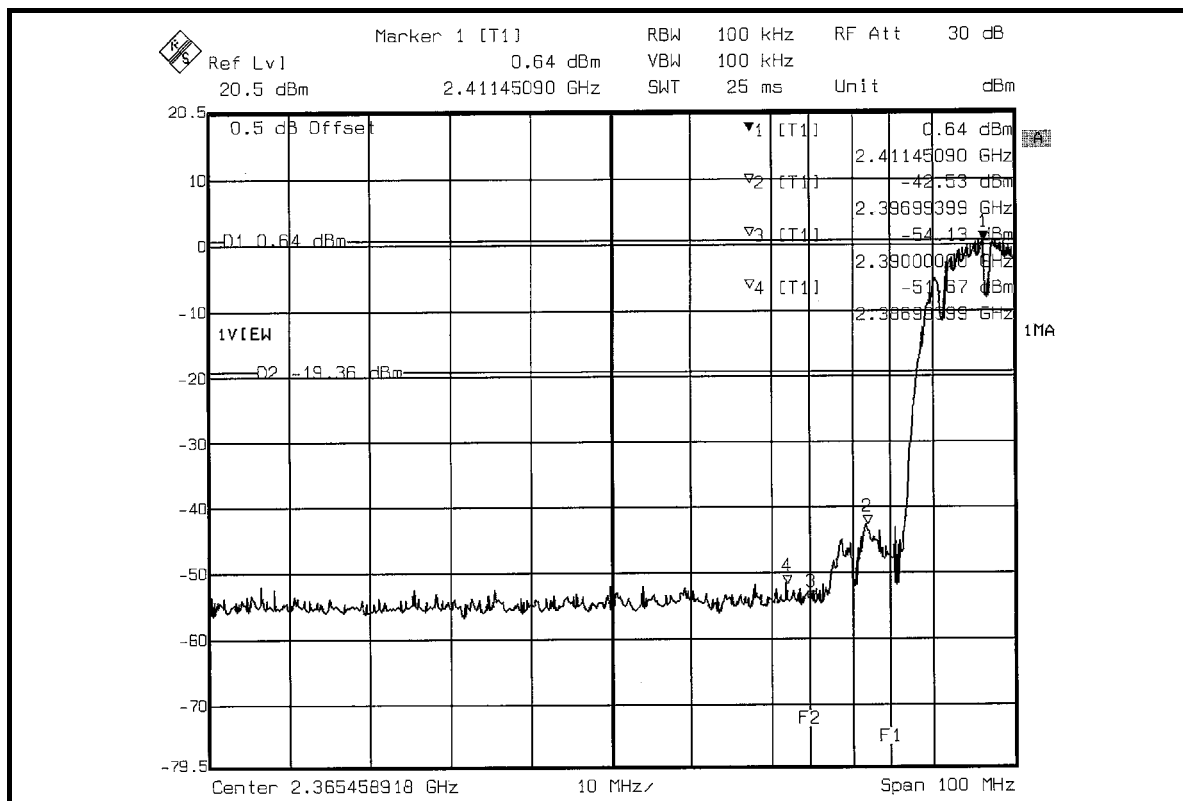

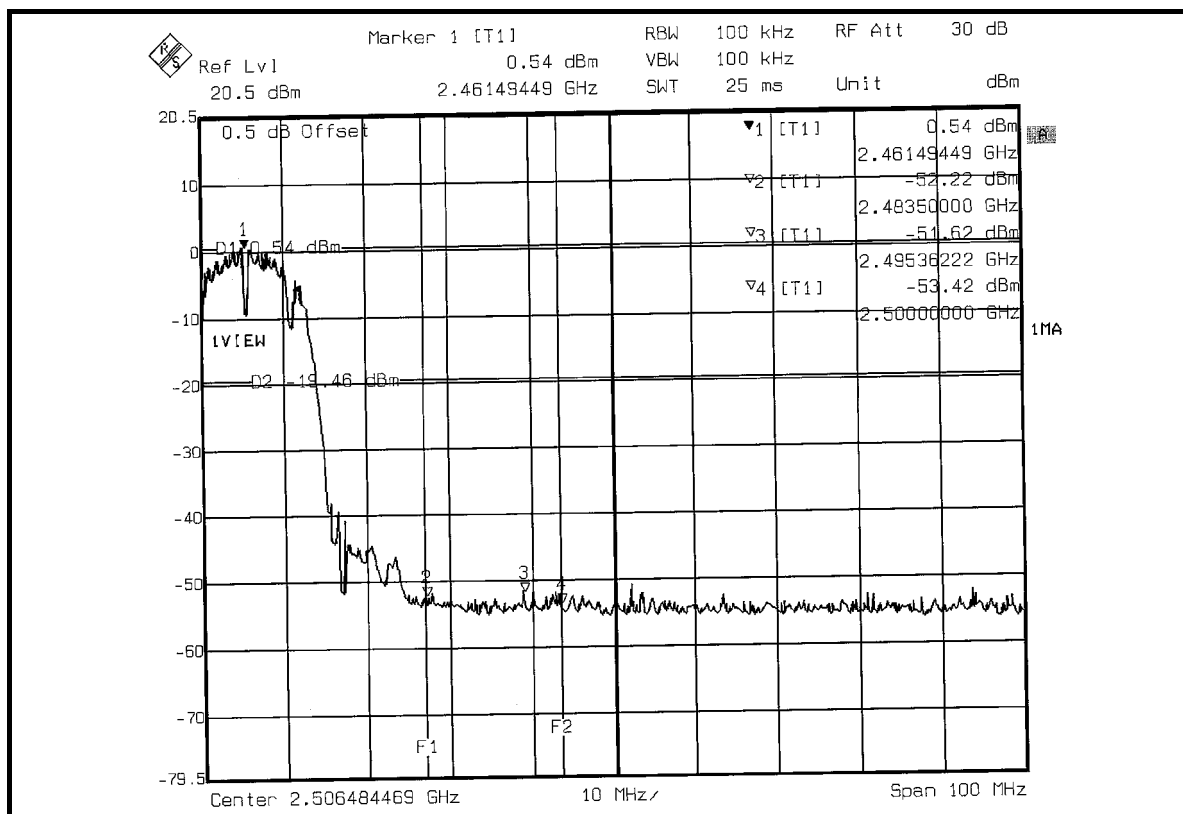
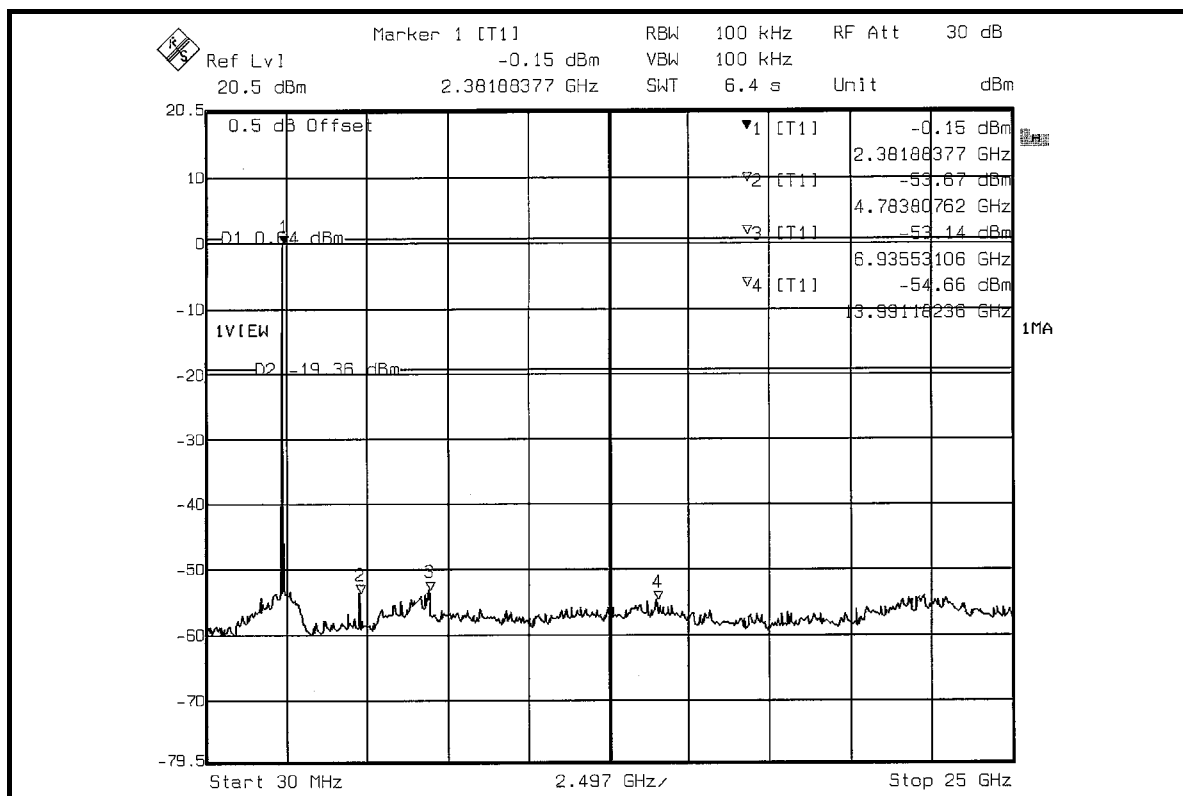

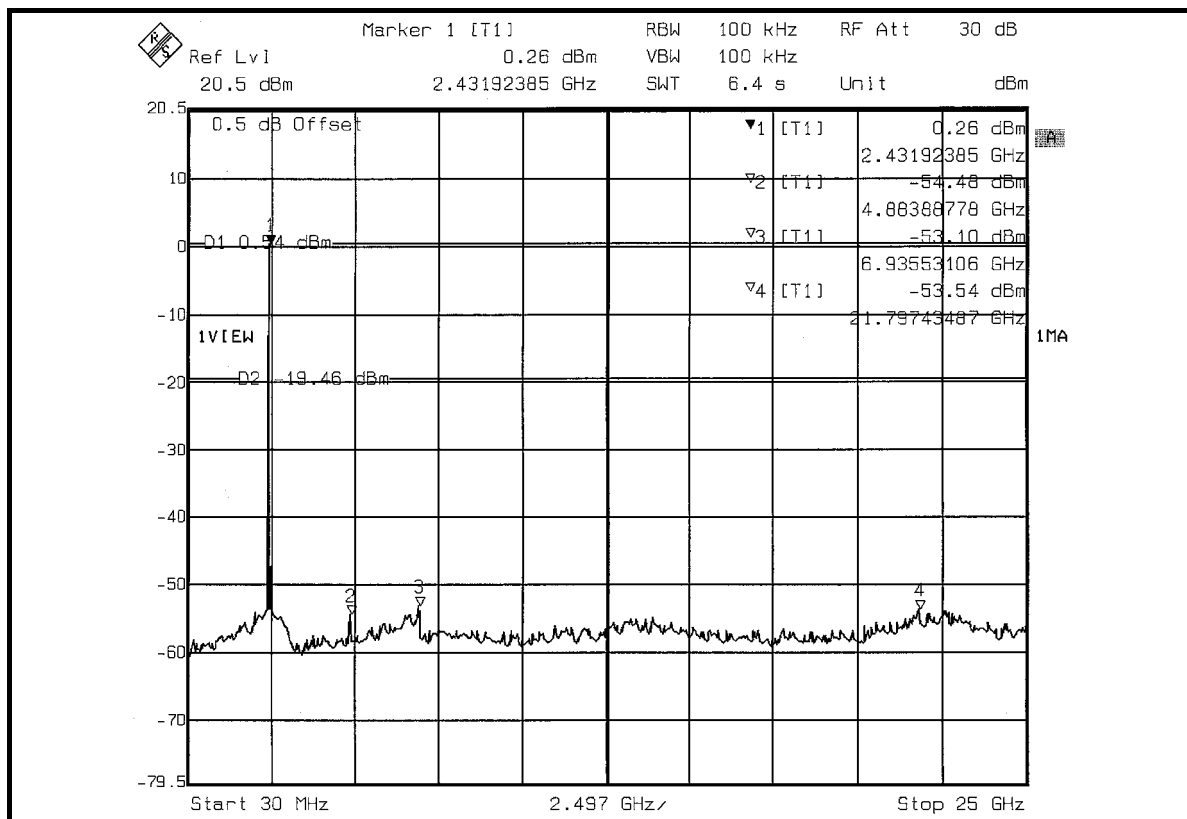
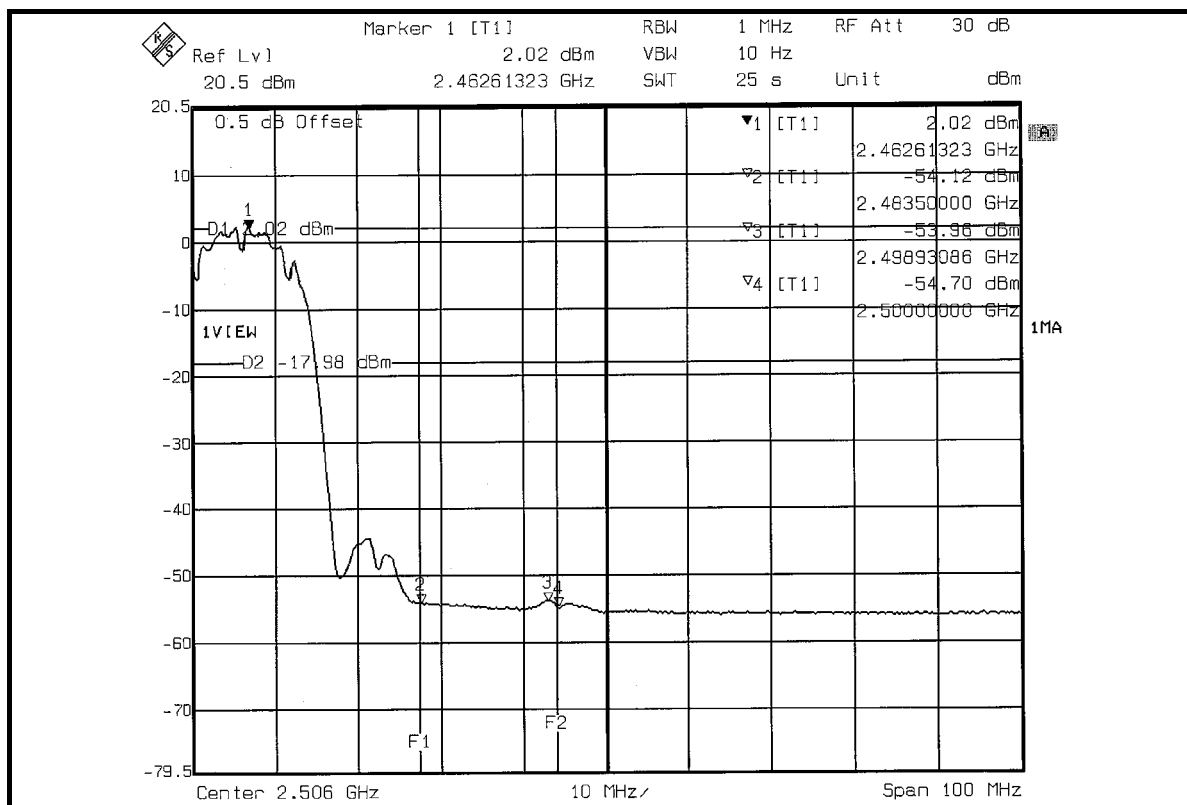



## 802.11g OFDM modulation

**NOTE 1:** The band edge emission plot on the next page shows 51.43dBc between carrier maximum power and local maximum emission in restrict band (2.3900GHz). The emission of carrier strength list in the test result of channel 1 at the item 4.2.7 is 104.13dBuV/m (Peak), so the maximum field strength in restrict band is  $104.13 - 51.43 = 52.70$ dBuV/m which is under 74dBuV/m limit.

The band edge emission plot of on the next page shows 50.96dBc between carrier maximum power and local maximum emission in restrict band (2.3900GHz). The emission of carrier strength list in the test result of channel 1 at the item 4.2.7 is 94.79dBuV/m (Average), so the maximum field strength in restrict band is  $94.79 - 50.96 = 43.83$ dBuV/m which is under 54dBuV/m limit.

**NOTE 2:** The band edge emission plot on the next second page shows 52.31dBc between carrier maximum power and local maximum emission in restrict band (2.4979GHz). The emission of carrier strength list in the test result of channel 11 at the item 4.2.7 is 105.10dBuV/m (Peak), so the maximum field strength in restrict band is  $105.10 - 52.31 = 52.79$ dBuV/m which is under 74dBuV/m limit.

The band edge emission plot on the next third page shows 50.61dBc between carrier maximum power and local maximum emission in restrict band (2.4835GHz). The emission of carrier strength list in the test result of channel 11 at the item 4.2.7 is 95.92dBuV/m (Average), so the maximum field strength in restrict band is  $95.92 - 50.61 = 45.31$ dBuV/m which is under 54dBuV/m limit.

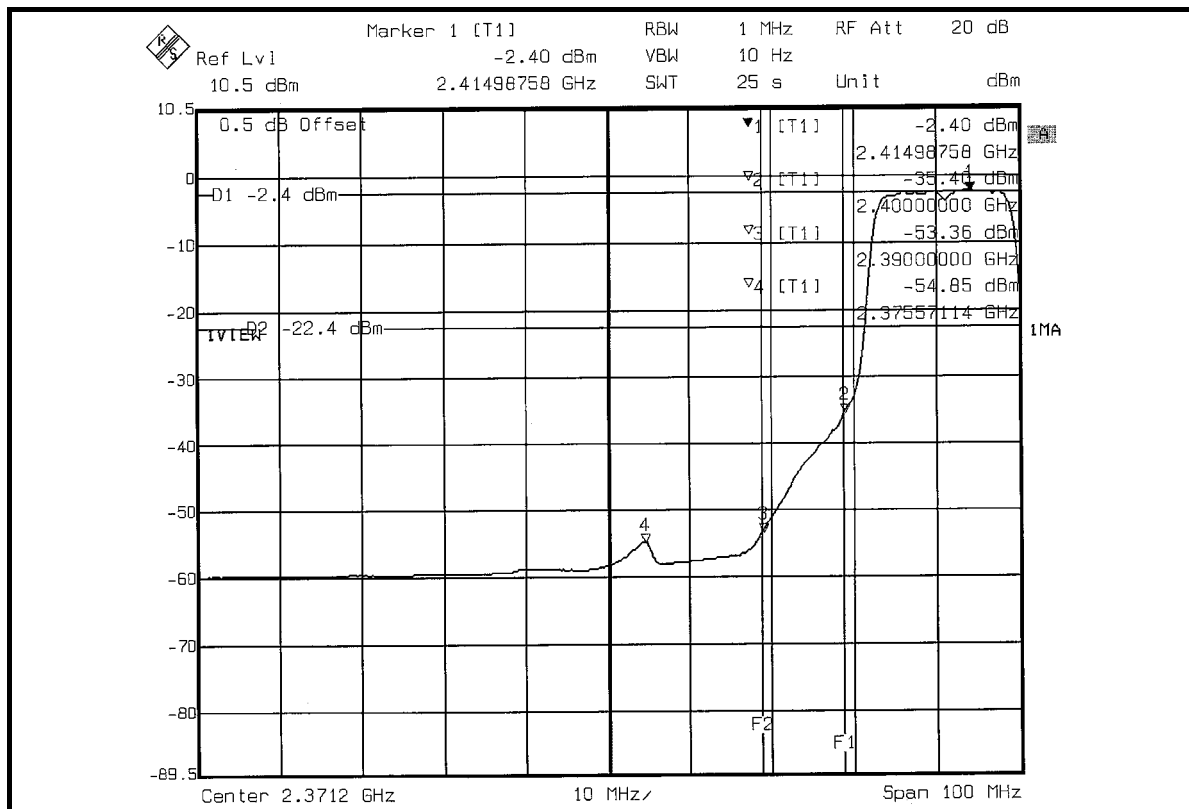
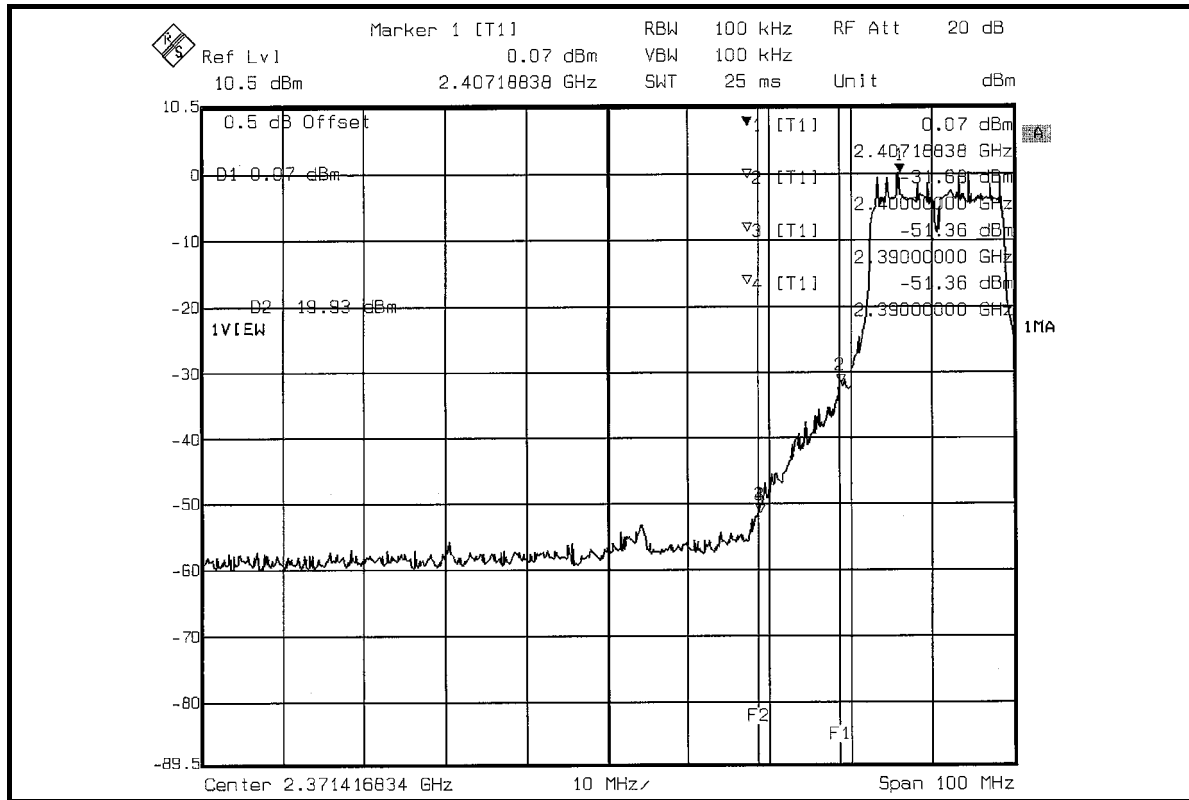

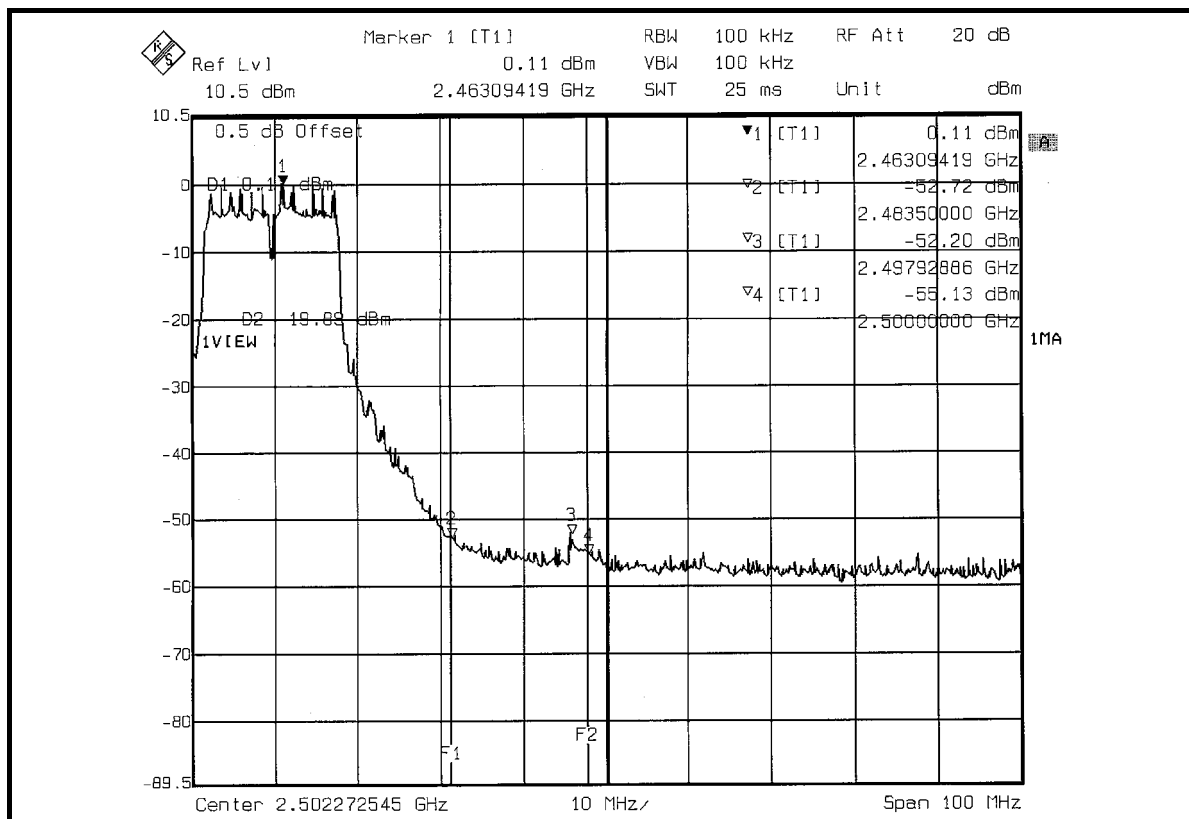
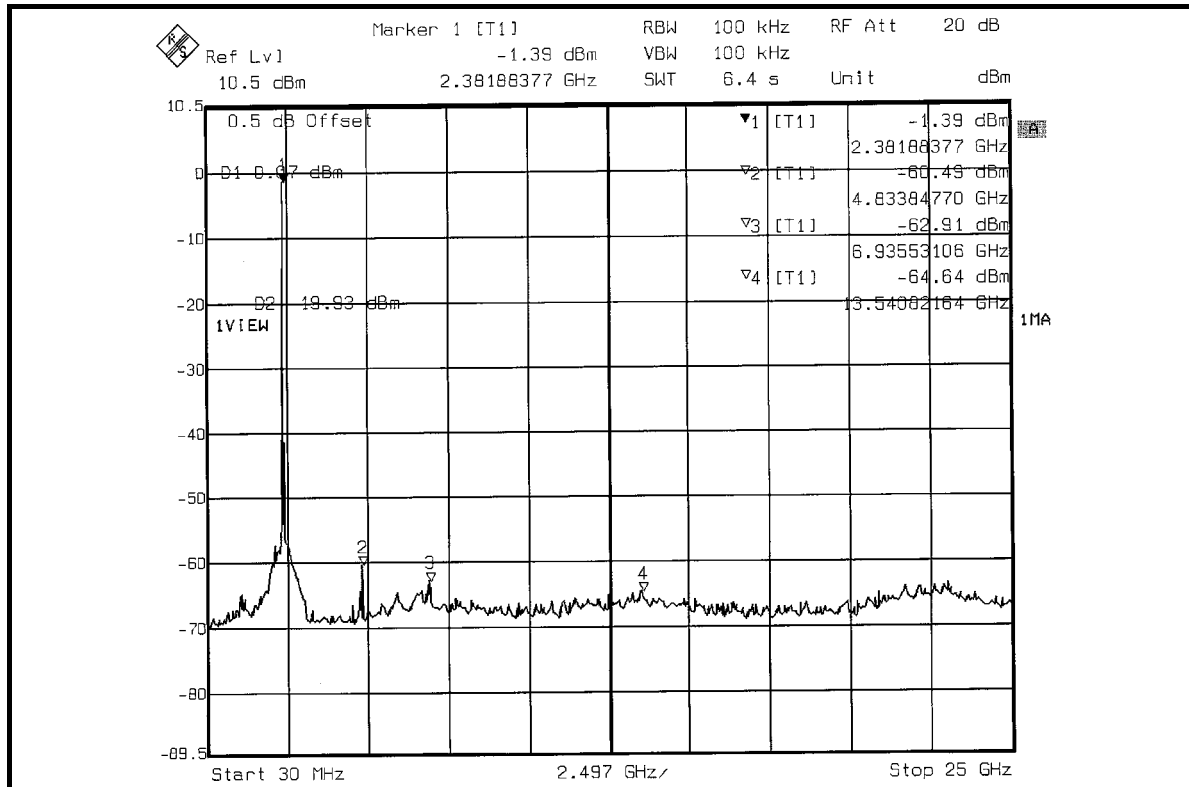

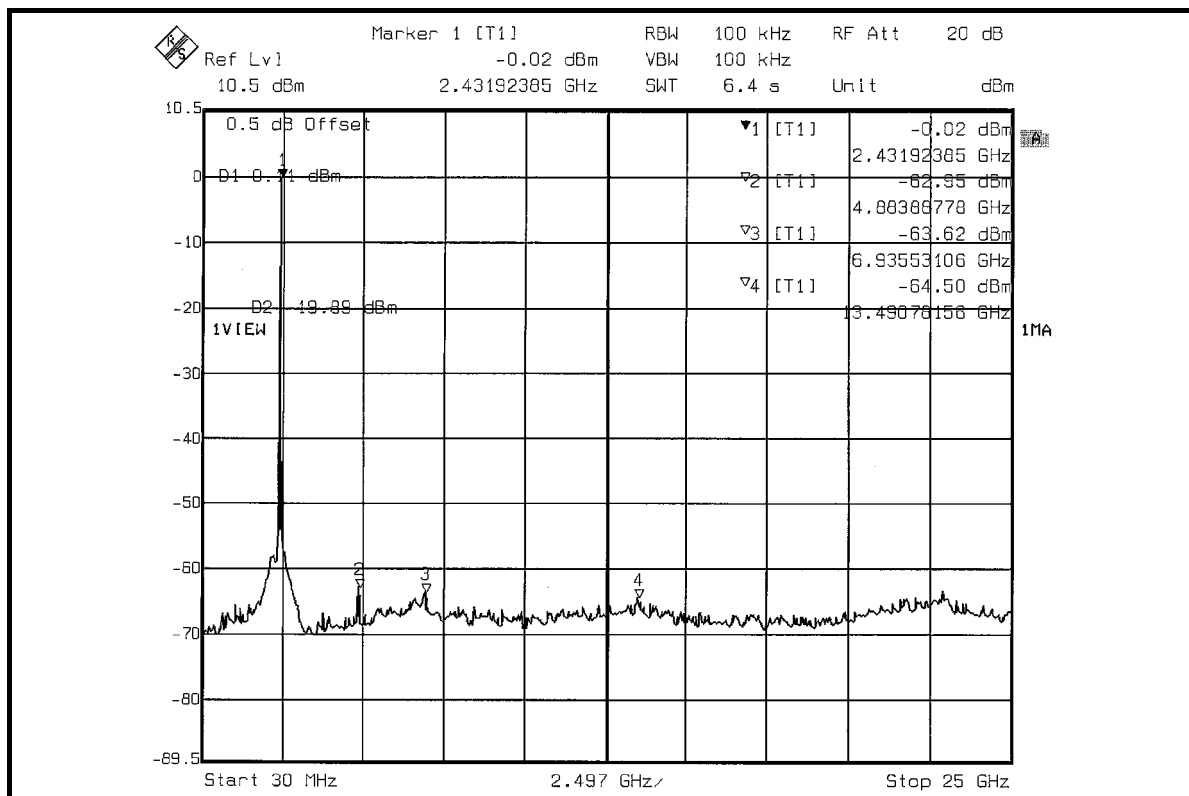
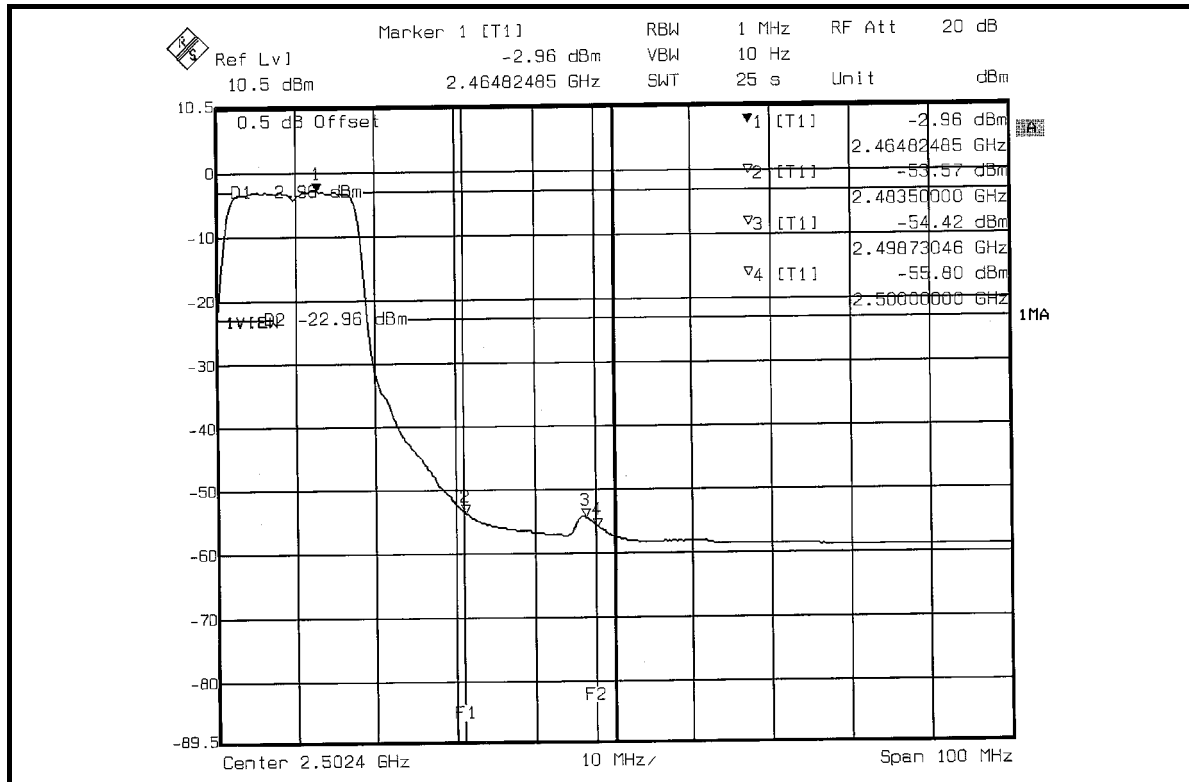

## **4.7 ANTENNA REQUIREMENT**

### **4.7.1 STANDARD APPLICABLE**

For intentional device, according to FCC 47 CFR Section 15.203, an intentional radiator shall be designed to ensure that no antenna other than that furnished by the responsible party shall be used with the device. And according to FCC 47 CFR Section 15.247 (b), if transmitting antennas of directional gain greater than 6dBi are used, the power shall be reduced by the amount in dB that the directional gain of the antenna exceeds 6dBi.

### **4.7.2 ANTENNA CONNECTED CONSTRUCTION**

The antenna used in this product is PIFA antenna with UFL connector. The maximum Gain of the antenna is 2.0dBi.



## 5. TEST TYPES AND RESULTS (FOR 802.11a 5745~5825MHz Band)

### 5.1 CONDUCTED EMISSION MEASUREMENT

#### 5.1.1 LIMITS OF CONDUCTED EMISSION MEASUREMENT

FREQUENCY OF EMISSION (MHz)	CONDUCTED LIMIT (dBµV)	
	Quasi-peak	Average
0.15-0.5	66 to 56	56 to 46
0.5-5	56	46
5-30	60	50

- NOTE:**
1. The lower limit shall apply at the transition frequencies.
  2. The limit decreases in line with the logarithm of the frequency in the range of 0.15 to 0.50 MHz.
  3. All emanations from a class A/B digital device or system, including any network of conductors and apparatus connected thereto, shall not exceed the level of field strengths specified above.

#### 5.1.2 TEST INSTRUMENTS

DESCRIPTION & MANUFACTURER	MODEL NO.	SERIAL NO.	CALIBRATED UNTIL
Test Receiver ROHDE & SCHWARZ	ESCS30	100288	Nov. 02, 2006
RF signal cable Woken	5D-FB	Cable-HYCO3-01	Jan. 06, 2007
LISN ROHDE & SCHWARZ	ESH2-Z5	100100	Jan. 09, 2007
LISN ROHDE & SCHWARZ	ESH3-Z5	100311	Jan. 22, 2007
Software ADT	ADT_Cond_V3	NA	NA

- NOTE:**
1. The calibration interval of the above test instruments is 12 months and the calibrations are traceable to NML/ROC and NIST/USA.
  2. The test was performed in HwaYa Shielded Room 2.
  3. The VCCI Site Registration No. is C-2047.

### 5.1.3 TEST PROCEDURES

- a. The EUT was placed 0.4 meters from the conducting wall of the shielded room with EUT being connected to the power mains through a line impedance stabilization network (LISN). Other support units were connected to the power mains through another LISN. The two LISNs provide 50 ohm/ 50uH of coupling impedance for the measuring instrument.
- b. Both lines of the power mains connected to the EUT were checked for maximum conducted interference.
- c. The frequency range from 150kHz to 30MHz was searched. Emission levels under (Limit – 20dB) was not recorded.

### 5.1.4 DEVIATION FROM TEST STANDARD

No deviation

### 5.1.5 TEST SETUP

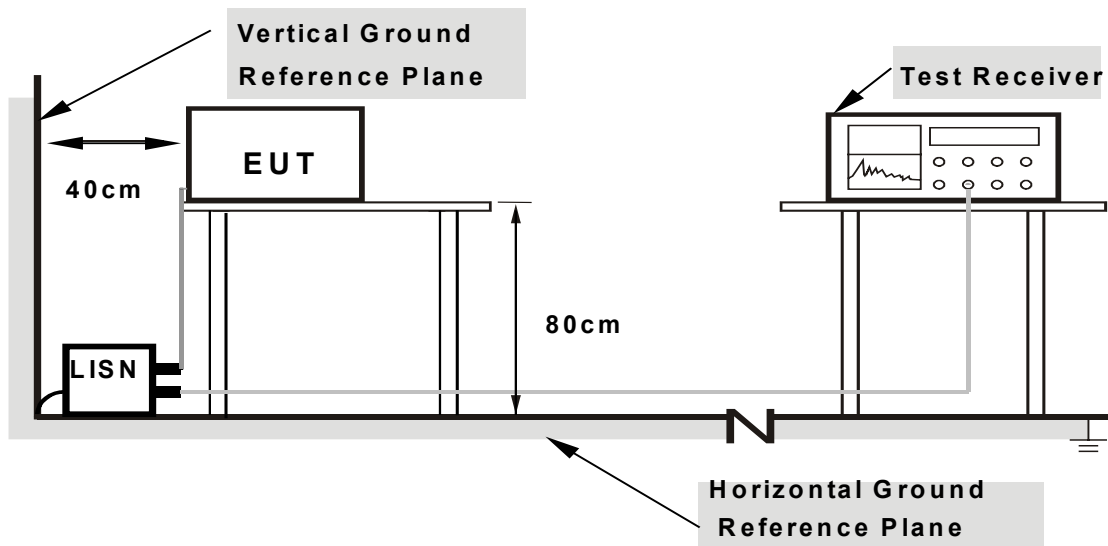

- Note:**
- 1.Support units were connected to second LISN.
  - 2.Both of LISNs (AMN) are 80 cm from EUT and at least 80 from other units and other metal planes

For the actual test configuration, please refer to the related item – Photographs of the Test Configuration.

### 5.1.6 EUT OPERATING CONDITIONS

Same as 4.1.6



## 5.1.7 TEST RESULTS

### Conducted Worst-Case Data

EUT TEST CONDITION		MEASUREMENT DETAIL	
CHANNEL	Channel 5	PHASE	Line 1
MODULATION TYPE	BPSK	6dB BANDWIDTH	9 kHz
TRANSFER RATE	6Mbps	ENVIRONMENTAL CONDITIONS	20deg. C, 60%RH, 991hPa
INPUT POWER (SYSTEM)	120Vac, 60 Hz	TEST MODE	A
TESTED BY	Match Tsui		

No	Freq. [MHz]	Corr. Factor [dB]	Reading Value [dB (uV)]		Emission Level [dB (uV)]		Limit [dB (uV)]		Margin (dB)	
			Q.P.	AV.	Q.P.	AV.	Q.P.	AV.	Q.P.	AV.
			1	0.193	0.10	46.35	-	46.45	-	63.91
2	0.259	0.10	37.00	-	37.10	-	61.45	51.45	-24.35	-
3	0.380	0.10	27.59	-	27.69	-	58.27	48.27	-30.58	-
4	0.857	0.10	22.17	-	22.27	-	56.00	46.00	-33.73	-
5	7.504	0.36	22.55	-	22.91	-	60.00	50.00	-37.09	-
6	29.074	1.26	27.04	-	28.30	-	60.00	50.00	-31.70	-

- REMARKS:**
1. Q.P. and AV. are abbreviations of quasi-peak and average individually.
  2. "-": The Quasi-peak reading value also meets average limit and measurement with the average detector is unnecessary.
  3. The emission levels of other frequencies were very low against the limit.
  4. Margin value = Emission level - Limit value
  5. Correction factor = Insertion loss + Cable loss
  6. Emission Level = Correction Factor + Reading Value.

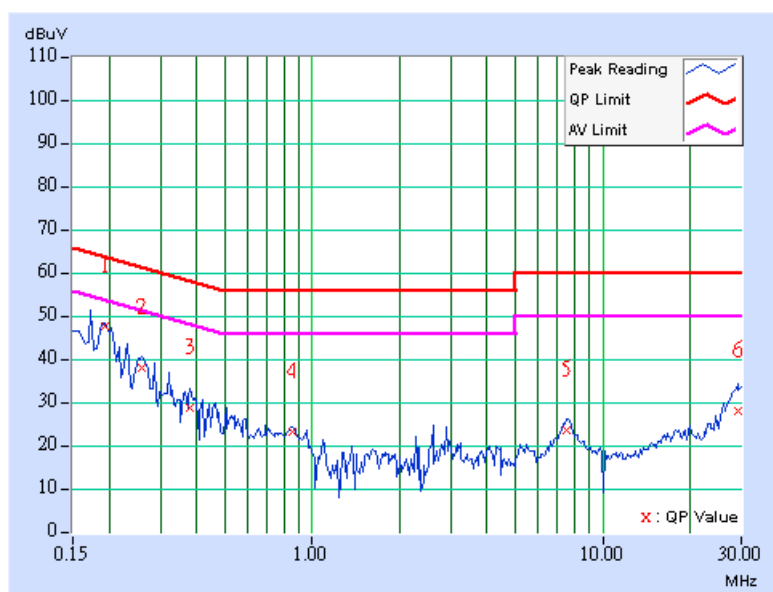

EUT TEST CONDITION		MEASUREMENT DETAIL	
CHANNEL	Channel 5	PHASE	Line 2
MODULATION TYPE	BPSK	6dB BANDWIDTH	9 kHz
TRANSFER RATE	6Mbps	ENVIRONMENTAL CONDITIONS	20deg. C, 60%RH, 991hPa
INPUT POWER (SYSTEM)	120Vac, 60 Hz	TEST MODE	A
TESTED BY	Match Tsui		

No	Freq. [MHz]	Corr. Factor (dB)	Reading Value [dB (uV)]		Emission Level [dB (uV)]		Limit [dB (uV)]		Margin (dB)	
			Q.P.	AV.	Q.P.	AV.	Q.P.	AV.	Q.P.	AV.
1	0.189	0.10	46.21	-	46.31	-	64.08	54.08	-17.77	-
2	0.255	0.10	37.46	-	37.56	-	61.58	51.58	-24.02	-
3	0.400	0.10	26.81	-	26.91	-	57.85	47.85	-30.94	-
4	0.939	0.19	22.07	-	22.26	-	56.00	46.00	-33.74	-
5	7.512	0.42	14.39	-	14.81	-	60.00	50.00	-45.19	-
6	29.203	1.00	22.96	-	23.96	-	60.00	50.00	-36.04	-

- REMARKS:**
1. Q.P. and AV. are abbreviations of quasi-peak and average individually.
  2. "-": The Quasi-peak reading value also meets average limit and measurement with the average detector is unnecessary.
  3. The emission levels of other frequencies were very low against the limit.
  4. Margin value = Emission level - Limit value
  5. Correction factor = Insertion loss + Cable loss
  6. Emission Level = Correction Factor + Reading Value.

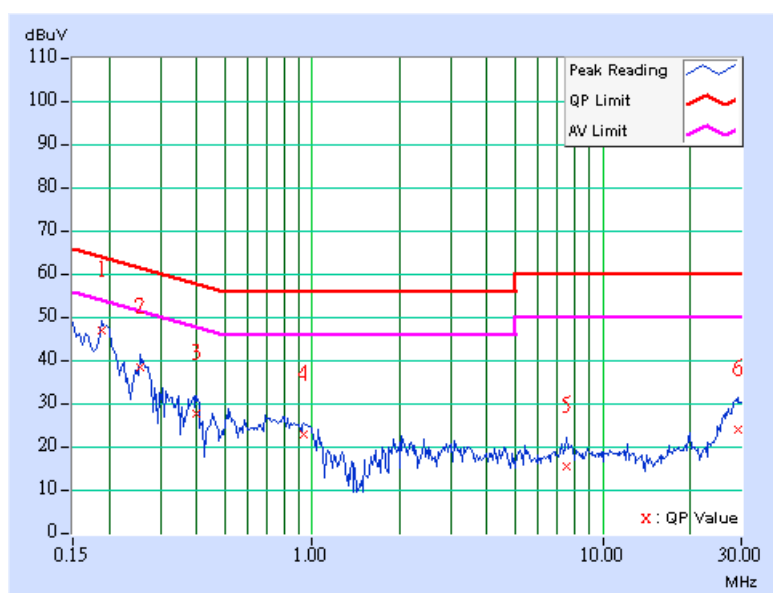

EUT TEST CONDITION		MEASUREMENT DETAIL	
CHANNEL	Channel 5	PHASE	Line 1
MODULATION TYPE	BPSK	6dB BANDWIDTH	9 kHz
TRANSFER RATE	6Mbps	ENVIRONMENTAL CONDITIONS	20deg. C, 60%RH, 991hPa
INPUT POWER (SYSTEM)	120Vac, 60 Hz	TEST MODE	B
TESTED BY	Match Tsui		

No	Freq. [MHz]	Corr. Factor (dB)	Reading Value [dB (uV)]		Emission Level [dB (uV)]		Limit [dB (uV)]		Margin (dB)	
			Q.P.	AV.	Q.P.	AV.	Q.P.	AV.	Q.P.	AV.
1	0.209	0.10	51.68	-	51.78	-	63.26	53.26	-11.48	-
2	0.314	0.10	41.88	-	41.98	-	59.86	49.86	-17.88	-
3	0.420	0.10	33.31	-	33.41	-	57.46	47.46	-24.05	-
4	0.627	0.10	32.32	-	32.42	-	56.00	46.00	-23.58	-
<b>5</b>	<b>4.492</b>	<b>0.37</b>	<b>44.75</b>	-	<b>45.12</b>	-	<b>56.00</b>	<b>46.00</b>	<b>-10.88</b>	-
6	23.410	0.81	29.07	-	29.88	-	60.00	50.00	-30.12	-

- REMARKS:**
1. Q.P. and AV. are abbreviations of quasi-peak and average individually.
  2. "-": The Quasi-peak reading value also meets average limit and measurement with the average detector is unnecessary.
  3. The emission levels of other frequencies were very low against the limit.
  4. Margin value = Emission level - Limit value
  5. Correction factor = Insertion loss + Cable loss
  6. Emission Level = Correction Factor + Reading Value.

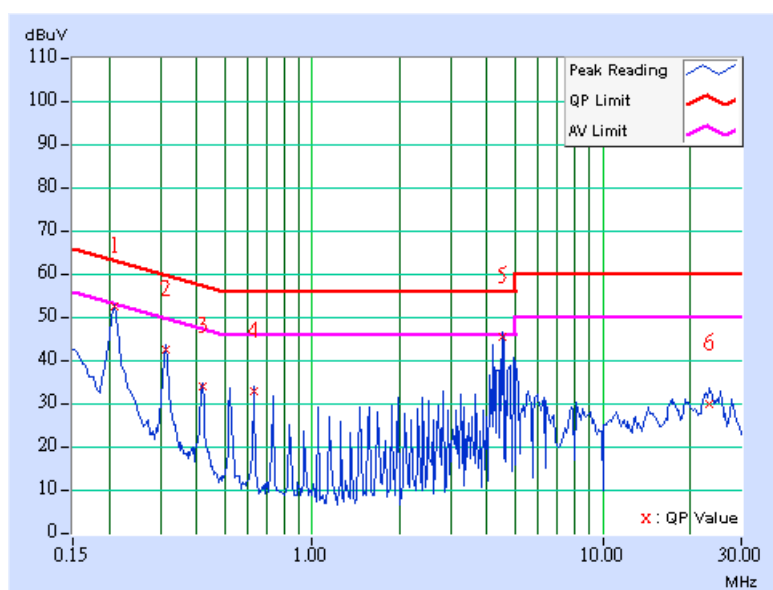

EUT TEST CONDITION		MEASUREMENT DETAIL	
CHANNEL	Channel 5	PHASE	Line 2
MODULATION TYPE	BPSK	6dB BANDWIDTH	9 kHz
TRANSFER RATE	6Mbps	ENVIRONMENTAL CONDITIONS	20deg. C, 60%RH, 991hPa
INPUT POWER (SYSTEM)	120Vac, 60 Hz	TEST MODE	B
TESTED BY	Match Tsui		

No	Freq. [MHz]	Corr. Factor (dB)	Reading Value [dB (uV)]		Emission Level [dB (uV)]		Limit [dB (uV)]		Margin (dB)	
			Q.P.	AV.	Q.P.	AV.	Q.P.	AV.	Q.P.	AV.
1	0.209	0.10	52.10	-	52.20	-	63.26	53.26	-11.06	-
2	0.314	0.10	42.21	-	42.31	-	59.86	49.86	-17.55	-
3	0.420	0.10	33.33	-	33.43	-	57.46	47.46	-24.02	-
4	0.521	0.12	32.79	-	32.91	-	56.00	46.00	-23.09	-
5	4.809	0.38	40.63	-	41.01	-	56.00	46.00	-14.99	-
6	25.200	0.84	35.84	-	36.68	-	60.00	50.00	-23.32	-

- REMARKS:**
1. Q.P. and AV. are abbreviations of quasi-peak and average individually.
  2. "-": The Quasi-peak reading value also meets average limit and measurement with the average detector is unnecessary.
  3. The emission levels of other frequencies were very low against the limit.
  4. Margin value = Emission level - Limit value
  5. Correction factor = Insertion loss + Cable loss
  6. Emission Level = Correction Factor + Reading Value.

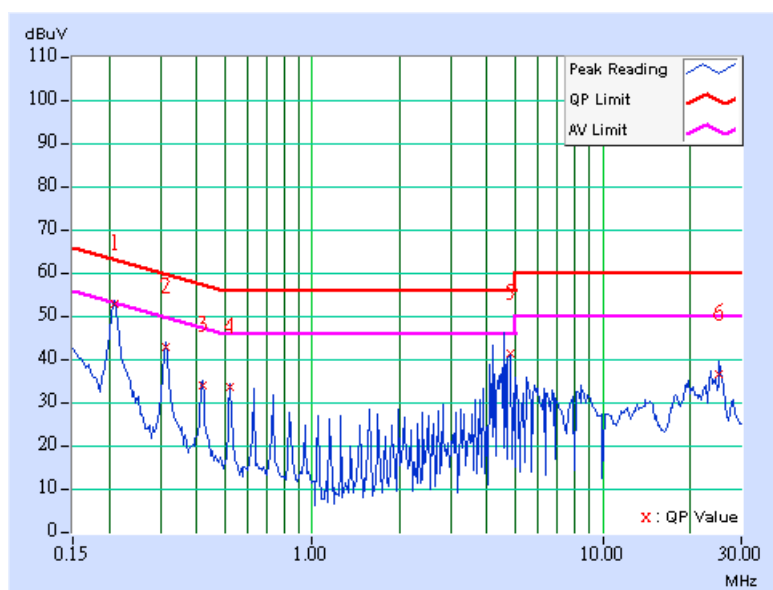

## 5.2 RADIATED EMISSION MEASUREMENT

### 5.2.1 LIMITS OF RADIATED EMISSION MEASUREMENT

Emissions radiated outside of the specified bands, shall be according to the general radiated limits in 15.209 as following:

Frequencies (MHz)	Field strength (microvolts/meter)	Measurement distance (meters)
0.009-0.490	2400/F(kHz)	300
0.490-1.705	24000/F(kHz)	30
1.705-30.0	30	30
30-88	100	3
88-216	150	3
216-960	200	3
Above 960	500	3

**NOTE:**

1. The lower limit shall apply at the transition frequencies.
2. Emission level (dBuV/m) = 20 log Emission level (uV/m).
3. As shown in 15.35(b), for frequencies above 1000MHz, the field strength limits are based on average detector, however, the peak field strength of any emission shall not exceed the maximum permitted average limits, specified above by more than 20dB under any condition of modulation.

## 5.2.2 TEST INSTRUMENTS

DESCRIPTION & MANUFACTURER	MODEL NO.	SERIAL NO.	CALIBRATED UNTIL
Test Receiver ROHDE & SCHWARZ	ESI7	838496/016	Jan. 01, 2007
Spectrum Analyzer ROHDE & SCHWARZ	FSP40	100041	Dec. 04, 2006
BILOG Antenna SCHWARZBECK	VULB9168	9168-155	Jan. 15, 2007
HORN Antenna SCHWARZBECK	BBHA 9120D	9120D-404	Jan. 01, 2007
HORN Antenna SCHWARZBECK	BBHA 9170	BBHA9170242	Jan. 19, 2007
Preamplifier Agilent	8449B	3008A01960	Nov. 09, 2006
RF signal cable HUBER+SUHNNER	SUCOFLEX 104	219268/4	Dec. 20, 2006
RF signal cable HUBER+SUHNNER	SUCOFLEX 104	230129/4	Dec. 20, 2006
Software ADT.	ADT_Radiated_V5.14	NA	NA
Antenna Tower inn-co GmbH	MA 4000	010303	NA
Antenna Tower Controller inn-co GmbH	CO2000	019303	NA
Turn Table ADT.	TT100.	TT93021704	NA
Turn Table Controller ADT.	SC100.	SC93021704	NA
26GHz ~ 40GHz Amplifier	AMF-6F-2600400	900619	Nov. 13, 2006

- NOTE:**
1. The calibration interval of the above test instruments is 12 months and the calibrations are traceable to NML/ROC and NIST/USA.
  2. The test was performed in HwaYa Chamber 3.
  3. The horn antenna and HP preamplifier (model: 8449B) are used only for the measurement of emission frequency above 1GHz if tested.
  4. The IC Site Registration No. is IC4924-4.

### 5.2.3 TEST PROCEDURES

- a. The EUT was placed on the top of a rotating table 0.8 meters above the ground at a 3 meters semi-anechoic chamber. The table was rotated 360 degrees to determine the position of the highest radiation.
- b. The EUT was set 3 meters away from the interference-receiving antenna, which was mounted on the top of a variable-height antenna tower.
- c. The antenna is a broadband antenna, and its height is varied from one meter to four meters above the ground to determine the maximum value of the field strength. Both horizontal and vertical polarizations of the antenna are set to make the measurement.
- d. For each suspected emission, the EUT was arranged to its worst case and then the antenna was tuned to heights from 1 meter to 4 meters and the rotatable table was turned from 0 degrees to 360 degrees to find the maximum reading.
- e. The test-receiver system was set to Peak Detect Function and Specified Bandwidth with Maximum Hold Mode.
- f. If the emission level of the EUT in peak mode was lower than the limit specified, then testing could be stopped and the peak values of the EUT would be reported. Otherwise the emissions would be re-tested one by one using peak, quasi-peak or average method as specified and then reported in a data sheet.

**NOTE:**

1. The resolution bandwidth and video bandwidth of test receiver/spectrum analyzer is 120kHz for Peak detection (PK) and Quasi-peak detection (QP) at frequency below 1GHz.
2. The resolution bandwidth and video bandwidth of test receiver/spectrum analyzer is 1 MHz for Peak detection at frequency above 1GHz.
3. The resolution bandwidth of test receiver/spectrum analyzer is 1 MHz and the video bandwidth is 10Hz for Average detection (AV) at frequency above 1GHz.

### 5.2.4 DEVIATION FROM TEST STANDARD

No deviation

### 5.2.5 TEST SETUP

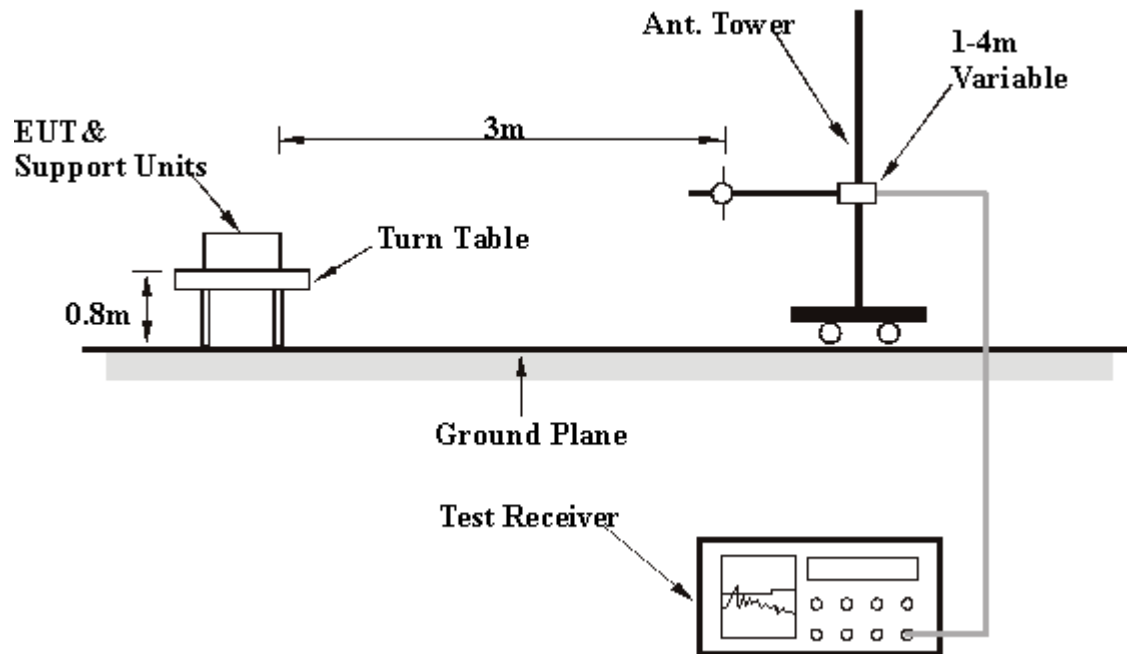

For the actual test configuration, please refer to the related item – Photographs of the Test Configuration.

### 5.2.6 EUT OPERATING CONDITIONS

Same as 4.1.6





## 5.2.7 TEST RESULTS

### Below 1GHz Worst-Case Data

EUT TEST CONDITION		MEASUREMENT DETAIL	
CHANNEL	Channel 5	FREQUENCY RANGE	Below 1000MHz
MODULATION TYPE	BPSK	DETECTOR FUNCTION	Quasi-Peak
TRANSFER RATE	6Mbps	ENVIRONMENTAL CONDITIONS	25deg. C, 65%RH, 991hPa
INPUT POWER (SYSTEM)	120Vac, 60 Hz	TEST MODE	A
TESTED BY	Brad Wu		

ANTENNA POLARITY & TEST DISTANCE: HORIZONTAL AT 3 M								
No.	Freq. (MHz)	Emission Level (dBuV/m)	Limit (dBuV/m)	Margin (dB)	Antenna Height (m)	Table Angle (Degree)	Raw Value (dBuV)	Correction Factor (dB/m)
1	407.11	22.68 QP	46.00	-23.32	1.50 H	34	4.75	17.93
2	453.77	21.65 QP	46.00	-24.35	1.00 H	130	2.85	18.79
3	519.86	23.35 QP	46.00	-22.65	1.00 H	55	2.98	20.36
4	731.74	23.78 QP	46.00	-22.22	1.25 H	76	-1.40	25.18
5	846.43	29.50 QP	46.00	-16.50	1.50 H	97	2.80	26.70
6	963.07	28.08 QP	54.00	-25.92	1.00 H	85	-1.43	29.51

ANTENNA POLARITY & TEST DISTANCE: VERTICAL AT 3 M								
No.	Freq. (MHz)	Emission Level (dBuV/m)	Limit (dBuV/m)	Margin (dB)	Antenna Height (m)	Table Angle (Degree)	Raw Value (dBuV)	Correction Factor (dB/m)
1	37.78	28.57 QP	40.00	-11.43	1.25 V	13	14.72	13.85
2	125.25	22.11 QP	43.50	-21.39	1.00 V	343	10.57	11.54
3	453.77	20.18 QP	46.00	-25.82	1.00 V	343	1.38	18.79
4	519.86	27.75 QP	46.00	-18.25	1.50 V	100	7.39	20.36
5	727.86	24.06 QP	46.00	-21.94	1.50 V	277	-1.00	25.06
6	933.91	27.51 QP	46.00	-18.49	1.00 V	163	-1.53	29.04

- REMARKS:**
1. Emission level(dBuV/m)=Raw Value(dBuV) + Correction Factor(dB/m)
  2. Correction Factor(dB/m) = Antenna Factor (dB/m) + Cable Factor (dB)
  3. The other emission levels were very low against the limit.
  4. Margin value = Emission level – Limit value.



EUT TEST CONDITION		MEASUREMENT DETAIL	
CHANNEL	Channel 5	FREQUENCY RANGE	Below 1000MHz
MODULATION TYPE	BPSK	DETECTOR FUNCTION	Quasi-Peak
TRANSFER RATE	6Mbps	ENVIRONMENTAL CONDITIONS	25deg. C, 65%RH, 991hPa
INPUT POWER (SYSTEM)	120Vac, 60 Hz	TEST MODE	B
TESTED BY	Brad Wu		

ANTENNA POLARITY & TEST DISTANCE: HORIZONTAL AT 3 M								
No.	Freq. (MHz)	Emission Level (dBuV/m)	Limit (dBuV/m)	Margin (dB)	Antenna Height (m)	Table Angle (Degree)	Raw Value (dBuV)	Correction Factor (dB/m)
1	86.37	18.31 QP	40.00	-21.69	1.00 H	73	8.74	9.57
2	224.39	20.45 QP	46.00	-25.55	1.50 H	235	8.87	11.58
3	323.53	26.68 QP	46.00	-19.32	1.00 H	268	10.93	15.75
4	519.86	22.92 QP	46.00	-23.08	1.00 H	106	2.55	20.36
5	733.69	24.74 QP	46.00	-21.26	1.00 H	262	-0.50	25.25
6	947.52	29.56 QP	46.00	-16.44	2.00 H	184	-0.11	29.67

ANTENNA POLARITY & TEST DISTANCE: VERTICAL AT 3 M								
No.	Freq. (MHz)	Emission Level (dBuV/m)	Limit (dBuV/m)	Margin (dB)	Antenna Height (m)	Table Angle (Degree)	Raw Value (dBuV)	Correction Factor (dB/m)
1	86.37	27.38 QP	40.00	-12.62	1.25 V	259	17.81	9.57
2	243.83	21.26 QP	46.00	-24.74	1.00 V	151	9.03	12.23
3	311.86	23.04 QP	46.00	-22.96	1.00 V	343	7.45	15.59
4	519.86	34.19 QP	46.00	-11.81	1.00 V	124	13.83	20.36
5	790.06	24.68 QP	46.00	-21.32	1.50 V	268	-1.36	26.04
6	966.95	28.68 QP	54.00	-25.32	1.00 V	226	-0.75	29.42

- REMARKS:**
1. Emission level(dBuV/m)=Raw Value(dBuV) + Correction Factor(dB/m)
  2. Correction Factor(dB/m) = Antenna Factor (dB/m) + Cable Factor (dB)
  3. The other emission levels were very low against the limit.
  4. Margin value = Emission level – Limit value.

### 802.11a OFDM modulation

EUT TEST CONDITION		MEASUREMENT DETAIL	
CHANNEL	Channel 1	FREQUENCY RANGE	1 ~ 40 GHz
MODULATION TYPE	BPSK	DETECTOR FUNCTION	Peak(PK) Average (AV)
TRANSFER RATE	6Mbps	ENVIRONMENTAL CONDITIONS	25deg. C, 65%RH, 991hPa
INPUT POWER (SYSTEM)	120Vac, 60 Hz	TESTED BY	Brad Wu

#### ANTENNA POLARITY & TEST DISTANCE: HORIZONTAL AT 3 M

No.	Freq. (MHz)	Emission Level (dBuV/m)	Limit (dBuV/m)	Margin (dB)	Antenna Height (m)	Table Angle (Degree)	Raw Value (dBuV)	Correction Factor (dB/m)
1	5725.00	69.45 PK	81.55	-12.10	1.17 H	350	29.26	40.19
1	5725.00	58.95 AV	72.27	-13.32	1.17 H	350	18.76	40.19
2	*5745.00	101.55 PK			1.17 H	350	61.30	40.25
2	*5745.00	92.27 AV			1.17 H	350	52.02	40.25
3	#11490.00	61.02 PK	74.00	-12.98	1.02 H	24	9.17	51.84
3	#11490.00	48.59 AV	54.00	-5.41	1.02 H	24	-3.26	51.84

#### ANTENNA POLARITY & TEST DISTANCE: VERTICAL AT 3 M

No.	Freq. (MHz)	Emission Level (dBuV/m)	Limit (dBuV/m)	Margin (dB)	Antenna Height (m)	Table Angle (Degree)	Raw Value (dBuV)	Correction Factor (dB/m)
1	5725.00	71.04 PK	85.26	-14.22	1.00 V	24	30.85	40.19
1	5725.00	59.39 AV	75.95	-16.56	1.00 V	24	19.20	40.19
2	*5745.00	105.26 PK			1.00 V	24	65.01	40.25
2	*5745.00	95.95 AV			1.00 V	24	55.70	40.25
3	#11490.00	61.87 PK	74.00	-12.13	1.07 V	231	10.02	51.84
3	#11490.00	49.42 AV	54.00	-4.58	1.07 V	231	-2.42	51.84

- NOTE:**
1. Emission level(dBuV/m)=Raw Value(dBuV) + Correction Factor(dB/m)
  2. Correction Factor(dB/m) = Antenna Factor (dB/m) + Cable Factor (dB)
  3. The other emission levels were very low against the limit.
  4. Margin value = Emission level – Limit value
  5. "\*" : Fundamental frequency
  6. "#"The radiated frequency falling in the restricted band.
  7. The limit value is defined as per 15.247

EUT TEST CONDITION		MEASUREMENT DETAIL	
CHANNEL	Channel 3	FREQUENCY RANGE	1 ~ 40 GHz
MODULATION TYPE	BPSK	DETECTOR FUNCTION	Peak(PK) Average (AV)
TRANSFER RATE	6Mbps	ENVIRONMENTAL CONDITIONS	25deg. C, 65%RH, 991hPa
INPUT POWER (SYSTEM)	120Vac, 60 Hz	TESTED BY	Brad Wu

ANTENNA POLARITY & TEST DISTANCE: HORIZONTAL AT 3 M								
No.	Freq. (MHz)	Emission Level (dBuV/m)	Limit (dBuV/m)	Margin (dB)	Antenna Height (m)	Table Angle (Degree)	Raw Value (dBuV)	Correction Factor (dB/m)
1	*5785.00	102.19 PK			1.08 H	59	61.84	40.35
1	*5785.00	92.64 AV			1.08 H	59	52.29	40.35
2	#11570.00	61.99 PK	74.00	-12.01	1.00 H	298	10.31	51.68
2	#11570.00	50.20 AV	54.00	-3.80	1.00 H	298	-1.48	51.68

ANTENNA POLARITY & TEST DISTANCE: VERTICAL AT 3 M								
No.	Freq. (MHz)	Emission Level (dBuV/m)	Limit (dBuV/m)	Margin (dB)	Antenna Height (m)	Table Angle (Degree)	Raw Value (dBuV)	Correction Factor (dB/m)
1	*5785.00	105.89 PK			1.05 V	49	65.54	40.35
1	*5785.00	96.24 AV			1.05 V	49	55.89	40.35
2	#11570.00	61.82 PK	74.00	-12.18	1.00 V	58	10.14	51.68
2	#11570.00	49.20 AV	54.00	-4.80	1.00 V	58	-2.48	51.68

- NOTE:**
1. Emission level(dBuV/m)=Raw Value(dBuV) + Correction Factor(dB/m)
  2. Correction Factor(dB/m) = Antenna Factor (dB/m) + Cable Factor (dB)
  3. The other emission levels were very low against the limit.
  4. Margin value = Emission level – Limit value
  5. "\*" : Fundamental frequency
  6. "#"The radiated frequency falling in the restricted band.
  7. The limit value is defined as per 15.247

EUT TEST CONDITION		MEASUREMENT DETAIL	
CHANNEL	Channel 5	FREQUENCY RANGE	1 ~ 40 GHz
MODULATION TYPE	BPSK	DETECTOR FUNCTION	Peak(PK) Average (AV)
TRANSFER RATE	6Mbps	ENVIRONMENTAL CONDITIONS	25deg. C, 65%RH, 991hPa
INPUT POWER (SYSTEM)	120Vac, 60 Hz	TESTED BY	Brad Wu

ANTENNA POLARITY & TEST DISTANCE: HORIZONTAL AT 3 M								
No.	Freq. (MHz)	Emission Level (dBuV/m)	Limit (dBuV/m)	Margin (dB)	Antenna Height (m)	Table Angle (Degree)	Raw Value (dBuV)	Correction Factor (dB/m)
1	*5825.00	102.07 PK			1.16 H	348	61.62	40.45
1	*5825.00	92.47 AV			1.16 H	348	52.02	40.45
2	5850.00	67.65 PK	82.07	-14.42	1.16 H	348	27.14	40.52
2	5850.00	56.27 AV	72.47	-16.20	1.16 H	348	15.76	40.52
3	#11650.00	60.87 PK	74.00	-13.13	1.04 H	63	9.39	51.48
3	#11650.00	48.45 AV	54.00	-5.55	1.04 H	63	-3.03	51.48

ANTENNA POLARITY & TEST DISTANCE: VERTICAL AT 3 M								
No.	Freq. (MHz)	Emission Level (dBuV/m)	Limit (dBuV/m)	Margin (dB)	Antenna Height (m)	Table Angle (Degree)	Raw Value (dBuV)	Correction Factor (dB/m)
1	*5825.00	105.76 PK			1.00 V	40	65.31	40.45
1	*5825.00	96.10 AV			1.00 V	40	55.65	40.45
2	5850.00	69.81 PK	85.76	-15.95	1.00 V	40	29.30	40.52
2	5850.00	58.41 AV	76.10	-17.69	1.00 V	40	17.89	40.52
3	#11650.00	60.59 PK	74.00	-13.41	1.08 V	234	9.11	51.48
3	#11650.00	48.08 AV	54.00	-5.92	1.08 V	234	-3.40	51.48

- NOTE:**
1. Emission level(dBuV/m)=Raw Value(dBuV) + Correction Factor(dB/m)
  2. Correction Factor(dB/m) = Antenna Factor (dB/m) + Cable Factor (dB)
  3. The other emission levels were very low against the limit.
  4. Margin value = Emission level – Limit value
  5. "\*" : Fundamental frequency
  6. "#"The radiated frequency falling in the restricted band.
  7. The limit value is defined as per 15.247



### 5.3 6dB BANDWIDTH MEASUREMENT

#### 5.3.1 LIMITS OF 6dB BANDWIDTH MEASUREMENT

The minimum of 6dB Bandwidth Measurement is 0.5 MHz.

#### 5.3.2 TEST INSTRUMENTS

Description & Manufacturer	Model No.	Serial No.	Calibrated Until
R&S SPECTRUM ANALYZER	FSP40	100040	Jun. 07, 2007

**NOTES:** The calibration interval of the above test instruments is 12 months and the calibrations are traceable to NML/ROC and NIST/USA.

### 5.3.3 TEST PROCEDURE

The transmitter output was connected to the spectrum analyzer through an attenuator. The bandwidth of the fundamental frequency was measured by spectrum analyzer with 100kHz RBW and 100kHz VBW. The 6dB bandwidth is defined as the total spectrum the power of which is higher than peak power minus 6dB.

### 5.3.4 DEVIATION FROM TEST STANDARD

No deviation

### 5.3.5 TEST SETUP

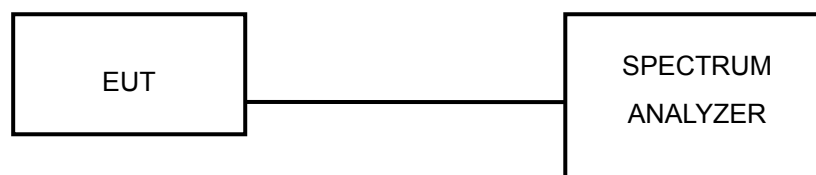

### 5.3.6 EUT OPERATING CONDITIONS

The software provided by client to enable the EUT under transmission condition continuously at lowest, middle and highest channel frequencies individually.



### 5.3.7 TEST RESULTS

#### 802.11a OFDM modulation

<b>MODULATION TYPE</b>	BPSK	<b>TRANSFER RATE</b>	6Mbps
<b>INPUT POWER (SYSTEM)</b>	120Vac, 60 Hz	<b>ENVIRONMENTAL CONDITIONS</b>	25deg.C, 68%RH, 991hPa
<b>TESTED BY</b>	Brad Wu		

<b>CHANNEL</b>	<b>CHANNEL FREQUENCY (MHz)</b>	<b>6dB BANDWIDTH (MHz)</b>	<b>MINIMUM LIMIT (MHz)</b>	<b>PASS/FAIL</b>
1	5745	15.78	0.5	PASS
3	5785	16.08	0.5	PASS
5	5825	16.03	0.5	PASS



CH 1

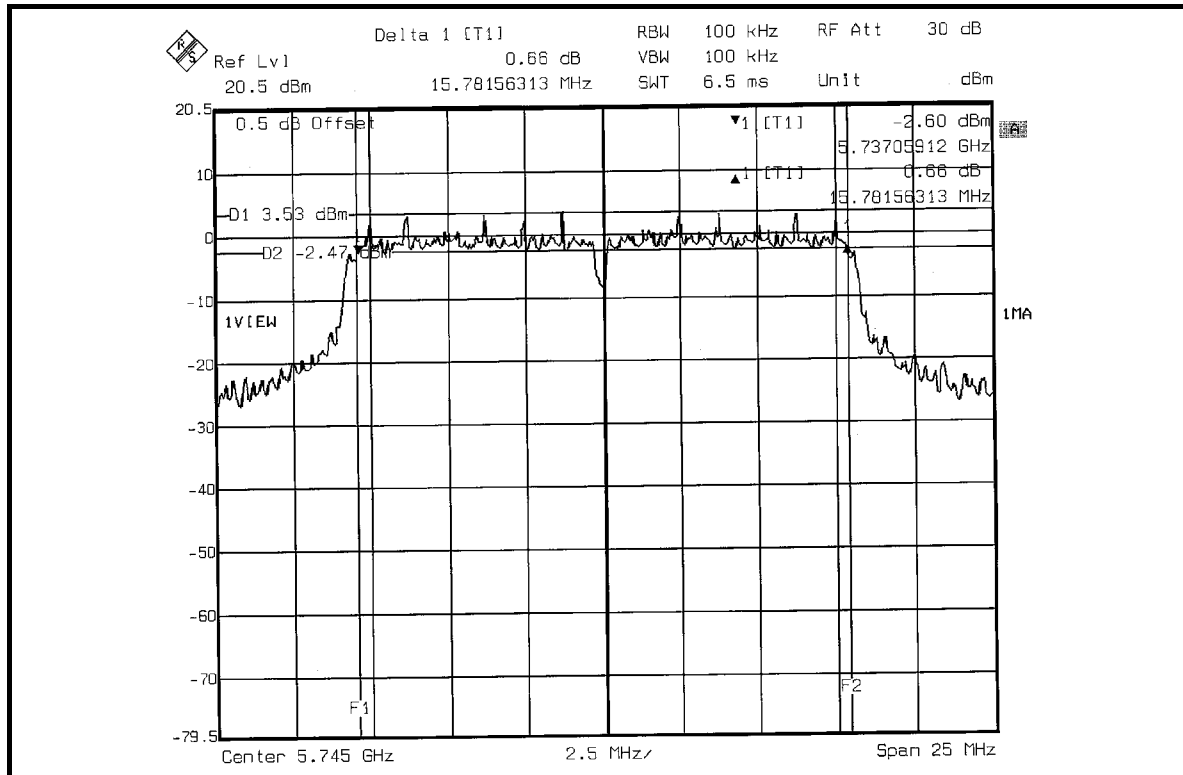

CH 3

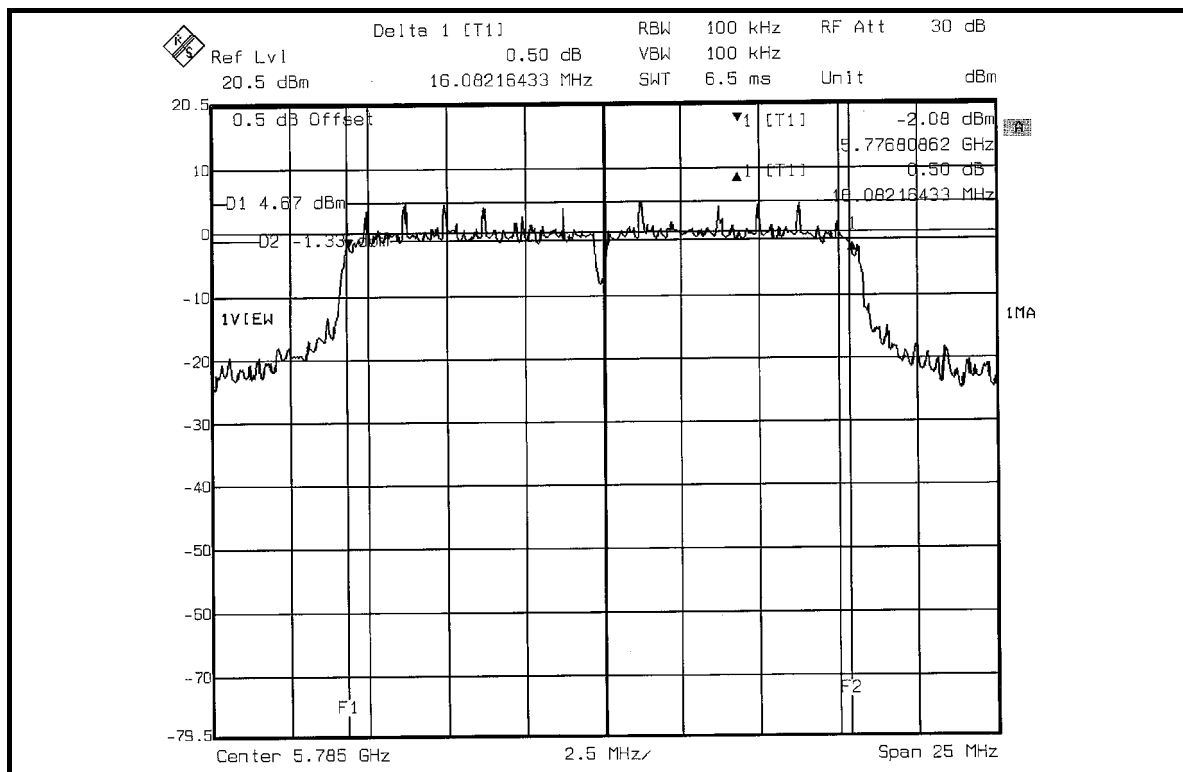

CH 5

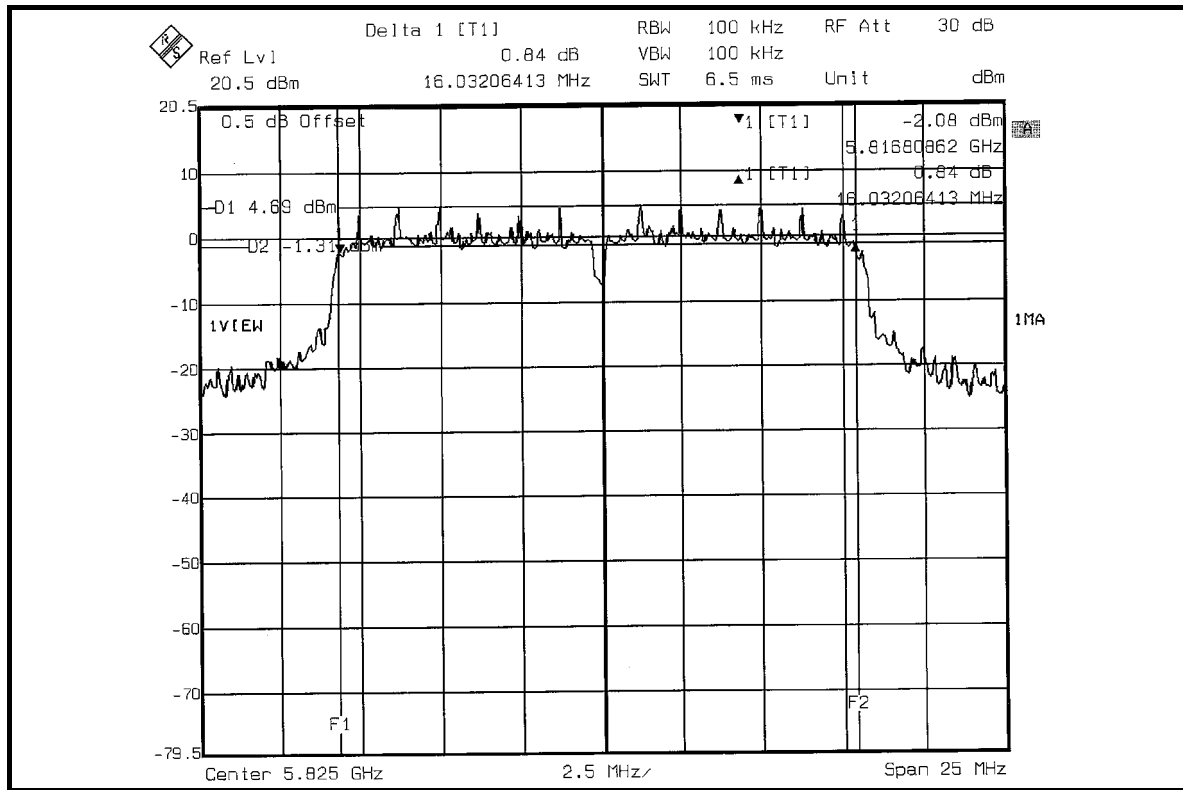



## 5.4 MAXIMUM PEAK OUTPUT POWER

### 5.4.1 LIMITS OF MAXIMUM PEAK OUTPUT POWER MEASUREMENT

The Maximum Peak Output Power Measurement is 30dBm.

### 5.4.2 INSTRUMENTS

Description & Manufacturer	Model No.	Serial No.	Calibrated Until
R&S SPECTRUM ANALYZER	FSP40	100040	Jun. 07, 2007
AGILENT SIGNAL GENERATOR	E8257C	MY43320668	Dec. 30, 2006
TEKTRONIX OSCILLOSCOPE	TDS 1012	C019167	Jan. 16, 2007
NARDA DETECTOR	4503A	FSCM99899	NA

**NOTE:**

The calibration interval of the above test instruments is 12 months and the calibrations are traceable to NML/ROC and NIST/USA..

### 5.4.3 TEST PROCEDURES

1. A detector was used on the output port of the EUT. An oscilloscope was used to read the response of the detector.
2. Replaced the EUT by the signal generator . The center frequency of the S.G was adjusted to the center frequency of the measured channel.
3. Adjusted the power to have the same reading on oscilloscope. Record the power level.

### 5.4.4 DEVIATION FROM TEST STANDARD

No deviation

### 5.4.5 TEST SETUP



### 5.4.6 EUT OPERATING CONDITIONS

Same as Item 5.3.6



### 5.4.7 TEST RESULTS

#### 802.11a OFDM modulation

<b>MODULATION TYPE</b>	BPSK	<b>TRANSFER RATE</b>	6Mbps
<b>INPUT POWER (SYSTEM)</b>	120Vac, 60 Hz	<b>ENVIRONMENTAL CONDITIONS</b>	25deg.C, 68%RH, 991hPa
<b>TESTED BY</b>	Brad Wu		

CHANNEL	CHANNEL FREQUENCY (MHz)	PEAK POWER OUTPUT (mW)	PEAK POWER OUTPUT (dBm)	PEAK POWER LIMIT (dBm)	PASS/FAIL
1	5745	50.582	17.04	30	PASS
3	5785	56.364	17.51	30	PASS
5	5825	56.494	17.52	30	PASS



## 5.5 POWER SPECTRAL DENSITY MEASUREMENT

### 5.5.1 LIMITS OF POWER SPECTRAL DENSITY MEASUREMENT

The Maximum of Power Spectral Density Measurement is 8dBm.

### 5.5.2 TEST INSTRUMENTS

Description & Manufacturer	Model No.	Serial No.	Calibrated Until
R&S SPECTRUM ANALYZER	FSP40	100040	Jun. 07, 2007

**NOTES:**

The calibration interval of the above test instruments is 12 months and the calibrations are traceable to NML/ROC and NIST/USA.

### 5.5.3 TEST PROCEDURE

The transmitter output was connected to the spectrum analyzer through an attenuator, the bandwidth of the fundamental frequency was measured with the spectrum analyzer using 3 kHz RBW and 30 kHz VBW, set sweep time = span/3 kHz. The power spectral density was measured and recorded.

The sweep time is allowed to be longer than span/3 kHz for a full response of the mixer in the spectrum analyzer.

### 5.5.4 DEVIATION FROM TEST STANDARD

No deviation

### 5.5.5 TEST SETUP

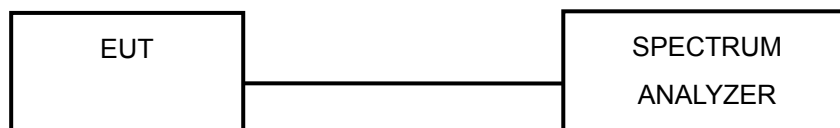

### 5.5.6 EUT OPERATING CONDITION

Same as Item 5.3.6



### 5.5.7 TEST RESULTS

#### 802.11a OFDM modulation

<b>MODULATION TYPE</b>	BPSK	<b>TRANSFER RATE</b>	6Mbps
<b>INPUT POWER (SYSTEM)</b>	120Vac, 60 Hz	<b>ENVIRONMENTAL CONDITIONS</b>	25deg.C, 68%RH, 991hPa
<b>TESTED BY</b>	Brad Wu		

<b>CHANNEL</b>	<b>CHANNEL FREQUENCY (MHz )</b>	<b>RF POWER LEVEL IN 3 kHz BW (dBm)</b>	<b>MAXIMUM LIMIT (dBm)</b>	<b>PASS/FAIL</b>
1	5745	-10.75	8	PASS
3	5785	-10.43	8	PASS
5	5825	-10.74	8	PASS



CH 1

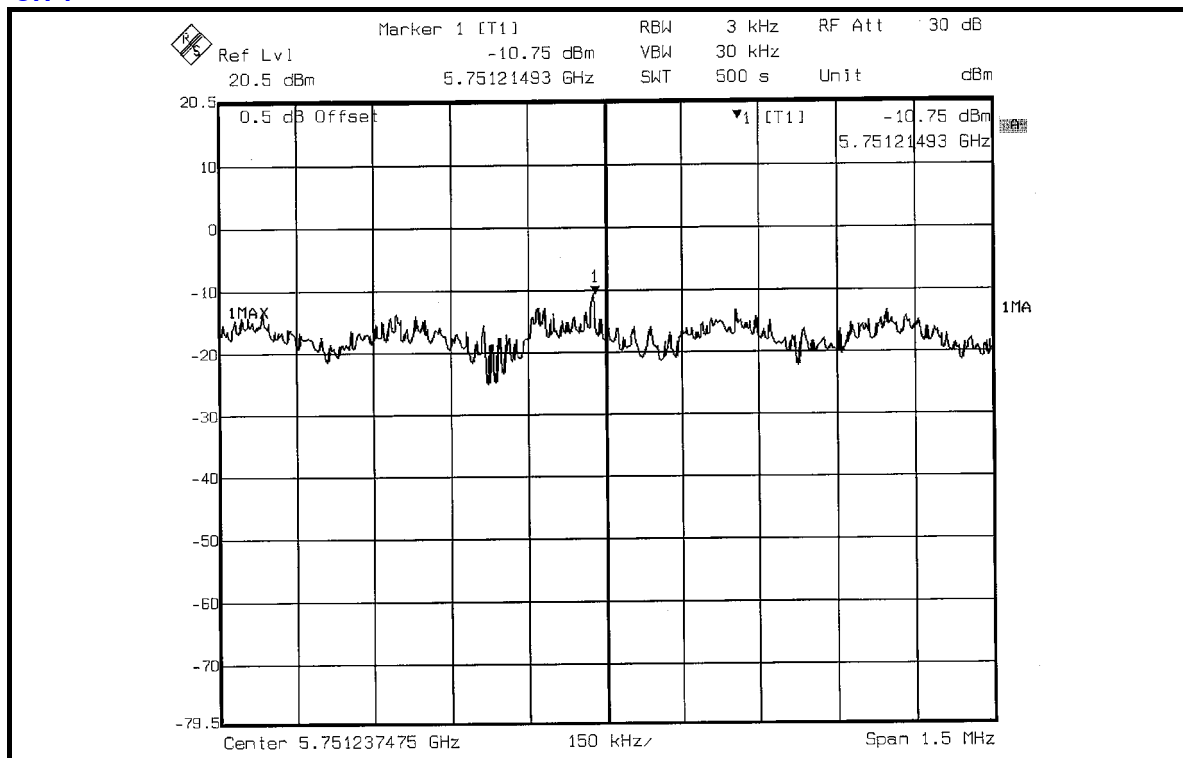

CH 3

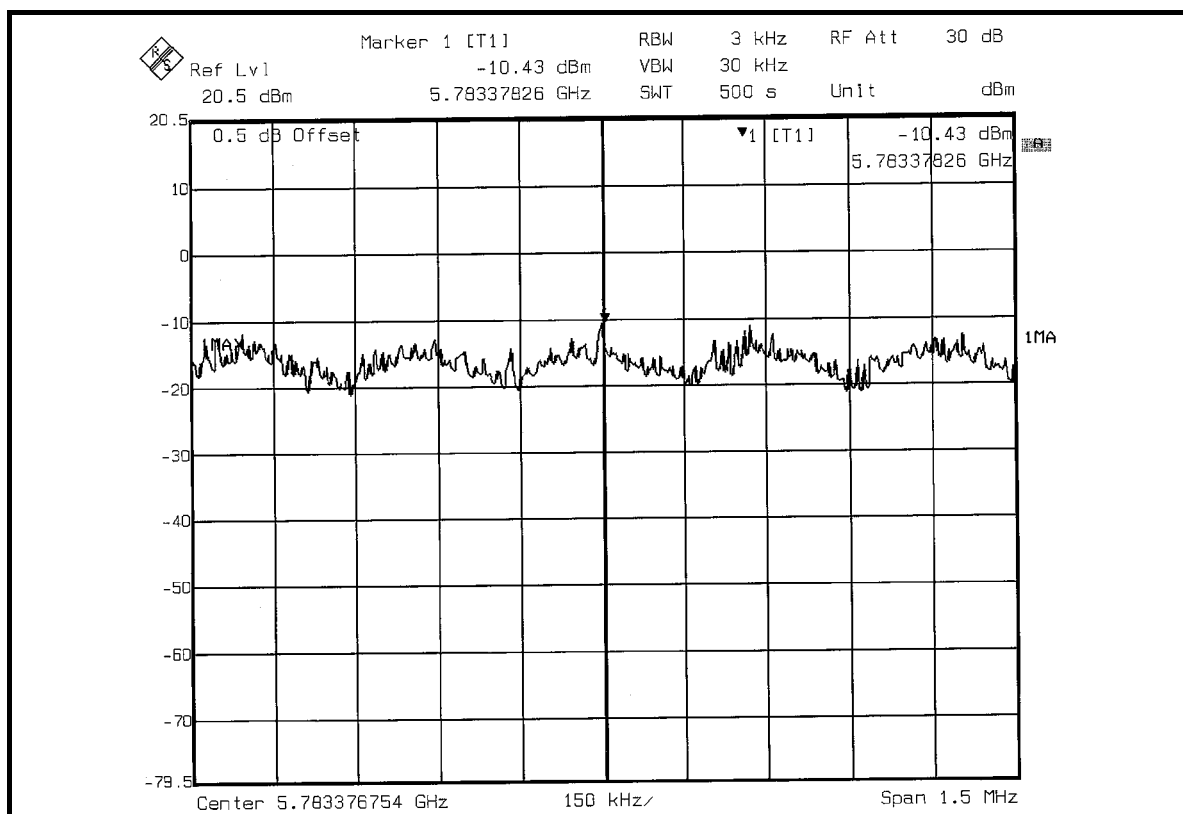

CH 5

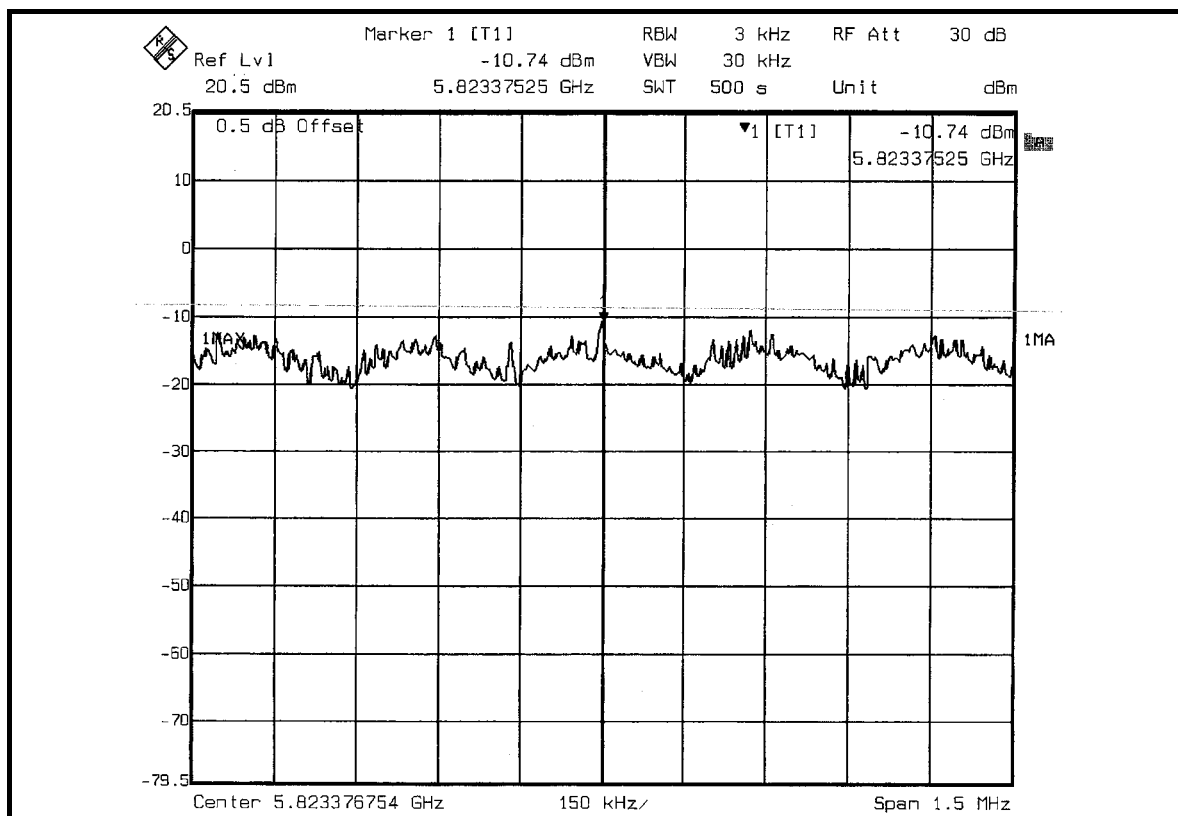

## 5.6 BAND EDGES MEASUREMENT

### 5.6.1 LIMITS OF BAND EDGES MEASUREMENT

Below -20dB of the highest emission level of operating band (in 100kHz Resolution Bandwidth).

### 5.6.2 TEST INSTRUMENTS

Description & Manufacturer	Model No.	Serial No.	Calibrated Until
R&S SPECTRUM ANALYZER	FSP40	100040	Jun. 07, 2007

#### NOTES:

The calibration interval of the above test instruments is 12 months and the calibrations are traceable to NML/ROC and NIST/USA.

### 5.6.3 TEST PROCEDURE

The transmitter output was connected to the spectrum analyzer via a low lose cable. Set both RBW and VBW of spectrum analyzer to 100 kHz with suitable frequency span including 100 MHz bandwidth from band edge. The band edges was measured and recorded.

### 5.6.4 DEVIATION FROM TEST STANDARD

No deviation

### 5.6.5 EUT OPERATING CONDITION

Same as Item 5.9.6

### 5.6.6 TEST RESULTS

The spectrum plots are attached on the following pages. D1 line indicates the highest level, D2 line indicates the 20dB offset below D1. It shows compliance with the requirement in part 15.247(d).

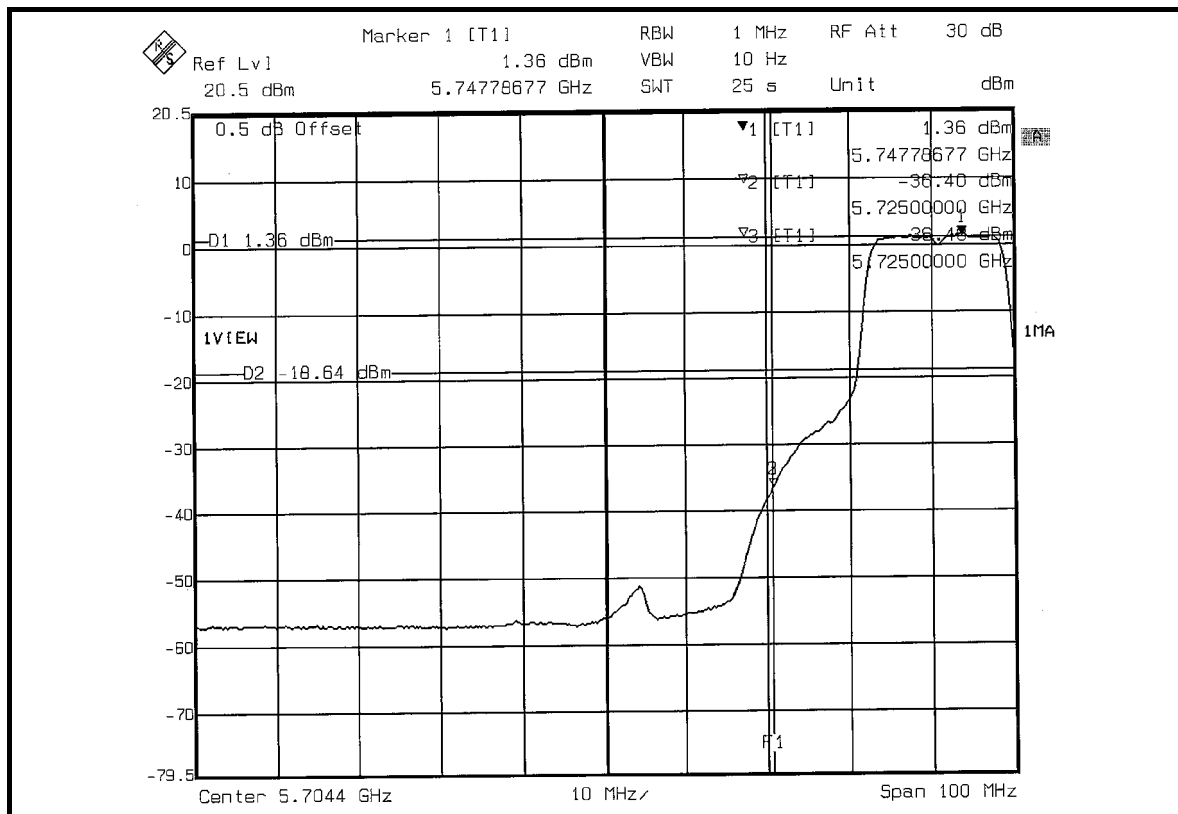
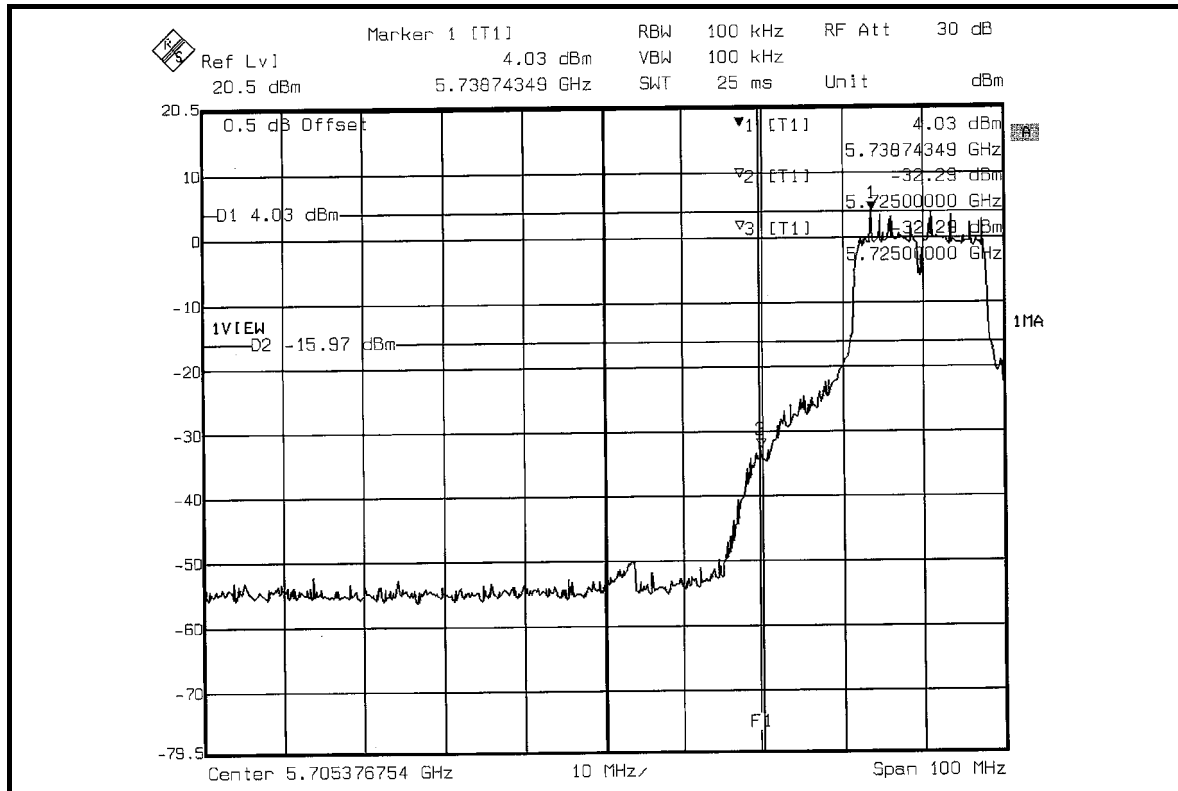

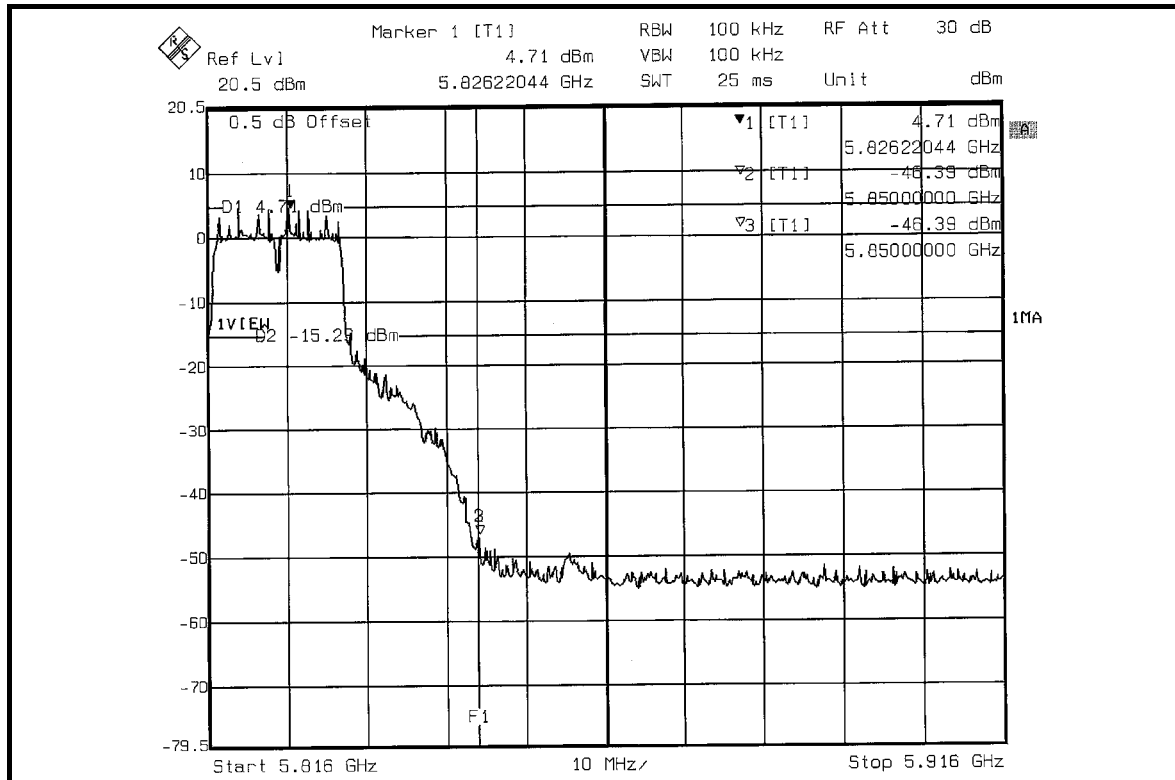
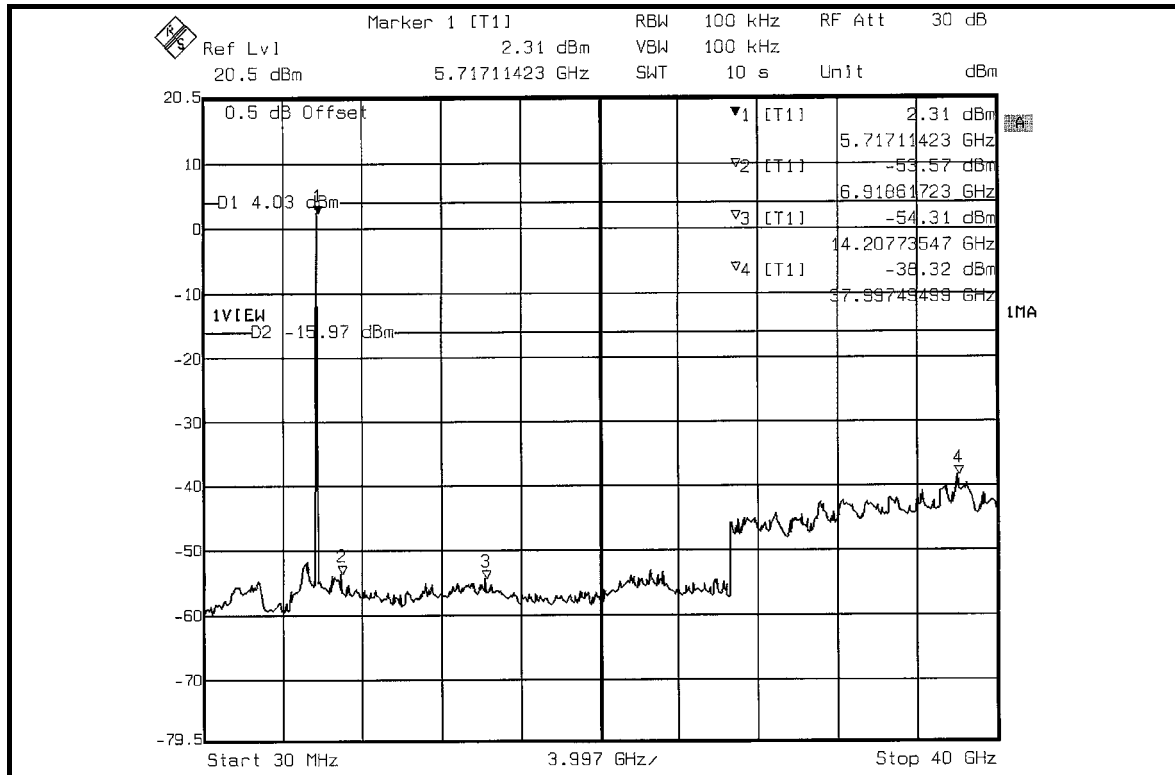

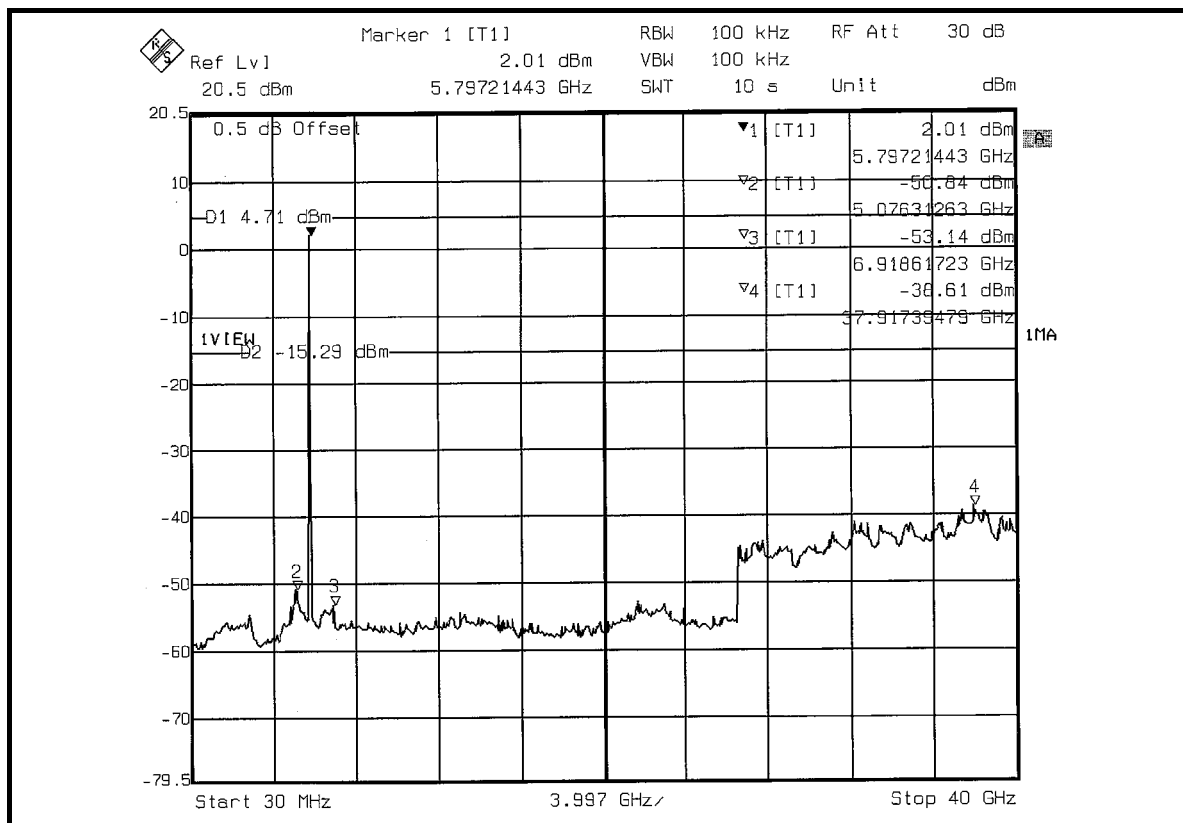
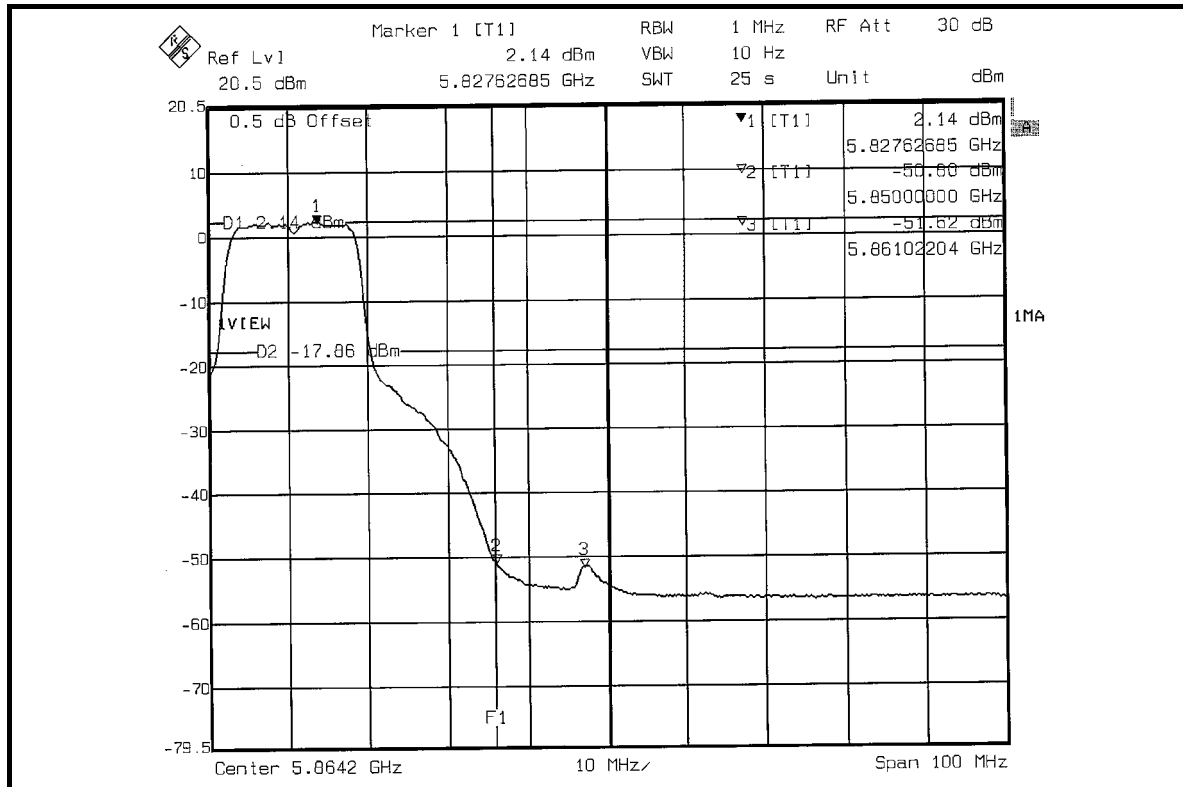



## **5.7 ANTENNA REQUIREMENT**

### **5.7.1 STANDARD APPLICABLE**

For intentional device, according to FCC 47 CFR Section 15.203, an intentional radiator shall be designed to ensure that no antenna other than that furnished by the responsible party shall be used with the device.

And according to FCC 47 CFR Section 15.247(a), if transmitting antennas of directional gain greater than 6dBi are used, the power shall be reduced by the amount in dB that the directional gain of the antenna exceeds 6dBi.

### **5.7.2 ANTENNA CONNECTED CONSTRUCTION**

The antenna used in this product is PIFA antenna with UFL connector. The maximum Gain of the antenna is 2.5dBi.





## 6. INFORMATION ON THE TESTING LABORATORIES

We, ADT Corp., were founded in 1988 to provide our best service in EMC, Radio, Telecom and Safety consultation. Our laboratories are accredited and approved by the following approval agencies according to ISO/IEC 17025.

<b>USA</b>	FCC, UL, A2LA
<b>Germany</b>	TUV Rheinland
<b>Japan</b>	VCCI
<b>Norway</b>	NEMKO
<b>Canada</b>	INDUSTRY CANADA , CSA
<b>R.O.C.</b>	CNLA, BSMI, DGT
<b>Netherlands</b>	Telefication
<b>Singapore</b>	PSB , GOST-ASIA(MOU)
<b>Russia</b>	CERTIS(MOU)

Copies of accreditation certificates of our laboratories obtained from approval agencies can be downloaded from our web site:

[www.adt.com.tw/index.5/phtml](http://www.adt.com.tw/index.5/phtml). If you have any comments, please feel free to contact us at the following:

**Linko EMC/RF Lab:**

Tel: 886-2-26052180

Fax: 886-2-26052943

**Hsin Chu EMC/RF Lab:**

Tel: 886-3-5935343

Fax: 886-3-5935342

**Hwa Ya EMC/RF/Safety Telecom Lab:**

Tel: 886-3-3183232

Fax: 886-3-3185050

**Web Site:** [www.adt.com.tw](http://www.adt.com.tw)

The address and road map of all our labs can be found in our web site also.



## **APPENDIX-A**

### **MODIFICATIONS RECORDERS FOR ENGINEERING CHANGES TO THE EUT BY THE LAB**

No any modifications are made to the EUT by the lab during the test.