



FCC TEST REPORT

(PART 15, SUBPART C, 15.407)

REPORT NO.: RF940825L08A
MODEL NO.: MC7094
RECEIVED: Aug. 24, 2005
TESTED: Sep. 22 ~ Oct. 17, 2005
ISSUED: Oct. 19, 2005

APPLICANT: Symbol Technologies, Inc.

ADDRESS: One Symbol Plaza, Holtsville, NY 11742-1300, U.S.A.

ISSUED BY: Advance Data Technology Corporation

LAB ADDRESS: No. 47, 14th Ling, Chia Pau Tsuen, Lin Kou Hsiang 244, Taipei Hsien, Taiwan, R.O.C.

TEST LOCATION: No. 19, Hwa Ya 2nd Rd., Wen Hwa Tsuen, Kwei Shan Hsiang, Taoyuan Hsien 333, Taiwan, R.O.C.

This test report consists of 61 pages in total. It may be duplicated completely for legal use with the approval of the applicant. It should not be reproduced except in full, without the written approval of our laboratory. The client should not use it to claim product endorsement by CNLA, A2LA or any government agencies. The test results in the report only apply to the tested sample.



0528
ILAC MRA



ACCREDITED
No. 2177-01



Table of Contents

1.	CERTIFICATION.....	4
2.	SUMMARY OF TEST RESULTS	5
2.1	MEASUREMENT uncertainty	6
3.	GENERAL INFORMATION	7
3.1	GENERAL DESCRIPTION OF EUT	7
3.2	DESCRIPTION OF TEST MODES	9
3.2.1	CONFIGURATION OF SYSTEM UNDER TEST	10
3.2.2	Test Mode Applicability and tested channel detail:	12
3.3	GENERAL DESCRIPTION OF APPLIED STANDARDS	14
3.4	DESCRIPTION OF SUPPORT UNITS	14
4.	TEST TYPES AND RESULTS	15
4.1	CONDUCTED EMISSION MEASUREMENT	15
4.1.1	LIMITS OF CONDUCTED EMISSION MEASUREMENT	15
4.1.2	TEST INSTRUMENTS	15
4.1.3	TEST PROCEDURES	16
4.1.4	DEVIATION FROM TEST STANDARD	16
4.1.5	TEST SETUP	17
4.1.6	EUT OPERATING CONDITIONS.....	17
4.1.7	TEST RESULTS	18
4.2	Radiated Emission Measurement.....	22
4.2.1	LIMITS OF RADIATED EMISSION MEASUREMENT	22
4.2.2	LIMITS OF UNWANTED EMISSION OUT OF THE RESTRICTED BANDS	23
4.2.3	TEST INSTRUMENTS	24
4.2.4	TEST PROCEDURES	25
4.2.5	DEVIATION FROM TEST STANDARD	25
4.2.6	TEST SETUP	26
4.2.7	EUT OPERATING CONDITION	26
4.2.8	Test RESULTS.....	27
4.3	Peak transmit power MEASUREMENT	34
4.3.1	LIMITS OF PEAK TRANSMIT POWER MEASUREMENT	34
4.3.2	TEST INSTRUMENTS	34
4.3.3	TEST PROCEDURE	35
4.3.4	DEVIATION FROM TEST STANDARD	35
4.3.5	TEST SETUP	35
4.3.6	EUT OPERATING CONDITIONS.....	35
4.3.7	TEST RESULTS	36
4.4	Peak power EXCURSION MEASUREMENT	41
4.4.1	LIMITS OF PEAK POWER EXCURSION MEASUREMENT	41



4.4.2	TEST INSTRUMENTS	41
4.4.3	TEST PROCEDURE	42
4.4.4	DEVIATION FROM TEST STANDARD	42
4.4.5	TEST SETUP	42
4.4.6	EUT OPERATING CONDITIONS.....	42
4.4.7	TEST RESULTS	43
4.5	PEAK power spectral density measurement	46
4.5.1	LIMITS OF PEAK POWER SPECTRAL DENSITY MEASUREMENT	46
4.5.2	TEST INSTRUMENTS	46
4.5.3	TEST PROCEDURES	47
4.5.4	DEVIATION FROM TEST STANDARD	47
4.5.5	TEST SETUP	47
4.5.6	EUT OPERATING CONDITIONS.....	47
4.5.7	TEST RESULTS	48
4.6	FREQUENCY STABILITY	51
4.6.1	LIMITS OF FREQUENCY STABILITY MEASUREMENT	51
4.6.2	TEST INSTRUMENTS	51
4.6.3	TEST PROCEDURE	51
4.6.4	DEVIATION FROM TEST STANDARD	51
4.6.5	TEST SETUP	52
4.6.6	EUT OPERATING CONDITION	52
4.6.7	TEST RESULTS	53
4.7	BAND EDGES MEASUREMENT	54
4.7.1	TEST INSTRUMENTS	54
4.7.2	TEST PROCEDURE	54
4.7.3	EUT OPERATING CONDITION	54
4.7.4	TEST RESULTS	54
4.8	ANTENNA REQUIREMENT	59
4.8.1	STANDARD APPLICABLE	59
4.8.2	ANTENNA CONNECTED CONSTRUCTION	59
5.	INFORMATION ON THE TESTING LABORATORIES.....	60



1. CERTIFICATION

PRODUCT: EDA (Enterprise Digital Assistant)
MODEL: MC7094
BRAND: Symbol
APPLICANT: Symbol Technologies, Inc.
TEST SAMPLE: PROTOTYPE
TESTED: Sep. 22 ~ Oct. 17, 2005
STANDARDS: FCC Part 15, Subpart E (Section 15.407)
ANSI C63.4-2003

The above equipment has been tested by **Advance Data Technology Corporation**, and found compliance with the requirement of the above standards. The test record, data evaluation & Equipment Under Test (EUT) configurations represented herein are true and accurate accounts of the measurements of the sample's EMC characteristics under the conditions specified in this report.

PREPARED BY : Rennie Wang , **DATE:** Oct. 19, 2005
Rennie Wang

TECHNICAL
ACCEPTANCE : Gary Chang , **DATE:** Oct. 19, 2005
Responsible for RF Gary Chang

APPROVED BY : Cody Chang , **DATE:** Oct. 19, 2005
Cody Chang / Deputy Manager



2. SUMMARY OF TEST RESULTS

The EUT has been tested according to the following specifications:

APPLIED STANDARD: FCC Part 15, Subpart E (Section 15.407)			
Standard Section	Test Type	Result	Remark
15.407(b)(5)	AC Power Conducted Emission	PASS	Meet the requirement of limit. Minimum passing margin is -13.70dB at 0.209MHz
15.407(b)(1/2/3) (b)(5)	Electric Field Strength Spurious Emissions, 30MHz ~ 40000MHz	PASS	Meet the requirement of limit. Minimum passing margin is -5.35dB at 5130.00MHz
15.407(a)(1/2/3)	Peak Transmit Power	PASS	Meet the requirement of limit.
15.407(a)(6)	Peak Power Excursion	PASS	Meet the requirement of limit.
15.407(a)(1/2/3)	Peak Power Spectral Density	PASS	Meet the requirement of limit.
15.407(g)	Frequency Stability	PASS	Meet the requirement of limit.



2.1 MEASUREMENT UNCERTAINTY

Where relevant, the following measurement uncertainty levels have been estimated for tests performed on the EUT as specified in CISPR 16-4:

MEASUREMENT	FREQUENCY	UNCERTAINTY
Conducted emissions	9kHz~30MHz	2.44 dB
Radiated emissions	30MHz ~ 200MHz	3.55 dB
	200MHz ~1000MHz	3.58 dB
	1GHz ~ 18GHz	1.10 dB
	18GHz ~ 40GHz	0.91 dB

This uncertainty represents an expanded uncertainty expressed at approximately the 95% confidence level using a coverage factor of k=2.



3. GENERAL INFORMATION

3.1 GENERAL DESCRIPTION OF EUT

EUT	EDA (Enterprise Digital Assistant)
MODEL NO.	MC7094
POWER SUPPLY	3.7Vdc from rechargeable lithium battery 5.4Vdc from power adapter for charger 12.0Vdc from power adapter for cradle
MODULATION TYPE	64QAM, 16QAM, QPSK, BPSK
MODULATION TECHNOLOGY	OFDM
TRANSFER RATE	54/48/36/24/18/12/9/6Mbps
FREQUENCY RANGE	5.180 ~ 5.320GHz
NUMBER OF CHANNEL	8
CHANNEL SPACING	20MHz
OUTPUT POWER	26.977mW
ANTENNA TYPE	PIFA antenna with 2.5dBi gain
DATA CABLE	0.92m non-shielded cable for earphone
I/O PORTS	Refer to user's manual
ASSOCIATED DEVICES	Earphone, cradle

NOTE:

- The EUT is an EDA (Enterprise Digital Assistant) with wireless LAN, bluetooth and mobile phone function. This report is only covered the functions of wireless LAN. The mobile phone function is covered in another two test reports, which standards used are FCC Part 24 and FCC Part 22. The bluetooth function is covered in another test report, which standards used is FCC Part 15, Subpart C (section 15.247).
- The wireless LAN included two dual band antennas. After pre-testing both primary and auxiliary antennas, the former as the worst case, was chosen for final test.
- The EDA supports two battery options, Heavy (high capacity) and Main (normal). Both options were assessed and the heavy battery was found to be worst case and was selected for the final test configuration.

HEAVY BATTERY:	
BRAND:	Symbol
MODEL:	82-71364-01
RATING:	3.7Vdc, 3800 mAh

MAIN BATTERY:	
BRAND:	Symbol
MODEL:	82-71363-01
RATING:	3.7Vdc, 1900 mAh



4. The cradle was operated with following power adapter:

BRAND:	HIPRO
MODEL:	HP-O2040D43
INPUT:	100-240Vac, 50-60Hz, 1.5A
OUTPUT:	12Vdc, 3.33A
POWER LINE:	AC 1.8m non-shielded cable without core DC 1.8m non-shielded cable with one core

5. The EUT was operated with following charging cradle:

BRAND:	Delta
MODEL:	ADP-16GB A
INPUT:	100-240Vac, 50-60Hz, 0.4A
OUTPUT:	5.4Vdc, 3A
POWER LINE:	AC 0.7m non-shielded cable without core DC 1.87m non-shielded cable with one core

6. The EUT operates in 5GHz Bands and compatibility with 802.11a technology.

7. The above EUT information was declared by the manufacturer and for more detailed features description, please refer to the manufacturer's specifications or User's Manual.



3.2 DESCRIPTION OF TEST MODES

Since the EUT is considered a portable unit, it was pre-tested on the positioned of each 3 axis. The worst case was found when positioned on X-plane. Therefore only the test data of this X-plane was used for radiated test.

Operated in 5180 ~ 5320MHz

8 channels are provided to this EUT.

CHANNEL	FREQUENCY
1	5180 MHz
2	5200 MHz
3	5220 MHz
4	5240 MHz
5	5260 MHz
6	5280 MHz
7	5300 MHz
8	5320 MHz

3.2.1 CONFIGURATION OF SYSTEM UNDER TEST

Mode 1

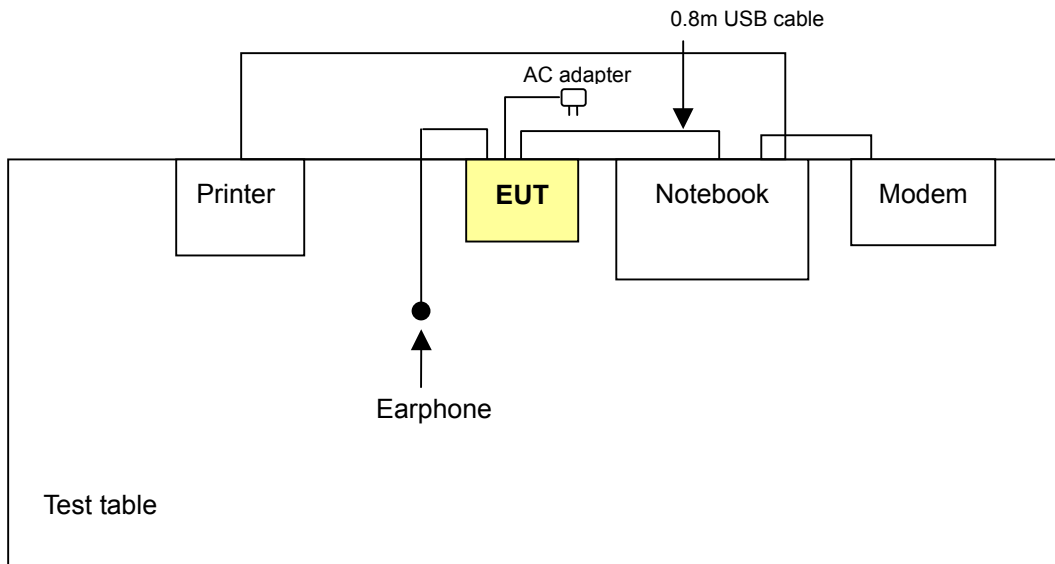

Mode 2

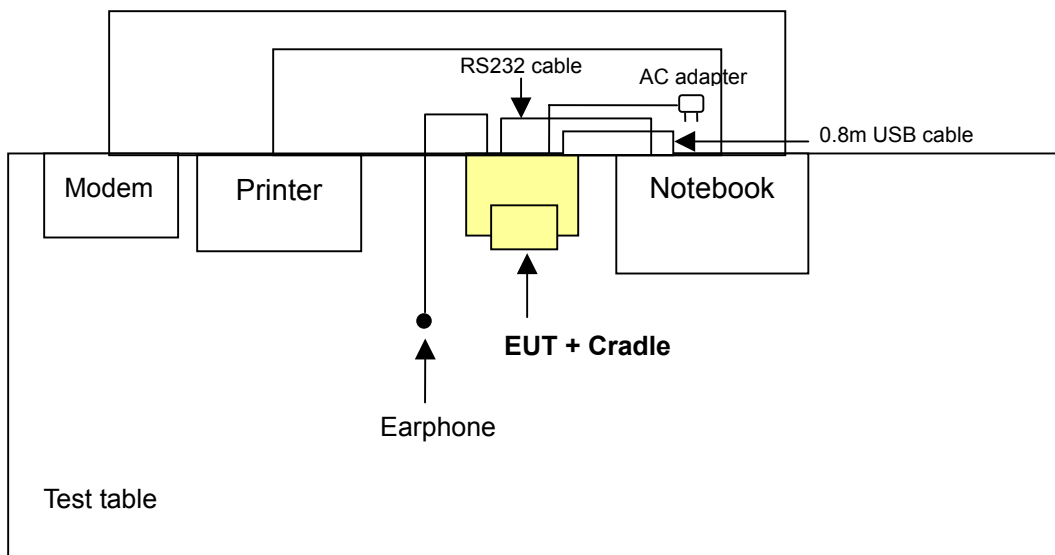

Mode 3

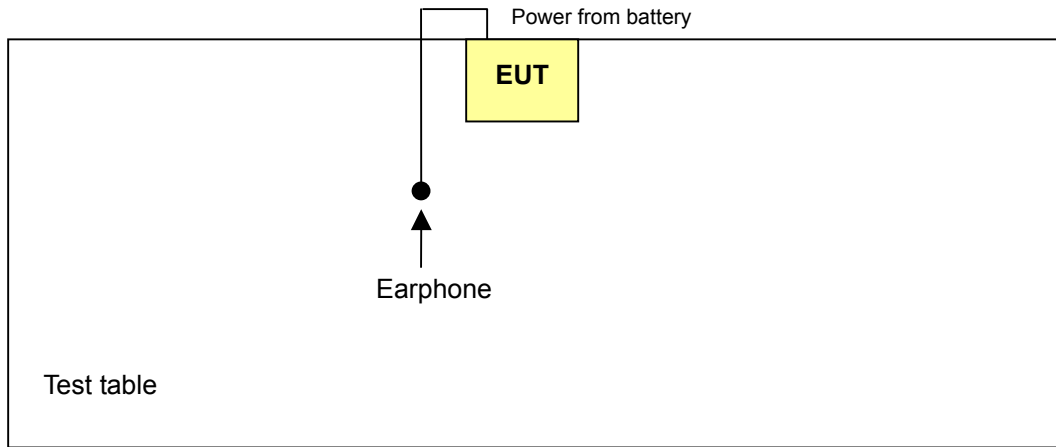



Radiated Emission Test (Below 1 GHz):

- Pre-Scan has been conducted to determine the worst-case mode from all possible combinations between available modulations, data rates, antenna ports (if EUT with antenna diversity architecture), and X, Y and Z Axis.
- Following channel(s) was (were) selected for the final test as listed below.

EUT CONFIGURE MODE	MODE	AVAILABLE CHANNEL	TESTED CHANNEL	MODULATION TECHNOLOGY	MODULATION TYPE	DATA RATE (Mbps)	AXIS
A	802.11a	1 to 8	5	OFDM	BPSK	6	X
B	802.11a	1 to 8	5	OFDM	BPSK	6	-
C	802.11a	1 to 8	5	OFDM	BPSK	6	X

Radiated Emission Test (Above 1 GHz):

- Pre-Scan has been conducted to determine the worst-case mode from all possible combinations between available modulations, data rates and antenna ports (if EUT with antenna diversity architecture), and X, Y and Z Axis.
- Following channel(s) was (were) selected for the final test as listed below.

EUT CONFIGURE MODE	MODE	AVAILABLE CHANNEL	TESTED CHANNEL	MODULATION TECHNOLOGY	MODULATION TYPE	DATA RATE (Mbps)	AXIS
A	802.11a	1 to 8	1, 4, 5, 8	OFDM	BPSK	6	X

Bandedge Measurement:

- Pre-Scan has been conducted to determine the worst-case mode from all possible combinations between available modulations, data rates and antenna ports (if EUT with antenna diversity architecture).
- Following channel(s) was (were) selected for the final test as listed below.

MODE	AVAILABLE CHANNEL	TESTED CHANNEL	MODULATION TECHNOLOGY	MODULATION TYPE	DATA RATE (Mbps)
802.11a	1 to 12	1, 8	OFDM	BPSK	6

Antenna Port Conducted Measurement:

- Pre-Scan has been conducted to determine the worst-case mode from all possible combinations between available modulations, data rates and antenna ports (if EUT with antenna diversity architecture).
- Following channel(s) was (were) selected for the final test as listed below.

MODE	AVAILABLE CHANNEL	TESTED CHANNEL	MODULATION TECHNOLOGY	MODULATION TYPE	DATA RATE (Mbps)
802.11a	1 to 12	1, 4, 5, 8	OFDM	BPSK	6



3.3 GENERAL DESCRIPTION OF APPLIED STANDARDS

The EUT is a RF product. According to the specifications of the manufacturer, it must comply with the requirements of the following standards:

FCC Part 15, Subpart E (15.407)

ANSI C63.4-2003

All test items have been performed and recorded as per the above standards.

NOTE: The EUT is also considered as a kind of computer peripheral, because the connection to computer is necessary for typical use. It has been verified to comply with the requirements of FCC Part 15, Subpart B, Class B (DoC). The test report has been issued separately.

3.4 DESCRIPTION OF SUPPORT UNITS

The EUT has been tested as an independent unit together with other necessary accessories or support units. The following support units or accessories were used to form a representative test configuration during the tests.

NO.	PRODUCT	BRAND	MODEL NO.	SERIAL NO.	FCC ID
1	NOTEBOOK COMPUTER	DELL	PP05L	16484462992	E2K24CLNS
2	MODEM	ACEEX	1414V/3	0401008269	IFAXDM1414
3	PRINTER	EPSON	LQ-300+	DCGY054147	FCC DoC Approved

NO.	SIGNAL CABLE DESCRIPTION OF THE ABOVE SUPPORT UNITS
1	NA
2	1.8 m shielded cable without core
3	1.2 m shielded cable without core

NOTE: All power cords of the above support units are non shielded (1.8m).



4. TEST TYPES AND RESULTS

4.1 CONDUCTED EMISSION MEASUREMENT

4.1.1 LIMITS OF CONDUCTED EMISSION MEASUREMENT

FREQUENCY OF EMISSION (MHz)	CONDUCTED LIMIT (dB μ V)	
	Quasi-peak	Average
0.15-0.5	66 to 56	56 to 46
0.5-5	56	46
5-30	60	50

- NOTE:**
1. The lower limit shall apply at the transition frequencies.
 2. The limit decreases in line with the logarithm of the frequency in the range of 0.15 to 0.50 MHz.
 3. All emanations from a class A/B digital device or system, including any network of conductors and apparatus connected thereto, shall not exceed the level of field strengths specified above.

4.1.2 TEST INSTRUMENTS

DESCRIPTION & MANUFACTURER	MODEL NO.	SERIAL NO.	CALIBRATED UNTIL
Test Receiver ROHDE & SCHWARZ	ESCS30	100288	Nov. 06, 2005
RF signal cable Woken	5D-FB	Cable-HyC02-01	Jan. 09, 2006
LISN ROHDE & SCHWARZ	ESH2-Z5	100100	Jan. 20, 2006
LISN ROHDE & SCHWARZ	ESH3-Z5	100311	Jan. 20, 2006
Software ADT	ADT_Cond_V3	NA	NA

- NOTE:**
1. The calibration interval of the above test instruments is 12 months and the calibrations are traceable to NML/ROC and NIST/USA.
 2. The test was performed in HwaYa Shielded Room 3.
 3. The VCCI Site Registration No. is C-2047.



4.1.3 TEST PROCEDURES

- a. The EUT was placed 0.4 meters from the conducting wall of the shielded room with EUT being connected to the power mains through a line impedance stabilization network (LISN). Other support units were connected to the power mains through another LISN. The two LISNs provide 50 ohm/ 50uH of coupling impedance for the measuring instrument.
- b. Both lines of the power mains connected to the EUT were checked for maximum conducted interference.
- c. The frequency range from 150kHz to 30MHz was searched. Emission levels under (Limit - 20dB) was not recorded.

4.1.4 DEVIATION FROM TEST STANDARD

No deviation

4.1.5 TEST SETUP

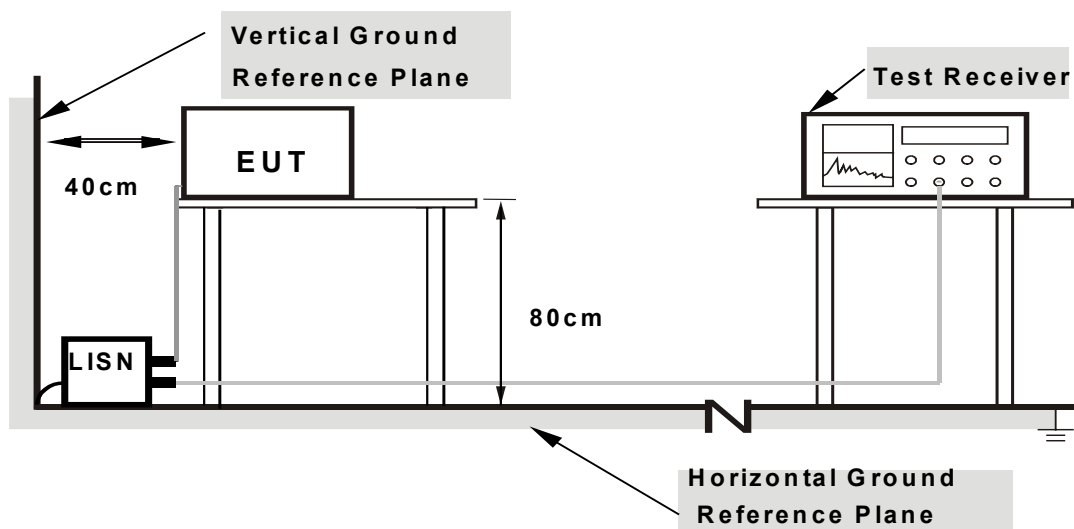

Note: 1. Support units were connected to second LISN.

2. Both of LISNs (AMN) are 80 cm from EUT and at least 80 from other units and other metal planes

For the actual test configuration, please refer to the related item – Photographs of the Test Configuration.

4.1.6 EUT OPERATING CONDITIONS

- Connected the EUT to notebook system placed on a testing table.
- The EUT ran a test program (provided by manufacturer) to enable EUT under transmission/receiving condition continuously at specific channel frequency.
- The notebook system sent "H" messages to its screen.
- The notebook system sent "H" messages to its modem.
- The notebook system sent "H" messages to printer and the printer printed them on paper.
- Steps c ~ e were repeated.



4.1.7 TEST RESULTS

Conducted Worst-Case Data_with charging cable

EUT	EDA (Enterprise Digital Assistant)	MEASUREMENT DETAIL	
MODEL	MC7094	PHASE	Line 1
CHANNEL	Channel 5	6dB BANDWIDTH	9 kHz
MODULATION TYPE	BPSK	ENVIRONMENTAL CONDITIONS	25deg. C, 65%RH, 991hPa
TRANSFER RATE	6Mbps	INPUT POWER (SYSTEM)	120Vac, 60 Hz
TESTED BY	Jay Hsu	TEST MODE	A

No	Freq. [MHz]	Corr. Factor (dB)	Reading Value		Emission Level		Limit		Margin	
			[dB (uV)]		[dB (uV)]		[dB (uV)]		(dB)	
			Q.P.	AV.	Q.P.	AV.	Q.P.	AV.	Q.P.	AV.
1	0.184	0.11	43.05	-	43.16	-	64.32	54.32	-21.16	-
2	0.254	0.11	34.57	-	34.68	-	61.61	51.61	-26.93	-
3	0.326	0.12	30.29	-	30.41	-	59.56	49.56	-29.15	-
4	0.486	0.14	24.04	-	24.18	-	56.24	46.24	-32.06	-
5	0.799	0.19	22.57	-	22.76	-	56.00	46.00	-33.24	-
6	2.635	0.26	32.26	-	32.52	-	56.00	46.00	-23.48	-

- REMARKS:**
1. Q.P. and AV. are abbreviations of quasi-peak and average individually.
 2. "-": The Quasi-peak reading value also meets average limit and measurement with the average detector is unnecessary.
 3. The emission levels of other frequencies were very low against the limit.
 4. Margin value = Emission level - Limit value
 5. Correction factor = Insertion loss + Cable loss
 6. Emission Level = Correction Factor + Reading Value.

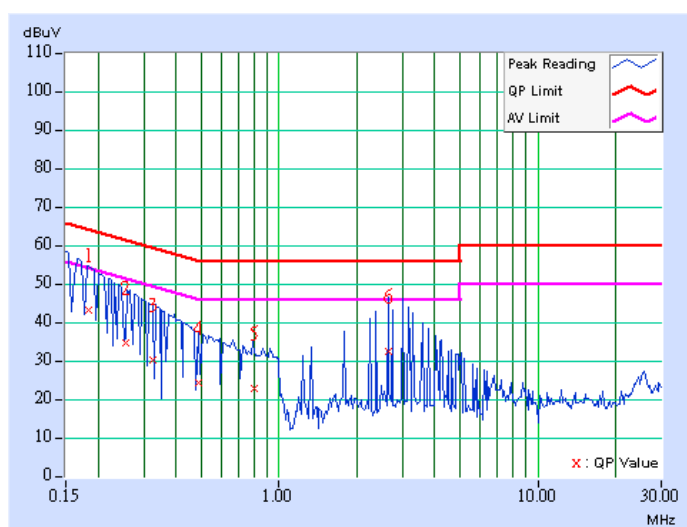



EUT	EDA (Enterprise Digital Assistant)	MEASUREMENT DETAIL	
MODEL	MC7094	PHASE	Line 2
CHANNEL	Channel 5	6dB BANDWIDTH	9 kHz
MODULATION TYPE	BPSK	ENVIRONMENTAL CONDITIONS	25deg. C, 65%RH, 991hPa
TRANSFER RATE	6Mbps	INPUT POWER (SYSTEM)	120Vac, 60 Hz
TESTED BY	Jay Hsu	TEST MODE	A

No	Freq. [MHz]	Corr. Factor (dB)	Reading Value		Emission Level		Limit		Margin	
			[dB (uV)]		[dB (uV)]		[dB (uV)]		(dB)	
			Q.P.	AV.	Q.P.	AV.	Q.P.	AV.	Q.P.	AV.
1	0.188	0.11	43.03	-	43.14	-	64.15	54.15	-21.01	-
2	0.246	0.11	35.58	-	35.69	-	61.88	51.88	-26.19	-
3	0.318	0.12	30.62	-	30.74	-	59.76	49.76	-29.02	-
4	0.452	0.13	24.49	-	24.62	-	56.84	46.84	-32.22	-
5	0.668	0.17	22.47	-	22.64	-	56.00	46.00	-33.36	-
6	2.727	0.26	33.33	-	33.59	-	56.00	46.00	-22.41	-

- REMARKS:**
1. Q.P. and AV. are abbreviations of quasi-peak and average individually.
 2. "-": The Quasi-peak reading value also meets average limit and measurement with the average detector is unnecessary.
 3. The emission levels of other frequencies were very low against the limit.
 4. Margin value = Emission level - Limit value
 5. Correction factor = Insertion loss + Cable loss
 6. Emission Level = Correction Factor + Reading Value.

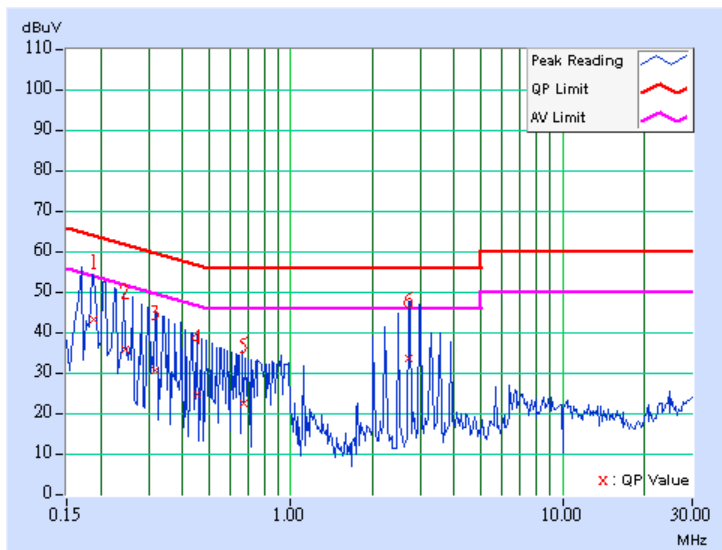



Conducted Worst-Case Data_with cradle

EUT	EDA (Enterprise Digital Assistant)	MEASUREMENT DETAIL	
MODEL	MC7094	PHASE	Line 1
CHANNEL	Channel 5	6dB BANDWIDTH	9 kHz
MODULATION TYPE	BPSK	ENVIRONMENTAL CONDITIONS	25deg. C, 65%RH, 991hPa
TRANSFER RATE	6Mbps	INPUT POWER (SYSTEM)	120Vac, 60 Hz
TESTED BY	Jay Hsu	TEST MODE	B

No	Freq. [MHz]	Corr. Factor (dB)	Reading Value		Emission Level		Limit		Margin	
			[dB (uV)]		[dB (uV)]		[dB (uV)]		(dB)	
			Q.P.	AV.	Q.P.	AV.	Q.P.	AV.	Q.P.	AV.
1	0.209	0.11	49.45	-	49.56	-	63.26	53.26	-13.70	-
2	0.420	0.11	34.99	-	35.10	-	57.46	47.46	-22.35	-
3	4.492	0.40	39.91	-	40.31	-	56.00	46.00	-15.69	-
4	7.938	0.49	28.98	-	29.47	-	60.00	50.00	-30.53	-
5	18.906	0.93	24.06	-	24.99	-	60.00	50.00	-35.01	-
6	24.543	1.32	26.23	-	27.55	-	60.00	50.00	-32.45	-

- REMARKS:**
1. Q.P. and AV. are abbreviations of quasi-peak and average individually.
 2. "-": The Quasi-peak reading value also meets average limit and measurement with the average detector is unnecessary.
 3. The emission levels of other frequencies were very low against the limit.
 4. Margin value = Emission level - Limit value
 5. Correction factor = Insertion loss + Cable loss
 6. Emission Level = Correction Factor + Reading Value.

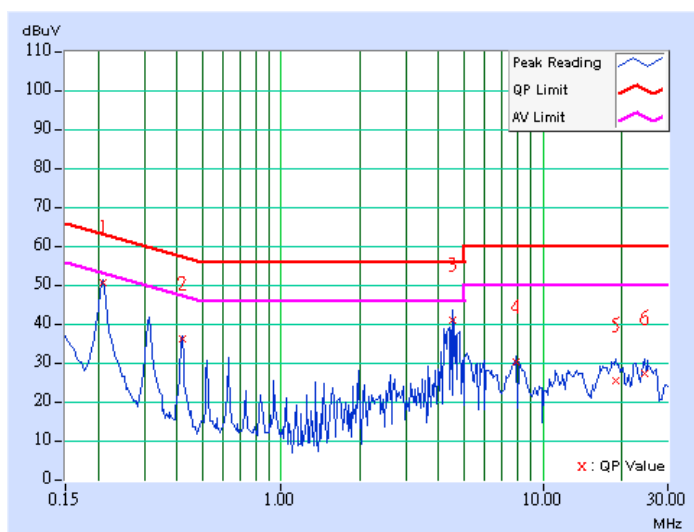



EUT	EDA (Enterprise Digital Assistant)	MEASUREMENT DETAIL	
MODEL	MC7094	PHASE	Line 2
CHANNEL	Channel 5	6dB BANDWIDTH	9 kHz
MODULATION TYPE	BPSK	ENVIRONMENTAL CONDITIONS	25deg. C, 65%RH, 991hPa
TRANSFER RATE	6Mbps	INPUT POWER (SYSTEM)	120Vac, 60 Hz
TESTED BY	Jay Hsu	TEST MODE	B

No	Freq. [MHz]	Corr. Factor (dB)	Reading Value		Emission Level		Limit		Margin	
			[dB (uV)]		[dB (uV)]		[dB (uV)]		(dB)	
			Q.P.	AV.	Q.P.	AV.	Q.P.	AV.	Q.P.	AV.
1	0.209	0.11	48.24	-	48.35	-	63.26	53.26	-14.91	-
2	0.420	0.11	34.44	-	34.55	-	57.46	47.46	-22.90	-
3	1.984	0.26	29.26	-	29.52	-	56.00	46.00	-26.48	-
4	4.176	0.39	38.74	-	39.13	-	56.00	46.00	-16.87	-
5	7.721	0.42	25.14	-	25.56	-	60.00	50.00	-34.44	-
6	16.910	0.56	27.14	-	27.70	-	60.00	50.00	-32.30	-

- REMARKS:**
1. Q.P. and AV. are abbreviations of quasi-peak and average individually.
 2. "-": The Quasi-peak reading value also meets average limit and measurement with the average detector is unnecessary.
 3. The emission levels of other frequencies were very low against the limit.
 4. Margin value = Emission level - Limit value
 5. Correction factor = Insertion loss + Cable loss
 6. Emission Level = Correction Factor + Reading Value.

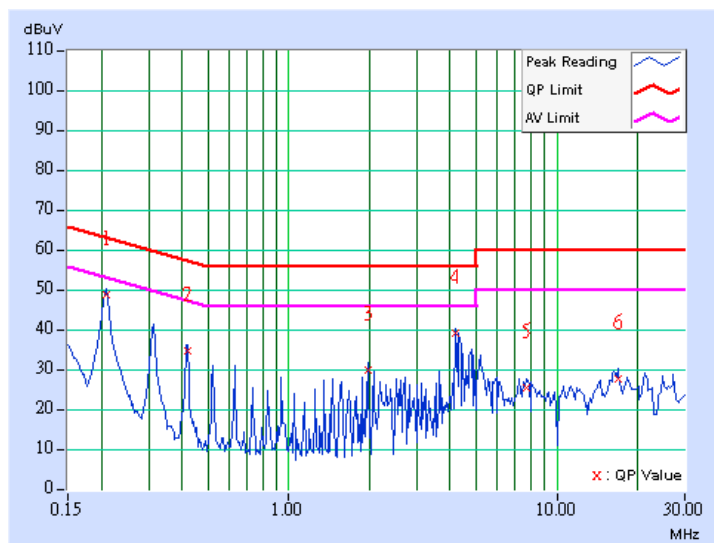



4.2 RADIATED EMISSION MEASUREMENT

4.2.1 LIMITS OF RADIATED EMISSION MEASUREMENT

Emissions radiated outside of the specified bands, shall be according to the general radiated limits in 15.209 as following:

Frequencies (MHz)	Field strength (microvolts/meter)	Measurement distance (meters)
0.009-0.490	2400/F(kHz)	300
0.490-1.705	24000/F(kHz)	30
1.705-30.0	30	30
30-88	100	3
88-216	150	3
216-960	200	3
Above 960	500	3

NOTE:

1. The lower limit shall apply at the transition frequencies.
2. Emission level (dBuV/m) = 20 log Emission level (uV/m).
3. As shown in 15.35(b), for frequencies above 1000MHz, the field strength limits are based on average detector, however, the peak field strength of any emission shall not exceed the maximum permitted average limits, specified above by more than 20dB under any condition of modulation.



4.2.2 LIMITS OF UNWANTED EMISSION OUT OF THE RESTRICTED BANDS

Frequencies (MHz)	EIRP Limit (dBm)	Equivalent Field Strength at 3m (dBμV/m) *note 3
5150~5250	-27	68.3
5250~5350	-27	68.3
5725~5825	-27 *note 1	68.3
	-17 *note 2	78.3

NOTE:

1. For frequencies 10MHz or greater above or below the band edge.
2. All emissions within the frequency range from the band edge to 10MHz above or below the band edge.
3. The following formula is used to convert the equipment isotropic radiated power (eirp) to field strength

$$E = \frac{1000000\sqrt{30P}}{3} \mu\text{V/m, where P is the eirp (Watts)}$$



4.2.3 TEST INSTRUMENTS

DESCRIPTION & MANUFACTURER	MODEL NO.	SERIAL NO.	CALIBRATED UNTIL
Test Receiver ROHDE & SCHWARZ	ESIB7	100188	Dec. 19, 2005
Spectrum Analyzer ROHDE & SCHWARZ	FSP40	100039	Nov. 21, 2005
BILOG Antenna SCHWARZBECK	VULB9168	9168-157	Jan. 22, 2006
HORN Antenna SCHWARZBECK	BBHA 9120 D	9120D-407	Jan. 16, 2006
HORN Antenna SCHWARZBECK	BBHA 9170	BBHA 9170241	Feb. 23, 2006
Preamplifier Agilent	8449B	3008A01961	Nov. 09, 2005
Preamplifier Agilent	8447D	2944A10629	Nov. 09, 2005
RF signal cable HUBER+SUHNER	SUCOFLEX 104	218182/4	Feb. 17, 2006
RF signal cable HUBER+SUHNER	SUCOFLEX 104	218194/4	Feb. 17, 2006
Software ADT.	ADT_Radiated_V5.14	NA	NA
Antenna Tower ADT.	AT100	AT93021702	NA
Turn Table ADT.	TT100.	TT93021702	NA
Controller ADT.	SC100.	SC93021702	NA
26GHz ~ 40GHz Amplifier	AMF-6F-2600400	923362	Mar. 13, 2006

- NOTE:**
1. The calibration interval of the above test instruments is 12 months and the calibrations are traceable to NML/ROC and NIST/USA.
 2. The test was performed in HwaYa Chamber 1.
 3. The horn antenna and HP preamplifier (model: 8449B) are used only for the measurement of emission frequency above 1GHz if tested.
 4. The IC Site Registration No. is IC4924-2.



4.2.4 TEST PROCEDURES

- a. The EUT was placed on the top of a rotating table 0.8 meters above the ground at a 3 meter semi-anechoic chamber. The table was rotated 360 degrees to determine the position of the highest radiation.
- b. The EUT was set 3 meters away from the interference-receiving antenna, which was mounted on the top of a variable-height antenna tower.
- c. The antenna is a broadband antenna, and its height is varied from one meter to four meters above the ground to determine the maximum value of the field strength. Both horizontal and vertical polarizations of the antenna are set to make the measurement.
- d. For each suspected emission, the EUT was arranged to its worst case and then the antenna was tuned to heights from 1 meter to 4 meters and the rotatable table was turned from 0 degrees to 360 degrees to find the maximum reading.
- e. The test-receiver system was set to Peak Detect Function and Specified Bandwidth with Maximum Hold Mode.
- f. If the emission level of the EUT in peak mode was 10dB lower than the limit specified, then testing could be stopped and the peak values of the EUT would be reported. Otherwise the emissions that did not have 10dB margin would be re-tested one by one using peak, quasi-peak or average method as specified and then reported in a data sheet.

NOTE:

1. The resolution bandwidth and video bandwidth of test receiver/spectrum analyzer is 120kHz for Peak detection (PK) and Quasi-peak detection (QP) at frequency below 1GHz.
2. The resolution bandwidth and video bandwidth of test receiver/spectrum analyzer is 1 MHz for Peak detection at frequency above 1GHz.
3. The resolution bandwidth of test receiver/spectrum analyzer is 1 MHz and the video bandwidth is 10 Hz for Average detection (AV) at frequency above 1GHz.

4.2.5 DEVIATION FROM TEST STANDARD

No deviation

4.2.6 TEST SETUP

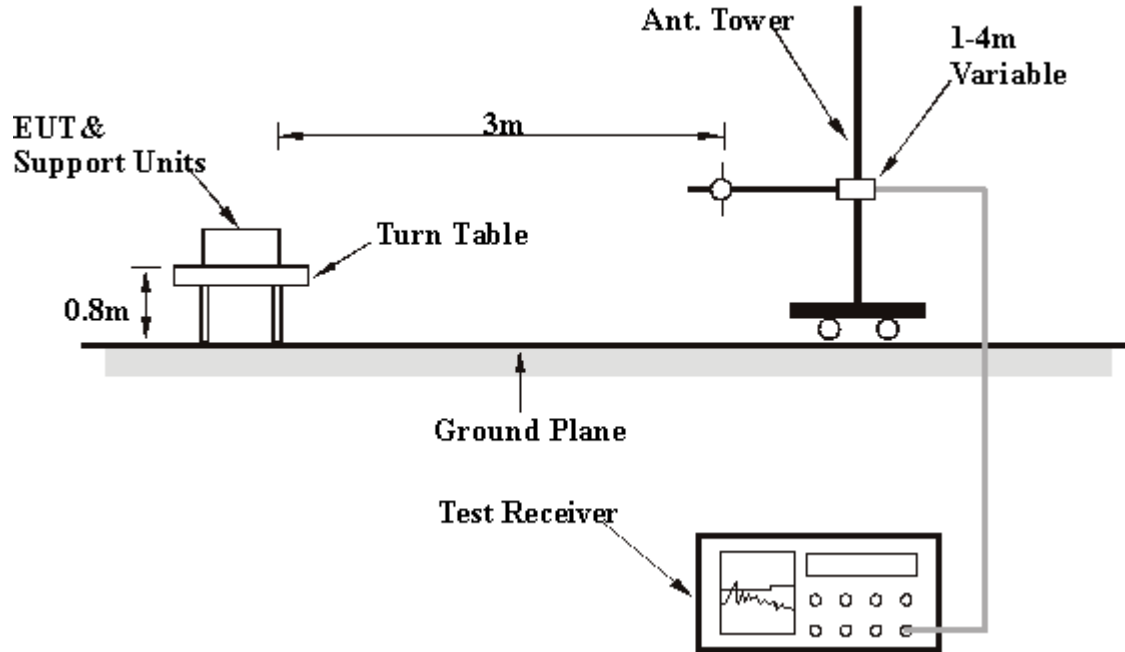

For the actual test configuration, please refer to the related item – Photographs of the Test Configuration.

4.2.7 EUT OPERATING CONDITION

Same as 4.1.6



4.2.8 TEST RESULTS

Below 1GHz Worst-Case Data_with charging cable

EUT	EDA (Enterprise Digital Assistant)	MEASUREMENT DETAIL	
MODEL	MC7094	FREQUENCY RANGE	Below 1000MHz
CHANNEL	Channel 5	DETECTOR FUNCTION	Quasi-Peak
MODULATION TYPE	BPSK	ENVIRONMENTAL CONDITIONS	25deg. C, 65%RH, 991hPa
TRANSFER RATE	6Mbps	INPUT POWER (SYSTEM)	120Vac, 60 Hz
TESTED BY	Match Tsui	TEST MODE	A

ANTENNA POLARITY & TEST DISTANCE: HORIZONTAL AT 3 M

No.	Freq. (MHz)	Emission Level (dBuV/m)	Limit (dBuV/m)	Margin (dB)	Antenna Height (m)	Table Angle (Degree)	Raw Value (dBuV)	Correction Factor (dB/m)
1	131.08	31.77 QP	43.50	-11.73	2.00 H	274	18.19	13.58
2	181.62	25.79 QP	43.50	-17.71	2.00 H	136	13.21	12.58
3	249.66	28.93 QP	46.00	-17.07	1.00 H	301	15.85	13.08
4	463.49	29.28 QP	46.00	-16.72	2.00 H	298	11.19	18.09
5	729.80	34.42 QP	46.00	-11.58	1.00 H	241	11.48	22.94
6	861.98	30.55 QP	46.00	-15.45	1.00 H	328	6.19	24.36

ANTENNA POLARITY & TEST DISTANCE: VERTICAL AT 3 M

No.	Freq. (MHz)	Emission Level (dBuV/m)	Limit (dBuV/m)	Margin (dB)	Antenna Height (m)	Table Angle (Degree)	Raw Value (dBuV)	Correction Factor (dB/m)
1	47.49	31.37 QP	40.00	-8.63	1.00 V	360	16.61	14.76
2	113.59	33.11 QP	43.50	-10.39	1.00 V	265	20.97	12.14
3	185.51	32.04 QP	43.50	-11.46	1.00 V	58	19.77	12.27
4	333.25	24.07 QP	46.00	-21.93	1.50 V	307	8.99	15.08
5	465.43	28.49 QP	46.00	-17.51	1.00 V	358	10.37	18.12
6	624.83	26.97 QP	46.00	-19.03	1.00 V	169	5.73	21.24
7	733.69	29.14 QP	46.00	-16.86	1.50 V	151	6.11	23.03
8	863.93	30.27 QP	46.00	-15.73	1.50 V	166	5.87	24.40
9	931.96	29.00 QP	46.00	-17.00	1.00 V	178	3.57	25.43

- REMARKS:**
1. Emission level(dBuV/m)=Raw Value(dBuV) + Correction Factor(dB/m)
 2. Correction Factor(dB/m) = Antenna Factor (dB/m) + Cable Factor (dB)
 3. The other emission levels were very low against the limit.
 4. Margin value = Emission level – Limit value

Below 1GHz Worst-Case Data_with cradle

EUT	EDA (Enterprise Digital Assistant)	MEASUREMENT DETAIL	
MODEL	MC7094	FREQUENCY RANGE	Below 1000MHz
CHANNEL	Channel 5	DETECTOR FUNCTION	Quasi-Peak
MODULATION TYPE	BPSK	ENVIRONMENTAL CONDITIONS	25deg. C, 65%RH, 991hPa
TRANSFER RATE	6Mbps	INPUT POWER (SYSTEM)	120Vac, 60 Hz
TESTED BY	Match Tsui	TEST MODE	B

ANTENNA POLARITY & TEST DISTANCE: HORIZONTAL AT 3 M

No.	Freq. (MHz)	Emission Level (dBuV/m)	Limit (dBuV/m)	Margin (dB)	Antenna Height (m)	Table Angle (Degree)	Raw Value (dBuV)	Correction Factor (dB/m)
1	115.53	33.60 QP	43.50	-9.90	1.50 H	85	21.26	12.34
2	164.13	29.54 QP	43.50	-13.96	1.50 H	259	15.29	14.26
3	249.66	39.65 QP	46.00	-6.35	1.00 H	280	26.57	13.08
4	465.43	31.82 QP	46.00	-14.18	2.00 H	280	13.70	18.12
5	500.42	29.38 QP	46.00	-16.62	2.00 H	25	10.78	18.59
6	597.62	29.65 QP	46.00	-16.35	1.00 H	310	8.82	20.83
7	731.74	35.83 QP	46.00	-10.17	1.00 H	325	12.84	22.99
8	867.82	31.20 QP	46.00	-14.80	1.50 H	283	6.73	24.47
9	898.92	29.01 QP	46.00	-16.99	1.00 H	118	3.93	25.08

ANTENNA POLARITY & TEST DISTANCE: VERTICAL AT 3 M

No.	Freq. (MHz)	Emission Level (dBuV/m)	Limit (dBuV/m)	Margin (dB)	Antenna Height (m)	Table Angle (Degree)	Raw Value (dBuV)	Correction Factor (dB/m)
1	43.61	29.30 QP	40.00	-10.70	1.00 V	343	14.27	15.03
2	82.48	29.26 QP	40.00	-10.74	1.00 V	94	19.47	9.80
3	115.53	37.45 QP	43.50	-6.05	1.00 V	229	25.11	12.34
4	148.58	29.01 QP	43.50	-14.49	1.00 V	40	14.61	14.40
5	199.12	28.00 QP	43.50	-15.50	1.00 V	328	16.80	11.20
6	249.66	38.31 QP	46.00	-7.69	1.50 V	334	25.23	13.08
7	455.71	32.94 QP	46.00	-13.06	1.00 V	304	14.95	17.99
8	500.42	29.60 QP	46.00	-16.40	1.00 V	244	11.01	18.59
9	624.83	30.10 QP	46.00	-15.90	1.00 V	196	8.87	21.24
10	733.69	33.64 QP	46.00	-12.36	1.50 V	229	10.60	23.03
11	865.87	30.36 QP	46.00	-15.64	1.00 V	316	5.93	24.43
12	898.92	32.98 QP	46.00	-13.02	1.00 V	232	7.90	25.08

- REMARKS:**
1. Emission level(dBuV/m)=Raw Value(dBuV) + Correction Factor(dB/m)
 2. Correction Factor(dB/m) = Antenna Factor (dB/m) + Cable Factor (dB)
 3. The other emission levels were very low against the limit.
 4. Margin value = Emission level – Limit value

Below 1GHz Worst-Case Data_battery mode

EUT	EDA (Enterprise Digital Assistant)	MEASUREMENT DETAIL	
MODEL	MC7094	FREQUENCY RANGE	Below 1000MHz
CHANNEL	Channel 5	DETECTOR FUNCTION	Quasi-Peak
MODULATION TYPE	BPSK	ENVIRONMENTAL CONDITIONS	25deg. C, 65%RH, 991hPa
TRANSFER RATE	6Mbps	INPUT POWER (SYSTEM)	3.7Vdc
TESTED BY	Match Tsui	TEST MODE	C

ANTENNA POLARITY & TEST DISTANCE: HORIZONTAL AT 3 M

No.	Freq. (MHz)	Emission Level (dBuV/m)	Limit (dBuV/m)	Margin (dB)	Antenna Height (m)	Table Angle (Degree)	Raw Value (dBuV)	Correction Factor (dB/m)
1	109.70	34.60 QP	43.50	-8.90	1.50 H	91	22.86	11.74
2	168.02	29.59 QP	43.50	-13.91	1.50 H	286	15.71	13.88
3	249.66	29.31 QP	46.00	-16.69	1.00 H	289	16.24	13.08
4	465.43	29.26 QP	46.00	-16.74	1.50 H	280	11.14	18.12
5	733.69	32.95 QP	46.00	-13.05	1.00 H	232	9.91	23.03
6	861.98	30.60 QP	46.00	-15.40	1.50 H	229	6.24	24.36
7	898.92	29.83 QP	46.00	-16.17	1.50 H	205	4.74	25.08

ANTENNA POLARITY & TEST DISTANCE: VERTICAL AT 3 M

No.	Freq. (MHz)	Emission Level (dBuV/m)	Limit (dBuV/m)	Margin (dB)	Antenna Height (m)	Table Angle (Degree)	Raw Value (dBuV)	Correction Factor (dB/m)
1	47.49	28.63 QP	40.00	-11.37	1.00 V	97	13.87	14.76
2	109.70	37.39 QP	43.50	-6.11	1.00 V	214	25.65	11.74
3	164.13	33.37 QP	43.50	-10.13	1.00 V	238	19.12	14.26
4	249.66	24.76 QP	46.00	-21.24	2.00 V	301	11.68	13.08
5	331.30	24.04 QP	46.00	-21.96	2.00 V	115	9.00	15.04
6	465.43	31.06 QP	46.00	-14.94	1.00 V	349	12.94	18.12
7	729.80	30.31 QP	46.00	-15.69	1.50 V	181	7.37	22.94
8	865.87	31.41 QP	46.00	-14.59	1.00 V	238	6.97	24.43
9	898.92	31.03 QP	46.00	-14.97	1.00 V	124	5.94	25.08

- REMARKS:**
1. Emission level(dBuV/m)=Raw Value(dBuV) + Correction Factor(dB/m)
 2. Correction Factor(dB/m) = Antenna Factor (dB/m) + Cable Factor (dB)
 3. The other emission levels were very low against the limit.
 4. Margin value = Emission level – Limit value



802.11a OFDM modulation

EUT	EDA (Enterprise Digital Assistant)	MEASUREMENT DETAIL	
MODEL	MC7094	FREQUENCY RANGE	1 ~ 40 GHz
CHANNEL	Channel 1	DETECTOR FUNCTION	Peak(PK) Average (AV)
MODULATION TYPE	BPSK	ENVIRONMENTAL CONDITIONS	26deg. C, 65%RH, 991hPa
TRANSFER RATE	6Mbps	INPUT POWER (SYSTEM)	120Vac, 60 Hz
TESTED BY	Jay Hsu		

ANTENNA POLARITY & TEST DISTANCE: HORIZONTAL AT 3 M								
No.	Freq. (MHz)	Emission Level (dBuV/m)	Limit (dBuV/m)	Margin (dB)	Antenna Height (m)	Table Angle (Degree)	Raw Value (dBuV)	Correction Factor (dB/m)
1	#5130.00	57.88 PK	74.00	-16.12	1.25 H	162	18.99	38.89
1	#5130.00	48.65 AV	54.00	-5.35	1.25 H	162	9.76	38.89
2	*5180.00	110.80 PK			1.25 H	162	71.83	38.97
2	*5180.00	101.57 AV			1.25 H	162	62.60	38.97
3	10360.00	57.31 PK	68.30	-10.99	1.12 H	360	8.25	49.06

ANTENNA POLARITY & TEST DISTANCE: VERTICAL AT 3 M								
No.	Freq. (MHz)	Emission Level (dBuV/m)	Limit (dBuV/m)	Margin (dB)	Antenna Height (m)	Table Angle (Degree)	Raw Value (dBuV)	Correction Factor (dB/m)
1	#5130.00	51.93 PK	74.00	-22.07	1.00 V	255	13.04	38.89
1	#5130.00	42.45 AV	54.00	-11.55	1.00 V	255	3.56	38.89
2	*5180.00	104.85 PK			1.00 V	255	65.88	38.97
2	*5180.00	95.37 AV			1.00 V	255	56.40	38.97
3	10360.00	57.09 PK	68.30	-11.21	1.02 V	250	8.03	49.06

- NOTE:**
1. Emission level(dBuV/m)=Raw Value(dBuV) + Correction Factor(dB/m)
 2. Correction Factor(dB/m) = Antenna Factor (dB/m) + Cable Factor (dB)
 3. The other emission levels were very low against the limit.
 4. Margin value = Emission level – Limit value
 5. "*" : Fundamental frequency
 6. "#"The radiated frequency falling in the restricted band.



EUT	EDA (Enterprise Digital Assistant)	MEASUREMENT DETAIL	
MODEL	MC7094	FREQUENCY RANGE	1 ~ 40 GHz
CHANNEL	Channel 4	DETECTOR FUNCTION	Peak(PK) Average (AV)
MODULATION TYPE	BPSK	ENVIRONMENTAL CONDITIONS	26deg. C, 65%RH, 991hPa
TRANSFER RATE	6Mbps	INPUT POWER (SYSTEM)	120Vac, 60 Hz
TESTED BY	Jay Hsu		

ANTENNA POLARITY & TEST DISTANCE: HORIZONTAL AT 3 M

No.	Freq. (MHz)	Emission Level (dBuV/m)	Limit (dBuV/m)	Margin (dB)	Antenna Height (m)	Table Angle (Degree)	Raw Value (dBuV)	Correction Factor (dB/m)
1	*5240.00	109.04 PK			1.50 H	255	69.62	39.42
1	*5240.00	99.67 AV			1.50 H	255	60.25	39.42
2	10480.00	57.70 PK	68.30	-10.60	1.00 H	131	8.44	49.26

ANTENNA POLARITY & TEST DISTANCE: VERTICAL AT 3 M

No.	Freq. (MHz)	Emission Level (dBuV/m)	Limit (dBuV/m)	Margin (dB)	Antenna Height (m)	Table Angle (Degree)	Raw Value (dBuV)	Correction Factor (dB/m)
1	*5240.00	104.05 PK			1.16 V	181	64.93	39.12
1	*5240.00	94.84 AV			1.16 V	181	55.72	39.12
2	10480.00	57.09 PK	68.30	-11.21	1.02 V	155	7.83	49.26

- NOTE:**
1. Emission level(dBuV/m)=Raw Value(dBuV) + Correction Factor(dB/m)
 2. Correction Factor(dB/m) = Antenna Factor (dB/m) + Cable Factor (dB)
 3. The other emission levels were very low against the limit.
 4. Margin value = Emission level – Limit value
 5. "*" : Fundamental frequency
 6. "#" The radiated frequency falling in the restricted band.



EUT	EDA (Enterprise Digital Assistant)	MEASUREMENT DETAIL	
MODEL	MC7094	FREQUENCY RANGE	1 ~ 40 GHz
CHANNEL	Channel 5	DETECTOR FUNCTION	Peak(PK) Average (AV)
MODULATION TYPE	BPSK	ENVIRONMENTAL CONDITIONS	26deg. C, 65%RH, 991hPa
TRANSFER RATE	6Mbps	INPUT POWER (SYSTEM)	120Vac, 60 Hz
TESTED BY	Jay Hsu		

ANTENNA POLARITY & TEST DISTANCE: HORIZONTAL AT 3 M

No.	Freq. (MHz)	Emission Level (dBuV/m)	Limit (dBuV/m)	Margin (dB)	Antenna Height (m)	Table Angle (Degree)	Raw Value (dBuV)	Correction Factor (dB/m)
1	*5260.00	109.77 PK			1.10 H	170	70.60	39.17
1	*5260.00	100.52 AV			1.10 H	170	61.35	39.17
2	10520.00	57.25 PK	68.30	-11.05	1.33 H	255	7.90	49.35

ANTENNA POLARITY & TEST DISTANCE: VERTICAL AT 3 M

No.	Freq. (MHz)	Emission Level (dBuV/m)	Limit (dBuV/m)	Margin (dB)	Antenna Height (m)	Table Angle (Degree)	Raw Value (dBuV)	Correction Factor (dB/m)
1	*5260.00	104.83 PK			1.02 V	154	65.66	39.17
1	*5260.00	95.22 AV			1.02 V	154	56.05	39.17
2	10520.00	57.87 PK	68.30	-10.43	1.00 V	184	8.52	49.35

- NOTE:**
1. Emission level(dBuV/m)=Raw Value(dBuV) + Correction Factor(dB/m)
 2. Correction Factor(dB/m) = Antenna Factor (dB/m) + Cable Factor (dB)
 3. The other emission levels were very low against the limit.
 4. Margin value = Emission level – Limit value
 5. "*" : Fundamental frequency
 6. "#"The radiated frequency falling in the restricted band.



EUT	EDA (Enterprise Digital Assistant)	MEASUREMENT DETAIL	
MODEL	MC7094	FREQUENCY RANGE	1 ~ 40 GHz
CHANNEL	Channel 8	DETECTOR FUNCTION	Peak(PK) Average (AV)
MODULATION TYPE	BPSK	ENVIRONMENTAL CONDITIONS	26deg. C, 65%RH, 991hPa
TRANSFER RATE	6Mbps	INPUT POWER (SYSTEM)	120Vac, 60 Hz
TESTED BY	Jay Hsu		

ANTENNA POLARITY & TEST DISTANCE: HORIZONTAL AT 3 M

No.	Freq. (MHz)	Emission Level (dBuV/m)	Limit (dBuV/m)	Margin (dB)	Antenna Height (m)	Table Angle (Degree)	Raw Value (dBuV)	Correction Factor (dB/m)
1	*5320.00	108.38 PK			1.10 H	174	69.07	39.31
1	*5320.00	99.45 AV			1.10 H	174	60.14	39.31
2	#5356.00	54.60 PK	74.00	-19.40	1.10 H	174	15.25	39.35
2	#5356.00	45.68 AV	54.00	-8.32	1.10 H	174	6.33	39.35
3	#10640.00	58.34 PK	74.00	-15.66	1.07 H	1	8.68	49.66
3	#10640.00	46.09 AV	54.00	-7.91	1.07 H	1	-3.57	49.66

ANTENNA POLARITY & TEST DISTANCE: VERTICAL AT 3 M

No.	Freq. (MHz)	Emission Level (dBuV/m)	Limit (dBuV/m)	Margin (dB)	Antenna Height (m)	Table Angle (Degree)	Raw Value (dBuV)	Correction Factor (dB/m)
1	*5320.00	103.82 PK			1.51 V	169	64.51	39.31
1	*5320.00	94.53 AV			1.51 V	169	55.22	39.31
2	#5356.00	50.05 PK	74.00	-23.95	1.51 V	169	10.70	39.35
2	#5356.00	40.76 AV	54.00	-13.24	1.51 V	169	1.41	39.35
3	#10640.00	58.43 PK	74.00	-15.57	1.11 V	180	8.77	49.66
3	#10640.00	46.18 AV	54.00	-7.82	1.11 V	180	-3.48	49.66

- NOTE:**
1. Emission level(dBuV/m)=Raw Value(dBuV) + Correction Factor(dB/m)
 2. Correction Factor(dB/m) = Antenna Factor (dB/m) + Cable Factor (dB)
 3. The other emission levels were very low against the limit.
 4. Margin value = Emission level – Limit value
 5. "*" : Fundamental frequency
 6. "#"The radiated frequency falling in the restricted band.



4.3 PEAK TRANSMIT POWER MEASUREMENT

4.3.1 LIMITS OF PEAK TRANSMIT POWER MEASUREMENT

Frequency Band	Limit
5.15 ~ 5.25GHz	The lesser of 50mW (17dBm) or 4dBm + 10logB
5.25 ~ 5.35GHz	The lesser of 250mW (24dBm) or 11dBm + 10logB
5.725 ~ 5.825GHz	The lesser of 1W (30dBm) or 17dBm + 10logB

NOTE: Where B is the 26dB emission bandwidth in MHz.

4.3.2 TEST INSTRUMENTS

Description & Manufacturer	Model No.	Serial No.	Calibrated Until
Spectrum Analyzer Agilent	E4446A	MY44360128	Dec. 05, 2005

NOTE: The calibration interval of the above test instruments is 12 months and the calibrations are traceable to NML/ROC and NIST/USA.



4.3.3 TEST PROCEDURE

1. The transmitter output was connected to the spectrum analyzer.
2. Set span to encompass the entire emission bandwidth of the signal.
3. Set RBW to 1MHz, VBW to 3MHz.
4. Using the spectrum analyzer's channel power measurement function to measure the output power.

NOTE:

The test is performed in accordance with FCC Public Notice: APPENDIX A Guidelines for Assessing Unlicensed National Information Infrastructure (U-NII) Devices – Part 15, Subpart E, August 2002.

The transmitter output operates continuously therefore Method # 1 is used.

4.3.4 DEVIATION FROM TEST STANDARD

No deviation

4.3.5 TEST SETUP



4.3.6 EUT OPERATING CONDITIONS

The software provided by client to enable the EUT under transmission condition continuously at specific channel frequencies individually.



4.3.7 TEST RESULTS

802.11a OFDM modulation

EUT	EDA (Enterprise Digital Assistant)	MODEL	MC7094
MODULATION TYPE	BPSK	TRANSFER RATE	6Mbps
INPUT POWER (SYSTEM)	120Vac, 60 Hz	ENVIRONMENTAL CONDITIONS	27deg.C, 63%RH, 991hPa
TESTED BY	Gary Chang		

CHANNEL	CHANNEL FREQUENCY (MHz)	PEAK POWER OUTPUT (mW)	PEAK POWER OUTPUT (dBm)	PEAK POWER LIMIT (dBm)	26dBc Occupied Bandwidth (MHz)	PASS/FAIL
1	5180	26.977	14.31	17.00	24.10	PASS
4	5240	19.543	12.91	17.00	21.00	PASS
5	5260	18.450	12.66	24.00	21.10	PASS
8	5320	17.179	12.35	24.00	21.50	PASS

NOTE: The 26dBc Occupied Bandwidth plot, please refer to the following pages.



Peak Power Output:
CH 1

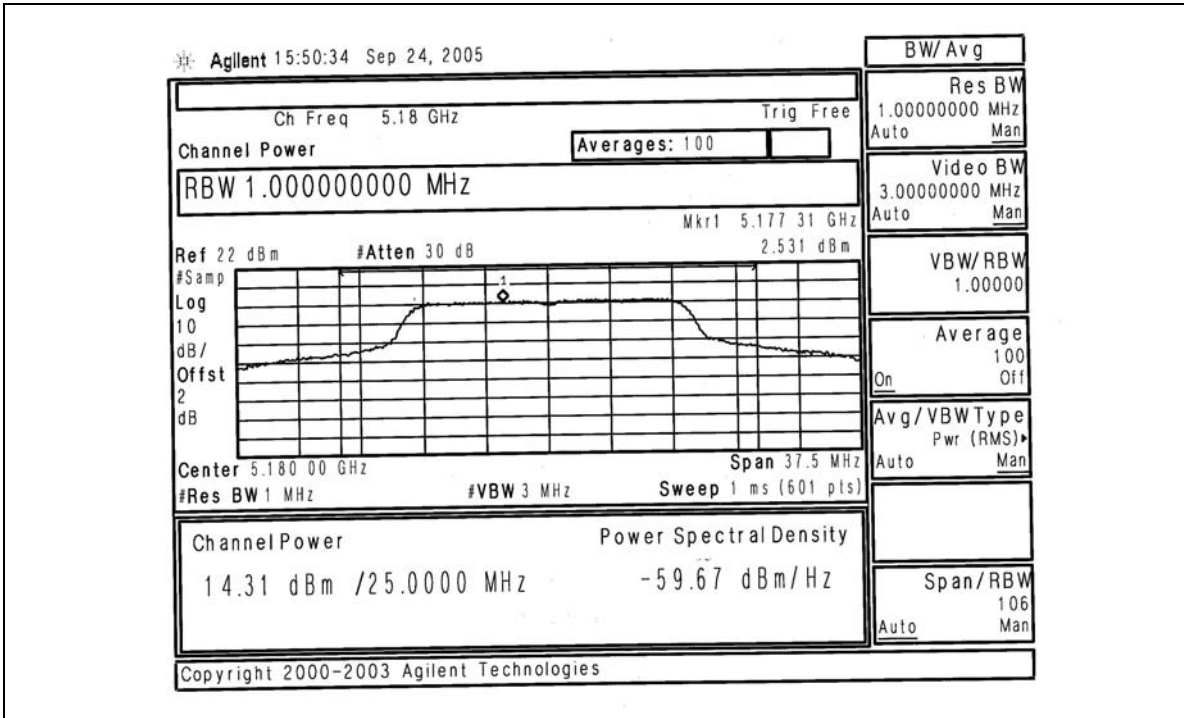

CH 4

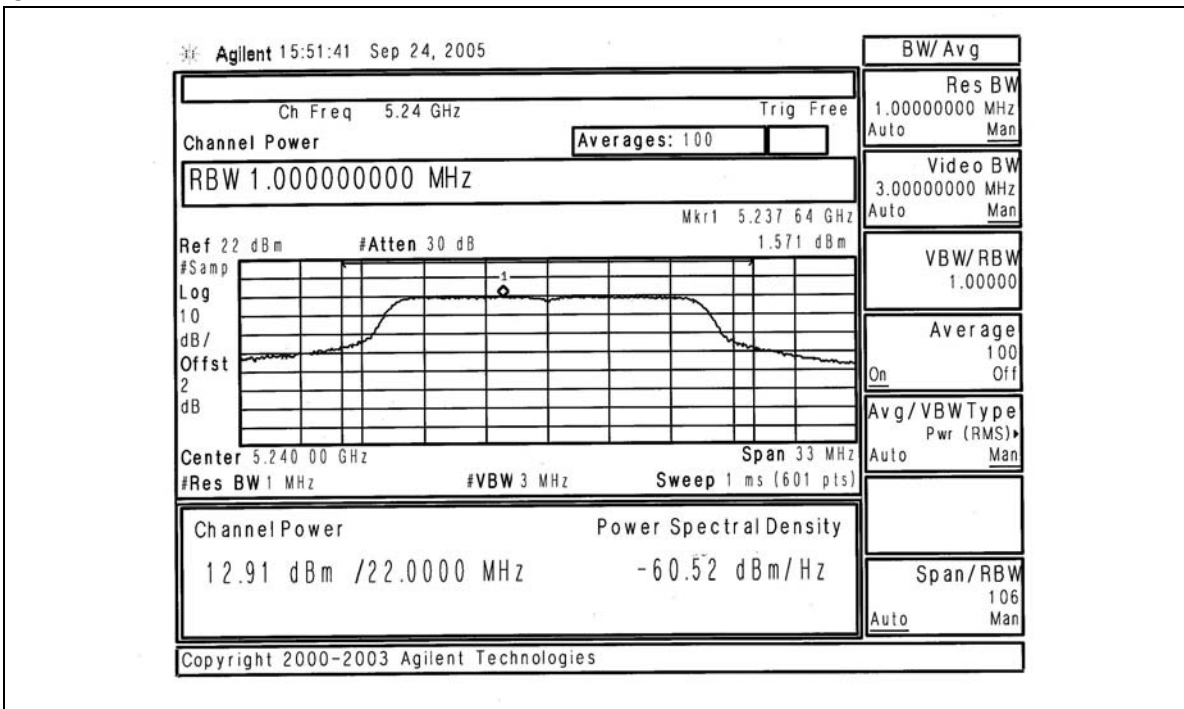



CH 5

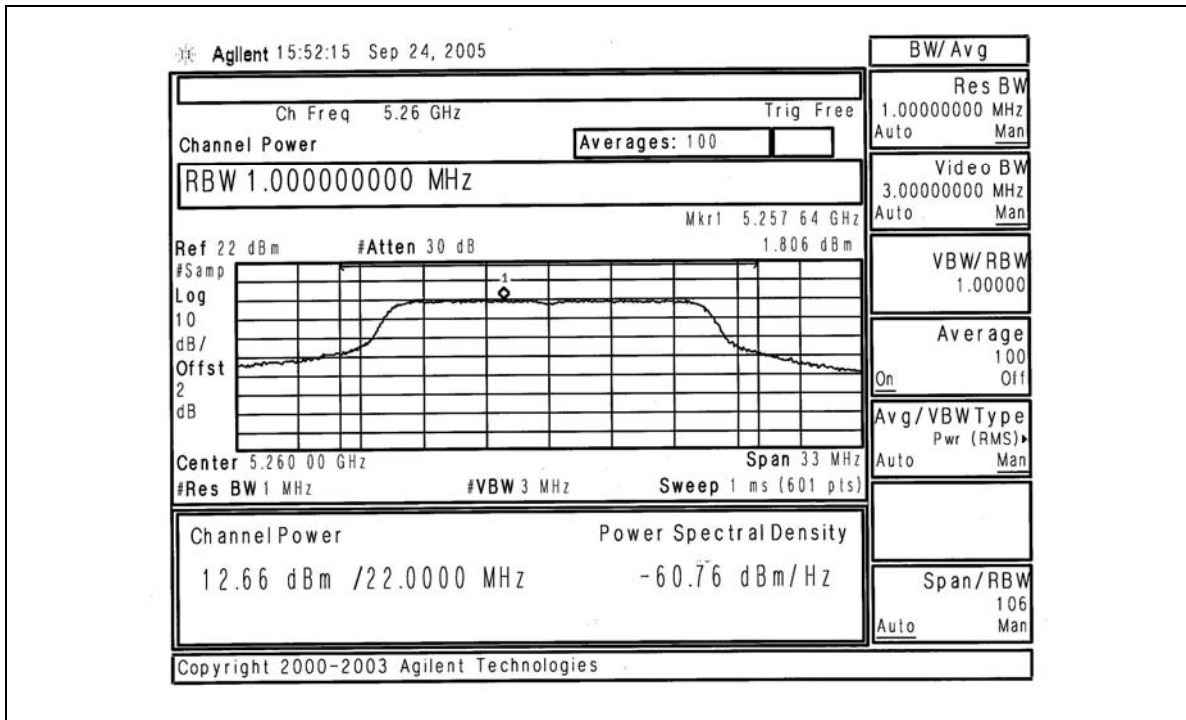

CH 8

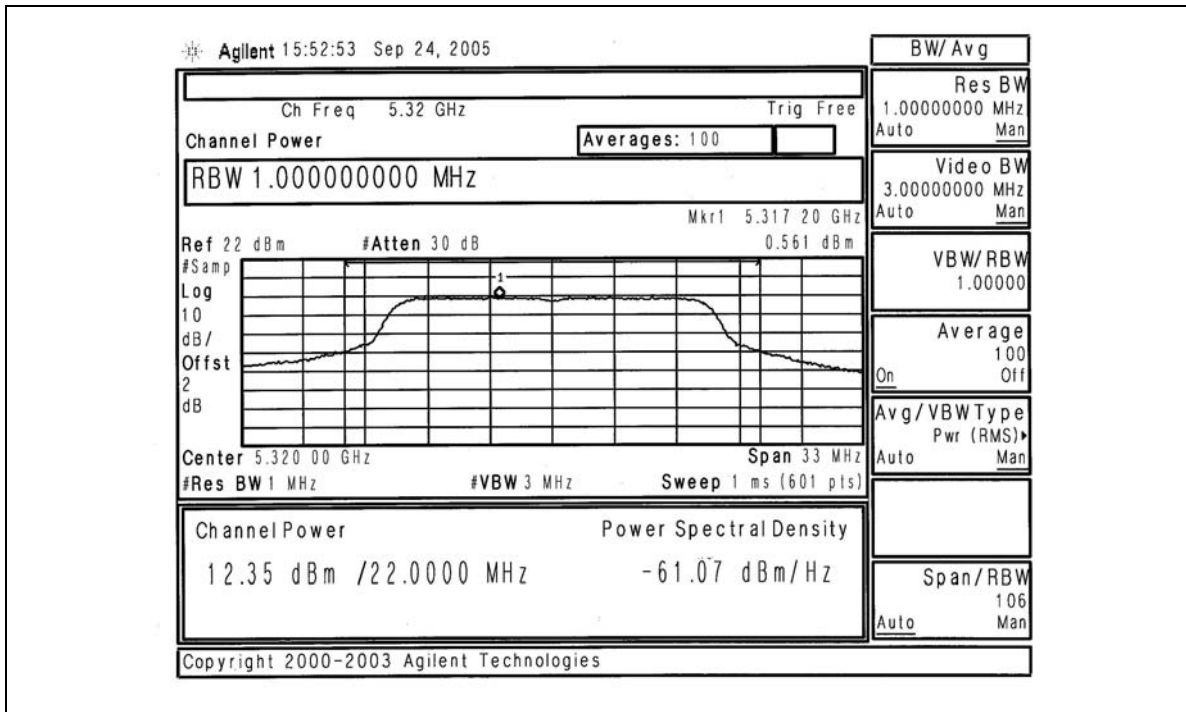



26dB Occupied Bandwidth:
CH 1

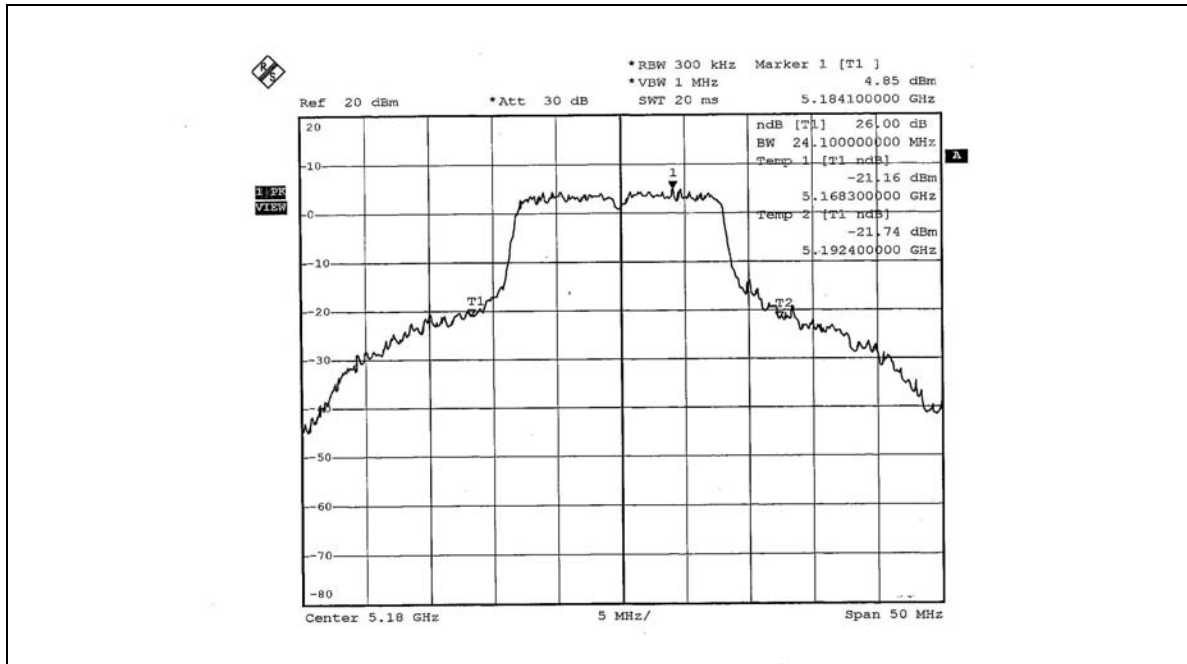

CH 4

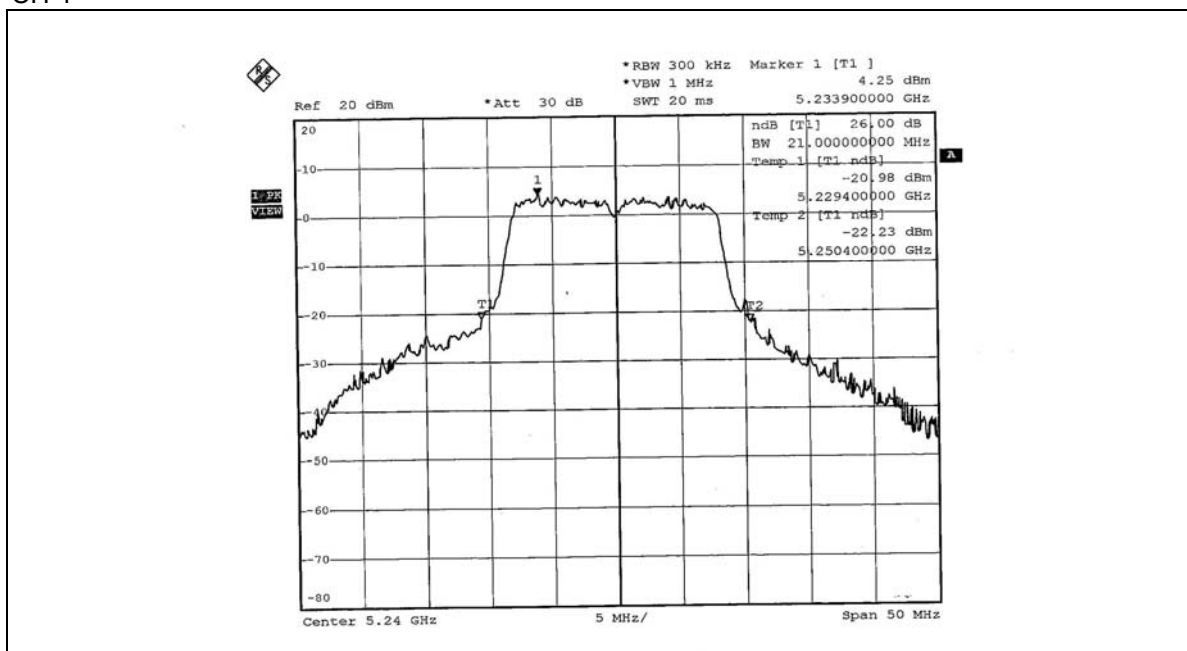



CH 5

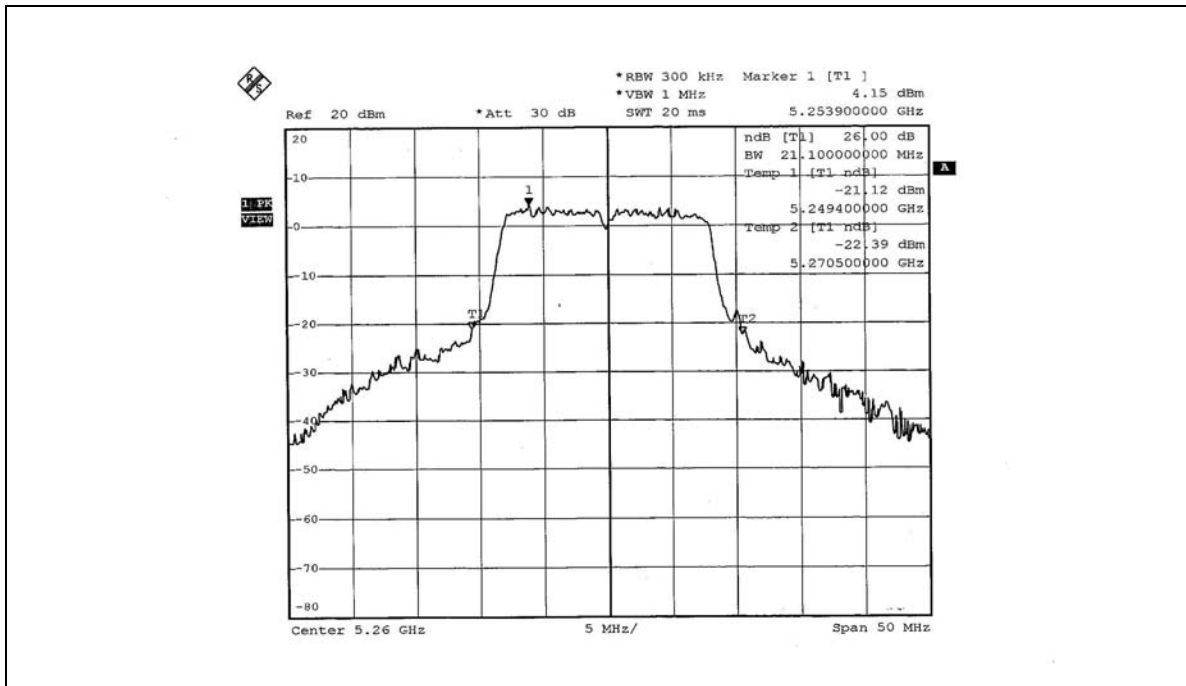

CH 8

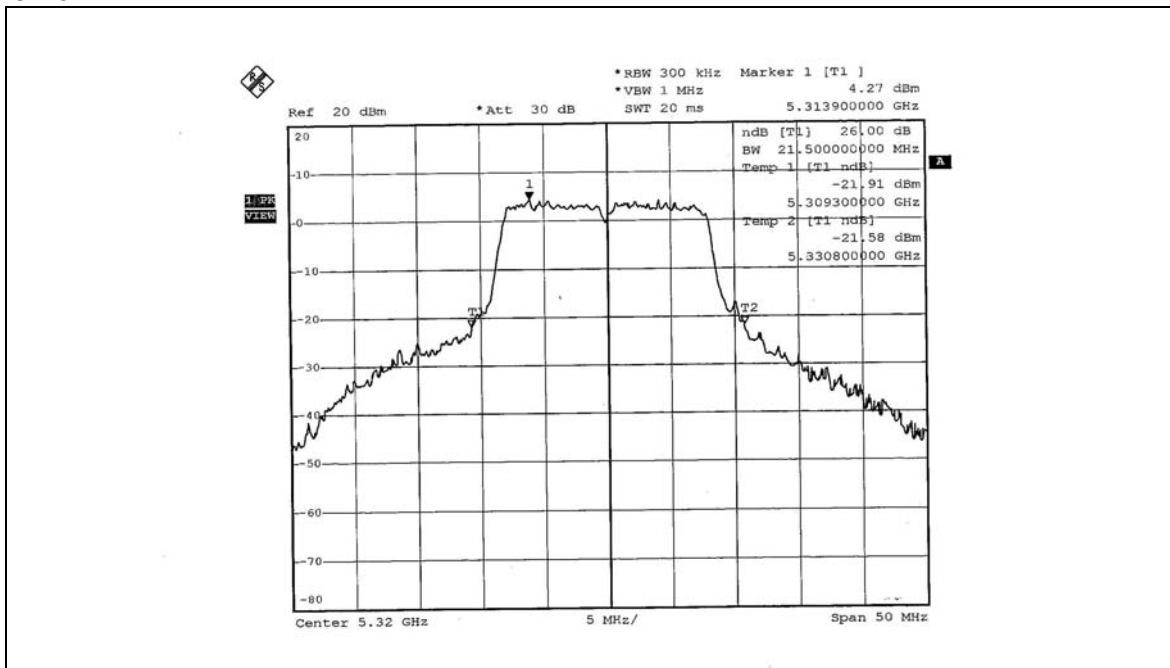



4.4 PEAK POWER EXCURSION MEASUREMENT

4.4.1 LIMITS OF PEAK POWER EXCURSION MEASUREMENT

Frequency Band	Limit
5.15 ~ 5.25 GHz	13dB
5.25 ~ 5.35 GHz	13dB
5.725 ~ 5.825 GHz	13dB

4.4.2 TEST INSTRUMENTS

Description & Manufacturer	Model No.	Serial No.	Calibrated Until
SPECTRUM ANALYZER	FSEK30	100049	Aug. 14, 2006

NOTE: The calibration interval of the above test instruments is 12 months and the calibrations are traceable to NML/ROC and NIST/USA.



4.4.3 TEST PROCEDURE

1. The transmitter output was connected to the spectrum analyzer.
2. Set the spectrum bandwidth span to view the entire spectrum.
3. Using peak detector and Max-hold function for Trace 1 (RB=1MHz, VB=3MHz) and 2 (RB=1MHz, VB=3kHz).
4. The largest difference between Trace 1 and Trace 2 in any 1MHz band on any frequency was recorded.

4.4.4 DEVIATION FROM TEST STANDARD

No deviation

4.4.5 TEST SETUP

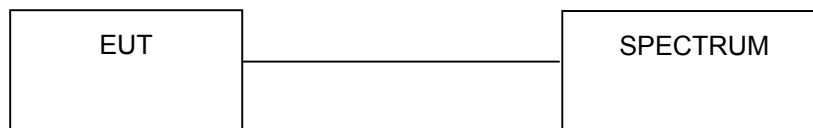

4.4.6 EUT OPERATING CONDITIONS

The software provided by client to enable the EUT under transmission condition continuously at specific channel frequencies individually.



4.4.7 TEST RESULTS

802.11a OFDM modulation

EUT	EDA (Enterprise Digital Assistant)	MODEL	MC7094
MODULATION TYPE	BPSK	TRANSFER RATE	6Mbps
INPUT POWER (SYSTEM)	120Vac, 60 Hz	ENVIRONMENTAL CONDITIONS	27deg.C, 63%RH, 991hPa
TESTED BY	Gary Chang		

CHANNEL	CHANNEL FREQUENCY (MHz)	PEAK POWER EXCURSION (dB)	PEAK to AVERAGE EXCURSION LIMIT (dB)	PASS/FAIL
1	5180	7.67	13	PASS
4	5240	8.56	13	PASS
5	5260	7.64	13	PASS
8	5320	7.24	13	PASS



CH 1

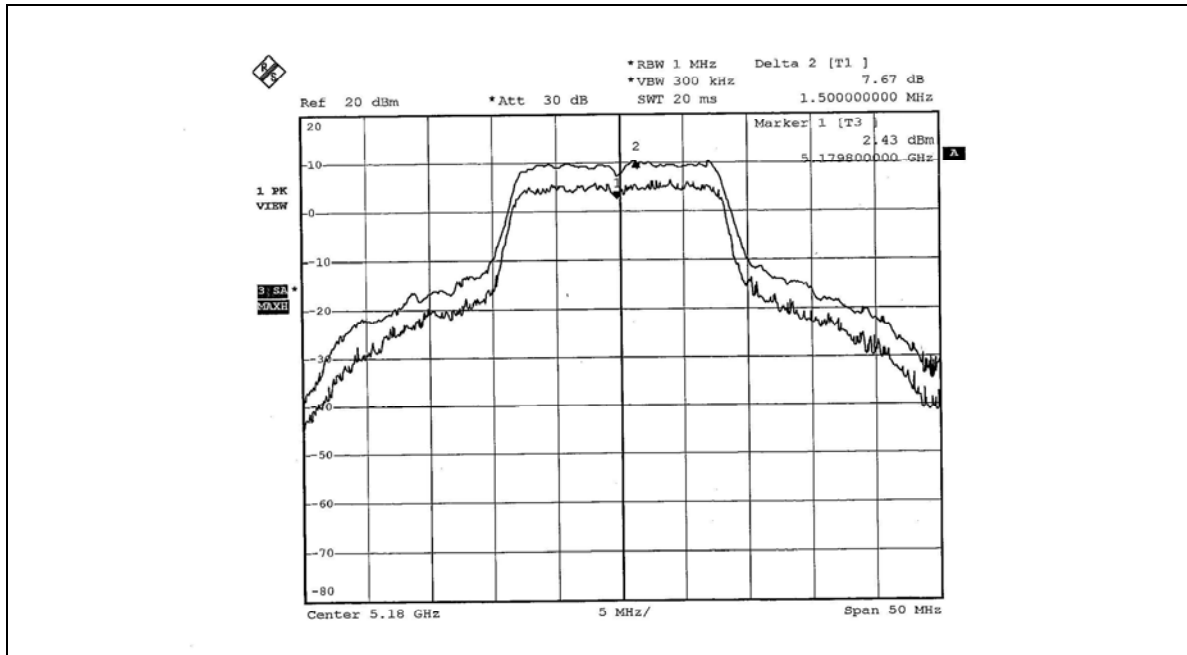

CH 4

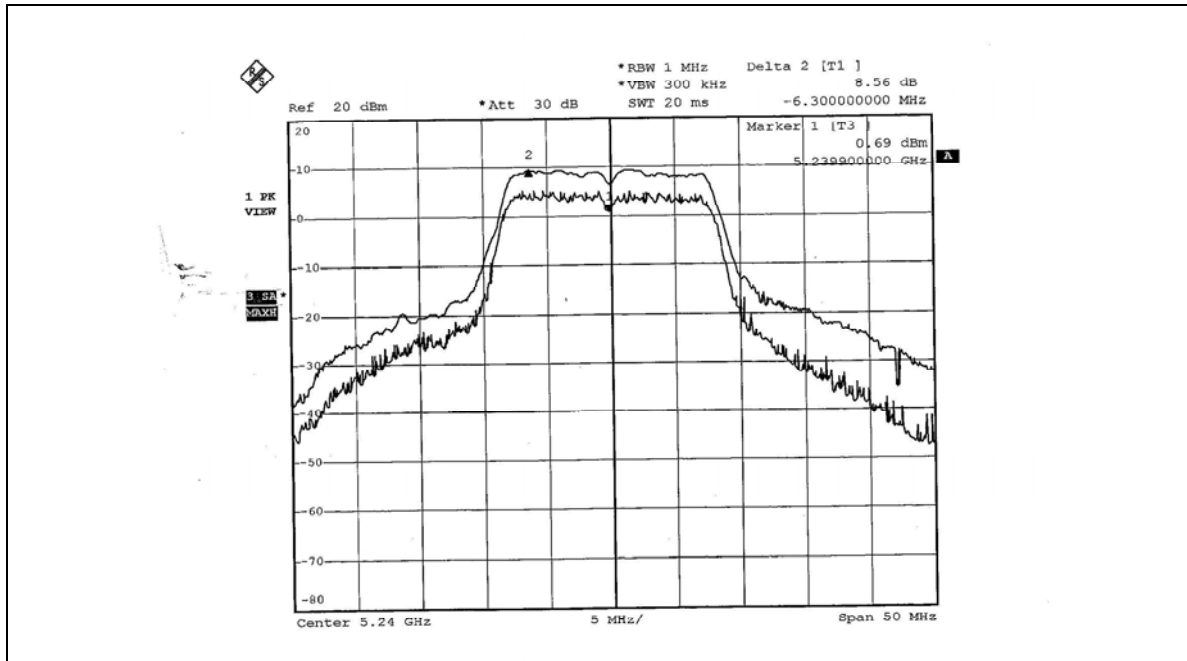



CH 5

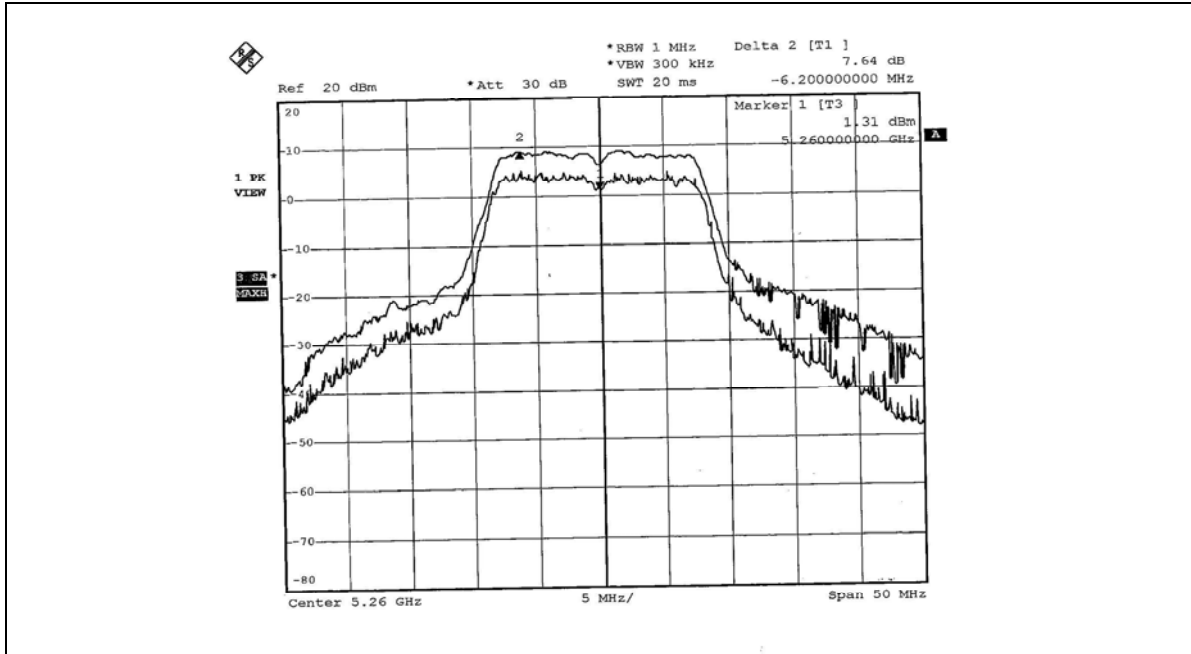

CH 8

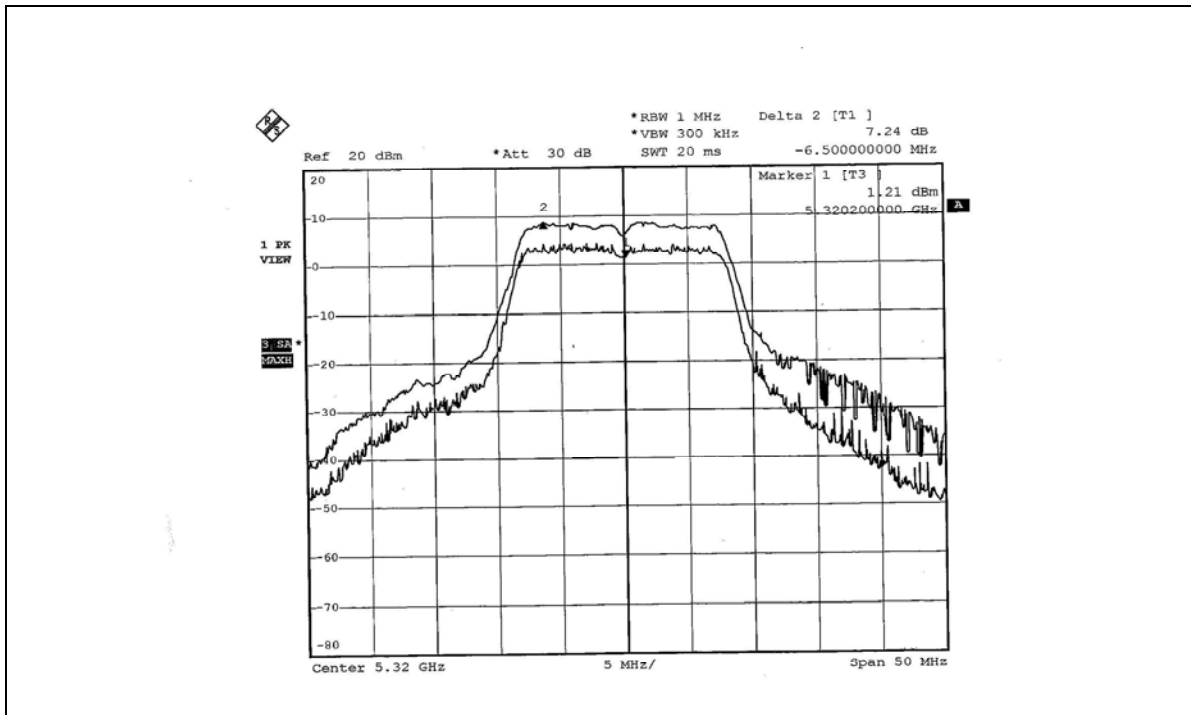



4.5 PEAK POWER SPECTRAL DENSITY MEASUREMENT

4.5.1 LIMITS OF PEAK POWER SPECTRAL DENSITY MEASUREMENT

Frequency Band	Limit
5.15 ~ 5.25GHz	4dBm
5.25 ~ 5.35GHz	11dBm
5.725 ~ 5.825GHz	17dBm

4.5.2 TEST INSTRUMENTS

Description & Manufacturer	Model No.	Serial No.	Calibrated Until
SPECTRUM ANALYZER	FSEK30	100049	Aug. 14, 2006

NOTE: The calibration interval of the above test instruments is 12 months and the calibrations are traceable to NML/ROC and NIST/USA.

4.5.3 TEST PROCEDURES

1. The transmitter output was connected to the spectrum analyzer.
2. Set RBW=1MHz, VBW=3MHz. The PPSD is the highest level found across the emission in any 1MHz band.

4.5.4 DEVIATION FROM TEST STANDARD

No deviation

4.5.5 TEST SETUP



4.5.6 EUT OPERATING CONDITIONS

Same as 5.3.6



4.5.7 TEST RESULTS

802.11a OFDM modulation

EUT	EDA (Enterprise Digital Assistant)	MODEL	MC7094
MODULATION TYPE	BPSK	TRANSFER RATE	6Mbps
INPUT POWER (SYSTEM)	120Vac, 60 Hz	ENVIRONMENTAL CONDITIONS	27deg.C, 63%RH, 991hPa
TESTED BY	Gary Chang		

CHANNEL	CHANNEL FREQUENCY (MHz)	RF POWER LEVEL IN 1MHz BW (dBm)	MAXIMUM LIMIT (dBm)	PASS/FAIL
1	5180	-0.01	4	PASS
4	5240	-0.19	4	PASS
5	5260	-0.54	11	PASS
8	5320	-0.69	11	PASS



CH 1

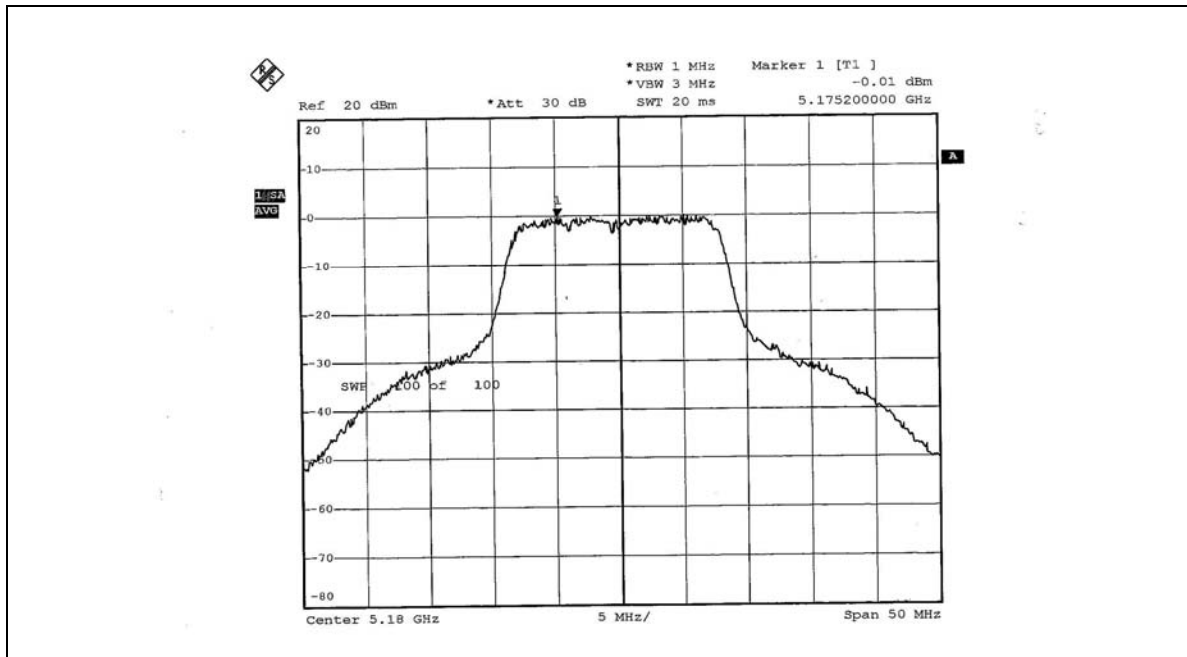

CH 4

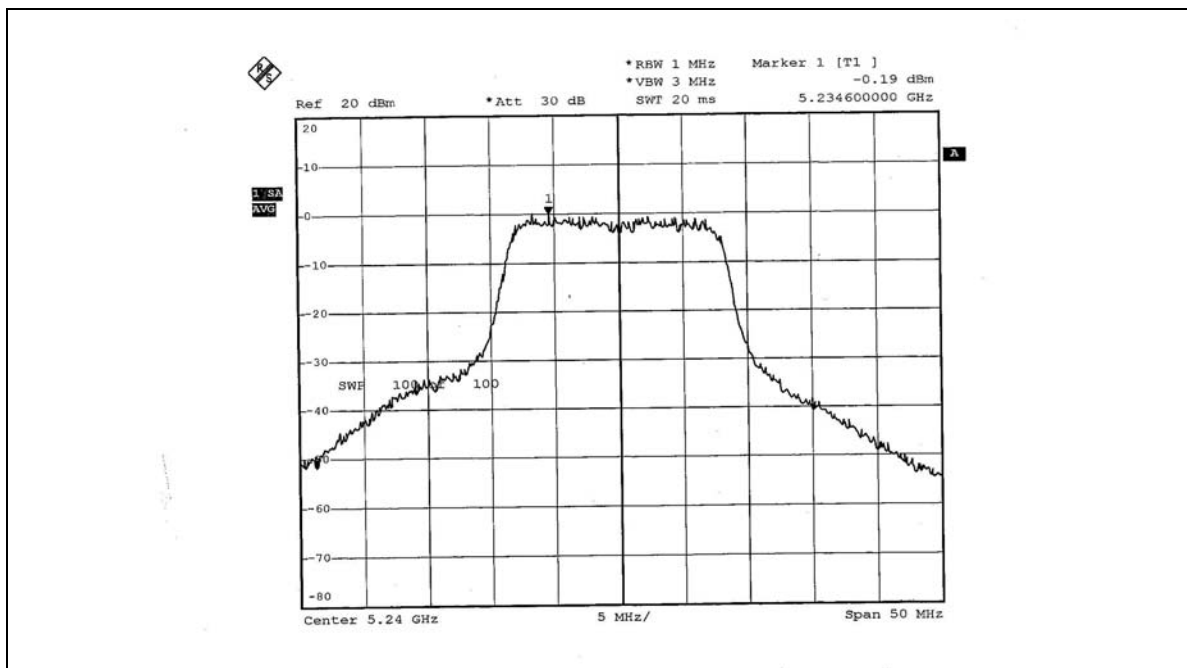



CH 5

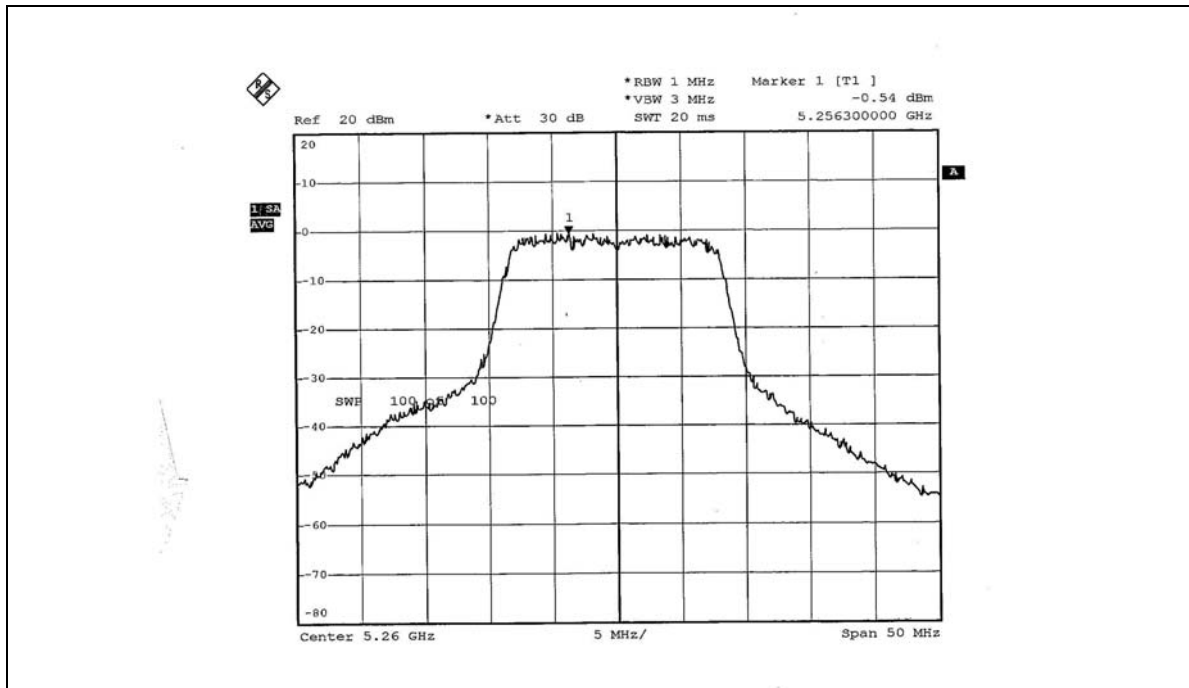

CH 8

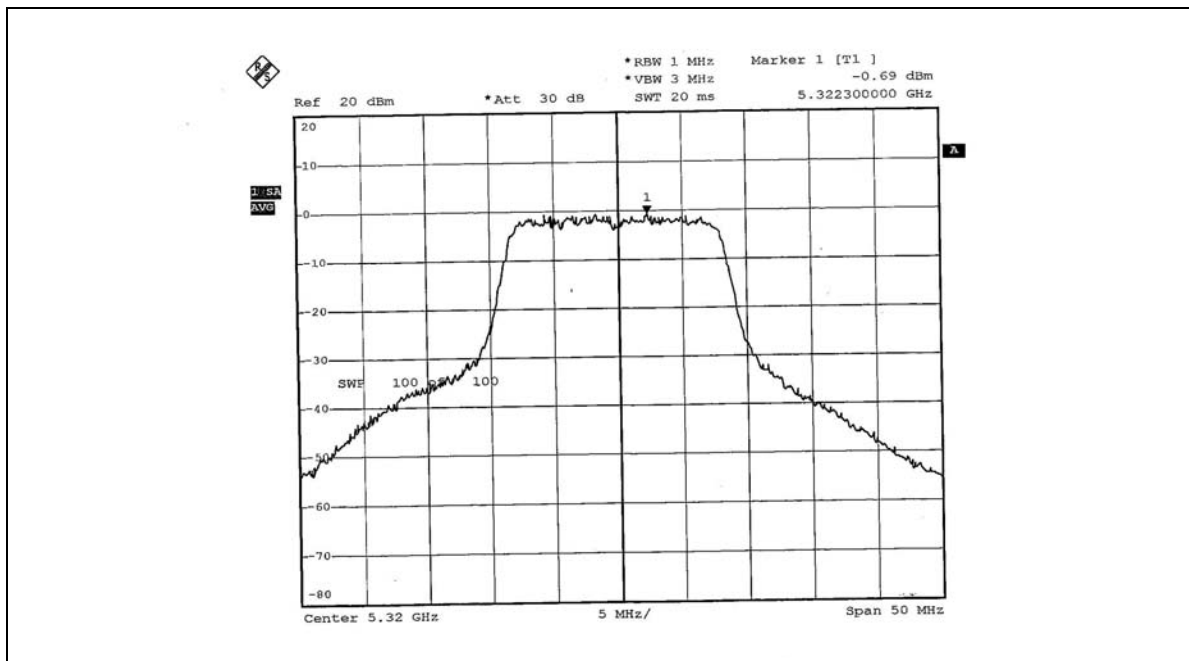



4.6 FREQUENCY STABILITY

4.6.1 LIMITS OF FREQUENCY STABILITY MEASUREMENT

The frequency tolerance of the carrier signal shall be maintained within +/- 0.02% of the operating frequency over a temperature variation of -30 degrees to 50 degrees C at normal supply voltage, and for a variation in the primary supply voltage from 85% to 115% of the rated supply voltage at a temperature of 20 degrees C.

4.6.2 TEST INSTRUMENTS

Description & Manufacturer	Model No.	Serial No.	Calibrated Until
ANRITSU SPECTRUM ANALYZER	MS2667C	M10281	Mar. 09, 2006
WIT STANDARD TEMPERATURE AND HUMIDITY CHAMBER	TH-4S-C	W981030	Jul. 18, 2006

NOTE: The calibration interval of the above test instruments is 12 months and the calibrations are traceable to NML/ROC and NIST/USA.

4.6.3 TEST PROCEDURE

1. The EUT was placed inside the environmental test chamber and powered by nominal DC voltage.
2. Turn the EUT on and couple its output to a spectrum analyzer.
3. Turn the EUT off and set the chamber to the highest temperature specified.
4. Allow sufficient time (approximately 30 min) for the temperature of the chamber to stabilize, turn the EUT on and measure the operating frequency after 2, 5, and 10 minutes.
5. Repeat step 2 and 3 with the temperature chamber set to the lowest temperature.
6. The test chamber was allowed to stabilize at +20 degree C for a minimum of 30 minutes. The supply voltage was then adjusted on the EUT from 85% to 115% and the frequency record.

4.6.4 DEVIATION FROM TEST STANDARD

No deviation

4.6.5 TEST SETUP

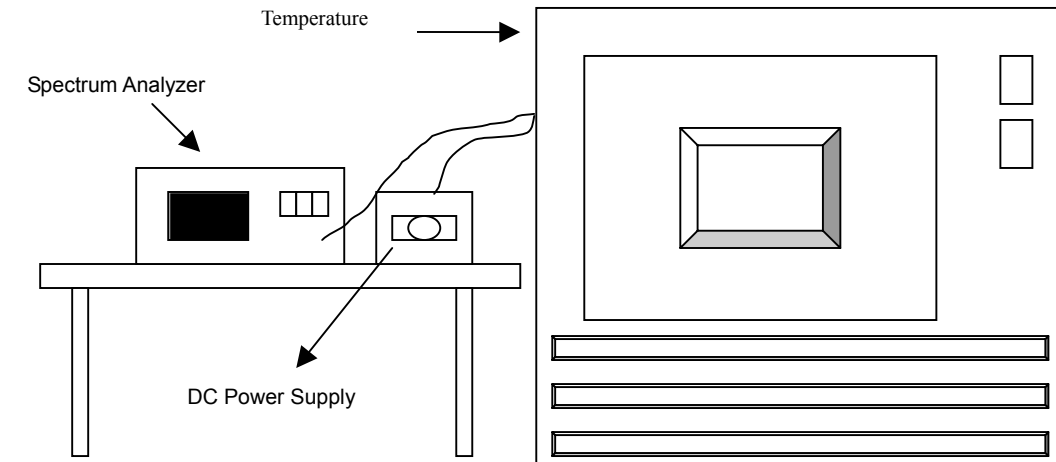

4.6.6 EUT OPERATING CONDITION

Same as Item 4.1.6



4.6.7 TEST RESULTS

		Operating frequency: 5320MHz				Limit : ± 0.01%			
Temp. (°C)	Power supply (Vac)	0 minute		2 minute		5 minute		10 minute	
		(MHz)	(%)	(MHz)	(%)	(MHz)	(%)	(MHz)	(%)
50	138	5319.985183	-0.000279	5319.985162	-0.000279	5319.985194	-0.000278	5319.985226	-0.000278
	120	5319.985189	-0.000278	5319.985170	-0.000279	5319.985216	-0.000278	5319.985237	-0.000278
	102	5319.985178	-0.000279	5319.985151	-0.000279	5319.985189	-0.000278	5319.985261	-0.000277
40	138	5319.990396	-0.000181	5319.990325	-0.000182	5319.990387	-0.000181	5319.990436	-0.000180
	120	5319.990405	-0.000180	5319.990296	-0.000182	5319.990399	-0.000180	5319.990410	-0.000180
	102	5319.990389	-0.000181	5319.990287	-0.000183	5319.990414	-0.000180	5319.990439	-0.000180
30	138	5319.996795	-0.000060	5319.996892	-0.000058	5319.996756	-0.000061	5319.996984	-0.000057
	120	5319.996714	-0.000062	5319.996844	-0.000059	5319.996748	-0.000061	5319.996940	-0.000058
	102	5319.996768	-0.000061	5319.996852	-0.000059	5319.996771	-0.000061	5319.996919	-0.000058
20	138	5320.003514	0.000066	5320.003249	0.000061	5320.003432	0.000065	5320.003410	0.000064
	120	5320.003639	0.000068	5320.003263	0.000061	5320.003455	0.000065	5320.003492	0.000066
	102	5320.003587	0.000067	5320.003297	0.000062	5320.003481	0.000065	5320.003468	0.000065
10	138	5320.009354	0.000176	5320.009172	0.000172	5320.009019	0.000170	5320.009332	0.000175
	120	5320.009295	0.000175	5320.009146	0.000172	5320.009035	0.000170	5320.009358	0.000176
	102	5320.009314	0.000175	5320.009190	0.000173	5320.009084	0.000171	5320.009362	0.000176
0	138	5320.013876	0.000261	5320.013532	0.000254	5320.013768	0.000259	5320.013139	0.000247
	120	5320.013941	0.000262	5320.013587	0.000255	5320.013774	0.000259	5320.013543	0.000255
	102	5320.013990	0.000263	5320.013516	0.000254	5320.013709	0.000258	5320.013682	0.000257
-10	138	5320.019539	0.000367	5320.019116	0.000359	5320.019155	0.000360	5320.019496	0.000366
	120	5320.019604	0.000368	5320.019286	0.000363	5320.019187	0.000361	5320.019420	0.000365
	102	5320.019532	0.000367	5320.019183	0.000361	5320.019236	0.000362	5320.019458	0.000366
-20	138	5320.025263	0.000475	5320.025485	0.000479	5320.025625	0.000482	5320.025394	0.000477
	120	5320.025270	0.000475	5320.025422	0.000478	5320.025631	0.000482	5320.025376	0.000477
	102	5320.025248	0.000475	5320.025416	0.000478	5320.025674	0.000483	5320.025458	0.000479
-30	138	5320.025060	0.000471	5320.029516	0.000555	5320.029387	0.000552	5320.029649	0.000557
	120	5320.029591	0.000556	5320.029528	0.000555	5320.029401	0.000553	5320.029657	0.000557
	102	5320.029519	0.000555	5320.029593	0.000556	5320.029358	0.000552	5320.029506	0.000555



4.7 BAND EDGES MEASUREMENT

4.7.1 TEST INSTRUMENTS

Description & Manufacturer	Model No.	Serial No.	Calibrated Until
SPECTRUM ANALYZER	FSEK30	100049	Aug. 14, 2006

NOTE: The calibration interval of the above test instruments is 12 months and the calibrations are traceable to NML/ROC and NIST/USA.

4.7.2 TEST PROCEDURE

The transmitter output was connected to the spectrum analyzer via a low lose cable. Set both RBW and VBW of spectrum analyzer to 1MHz with suitable frequency span including 100 MHz bandwidth from band edge. The band edges was measured and recorded.

4.7.3 EUT OPERATING CONDITION

The software provided by client to enable the EUT under transmission condition continuously at specific channel frequencies individually.

4.7.4 TEST RESULTS

For signals in the restricted bands above and below the 5.15 to 5.35GHz allocated band a measurement was made of the amplitude of the spurious emissions with respect to the intentional signals. The relative amplitude, in dBc, was applied to the average and peak filed strength of the intentional signal made on the OATS to calculate the field strength of the unintentional signals.

The spectrum plots (Peak RBW=VBW=1MHz; Average RBW=1MHz, VBW=10Hz) are attached on the following pages.

**For 5180 ~ 5320MHz band****Channel 1 (5180MHz)**

The band edge emission plot on page 56 shows 49.86Bc between carrier maximum power and local maximum emission in restrict band. The emission of carrier strength list in the test result of channel 1 is 110.80dBuV/m (Peak), so the maximum field strength in restrict band is $110.80-49.86=60.94$ dBuV/m which is under 74dBuV/m limit.

The band edge emission plot on page 56 shows 52.17dBc between carrier maximum power and local maximum emission in restrict band. The emission of carrier strength list in the test result of channel 1 is 101.57dBuV/m (Average), so the maximum field strength in restrict band is $101.57-52.17=49.40$ dBuV/m which is under 54dBuV/m limit.

Channel 8 (5320MHz)

The band edge emission plot on page 57 shows 50.66dBc between carrier maximum power and local maximum emission in restrict band. The emission of carrier strength list in the test result of channel 8 is 108.38dBuV/m (Peak), so the maximum field strength in restrict band is $108.38-50.66=57.72$ dBuV/m which is under 74dBuV/m limit.

The band edge emission plot on page 58 shows 52.53dBc between carrier maximum power and local maximum emission in restrict band. The emission of carrier strength list in the test result of channel 8 is 99.45dBuV/m (Average), so the maximum field strength in restrict band is $99.45-52.53=46.92$ dBuV/m which is under 54dBuV/m limit.

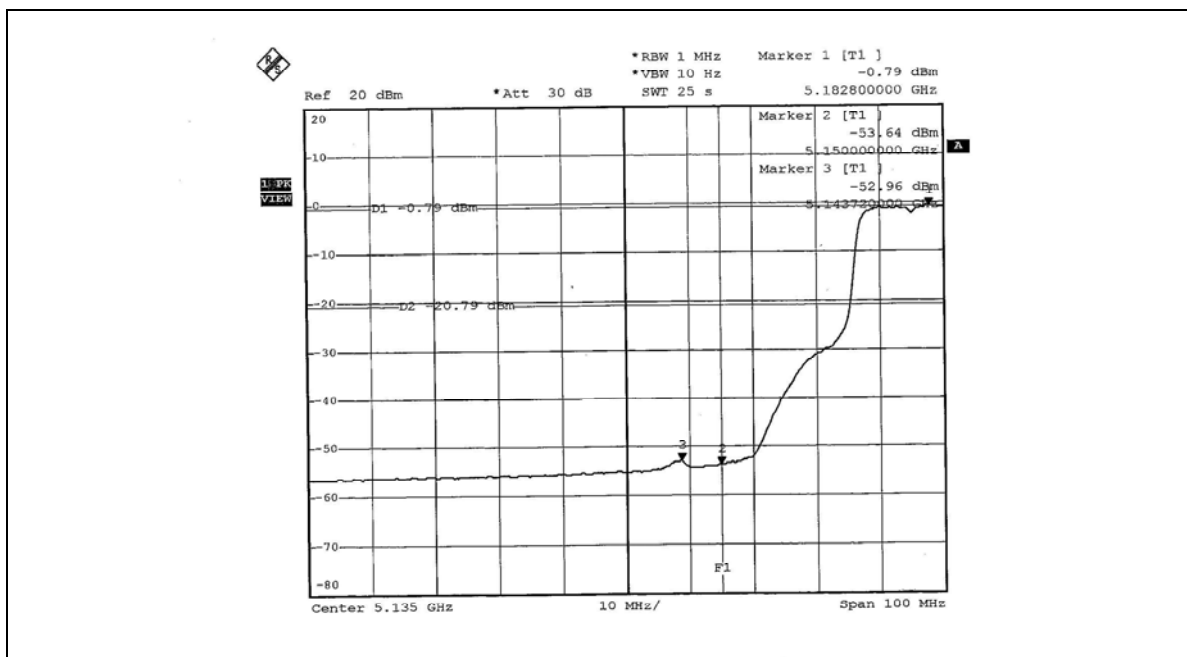
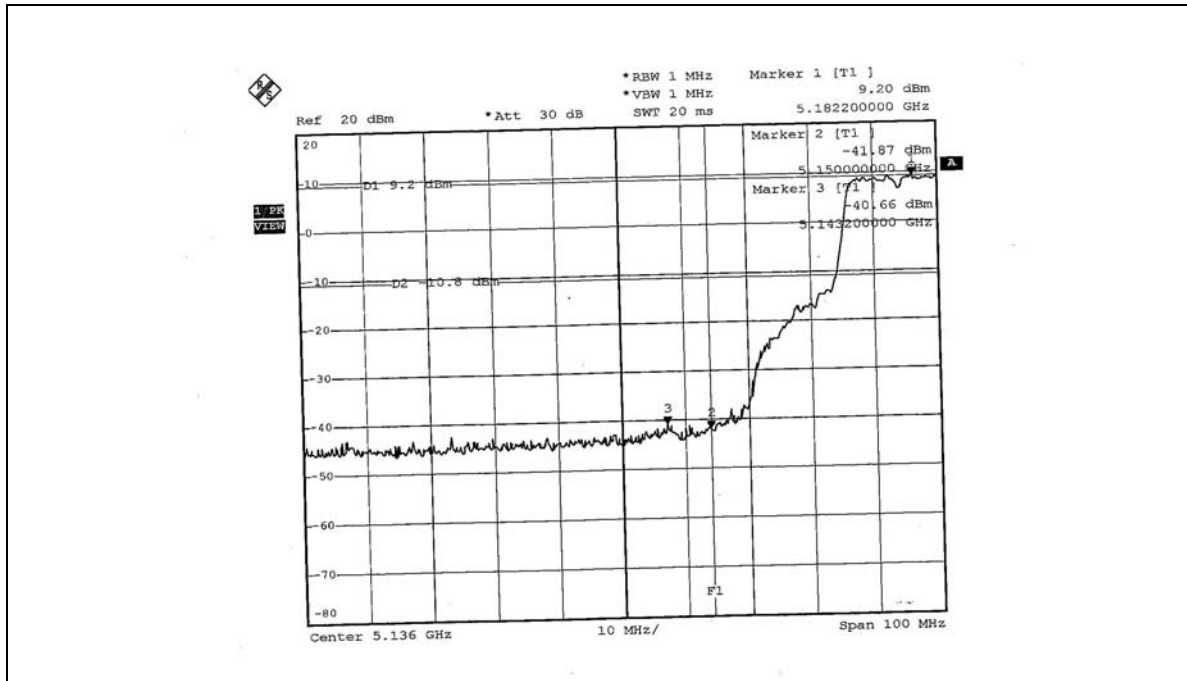

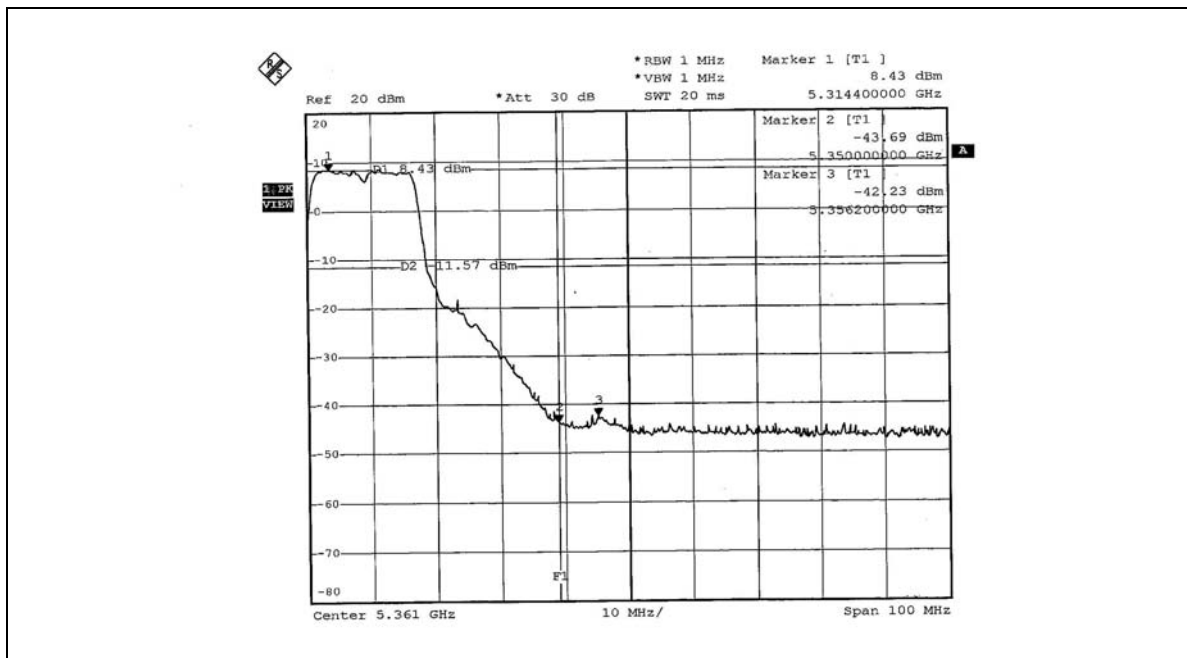
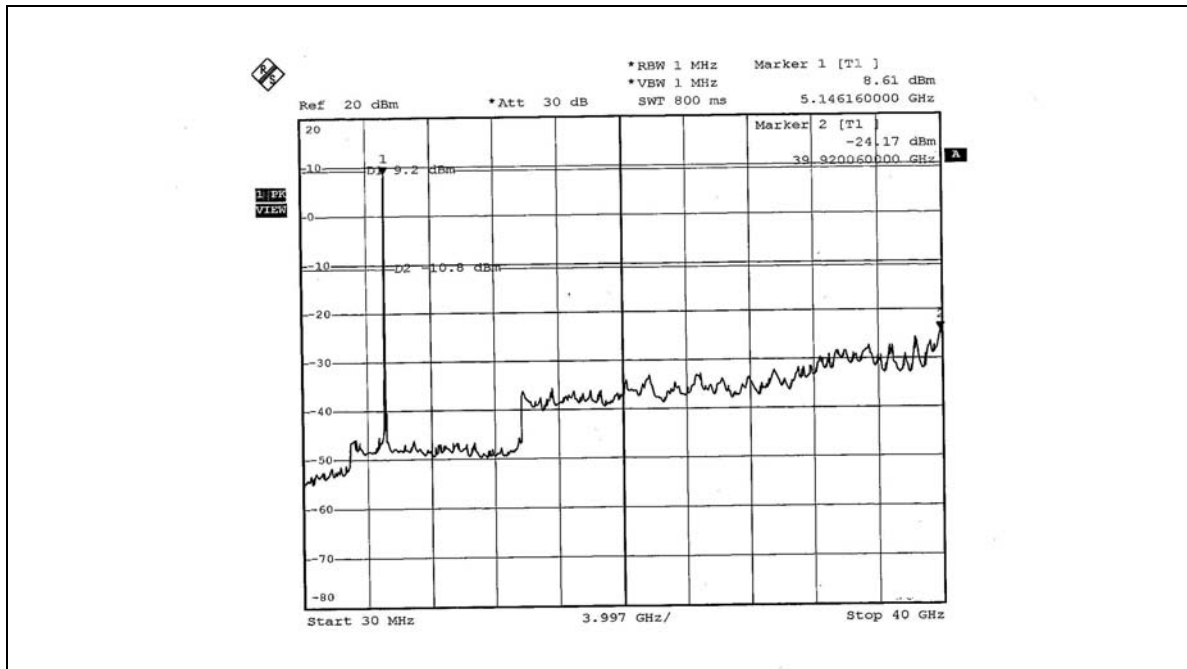

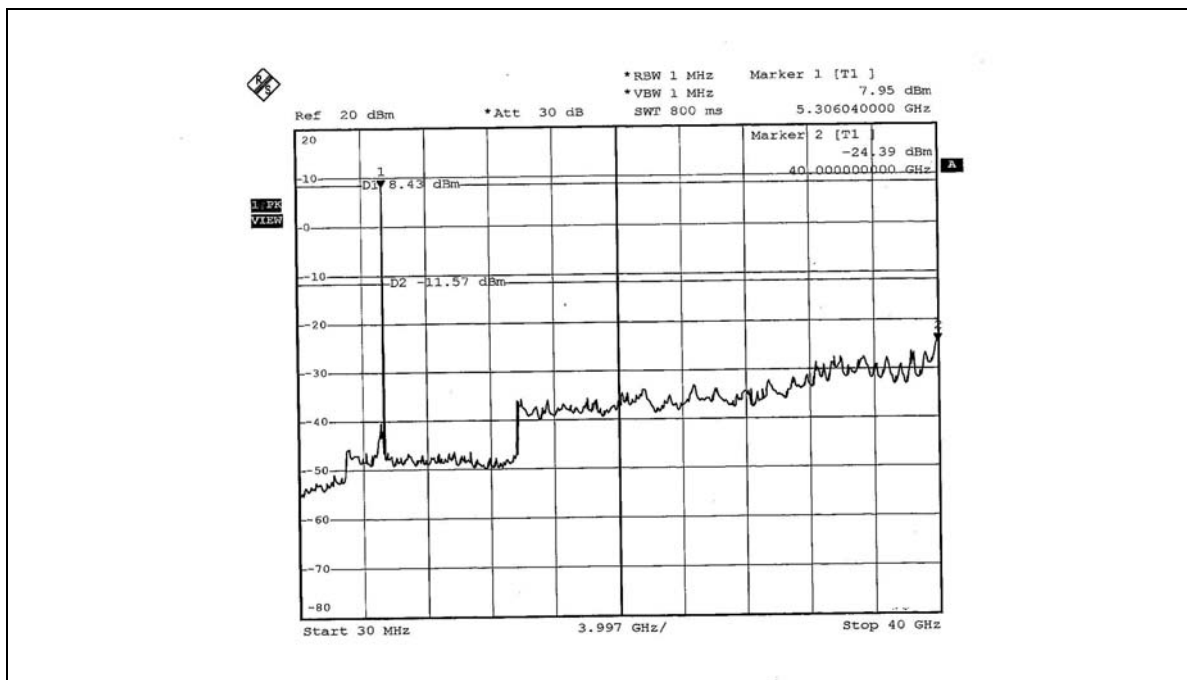
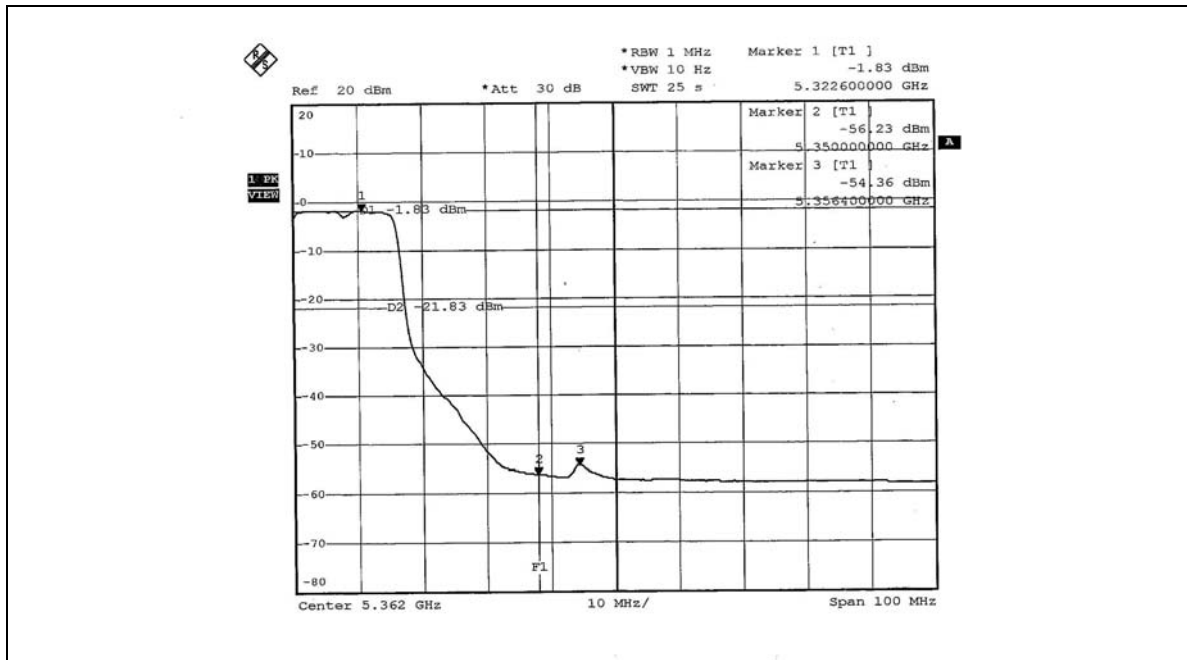



4.8 ANTENNA REQUIREMENT

4.8.1 STANDARD APPLICABLE

For intentional device, according to FCC 47 CFR Section 15.203, an intentional radiator shall be designed to ensure that no antenna other than that furnished by the responsible party shall be used with the device.

And according to FCC 47 CFR Section 15.407(a), if transmitting antennas of directional gain greater than 6dBi are used, the power shall be reduced by the amount in dB that the directional gain of the antenna exceeds 6dBi.

4.8.2 ANTENNA CONNECTED CONSTRUCTION

The antenna used in this product is PIFA antenna with UFL connector. The maximum Gain of the antenna is 2.5dBi.



5. INFORMATION ON THE TESTING LABORATORIES

We, ADT Corp., were founded in 1988 to provide our best service in EMC, Radio, Telecom and Safety consultation. Our laboratories are accredited and approved by the following approval agencies according to ISO/IEC 17025.

USA	FCC, NVLAP, UL, A2LA
Germany	TUV Rheinland
Japan	VCCI
Norway	NEMKO
Canada	INDUSTRY CANADA , CSA
R.O.C.	CNLA, BSMI, DGT
Netherlands	Telefication
Singapore	PSB , GOST-ASIA(MOU)
Russia	CERTIS(MOU)

Copies of accreditation certificates of our laboratories obtained from approval agencies can be downloaded from our web site:

www.adt.com.tw/index.5/phtml. If you have any comments, please feel free to contact us at the following:

Linko EMC/RF Lab:

Tel: 886-2-26052180

Fax: 886-2-26052943

Hsin Chu EMC/RF Lab:

Tel: 886-3-5935343

Fax: 886-3-5935342

Hwa Ya EMC/RF/Safety Telecom Lab:

Tel: 886-3-3183232

Fax: 886-3-3185050

Linko RF Lab.

Tel: 886-3-3270910

Fax: 886-3-3270892

Web Site: www.adt.com.tw

The address and road map of all our labs can be found in our web site also.



APPENDIX-A

MODIFICATIONS RECORDERS FOR ENGINEERING CHANGES TO THE EUT BY THE LAB

No any modifications are made to the EUT by the lab during the test.