



FCC TEST REPORT

(PART 15, SUBPART C, 15.247)

REPORT NO.: RF940915L13A
MODEL NO.: MC7090
RECEIVED: Sep. 02, 2005
TESTED: Sep. 02 ~ Oct. 17, 2005
ISSUED: Oct. 19, 2005

APPLICANT: Symbol Technologies, Inc.

ADDRESS: One Symbol Plaza, Holtsville, NY 11742-1300, U.S.A.

ISSUED BY: Advance Data Technology Corporation

LAB ADDRESS: No. 47, 14th Ling, Chia Pau Tsuen, Lin Kou Hsiang 244, Taipei Hsien, Taiwan, R.O.C.

TEST LOCATION: No. 19, Hwa Ya 2nd Rd., Wen Hwa Tsuen, Kwei Shan Hsiang, Taoyuan Hsien 333, Taiwan, R.O.C.

This test report consists of 166 pages in total. It may be duplicated completely for legal use with the approval of the applicant. It should not be reproduced except in full, without the written approval of our laboratory. The client should not use it to claim product endorsement by CNLA, A2LA or any government agencies. The test results in the report only apply to the tested sample.



0528
ILAC MRA



No. 2177-01



Table of Contents

1.	CERTIFICATION	7
2.	SUMMARY OF TEST RESULTS	8
2.1	MEASUREMENT UNCERTAINTY	8
3.	GENERAL INFORMATION.....	9
3.1	GENERAL DESCRIPTION OF EUT	9
3.2	DESCRIPTION OF TEST MODES.....	11
3.2.1	CONFIGURATION OF SYSTEM UNDER TEST	13
3.2.2	TEST MODE APPLICABILITY AND TESTED CHANNEL DETAIL	14
3.3	GENERAL DESCRIPTION OF APPLIED STANDARDS	19
3.4	DESCRIPTION OF SUPPORT UNITS	19
4.	TEST TYPES AND RESULTS (FOR 802.11b & g 2412~2462MHz BAND).....	20
4.1	CONDUCTED EMISSION MEASUREMENT	20
4.1.1	LIMITS OF CONDUCTED EMISSION MEASUREMENT.....	20
4.1.2	TEST INSTRUMENTS.....	20
4.1.3	TEST PROCEDURES	21
4.1.4	DEVIATION FROM TEST STANDARD	21
4.1.5	TEST SETUP	22
4.1.6	EUT OPERATING CONDITIONS	22
4.1.7	TEST RESULTS	23
4.2	RADIATED EMISSION MEASUREMENT	35
4.2.1	LIMITS OF RADIATED EMISSION MEASUREMENT.....	35
4.2.2	TEST INSTRUMENTS.....	36
4.2.3	TEST PROCEDURES	37
4.2.4	DEVIATION FROM TEST STANDARD	37
4.2.5	TEST SETUP	38
4.2.6	EUT OPERATING CONDITIONS	38
4.2.7	TEST RESULTS	39
4.3	6dB BANDWIDTH MEASUREMENT	48
4.3.1	LIMITS OF 6dB BANDWIDTH MEASUREMENT	48
4.3.2	TEST INSTRUMENTS.....	48
4.3.3	TEST PROCEDURE.....	49
4.3.4	DEVIATION FROM TEST STANDARD	49
4.3.5	TEST SETUP	49
4.3.6	EUT OPERATING CONDITIONS	49
4.3.7	TEST RESULTS	50
4.4	MAXIMUM PEAK OUTPUT POWER	56



4.4.1 LIMITS OF MAXIMUM PEAK OUTPUT POWER MEASUREMENT 56

4.4.2 INSTRUMENTS..... 56

4.4.1 TEST PROCEDURES 57

4.4.2 DEVIATION FROM TEST STANDARD 57

4.4.3 TEST SETUP 57

4.4.4 EUT OPERATING CONDITIONS 57

4.4.3 TEST RESULTS 58

4.5 POWER SPECTRAL DENSITY MEASUREMENT 59

4.5.1 LIMITS OF POWER SPECTRAL DENSITY MEASUREMENT 59

4.5.2 TEST INSTRUMENTS..... 59

4.5.3 TEST PROCEDURE..... 60

4.5.4 DEVIATION FROM TEST STANDARD 60

4.5.5 TEST SETUP 60

4.5.6 EUT OPERATING CONDITION 60

4.5.7 TEST RESULTS 61

4.6 BAND EDGES MEASUREMENT 67

4.6.1 LIMITS OF BAND EDGES MEASUREMENT 67

4.6.2 TEST INSTRUMENTS..... 67

4.6.3 TEST PROCEDURE..... 67

4.6.4 DEVIATION FROM TEST STANDARD 67

4.6.5 EUT OPERATING CONDITION 67

4.6.6 TEST RESULTS 68

4.7 ANTENNA REQUIREMENT 76

4.7.1 STANDARD APPLICABLE 76

4.7.2 ANTENNA CONNECTED CONSTRUCTION 76

5. TEST TYPES AND RESULTS (FOR 802.11a 5745~5825MHz Band) 77

5.1 CONDUCTED EMISSION MEASUREMENT 77

5.1.1 LIMITS OF CONDUCTED EMISSION MEASUREMENT..... 77

5.1.2 TEST INSTRUMENTS..... 77

5.1.3 TEST PROCEDURES 78

5.1.4 DEVIATION FROM TEST STANDARD 78

5.1.5 TEST SETUP 79

5.1.6 EUT OPERATING CONDITIONS 79

5.1.7 TEST RESULTS 80

5.2 RADIATED EMISSION MEASUREMENT 84

5.2.1 LIMITS OF RADIATED EMISSION MEASUREMENT..... 84

5.2.2 TEST INSTRUMENTS..... 85

5.2.3 TEST PROCEDURES 86

5.2.4 DEVIATION FROM TEST STANDARD 86



5.2.5 TEST SETUP 87

5.2.6 EUT OPERATING CONDITIONS 87

5.2.7 TEST RESULTS 88

5.3 6dB BANDWIDTH MEASUREMENT 94

5.3.1 LIMITS OF 6dB BANDWIDTH MEASUREMENT 94

5.3.2 TEST INSTRUMENTS..... 94

5.3.3 TEST PROCEDURE..... 95

5.3.4 DEVIATION FROM TEST STANDARD 95

5.3.5 TEST SETUP 95

5.3.6 EUT OPERATING CONDITIONS 95

5.3.7 TEST RESULTS 96

5.4 MAXIMUM PEAK OUTPUT POWER 99

5.4.1 LIMITS OF MAXIMUM PEAK OUTPUT POWER MEASUREMENT 99

5.4.2 INSTRUMENTS..... 99

5.4.3 TEST PROCEDURES 100

5.4.4 DEVIATION FROM TEST STANDARD 100

5.4.5 TEST SETUP 100

5.4.6 EUT OPERATING CONDITIONS 100

5.4.7 TEST RESULTS 101

5.5 POWER SPECTRAL DENSITY MEASUREMENT 102

5.5.1 LIMITS OF POWER SPECTRAL DENSITY MEASUREMENT 102

5.5.2 TEST INSTRUMENTS..... 102

5.5.3 TEST PROCEDURE..... 103

5.5.4 DEVIATION FROM TEST STANDARD 103

5.5.5 TEST SETUP 103

5.5.6 EUT OPERATING CONDITION 103

5.5.7 TEST RESULTS 104

5.6 BAND EDGES MEASUREMENT 107

5.6.1 LIMITS OF BAND EDGES MEASUREMENT 107

5.6.2 TEST INSTRUMENTS..... 107

5.6.3 TEST PROCEDURE..... 107

5.6.4 DEVIATION FROM TEST STANDARD 107

5.6.5 EUT OPERATING CONDITION 108

5.6.6 TEST RESULTS 108

5.7 ANTENNA REQUIREMENT 112

5.7.1 STANDARD APPLICABLE 112

5.7.2 ANTENNA CONNECTED CONSTRUCTION 112

6. TEST TYPES AND RESULTS (FOR BLUETOOTH) 113

6.1.1 CONDUCTED EMISSION MEASUREMENT 113



6.1.2 LIMITS OF CONDUCTED EMISSION MEASUREMENT..... 113

6.1.3 TEST INSTRUMENTS..... 113

6.1.4 TEST PROCEDURES 114

6.1.5 DEVIATION FROM TEST STANDARD 114

6.1.6 TEST SETUP 115

6.1.7 EUT OPERATING CONDITIONS 115

6.1.8 TEST RESULTS 116

6.2 RADIATED EMISSION MEASUREMENT 128

6.2.1 LIMITS OF RADIATED EMISSION MEASUREMENT..... 128

6.2.2 TEST INSTRUMENTS..... 129

6.2.3 TEST PROCEDURES 130

6.2.4 DEVIATION FROM TEST STANDARD 130

6.2.5 TEST SETUP 131

6.2.6 EUT OPERATING CONDITIONS 131

6.2.7 TEST RESULTS 132

6.3 NUMBER OF HOPPING FREQUENCY USED 138

6.3.1 LIMIT OF HOPPING FREQUENCY USED 138

6.3.2 TEST INSTRUMENTS..... 138

6.3.3 TEST PROCEDURES 138

6.3.4 DEVIATION FROM TEST STANDARD 139

6.3.5 TEST SETUP 139

6.3.6 TEST RESULTS 139

6.4 DWELL TIME ON EACH CHANNEL 141

6.4.1 LIMIT OF DWELL TIME USED..... 141

6.4.2 TEST INSTRUMENTS..... 141

6.4.3 TEST PROCEDURES 141

6.4.4 DEVIATION FROM TEST STANDARD 141

6.4.5 TEST SETUP 142

6.4.6 TEST RESULTS 142

6.5 CHANNEL BANDWIDTH..... 146

6.5.1 LIMITS OF CHANNEL BANDWIDTH 146

6.5.2 TEST INSTRUMENTS..... 146

6.5.3 TEST PROCEDURE..... 146

6.5.4 DEVIATION FROM TEST STANDARD 146

6.5.5 TEST SETUP 147

6.5.6 EUT OPERATING CONDITION 147

6.5.7 TEST RESULTS 148

6.6 HOPPING CHANNEL SEPARATION 151

6.6.1 LIMIT OF HOPPING CHANNEL SEPARATION 151



6.6.2	TEST INSTRUMENTS.....	151
6.6.3	TEST PROCEDURES	151
6.6.4	DEVIATION FROM TEST STANDARD	151
6.6.5	TEST SETUP	151
6.6.6	TEST RESULTS	152
6.7	MAXIMUM PEAK OUTPUT POWER	155
6.7.1	LIMITS OF MAXIMUM PEAK OUTPUT POWER MEASUREMENT	155
6.7.2	TEST INSTRUMENTS.....	155
6.7.3	TEST PROCEDURES	155
6.7.4	DEVIATION FROM TEST STANDARD	155
6.7.5	TEST SETUP	156
6.7.6	EUT OPERATING CONDITION	156
6.7.7	TEST RESULTS	157
6.8	BAND EDGES MEASUREMENT	160
6.8.1	LIMITS OF BAND EDGES MEASUREMENT	160
6.8.2	TEST INSTRUMENTS.....	160
6.8.3	TEST PROCEDURE.....	160
6.8.4	DEVIATION FROM TEST STANDARD	160
6.8.5	EUT OPERATING CONDITION	160
6.8.6	TEST RESULTS	161
6.9	ANTENNA REQUIREMENT	164
6.9.1	STANDARD APPLICABLE	164
6.9.2	ANTENNA CONNECTED CONSTRUCTION	164
7.	INFORMATION ON THE TESTING LABORATORIES	165



1. CERTIFICATION

PRODUCT: EDA (Enterprise Digital Assistant)
MODEL: MC7090
BRAND: Symbol
APPLICANT: Symbol Technologies, Inc.
TEST SAMPLE: PROTOTYPE
TESTED: Sep. 02 ~ Oct. 17, 2005
STANDARDS: FCC Part 15, Subpart C (Section 15.247),
ANSI C63.4-2003

The above equipment has been tested by **Advance Data Technology Corporation**, and found compliance with the requirement of the above standards. The test record, data evaluation & Equipment Under Test (EUT) configurations represented herein are true and accurate accounts of the measurements of the sample's EMC characteristics under the conditions specified in this report.

PREPARED BY : Andrea Hsia , **DATE:** Oct. 19, 2005
Andrea Hsia

TECHNICAL
ACCEPTANCE : Gary Chang , **DATE:** Oct. 19, 2005
Responsible for RF
Gary Chang

APPROVED BY : Cody Chang , **DATE:** Oct. 19, 2005
Cody Chang / Deputy Manager

2. SUMMARY OF TEST RESULTS

The EUT has been tested according to the following specifications:

APPLIED STANDARD: FCC Part 15, Subpart C (Section 15.247)			
Standard Section	Test Type and Limit	Result	Remark
15.207	AC Power Conducted Emission	PASS	Meet the requirement of limit. Minimum passing margin is -14.76dB at 0.201MHz
15.247(a)(2)	Spectrum Bandwidth of a Direct Sequence Spread Spectrum System Limit: min. 500kHz	PASS	Meet the requirement of limit.
15.247(b)	Maximum Peak Output Power Limit: max. 30dBm	PASS	Meet the requirement of limit.
15.247(d)	Radiated Emissions Limit: Table 15.209	PASS	Meet the requirement of limit. Minimum passing margin is -5.92dB at 2390.00MHz
15.247(e)	Power Spectral Density Limit: max. 8dBm	PASS	Meet the requirement of limit.
15.247(d)	Band Edge Measurement Limit: 20dB less than the peak value of fundamental frequency	PASS	Meet the requirement of limit.

2.1 MEASUREMENT UNCERTAINTY

Where relevant, the following measurement uncertainty levels have been estimated for tests performed on the EUT as specified in CISPR 16-4:

Measurement	Frequency	Uncertainty
Conducted emissions	9kHz~30MHz	2.44 dB
Radiated emissions	30MHz ~ 200MHz	3.73 dB
	200MHz ~ 1000MHz	3.74 dB
	1GHz ~ 18GHz	2.20 dB
	18GHz ~ 40GHz	1.88 dB

This uncertainty represents an expanded uncertainty expressed at approximately the 95% confidence level using a coverage factor of k=2.



3. GENERAL INFORMATION

3.1 GENERAL DESCRIPTION OF EUT

EUT	EDA (Enterprise Digital Assistant)
MODEL NO.	MC7090
POWER SUPPLY	3.7Vdc from rechargeable lithium battery 5.4Vdc from power adapter for charger 12.0Vdc from power adapter for cradle
MODULATION TYPE	Wireless LAN: CCK, DQPSK, DBPSK for DSSS 64QAM, 16QAM, QPSK, BPSK for OFDM Bluetooth: GFSK for FHSS
MODULATION TECHNOLOGY	DSSS, OFDM, FHSS
TRANSFER RATE	Wireless LAN: 802.11b: 11/5.5/2/1Mbps 802.11g: 54/48/36/24/18/12/9/6Mbps 802.11a: 54/48/36/24/18/12/9/6Mbps Bluetooth: 723Kbps
FREQUENCY RANGE	Wireless LAN: 802.11b & 802.11g: 2.412 ~ 2.462GHz 802.11a: 5.745 ~ 5.825GHz Bluetooth: 2.402 ~ 2.480GHz
NUMBER OF CHANNEL	Wireless LAN: 802.11b & 802.11g: 11 802.11a: 5 Bluetooth: 79
CHANNEL SPACING	Wireless LAN: 802.11b & 802.11g: 5MHz 802.11a: 20MHz Bluetooth: 1MHz
OUTPUT POWER	Wireless LAN: 40.551mW for 802.11b 44.771mW for 802.11g 40.551mW for 5.745 ~ 5.825GHz Bluetooth: 1.057mW
ANTENNA TYPE	Wireless LAN: PIFA antenna with 2.0dBi gain (for 2.4GHz) PIFA antenna with 2.5dBi gain (for 5.0GHz) Bluetooth: Chip antenna with 2.0dBi gain
DATA CABLE	0.92m non-shielded cable for earphone
I/O PORTS	Refer to user's manual
ASSOCIATED DEVICES	Earphone, cradle

**NOTE:**

1. The EUT is an EDA (Enterprise Digital Assistant) with wireless LAN and bluetooth functions.
2. The wireless LAN included two dual band antennas. After pre-testing both primary and auxiliary antennas, the former as the worst case, was chosen for final test.
3. The EDA supports two battery options, Heavy (high capacity) and Main (normal). Both options were assessed and the heavy battery was found to be worst case and was selected for the final test configuration.

HEAVY BATTERY:	
BRAND:	Symbol
MODEL:	82-71364-01
RATING:	3.7Vdc, 3800 mAh

MAIN BATTERY:	
BRAND:	Symbol
MODEL:	82-71363-01
RATING:	3.7Vdc, 1900 mAh

4. The cradle was operated with following power adapter:

BRAND:	HIPRO
MODEL:	HP-O2040D43
INPUT:	100-240Vac, 50-60Hz, 1.5A
OUTPUT:	12Vdc, 3.33A
POWER LINE:	AC 1.8m non-shielded cable without core DC 1.8m non-shielded cable with one core

5. The EUT was operated with following charging cradle:

BRAND:	Delta
MODEL:	ADP-16GB A
INPUT:	100-240Vac, 50-60Hz, 0.4A
OUTPUT:	5.4Vdc, 3A
POWER LINE:	AC 0.7m non-shielded cable without core DC 1.87m non-shielded cable with one core

6. The EUT operates in both the 5GHz and 2.4GHz Bands and compatibility with 802.11a and 802.11b, 802.11g technology.
7. The above EUT information was declared by the manufacturer and for more detailed features description, please refer to the manufacturer's specifications or User's Manual.

3.2 DESCRIPTION OF TEST MODES

Since the EUT is considered a portable unit, it was pre-tested on the positioned of each 3 axis. The worst case was found when positioned on X-plane. Therefore only the test data of this X-plane was used for radiated test.

Operated in 2400 ~ 2483.5MHz band:

11 channels are provided to the EUT for wireless LAN function:

CHANNEL	FREQUENCY	CHANNEL	FREQUENCY
1	2412 MHz	7	2442 MHz
2	2417 MHz	8	2447 MHz
3	2422 MHz	9	2452 MHz
4	2427 MHz	10	2457 MHz
5	2432 MHz	11	2462 MHz
6	2437 MHz		

79 channels are provided to this EUT for bluetooth function:

CHANNEL	FREQ. (MHz)	CHANNEL	FREQ. (MHz)	CHANNEL	FREQ. (MHz)	CHANNEL	FREQ. (MHz)
0	2402	20	2422	40	2442	60	2462
1	2403	21	2423	41	2443	61	2463
2	2404	22	2424	42	2444	62	2464
3	2405	23	2425	43	2445	63	2465
4	2406	24	2426	44	2446	64	2466
5	2407	25	2427	45	2447	65	2467
6	2408	26	2428	46	2448	66	2468
7	2409	27	2429	47	2449	67	2469
8	2410	28	2430	48	2450	68	2470
9	2411	29	2431	49	2451	69	2471
10	2412	30	2431	50	2452	70	2472
11	2413	31	2433	51	2453	71	2473
12	2414	32	2434	52	2454	72	2474
13	2415	33	2435	53	2455	73	2475
14	2416	34	2436	54	2456	74	2476
15	2417	35	2437	55	2457	75	2477
16	2418	36	2438	56	2458	76	2478
17	2419	37	2439	57	2459	77	2479
18	2420	38	2440	58	2460	78	2480
19	2421	39	2441	59	2461		



Operated in 5745 ~ 5825MHz band:

5 channels are provided to this EUT for wireless LAN function:

CHANNEL	FREQUENCY
1	5745 MHz
2	5765 MHz
3	5785 MHz
4	5805 MHz
5	5825 MHz

3.2.1 CONFIGURATION OF SYSTEM UNDER TEST

Mode 1

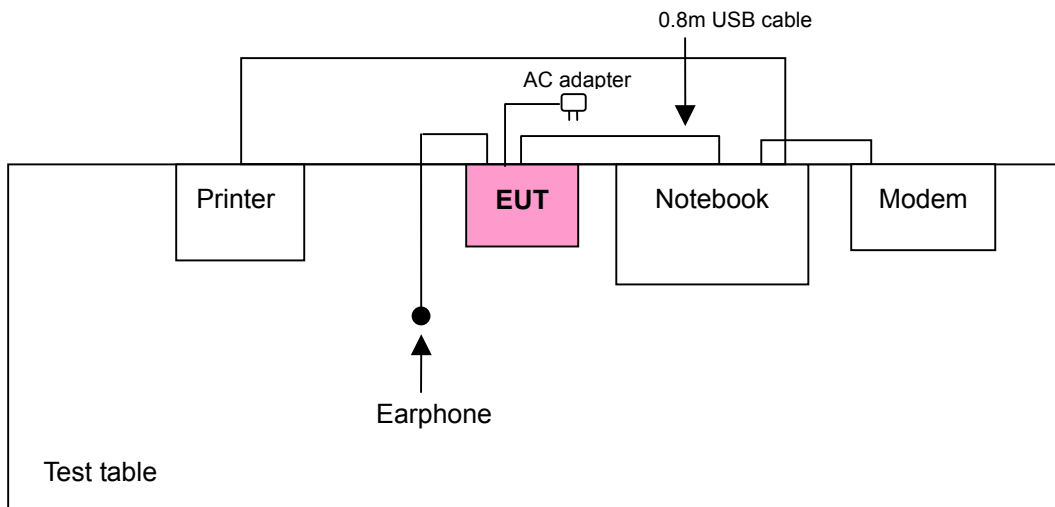

Mode 2

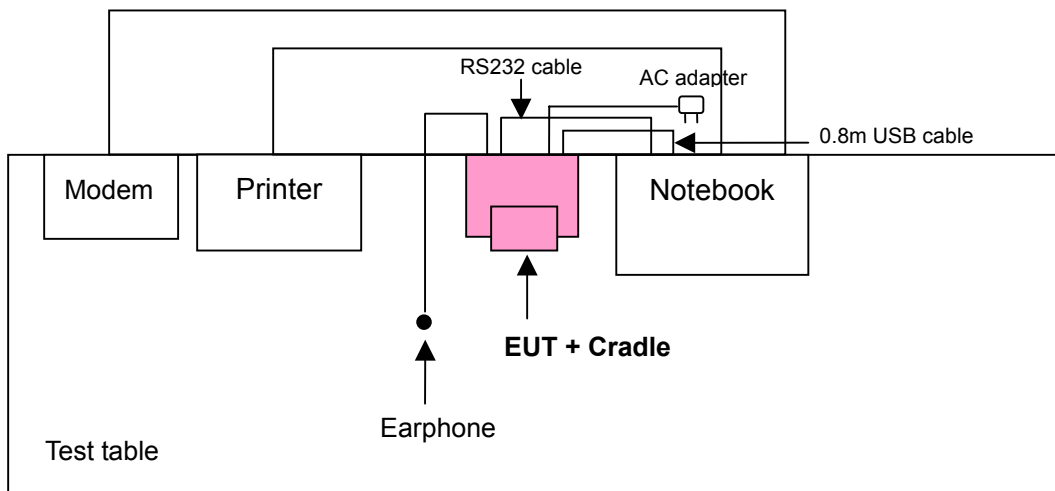

Mode 3

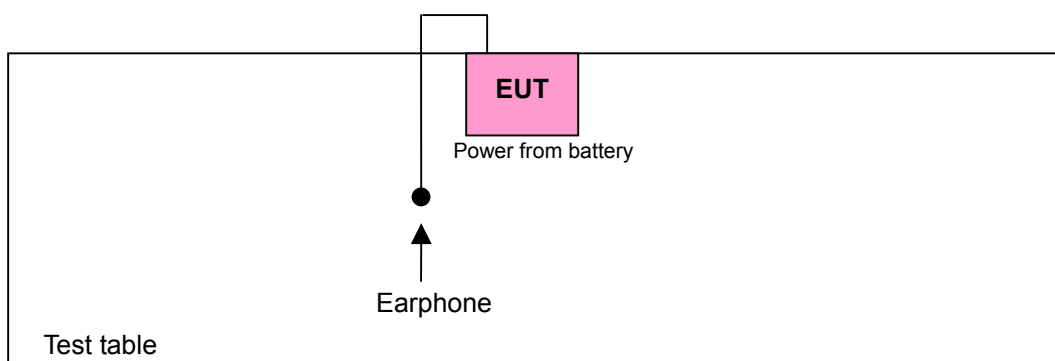



3.2.2 TEST MODE APPLICABILITY AND TESTED CHANNEL DETAIL

FOR WIRELESS LAN FUNCTION:

EUT configure mode	Applicable to				Description
	PLC	RE<1G	RE≥1G	APCM	
A	√	√	√	√	The EUT with heavy battery connected with the earphone, and was powered by the adapter mode: ADP-16GB A
B	√	√	-	-	The EUT with heavy battery connected with the earphone and cradle, and was powered by the adapter model: HP-O2040D43
C	-	√	-	-	The EUT with heavy battery connected with the earphone

Where PLC: Power Line Conducted Emission RE<1G RE: Radiated Emission below 1GHz
 RE≥1G: Radiated Emission above 1GHz APCM: Antenna Port Conducted Measurement

NOTE: “-“ means no effect.

POWER LINE CONDUCTED EMISSION TEST:

- Pre-Scan has been conducted to determine the worst-case mode from all possible combinations between available modulations, data rates and antenna ports (if EUT with antenna diversity architecture).
- Following channel(s) was (were) selected for the final test as listed below.

EUT CONFIGURE MODE	Mode	AVAILABLE CHANNEL	TESTED CHANNEL	MODULATION TECHNOLOGY	MODULATION TYPE	DATA RATE (Mbps)
A	802.11b	1 to 11	1, 6, 11	DSSS	CCK	11
A	802.11g	1 to 11	1, 6, 11	OFDM	BPSK	6
A	802.11a	1 to 5	5	OFDM	BPSK	6
B	802.11b	1 to 11	1, 6, 11	DSSS	CCK	11
B	802.11g	1 to 11	1, 6, 11	OFDM	BPSK	6
B	802.11a	1 to 5	5	OFDM	BPSK	6

**RADIATED EMISSION TEST (BELOW 1 GHz):**

- Pre-Scan has been conducted to determine the worst-case mode from all possible combinations between available modulations, data rates, antenna ports (if EUT with antenna diversity architecture), and X, Y and Z Axis.
- Following channel(s) was (were) selected for the final test as listed below.

EUT CONFIGURE MODE	MODE	AVAILABLE CHANNEL	TESTED CHANNEL	MODULATION TECHNOLOGY	MODULATION TYPE	DATA RATE (Mbps)	AXIS
A	802.11b	1 to 11	11	DSSS	CCK	11	X
A	802.11g	1 to 11	11	OFDM	BPSK	6	X
A	802.11a	1 to 5	5	OFDM	BPSK	6	X
B	802.11b	1 to 11	11	DSSS	CCK	11	-
B	802.11g	1 to 11	11	OFDM	BPSK	6	-
B	802.11a	1 to 5	5	OFDM	BPSK	6	-
C	802.11b	1 to 11	11	DSSS	CCK	11	X
C	802.11g	1 to 11	11	OFDM	BPSK	6	X
C	802.11a	1 to 5	5	OFDM	BPSK	6	X

RADIATED EMISSION TEST (ABOVE 1 GHz):

- Pre-Scan has been conducted to determine the worst-case mode from all possible combinations between available modulations, data rates and antenna ports (if EUT with antenna diversity architecture), and X, Y and Z Axis.
- Following channel(s) was (were) selected for the final test as listed below.

EUT CONFIGURE MODE	MODE	AVAILABLE CHANNEL	TESTED CHANNEL	MODULATION TECHNOLOGY	MODULATION TYPE	DATA RATE (Mbps)	AXIS
A	802.11b	1 to 11	1, 6, 11	DSSS	CCK	11	X
A	802.11g	1 to 11	1, 6, 11	OFDM	BPSK	6	X
A	802.11a	1 to 5	1, 3, 5	OFDM	BPSK	6	X

BANDEDGE MEASUREMENT:

- Pre-Scan has been conducted to determine the worst-case mode from all possible combinations between available modulations, data rates and antenna ports (if EUT with antenna diversity architecture).
- Following channel(s) was (were) selected for the final test as listed below.

MODE	AVAILABLE CHANNEL	TESTED CHANNEL	MODULATION TECHNOLOGY	MODULATION TYPE	DATA RATE (Mbps)
802.11b	1 to 11	1, 11	DSSS	CCK	11
802.11g	1 to 11	1, 11	OFDM	BPSK	6
802.11a	1 to 5	1, 5	OFDM	BPSK	6

ANTENNA PORT CONDUCTED MEASUREMENT:

- Pre-Scan has been conducted to determine the worst-case mode from all possible combinations between available modulations, data rates and antenna ports (if EUT with antenna diversity architecture).
- Following channel(s) was (were) selected for the final test as listed below.

MODE	AVAILABLE CHANNEL	TESTED CHANNEL	MODULATION TECHNOLOGY	MODULATION TYPE	DATA RATE (Mbps)
802.11b	1 to 11	1, 6, 11	DSSS	CCK	11
802.11g	1 to 11	1, 6, 11	OFDM	BPSK	6
802.11a	1 to 5	1, 3, 5	OFDM	BPSK	6



FOR BLUETOOTH FUNCTION:

EUT configure mode	Applicable to				Description
	PLC	RE<1G	RE≥1G	APCM	
A	√	√	√	√	The EUT with heavy battery connected with the earphone, and was powered by the adapter mode: ADP-16GB A
B	√	√	-	-	The EUT with heavy battery connected with the earphone and cradle, and was powered by the adapter model: HP-O2040D43
C	-	√	-	-	The EUT with heavy battery connected with the earphone

Where PLC: Power Line Conducted Emission
RE≥1G: Radiated Emission above 1GHz

RE<1G RE: Radiated Emission below 1GHz
APCM: Antenna Port Conducted Measurement

NOTE: “-“ means no effect.

POWER LINE CONDUCTED EMISSION TEST:

- Pre-Scan has been conducted to determine the worst-case mode from all possible combinations between available modulations, data rates and antenna ports (if EUT with antenna diversity architecture), and packet types.
- Following channel(s) was (were) selected for the final test as listed below.

EUT CONFIGURE MODE	AVAILABLE CHANNEL	TESTED CHANNEL	MODULATION TECHNOLOGY	MODULATION TYPE	PACKET TYPE
A	0 to 78	0, 39, 78	FHSS	GFSK	DH5
B	0 to 78	0, 39, 78	FHSS	GFSK	DH5

RADIATED EMISSION TEST (BELOW 1 GHz):

- Pre-Scan has been conducted to determine the worst-case mode from all possible combinations between available modulations, data rates, antenna ports (if EUT with antenna diversity architecture), X, Y, Z Axis, and packet types.
- Following channel(s) was (were) selected for the final test as listed below.

EUT CONFIGURE MODE	AVAILABLE CHANNEL	TESTED CHANNEL	MODULATION TECHNOLOGY	MODULATION TYPE	PACKET TYPE	AXIS
A	0 to 78	78	FHSS	GFSK	DH5	X
B	0 to 78	78	FHSS	GFSK	DH5	-
C	0 to 78	78	FHSS	GFSK	DH5	X

RADIATED EMISSION TEST (ABOVE 1 GHz):

- Pre-Scan has been conducted to determine the worst-case mode from all possible combinations between available modulations, data rates and antenna ports (if EUT with antenna diversity architecture), X, Y, Z Axis, and packet types.
- Following channel(s) was (were) selected for the final test as listed below.

EUT CONFIGURE MODE	AVAILABLE CHANNEL	TESTED CHANNEL	MODULATION TECHNOLOGY	MODULATION TYPE	PACKET TYPE	AXIS
A	0 to 78	0, 39, 78	FHSS	GFSK	DH5	X

BANDEDGE MEASUREMENT:

- Pre-Scan has been conducted to determine the worst-case mode from all possible combinations between available modulations, data rates and antenna ports (if EUT with antenna diversity architecture).
- Following channel(s) was (were) selected for the final test as listed below.

AVAILABLE CHANNEL	TESTED CHANNEL	MODULATION TECHNOLOGY	MODULATION TYPE	PACKET TYPE
0 to 78	0, 78	FHSS	GFSK	DH5

ANTENNA PORT CONDUCTED MEASUREMENT:

- Pre-Scan has been conducted to determine the worst-case mode from all possible combinations between available modulations, data rates and antenna ports (if EUT with antenna diversity architecture).
- Following channel(s) was (were) selected for the final test as listed below.

AVAILABLE CHANNEL	TESTED CHANNEL	MODULATION TECHNOLOGY	MODULATION TYPE	PACKET TYPE
0 to 78	0, 39, 78	FHSS	GFSK	DH5



3.3 GENERAL DESCRIPTION OF APPLIED STANDARDS

The EUT is a RF Product. According to the specifications of the manufacturer, it must comply with the requirements of the following standards:

FCC Part 15, Subpart C. (15.247)

ANSI C63.4-2003

All test items have been performed and recorded as per the above standards.

NOTE: The EUT is also considered as a kind of computer peripheral, because the connection to computer is necessary for typical use. It has been verified to comply with the requirements of FCC Part 15, Subpart B, Class B (DoC). The test report has been issued separately.

3.4 DESCRIPTION OF SUPPORT UNITS

The EUT has been tested as an independent unit together with other necessary accessories or support units. The following support units or accessories were used to form a representative test configuration during the tests.

NO.	PRODUCT	BRAND	MODEL NO.	SERIAL NO.	FCC ID
1	NOTEBOOK COMPUTER	DELL	PP05L	16484462992	E2K24CLNS
2	MODEM	ACEEX	1414V/3	0401008269	IFAXDM1414
3	PRINTER	EPSON	LQ-300+	DCGY054147	FCC DoC Approved

NO.	SIGNAL CABLE DESCRIPTION OF THE ABOVE SUPPORT UNITS
1	NA
2	1.8 m shielded cable without core
3	1.2 m shielded cable without core

NOTE: All power cords of the above support units are non shielded (1.8m).



4. TEST TYPES AND RESULTS (FOR 802.11b & g 2412~2462MHz BAND)

4.1 CONDUCTED EMISSION MEASUREMENT

4.1.1 LIMITS OF CONDUCTED EMISSION MEASUREMENT

FREQUENCY OF EMISSION (MHz)	CONDUCTED LIMIT (dB μ V)	
	Quasi-peak	Average
0.15-0.5	66 to 56	56 to 46
0.5-5	56	46
5-30	60	50

- NOTE:**
1. The lower limit shall apply at the transition frequencies.
 2. The limit decreases in line with the logarithm of the frequency in the range of 0.15 to 0.50 MHz.
 3. All emanations from a class A/B digital device or system, including any network of conductors and apparatus connected thereto, shall not exceed the level of field strengths specified above.

4.1.2 TEST INSTRUMENTS

DESCRIPTION & MANUFACTURER	MODEL NO.	SERIAL NO.	CALIBRATED UNTIL
Test Receiver ROHDE & SCHWARZ	ESCS30	100288	Nov. 06, 2005
RF signal cable Woken	5D-FB	Cable-HyC02-01	Jan. 09, 2006
LISN ROHDE & SCHWARZ	ESH2-Z5	100100	Jan. 20, 2006
LISN ROHDE & SCHWARZ	ESH3-Z5	100311	Jan. 20, 2006
Software ADT	ADT_Cond_V3	NA	NA

- NOTE:**
1. The calibration interval of the above test instruments is 12 months and the calibrations are traceable to NML/ROC and NIST/USA.
 2. The test was performed in HwaYa Shielded Room 3.
 3. The VCCI Site Registration No. is C-2047.



4.1.3 TEST PROCEDURES

- a. The EUT was placed 0.4 meters from the conducting wall of the shielded room with EUT being connected to the power mains through a line impedance stabilization network (LISN). Other support units were connected to the power mains through another LISN. The two LISNs provide 50 ohm/ 50uH of coupling impedance for the measuring instrument.
- b. Both lines of the power mains connected to the EUT were checked for maximum conducted interference.
- c. The frequency range from 150kHz to 30MHz was searched. Emission levels under (Limit - 20dB) was not recorded.

4.1.4 DEVIATION FROM TEST STANDARD

No deviation

4.1.5 TEST SETUP

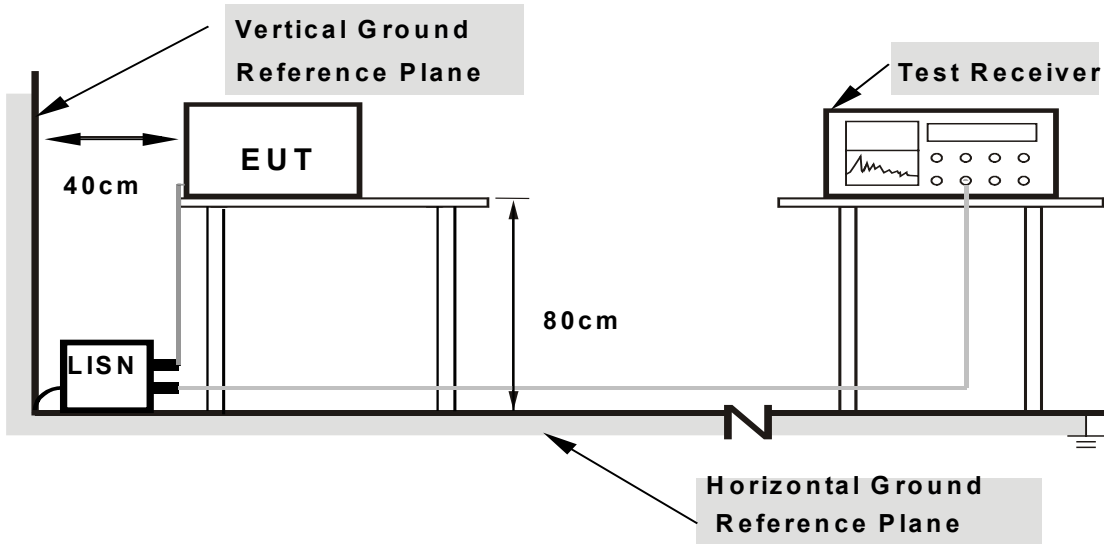

- Note:**
1. Support units were connected to second LISN.
 2. Both of LISNs (AMN) are 80 cm from EUT and at least 80 from other units and other metal planes

For the actual test configuration, please refer to the related item – Photographs of the Test Configuration.

4.1.6 EUT OPERATING CONDITIONS

- a. Connected the EUT to notebook system placed on a testing table.
- b. The EUT ran a test program (provided by manufacturer) to enable EUT under transmission/receiving condition continuously at specific channel frequency.
- c. The notebook system sent "H" messages to its screen.
- d. The notebook system sent "H" messages to modem.
- e. The notebook system sent "H" messages to printer, and the printer printed them on paper.
- f. Steps c ~ e were repeated.



4.1.7 TEST RESULTS

Conducted Worst-Case Data (with charging cable)

EUT	EDA (Enterprise Digital Assistant)	MEASUREMENT DETAIL	
MODEL	MC7090	PHASE	Line 1
CHANNEL	Channel 1	6dB BANDWIDTH	9 kHz
MODULATION TYPE	BPSK	ENVIRONMENTAL CONDITIONS	25deg. C, 65%RH, 991hPa
TRANSFER RATE	6Mbps	INPUT POWER (SYSTEM)	120Vac, 60 Hz
TEST MODE	A	TESTED BY	Jay Hsu

No	Freq. [MHz]	Corr. Factor (dB)	Reading Value		Emission Level		Limit		Margin	
			[dB (uV)]		[dB (uV)]		[dB (uV)]		(dB)	
			Q.P.	AV.	Q.P.	AV.	Q.P.	AV.	Q.P.	AV.
1	0.183	0.11	42.49	-	42.60	-	64.34	54.34	-21.74	-
2	0.196	0.11	41.07	-	41.18	-	63.79	53.79	-22.61	-
3	0.394	0.12	27.19	-	27.31	-	57.97	47.97	-30.66	-
4	0.676	0.17	21.72	-	21.89	-	56.00	46.00	-34.11	-
5	0.991	0.23	17.86	-	18.09	-	56.00	46.00	-37.91	-
6	2.863	0.27	33.45	-	33.72	-	56.00	46.00	-22.28	-

- REMARKS:**
1. Q.P. and AV. are abbreviations of quasi-peak and average individually.
 2. "-": The Quasi-peak reading value also meets average limit and measurement with the average detector is unnecessary.
 3. The emission levels of other frequencies were very low against the limit.
 4. Margin value = Emission level - Limit value
 5. Correction factor = Insertion loss + Cable loss
 6. Emission Level = Correction Factor + Reading Value.

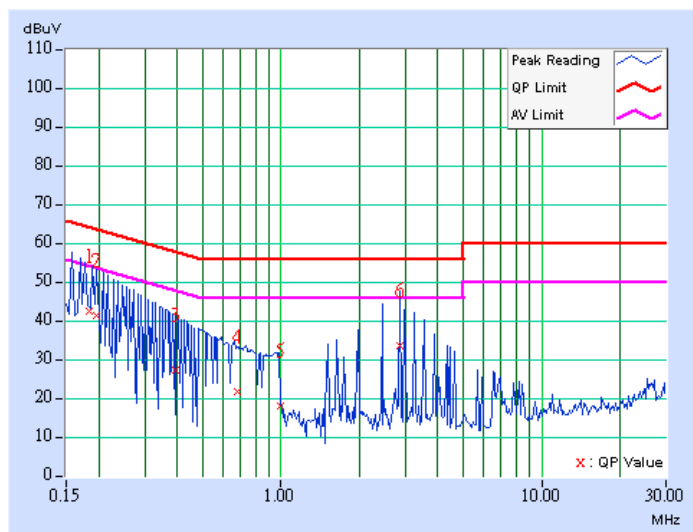



EUT	EDA (Enterprise Digital Assistant)	MEASUREMENT DETAIL	
MODEL	MC7090	PHASE	Line 2
CHANNEL	Channel 1	6dB BANDWIDTH	9 kHz
MODULATION TYPE	BPSK	ENVIRONMENTAL CONDITIONS	25deg. C, 65%RH, 991hPa
TRANSFER RATE	6Mbps	INPUT POWER (SYSTEM)	120Vac, 60 Hz
TEST MODE	A	TESTED BY	Jay Hsu

No	Freq. [MHz]	Corr. Factor (dB)	Reading Value		Emission Level		Limit		Margin	
			[dB (uV)]		[dB (uV)]		[dB (uV)]		(dB)	
			Q.P.	AV.	Q.P.	AV.	Q.P.	AV.	Q.P.	AV.
1	0.177	0.11	44.21	-	44.32	-	64.60	54.60	-20.28	-
2	0.238	0.11	40.36	-	40.47	-	62.15	52.15	-21.68	-
3	0.302	0.12	42.27	-	42.39	-	60.18	50.18	-17.79	-
4	0.359	0.12	42.67	-	42.79	-	58.74	48.74	-15.96	-
5	0.416	0.12	29.97	-	30.09	-	57.52	47.52	-27.43	-
6	1.883	0.25	29.11	-	29.36	-	56.00	46.00	-26.64	-

- REMARKS:**
1. Q.P. and AV. are abbreviations of quasi-peak and average individually.
 2. "-": The Quasi-peak reading value also meets average limit and measurement with the average detector is unnecessary.
 3. The emission levels of other frequencies were very low against the limit.
 4. Margin value = Emission level - Limit value
 5. Correction factor = Insertion loss + Cable loss
 6. Emission Level = Correction Factor + Reading Value.

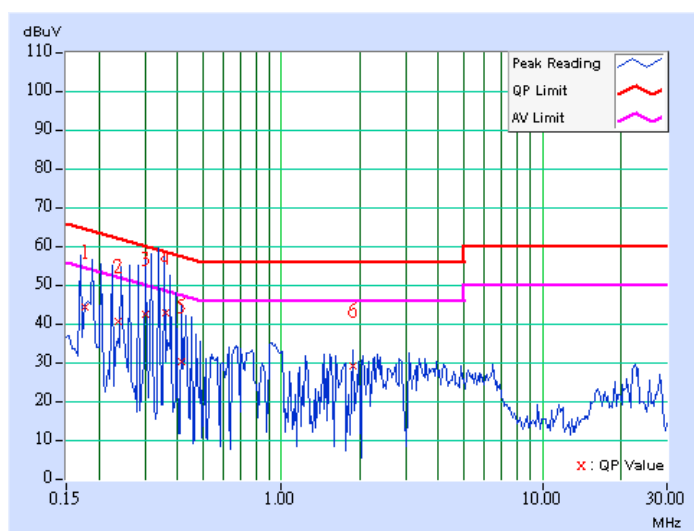



EUT	EDA (Enterprise Digital Assistant)	MEASUREMENT DETAIL	
MODEL	MC7090	PHASE	Line 1
CHANNEL	Channel 6	6dB BANDWIDTH	9 kHz
MODULATION TYPE	BPSK	ENVIRONMENTAL CONDITIONS	25deg. C, 65%RH, 991hPa
TRANSFER RATE	6Mbps	INPUT POWER (SYSTEM)	120Vac, 60 Hz
TEST MODE	A	TESTED BY	Jay Hsu

No	Freq. [MHz]	Corr. Factor (dB)	Reading Value		Emission Level		Limit		Margin	
			[dB (uV)]		[dB (uV)]		[dB (uV)]		(dB)	
			Q.P.	AV.	Q.P.	AV.	Q.P.	AV.	Q.P.	AV.
1	0.183	0.11	42.55	-	42.66	-	64.36	54.36	-21.70	-
2	0.242	0.11	36.13	-	36.24	-	62.02	52.02	-25.77	-
3	0.313	0.12	31.89	-	32.01	-	59.89	49.89	-27.88	-
4	0.487	0.14	23.58	-	23.72	-	56.22	46.22	-32.51	-
5	0.797	0.19	21.06	-	21.25	-	56.00	46.00	-34.75	-
6	2.908	0.27	33.13	-	33.40	-	56.00	46.00	-22.60	-

- REMARKS:**
1. Q.P. and AV. are abbreviations of quasi-peak and average individually.
 2. "-": The Quasi-peak reading value also meets average limit and measurement with the average detector is unnecessary.
 3. The emission levels of other frequencies were very low against the limit.
 4. Margin value = Emission level - Limit value
 5. Correction factor = Insertion loss + Cable loss
 6. Emission Level = Correction Factor + Reading Value.

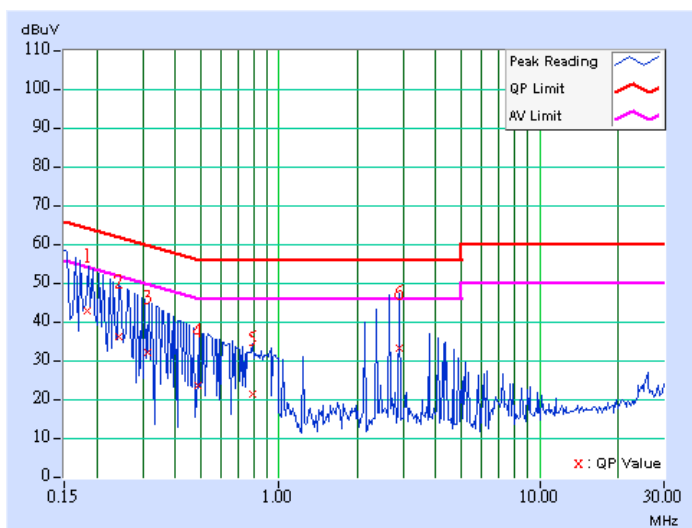



EUT	EDA (Enterprise Digital Assistant)	MEASUREMENT DETAIL	
MODEL	MC7090	PHASE	Line 2
CHANNEL	Channel 6	6dB BANDWIDTH	9 kHz
MODULATION TYPE	BPSK	ENVIRONMENTAL CONDITIONS	25deg. C, 65%RH, 991hPa
TRANSFER RATE	6Mbps	INPUT POWER (SYSTEM)	120Vac, 60 Hz
TEST MODE	A	TESTED BY	Jay Hsu

No	Freq. [MHz]	Corr. Factor (dB)	Reading Value		Emission Level		Limit		Margin	
			[dB (uV)]		[dB (uV)]		[dB (uV)]		(dB)	
			Q.P.	AV.	Q.P.	AV.	Q.P.	AV.	Q.P.	AV.
1	0.181	0.11	44.04	-	44.15	-	64.42	54.42	-20.27	-
2	0.245	0.11	37.00	-	37.11	-	61.93	51.93	-24.82	-
3	0.368	0.12	28.31	-	28.43	-	58.54	48.54	-30.11	-
4	0.597	0.16	22.89	-	23.05	-	56.00	46.00	-32.95	-
5	0.996	0.23	18.93	-	19.16	-	56.00	46.00	-36.84	-
6	3.227	0.27	29.52	-	29.79	-	56.00	46.00	-26.21	-

- REMARKS:**
1. Q.P. and AV. are abbreviations of quasi-peak and average individually.
 2. "-": The Quasi-peak reading value also meets average limit and measurement with the average detector is unnecessary.
 3. The emission levels of other frequencies were very low against the limit.
 4. Margin value = Emission level - Limit value
 5. Correction factor = Insertion loss + Cable loss
 6. Emission Level = Correction Factor + Reading Value.

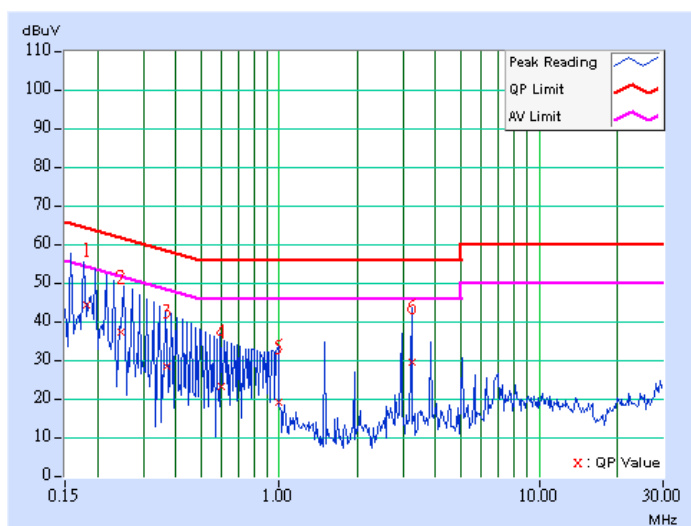



EUT	EDA (Enterprise Digital Assistant)	MEASUREMENT DETAIL	
MODEL	MC7090	PHASE	Line 1
CHANNEL	Channel 11	6dB BANDWIDTH	9 kHz
MODULATION TYPE	BPSK	ENVIRONMENTAL CONDITIONS	25deg. C, 65%RH, 991hPa
TRANSFER RATE	6Mbps	INPUT POWER (SYSTEM)	120Vac, 60 Hz
TEST MODE	A	TESTED BY	Jay Hsu

No	Freq. [MHz]	Corr. Factor (dB)	Reading Value		Emission Level		Limit		Margin	
			[dB (uV)]		[dB (uV)]		[dB (uV)]		(dB)	
			Q.P.	AV.	Q.P.	AV.	Q.P.	AV.	Q.P.	AV.
1	0.180	0.11	41.83	-	41.94	-	64.51	54.51	-22.57	-
2	0.244	0.11	36.61	-	36.72	-	61.96	51.96	-25.24	-
3	0.328	0.12	30.18	-	30.30	-	59.50	49.50	-29.21	-
4	0.549	0.15	22.77	-	22.92	-	56.00	46.00	-33.08	-
5	0.935	0.22	18.58	-	18.80	-	56.00	46.00	-37.20	-
6	2.195	0.25	26.28	-	26.53	-	56.00	46.00	-29.47	-

- REMARKS:**
1. Q.P. and AV. are abbreviations of quasi-peak and average individually.
 2. "-": The Quasi-peak reading value also meets average limit and measurement with the average detector is unnecessary.
 3. The emission levels of other frequencies were very low against the limit.
 4. Margin value = Emission level - Limit value
 5. Correction factor = Insertion loss + Cable loss
 6. Emission Level = Correction Factor + Reading Value.

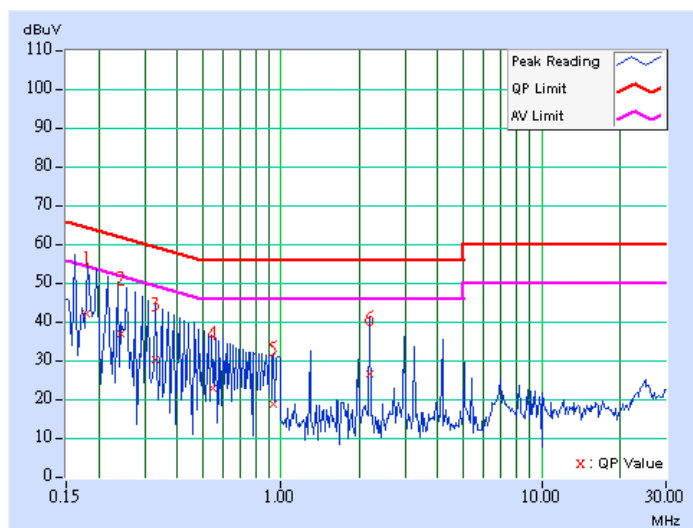



EUT	EDA (Enterprise Digital Assistant)	MEASUREMENT DETAIL	
MODEL	MC7090	PHASE	Line 2
CHANNEL	Channel 11	6dB BANDWIDTH	9 kHz
MODULATION TYPE	BPSK	ENVIRONMENTAL CONDITIONS	25deg. C, 65%RH, 991hPa
TRANSFER RATE	6Mbps	INPUT POWER (SYSTEM)	120Vac, 60 Hz
TEST MODE	A	TESTED BY	Jay Hsu

No	Freq. [MHz]	Corr. Factor (dB)	Reading Value		Emission Level		Limit		Margin	
			[dB (uV)]		[dB (uV)]		[dB (uV)]		(dB)	
			Q.P.	AV.	Q.P.	AV.	Q.P.	AV.	Q.P.	AV.
1	0.185	0.11	43.39	-	43.50	-	64.28	54.28	-20.78	-
2	0.244	0.11	37.12	-	37.23	-	61.95	51.95	-24.72	-
3	0.322	0.12	30.40	-	30.52	-	59.66	49.66	-29.15	-
4	0.609	0.16	21.48	-	21.64	-	56.00	46.00	-34.36	-
5	0.857	0.20	20.72	-	20.92	-	56.00	46.00	-35.08	-
6	3.180	0.27	30.30	-	30.57	-	56.00	46.00	-25.43	-

- REMARKS:**
1. Q.P. and AV. are abbreviations of quasi-peak and average individually.
 2. "-": The Quasi-peak reading value also meets average limit and measurement with the average detector is unnecessary.
 3. The emission levels of other frequencies were very low against the limit.
 4. Margin value = Emission level - Limit value
 5. Correction factor = Insertion loss + Cable loss
 6. Emission Level = Correction Factor + Reading Value.

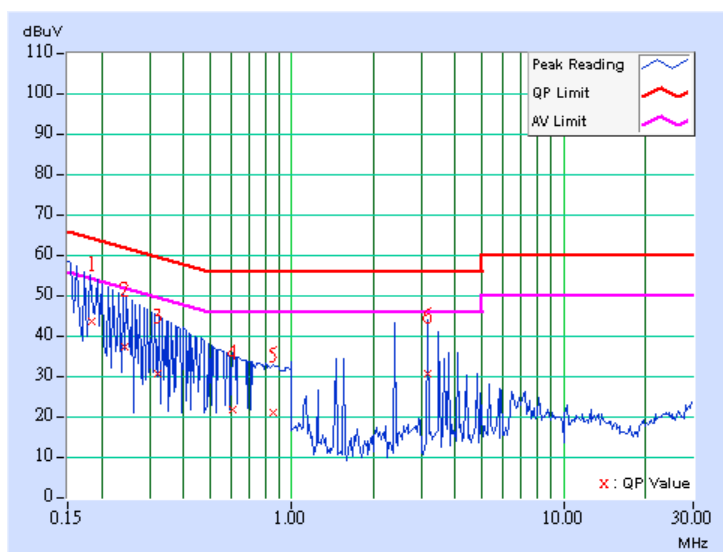



Conducted Worst-Case Data (with cradle)

EUT	EDA (Enterprise Digital Assistant)	MEASUREMENT DETAIL	
MODEL	MC7090	PHASE	Line 1
CHANNEL	Channel 1	6dB BANDWIDTH	9 kHz
MODULATION TYPE	BPSK	ENVIRONMENTAL CONDITIONS	25deg. C, 65%RH, 991hPa
TRANSFER RATE	6Mbps	INPUT POWER (SYSTEM)	120Vac, 60 Hz
TEST MODE	B	TESTED BY	Jay Hsu

No	Freq. [MHz]	Corr. Factor (dB)	Reading Value		Emission Level		Limit		Margin	
			[dB (uV)]		[dB (uV)]		[dB (uV)]		(dB)	
			Q.P.	AV.	Q.P.	AV.	Q.P.	AV.	Q.P.	AV.
1	0.197	0.11	46.82	-	46.93	-	63.74	53.74	-16.81	-
2	0.599	0.15	37.07	-	37.22	-	56.00	46.00	-18.78	-
3	1.398	0.25	32.29	-	32.54	-	56.00	46.00	-23.46	-
4	3.094	0.33	30.74	-	31.07	-	56.00	46.00	-24.93	-
5	4.391	0.40	37.06	-	37.46	-	56.00	46.00	-18.54	-
6	26.047	1.48	27.46	-	28.94	-	60.00	50.00	-31.06	-

- REMARKS:**
1. Q.P. and AV. are abbreviations of quasi-peak and average individually.
 2. "-": The Quasi-peak reading value also meets average limit and measurement with the average detector is unnecessary.
 3. The emission levels of other frequencies were very low against the limit.
 4. Margin value = Emission level - Limit value
 5. Correction factor = Insertion loss + Cable loss
 6. Emission Level = Correction Factor + Reading Value.

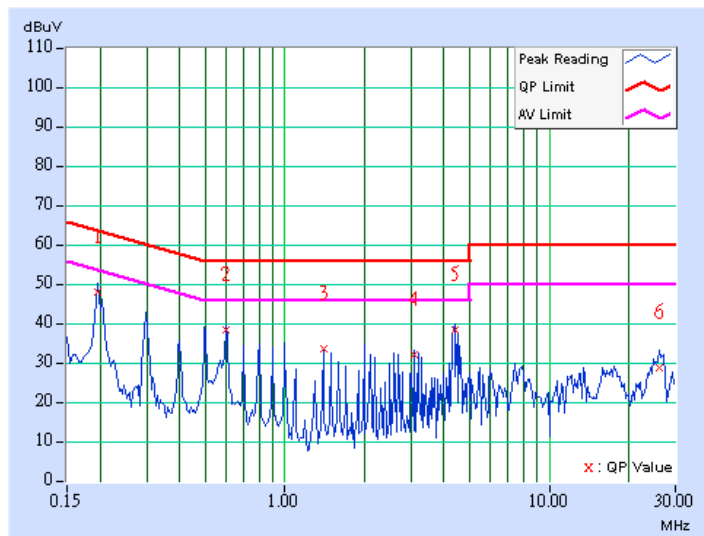



EUT	EDA (Enterprise Digital Assistant)	MEASUREMENT DETAIL	
MODEL	MC7090	PHASE	Line 2
CHANNEL	Channel 1	6dB BANDWIDTH	9 kHz
MODULATION TYPE	BPSK	ENVIRONMENTAL CONDITIONS	25deg. C, 65%RH, 991hPa
TRANSFER RATE	6Mbps	INPUT POWER (SYSTEM)	120Vac, 60 Hz
TEST MODE	B	TESTED BY	Jay Hsu

No	Freq. [MHz]	Corr. Factor (dB)	Reading Value		Emission Level		Limit		Margin	
			[dB (uV)]		[dB (uV)]		[dB (uV)]		(dB)	
			Q.P.	AV.	Q.P.	AV.	Q.P.	AV.	Q.P.	AV.
1	0.201	0.11	46.92	-	47.03	-	63.58	53.58	-16.55	-
2	0.298	0.11	39.12	-	39.23	-	60.29	50.29	-21.06	-
3	0.498	0.13	37.40	-	37.53	-	56.04	46.04	-18.51	-
4	1.496	0.25	34.27	-	34.52	-	56.00	46.00	-21.48	-
5	4.188	0.39	36.25	-	36.64	-	56.00	46.00	-19.36	-
6	26.047	0.94	25.90	-	26.84	-	60.00	50.00	-33.16	-

- REMARKS:**
1. Q.P. and AV. are abbreviations of quasi-peak and average individually.
 2. "-": The Quasi-peak reading value also meets average limit and measurement with the average detector is unnecessary.
 3. The emission levels of other frequencies were very low against the limit.
 4. Margin value = Emission level - Limit value
 5. Correction factor = Insertion loss + Cable loss
 6. Emission Level = Correction Factor + Reading Value.

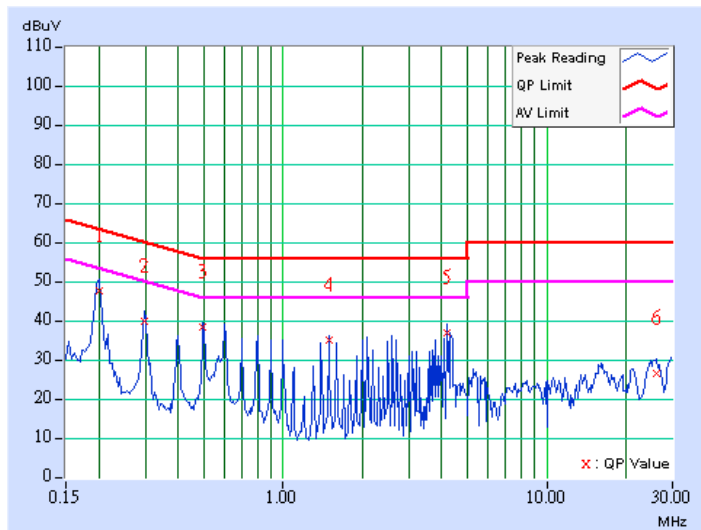



EUT	EDA (Enterprise Digital Assistant)	MEASUREMENT DETAIL	
MODEL	MC7090	PHASE	Line 1
CHANNEL	Channel 6	6dB BANDWIDTH	9 kHz
MODULATION TYPE	BPSK	ENVIRONMENTAL CONDITIONS	25deg. C, 65%RH, 991hPa
TRANSFER RATE	6Mbps	INPUT POWER (SYSTEM)	120Vac, 60 Hz
TEST MODE	B	TESTED BY	Jay Hsu

No	Freq. [MHz]	Corr. Factor (dB)	Reading Value		Emission Level		Limit		Margin	
			[dB (uV)]		[dB (uV)]		[dB (uV)]		(dB)	
			Q.P.	AV.	Q.P.	AV.	Q.P.	AV.	Q.P.	AV.
1	0.201	0.11	47.74	-	47.85	-	63.58	53.58	-15.73	-
2	0.298	0.11	39.36	-	39.47	-	60.29	50.29	-20.82	-
3	0.498	0.13	36.45	-	36.58	-	56.04	46.04	-19.46	-
4	1.398	0.25	32.17	-	32.42	-	56.00	46.00	-23.58	-
5	4.293	0.40	37.98	-	38.38	-	56.00	46.00	-17.62	-
6	25.957	1.47	26.47	-	27.94	-	60.00	50.00	-32.06	-

- REMARKS:**
1. Q.P. and AV. are abbreviations of quasi-peak and average individually.
 2. "-": The Quasi-peak reading value also meets average limit and measurement with the average detector is unnecessary.
 3. The emission levels of other frequencies were very low against the limit.
 4. Margin value = Emission level - Limit value
 5. Correction factor = Insertion loss + Cable loss
 6. Emission Level = Correction Factor + Reading Value.

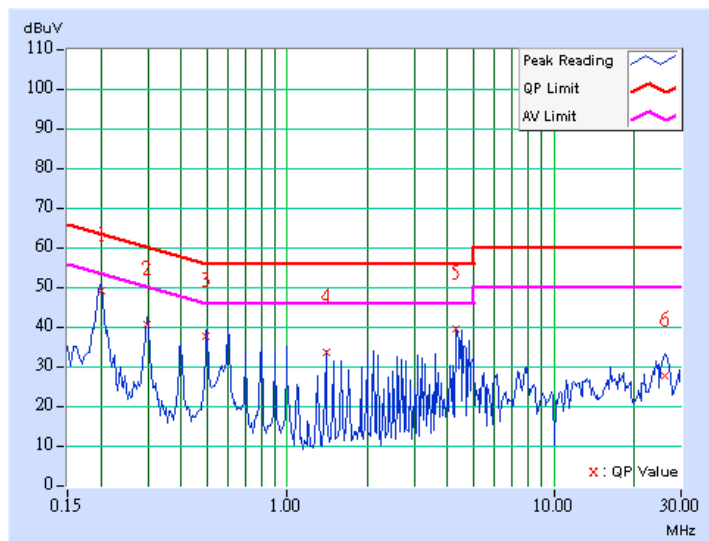



EUT	EDA (Enterprise Digital Assistant)	MEASUREMENT DETAIL	
MODEL	MC7090	PHASE	Line 2
CHANNEL	Channel 6	6dB BANDWIDTH	9 kHz
MODULATION TYPE	BPSK	ENVIRONMENTAL CONDITIONS	25deg. C, 65%RH, 991hPa
TRANSFER RATE	6Mbps	INPUT POWER (SYSTEM)	120Vac, 60 Hz
TEST MODE	B	TESTED BY	Jay Hsu

No	Freq. [MHz]	Corr. Factor (dB)	Reading Value		Emission Level		Limit		Margin	
			[dB (uV)]		[dB (uV)]		[dB (uV)]		(dB)	
			Q.P.	AV.	Q.P.	AV.	Q.P.	AV.	Q.P.	AV.
1	0.201	0.11	46.88	-	46.99	-	63.58	53.58	-16.59	-
2	0.298	0.11	39.06	-	39.17	-	60.29	50.29	-21.12	-
3	0.498	0.13	37.40	-	37.53	-	56.04	46.04	-18.51	-
4	1.496	0.25	34.27	-	34.52	-	56.00	46.00	-21.48	-
5	4.391	0.39	35.97	-	36.36	-	56.00	46.00	-19.64	-
6	16.473	0.53	24.18	-	24.71	-	60.00	50.00	-35.29	-

- REMARKS:**
1. Q.P. and AV. are abbreviations of quasi-peak and average individually.
 2. "-": The Quasi-peak reading value also meets average limit and measurement with the average detector is unnecessary.
 3. The emission levels of other frequencies were very low against the limit.
 4. Margin value = Emission level - Limit value
 5. Correction factor = Insertion loss + Cable loss
 6. Emission Level = Correction Factor + Reading Value.

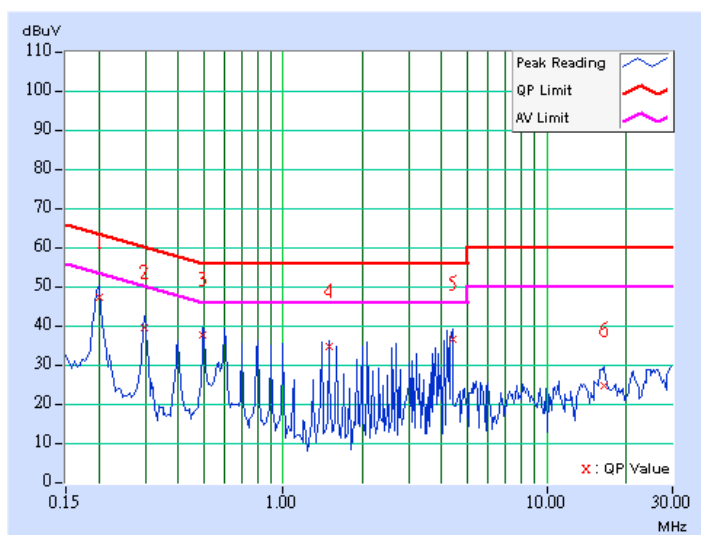



EUT	EDA (Enterprise Digital Assistant)	MEASUREMENT DETAIL	
MODEL	MC7090	PHASE	Line 1
CHANNEL	Channel 11	6dB BANDWIDTH	9 kHz
MODULATION TYPE	BPSK	ENVIRONMENTAL CONDITIONS	25deg. C, 65%RH, 991hPa
TRANSFER RATE	6Mbps	INPUT POWER (SYSTEM)	120Vac, 60 Hz
TEST MODE	B	TESTED BY	Jay Hsu

No	Freq. [MHz]	Corr. Factor (dB)	Reading Value		Emission Level		Limit		Margin	
			[dB (uV)]		[dB (uV)]		[dB (uV)]		(dB)	
			Q.P.	AV.	Q.P.	AV.	Q.P.	AV.	Q.P.	AV.
1	0.201	0.11	47.66	-	47.77	-	63.58	53.58	-15.81	-
2	0.298	0.11	39.28	-	39.39	-	60.29	50.29	-20.90	-
3	0.998	0.24	32.43	-	32.67	-	56.00	46.00	-23.33	-
4	4.289	0.40	38.64	-	39.04	-	56.00	46.00	-16.96	-
5	7.883	0.49	27.33	-	27.82	-	60.00	50.00	-32.18	-
6	26.457	1.53	26.75	-	28.28	-	60.00	50.00	-31.72	-

- REMARKS:**
1. Q.P. and AV. are abbreviations of quasi-peak and average individually.
 2. "-": The Quasi-peak reading value also meets average limit and measurement with the average detector is unnecessary.
 3. The emission levels of other frequencies were very low against the limit.
 4. Margin value = Emission level - Limit value
 5. Correction factor = Insertion loss + Cable loss
 6. Emission Level = Correction Factor + Reading Value.

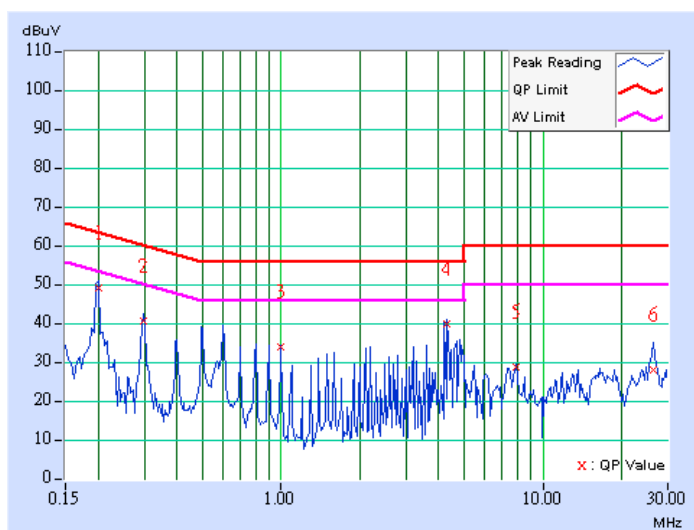



EUT	EDA (Enterprise Digital Assistant)	MEASUREMENT DETAIL	
MODEL	MC7090	PHASE	Line 2
CHANNEL	Channel 11	6dB BANDWIDTH	9 kHz
MODULATION TYPE	BPSK	ENVIRONMENTAL CONDITIONS	25deg. C, 65%RH, 991hPa
TRANSFER RATE	6Mbps	INPUT POWER (SYSTEM)	120Vac, 60 Hz
TEST MODE	B	TESTED BY	Jay Hsu

No	Freq. [MHz]	Corr. Factor (dB)	Reading Value [dB (uV)]		Emission Level [dB (uV)]		Limit [dB (uV)]		Margin (dB)	
			Q.P.	AV.	Q.P.	AV.	Q.P.	AV.	Q.P.	AV.
			1	0.197	0.11	45.75	-	45.86	-	63.74
2	0.298	0.11	38.31	-	38.42	-	60.29	50.29	-21.87	-
3	0.498	0.13	36.08	-	36.21	-	56.04	46.04	-19.83	-
4	1.496	0.25	31.54	-	31.79	-	56.00	46.00	-24.21	-
5	2.098	0.27	29.63	-	29.90	-	56.00	46.00	-26.10	-
6	4.195	0.39	34.20	-	34.59	-	56.00	46.00	-21.41	-

- REMARKS:**
1. Q.P. and AV. are abbreviations of quasi-peak and average individually.
 2. "-": The Quasi-peak reading value also meets average limit and measurement with the average detector is unnecessary.
 3. The emission levels of other frequencies were very low against the limit.
 4. Margin value = Emission level - Limit value
 5. Correction factor = Insertion loss + Cable loss
 6. Emission Level = Correction Factor + Reading Value.

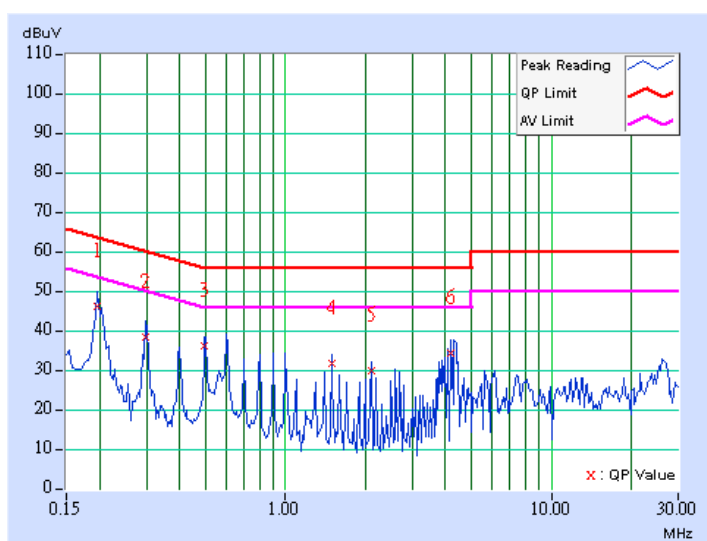



4.2 RADIATED EMISSION MEASUREMENT

4.2.1 LIMITS OF RADIATED EMISSION MEASUREMENT

Emissions radiated outside of the specified bands, shall be according to the general radiated limits in 15.209 as following:

Frequencies (MHz)	Field strength (microvolts/meter)	Measurement distance (meters)
0.009-0.490	2400/F(kHz)	300
0.490-1.705	24000/F(kHz)	30
1.705-30.0	30	30
30-88	100	3
88-216	150	3
216-960	200	3
Above 960	500	3

NOTE:

1. The lower limit shall apply at the transition frequencies.
2. Emission level (dBuV/m) = 20 log Emission level (uV/m).
3. As shown in 15.35(b), for frequencies above 1000MHz, the field strength limits are based on average detector, however, the peak field strength of any emission shall not exceed the maximum permitted average limits, specified above by more than 20dB under any condition of modulation.



4.2.2 TEST INSTRUMENTS

DESCRIPTION & MANUFACTURER	MODEL NO.	SERIAL NO.	CALIBRATED UNTIL
Test Receiver ROHDE & SCHWARZ	ESIB7	100188	Dec. 19, 2005
Spectrum Analyzer ROHDE & SCHWARZ	FSP40	100039	Nov. 21, 2005
BILOG Antenna SCHWARZBECK	VULB9168	9168-157	Jan. 22, 2006
HORN Antenna SCHWARZBECK	BBHA 9120 D	9120D-407	Jan. 16, 2006
HORN Antenna SCHWARZBECK	BBHA 9170	BBHA 9170241	Feb. 23, 2006
Preamplifier Agilent	8449B	3008A01961	Nov. 09, 2005
Preamplifier Agilent	8447D	2944A10629	Nov. 09, 2005
RF signal cable HUBER+SUHNER	SUCOFLEX 104	218182/4	Feb. 17, 2006
RF signal cable HUBER+SUHNER	SUCOFLEX 104	218194/4	Feb. 17, 2006
Software ADT.	ADT_Radiated_V5.14	NA	NA
Antenna Tower ADT.	AT100	AT93021702	NA
Turn Table ADT.	TT100.	TT93021702	NA
Controller ADT.	SC100.	SC93021702	NA
26GHz ~ 40GHz Amplifier	AMF-6F-2600400	923362	Mar. 13, 2006

- NOTE:**
1. The calibration interval of the above test instruments is 12 months and the calibrations are traceable to NML/ROC and NIST/USA.
 2. The test was performed in HwaYa Chamber 1.
 3. The horn antenna and HP preamplifier (model: 8449B) are used only for the measurement of emission frequency above 1GHz if tested.
 4. The IC Site Registration No. is IC4924-2.



4.2.3 TEST PROCEDURES

- a. The EUT was placed on the top of a rotating table 0.8 meters above the ground at a 3 meter semi-anechoic chamber. The table was rotated 360 degrees to determine the position of the highest radiation.
- b. The EUT was set 3 meters away from the interference-receiving antenna, which was mounted on the top of a variable-height antenna tower.
- c. The antenna is a broadband antenna, and its height is varied from one meter to four meters above the ground to determine the maximum value of the field strength. Both horizontal and vertical polarizations of the antenna are set to make the measurement.
- d. For each suspected emission, the EUT was arranged to its worst case and then the antenna was tuned to heights from 1 meter to 4 meters and the rotatable table was turned from 0 degrees to 360 degrees to find the maximum reading.
- e. The test-receiver system was set to Peak Detect Function and Specified Bandwidth with Maximum Hold Mode.
- f. If the emission level of the EUT in peak mode was lower than the limit specified, then testing could be stopped and the peak values of the EUT would be reported. Otherwise the emissions would be re-tested one by one using peak, quasi-peak or average method as specified and then reported in a data sheet.

NOTE:

1. The resolution bandwidth and video bandwidth of test receiver/spectrum analyzer is 120kHz for Quasi-peak detection at frequency below 1GHz.
2. The resolution bandwidth and video bandwidth of test receiver/spectrum analyzer is 1 MHz for Peak detection (PK) at frequency above 1GHz.
3. The resolution bandwidth of test receiver/spectrum analyzer is 1 MHz and the video bandwidth is 10 Hz for Average detection (AV) at frequency above 1GHz.

4.2.4 DEVIATION FROM TEST STANDARD

No deviation

4.2.5 TEST SETUP

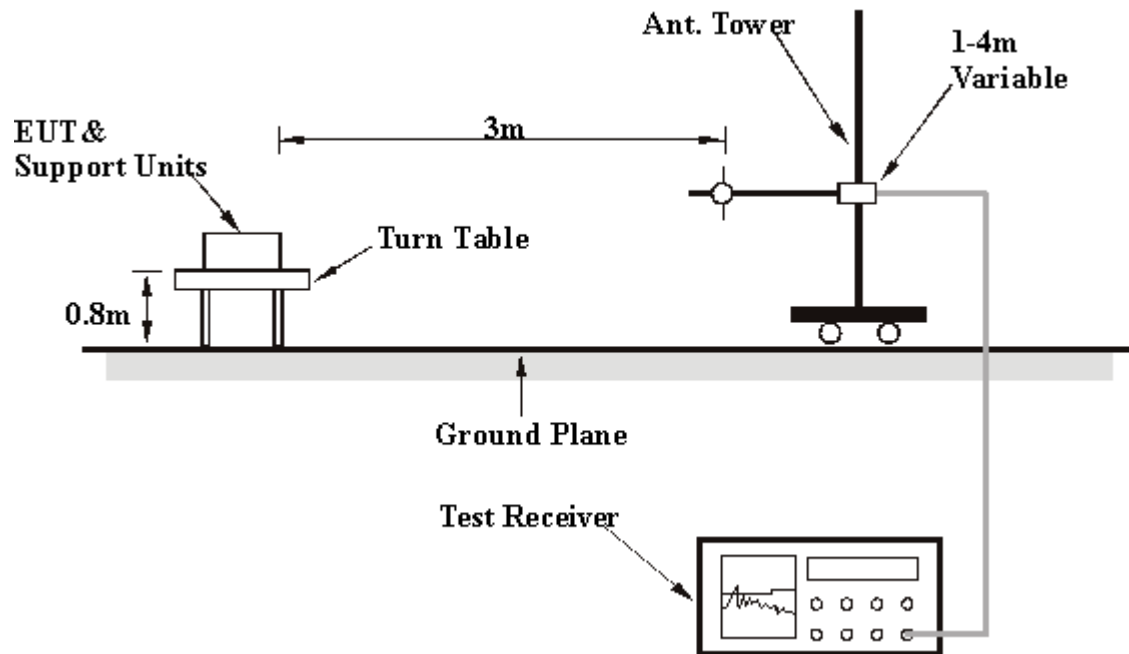

For the actual test configuration, please refer to the related item – Photographs of the Test Configuration.

4.2.6 EUT OPERATING CONDITIONS

Same as 4.1.6



4.2.7 TEST RESULTS

Below 1GHz Worst-Case Data (with charging cable)

EUT	EDA (Enterprise Digital Assistant)	MEASUREMENT DETAIL	
MODEL	MC7090	FREQUENCY RANGE	Below 1000MHz
CHANNEL	Channel 11	DETECTOR FUNCTION	Quasi-Peak
MODULATION TYPE	BPSK	ENVIRONMENTAL CONDITIONS	25deg. C, 65%RH, 991hPa
TRANSFER RATE	6Mbps	INPUT POWER (SYSTEM)	120Vac, 60 Hz
TEST MODE	A	TESTED BY	Match Tsui

ANTENNA POLARITY & TEST DISTANCE: HORIZONTAL AT 3 M

No.	Freq. (MHz)	Emission Level (dBuV/m)	Limit (dBuV/m)	Margin (dB)	Antenna Height (m)	Table Angle (Degree)	Raw Value (dBuV)	Correction Factor (dB/m)
1	101.92	27.92 QP	43.50	-15.58	2.00 H	55	16.98	10.94
2	134.98	30.07 QP	43.50	-13.43	1.50 H	292	16.21	13.86
3	166.07	33.76 QP	43.50	-9.74	1.50 H	244	19.69	14.07
4	199.12	28.87 QP	43.50	-14.63	1.50 H	256	17.67	11.20
5	249.66	39.25 QP	46.00	-6.75	1.00 H	88	26.17	13.08
6	374.07	36.86 QP	46.00	-9.14	1.00 H	112	20.83	16.03
7	457.66	28.78 QP	46.00	-17.22	1.50 H	340	10.77	18.01
8	735.63	29.20 QP	46.00	-16.80	2.00 H	310	6.12	23.08

ANTENNA POLARITY & TEST DISTANCE: VERTICAL AT 3 M

No.	Freq. (MHz)	Emission Level (dBuV/m)	Limit (dBuV/m)	Margin (dB)	Antenna Height (m)	Table Angle (Degree)	Raw Value (dBuV)	Correction Factor (dB/m)
1	49.44	22.45 QP	40.00	-17.55	1.00 V	178	7.92	14.53
2	80.54	23.37 QP	40.00	-16.63	2.00 V	360	13.61	9.76
3	111.64	29.11 QP	43.50	-14.39	1.00 V	151	17.17	11.94
4	162.18	29.86 QP	43.50	-13.64	1.00 V	202	15.41	14.45
5	199.12	28.93 QP	43.50	-14.57	1.50 V	316	17.73	11.20
6	249.66	37.69 QP	46.00	-8.31	2.00 V	193	24.61	13.08
7	374.07	32.72 QP	46.00	-13.28	1.00 V	160	16.69	16.03
8	457.66	29.10 QP	46.00	-16.90	2.00 V	360	11.09	18.01
9	601.50	27.50 QP	46.00	-18.50	1.50 V	328	6.59	20.91
10	731.74	27.42 QP	46.00	-18.58	1.50 V	360	4.43	22.99
11	799.78	27.25 QP	46.00	-18.75	2.00 V	13	3.55	23.70

- REMARKS:**
1. Emission level(dBuV/m)=Raw Value(dBuV) + Correction Factor(dB/m)
 2. Correction Factor(dB/m) = Antenna Factor (dB/m) + Cable Factor (dB)
 3. The other emission levels were very low against the limit.
 4. Margin value = Emission level – Limit value



Below 1GHz Worst-Case Data (with cradle)

EUT	EDA (Enterprise Digital Assistant)	MEASUREMENT DETAIL	
MODEL	MC7090	FREQUENCY RANGE	Below 1000MHz
CHANNEL	Channel 11	DETECTOR FUNCTION	Quasi-Peak
MODULATION TYPE	BPSK	ENVIRONMENTAL CONDITIONS	25deg. C, 65%RH, 991hPa
TRANSFER RATE	6Mbps	INPUT POWER (SYSTEM)	120Vac, 60 Hz
TEST MODE	B	TESTED BY	Match Tsui

ANTENNA POLARITY & TEST DISTANCE: HORIZONTAL AT 3 M

No.	Freq. (MHz)	Emission Level (dBuV/m)	Limit (dBuV/m)	Margin (dB)	Antenna Height (m)	Table Angle (Degree)	Raw Value (dBuV)	Correction Factor (dB/m)
1	115.53	28.28 QP	43.50	-15.22	1.50 H	265	15.94	12.34
2	164.13	34.86 QP	43.50	-8.64	1.50 H	229	20.61	14.26
3	195.23	27.19 QP	43.50	-16.31	2.00 H	265	15.68	11.51
4	249.66	39.21 QP	46.00	-6.79	1.00 H	85	26.13	13.08
5	374.07	37.33 QP	46.00	-8.67	1.00 H	100	21.30	16.03
6	449.88	28.88 QP	46.00	-17.12	1.50 H	352	10.97	17.91
7	733.69	29.97 QP	46.00	-16.03	1.00 H	277	6.94	23.03
8	801.72	29.26 QP	46.00	-16.74	1.00 H	307	5.55	23.72

ANTENNA POLARITY & TEST DISTANCE: VERTICAL AT 3 M

No.	Freq. (MHz)	Emission Level (dBuV/m)	Limit (dBuV/m)	Margin (dB)	Antenna Height (m)	Table Angle (Degree)	Raw Value (dBuV)	Correction Factor (dB/m)
1	78.60	23.32 QP	40.00	-16.68	1.00 V	82	13.21	10.11
2	111.64	29.82 QP	43.50	-13.68	1.00 V	166	17.88	11.94
3	162.18	30.49 QP	43.50	-13.01	1.00 V	190	16.04	14.45
4	249.66	38.27 QP	46.00	-7.73	2.00 V	16	25.19	13.08
5	374.07	32.77 QP	46.00	-13.23	1.00 V	157	16.75	16.03
6	457.66	29.19 QP	46.00	-16.81	1.50 V	154	11.17	18.01
7	519.86	28.24 QP	46.00	-17.76	1.00 V	91	9.25	18.99

- REMARKS:**
1. Emission level(dBuV/m)=Raw Value(dBuV) + Correction Factor(dB/m)
 2. Correction Factor(dB/m) = Antenna Factor (dB/m) + Cable Factor (dB)
 3. The other emission levels were very low against the limit.
 4. Margin value = Emission level – Limit value



Below 1GHz Worst-Case Data (battery mode)

EUT	EDA (Enterprise Digital Assistant)	MEASUREMENT DETAIL	
MODEL	MC7090	FREQUENCY RANGE	Below 1000MHz
CHANNEL	Channel 11	DETECTOR FUNCTION	Quasi-Peak
MODULATION TYPE	BPSK	ENVIRONMENTAL CONDITIONS	25deg. C, 65%RH, 991hPa
TRANSFER RATE	6Mbps	INPUT POWER (SYSTEM)	120Vac, 60 Hz
TEST MODE	C	TESTED BY	Match Tsui

ANTENNA POLARITY & TEST DISTANCE: HORIZONTAL AT 3 M

No.	Freq. (MHz)	Emission Level (dBuV/m)	Limit (dBuV/m)	Margin (dB)	Antenna Height (m)	Table Angle (Degree)	Raw Value (dBuV)	Correction Factor (dB/m)
1	92.20	28.19 QP	43.50	-15.31	2.00 H	259	18.07	10.12
2	136.91	34.75 QP	43.50	-8.75	2.00 H	289	20.76	13.99
3	175.79	28.44 QP	43.50	-15.06	1.50 H	250	15.32	13.12
4	206.89	25.93 QP	43.50	-17.57	1.50 H	343	14.63	11.30
5	519.86	29.34 QP	46.00	-16.66	1.50 H	64	10.35	18.99
6	731.74	29.65 QP	46.00	-16.35	1.00 H	280	6.66	22.99

ANTENNA POLARITY & TEST DISTANCE: VERTICAL AT 3 M

No.	Freq. (MHz)	Emission Level (dBuV/m)	Limit (dBuV/m)	Margin (dB)	Antenna Height (m)	Table Angle (Degree)	Raw Value (dBuV)	Correction Factor (dB/m)
1	47.49	23.69 QP	40.00	-16.31	1.00 V	115	8.93	14.76
2	134.97	28.13 QP	43.50	-15.37	2.50 V	226	14.27	13.86
3	166.07	28.06 QP	43.50	-15.44	1.00 V	214	13.99	14.07
4	619.00	27.56 QP	46.00	-18.44	1.00 V	130	6.40	21.16
5	825.05	26.37 QP	46.00	-19.63	1.00 V	181	2.46	23.91
6	867.82	26.91 QP	46.00	-19.09	1.00 V	262	2.44	24.47

- REMARKS:**
1. Emission level(dBuV/m)=Raw Value(dBuV) + Correction Factor(dB/m)
 2. Correction Factor(dB/m) = Antenna Factor (dB/m) + Cable Factor (dB)
 3. The other emission levels were very low against the limit.
 4. Margin value = Emission level – Limit value



802.11b DSSS modulation

EUT	EDA (Enterprise Digital Assistant)	MEASUREMENT DETAIL	
MODEL	MC7090	FREQUENCY RANGE	1 ~ 25GHz
CHANNEL	Channel 1	DETECTOR FUNCTION	Peak(PK) Average (AV)
MODULATION TYPE	CCK	ENVIRONMENTAL CONDITIONS	25deg. C, 68%RH, 991hPa
TRANSFER RATE	11Mbps	INPUT POWER (SYSTEM)	120Vac, 60 Hz
TESTED BY	Match Tsui		

ANTENNA POLARITY & TEST DISTANCE: HORIZONTAL AT 3 M

No.	Freq. (MHz)	Emission Level (dBuV/m)	Limit (dBuV/m)	Margin (dB)	Antenna Height (m)	Table Angle (Degree)	Raw Value (dBuV)	Correction Factor (dB/m)
1	2390.00	59.85 PK	74.00	-14.15	1.05 H	325	27.81	32.04
1	2390.00	46.93 AV	54.00	-7.07	1.05 H	325	14.89	32.04
2	*2412.00	108.09 PK			1.05 H	325	75.96	32.13
2	*2412.00	100.63 AV			1.05 H	325	68.50	32.13
3	4824.00	47.07 PK	74.00	-26.93	1.10 H	300	8.87	38.20
3	4824.00	34.49 AV	54.00	-19.51	1.10 H	300	-3.71	38.20

ANTENNA POLARITY & TEST DISTANCE: VERTICAL AT 3 M

No.	Freq. (MHz)	Emission Level (dBuV/m)	Limit (dBuV/m)	Margin (dB)	Antenna Height (m)	Table Angle (Degree)	Raw Value (dBuV)	Correction Factor (dB/m)
1	2390.00	54.21 PK	74.00	-19.79	1.07 V	360	22.17	32.04
1	2390.00	45.64 AV	54.00	-8.36	1.07 V	360	13.60	32.04
2	*2412.00	104.21 PK			1.07 V	360	72.08	32.13
2	*2412.00	99.44 AV			1.07 V	360	67.31	32.13
3	4824.00	47.18 PK	74.00	-26.82	1.07 V	360	8.98	38.20
3	4824.00	34.45 AV	54.00	-19.55	1.07 V	360	-3.75	38.20

- REMARKS:**
1. Emission level(dBuV/m)=Raw Value(dBuV) + Correction Factor(dB/m)
 2. Correction Factor(dB/m) = Antenna Factor (dB/m) + Cable Factor (dB)
 3. The other emission levels were very low against the limit.
 4. Margin value = Emission level – Limit value.
 5. The limit value is defined as per 15.247
 6. " * " : Fundamental frequency



EUT	EDA (Enterprise Digital Assistant)	MEASUREMENT DETAIL	
MODEL	MC7090	FREQUENCY RANGE	1 ~ 25GHz
CHANNEL	Channel 6	DETECTOR FUNCTION	Peak(PK) Average (AV)
MODULATION TYPE	CCK	ENVIRONMENTAL CONDITIONS	25deg. C, 68%RH, 991hPa
TRANSFER RATE	11Mbps	INPUT POWER (SYSTEM)	120Vac, 60 Hz
TESTED BY	Match Tsui		

ANTENNA POLARITY & TEST DISTANCE: HORIZONTAL AT 3 M

No.	Freq. (MHz)	Emission Level (dBuV/m)	Limit (dBuV/m)	Margin (dB)	Antenna Height (m)	Table Angle (Degree)	Raw Value (dBuV)	Correction Factor (dB/m)
1	*2437.00	110.28 PK			1.03 H	333	78.03	32.25
1	*2437.00	102.75 AV			1.03 H	333	70.50	32.25
2	4874.00	47.67 PK	74.00	-26.33	1.01 H	123	9.35	38.32
2	4874.00	34.90 AV	54.00	-19.10	1.01 H	123	-3.42	38.32

ANTENNA POLARITY & TEST DISTANCE: VERTICAL AT 3 M

No.	Freq. (MHz)	Emission Level (dBuV/m)	Limit (dBuV/m)	Margin (dB)	Antenna Height (m)	Table Angle (Degree)	Raw Value (dBuV)	Correction Factor (dB/m)
1	*2437.00	106.47 PK			1.33 V	340	74.22	32.25
1	*2437.00	100.59 AV			1.33 V	340	68.34	32.25
2	4874.00	47.54 PK	74.00	-26.46	1.07 V	147	9.22	38.32
2	4874.00	34.59 AV	54.00	-19.41	1.07 V	147	-3.73	38.32

- REMARKS:**
1. Emission level(dBuV/m)=Raw Value(dBuV) + Correction Factor(dB/m)
 2. Correction Factor(dB/m) = Antenna Factor (dB/m) + Cable Factor (dB)
 3. The other emission levels were very low against the limit.
 4. Margin value = Emission level – Limit value.
 5. The limit value is defined as per 15.247
 6. “ * “ : Fundamental frequency



EUT	EDA (Enterprise Digital Assistant)	MEASUREMENT DETAIL	
MODEL	MC7090	FREQUENCY RANGE	1 ~ 25GHz
CHANNEL	Channel 11	DETECTOR FUNCTION	Peak(PK) Average (AV)
MODULATION TYPE	CCK	ENVIRONMENTAL CONDITIONS	25deg. C, 68%RH, 991hPa
TRANSFER RATE	11Mbps	INPUT POWER (SYSTEM)	120Vac, 60 Hz
TESTED BY	Match Tsui		

ANTENNA POLARITY & TEST DISTANCE: HORIZONTAL AT 3 M

No.	Freq. (MHz)	Emission Level (dBuV/m)	Limit (dBuV/m)	Margin (dB)	Antenna Height (m)	Table Angle (Degree)	Raw Value (dBuV)	Correction Factor (dB/m)
1	*2462.00	106.21 PK			1.28 H	325	73.85	32.36
1	*2462.00	98.58 AV			1.28 H	325	66.22	32.36
2	2483.50	54.88 PK	74.00	-19.12	1.28 H	325	22.42	32.46
2	2483.50	46.53 AV	54.00	-7.47	1.28 H	325	14.07	32.46
3	4924.00	47.83 PK	74.00	-26.17	1.11 H	143	9.37	38.46
3	4924.00	35.38 AV	54.00	-18.62	1.11 H	143	-3.08	38.46

ANTENNA POLARITY & TEST DISTANCE: VERTICAL AT 3 M

No.	Freq. (MHz)	Emission Level (dBuV/m)	Limit (dBuV/m)	Margin (dB)	Antenna Height (m)	Table Angle (Degree)	Raw Value (dBuV)	Correction Factor (dB/m)
1	*2462.00	104.23 PK	74.00	30.23	1.33 V	345	71.87	32.36
1	*2462.00	97.20 AV	54.00	43.20	1.33 V	345	64.84	32.36
2	2483.50	57.24 PK	74.00	-16.76	1.33 V	345	24.78	32.46
2	2483.50	46.74 AV	54.00	-7.26	1.33 V	345	14.28	32.46
3	4924.00	47.44 PK	74.00	-26.56	1.00 V	130	8.98	38.46
3	4924.00	35.30 AV	54.00	-18.70	1.00 V	130	-3.16	38.46

- REMARKS:**
1. Emission level(dBuV/m)=Raw Value(dBuV) + Correction Factor(dB/m)
 2. Correction Factor(dB/m) = Antenna Factor (dB/m) + Cable Factor (dB)
 3. The other emission levels were very low against the limit.
 4. Margin value = Emission level – Limit value.
 5. The limit value is defined as per 15.247
 6. “ * “ : Fundamental frequency



802.11g OFDM modulation

EUT	EDA (Enterprise Digital Assistant)	MEASUREMENT DETAIL	
MODEL	MC7090	FREQUENCY RANGE	1 ~ 25GHz
CHANNEL	Channel 1	DETECTOR FUNCTION	Peak(PK) Average (AV)
MODULATION TYPE	BPSK	ENVIRONMENTAL CONDITIONS	25deg. C, 68%RH, 991hPa
TRANSFER RATE	6Mbps	INPUT POWER (SYSTEM)	120Vac, 60 Hz
TESTED BY	Match Tsui		

ANTENNA POLARITY & TEST DISTANCE: HORIZONTAL AT 3 M

No.	Freq. (MHz)	Emission Level (dBuV/m)	Limit (dBuV/m)	Margin (dB)	Antenna Height (m)	Table Angle (Degree)	Raw Value (dBuV)	Correction Factor (dB/m)
1	2390.00	58.55 PK	74.00	-15.45	1.33 H	324	26.51	32.04
1	2390.00	48.08 AV	54.00	-5.92	1.33 H	324	16.04	32.04
2	*2412.00	107.44 PK			1.33 H	324	75.31	32.13
2	*2412.00	97.55 AV			1.33 H	324	65.42	32.13
3	4824.00	46.48 PK	74.00	-27.52	1.12 H	300	8.28	38.20
3	4824.00	34.13 AV	54.00	-19.87	1.12 H	300	-4.07	38.20

ANTENNA POLARITY & TEST DISTANCE: VERTICAL AT 3 M

No.	Freq. (MHz)	Emission Level (dBuV/m)	Limit (dBuV/m)	Margin (dB)	Antenna Height (m)	Table Angle (Degree)	Raw Value (dBuV)	Correction Factor (dB/m)
1	2390.00	57.32 PK	74.00	-16.68	1.31 V	6	25.28	32.04
1	2390.00	46.75 AV	54.00	-7.25	1.31 V	6	14.71	32.04
2	*2412.00	102.91 PK			1.31 V	6	70.78	32.13
2	*2412.00	93.98 AV			1.31 V	6	61.85	32.13
3	4824.00	47.48 PK	74.00	-26.52	1.00 V	347	9.28	38.20
3	4824.00	34.31 AV	54.00	-19.69	1.00 V	347	-3.89	38.20

- REMARKS:**
1. Emission level(dBuV/m)=Raw Value(dBuV) + Correction Factor(dB/m)
 2. Correction Factor(dB/m) = Antenna Factor (dB/m) + Cable Factor (dB)
 3. The other emission levels were very low against the limit.
 4. Margin value = Emission level – Limit value.
 5. The limit value is defined as per 15.247
 6. “ * “ : Fundamental frequency



EUT	EDA (Enterprise Digital Assistant)	MEASUREMENT DETAIL	
MODEL	MC7090	FREQUENCY RANGE	1 ~ 25GHz
CHANNEL	Channel 6	DETECTOR FUNCTION	Peak(PK) Average (AV)
MODULATION TYPE	BPSK	ENVIRONMENTAL CONDITIONS	25deg. C, 68%RH, 991hPa
TRANSFER RATE	6Mbps	INPUT POWER (SYSTEM)	120Vac, 60 Hz
TESTED BY	Match Tsui		

ANTENNA POLARITY & TEST DISTANCE: HORIZONTAL AT 3 M

No.	Freq. (MHz)	Emission Level (dBuV/m)	Limit (dBuV/m)	Margin (dB)	Antenna Height (m)	Table Angle (Degree)	Raw Value (dBuV)	Correction Factor (dB/m)
1	*2437.00	108.13 PK			1.30 H	309	75.88	32.25
1	*2437.00	98.82 AV			1.30 H	309	66.57	32.25
2	4824.00	46.57 PK	74.00	-27.43	1.17 H	122	8.37	38.20
2	4824.00	34.22 AV	54.00	-19.78	1.17 H	122	-3.98	38.20

ANTENNA POLARITY & TEST DISTANCE: VERTICAL AT 3 M

No.	Freq. (MHz)	Emission Level (dBuV/m)	Limit (dBuV/m)	Margin (dB)	Antenna Height (m)	Table Angle (Degree)	Raw Value (dBuV)	Correction Factor (dB/m)
1	*2437.00	104.53 PK			1.30 V	360	72.28	32.25
1	*2437.00	95.17 AV			1.30 V	360	62.92	32.25
2	4824.00	47.18 PK	74.00	-26.82	1.00 V	135	8.98	38.20
2	4824.00	34.25 AV	54.00	-19.75	1.00 V	135	-3.95	38.20

- REMARKS:**
1. Emission level(dBuV/m)=Raw Value(dBuV) + Correction Factor(dB/m)
 2. Correction Factor(dB/m) = Antenna Factor (dB/m) + Cable Factor (dB)
 3. The other emission levels were very low against the limit.
 4. Margin value = Emission level – Limit value.
 5. The limit value is defined as per 15.247
 6. “ * “ : Fundamental frequency



EUT	EDA (Enterprise Digital Assistant)	MEASUREMENT DETAIL	
MODEL	MC7090	FREQUENCY RANGE	1 ~ 25GHz
CHANNEL	Channel 11	DETECTOR FUNCTION	Peak(PK) Average (AV)
MODULATION TYPE	BPSK	ENVIRONMENTAL CONDITIONS	25deg. C, 68%RH, 991hPa
TRANSFER RATE	6Mbps	INPUT POWER (SYSTEM)	120Vac, 60 Hz
TESTED BY	Match Tsui		

ANTENNA POLARITY & TEST DISTANCE: HORIZONTAL AT 3 M

No.	Freq. (MHz)	Emission Level (dBuV/m)	Limit (dBuV/m)	Margin (dB)	Antenna Height (m)	Table Angle (Degree)	Raw Value (dBuV)	Correction Factor (dB/m)
1	*2462.00	105.65 PK			1.03 H	322	73.29	32.36
1	*2462.00	95.64 AV			1.03 H	322	63.28	32.36
2	2483.50	59.29 PK	74.00	-14.71	1.03 H	322	26.83	32.46
2	2483.50	47.79 AV	54.00	-6.21	1.03 H	322	15.33	32.46
3	4924.00	47.41 PK	74.00	-26.59	1.10 H	300	8.95	38.46
3	4924.00	34.47 AV	54.00	-19.53	1.10 H	300	-3.99	38.46

ANTENNA POLARITY & TEST DISTANCE: VERTICAL AT 3 M

No.	Freq. (MHz)	Emission Level (dBuV/m)	Limit (dBuV/m)	Margin (dB)	Antenna Height (m)	Table Angle (Degree)	Raw Value (dBuV)	Correction Factor (dB/m)
1	*2462.00	100.78 PK			1.29 V	14	68.42	32.36
1	*2462.00	91.48 AV			1.29 V	14	59.12	32.36
2	2483.50	54.09 PK	74.00	-19.91	1.29 V	14	21.63	32.46
2	2483.50	46.37 AV	54.00	-7.63	1.29 V	14	13.91	32.46
3	4924.00	47.81 PK	74.00	-26.19	1.10 V	300	9.35	38.46
3	4924.00	34.62 AV	54.00	-19.38	1.10 V	300	-3.84	38.46

- REMARKS:**
1. Emission level(dBuV/m)=Raw Value(dBuV) + Correction Factor(dB/m)
 2. Correction Factor(dB/m) = Antenna Factor (dB/m) + Cable Factor (dB)
 3. The other emission levels were very low against the limit.
 4. Margin value = Emission level – Limit value.
 5. The limit value is defined as per 15.247
 6. “ * “ : Fundamental frequency



4.3 6dB BANDWIDTH MEASUREMENT

4.3.1 LIMITS OF 6dB BANDWIDTH MEASUREMENT

The minimum of 6dB Bandwidth Measurement is 0.5 MHz.

4.3.2 TEST INSTRUMENTS

Description & Manufacturer	Model No.	Serial No.	Calibrated Until
SPECTRUM ANALYZER	FSEK 30	100049	Aug. 14, 2006

NOTE: The calibration interval of the above test instruments is 12 months and the calibrations are traceable to NML/ROC and NIST/USA.

4.3.3 TEST PROCEDURE

The transmitter output was connected to the spectrum analyzer through an attenuator. The bandwidth of the fundamental frequency was measured by spectrum analyzer with 100kHz RBW and 100kHz VBW. The 6dB bandwidth is defined as the total spectrum the power of which is higher than peak power minus 6dB.

4.3.4 DEVIATION FROM TEST STANDARD

No deviation

4.3.5 TEST SETUP

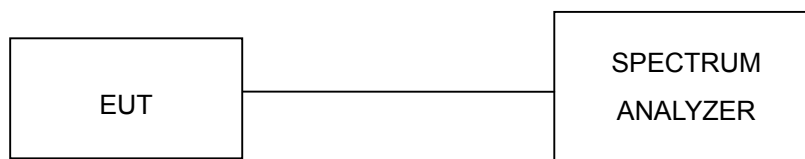

4.3.6 EUT OPERATING CONDITIONS

The software provided by client to enable the EUT under transmission condition continuously at lowest, middle and highest channel frequencies individually.



4.3.7 TEST RESULTS

802.11b DSSS modulation

EUT	EDA (Enterprise Digital Assistant)	MODEL	MC7090
MODULATION TYPE	CCK	TRANSFER RATE	11Mbps
INPUT POWER (SYSTEM)	120Vac, 60 Hz	ENVIRONMENTAL CONDITIONS	27deg.C, 63%RH, 991hPa
TESTED BY	Gary Chang		

CHANNEL	CHANNEL FREQUENCY (MHz)	6dB BANDWIDTH (MHz)	MINIMUM LIMIT (MHz)	PASS/FAIL
1	2412	12.20	0.5	PASS
6	2437	11.52	0.5	PASS
11	2462	11.52	0.5	PASS



CH 1

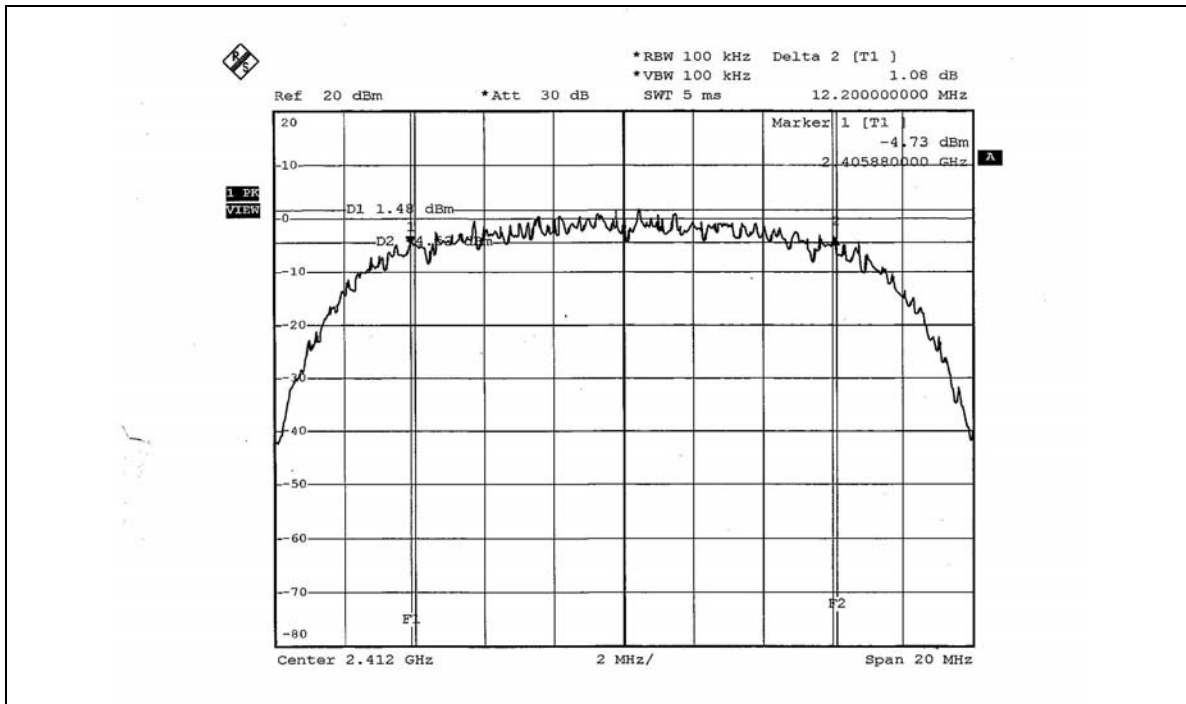

CH 6

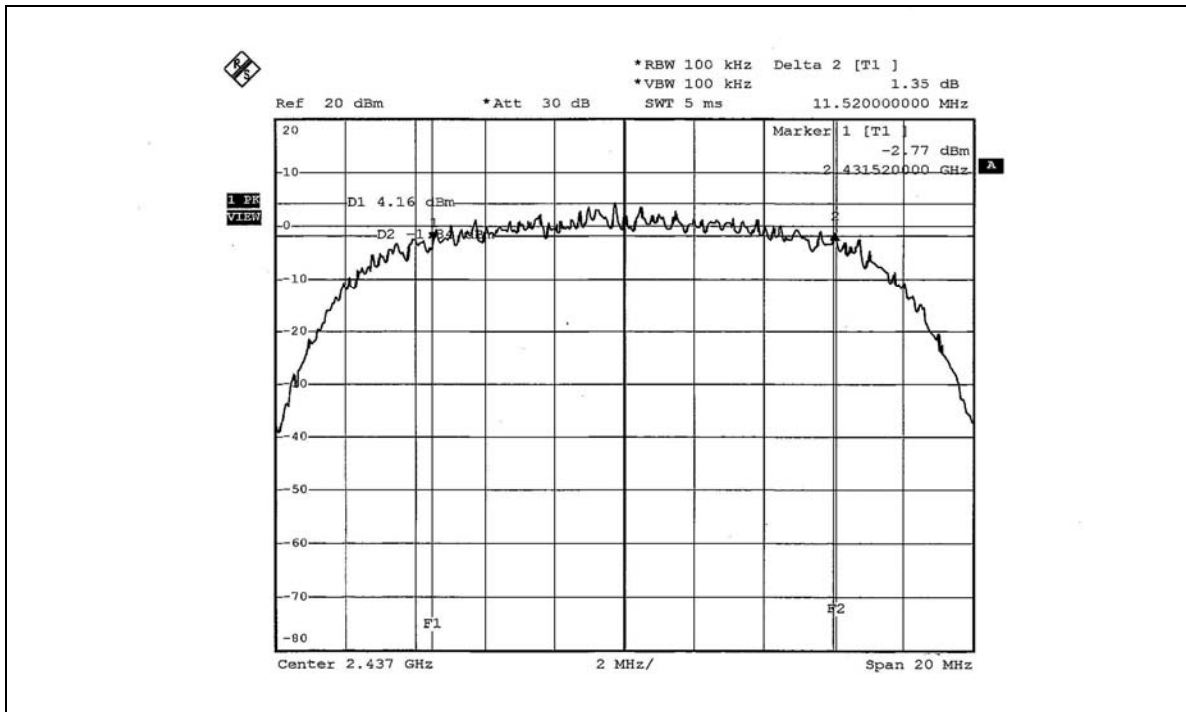



CH 11

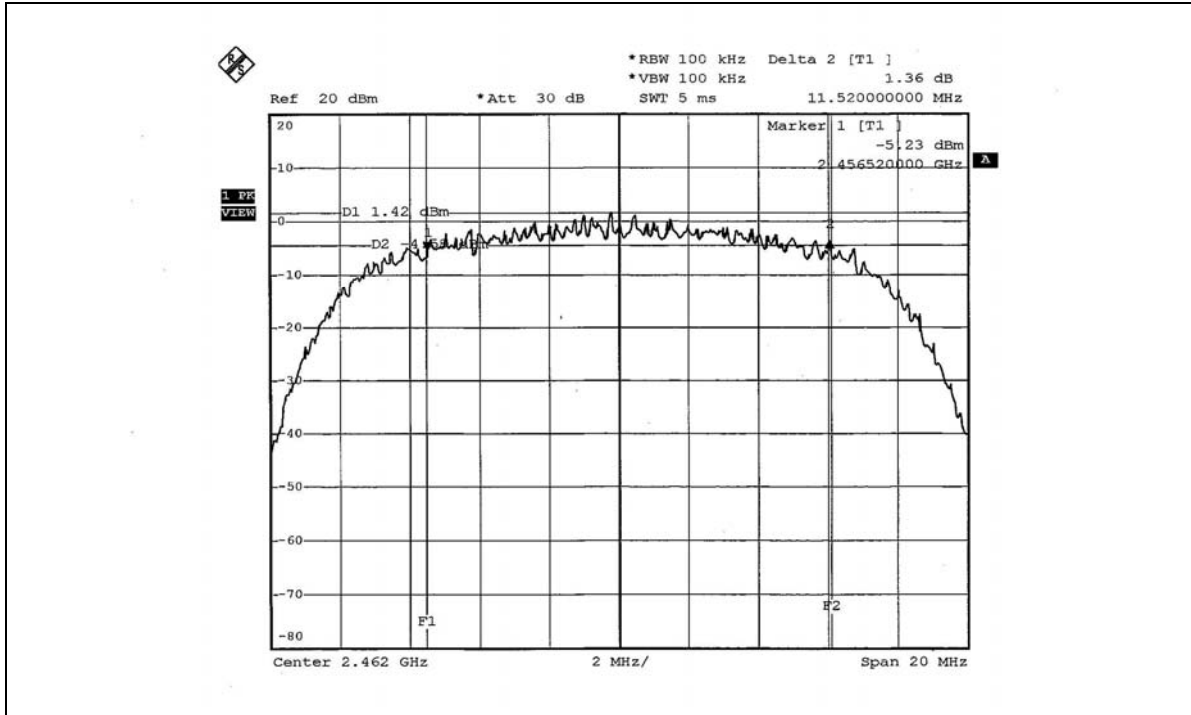



802.11g OFDM modulation

EUT	EDA (Enterprise Digital Assistant)	MODEL	MC7090
MODULATION TYPE	BPSK	TRANSFER RATE	6Mbps
INPUT POWER (SYSTEM)	120Vac, 60 Hz	ENVIRONMENTAL CONDITIONS	27deg.C, 63%RH, 991hPa
TESTED BY	Gary Chang		

CHANNEL	CHANNEL FREQUENCY (MHz)	6dB BANDWIDTH (MHz)	MINIMUM LIMIT (MHz)	PASS/FAIL
1	2412	15.80	0.5	PASS
6	2437	15.68	0.5	PASS
11	2462	15.76	0.5	PASS



CH 1

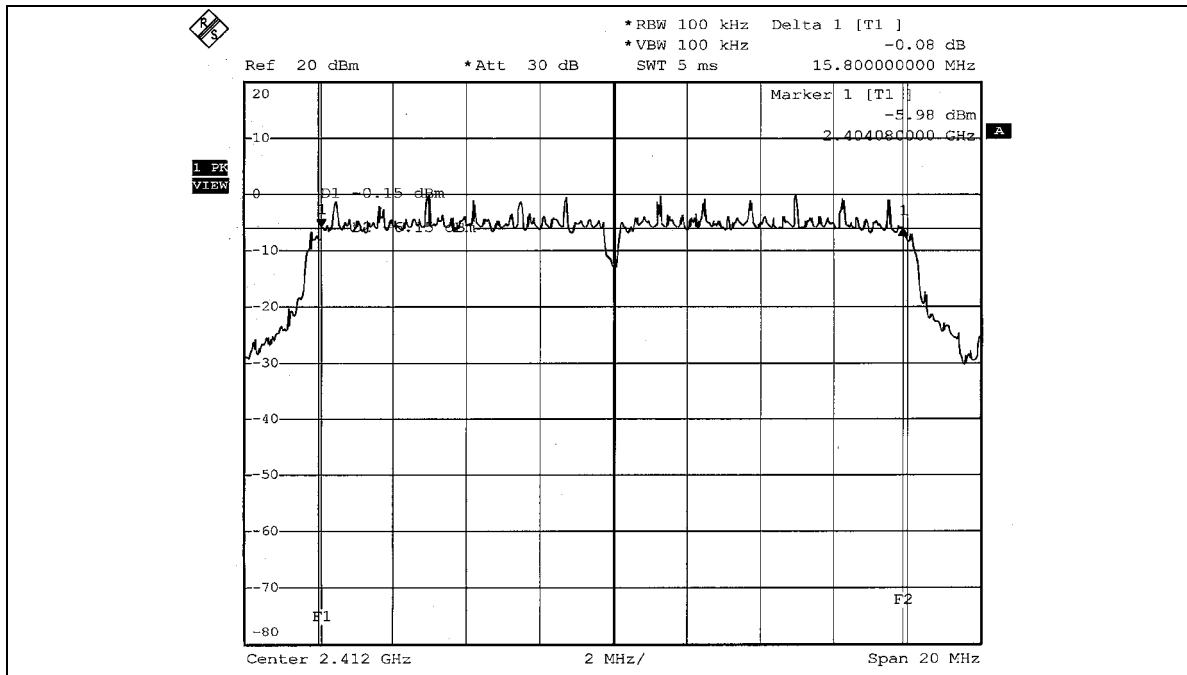

CH 6

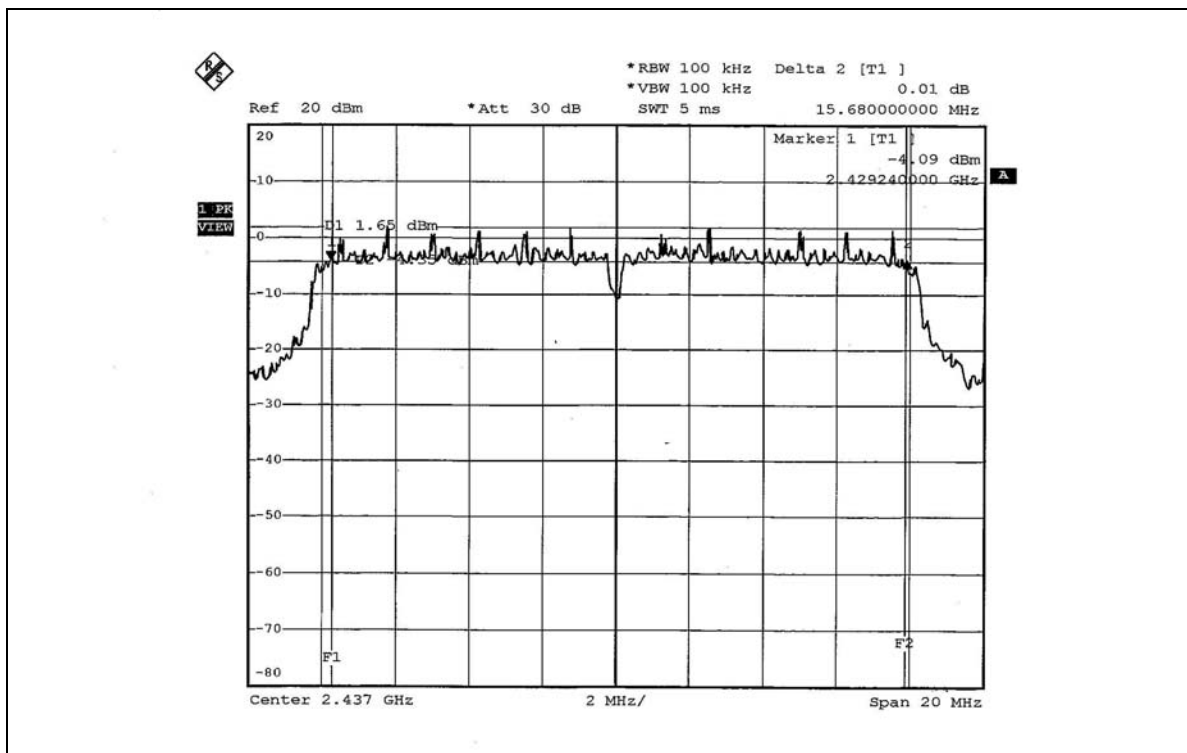



CH 11

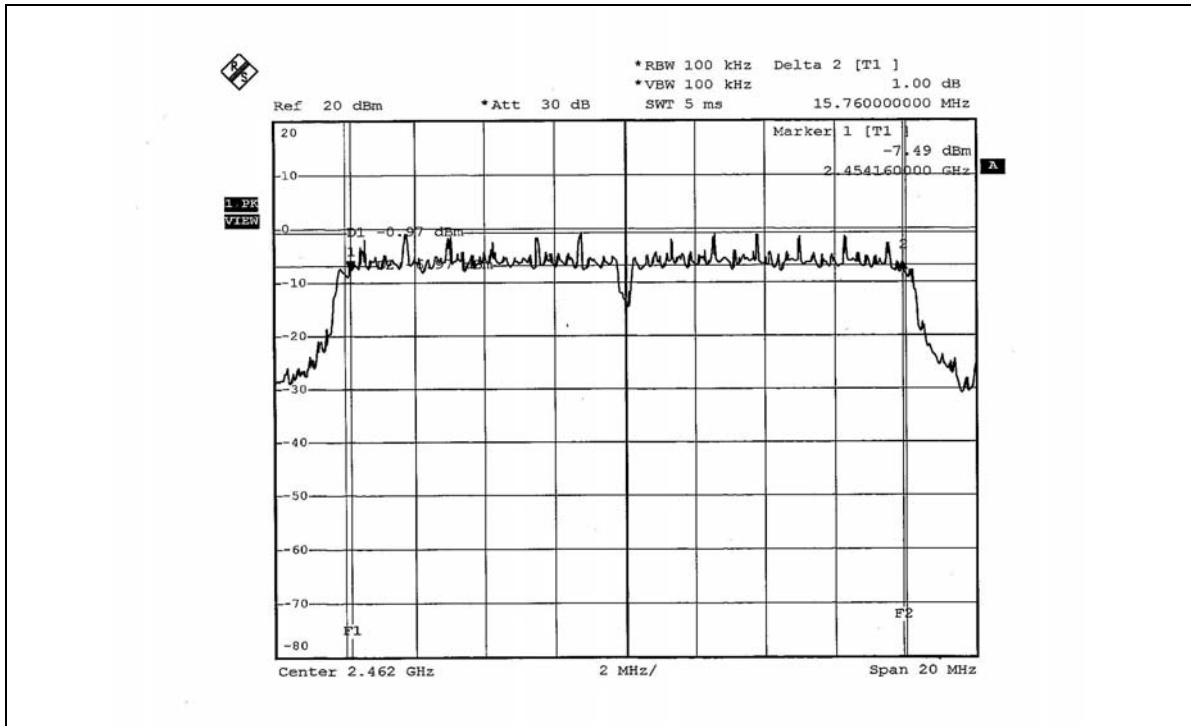



4.4 MAXIMUM PEAK OUTPUT POWER

4.4.1 LIMITS OF MAXIMUM PEAK OUTPUT POWER MEASUREMENT

The Maximum Peak Output Power Measurement is 30dBm.

4.4.2 INSTRUMENTS

Description & Manufacturer	Model No.	Serial No.	Calibrated Until
R&S SPECTRUM ANALYZER	FSEK30	100049	Aug. 14, 2006
AGILENT SIGNAL GENERATOR	E8257C	MY43320668	Dec. 31, 2005
TEKTRONIX OSCILLOSCOPE	TDS 1012	C019167	Feb. 01, 2006
NARDA DETECTOR	4503A	FSCM99899	NA

NOTE:

The calibration interval of the above test instruments is 12 months and the calibrations are traceable to NML/ROC and NIST/USA.

4.4.1 TEST PROCEDURES

1. A detector was used on the output port of the EUT. An oscilloscope was used to read the response of the detector.
2. Replaced the EUT by the signal generator. The center frequency of the S.G was adjusted to the center frequency of the measured channel.
3. Adjusted the power to have the same reading on oscilloscope. Record the power level.

4.4.2 DEVIATION FROM TEST STANDARD

No deviation

4.4.3 TEST SETUP



4.4.4 EUT OPERATING CONDITIONS

Same as Item 4.3.6



4.4.3 TEST RESULTS

802.11b DSSS modulation

EUT	EDA (Enterprise Digital Assistant)	MODEL	MC7090
MODULATION TYPE	CCK	TRANSFER RATE	11Mbps
INPUT POWER (SYSTEM)	120Vac, 60 Hz	ENVIRONMENTAL CONDITIONS	27deg.C, 63%RH, 991hPa
TESTED BY	Gary Chang		

CHANNEL	CHANNEL FREQUENCY (MHz)	PEAK POWER OUTPUT (mW)	PEAK POWER OUTPUT (dBm)	PEAK POWER LIMIT (dBm)	PASS/FAIL
1	2412	22.699	13.56	30	PASS
6	2437	40.551	16.08	30	PASS
11	2462	25.468	14.06	30	PASS

802.11g OFDM modulation

EUT	EDA (Enterprise Digital Assistant)	MODEL	MC7090
MODULATION TYPE	BPSK	TRANSFER RATE	6Mbps
INPUT POWER (SYSTEM)	120Vac, 60 Hz	ENVIRONMENTAL CONDITIONS	27deg.C, 63%RH, 991hPa
TESTED BY	Gary Chang		

CHANNEL	CHANNEL FREQUENCY (MHz)	PEAK POWER OUTPUT (mW)	PEAK POWER OUTPUT (dBm)	PEAK POWER LIMIT (dBm)	PASS/FAIL
1	2412	25.235	14.02	30	PASS
6	2437	44.771	16.51	30	PASS
11	2462	25.410	14.05	30	PASS



4.5 POWER SPECTRAL DENSITY MEASUREMENT

4.5.1 LIMITS OF POWER SPECTRAL DENSITY MEASUREMENT

The Maximum of Power Spectral Density Measurement is 8dBm.

4.5.2 TEST INSTRUMENTS

Description & Manufacturer	Model No.	Serial No.	Calibrated Until
R&S SPECTRUM ANALYZER	FSEK30	100049	Aug. 14, 2006

NOTE:

The calibration interval of the above test instruments is 12 months and the calibrations are traceable to NML/ROC and NIST/USA.

4.5.3 TEST PROCEDURE

The transmitter output was connected to the spectrum analyzer through an attenuator, the bandwidth of the fundamental frequency was measured with the spectrum analyzer using 3kHz RBW and 30kHz VBW, set sweep time = span/3kHz. The power spectral density was measured and recorded. The sweep time is allowed to be longer than span/3kHz for a full response of the mixer in the spectrum analyzer.

4.5.4 DEVIATION FROM TEST STANDARD

No deviation

4.5.5 TEST SETUP

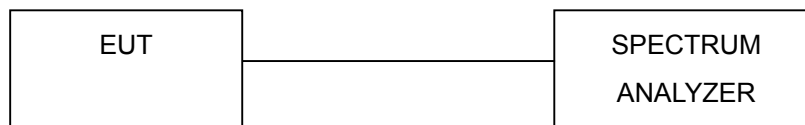

4.5.6 EUT OPERATING CONDITION

Same as Item 4.3.6



4.5.7 TEST RESULTS

802.11b DSSS modulation

EUT	EDA (Enterprise Digital Assistant)	MODEL	MC7090
MODULATION TYPE	CCK	TRANSFER RATE	11Mbps
INPUT POWER (SYSTEM)	120Vac, 60 Hz	ENVIRONMENTAL CONDITIONS	27deg.C, 63%RH, 991hPa
TESTED BY	Gary Chang		

CHANNEL	CHANNEL FREQUENCY (MHz)	RF POWER LEVEL IN 3kHz BW (dBm)	MAXIMUM LIMIT (dBm)	PASS/FAIL
1	2412	-12.45	8	PASS
6	2437	-9.67	8	PASS
11	2462	-12.86	8	PASS



CH 1

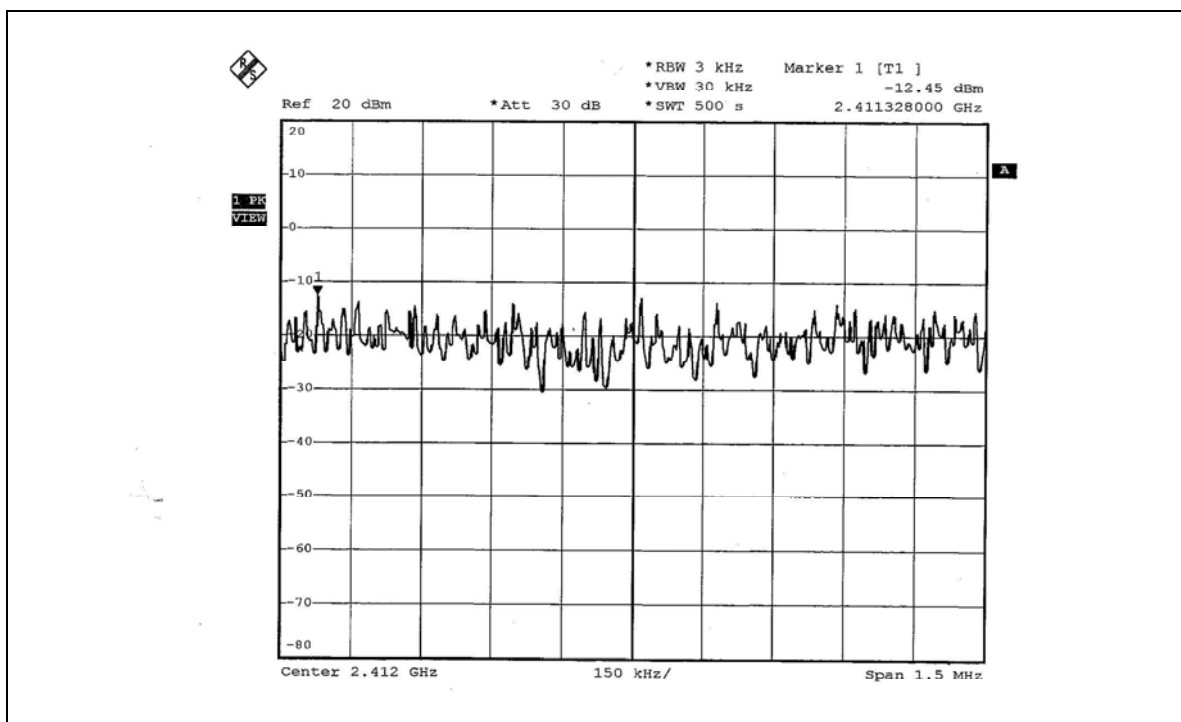

CH 6

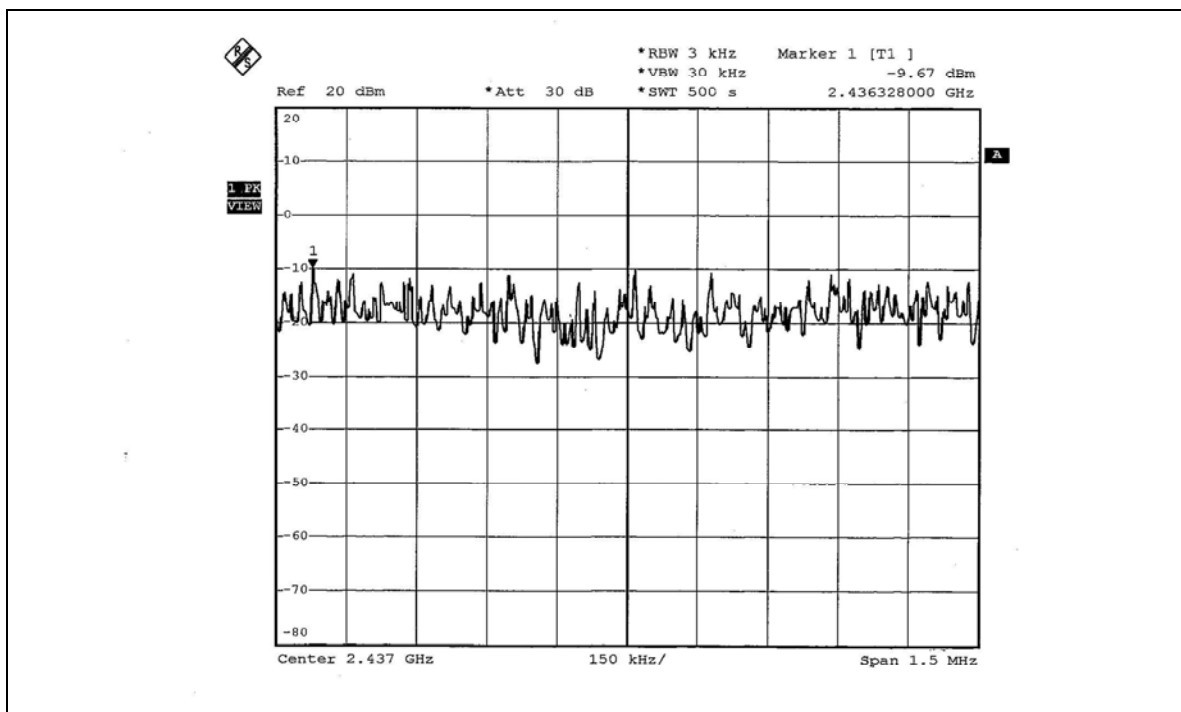



CH 11

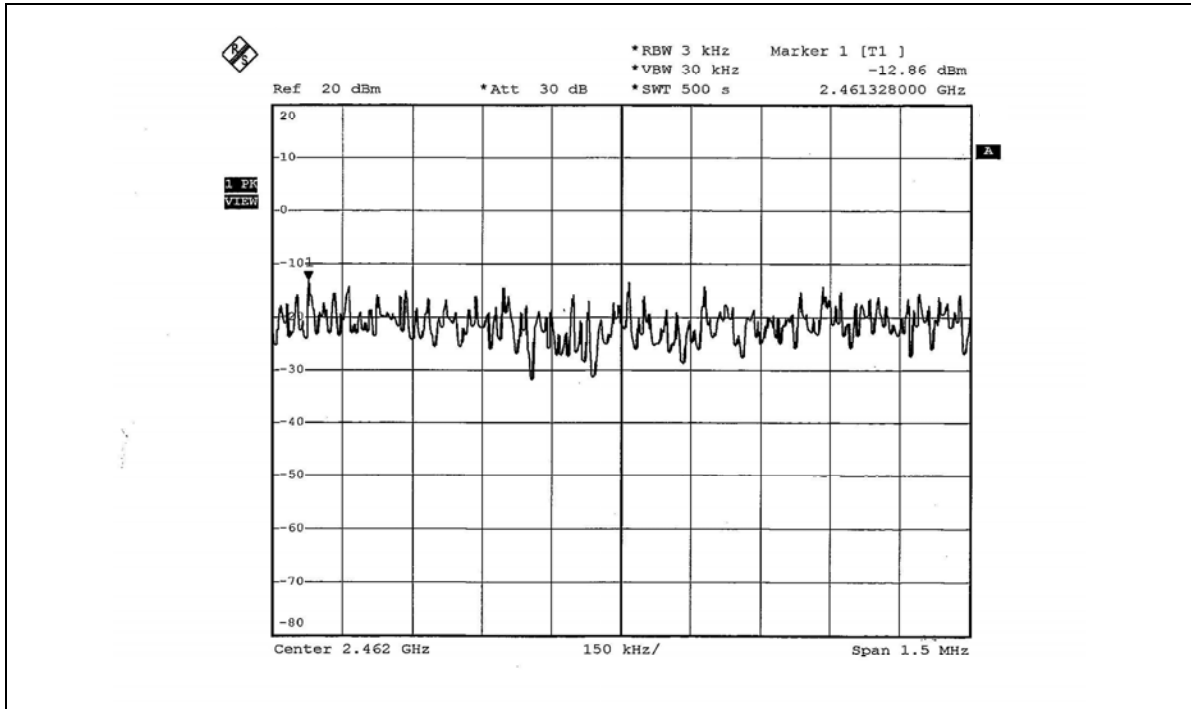



802.11g OFDM modulation

EUT	EDA (Enterprise Digital Assistant)	MODEL	MC7090
MODULATION TYPE	BPSK	TRANSFER RATE	6Mbps
INPUT POWER (SYSTEM)	120Vac, 60 Hz	ENVIRONMENTAL CONDITIONS	27deg.C, 63%RH, 991hPa
TESTED BY	Gary Chang		

CHANNEL	CHANNEL FREQUENCY (MHz)	RF POWER LEVEL IN 3kHz BW (dBm)	MAXIMUM LIMIT (dBm)	PASS/FAIL
1	2412	-16.83	8	PASS
6	2437	-14.45	8	PASS
11	2462	-17.20	8	PASS



CH 1

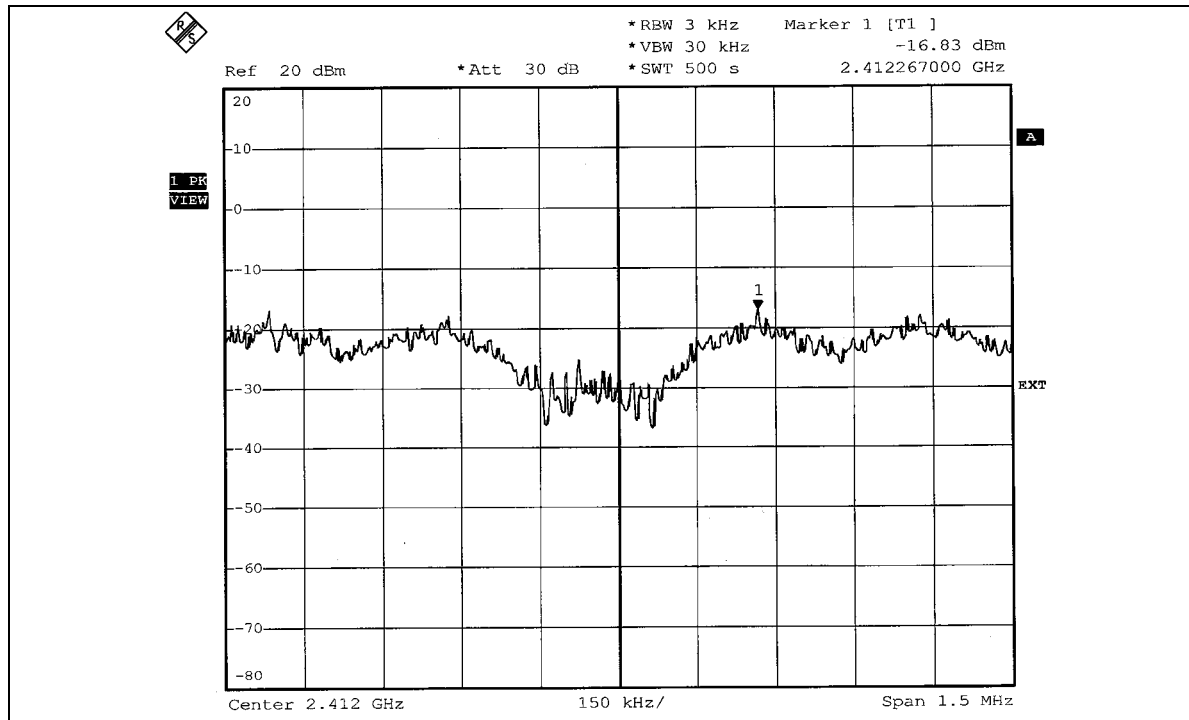

CH 6

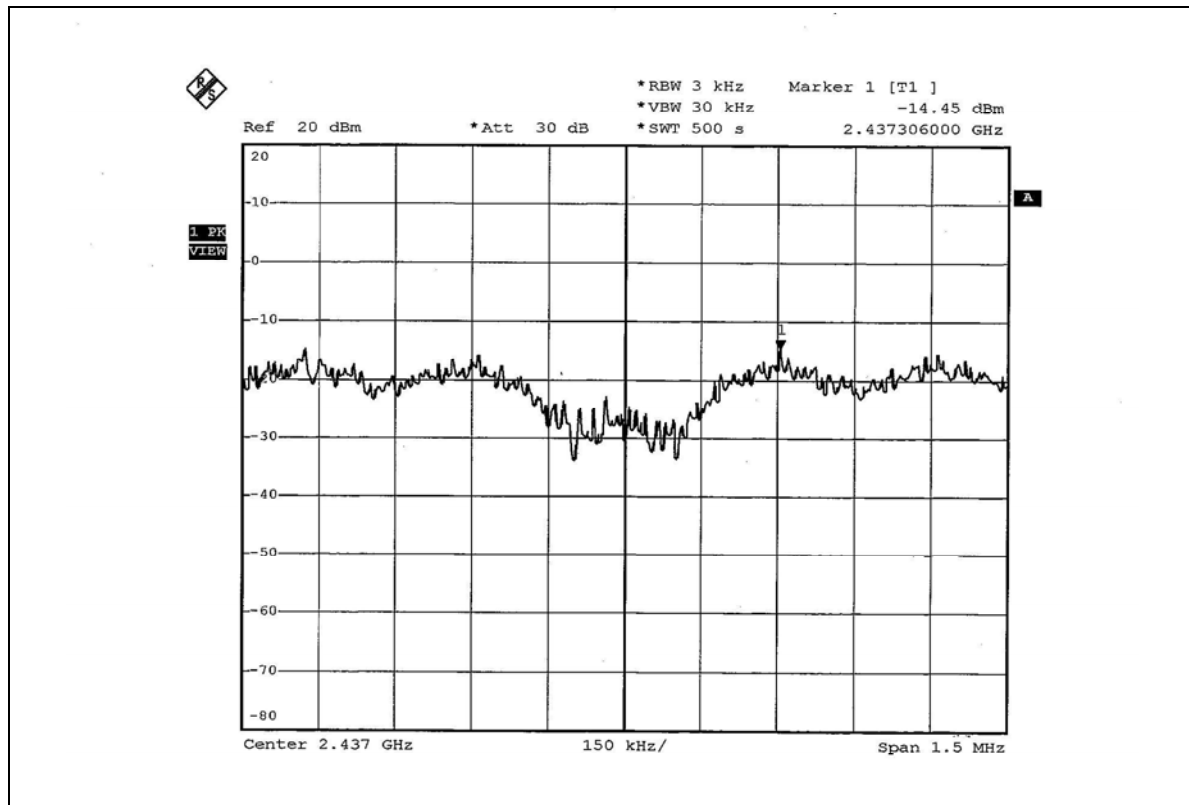



CH 11

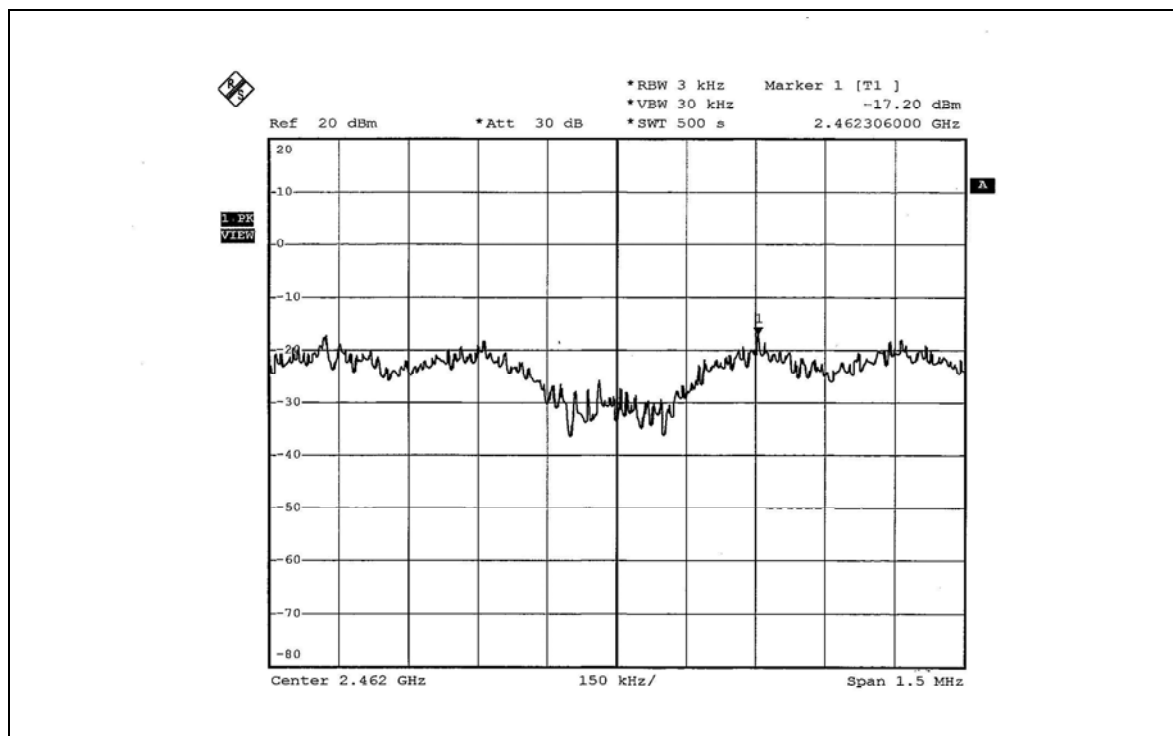



4.6 BAND EDGES MEASUREMENT

4.6.1 LIMITS OF BAND EDGES MEASUREMENT

Below -20dB of the highest emission level of operating band (in 100kHz Resolution Bandwidth).

4.6.2 TEST INSTRUMENTS

Description & Manufacturer	Model No.	Serial No.	Calibrated Until
R&S SPECTRUM ANALYZER	FSEK30	100049	Aug. 14, 2006

NOTE: The calibration interval of the above test instruments is 12 months and the calibrations are traceable to NML/ROC and NIST/USA.

4.6.3 TEST PROCEDURE

The transmitter output was connected to the spectrum analyzer via a low lose cable. Set both RBW and VBW of spectrum analyzer to 100kHz with suitable frequency span including 100 MHz bandwidth from band edge. The band edges was measured and recorded.

The spectrum plots (Peak RBW=VBW=100kHz ; Average RBW=1MHz, VBW=10Hz) are attached on the following pages.

4.6.4 DEVIATION FROM TEST STANDARD

No deviation

4.6.5 EUT OPERATING CONDITION

Same as Item 4.3.6



4.6.6 TEST RESULTS

The spectrum plots are attached on the following 12 images. D1 line indicates the highest level, and D2 line indicates the 20dB offset below D1. It shows compliance with the requirement in part 15.247(d).

802.11b DSSS modulation

NOTE 1: The band edge emission plot on page 71 shows 49.86dBc between carrier maximum power and local maximum emission in restrict band (2.3552GHz). The emission of carrier strength list in the test result of channel 1 at the item 4.2.7 is 108.09dBuV/m (Peak), so the maximum field strength in restrict band is $108.09 - 49.86 = 58.23$ dBuV/m which is under 74dBuV/m limit.

The band edge emission plot of on page 71 shows 56.51dBc between carrier maximum power and local maximum emission in restrict band (2.3900GHz). The emission of carrier strength list in the test result of channel 1 at the item 4.2.7 is 100.63dBuV/m (Average), so the maximum field strength in restrict band is $100.63 - 56.51 = 44.12$ dBuV/m which is under 54dBuV/m limit.

NOTE 2: The band edge emission plot on page 72 shows 50.24dBc between carrier maximum power and local maximum emission in restrict band (2.4872GHz). The emission of carrier strength list in the test result of channel 11 at the item 4.2.7 is 106.21dBuV/m (Peak), so the maximum field strength in restrict band is $106.21 - 50.24 = 55.97$ dBuV/m which is under 74dBuV/m limit.

The band edge emission plot on page 73 shows 55.69dBc between carrier maximum power and local maximum emission in restrict band (2.4835GHz). The emission of carrier strength list in the test result of channel 11 at the item 4.2.7 is 98.58dBuV/m (Average), so the maximum field strength in restrict band is $98.58 - 55.69 = 42.89$ dBuV/m which is under 54dBuV/m limit.

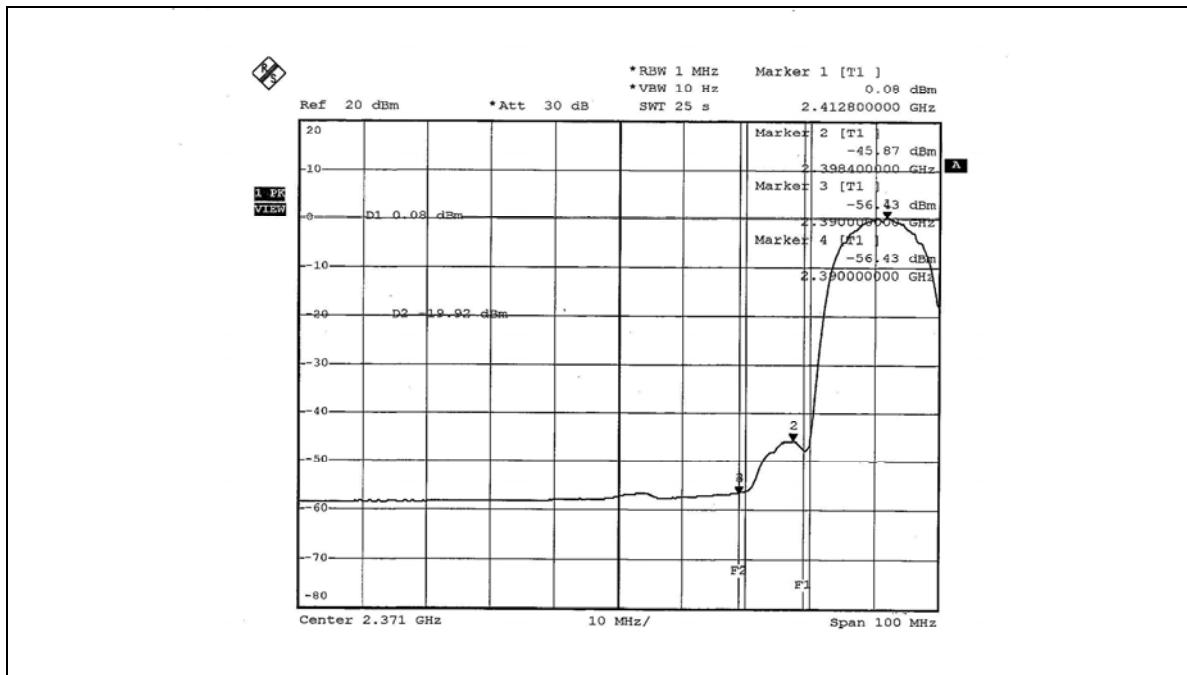
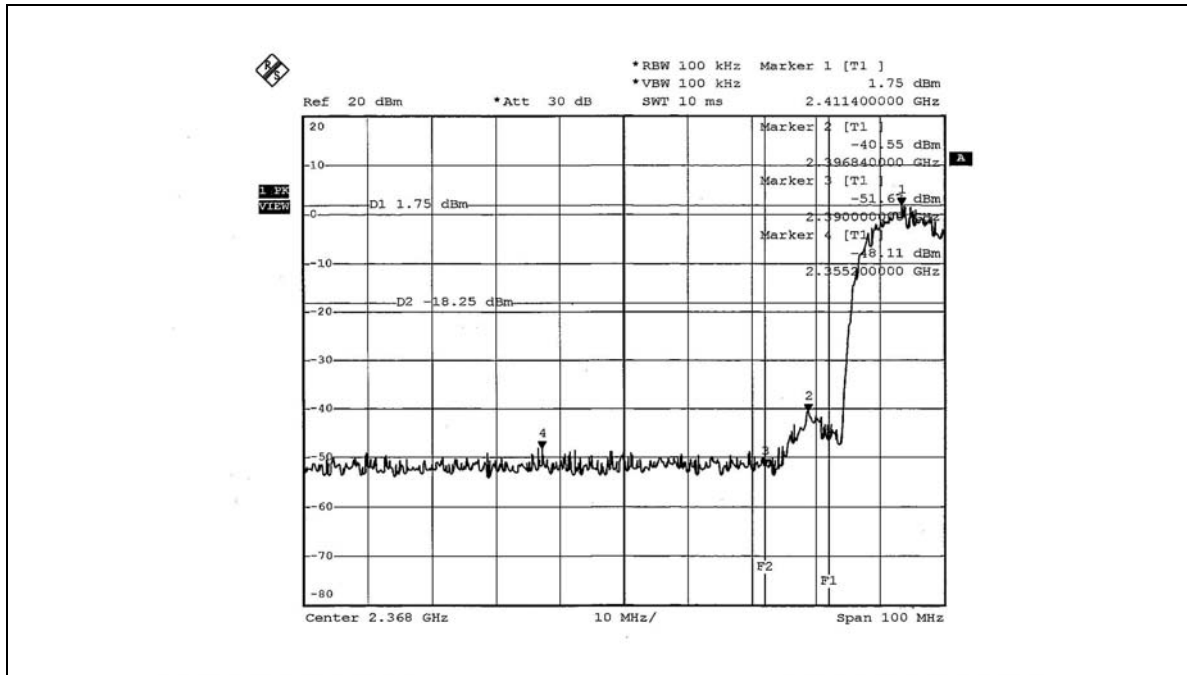

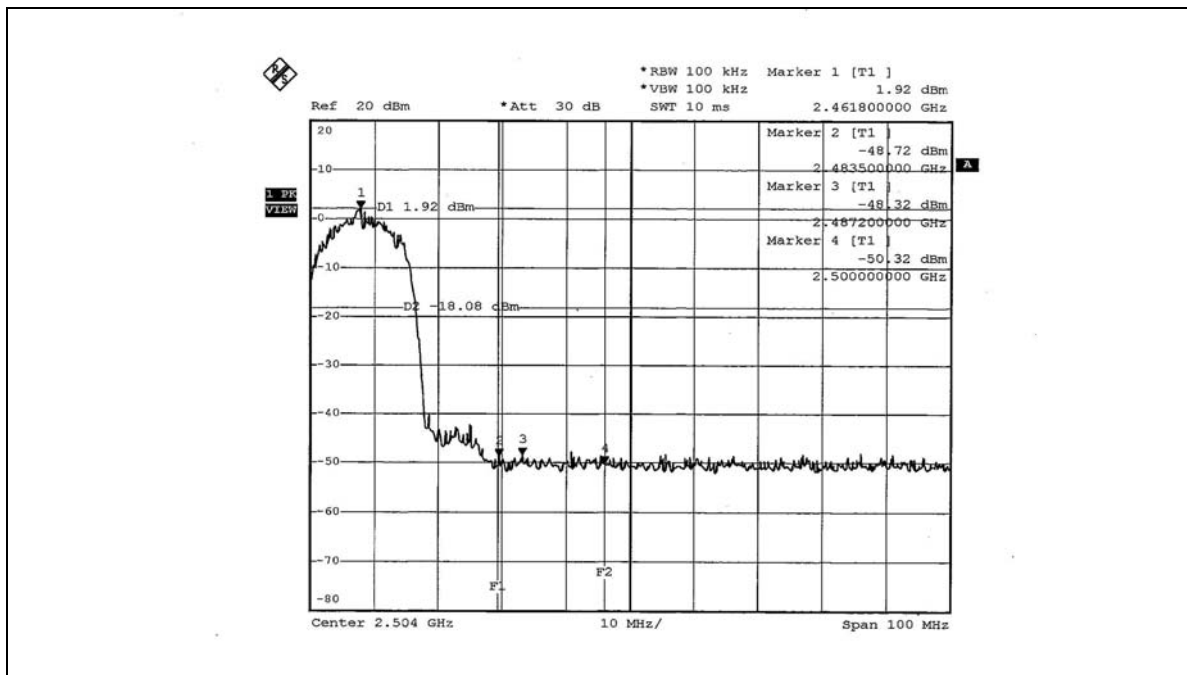
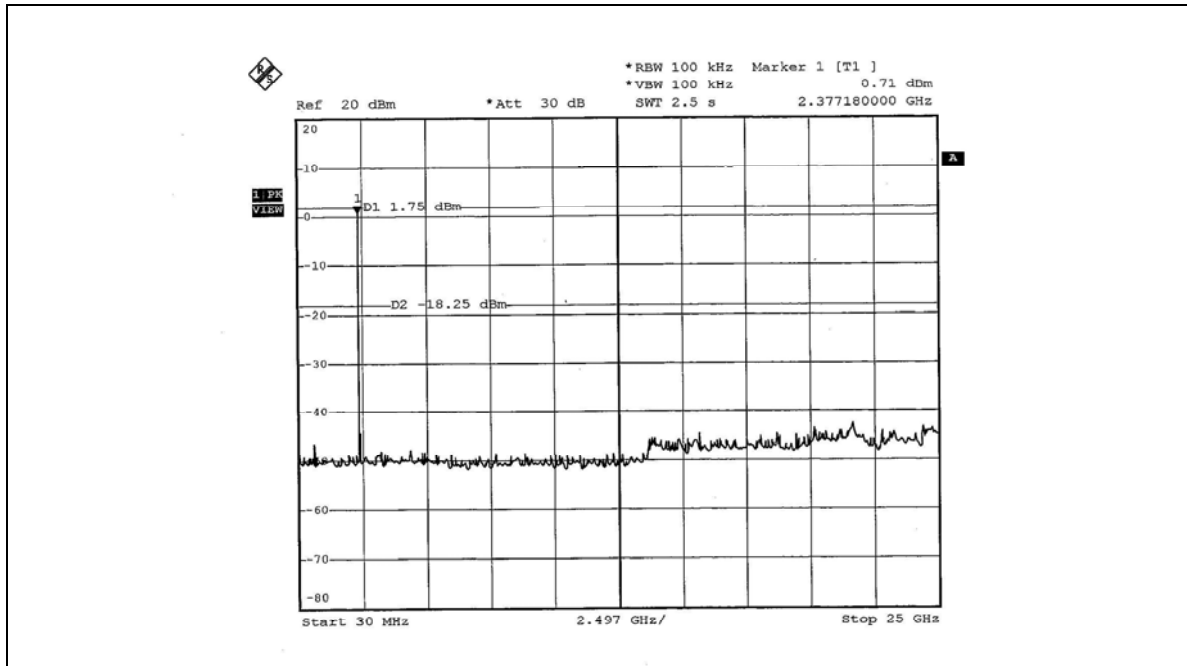

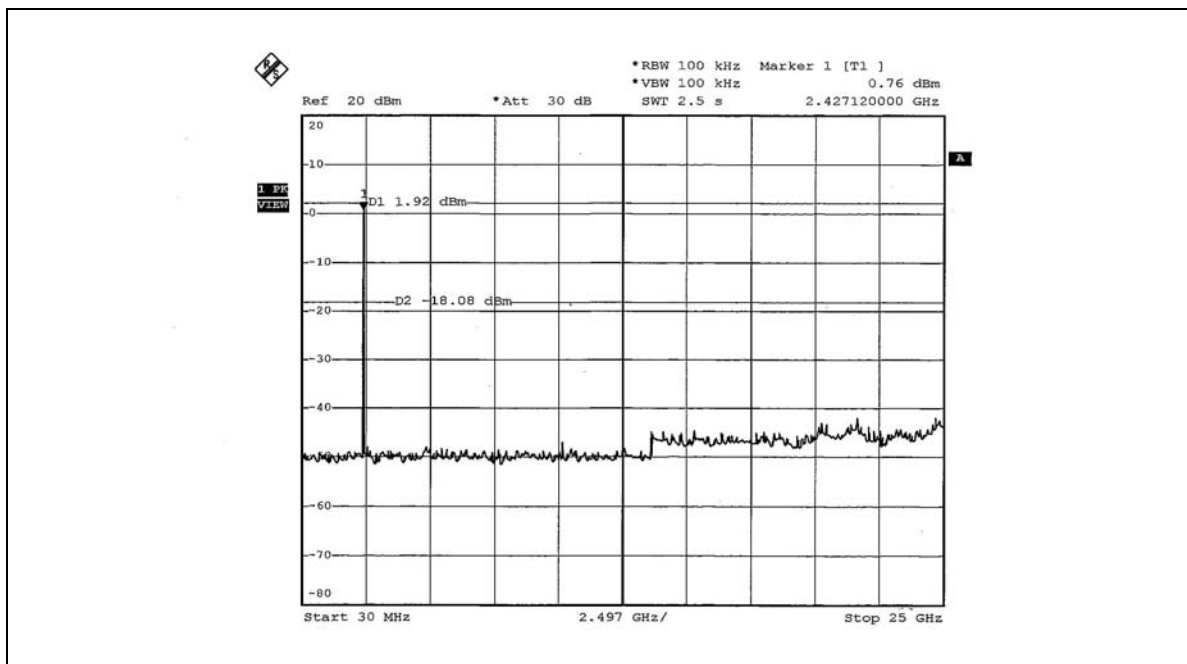
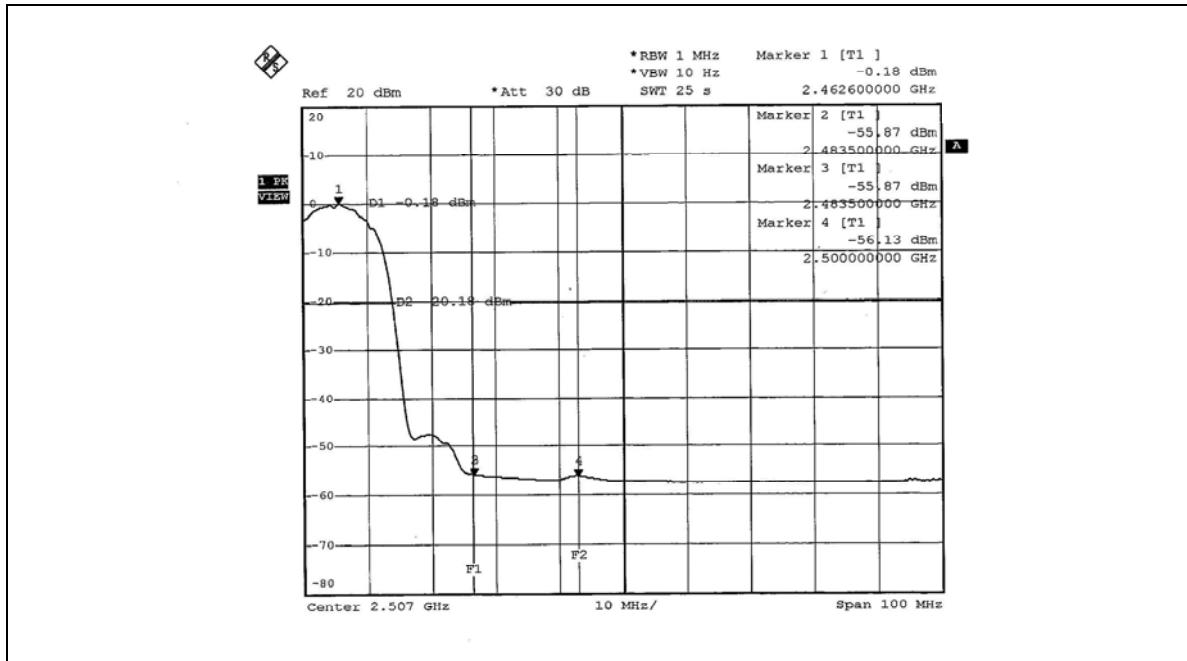



802.11g OFDM modulation

NOTE 1: The band edge emission plot on page 75 shows 47.43dBc between carrier maximum power and local maximum emission in restrict band (2.3546GHz). The emission of carrier strength list in the test result of channel 1 at the item 4.2.7 is 107.44dBuV/m (Peak), so the maximum field strength in restrict band is $107.44 - 47.43 = 60.01$ dBuV/m which is under 74dBuV/m limit.

The band edge emission plot of on page 75 shows 50.42dBc between carrier maximum power and local maximum emission in restrict band (2.3900GHz). The emission of carrier strength list in the test result of channel 1 at the item 4.2.7 is 97.55dBuV/m (Average), so the maximum field strength in restrict band is $97.55 - 50.42 = 47.13$ dBuV/m which is under 54dBuV/m limit.

NOTE 2: The band edge emission plot on page 76 shows 47.14dBc between carrier maximum power and local maximum emission in restrict band (2.4835GHz). The emission of carrier strength list in the test result of channel 11 at the item 4.2.7 is 105.65dBuV/m (Peak), so the maximum field strength in restrict band is $105.65 - 47.14 = 58.51$ dBuV/m which is under 74dBuV/m limit.

The band edge emission plot on page 77 shows 50.34dBc between carrier maximum power and local maximum emission in restrict band (2.4835GHz). The emission of carrier strength list in the test result of channel 11 at the item 4.2.7 is 95.64dBuV/m (Average), so the maximum field strength in restrict band is $95.64 - 50.34 = 45.30$ dBuV/m which is under 54dBuV/m limit.

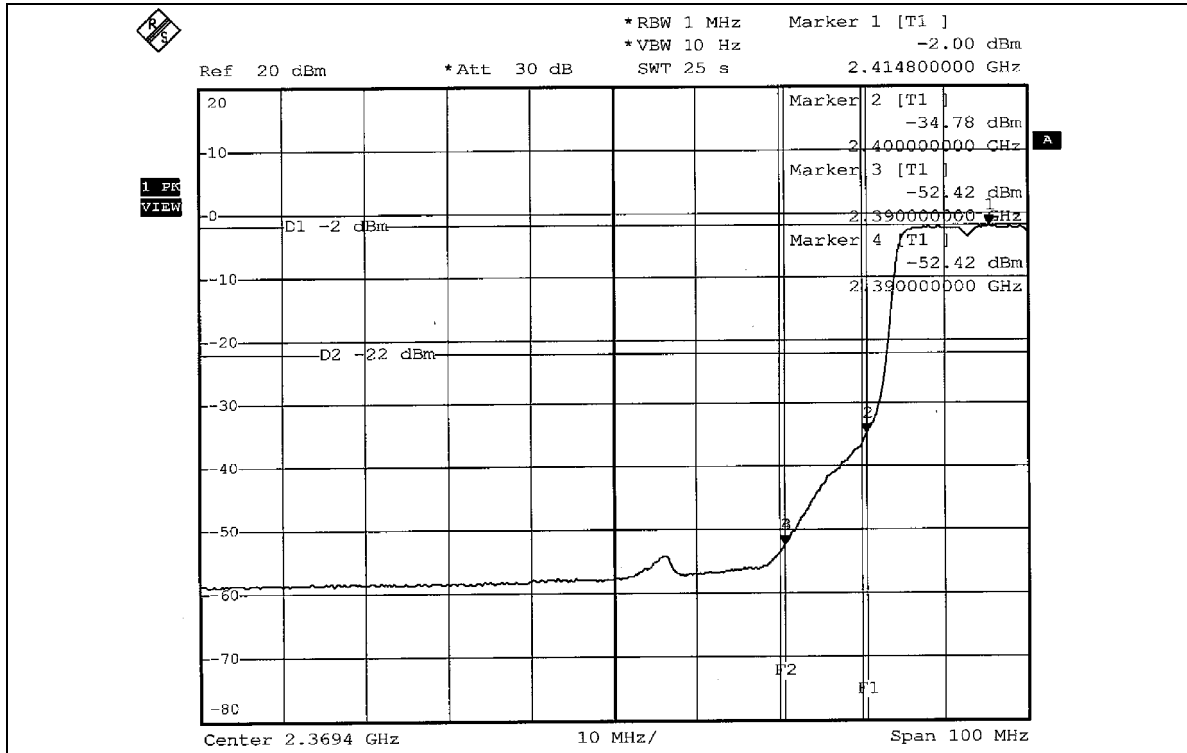
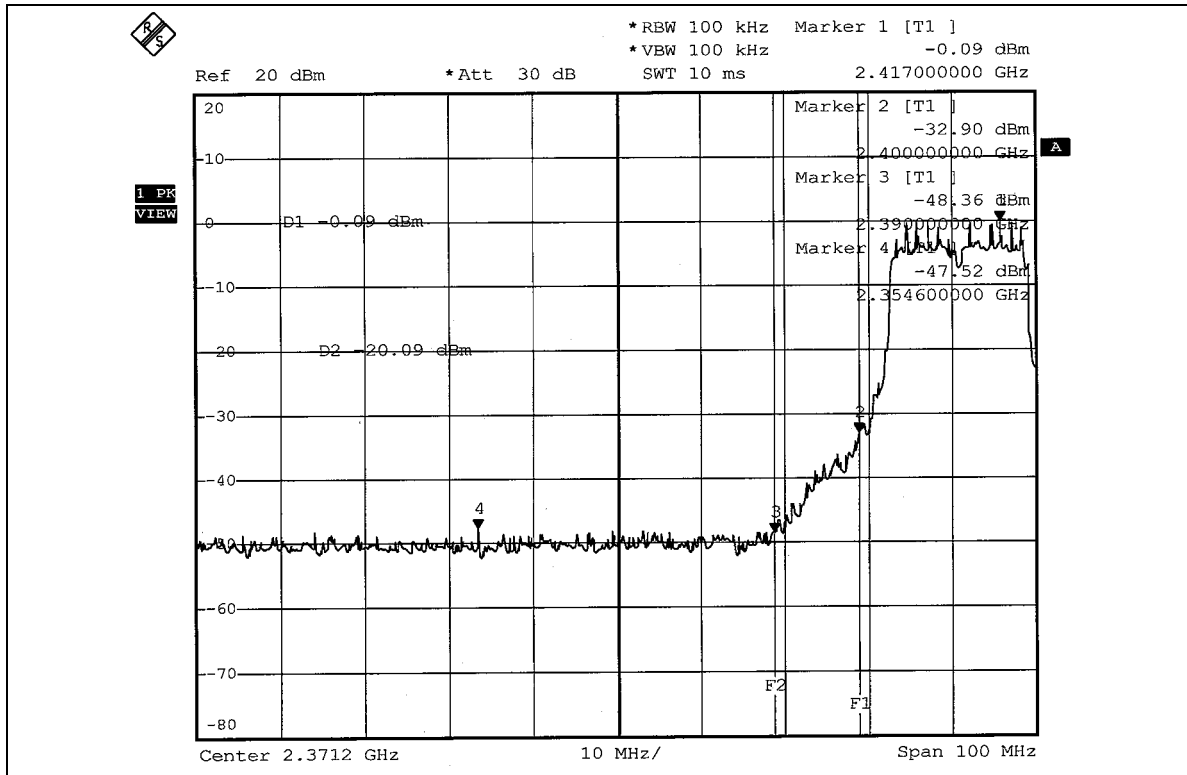

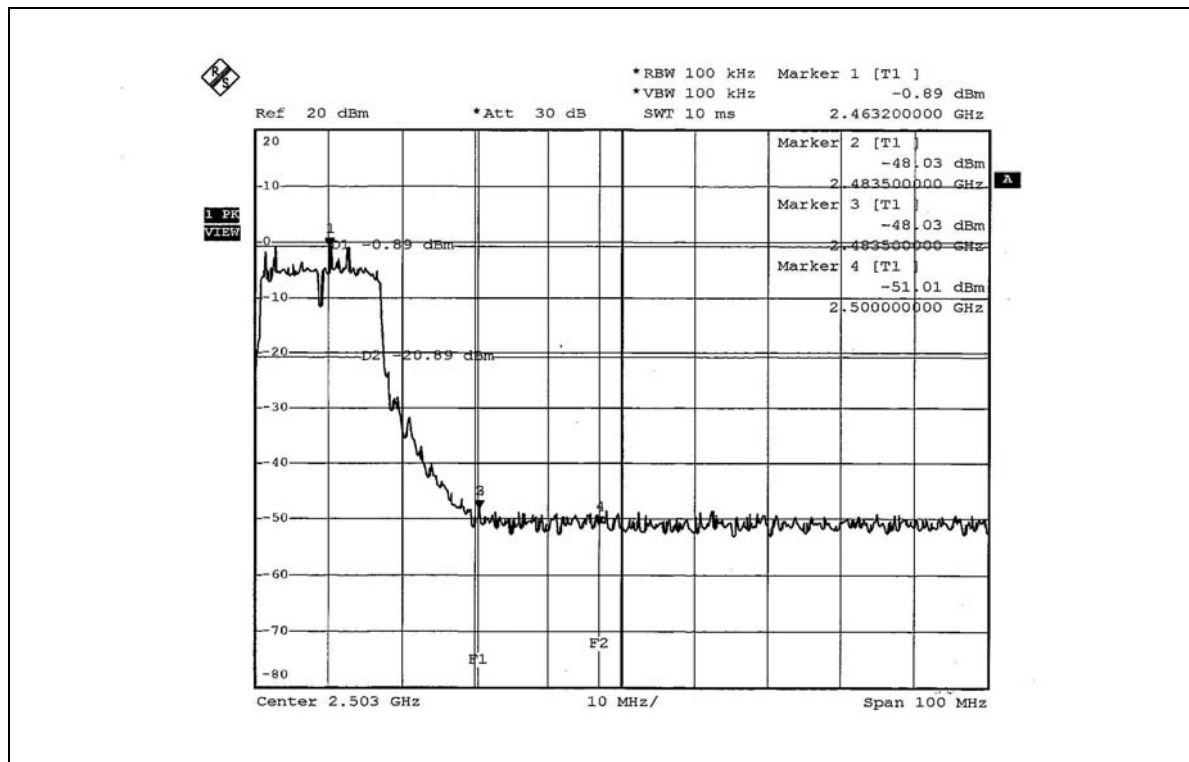
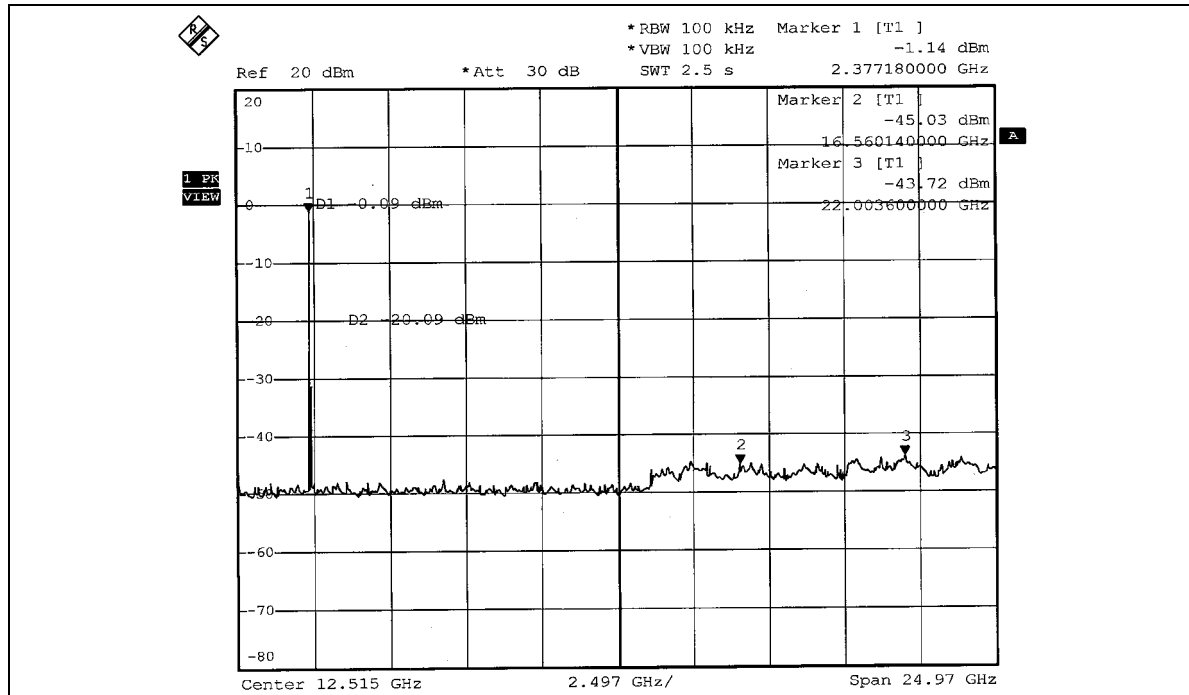

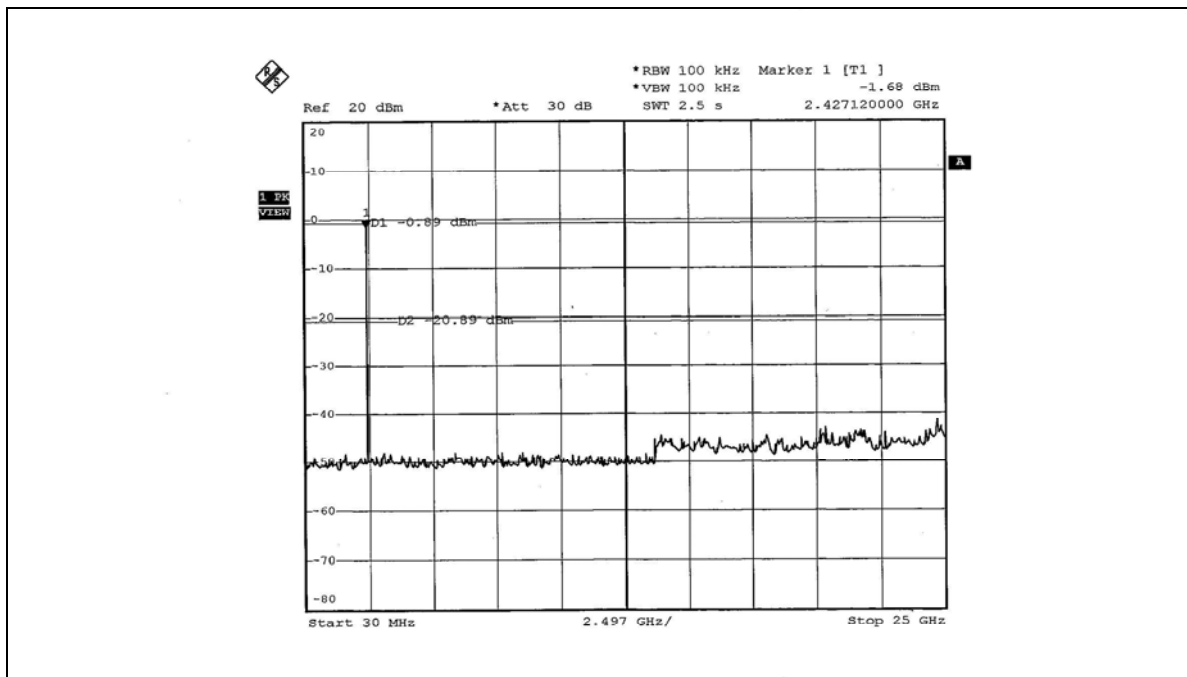
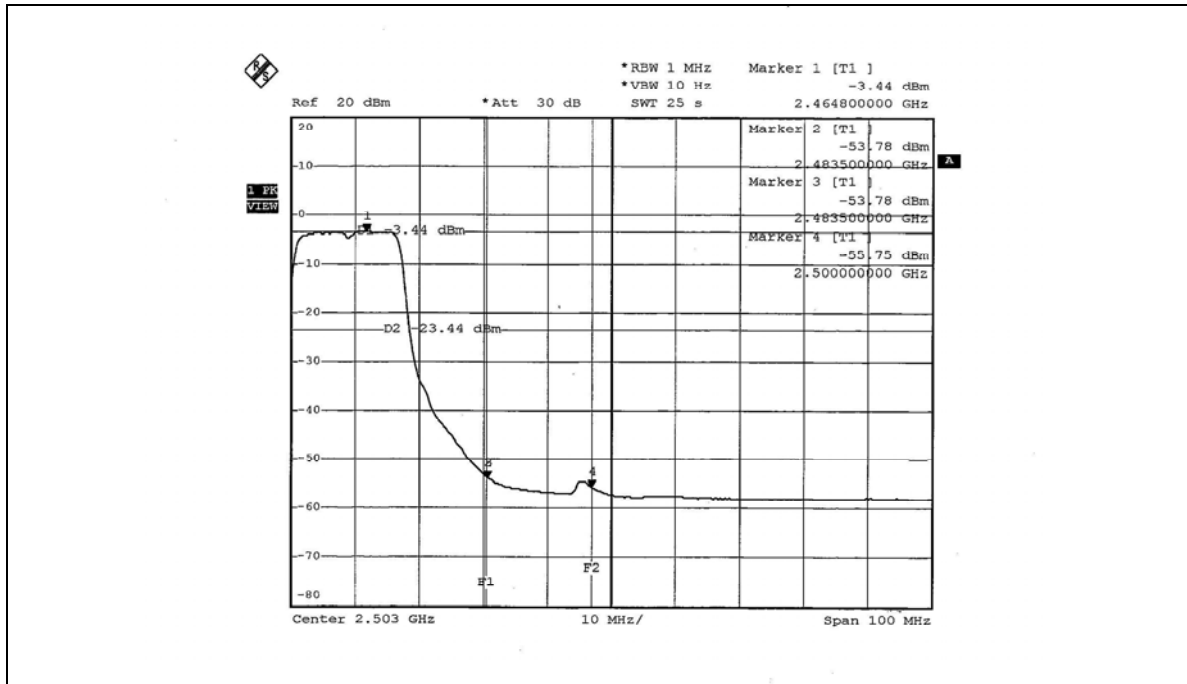



4.7 ANTENNA REQUIREMENT

4.7.1 STANDARD APPLICABLE

For intentional device, according to FCC 47 CFR Section 15.203, an intentional radiator shall be designed to ensure that no antenna other than that furnished by the responsible party shall be used with the device. And according to FCC 47 CFR Section 15.247 (b), if transmitting antennas of directional gain greater than 6dBi are used, the power shall be reduced by the amount in dB that the directional gain of the antenna exceeds 6dBi.

4.7.2 ANTENNA CONNECTED CONSTRUCTION

The antenna used in this product is PIFA antenna with UFL connector. The maximum Gain of the antenna is 2.0dBi.



5. TEST TYPES AND RESULTS (FOR 802.11a 5745~5825MHz Band)

5.1 CONDUCTED EMISSION MEASUREMENT

5.1.1 LIMITS OF CONDUCTED EMISSION MEASUREMENT

FREQUENCY OF EMISSION (MHz)	CONDUCTED LIMIT (dB μ V)	
	Quasi-peak	Average
0.15-0.5	66 to 56	56 to 46
0.5-5	56	46
5-30	60	50

- NOTE:**
- The lower limit shall apply at the transition frequencies.
 - The limit decreases in line with the logarithm of the frequency in the range of 0.15 to 0.50 MHz.
 - All emanations from a class A/B digital device or system, including any network of conductors and apparatus connected thereto, shall not exceed the level of field strengths specified above.

5.1.2 TEST INSTRUMENTS

DESCRIPTION & MANUFACTURER	MODEL NO.	SERIAL NO.	CALIBRATED UNTIL
Test Receiver ROHDE & SCHWARZ	ESCS30	100288	Nov. 06, 2005
RF signal cable Woken	5D-FB	Cable-HyC02-01	Jan. 09, 2006
LISN ROHDE & SCHWARZ	ESH2-Z5	100100	Jan. 20, 2006
LISN ROHDE & SCHWARZ	ESH3-Z5	100311	Jan. 20, 2006
Software ADT	ADT_Cond_V3	NA	NA

- NOTE:**
- The calibration interval of the above test instruments is 12 months and the calibrations are traceable to NML/ROC and NIST/USA.
 - The test was performed in HwaYa Shielded Room 3.
 - The VCCI Site Registration No. is C-2047.



5.1.3 TEST PROCEDURES

- a. The EUT was placed 0.4 meters from the conducting wall of the shielded room with EUT being connected to the power mains through a line impedance stabilization network (LISN). Other support units were connected to the power mains through another LISN. The two LISNs provide 50 ohm/ 50uH of coupling impedance for the measuring instrument.
- b. Both lines of the power mains connected to the EUT were checked for maximum conducted interference.
- c. The frequency range from 150kHz to 30MHz was searched. Emission levels under (Limit – 20dB) was not recorded.

5.1.4 DEVIATION FROM TEST STANDARD

No deviation

5.1.5 TEST SETUP

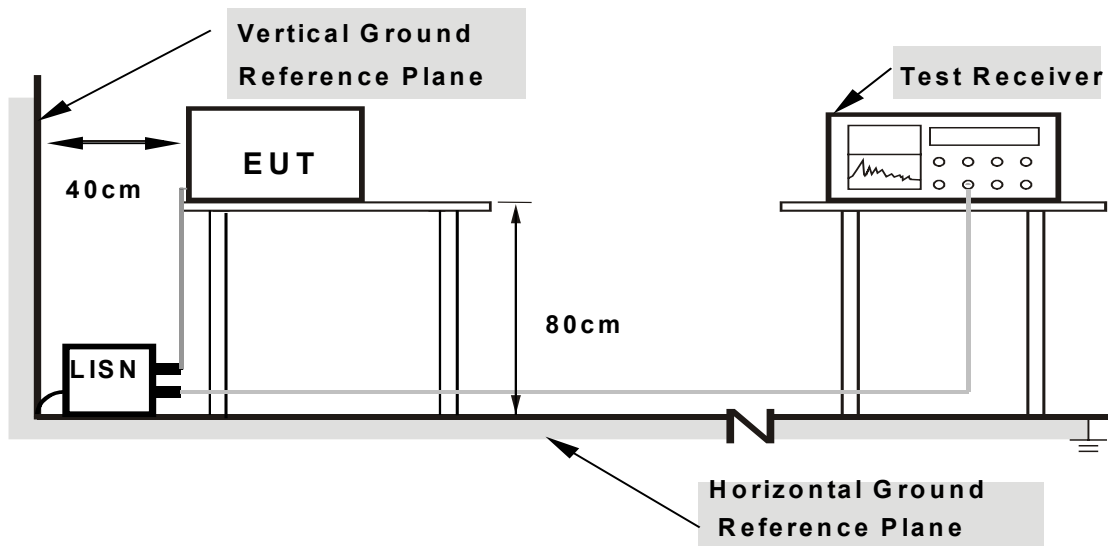

- Note:**
- 1.Support units were connected to second LISN.
 - 2.Both of LISNs (AMN) are 80 cm from EUT and at least 80 from other units and other metal planes

For the actual test configuration, please refer to the related item – Photographs of the Test Configuration.

5.1.6 EUT OPERATING CONDITIONS

Same as 4.1.6



5.1.7 TEST RESULTS

Conducted Worst-Case Data (with charging cable)

EUT	EDA (Enterprise Digital Assistant)	MEASUREMENT DETAIL	
MODEL	MC7090	PHASE	Line 1
CHANNEL	Channel 5	6dB BANDWIDTH	9 kHz
MODULATION TYPE	BPSK	ENVIRONMENTAL CONDITIONS	26deg. C, 65%RH, 991hPa
TRANSFER RATE	6Mbps	INPUT POWER (SYSTEM)	120Vac, 60 Hz
TEST MODE	A	TESTED BY	Jay Hsu

No	Freq. [MHz]	Corr. Factor (dB)	Reading Value [dB (uV)]		Emission Level [dB (uV)]		Limit [dB (uV)]		Margin (dB)	
			Q.P.	AV.	Q.P.	AV.	Q.P.	AV.	Q.P.	AV.
			1	0.189	0.11	42.77	-	42.88	-	64.10
2	0.246	0.11	35.62	-	35.73	-	61.88	51.88	-26.15	-
3	0.378	0.12	27.79	-	27.91	-	58.33	48.33	-30.42	-
4	0.669	0.17	22.17	-	22.34	-	56.00	46.00	-33.66	-
5	0.939	0.22	18.68	-	18.90	-	56.00	46.00	-37.10	-
6	3.157	0.27	30.58	-	30.85	-	56.00	46.00	-25.15	-

- REMARKS:**
1. Q.P. and AV. are abbreviations of quasi-peak and average individually.
 2. "-": The Quasi-peak reading value also meets average limit and measurement with the average detector is unnecessary.
 3. The emission levels of other frequencies were very low against the limit.
 4. Margin value = Emission level - Limit value
 5. Correction factor = Insertion loss + Cable loss
 6. Emission Level = Correction Factor + Reading Value.

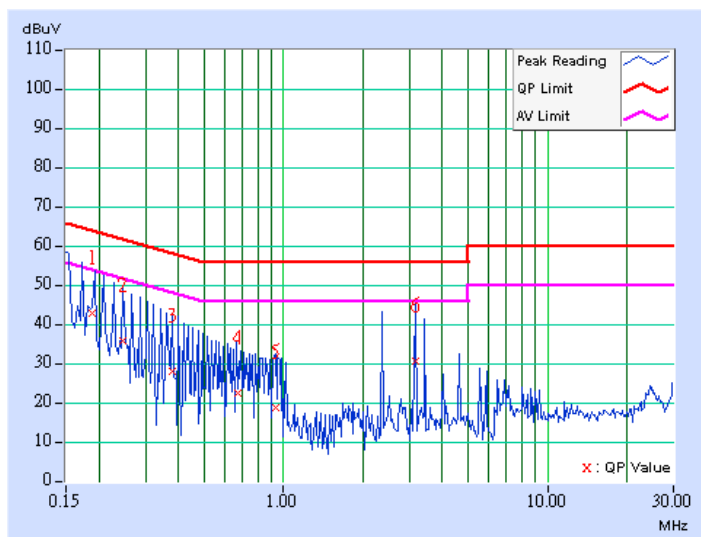



EUT	EDA (Enterprise Digital Assistant)	MEASUREMENT DETAIL	
MODEL	MC7090	PHASE	Line 2
CHANNEL	Channel 5	6dB BANDWIDTH	9 kHz
MODULATION TYPE	BPSK	ENVIRONMENTAL CONDITIONS	26deg. C, 65%RH, 991hPa
TRANSFER RATE	6Mbps	INPUT POWER (SYSTEM)	120Vac, 60 Hz
TEST MODE	A	TESTED BY	Jay Hsu

No	Freq. [MHz]	Corr. Factor (dB)	Reading Value		Emission Level		Limit		Margin	
			[dB (uV)]		[dB (uV)]		[dB (uV)]		(dB)	
			Q.P.	AV.	Q.P.	AV.	Q.P.	AV.	Q.P.	AV.
1	0.185	0.11	42.09	-	42.20	-	64.25	54.25	-22.06	-
2	0.244	0.11	36.17	-	36.28	-	61.94	51.94	-25.66	-
3	0.317	0.12	30.92	-	31.04	-	59.78	49.78	-28.75	-
4	0.671	0.17	21.38	-	21.55	-	56.00	46.00	-34.45	-
5	0.994	0.23	19.17	-	19.40	-	56.00	46.00	-36.60	-
6	2.165	0.25	26.23	-	26.48	-	56.00	46.00	-29.52	-

- REMARKS:**
1. Q.P. and AV. are abbreviations of quasi-peak and average individually.
 2. "-": The Quasi-peak reading value also meets average limit and measurement with the average detector is unnecessary.
 3. The emission levels of other frequencies were very low against the limit.
 4. Margin value = Emission level - Limit value
 5. Correction factor = Insertion loss + Cable loss
 6. Emission Level = Correction Factor + Reading Value.

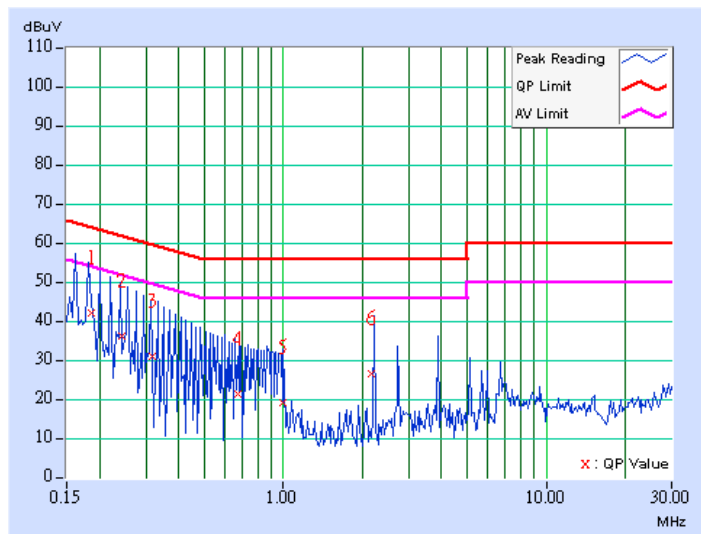



Conducted Worst-Case Data (with cradle)

EUT	EDA (Enterprise Digital Assistant)	MEASUREMENT DETAIL	
MODEL	MC7090	PHASE	Line 1
CHANNEL	Channel 5	6dB BANDWIDTH	9 kHz
MODULATION TYPE	BPSK	ENVIRONMENTAL CONDITIONS	26deg. C, 65%RH, 991hPa
TRANSFER RATE	6Mbps	INPUT POWER (SYSTEM)	120Vac, 60 Hz
TEST MODE	B	TESTED BY	Jay Hsu

No	Freq. [MHz]	Corr. Factor (dB)	Reading Value		Emission Level		Limit		Margin	
			[dB (uV)]		[dB (uV)]		[dB (uV)]		(dB)	
			Q.P.	AV.	Q.P.	AV.	Q.P.	AV.	Q.P.	AV.
1	0.201	0.11	48.05	-	48.16	-	63.58	53.58	-15.42	-
2	0.298	0.11	39.57	-	39.68	-	60.29	50.29	-20.61	-
3	0.498	0.13	36.67	-	36.80	-	56.04	46.04	-19.24	-
4	0.998	0.24	32.43	-	32.67	-	56.00	46.00	-23.33	-
5	2.094	0.27	31.92	-	32.19	-	56.00	46.00	-23.81	-
6	4.289	0.40	39.03	-	39.43	-	56.00	46.00	-16.57	-

- REMARKS:**
1. Q.P. and AV. are abbreviations of quasi-peak and average individually.
 2. "-": The Quasi-peak reading value also meets average limit and measurement with the average detector is unnecessary.
 3. The emission levels of other frequencies were very low against the limit.
 4. Margin value = Emission level - Limit value
 5. Correction factor = Insertion loss + Cable loss
 6. Emission Level = Correction Factor + Reading Value.

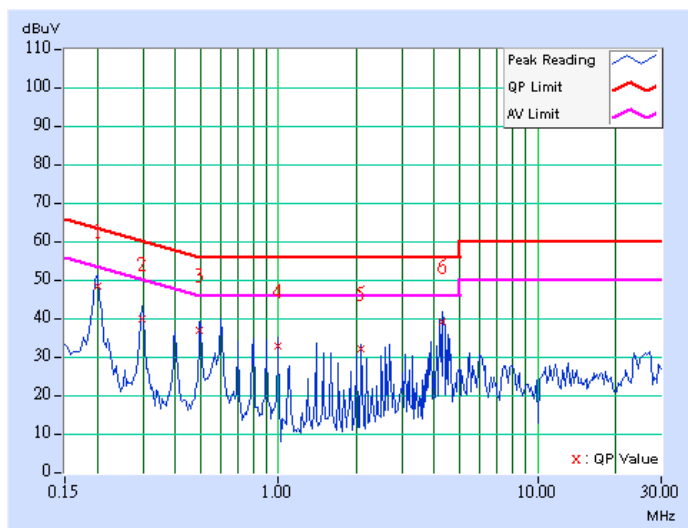



EUT	EDA (Enterprise Digital Assistant)	MEASUREMENT DETAIL	
MODEL	MC7090	PHASE	Line 2
CHANNEL	Channel 5	6dB BANDWIDTH	9 kHz
MODULATION TYPE	BPSK	ENVIRONMENTAL CONDITIONS	26deg. C, 65%RH, 991hPa
TRANSFER RATE	6Mbps	INPUT POWER (SYSTEM)	120Vac, 60 Hz
TEST MODE	B	TESTED BY	Jay Hsu

No	Freq. [MHz]	Corr. Factor (dB)	Reading Value		Emission Level		Limit		Margin	
			[dB (uV)]		[dB (uV)]		[dB (uV)]		(dB)	
			Q.P.	AV.	Q.P.	AV.	Q.P.	AV.	Q.P.	AV.
1	0.201	0.11	47.38	-	47.49	-	63.58	53.58	-16.09	-
2	0.298	0.11	39.44	-	39.55	-	60.29	50.29	-20.74	-
3	0.498	0.13	37.12	-	37.25	-	56.04	46.04	-18.79	-
4	1.496	0.25	33.66	-	33.91	-	56.00	46.00	-22.09	-
5	3.793	0.38	33.35	-	33.73	-	56.00	46.00	-22.27	-
6	4.297	0.39	32.19	-	32.58	-	56.00	46.00	-23.42	-

- REMARKS:**
1. Q.P. and AV. are abbreviations of quasi-peak and average individually.
 2. "-": The Quasi-peak reading value also meets average limit and measurement with the average detector is unnecessary.
 3. The emission levels of other frequencies were very low against the limit.
 4. Margin value = Emission level - Limit value
 5. Correction factor = Insertion loss + Cable loss
 6. Emission Level = Correction Factor + Reading Value.

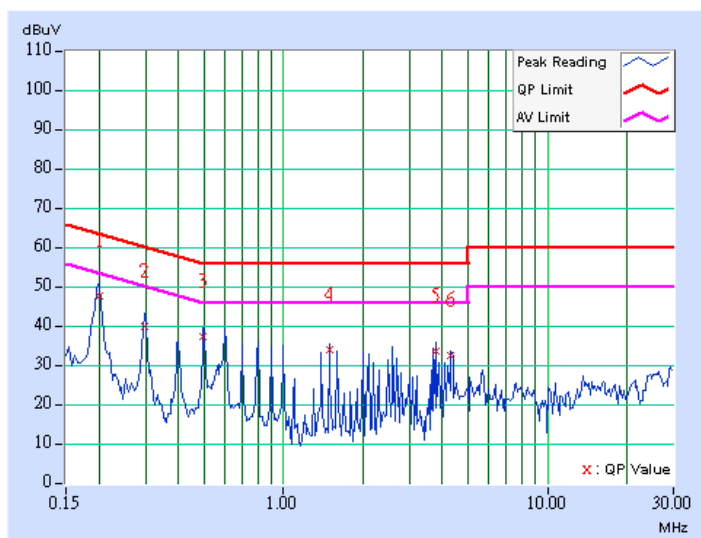



5.2 RADIATED EMISSION MEASUREMENT

5.2.1 LIMITS OF RADIATED EMISSION MEASUREMENT

Emissions radiated outside of the specified bands, shall be according to the general radiated limits in 15.209 as following:

Frequencies (MHz)	Field strength (microvolts/meter)	Measurement distance (meters)
0.009-0.490	2400/F(kHz)	300
0.490-1.705	24000/F(kHz)	30
1.705-30.0	30	30
30-88	100	3
88-216	150	3
216-960	200	3
Above 960	500	3

NOTE:

1. The lower limit shall apply at the transition frequencies.
2. Emission level (dBuV/m) = 20 log Emission level (uV/m).
3. As shown in 15.35(b), for frequencies above 1000MHz, the field strength limits are based on average detector, however, the peak field strength of any emission shall not exceed the maximum permitted average limits, specified above by more than 20dB under any condition of modulation.



5.2.2 TEST INSTRUMENTS

DESCRIPTION & MANUFACTURER	MODEL NO.	SERIAL NO.	CALIBRATED UNTIL
Test Receiver ROHDE & SCHWARZ	ESIB7	100188	Dec. 19, 2005
Spectrum Analyzer ROHDE & SCHWARZ	FSP40	100039	Nov. 21, 2005
BILOG Antenna SCHWARZBECK	VULB9168	9168-157	Jan. 22, 2006
HORN Antenna SCHWARZBECK	BBHA 9120 D	9120D-407	Jan. 16, 2006
HORN Antenna SCHWARZBECK	BBHA 9170	BBHA 9170241	Feb. 23, 2006
Preamplifier Agilent	8449B	3008A01961	Nov. 09, 2005
Preamplifier Agilent	8447D	2944A10629	Nov. 09, 2005
RF signal cable HUBER+SUHNER	SUCOFLEX 104	218182/4	Feb. 17, 2006
RF signal cable HUBER+SUHNER	SUCOFLEX 104	218194/4	Feb. 17, 2006
Software ADT.	ADT_Radiated_V5.14	NA	NA
Antenna Tower ADT.	AT100	AT93021702	NA
Turn Table ADT.	TT100.	TT93021702	NA
Controller ADT.	SC100.	SC93021702	NA
26GHz ~ 40GHz Amplifier	AMF-6F-2600400	923362	Mar. 13, 2006

- NOTE:**
1. The calibration interval of the above test instruments is 12 months and the calibrations are traceable to NML/ROC and NIST/USA.
 2. The test was performed in HwaYa Chamber 1.
 3. The horn antenna and HP preamplifier (model: 8449B) are used only for the measurement of emission frequency above 1GHz if tested.
 4. The IC Site Registration No. is IC4924-2.



5.2.3 TEST PROCEDURES

- a. The EUT was placed on the top of a rotating table 0.8 meters above the ground at a 3 meter semi-anechoic chamber. The table was rotated 360 degrees to determine the position of the highest radiation.
- b. The EUT was set 3 meters away from the interference-receiving antenna, which was mounted on the top of a variable-height antenna tower.
- c. The antenna is a broadband antenna, and its height is varied from one meter to four meters above the ground to determine the maximum value of the field strength. Both horizontal and vertical polarizations of the antenna are set to make the measurement.
- d. For each suspected emission, the EUT was arranged to its worst case and then the antenna was tuned to heights from 1 meter to 4 meters and the rotatable table was turned from 0 degrees to 360 degrees to find the maximum reading.
- e. The test-receiver system was set to Peak Detect Function and Specified Bandwidth with Maximum Hold Mode.
- f. If the emission level of the EUT in peak mode was lower than the limit specified, then testing could be stopped and the peak values of the EUT would be reported. Otherwise the emissions would be re-tested one by one using peak, quasi-peak or average method as specified and then reported in a data sheet.

NOTE:

1. The resolution bandwidth and video bandwidth of test receiver/spectrum analyzer is 120kHz for Peak detection (PK) and Quasi-peak detection (QP) at frequency below 1GHz.
2. The resolution bandwidth and video bandwidth of test receiver/spectrum analyzer is 1 MHz for Peak detection at frequency above 1GHz.
3. The resolution bandwidth of test receiver/spectrum analyzer is 1 MHz and the video bandwidth is 10 Hz for Average detection (AV) at frequency above 1GHz.

5.2.4 DEVIATION FROM TEST STANDARD

No deviation

5.2.5 TEST SETUP

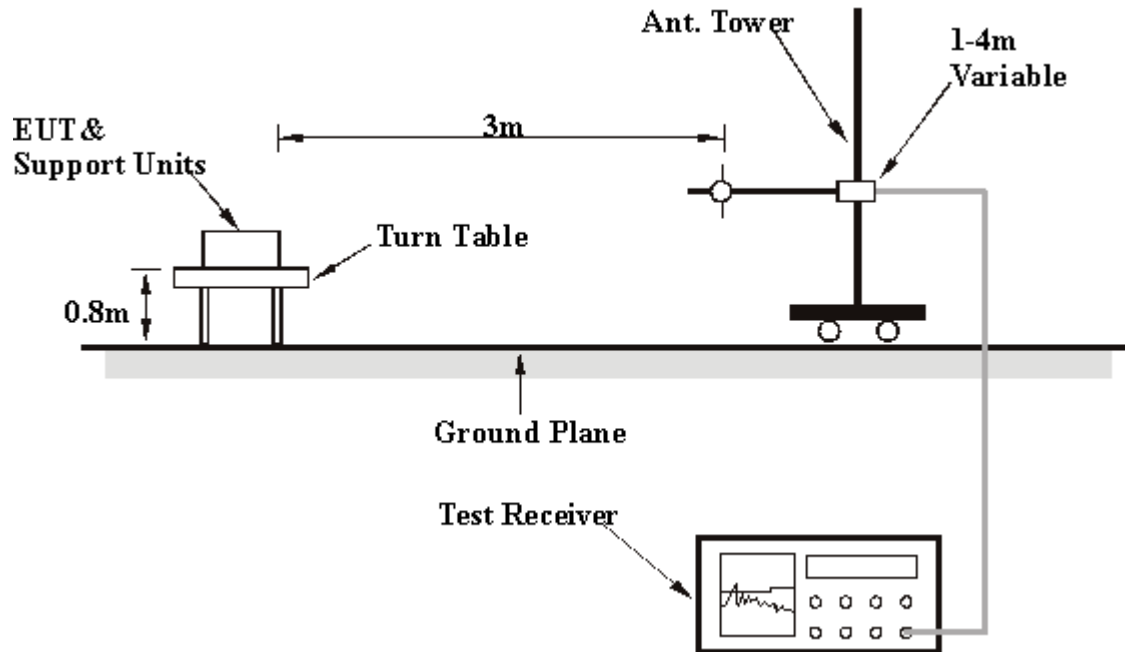

For the actual test configuration, please refer to the related item – Photographs of the Test Configuration.

5.2.6 EUT OPERATING CONDITIONS

Same as 4.1.6



5.2.7 TEST RESULTS

Below 1GHz Worst-Case Data (with charging cable)

EUT	EDA (Enterprise Digital Assistant)	MEASUREMENT DETAIL	
MODEL	MC7090	FREQUENCY RANGE	Below 1000MHz
CHANNEL	Channel 5	DETECTOR FUNCTION	Quasi-Peak
MODULATION TYPE	BPSK	ENVIRONMENTAL CONDITIONS	27deg. C, 64%RH, 991hPa
TRANSFER RATE	6Mbps	INPUT POWER (SYSTEM)	120Vac, 60 Hz
TEST MODE	A	TESTED BY	Match Tsui

ANTENNA POLARITY & TEST DISTANCE: HORIZONTAL AT 3 M

No.	Freq. (MHz)	Emission Level (dBuV/m)	Limit (dBuV/m)	Margin (dB)	Antenna Height (m)	Table Angle (Degree)	Raw Value (dBuV)	Correction Factor (dB/m)
1	57.21	22.30 QP	40.00	-17.70	2.00 H	295	8.56	13.74
2	115.53	30.93 QP	43.50	-12.57	1.50 H	283	18.59	12.34
3	173.85	28.61 QP	43.50	-14.89	1.50 H	292	15.30	13.31
4	249.66	34.92 QP	46.00	-11.08	1.00 H	268	21.84	13.08
5	519.86	30.17 QP	46.00	-15.83	1.50 H	115	11.18	18.99
6	731.74	29.62 QP	46.00	-16.38	1.00 H	298	6.63	22.99

ANTENNA POLARITY & TEST DISTANCE: VERTICAL AT 3 M

No.	Freq. (MHz)	Emission Level (dBuV/m)	Limit (dBuV/m)	Margin (dB)	Antenna Height (m)	Table Angle (Degree)	Raw Value (dBuV)	Correction Factor (dB/m)
1	45.55	25.39 QP	40.00	-14.61	1.00 V	352	10.40	14.99
2	115.53	27.99 QP	43.50	-15.51	1.00 V	335	15.65	12.34
3	168.02	24.78 QP	43.50	-18.72	1.00 V	271	10.90	13.88
4	249.66	33.12 QP	46.00	-12.88	1.50 V	301	20.04	13.08
5	457.66	28.06 QP	46.00	-17.94	1.00 V	106	10.05	18.01
6	731.74	27.30 QP	46.00	-18.70	2.50 V	19	4.31	22.99

- REMARKS:**
1. Emission level(dBuV/m)=Raw Value(dBuV) + Correction Factor(dB/m)
 2. Correction Factor(dB/m) = Antenna Factor (dB/m) + Cable Factor (dB)
 3. The other emission levels were very low against the limit.
 4. Margin value = Emission level – Limit value



Below 1GHz Worst-Case Data (with cradle)

EUT	EDA (Enterprise Digital Assistant)	MEASUREMENT DETAIL	
MODEL	MC7090	FREQUENCY RANGE	Below 1000MHz
CHANNEL	Channel 5	DETECTOR FUNCTION	Quasi-Peak
MODULATION TYPE	BPSK	ENVIRONMENTAL CONDITIONS	27deg. C, 64%RH, 991hPa
TRANSFER RATE	6Mbps	INPUT POWER (SYSTEM)	120Vac, 60 Hz
TEST MODE	B	TESTED BY	Match Tsui

ANTENNA POLARITY & TEST DISTANCE: HORIZONTAL AT 3 M

No.	Freq. (MHz)	Emission Level (dBuV/m)	Limit (dBuV/m)	Margin (dB)	Antenna Height (m)	Table Angle (Degree)	Raw Value (dBuV)	Correction Factor (dB/m)
1	98.04	27.50 QP	43.50	-16.00	2.00 H	271	16.91	10.59
2	133.03	29.92 QP	43.50	-13.58	2.00 H	286	16.20	13.72
3	164.13	34.64 QP	43.50	-8.86	1.50 H	238	20.38	14.26
4	197.17	27.29 QP	43.50	-16.21	1.00 H	238	15.93	11.35
5	249.66	39.12 QP	46.00	-6.88	1.00 H	94	26.04	13.08
6	311.86	28.26 QP	46.00	-17.74	1.00 H	307	13.66	14.60
7	374.07	37.19 QP	46.00	-8.81	1.00 H	106	21.16	16.03
8	449.88	28.81 QP	46.00	-17.19	1.50 H	349	10.90	17.91
9	731.74	30.09 QP	46.00	-15.91	1.00 H	277	7.10	22.99
10	801.72	28.08 QP	46.00	-17.92	1.00 H	307	4.37	23.72

ANTENNA POLARITY & TEST DISTANCE: VERTICAL AT 3 M

No.	Freq. (MHz)	Emission Level (dBuV/m)	Limit (dBuV/m)	Margin (dB)	Antenna Height (m)	Table Angle (Degree)	Raw Value (dBuV)	Correction Factor (dB/m)
1	51.38	24.11 QP	40.00	-15.89	1.00 V	202	9.79	14.33
2	111.64	29.08 QP	43.50	-14.42	1.00 V	193	17.14	11.94
3	162.18	29.85 QP	43.50	-13.65	1.00 V	196	15.40	14.45
4	249.66	38.35 QP	46.00	-7.65	1.50 V	199	25.28	13.08
5	374.07	32.81 QP	46.00	-13.19	1.00 V	172	16.78	16.03
6	449.88	29.04 QP	46.00	-16.96	2.00 V	10	11.13	17.91
7	731.74	28.17 QP	46.00	-17.83	2.50 V	319	5.18	22.99

- REMARKS:**
1. Emission level(dBuV/m)=Raw Value(dBuV) + Correction Factor(dB/m)
 2. Correction Factor(dB/m) = Antenna Factor (dB/m) + Cable Factor (dB)
 3. The other emission levels were very low against the limit.
 4. Margin value = Emission level – Limit value



Below 1GHz Worst-Case Data (battery mode)

EUT	EDA (Enterprise Digital Assistant)	MEASUREMENT DETAIL	
MODEL	MC7090	FREQUENCY RANGE	Below 1000MHz
CHANNEL	Channel 5	DETECTOR FUNCTION	Quasi-Peak
MODULATION TYPE	BPSK	ENVIRONMENTAL CONDITIONS	27deg. C, 64%RH, 991hPa
TRANSFER RATE	6Mbps	INPUT POWER (SYSTEM)	120Vac, 60 Hz
TEST MODE	C	TESTED BY	Match Tsui

ANTENNA POLARITY & TEST DISTANCE: HORIZONTAL AT 3 M

No.	Freq. (MHz)	Emission Level (dBuV/m)	Limit (dBuV/m)	Margin (dB)	Antenna Height (m)	Table Angle (Degree)	Raw Value (dBuV)	Correction Factor (dB/m)
1	96.09	28.94 QP	43.50	-14.56	2.00 H	250	18.51	10.43
2	136.91	34.99 QP	43.50	-8.51	1.00 H	280	20.99	13.99
3	201.06	27.05 QP	43.50	-16.45	1.00 H	256	15.89	11.16
4	519.86	28.37 QP	46.00	-17.63	1.50 H	67	9.38	18.99
5	632.61	26.80 QP	46.00	-19.20	2.50 H	223	5.45	21.35
6	731.74	28.24 QP	46.00	-17.76	1.00 H	280	5.26	22.99

ANTENNA POLARITY & TEST DISTANCE: VERTICAL AT 3 M

No.	Freq. (MHz)	Emission Level (dBuV/m)	Limit (dBuV/m)	Margin (dB)	Antenna Height (m)	Table Angle (Degree)	Raw Value (dBuV)	Correction Factor (dB/m)
1	45.55	29.91 QP	40.00	-10.09	1.50 V	7	14.91	14.99
2	115.53	23.84 QP	43.50	-19.66	1.00 V	25	11.50	12.34
3	166.07	28.10 QP	43.50	-15.40	1.00 V	205	14.03	14.07
4	617.05	27.26 QP	46.00	-18.74	1.00 V	142	6.13	21.13
5	733.69	26.01 QP	46.00	-19.99	1.50 V	352	2.98	23.03
6	836.71	31.83 QP	46.00	-14.17	1.00 V	4	7.82	24.01

- REMARKS:**
1. Emission level(dBuV/m)=Raw Value(dBuV) + Correction Factor(dB/m)
 2. Correction Factor(dB/m) = Antenna Factor (dB/m) + Cable Factor (dB)
 3. The other emission levels were very low against the limit.
 4. Margin value = Emission level – Limit value



802.11a OFDM modulation

EUT	EDA (Enterprise Digital Assistant)	MEASUREMENT DETAIL	
MODEL	MC7090	FREQUENCY RANGE	1 ~ 40 GHz
CHANNEL	Channel 1	DETECTOR FUNCTION	Peak(PK) Average (AV)
MODULATION TYPE	BPSK	ENVIRONMENTAL CONDITIONS	25deg. C, 68%RH, 991hPa
TRANSFER RATE	6Mbps	INPUT POWER (SYSTEM)	120Vac, 60 Hz
TESTED BY	Match Tsui		

ANTENNA POLARITY & TEST DISTANCE: HORIZONTAL AT 3 M

No.	Freq. (MHz)	Emission Level (dBuV/m)	Limit (dBuV/m)	Margin (dB)	Antenna Height (m)	Table Angle (Degree)	Raw Value (dBuV)	Correction Factor (dB/m)
1	5725.00	79.75 PK	90.60	-10.85	1.03 H	185	39.70	40.05
1	5725.00	65.65 AV	81.37	-15.72	1.03 H	185	25.60	40.05
2	5745.00	110.60 PK			1.03 H	185	70.52	40.08
2	5745.00	101.37 AV			1.03 H	185	61.29	40.08
3	#11490.00	58.12 PK	74.00	-15.88	1.04 H	323	7.94	50.18
3	#11490.00	45.68 AV	54.00	-8.32	1.04 H	323	-4.50	50.18

ANTENNA POLARITY & TEST DISTANCE: VERTICAL AT 3 M

No.	Freq. (MHz)	Emission Level (dBuV/m)	Limit (dBuV/m)	Margin (dB)	Antenna Height (m)	Table Angle (Degree)	Raw Value (dBuV)	Correction Factor (dB/m)
1	5725.00	75.14 PK	85.52	-10.38	1.02 V	360	35.09	40.05
1	5725.00	61.87 AV	76.16	-14.29	1.02 V	360	21.83	40.05
2	*5745.00	105.52 PK			1.02 V	360	65.44	40.08
2	*5745.00	96.16 AV			1.02 V	360	56.08	40.08

- NOTE:**
1. Emission level(dBuV/m)=Raw Value(dBuV) + Correction Factor(dB/m)
 2. Correction Factor(dB/m) = Antenna Factor (dB/m) + Cable Factor (dB)
 3. The other emission levels were very low against the limit.
 4. Margin value = Emission level – Limit value
 5. "*" : Fundamental frequency
 6. "#"The radiated frequency falling in the restricted band.
 7. The limit value is defined as per 15.247



EUT	EDA (Enterprise Digital Assistant)	MEASUREMENT DETAIL	
MODEL	MC7090	FREQUENCY RANGE	1 ~ 40 GHz
CHANNEL	Channel 3	DETECTOR FUNCTION	Peak(PK) Average (AV)
MODULATION TYPE	BPSK	ENVIRONMENTAL CONDITIONS	25deg. C, 68%RH, 991hPa
TRANSFER RATE	6Mbps	INPUT POWER (SYSTEM)	120Vac, 60 Hz
TESTED BY	Match Tsui		

ANTENNA POLARITY & TEST DISTANCE: HORIZONTAL AT 3 M

No.	Freq. (MHz)	Emission Level (dBuV/m)	Limit (dBuV/m)	Margin (dB)	Antenna Height (m)	Table Angle (Degree)	Raw Value (dBuV)	Correction Factor (dB/m)
1	*5785.00	110.26 PK			1.15 H	171	70.11	40.15
1	*5785.00	100.74 AV			1.15 H	171	60.59	40.15
2	11570.00	58.18 PK	74.00	-15.82	1.07 H	1	8.06	50.12
2	11570.00	46.02 AV	54.00	-7.98	1.07 H	1	-4.10	50.12

ANTENNA POLARITY & TEST DISTANCE: VERTICAL AT 3 M

No.	Freq. (MHz)	Emission Level (dBuV/m)	Limit (dBuV/m)	Margin (dB)	Antenna Height (m)	Table Angle (Degree)	Raw Value (dBuV)	Correction Factor (dB/m)
1	*5785.00	110.02 PK			1.07 V	149	69.87	40.15
1	*5785.00	100.62 AV			1.07 V	149	60.47	40.15
2	11570.00	58.47 PK	74.00	-15.53	1.08 V	230	8.35	50.12
2	11570.00	45.98 AV	54.00	-8.02	1.08 V	230	-4.14	50.12

- NOTE:**
1. Emission level(dBuV/m)=Raw Value(dBuV) + Correction Factor(dB/m)
 2. Correction Factor(dB/m) = Antenna Factor (dB/m) + Cable Factor (dB)
 3. The other emission levels were very low against the limit.
 4. Margin value = Emission level – Limit value
 5. "*" : Fundamental frequency
 6. "#"The radiated frequency falling in the restricted band.
 7. The limit value is defined as per 15.247



EUT	EDA (Enterprise Digital Assistant)	MEASUREMENT DETAIL	
MODEL	MC7090	FREQUENCY RANGE	1 ~ 40 GHz
CHANNEL	Channel 5	DETECTOR FUNCTION	Peak(PK) Average (AV)
MODULATION TYPE	BPSK	ENVIRONMENTAL CONDITIONS	25deg. C, 68%RH, 991hPa
TRANSFER RATE	6Mbps	INPUT POWER (SYSTEM)	120Vac, 60 Hz
TESTED BY	Match Tsui		

ANTENNA POLARITY & TEST DISTANCE: HORIZONTAL AT 3 M

No.	Freq. (MHz)	Emission Level (dBuV/m)	Limit (dBuV/m)	Margin (dB)	Antenna Height (m)	Table Angle (Degree)	Raw Value (dBuV)	Correction Factor (dB/m)
1	*5825.00	110.39 PK			1.39 H	175	70.17	40.22
1	*5825.00	101.07 AV			1.39 H	175	60.85	40.22
2	5850.00	68.16 PK	90.39	-22.23	1.39 H	175	27.90	40.26
2	5850.00	57.46 AV	81.07	-23.61	1.39 H	175	17.20	40.26
3	11650.00	58.31 PK	74.00	-15.69	1.00 H	360	8.12	50.19
3	11650.00	46.07 AV	54.00	-7.93	1.00 H	360	-4.12	50.19

ANTENNA POLARITY & TEST DISTANCE: VERTICAL AT 3 M

No.	Freq. (MHz)	Emission Level (dBuV/m)	Limit (dBuV/m)	Margin (dB)	Antenna Height (m)	Table Angle (Degree)	Raw Value (dBuV)	Correction Factor (dB/m)
1	*5825.00	107.80 PK			1.06 V	158	67.58	40.22
1	*5825.00	98.69 AV			1.06 V	158	58.47	40.22
2	5850.00	67.06 PK	87.80	-20.74	1.06 V	158	26.80	40.26
2	5850.00	57.40 AV	78.69	-21.29	1.06 V	158	17.14	40.26
3	11650.00	58.61 PK	74.00	-15.39	1.00 V	360	8.42	50.19
3	11650.00	45.89 AV	54.00	-8.11	1.00 V	360	-4.30	50.19

- NOTE:**
1. Emission level(dBuV/m)=Raw Value(dBuV) + Correction Factor(dB/m)
 2. Correction Factor(dB/m) = Antenna Factor (dB/m) + Cable Factor (dB)
 3. The other emission levels were very low against the limit.
 4. Margin value = Emission level – Limit value
 5. "*" : Fundamental frequency
 6. "#"The radiated frequency falling in the restricted band.
 7. The limit value is defined as per 15.247



5.3 6dB BANDWIDTH MEASUREMENT

5.3.1 LIMITS OF 6dB BANDWIDTH MEASUREMENT

The minimum of 6dB Bandwidth Measurement is 0.5 MHz.

5.3.2 TEST INSTRUMENTS

Description & Manufacturer	Model No.	Serial No.	Calibrated Until
R&S SPECTRUM ANALYZER	FSEK30	100049	Aug. 14, 2006

NOTES: The calibration interval of the above test instruments is 12 months and the calibrations are traceable to NML/ROC and NIST/USA.

5.3.3 TEST PROCEDURE

The transmitter output was connected to the spectrum analyzer through an attenuator. The bandwidth of the fundamental frequency was measured by spectrum analyzer with 100kHz RBW and 100kHz VBW. The 6dB bandwidth is defined as the total spectrum the power of which is higher than peak power minus 6dB.

5.3.4 DEVIATION FROM TEST STANDARD

No deviation

5.3.5 TEST SETUP

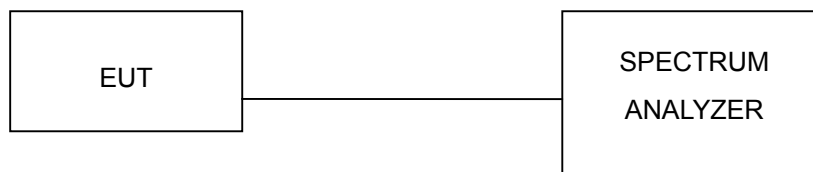

5.3.6 EUT OPERATING CONDITIONS

The software provided by client to enable the EUT under transmission condition continuously at lowest, middle and highest channel frequencies individually.



5.3.7 TEST RESULTS

802.11a OFDM modulation

EUT	EDA (Enterprise Digital Assistant)	MODEL	MC7090
MODULATION TYPE	BPSK	TRANSFER RATE	6Mbps
INPUT POWER (SYSTEM)	120Vac, 60 Hz	ENVIRONMENTAL CONDITIONS	27deg.C, 63%RH, 991hPa
TESTED BY	Gary Chang		

CHANNEL	CHANNEL FREQUENCY (MHz)	6dB BANDWIDTH (MHz)	MINIMUM LIMIT (MHz)	PASS/FAIL
1	5745	15.72	0.5	PASS
3	5785	15.60	0.5	PASS
5	5825	15.72	0.5	PASS



CH 1

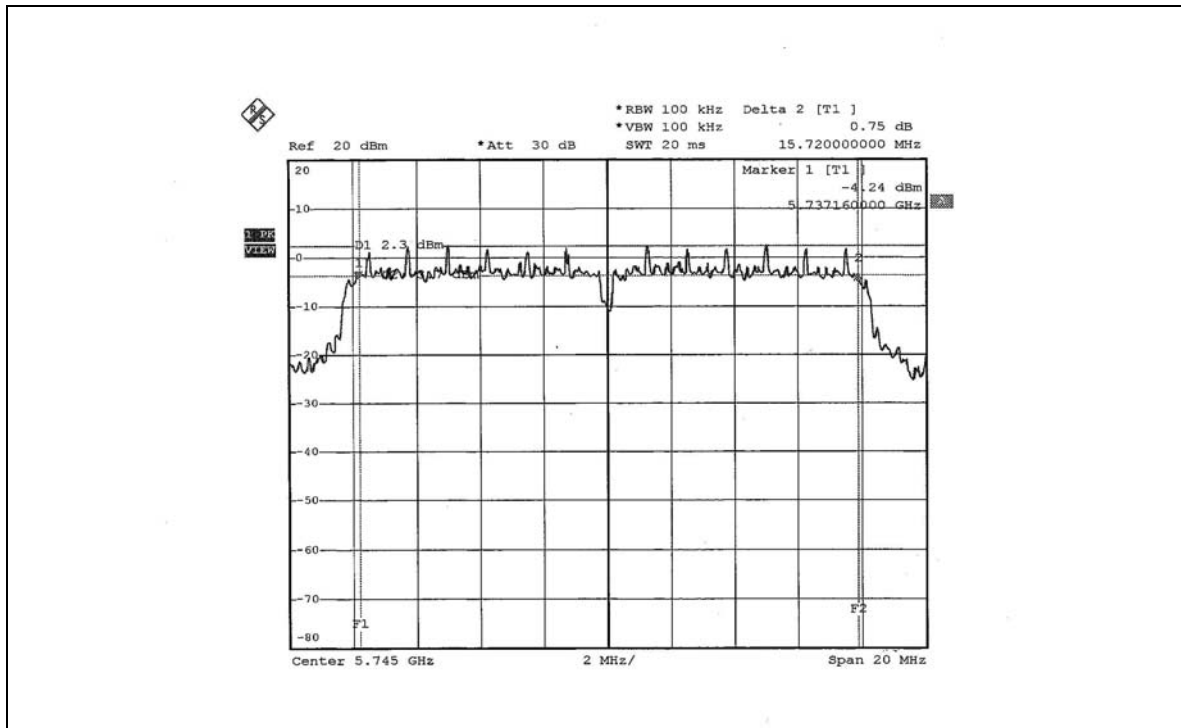

CH 3

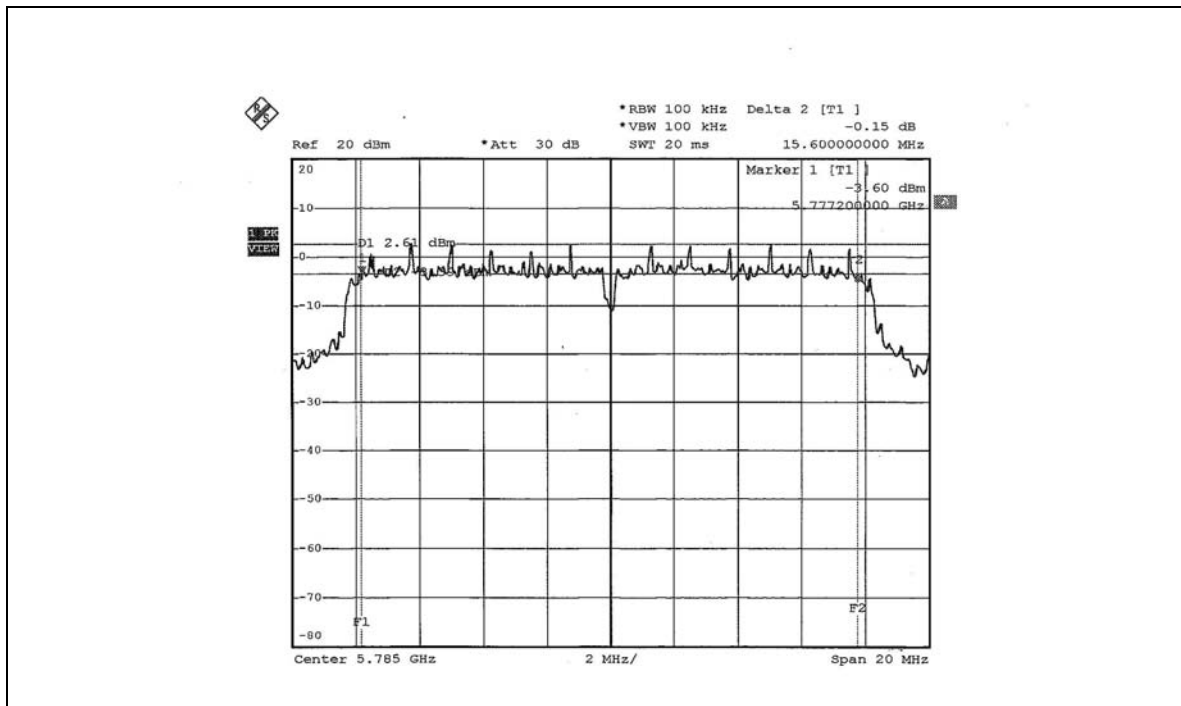



CH 5

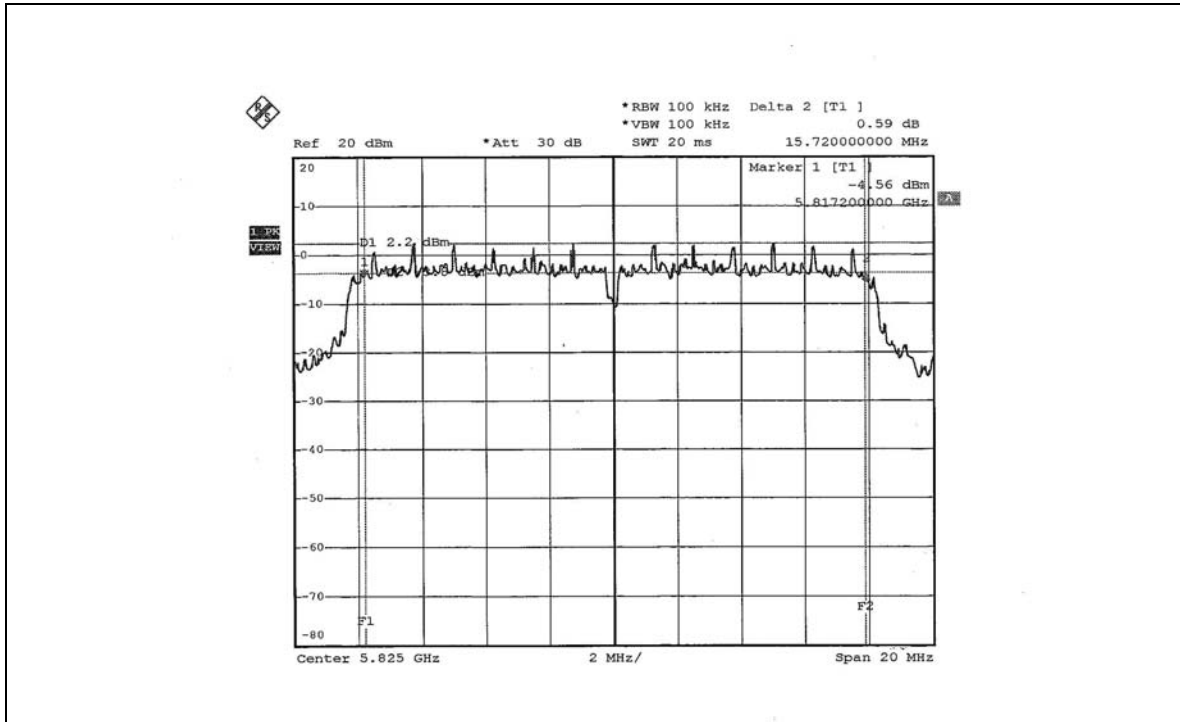



5.4 MAXIMUM PEAK OUTPUT POWER

5.4.1 LIMITS OF MAXIMUM PEAK OUTPUT POWER MEASUREMENT

The Maximum Peak Output Power Measurement is 30dBm.

5.4.2 INSTRUMENTS

Description & Manufacturer	Model No.	Serial No.	Calibrated Until
R&S SPECTRUM ANALYZER	FSEK30	100049	Aug. 14, 2006
AGILENT SIGNAL GENERATOR	E8257C	MY43320668	Dec. 31, 2005
TEKTRONIX OSCILLOSCOPE	TDS 1012	C019167	Feb. 01, 2006
NARDA DETECTOR	4503A	FSCM99899	NA

NOTE:

The calibration interval of the above test instruments is 12 months and the calibrations are traceable to NML/ROC and NIST/USA..

5.4.3 TEST PROCEDURES

1. A detector was used on the output port of the EUT. An oscilloscope was used to read the response of the detector.
2. Replaced the EUT by the signal generator . The center frequency of the S.G was adjusted to the center frequency of the measured channel.
3. Adjusted the power to have the same reading on oscilloscope. Record the power level.

5.4.4 DEVIATION FROM TEST STANDARD

No deviation

5.4.5 TEST SETUP



5.4.6 EUT OPERATING CONDITIONS

Same as Item 5.3.6



5.4.7 TEST RESULTS

802.11a OFDM modulation

EUT	EDA (Enterprise Digital Assistant)	MODEL	MC7090
MODULATION TYPE	BPSK	TRANSFER RATE	6Mbps
INPUT POWER (SYSTEM)	120Vac, 60 Hz	ENVIRONMENTAL CONDITIONS	27deg.C, 63%RH, 991hPa
TESTED BY	Gary Chang		

CHANNEL	CHANNEL FREQUENCY (MHz)	PEAK POWER OUTPUT (mW)	PEAK POWER OUTPUT (dBm)	PEAK POWER LIMIT (dBm)	PASS/FAIL
1	5745	40.365	16.06	30	PASS
3	5785	40.087	16.03	30	PASS
5	5825	40.551	16.08	30	PASS



5.5 POWER SPECTRAL DENSITY MEASUREMENT

5.5.1 LIMITS OF POWER SPECTRAL DENSITY MEASUREMENT

The Maximum of Power Spectral Density Measurement is 8dBm.

5.5.2 TEST INSTRUMENTS

Description & Manufacturer	Model No.	Serial No.	Calibrated Until
R&S SPECTRUM ANALYZER	FSEK30	100049	Aug. 14, 2006

NOTES:

The calibration interval of the above test instruments is 12 months and the calibrations are traceable to NML/ROC and NIST/USA.

5.5.3 TEST PROCEDURE

The transmitter output was connected to the spectrum analyzer through an attenuator, the bandwidth of the fundamental frequency was measured with the spectrum analyzer using 3 kHz RBW and 30 kHz VBW, set sweep time = span/3 kHz. The power spectral density was measured and recorded.

The sweep time is allowed to be longer than span/3 kHz for a full response of the mixer in the spectrum analyzer.

5.5.4 DEVIATION FROM TEST STANDARD

No deviation

5.5.5 TEST SETUP

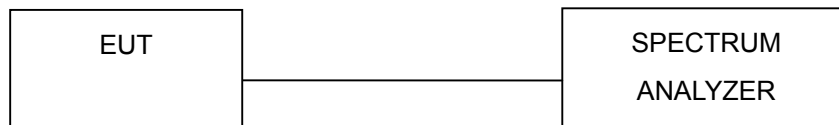

5.5.6 EUT OPERATING CONDITION

Same as Item 5.3.6



5.5.7 TEST RESULTS

802.11a OFDM modulation

EUT	EDA (Enterprise Digital Assistant)	MODEL	MC7090
MODULATION TYPE	BPSK	TRANSFER RATE	6Mbps
INPUT POWER (SYSTEM)	120Vac, 60 Hz	ENVIRONMENTAL CONDITIONS	27deg.C, 63%RH, 991hPa
TESTED BY	Gary Chang		

CHANNEL	CHANNEL FREQUENCY (MHz)	RF POWER LEVEL IN 3 kHz BW (dBm)	MAXIMUM LIMIT (dBm)	PASS/FAIL
1	5745	-14.62	8	PASS
3	5785	-14.33	8	PASS
5	5825	-14.49	8	PASS



CH 1

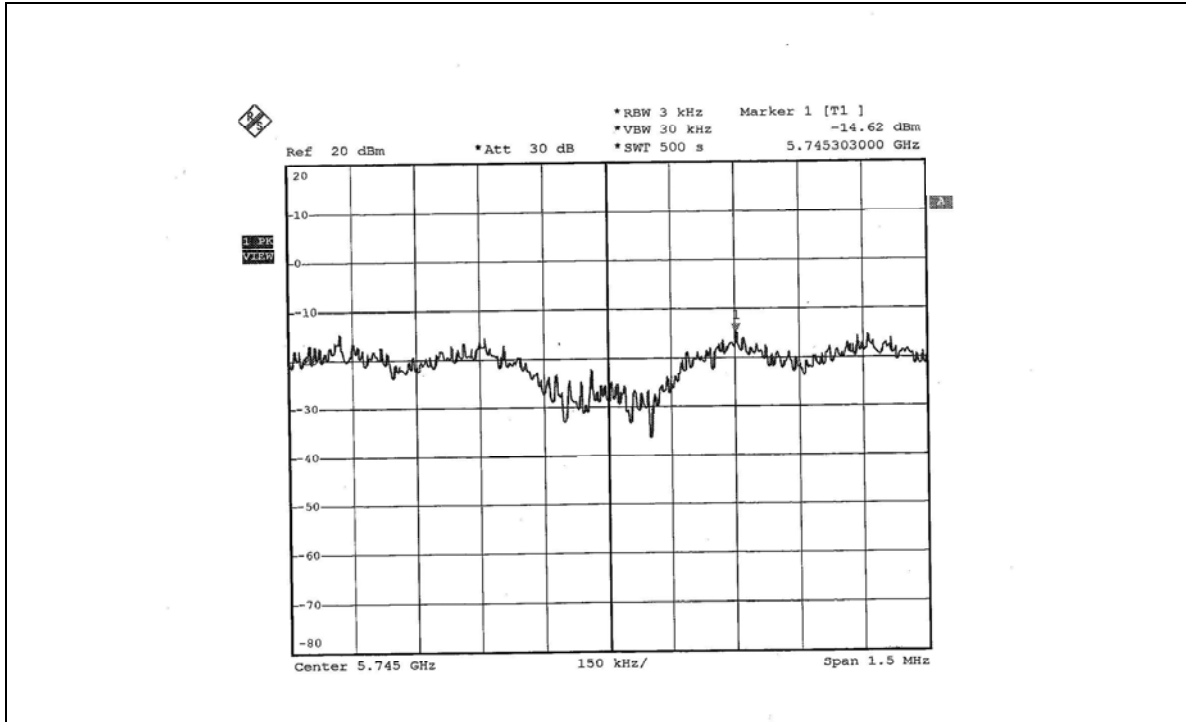

CH 3

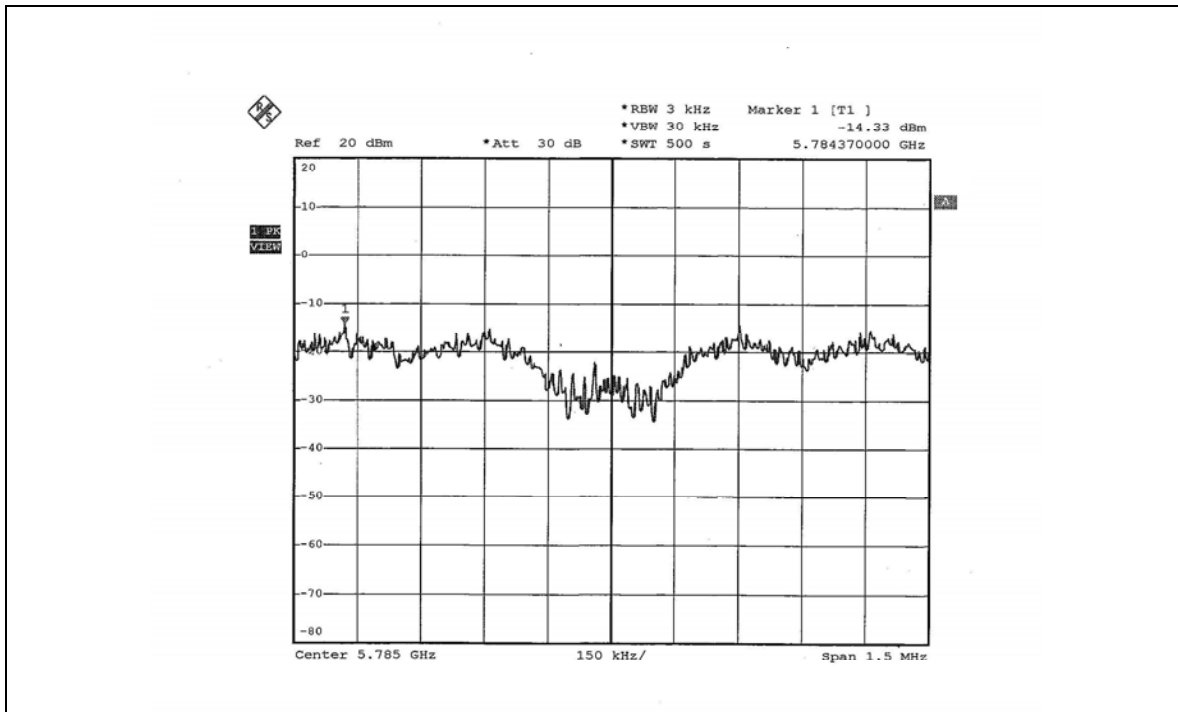



CH 5

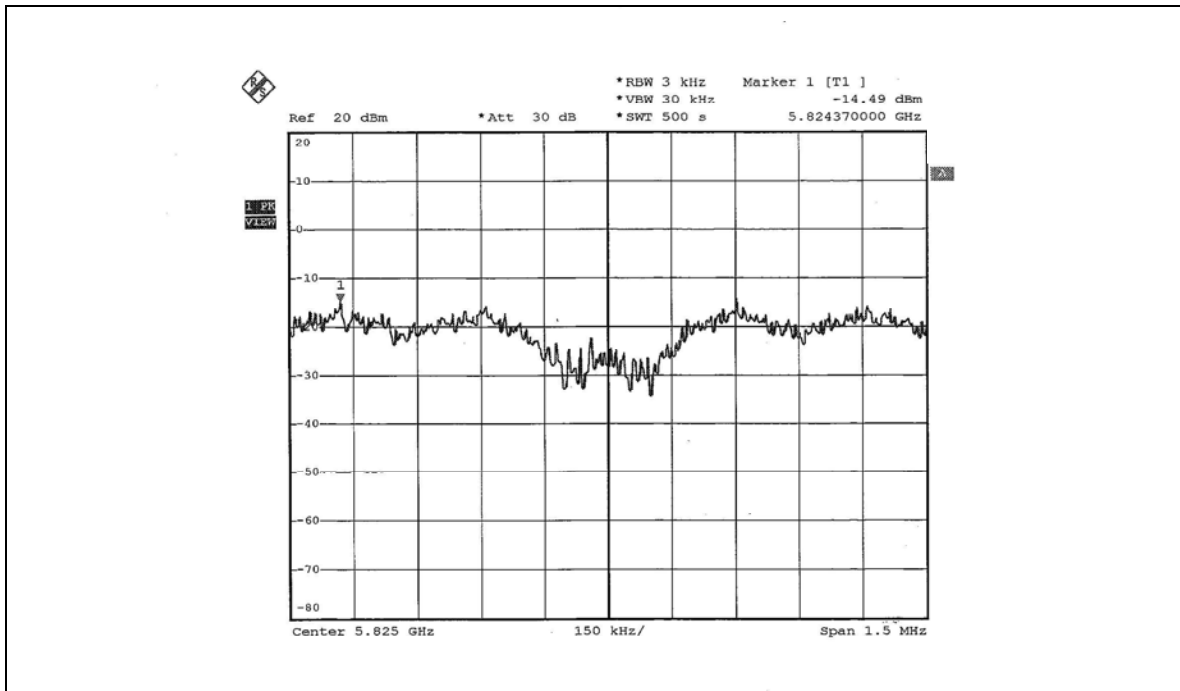



5.6 BAND EDGES MEASUREMENT

5.6.1 LIMITS OF BAND EDGES MEASUREMENT

Below -20dB of the highest emission level of operating band (in 100kHz Resolution Bandwidth).

5.6.2 TEST INSTRUMENTS

Description & Manufacturer	Model No.	Serial No.	Calibrated Until
R&S SPECTRUM ANALYZER	FSEK30	100049	Aug. 14, 2006

NOTES:

The calibration interval of the above test instruments is 12 months and the calibrations are traceable to NML/ROC and NIST/USA.

5.6.3 TEST PROCEDURE

The transmitter output was connected to the spectrum analyzer via a low loss cable. Set both RBW and VBW of spectrum analyzer to 100 kHz with suitable frequency span including 100 MHz bandwidth from band edge. The band edges were measured and recorded.

5.6.4 DEVIATION FROM TEST STANDARD

No deviation



5.6.5 EUT OPERATING CONDITION

Same as Item 5.9.6

5.6.6 TEST RESULTS

The spectrum plots are attached on the following pages. D1 line indicates the highest level, D2 line indicates the 20dB offset below D1. It shows compliance with the requirement in part 15.247(d).

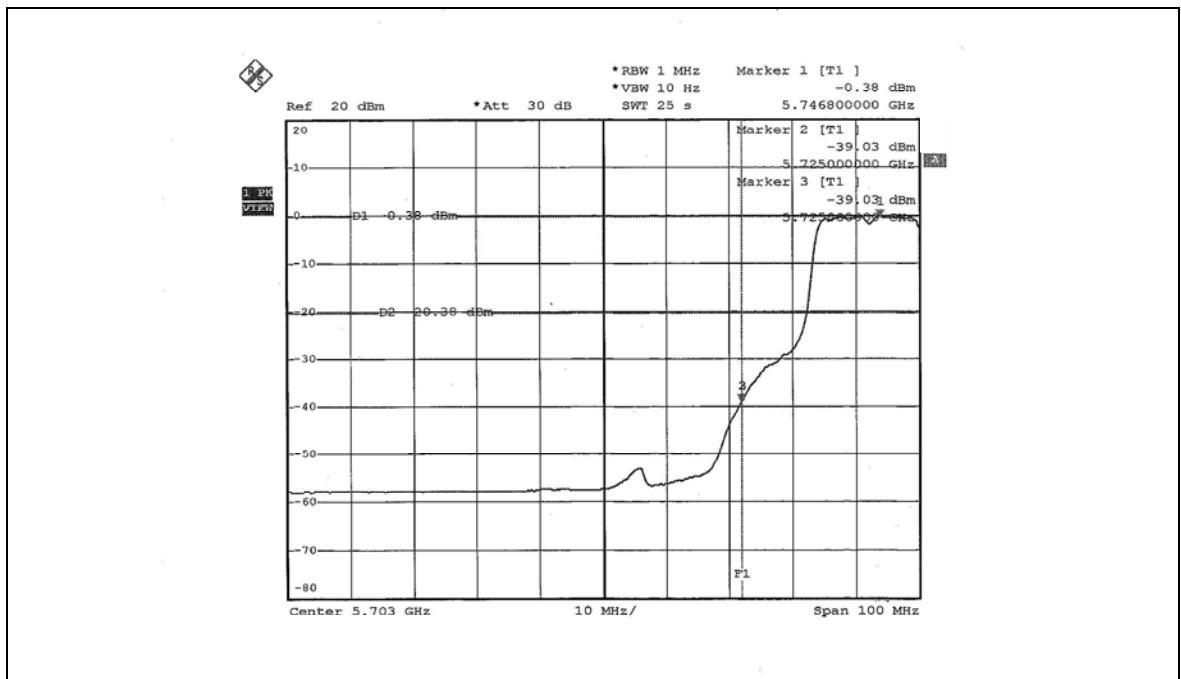
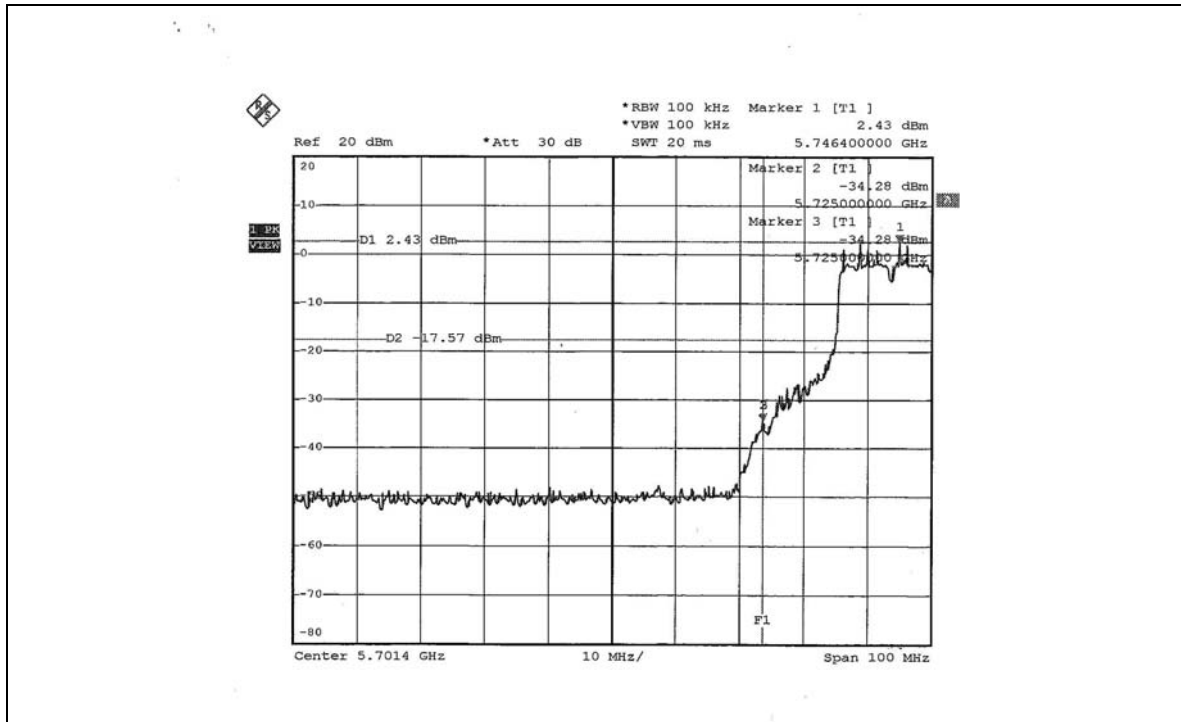

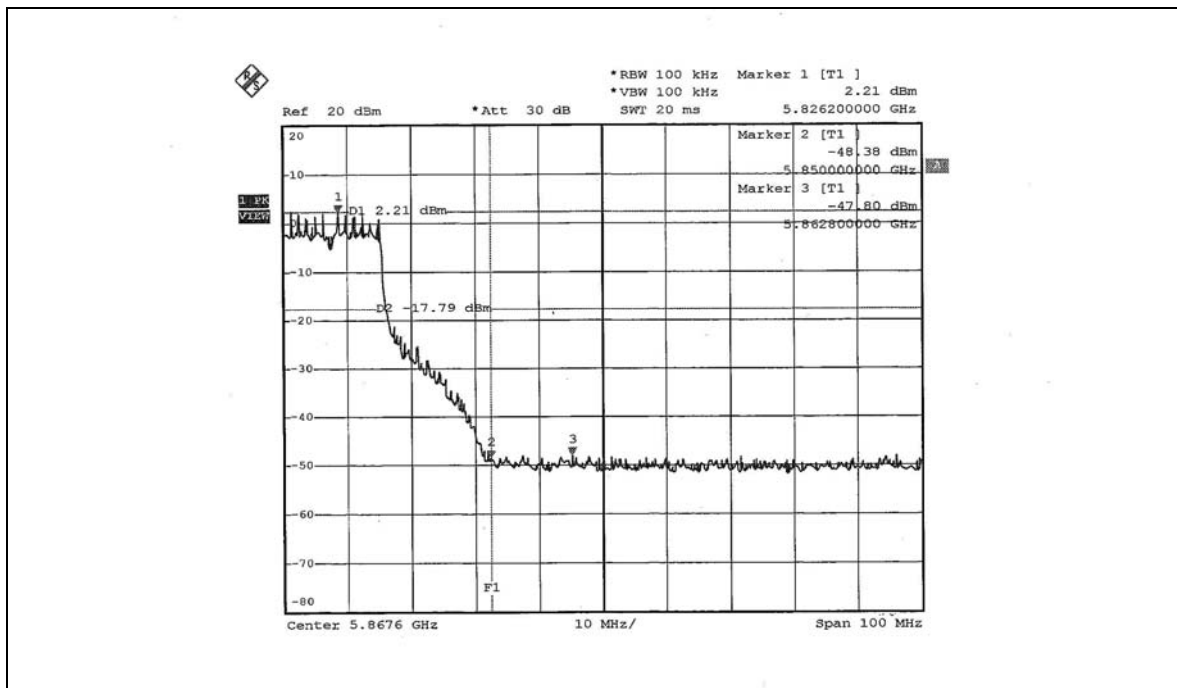
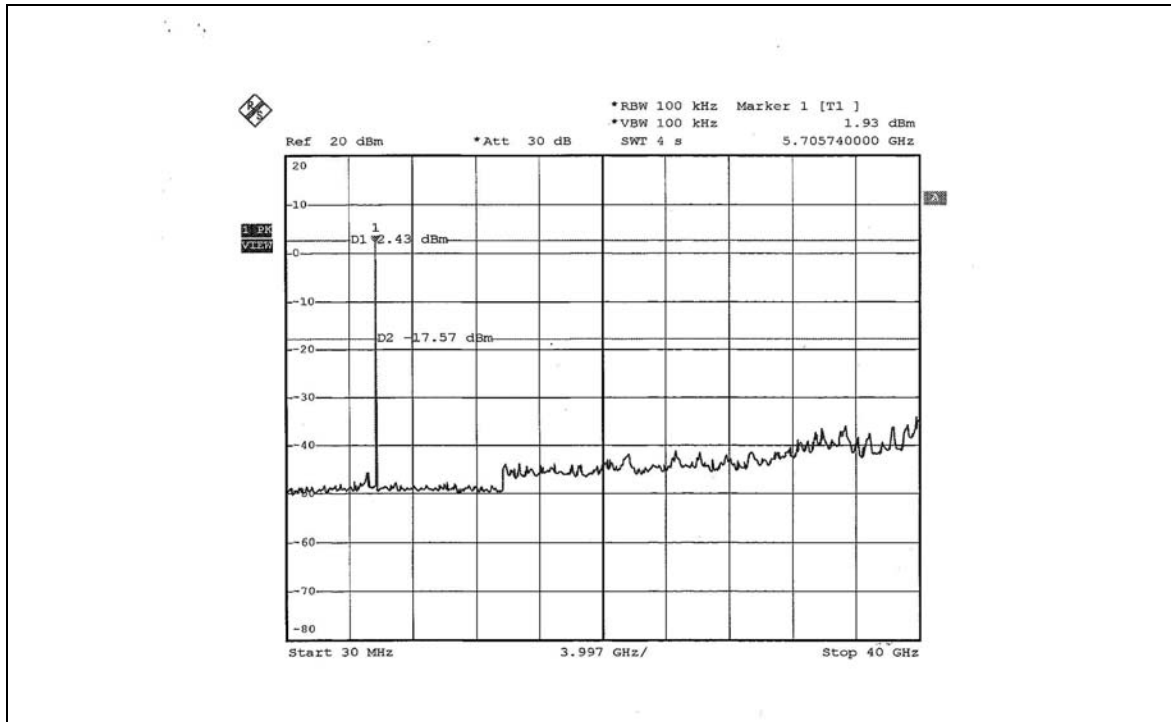

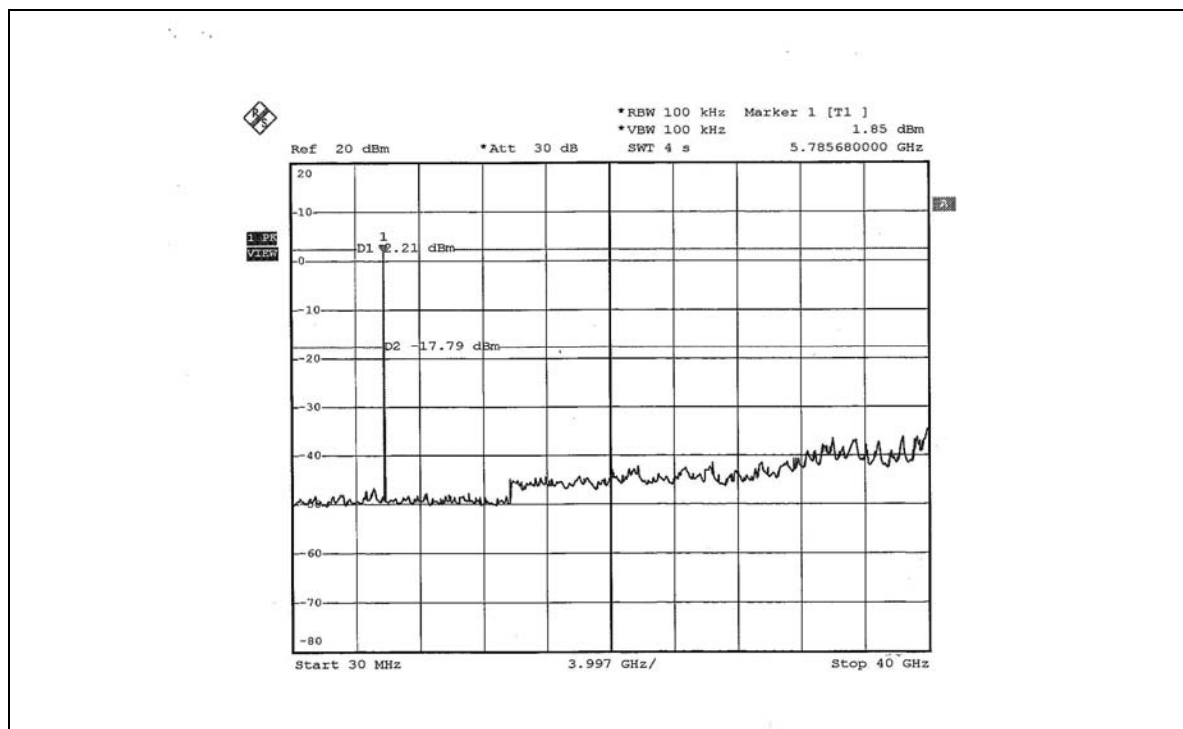
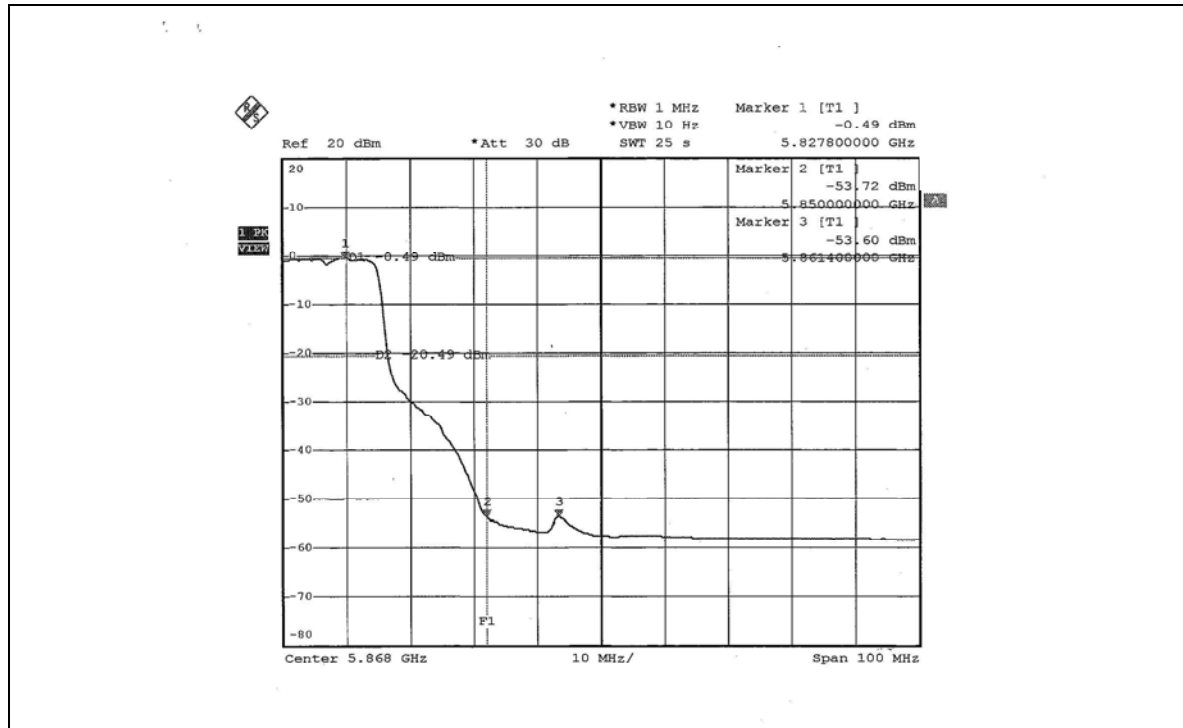



5.7 ANTENNA REQUIREMENT

5.7.1 STANDARD APPLICABLE

For intentional device, according to FCC 47 CFR Section 15.203, an intentional radiator shall be designed to ensure that no antenna other than that furnished by the responsible party shall be used with the device.

And according to FCC 47 CFR Section 15.247(a), if transmitting antennas of directional gain greater than 6dBi are used, the power shall be reduced by the amount in dB that the directional gain of the antenna exceeds 6dBi.

5.7.2 ANTENNA CONNECTED CONSTRUCTION

The antenna used in this product is PIFA antenna with UFL connector. The maximum Gain of the antenna is 2.5dBi.



6. TEST TYPES AND RESULTS (FOR BLUETOOTH)

6.1.1 CONDUCTED EMISSION MEASUREMENT

6.1.2 LIMITS OF CONDUCTED EMISSION MEASUREMENT

FREQUENCY OF EMISSION (MHz)	CONDUCTED LIMIT (dB μ V)	
	Quasi-peak	Average
0.15 ~ 0.5	66 to 56	56 to 46
0.5 ~ 5	56	46
5 ~ 30	60	50

- NOTE:**
1. The lower limit shall apply at the transition frequencies.
 2. The limit decreases in line with the logarithm of the frequency in the range of 0.15 to 0.50 MHz.
 3. All emanations from a class A/B digital device or system, including any network of conductors and apparatus connected thereto, shall not exceed the level of field strengths specified above.

6.1.3 TEST INSTRUMENTS

DESCRIPTION & MANUFACTURER	MODEL NO.	SERIAL NO.	CALIBRATED UNTIL
Test Receiver ROHDE & SCHWARZ	ESCS30	100288	Nov. 06, 2005
RF signal cable Woken	5D-FB	Cable-HyC02-01	Jan. 09, 2006
LISN ROHDE & SCHWARZ	ESH2-Z5	100100	Jan. 20, 2006
LISN ROHDE & SCHWARZ	ESH3-Z5	100311	Jan. 20, 2006
Software ADT	ADT_Cond_V3	NA	NA

- NOTE:**
1. The calibration interval of the above test instruments is 12 months and the calibrations are traceable to NML/ROC and NIST/USA.
 2. The test was performed in HwaYa Shielded Room 3.
 3. The VCCI Site Registration No. is C-2047.



6.1.4 TEST PROCEDURES

- a. The EUT was placed 0.4 meters from the conducting wall of the shielded room with EUT being connected to the power mains through a line impedance stabilization network (LISN). Other support units were connected to the power mains through another LISN. The two LISNs provide 50 ohm/ 50uH of coupling impedance for the measuring instrument.
- b. Both lines of the power mains connected to the EUT were checked for maximum conducted interference.
- c. The frequency range from 150kHz to 30MHz was searched. Emission levels under (Limit - 20dB) was not recorded.

6.1.5 DEVIATION FROM TEST STANDARD

No deviation

6.1.6 TEST SETUP

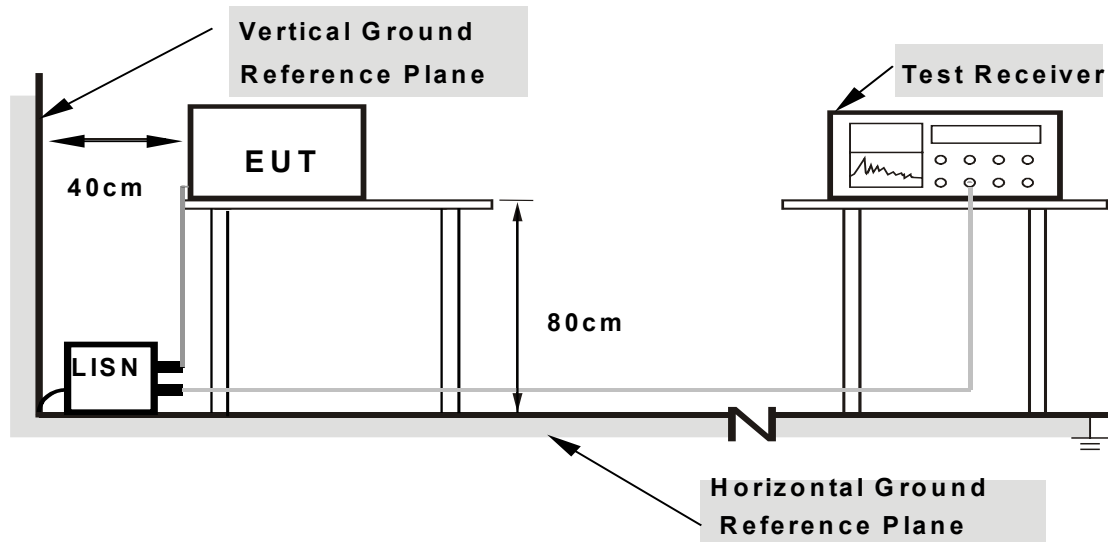

Note: 1. Support units were connected to second LISN.

2. Both of LISNs (AMN) are 80 cm from EUT and at least 80 from other units and other metal planes

For the actual test configuration, please refer to the related item – Photographs of the Test Configuration.

6.1.7 EUT OPERATING CONDITIONS

Same as 4.1.6



6.1.8 TEST RESULTS

Conducted Worst-Case Data (with charging cable)

EUT	EDA (Enterprise Digital Assistant)	MEASUREMENT DETAIL	
MODEL	MC7090	PHASE	Line 1
CHANNEL	Channel 0	6dB BANDWIDTH	9 kHz
MODULATION TYPE	GFSK	ENVIRONMENTAL CONDITIONS	25deg. C, 65%RH, 991hPa
INPUT POWER (SYSTEM)	120Vac, 60 Hz	TEST MODE	A
TESTED BY	Jay Hsu		

No	Freq. [MHz]	Corr. Factor (dB)	Reading Value		Emission Level		Limit		Margin	
			[dB (uV)]		[dB (uV)]		[dB (uV)]		(dB)	
			Q.P.	AV.	Q.P.	AV.	Q.P.	AV.	Q.P.	AV.
1	0.186	0.11	42.19	-	42.30	-	64.22	54.22	-21.93	-
2	0.193	0.11	41.41	-	41.52	-	63.89	53.89	-22.37	-
3	0.322	0.12	30.41	-	30.53	-	59.66	49.66	-29.13	-
4	0.554	0.15	22.23	-	22.38	-	56.00	46.00	-33.62	-
5	0.728	0.18	22.22	-	22.40	-	56.00	46.00	-33.60	-
6	2.922	0.27	33.11	-	33.38	-	56.00	46.00	-22.62	-

- REMARKS:**
1. Q.P. and AV. are abbreviations of quasi-peak and average individually.
 2. "-": The Quasi-peak reading value also meets average limit and measurement with the average detector is unnecessary.
 3. The emission levels of other frequencies were very low against the limit.
 4. Margin value = Emission level - Limit value
 5. Correction factor = Insertion loss + Cable loss
 6. Emission Level = Correction Factor + Reading Value.

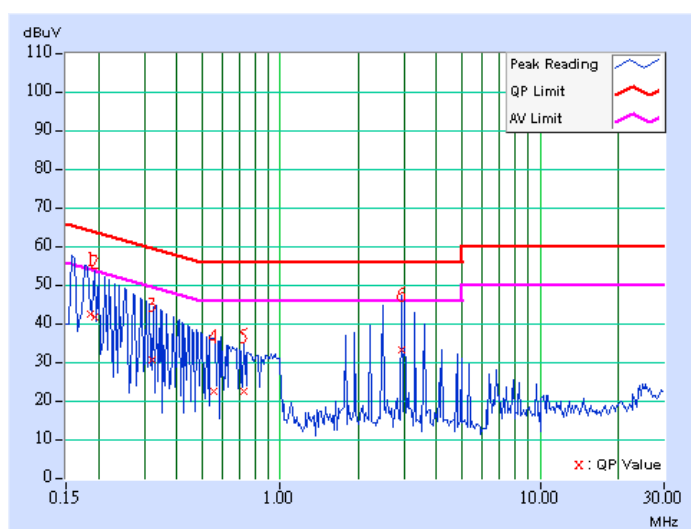



EUT	EDA (Enterprise Digital Assistant)	MEASUREMENT DETAIL	
MODEL	MC7090	PHASE	Line 2
CHANNEL	Channel 0	6dB BANDWIDTH	9 kHz
MODULATION TYPE	GFSK	ENVIRONMENTAL CONDITIONS	25deg. C, 65%RH, 991hPa
INPUT POWER (SYSTEM)	120Vac, 60 Hz	TEST MODE	A
TESTED BY	Jay Hsu		

No	Freq. [MHz]	Corr. Factor (dB)	Reading Value		Emission Level		Limit		Margin	
			[dB (uV)]		[dB (uV)]		[dB (uV)]		(dB)	
			Q.P.	AV.	Q.P.	AV.	Q.P.	AV.	Q.P.	AV.
1	0.181	0.11	42.32	-	42.43	-	64.44	54.44	-22.02	-
2	0.245	0.11	36.67	-	36.78	-	61.93	51.93	-25.15	-
3	0.314	0.12	30.93	-	31.05	-	59.86	49.86	-28.82	-
4	0.553	0.15	21.93	-	22.08	-	56.00	46.00	-33.92	-
5	0.998	0.23	18.43	-	18.66	-	56.00	46.00	-37.34	-
6	2.892	0.27	33.44	-	33.71	-	56.00	46.00	-22.29	-

- REMARKS:**
1. Q.P. and AV. are abbreviations of quasi-peak and average individually.
 2. "-": The Quasi-peak reading value also meets average limit and measurement with the average detector is unnecessary.
 3. The emission levels of other frequencies were very low against the limit.
 4. Margin value = Emission level - Limit value
 5. Correction factor = Insertion loss + Cable loss
 6. Emission Level = Correction Factor + Reading Value.

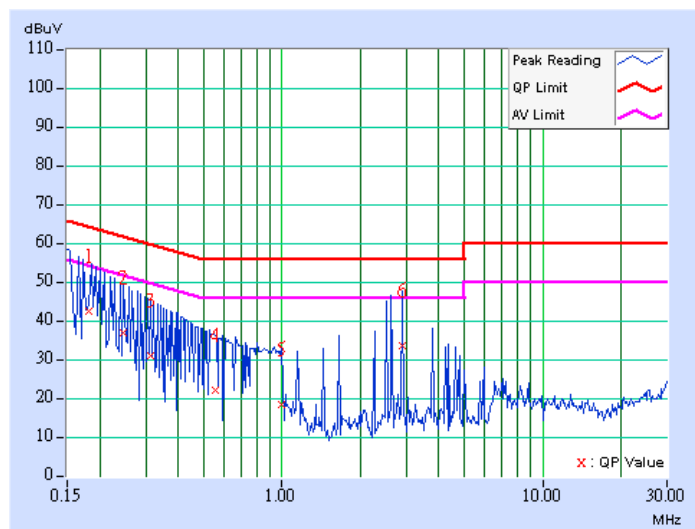



EUT	EDA (Enterprise Digital Assistant)	MEASUREMENT DETAIL	
MODEL	MC7090	PHASE	Line 1
CHANNEL	Channel 39	6dB BANDWIDTH	9 kHz
MODULATION TYPE	GFSK	ENVIRONMENTAL CONDITIONS	25deg. C, 65%RH, 991hPa
INPUT POWER (SYSTEM)	120Vac, 60 Hz	TEST MODE	A
TESTED BY	Jay Hsu		

No	Freq. [MHz]	Corr. Factor (dB)	Reading Value		Emission Level		Limit		Margin	
			[dB (uV)]		[dB (uV)]		[dB (uV)]		(dB)	
			Q.P.	AV.	Q.P.	AV.	Q.P.	AV.	Q.P.	AV.
1	0.182	0.11	42.59	-	42.70	-	64.41	54.41	-21.71	-
2	0.246	0.11	35.56	-	35.67	-	61.89	51.89	-26.22	-
3	0.315	0.12	30.53	-	30.65	-	59.83	49.83	-29.18	-
4	0.490	0.14	23.09	-	23.23	-	56.17	46.17	-32.94	-
5	0.865	0.21	20.84	-	21.05	-	56.00	46.00	-34.95	-
6	2.516	0.26	30.93	-	31.19	-	56.00	46.00	-24.81	-

- REMARKS:**
1. Q.P. and AV. are abbreviations of quasi-peak and average individually.
 2. "-": The Quasi-peak reading value also meets average limit and measurement with the average detector is unnecessary.
 3. The emission levels of other frequencies were very low against the limit.
 4. Margin value = Emission level - Limit value
 5. Correction factor = Insertion loss + Cable loss
 6. Emission Level = Correction Factor + Reading Value.

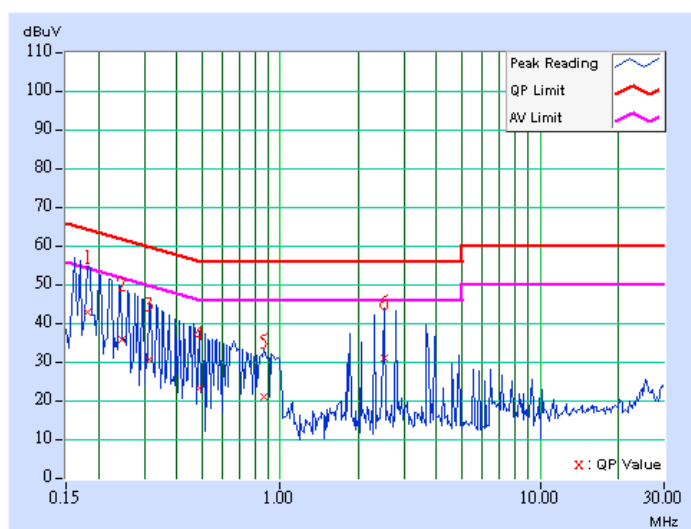



EUT	EDA (Enterprise Digital Assistant)	MEASUREMENT DETAIL	
MODEL	MC7090	PHASE	Line 2
CHANNEL	Channel 39	6dB BANDWIDTH	9 kHz
MODULATION TYPE	GFSK	ENVIRONMENTAL CONDITIONS	25deg. C, 65%RH, 991hPa
INPUT POWER (SYSTEM)	120Vac, 60 Hz	TEST MODE	A
TESTED BY	Jay Hsu		

No	Freq. [MHz]	Corr. Factor (dB)	Reading Value		Emission Level		Limit		Margin	
			[dB (uV)]		[dB (uV)]		[dB (uV)]		(dB)	
			Q.P.	AV.	Q.P.	AV.	Q.P.	AV.	Q.P.	AV.
1	0.182	0.11	42.59	-	42.70	-	64.41	54.41	-21.72	-
2	0.248	0.11	35.48	-	35.59	-	61.82	51.82	-26.23	-
3	0.369	0.12	28.13	-	28.25	-	58.53	48.53	-30.28	-
4	0.601	0.16	21.12	-	21.28	-	56.00	46.00	-34.72	-
5	0.994	0.23	19.66	-	19.89	-	56.00	46.00	-36.11	-
6	2.723	0.26	33.41	-	33.67	-	56.00	46.00	-22.33	-

- REMARKS:**
1. Q.P. and AV. are abbreviations of quasi-peak and average individually.
 2. "-": The Quasi-peak reading value also meets average limit and measurement with the average detector is unnecessary.
 3. The emission levels of other frequencies were very low against the limit.
 4. Margin value = Emission level - Limit value
 5. Correction factor = Insertion loss + Cable loss
 6. Emission Level = Correction Factor + Reading Value.

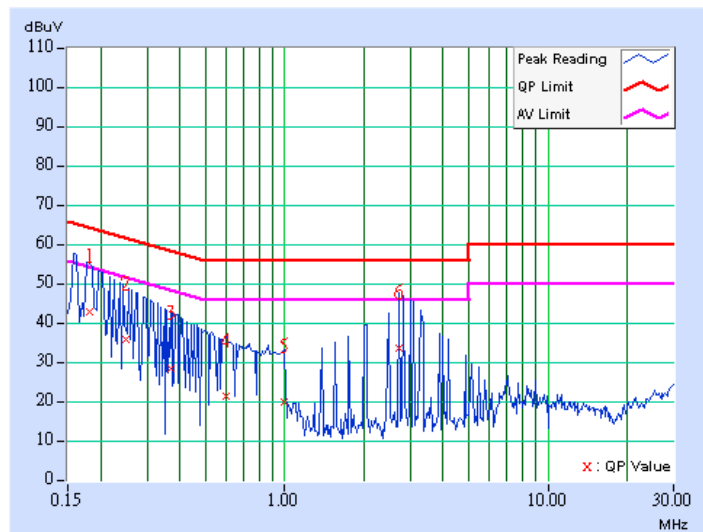



EUT	EDA (Enterprise Digital Assistant)	MEASUREMENT DETAIL	
MODEL	MC7090	PHASE	Line 1
CHANNEL	Channel 78	6dB BANDWIDTH	9 kHz
MODULATION TYPE	GFSK	ENVIRONMENTAL CONDITIONS	25deg. C, 65%RH, 991hPa
INPUT POWER (SYSTEM)	120Vac, 60 Hz	TEST MODE	A
TESTED BY	Jay Hsu		

No	Freq. [MHz]	Corr. Factor (dB)	Reading Value		Emission Level		Limit		Margin	
			[dB (uV)]		[dB (uV)]		[dB (uV)]		(dB)	
			Q.P.	AV.	Q.P.	AV.	Q.P.	AV.	Q.P.	AV.
1	0.183	0.11	42.56	-	42.67	-	64.36	54.36	-21.70	-
2	0.247	0.11	36.05	-	36.16	-	61.87	51.87	-25.70	-
3	0.366	0.12	27.67	-	27.79	-	58.59	48.59	-30.80	-
4	0.463	0.13	24.53	-	24.66	-	56.65	46.65	-31.99	-
5	0.726	0.18	22.04	-	22.22	-	56.00	46.00	-33.78	-
6	2.453	0.26	30.07	-	30.33	-	56.00	46.00	-25.67	-

- REMARKS:**
1. Q.P. and AV. are abbreviations of quasi-peak and average individually.
 2. "-": The Quasi-peak reading value also meets average limit and measurement with the average detector is unnecessary.
 3. The emission levels of other frequencies were very low against the limit.
 4. Margin value = Emission level - Limit value
 5. Correction factor = Insertion loss + Cable loss
 6. Emission Level = Correction Factor + Reading Value.

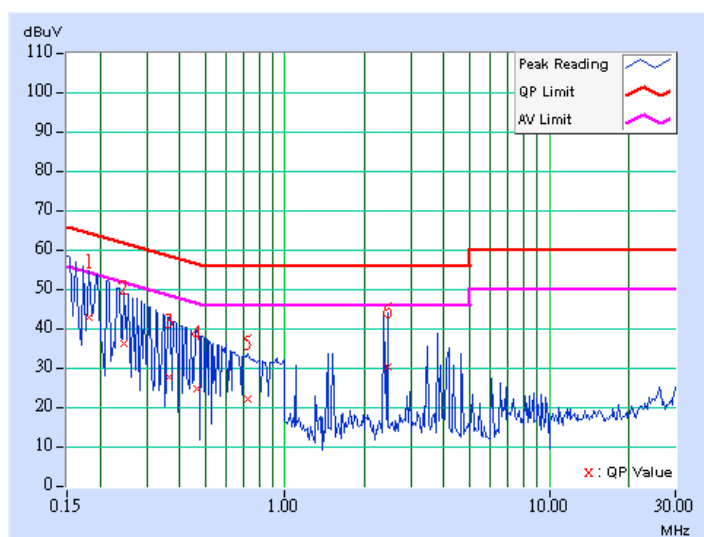



EUT	EDA (Enterprise Digital Assistant)	MEASUREMENT DETAIL	
MODEL	MC7090	PHASE	Line 2
CHANNEL	Channel 78	6dB BANDWIDTH	9 kHz
MODULATION TYPE	GFSK	ENVIRONMENTAL CONDITIONS	25deg. C, 65%RH, 991hPa
INPUT POWER (SYSTEM)	120Vac, 60 Hz	TEST MODE	A
TESTED BY	Jay Hsu		

No	Freq. [MHz]	Corr. Factor (dB)	Reading Value		Emission Level		Limit		Margin	
			[dB (uV)]		[dB (uV)]		[dB (uV)]		(dB)	
			Q.P.	AV.	Q.P.	AV.	Q.P.	AV.	Q.P.	AV.
1	0.179	0.11	41.25	-	41.36	-	64.51	54.51	-23.15	-
2	0.248	0.11	35.36	-	35.47	-	61.83	51.83	-26.36	-
3	0.430	0.13	25.63	-	25.76	-	57.24	47.24	-31.49	-
4	0.670	0.17	21.46	-	21.63	-	56.00	46.00	-34.37	-
5	1.275	0.24	18.71	-	18.95	-	56.00	46.00	-37.05	-
6	2.790	0.27	33.68	-	33.95	-	56.00	46.00	-22.05	-

- REMARKS:**
1. Q.P. and AV. are abbreviations of quasi-peak and average individually.
 2. "-": The Quasi-peak reading value also meets average limit and measurement with the average detector is unnecessary.
 3. The emission levels of other frequencies were very low against the limit.
 4. Margin value = Emission level - Limit value
 5. Correction factor = Insertion loss + Cable loss
 6. Emission Level = Correction Factor + Reading Value.

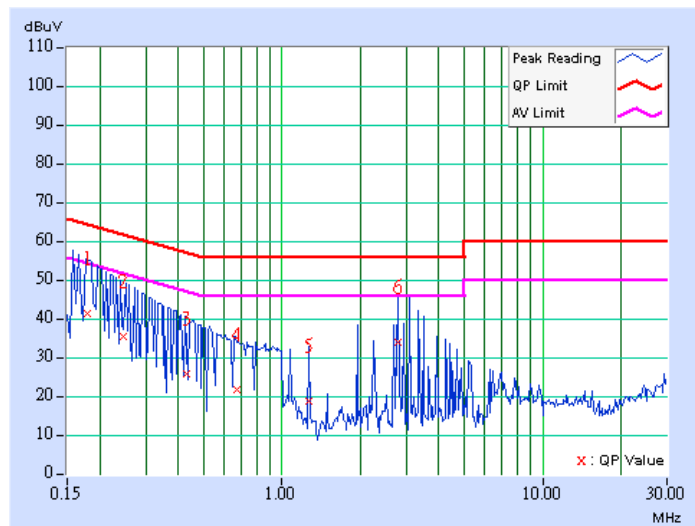



Conducted Worst-Case Data (with cradle)

EUT	EDA (Enterprise Digital Assistant)	MEASUREMENT DETAIL	
MODEL	MC7090	PHASE	Line 1
CHANNEL	Channel 0	6dB BANDWIDTH	9 kHz
MODULATION TYPE	GFSK	ENVIRONMENTAL CONDITIONS	25deg. C, 65%RH, 991hPa
INPUT POWER (SYSTEM)	120Vac, 60 Hz	TEST MODE	B
TESTED BY	Jay Hsu		

No	Freq. [MHz]	Corr. Factor (dB)	Reading Value		Emission Level		Limit		Margin	
			[dB (uV)]		[dB (uV)]		[dB (uV)]		(dB)	
			Q.P.	AV.	Q.P.	AV.	Q.P.	AV.	Q.P.	AV.
1	0.201	0.11	48.71	-	48.82	-	63.58	53.58	-14.76	-
2	0.298	0.11	40.09	-	40.20	-	60.29	50.29	-20.09	-
3	0.599	0.15	36.92	-	37.07	-	56.00	46.00	-18.93	-
4	1.496	0.25	32.29	-	32.54	-	56.00	46.00	-23.46	-
5	4.188	0.39	35.30	-	35.69	-	56.00	46.00	-20.31	-
6	26.453	1.53	28.19	-	29.72	-	60.00	50.00	-30.28	-

- REMARKS:**
1. Q.P. and AV. are abbreviations of quasi-peak and average individually.
 2. "-": The Quasi-peak reading value also meets average limit and measurement with the average detector is unnecessary.
 3. The emission levels of other frequencies were very low against the limit.
 4. Margin value = Emission level - Limit value
 5. Correction factor = Insertion loss + Cable loss
 6. Emission Level = Correction Factor + Reading Value.

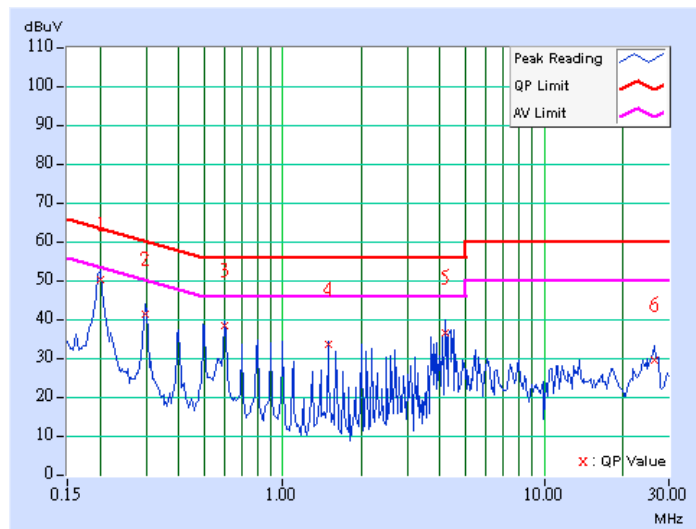



EUT	EDA (Enterprise Digital Assistant)	MEASUREMENT DETAIL	
MODEL	MC7090	PHASE	Line 2
CHANNEL	Channel 0	6dB BANDWIDTH	9 kHz
MODULATION TYPE	GFSK	ENVIRONMENTAL CONDITIONS	25deg. C, 65%RH, 991hPa
INPUT POWER (SYSTEM)	120Vac, 60 Hz	TEST MODE	B
TESTED BY	Jay Hsu		

No	Freq. [MHz]	Corr. Factor (dB)	Reading Value		Emission Level		Limit		Margin	
			[dB (uV)]		[dB (uV)]		[dB (uV)]		(dB)	
			Q.P.	AV.	Q.P.	AV.	Q.P.	AV.	Q.P.	AV.
1	0.201	0.11	47.78	-	47.89	-	63.58	53.58	-15.69	-
2	0.298	0.11	39.71	-	39.82	-	60.29	50.29	-20.47	-
3	0.599	0.15	36.76	-	36.91	-	56.00	46.00	-19.09	-
4	1.395	0.25	32.00	-	32.25	-	56.00	46.00	-23.75	-
5	4.293	0.39	37.29	-	37.68	-	56.00	46.00	-18.32	-
6	25.848	0.92	25.04	-	25.96	-	60.00	50.00	-34.04	-

- REMARKS:**
1. Q.P. and AV. are abbreviations of quasi-peak and average individually.
 2. "-": The Quasi-peak reading value also meets average limit and measurement with the average detector is unnecessary.
 3. The emission levels of other frequencies were very low against the limit.
 4. Margin value = Emission level - Limit value
 5. Correction factor = Insertion loss + Cable loss
 6. Emission Level = Correction Factor + Reading Value.

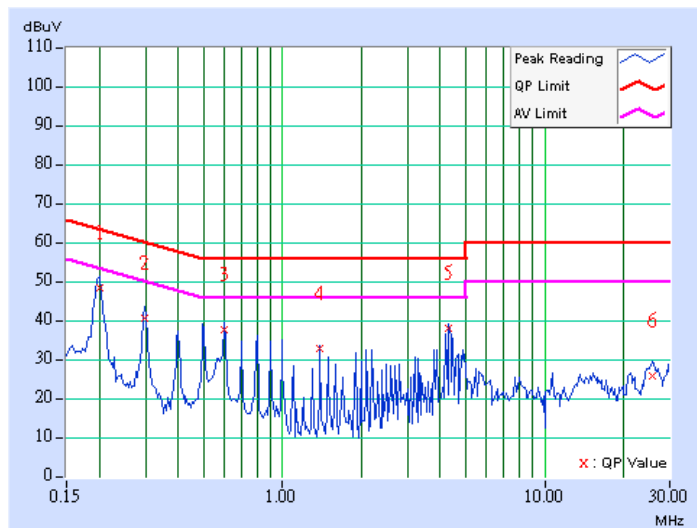



EUT	EDA (Enterprise Digital Assistant)	MEASUREMENT DETAIL	
MODEL	MC7090	PHASE	Line 1
CHANNEL	Channel 39	6dB BANDWIDTH	9 kHz
MODULATION TYPE	GFSK	ENVIRONMENTAL CONDITIONS	25deg. C, 65%RH, 991hPa
INPUT POWER (SYSTEM)	120Vac, 60 Hz	TEST MODE	B
TESTED BY	Jay Hsu		

No	Freq. [MHz]	Corr. Factor (dB)	Reading Value		Emission Level		Limit		Margin	
			[dB (uV)]		[dB (uV)]		[dB (uV)]		(dB)	
			Q.P.	AV.	Q.P.	AV.	Q.P.	AV.	Q.P.	AV.
1	0.201	0.11	48.23	-	48.34	-	63.58	53.58	-15.24	-
2	0.500	0.13	36.78	-	36.91	-	56.00	46.00	-19.09	-
3	0.998	0.24	32.15	-	32.39	-	56.00	46.00	-23.61	-
4	3.793	0.38	33.96	-	34.34	-	56.00	46.00	-21.66	-
5	4.391	0.40	36.57	-	36.97	-	56.00	46.00	-19.03	-
6	26.051	1.48	27.54	-	29.02	-	60.00	50.00	-30.98	-

- REMARKS:**
1. Q.P. and AV. are abbreviations of quasi-peak and average individually.
 2. "-": The Quasi-peak reading value also meets average limit and measurement with the average detector is unnecessary.
 3. The emission levels of other frequencies were very low against the limit.
 4. Margin value = Emission level - Limit value
 5. Correction factor = Insertion loss + Cable loss
 6. Emission Level = Correction Factor + Reading Value.

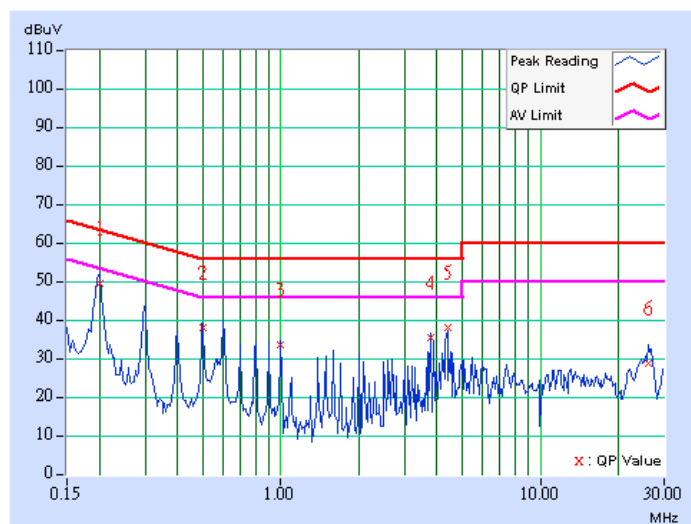



EUT	EDA (Enterprise Digital Assistant)	MEASUREMENT DETAIL	
MODEL	MC7090	PHASE	Line 2
CHANNEL	Channel 39	6dB BANDWIDTH	9 kHz
MODULATION TYPE	GFSK	ENVIRONMENTAL CONDITIONS	25deg. C, 65%RH, 991hPa
INPUT POWER (SYSTEM)	120Vac, 60 Hz	TEST MODE	B
TESTED BY	Jay Hsu		

No	Freq. [MHz]	Corr. Factor (dB)	Reading Value		Emission Level		Limit		Margin	
			[dB (uV)]		[dB (uV)]		[dB (uV)]		(dB)	
			Q.P.	AV.	Q.P.	AV.	Q.P.	AV.	Q.P.	AV.
1	0.201	0.11	48.22	-	48.33	-	63.58	53.58	-15.25	-
2	0.500	0.13	37.05	-	37.18	-	56.00	46.00	-18.82	-
3	0.998	0.24	32.23	-	32.47	-	56.00	46.00	-23.53	-
4	1.496	0.25	33.15	-	33.40	-	56.00	46.00	-22.60	-
5	4.293	0.39	37.27	-	37.66	-	56.00	46.00	-18.34	-
6	24.648	0.84	24.58	-	25.42	-	60.00	50.00	-34.58	-

- REMARKS:**
1. Q.P. and AV. are abbreviations of quasi-peak and average individually.
 2. "-": The Quasi-peak reading value also meets average limit and measurement with the average detector is unnecessary.
 3. The emission levels of other frequencies were very low against the limit.
 4. Margin value = Emission level - Limit value
 5. Correction factor = Insertion loss + Cable loss
 6. Emission Level = Correction Factor + Reading Value.

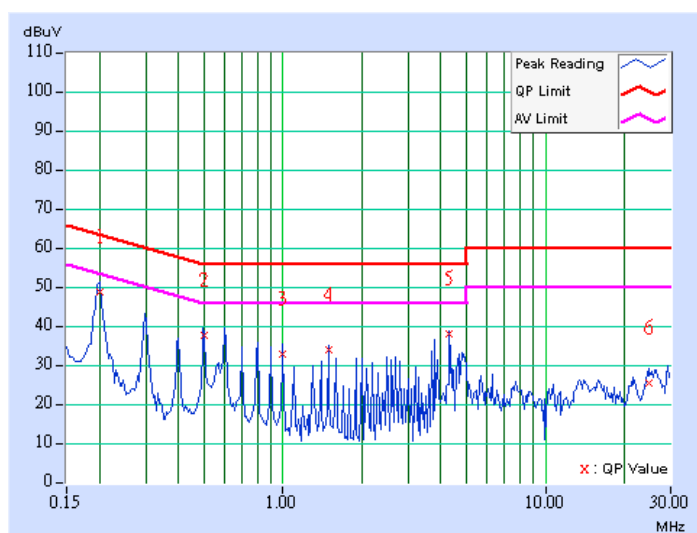



EUT	EDA (Enterprise Digital Assistant)	MEASUREMENT DETAIL	
MODEL	MC7090	PHASE	Line 1
CHANNEL	Channel 78	6dB BANDWIDTH	9 kHz
MODULATION TYPE	GFSK	ENVIRONMENTAL CONDITIONS	25deg. C, 65%RH, 991hPa
INPUT POWER (SYSTEM)	120Vac, 60 Hz	TEST MODE	B
TESTED BY	Jay Hsu		

No	Freq. [MHz]	Corr. Factor (dB)	Reading Value		Emission Level		Limit		Margin	
			[dB (uV)]		[dB (uV)]		[dB (uV)]		(dB)	
			Q.P.	AV.	Q.P.	AV.	Q.P.	AV.	Q.P.	AV.
1	0.201	0.11	48.11	-	48.22	-	63.58	53.58	-15.36	-
2	0.298	0.11	39.67	-	39.78	-	60.29	50.29	-20.51	-
3	2.094	0.27	31.79	-	32.06	-	56.00	46.00	-23.94	-
4	4.191	0.39	37.52	-	37.91	-	56.00	46.00	-18.09	-
5	13.070	0.55	25.65	-	26.20	-	60.00	50.00	-33.80	-
6	26.543	1.54	27.04	-	28.58	-	60.00	50.00	-31.42	-

- REMARKS:**
1. Q.P. and AV. are abbreviations of quasi-peak and average individually.
 2. "-": The Quasi-peak reading value also meets average limit and measurement with the average detector is unnecessary.
 3. The emission levels of other frequencies were very low against the limit.
 4. Margin value = Emission level - Limit value
 5. Correction factor = Insertion loss + Cable loss
 6. Emission Level = Correction Factor + Reading Value.

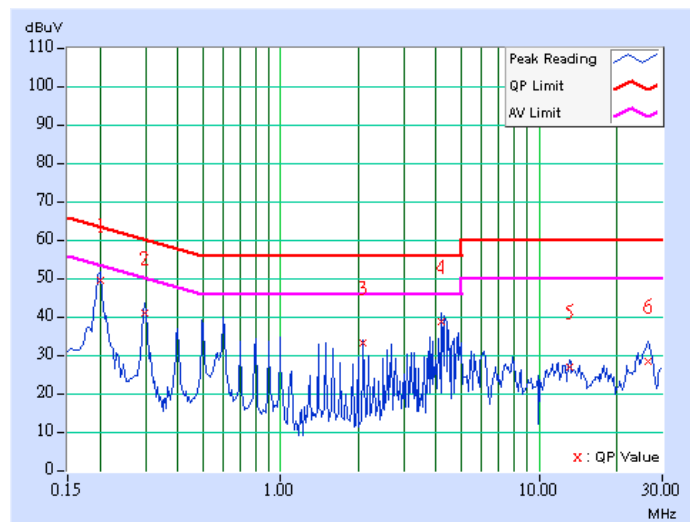



EUT	EDA (Enterprise Digital Assistant)	MEASUREMENT DETAIL	
MODEL	MC7090	PHASE	Line 2
CHANNEL	Channel 78	6dB BANDWIDTH	9 kHz
MODULATION TYPE	GFSK	ENVIRONMENTAL CONDITIONS	25deg. C, 65%RH, 991hPa
INPUT POWER (SYSTEM)	120Vac, 60 Hz	TEST MODE	B
TESTED BY	Jay Hsu		

No	Freq. [MHz]	Corr. Factor (dB)	Reading Value		Emission Level		Limit		Margin	
			[dB (uV)]		[dB (uV)]		[dB (uV)]		(dB)	
			Q.P.	AV.	Q.P.	AV.	Q.P.	AV.	Q.P.	AV.
1	0.201	0.11	47.32	-	47.43	-	63.58	53.58	-16.15	-
2	0.298	0.11	39.32	-	39.43	-	60.29	50.29	-20.86	-
3	0.498	0.13	37.00	-	37.13	-	56.04	46.04	-18.91	-
4	2.098	0.27	32.18	-	32.45	-	56.00	46.00	-23.55	-
5	4.191	0.39	36.81	-	37.20	-	56.00	46.00	-18.80	-
6	24.844	0.85	24.24	-	25.09	-	60.00	50.00	-34.91	-

- REMARKS:**
1. Q.P. and AV. are abbreviations of quasi-peak and average individually.
 2. "-": The Quasi-peak reading value also meets average limit and measurement with the average detector is unnecessary.
 3. The emission levels of other frequencies were very low against the limit.
 4. Margin value = Emission level - Limit value
 5. Correction factor = Insertion loss + Cable loss
 6. Emission Level = Correction Factor + Reading Value.

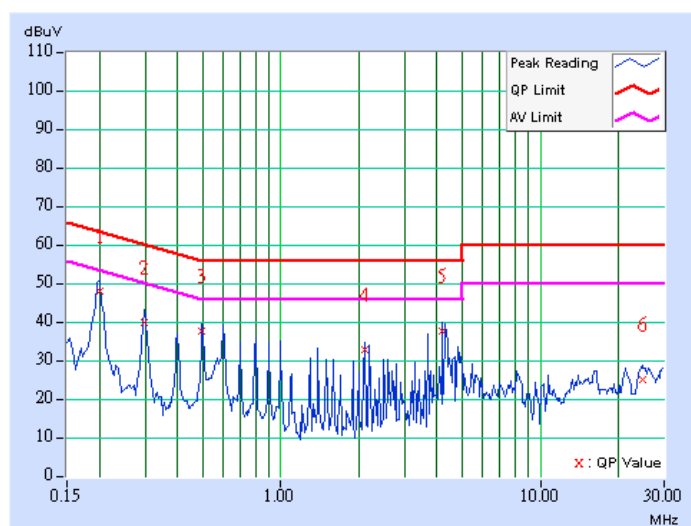



6.2 RADIATED EMISSION MEASUREMENT

6.2.1 LIMITS OF RADIATED EMISSION MEASUREMENT

Emissions radiated outside of the specified bands, shall be according to the general radiated limits in 15.209 as following:

FREQUENCIES (MHz)	FIELD STRENGTH (microvolts/meter)	MEASUREMENT DISTANCE (meters)
0.009 ~ 0.490	2400/F(kHz)	300
0.490 ~ 1.705	24000/F(kHz)	30
1.705 ~ 30.0	30	30
30 ~ 88	100	3
88 ~ 216	150	3
216 ~ 960	200	3
Above 960	500	3

NOTE:

1. The lower limit shall apply at the transition frequencies.
2. Emission level (dBuV/m) = 20 log Emission level (uV/m).
3. As shown in 15.35(b), for frequencies above 1000MHz, the field strength limits are based on average detector, however, the peak field strength of any emission shall not exceed the maximum permitted average limits, specified above by more than 20dB under any condition of modulation.



6.2.2 TEST INSTRUMENTS

DESCRIPTION & MANUFACTURER	MODEL NO.	SERIAL NO.	CALIBRATED UNTIL
Test Receiver ROHDE & SCHWARZ	ESIB7	100188	Dec. 19, 2005
Spectrum Analyzer ROHDE & SCHWARZ	FSP40	100039	Nov. 21, 2005
BILOG Antenna SCHWARZBECK	VULB9168	9168-157	Jan. 22, 2006
HORN Antenna SCHWARZBECK	BBHA 9120 D	9120D-407	Jan. 16, 2006
HORN Antenna SCHWARZBECK	BBHA 9170	BBHA 9170241	Feb. 23, 2006
Preamplifier Agilent	8449B	3008A01961	Nov. 09, 2005
Preamplifier Agilent	8447D	2944A10629	Nov. 09, 2005
RF signal cable HUBER+SUHNER	SUCOFLEX 104	218182/4	Feb. 17, 2006
RF signal cable HUBER+SUHNER	SUCOFLEX 104	218194/4	Feb. 17, 2006
Software ADT.	ADT_Radiated_V5.14	NA	NA
Antenna Tower ADT.	AT100	AT93021702	NA
Turn Table ADT.	TT100.	TT93021702	NA
Controller ADT.	SC100.	SC93021702	NA
26GHz ~ 40GHz Amplifier	AMF-6F-2600400	923362	Mar. 13, 2006

- NOTE:**
1. The calibration interval of the above test instruments is 12 months and the calibrations are traceable to NML/ROC and NIST/USA.
 2. The test was performed in HwaYa Chamber 1.
 3. The horn antenna and HP preamplifier (model: 8449B) are used only for the measurement of emission frequency above 1GHz if tested.
 4. The IC Site Registration No. is IC4924-2.



6.2.3 TEST PROCEDURES

- a. The EUT was placed on the top of a rotating table 0.8 meters above the ground at a 3 meter semi-anechoic chamber. The table was rotated 360 degrees to determine the position of the highest radiation.
- b. The EUT was set 3 meters away from the interference-receiving antenna, which was mounted on the top of a variable-height antenna tower.
- c. The antenna is a broadband antenna, and its height is varied from one meter to four meters above the ground to determine the maximum value of the field strength. Both horizontal and vertical polarizations of the antenna are set to make the measurement.
- d. For each suspected emission, the EUT was arranged to its worst case and then the antenna was tuned to heights from 1 meter to 4 meters and the rotatable table was turned from 0 degrees to 360 degrees to find the maximum reading.
- e. The test-receiver system was set to Peak Detect Function and Specified Bandwidth with Maximum Hold Mode.
- f. If the emission level of the EUT in peak mode was lower than the limit specified, then testing could be stopped and the peak values of the EUT would be reported. Otherwise the emissions would be re-tested one by one using peak, quasi-peak or average method as specified and then reported in a data sheet.

NOTE:

1. The resolution bandwidth and video bandwidth of test receiver/spectrum analyzer is 120kHz for Quasi-peak detection at frequency below 1GHz.
2. The resolution bandwidth and video bandwidth of test receiver/spectrum analyzer is 1 MHz for Peak detection (PK) at frequency above 1GHz.

6.2.4 DEVIATION FROM TEST STANDARD

No deviation

6.2.5 TEST SETUP

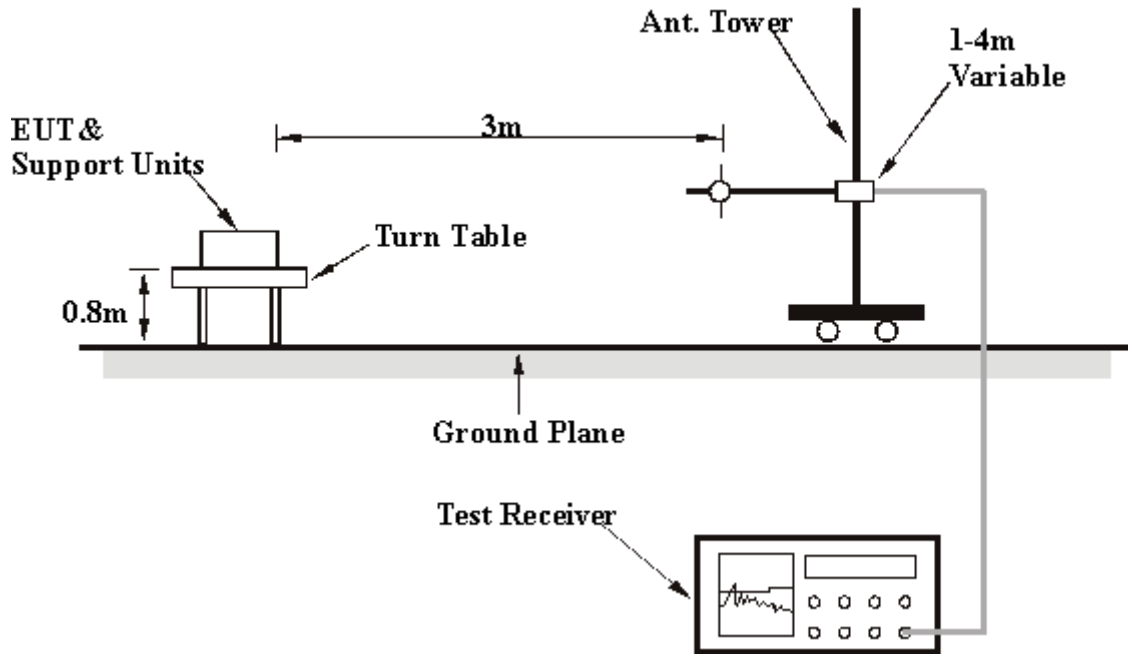

For the actual test configuration, please refer to the related item – Photographs of the Test Configuration.

6.2.6 EUT OPERATING CONDITIONS

Same as 4.1.6

6.2.7 TEST RESULTS

Radiated Worst Case Data (with charging cable)

EUT	EDA (Enterprise Digital Assistant)	MEASUREMENT DETAIL	
MODEL	MC7090	FREQUENCY RANGE	Below 1000MHz
CHANNEL	Channel 78	DETECTOR FUNCTION	Quasi-Peak
MODULATION TYPE	GFSK	ENVIRONMENTAL CONDITIONS	25deg. C, 65%RH, 991hPa
INPUT POWER (SYSTEM)	120Vac, 60 Hz	TEST MODE	A
TESTED BY	Match Tsui		

ANTENNA POLARITY & TEST DISTANCE: HORIZONTAL AT 3 M

No.	Freq. (MHz)	Emission Level (dBuV/m)	Limit (dBuV/m)	Margin (dB)	Antenna Height (m)	Table Angle (Degree)	Raw Value (dBuV)	Correction Factor (dB/m)
1	53.33	26.73 QP	40.00	-13.27	1.00 H	52	12.60	14.13
2	96.43	34.33 QP	43.50	-9.17	2.00 H	132	23.87	10.46
3	148.58	29.10 QP	43.50	-14.40	1.50 H	70	14.70	14.40
4	201.06	31.09 QP	43.50	-12.41	1.00 H	82	19.93	11.16
5	259.38	31.17 QP	46.00	-14.83	1.00 H	109	17.96	13.21
6	370.18	27.09 QP	46.00	-18.91	1.00 H	256	11.15	15.94
7	519.86	27.08 QP	46.00	-18.92	1.50 H	223	8.09	18.99

ANTENNA POLARITY & TEST DISTANCE: VERTICAL AT 3 M

No.	Freq. (MHz)	Emission Level (dBuV/m)	Limit (dBuV/m)	Margin (dB)	Antenna Height (m)	Table Angle (Degree)	Raw Value (dBuV)	Correction Factor (dB/m)
1	53.55	29.39 QP	40.00	-10.61	2.00 V	132	15.28	14.11
2	94.15	32.87 QP	43.50	-10.63	1.00 V	52	22.59	10.28
3	164.13	31.89 QP	43.50	-11.61	1.00 V	25	17.63	14.26
4	197.17	24.52 QP	43.50	-18.98	1.00 V	360	13.17	11.35
5	385.73	26.79 QP	46.00	-19.21	2.50 V	10	10.49	16.30
6	599.56	26.78 QP	46.00	-19.22	1.00 V	28	5.90	20.88

- REMARKS:**
1. Emission level (dBuV/m) = Raw Value (dBuV) + Correction Factor (dB/m).
 2. Correction Factor (dB/m) = Antenna Factor (dB/m) + Cable Factor (dB).
 3. The other emission levels were very low against the limit.
 4. Margin value = Emission level – Limit value.



Radiated Worst Case Data (with cradle)

EUT	EDA (Enterprise Digital Assistant)	MEASUREMENT DETAIL	
MODEL	MC7090	FREQUENCY RANGE	Below 1000MHz
CHANNEL	Channel 78	DETECTOR FUNCTION	Quasi-Peak
MODULATION TYPE	GFSK	ENVIRONMENTAL CONDITIONS	25deg. C, 65%RH, 991hPa
INPUT POWER (SYSTEM)	120Vac, 60 Hz	TEST MODE	B
TESTED BY	Match Tsui		

ANTENNA POLARITY & TEST DISTANCE: HORIZONTAL AT 3 M

No.	Freq. (MHz)	Emission Level (dBuV/m)	Limit (dBuV/m)	Margin (dB)	Antenna Height (m)	Table Angle (Degree)	Raw Value (dBuV)	Correction Factor (dB/m)
1	98.04	27.37 QP	43.50	-16.13	2.00 H	286	16.78	10.59
2	133.03	31.17 QP	43.50	-12.33	1.50 H	274	17.45	13.72
3	164.13	33.31 QP	43.50	-10.19	1.50 H	250	19.05	14.26
4	212.73	25.88 QP	43.50	-17.62	1.00 H	241	14.43	11.45
5	249.66	39.42 QP	46.00	-6.58	1.00 H	97	26.34	13.08
6	307.98	28.54 QP	46.00	-17.46	1.00 H	79	14.03	14.51
7	374.07	37.12 QP	46.00	-8.88	1.00 H	106	21.09	16.03
8	457.66	29.94 QP	46.00	-16.06	1.50 H	346	11.93	18.01
9	733.69	29.17 QP	46.00	-16.83	1.00 H	301	6.14	23.03
10	799.78	28.18 QP	46.00	-17.82	2.00 H	37	4.48	23.70

ANTENNA POLARITY & TEST DISTANCE: VERTICAL AT 3 M

No.	Freq. (MHz)	Emission Level (dBuV/m)	Limit (dBuV/m)	Margin (dB)	Antenna Height (m)	Table Angle (Degree)	Raw Value (dBuV)	Correction Factor (dB/m)
1	51.38	23.44 QP	40.00	-16.56	1.00 V	211	9.11	14.33
2	111.64	28.35 QP	43.50	-15.15	1.00 V	187	16.41	11.94
3	166.07	29.55 QP	43.50	-13.95	1.00 V	199	15.49	14.07
4	249.66	38.33 QP	46.00	-7.67	2.00 V	199	25.25	13.08
5	374.07	32.90 QP	46.00	-13.10	1.00 V	166	16.87	16.03
6	457.66	29.23 QP	46.00	-16.77	2.00 V	154	11.22	18.01

- REMARKS:**
1. Emission level (dBuV/m) = Raw Value (dBuV) + Correction Factor (dB/m).
 2. Correction Factor (dB/m) = Antenna Factor (dB/m) + Cable Factor (dB).
 3. The other emission levels were very low against the limit.
 4. Margin value = Emission level – Limit value.



Radiated Worst Case Data (battery mode)

EUT	EDA (Enterprise Digital Assistant)	MEASUREMENT DETAIL	
MODEL	MC7090	FREQUENCY RANGE	Below 1000MHz
CHANNEL	Channel 78	DETECTOR FUNCTION	Quasi-Peak
MODULATION TYPE	GFSK	ENVIRONMENTAL CONDITIONS	25deg. C, 65%RH, 991hPa
INPUT POWER (SYSTEM)	120Vac, 60 Hz	TEST MODE	C
TESTED BY	Match Tsui		

ANTENNA POLARITY & TEST DISTANCE: HORIZONTAL AT 3 M

No.	Freq. (MHz)	Emission Level (dBuV/m)	Limit (dBuV/m)	Margin (dB)	Antenna Height (m)	Table Angle (Degree)	Raw Value (dBuV)	Correction Factor (dB/m)
1	98.04	28.47 QP	43.50	-15.03	2.00 H	286	17.88	10.59
2	136.91	34.82 QP	43.50	-8.68	2.00 H	286	20.83	13.99
3	168.02	32.40 QP	43.50	-11.10	1.50 H	235	18.53	13.88
4	199.12	26.70 QP	43.50	-16.80	1.50 H	325	15.50	11.20
5	519.86	28.32 QP	46.00	-17.68	1.50 H	70	9.33	18.99
6	739.52	30.62 QP	46.00	-15.38	1.00 H	283	7.45	23.17
7	811.44	28.59 QP	46.00	-17.41	1.00 H	283	4.79	23.80

ANTENNA POLARITY & TEST DISTANCE: VERTICAL AT 3 M

No.	Freq. (MHz)	Emission Level (dBuV/m)	Limit (dBuV/m)	Margin (dB)	Antenna Height (m)	Table Angle (Degree)	Raw Value (dBuV)	Correction Factor (dB/m)
1	47.49	23.31 QP	40.00	-16.69	1.00 V	175	8.54	14.76
2	162.18	27.60 QP	43.50	-15.90	1.00 V	268	13.16	14.45
3	615.11	29.72 QP	46.00	-16.28	1.00 V	133	8.61	21.10
4	731.74	27.39 QP	46.00	-18.61	1.50 V	343	4.41	22.99
5	850.32	29.39 QP	46.00	-16.61	1.50 V	274	5.26	24.13
6	902.81	27.75 QP	46.00	-18.25	1.50 V	133	2.62	25.13

- REMARKS:**
1. Emission level (dBuV/m) = Raw Value (dBuV) + Correction Factor (dB/m).
 2. Correction Factor (dB/m) = Antenna Factor (dB/m) + Cable Factor (dB).
 3. The other emission levels were very low against the limit.
 4. Margin value = Emission level – Limit value.



EUT	EDA (Enterprise Digital Assistant)	MEASUREMENT DETAIL	
MODEL	MC7090	FREQUENCY RANGE	1 ~ 25GHz
CHANNEL	Channel 0	DETECTOR FUNCTION	Peak (PK) Average (AV)
MODULATION TYPE	GFSK	INPUT POWER (SYSTEM)	120Vac, 60 Hz
ENVIRONMENTAL CONDITIONS	25deg. C, 67%RH, 991hPa	TESTED BY	Long Chen

ANTENNA POLARITY & TEST DISTANCE: HORIZONTAL AT 3 M

No.	Freq. (MHz)	Emission Level (dBuV/m)	Limit (dBuV/m)	Margin (dB)	Antenna Height (m)	Table Angle (Degree)	Raw Value (dBuV)	Correction Factor (dB/m)
1	2390.00	38.97 PK	74.00	-35.03	1.50 H	28	6.93	32.04
2	*2402.00	91.97 PK			1.50 H	28	59.88	32.09
2	*2402.00	61.97 AV			1.50 H	28	29.88	32.09
3	4804.00	51.88 PK	74.00	-22.12	1.31 H	233	13.73	38.15
3	4804.00	21.88 AV	54.00	-32.12	1.31 H	233	-16.27	38.15

ANTENNA POLARITY & TEST DISTANCE: VERTICAL AT 3 M

No.	Freq. (MHz)	Emission Level (dBuV/m)	Limit (dBuV/m)	Margin (dB)	Antenna Height (m)	Table Angle (Degree)	Raw Value (dBuV)	Correction Factor (dB/m)
1	2390.00	34.64 PK	74.00	-39.36	1.35 V	151	2.60	32.04
2	*2402.00	87.64 PK			1.35 V	151	55.55	32.09
2	*2402.00	57.64 AV			1.35 V	151	25.55	32.09
3	4804.00	51.20 PK	74.00	-22.80	1.00 V	243	13.05	38.15
3	4804.00	21.20 AV	54.00	-32.80	1.00 V	243	-16.95	38.15

- REMARKS:**
1. Emission level (dBuV/m) = Raw Value (dBuV) + Correction Factor (dB/m).
 2. Correction Factor (dB/m) = Antenna Factor (dB/m) + Cable Factor (dB).
 3. The other emission levels were very low against the limit.
 4. Margin value = Emission level – Limit value.
 5. The DH5 packet was the worse case duty cycle for a transmit dwell time on a channel, based upon bluetooth theory the transmitter is on 0.625 * 5 per 296.25 ms per channel. Therefore, the duty cycle be equal to: $20\log(3.125/100) = -30$ dB.
 6. Average value = peak reading $-20\log(\text{duty cycle})$.



EUT	EDA (Enterprise Digital Assistant)	MEASUREMENT DETAIL	
MODEL	MC7090	FREQUENCY RANGE	1 ~ 25GHz
CHANNEL	Channel 39	DETECTOR FUNCTION	Peak (PK) Average (AV)
MODULATION TYPE	GFSK	INPUT POWER (SYSTEM)	120Vac, 60 Hz
ENVIRONMENTAL CONDITIONS	25deg. C, 67%RH, 991hPa	TESTED BY	Long Chen

ANTENNA POLARITY & TEST DISTANCE: HORIZONTAL AT 3 M

No.	Freq. (MHz)	Emission Level (dBuV/m)	Limit (dBuV/m)	Margin (dB)	Antenna Height (m)	Table Angle (Degree)	Raw Value (dBuV)	Correction Factor (dB/m)
1	*2441.00	92.35 PK			1.39 H	26	60.09	32.26
1	*2441.00	62.35 AV			1.39 H	26	30.09	32.26
2	4882.00	52.68 PK	74.00	-21.32	1.00 H	296	14.34	38.34
2	4882.00	22.68 AV	54.00	-31.32	1.00 H	296	-15.66	38.34

ANTENNA POLARITY & TEST DISTANCE: VERTICAL AT 3 M

No.	Freq. (MHz)	Emission Level (dBuV/m)	Limit (dBuV/m)	Margin (dB)	Antenna Height (m)	Table Angle (Degree)	Raw Value (dBuV)	Correction Factor (dB/m)
1	*2441.00	88.30 PK			1.32 V	154	56.21	32.09
1	*2441.00	58.30 AV			1.32 V	154	26.21	32.09
2	4882.00	51.63 PK	74.00	-22.37	1.27 V	229	13.29	38.34
2	4882.00	21.63 AV	54.00	-32.37	1.27 V	229	-16.71	38.34

- REMARKS:**
1. Emission level (dBuV/m) = Raw Value (dBuV) + Correction Factor (dB/m).
 2. Correction Factor (dB/m) = Antenna Factor (dB/m) + Cable Factor (dB).
 3. The other emission levels were very low against the limit.
 4. Margin value = Emission level – Limit value.
 5. The DH5 packet was the worse case duty cycle for a transmit dwell time on a channel, based upon bluetooth theory the transmitter is on 0.625 * 5 per 296.25 ms per channel. Therefore, the duty cycle be equal to: $20\log(3.125/100) = -30$ dB.
 6. Average value = peak reading $-20\log(\text{duty cycle})$.



EUT	EDA (Enterprise Digital Assistant)	MEASUREMENT DETAIL	
MODEL	MC7090	FREQUENCY RANGE	1 ~ 25GHz
CHANNEL	Channel 78	DETECTOR FUNCTION	Peak (PK) Average (AV)
MODULATION TYPE	GFSK	INPUT POWER (SYSTEM)	120Vac, 60 Hz
ENVIRONMENTAL CONDITIONS	25deg. C, 67%RH, 991hPa	TESTED BY	Long Chen

ANTENNA POLARITY & TEST DISTANCE: HORIZONTAL AT 3 M

No.	Freq. (MHz)	Emission Level (dBuV/m)	Limit (dBuV/m)	Margin (dB)	Antenna Height (m)	Table Angle (Degree)	Raw Value (dBuV)	Correction Factor (dB/m)
1	*2480.00	93.42 PK			1.43 H	25	60.98	32.44
1	*2480.00	63.42 AV			1.43 H	25	30.98	32.44
2	2483.50	41.42 PK	74.00	-32.58	1.43 H	25	8.96	32.46
3	4960.00	54.96 PK	74.00	-19.04	1.32 H	296	16.39	38.57
3	4960.00	24.96 AV	54.00	-29.04	1.32 H	296	-13.61	38.57

ANTENNA POLARITY & TEST DISTANCE: VERTICAL AT 3 M

No.	Freq. (MHz)	Emission Level (dBuV/m)	Limit (dBuV/m)	Margin (dB)	Antenna Height (m)	Table Angle (Degree)	Raw Value (dBuV)	Correction Factor (dB/m)
1	*2480.00	88.96 PK			1.06 V	173	56.52	32.44
1	*2480.00	58.96 AV			1.06 V	173	26.52	32.44
2	2483.50	36.96 PK	74.00	-37.04	1.06 V	173	4.50	32.46
3	4960.00	53.84 PK	74.00	-20.16	1.00 V	327	15.27	38.57
3	4960.00	23.84 AV	54.00	-30.16	1.00 V	327	-14.73	38.57

- REMARKS:**
1. Emission level (dBuV/m) = Raw Value (dBuV) + Correction Factor (dB/m).
 2. Correction Factor (dB/m) = Antenna Factor (dB/m) + Cable Factor (dB).
 3. The other emission levels were very low against the limit.
 4. Margin value = Emission level – Limit value.
 5. The DH5 packet was the worse case duty cycle for a transmit dwell time on a channel, based upon bluetooth theory the transmitter is on 0.625 * 5 per 296.25 ms per channel. Therefore, the duty cycle be equal to: $20\log(3.125/100) = -30$ dB.
 6. Average value = peak reading $-20\log(\text{duty cycle})$.



6.3 NUMBER OF HOPPING FREQUENCY USED

6.3.1 LIMIT OF HOPPING FREQUENCY USED

At least 15 channels frequencies, and should be equally spaced.

6.3.2 TEST INSTRUMENTS

DESCRIPTION & MANUFACTURER	MODEL NO.	SERIAL NO.	CALIBRATED UNTIL
SPECTRUM ANALYZER	FSEK30	100049	Aug. 14, 2006

NOTE: The calibration interval of the above test instruments is 12 months. And the calibrations are traceable to NML/ROC and NIST/USA.

6.3.3 TEST PROCEDURES

- a. Check the calibration of the measuring instrument (SA) using either an internal calibrator or a known signal from an external generator.
- b. Turn on the EUT and connect its antenna terminal to measurement via a low loss cable. Then set it to any one measured frequency within its operating range and make sure the instrument is operated in its linear range.
- c. Set the SA on MaxHold Mode, and then keep the EUT in hopping mode. Record all the signals from each channel until each one has been recorded.
- d. Set the SA on View mode and then plot the result on SA screen.
- e. Repeat above procedures until all frequencies measured were complete.

6.3.4 DEVIATION FROM TEST STANDARD

No deviation.

6.3.5 TEST SETUP



6.3.6 TEST RESULTS

There are 79 hopping frequencies in the hopping mode. Please refer to next two pages for the test result. On the plots, it shows that the hopping frequencies are equally spaced.

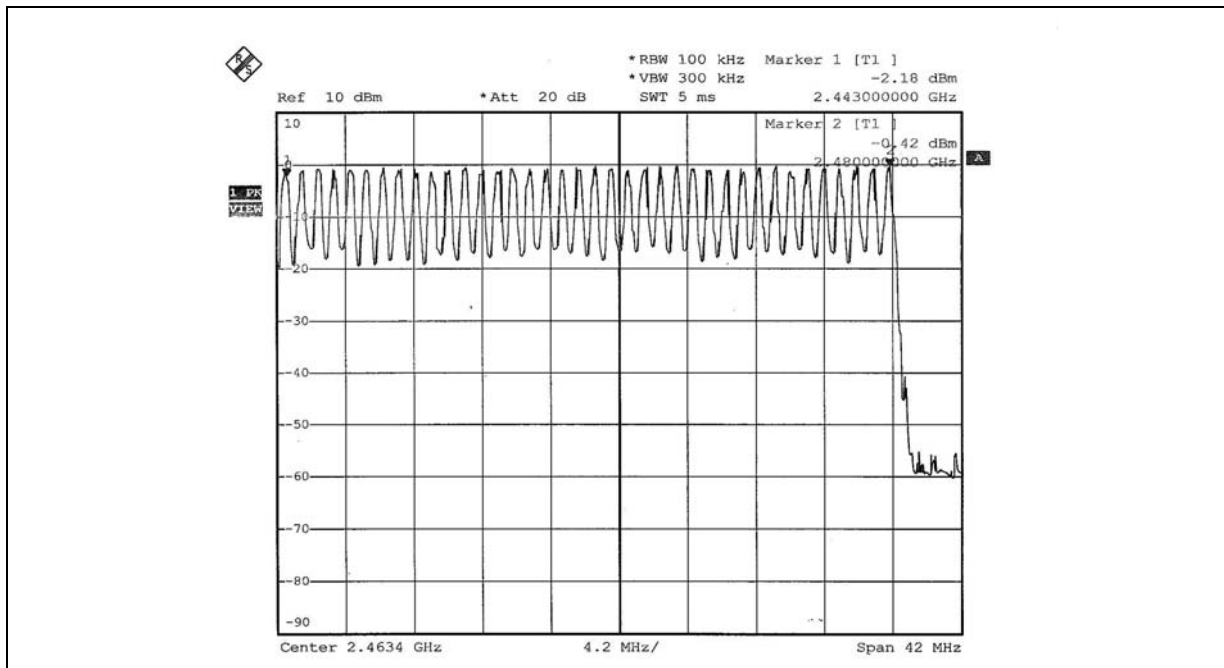
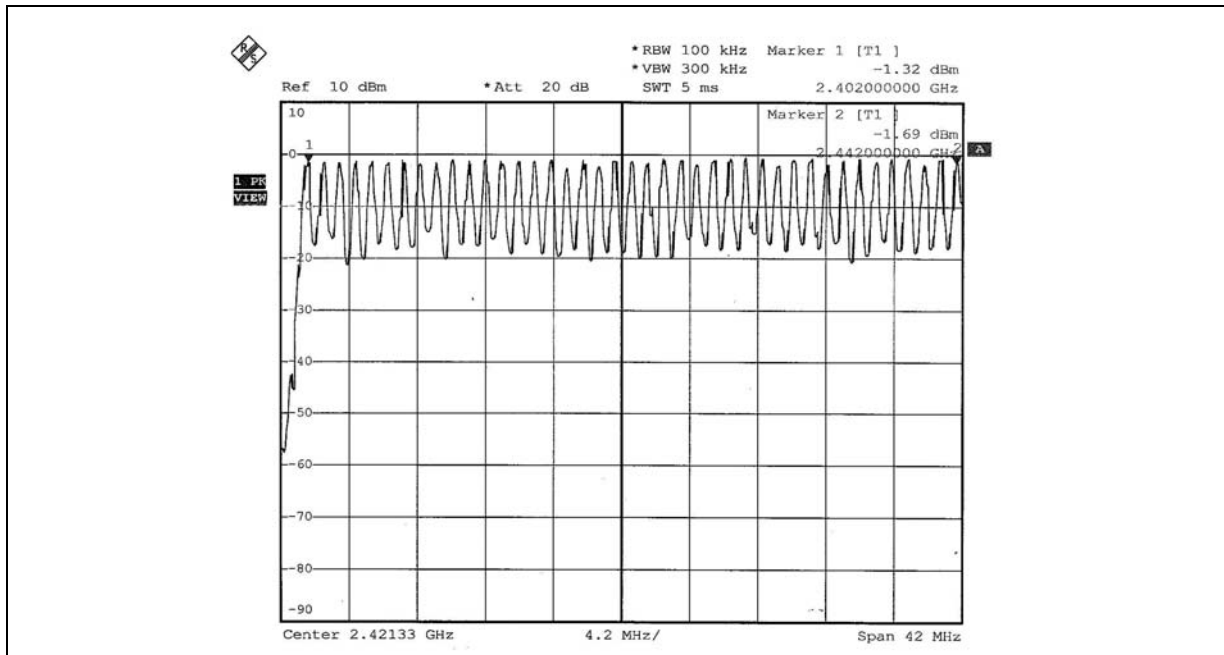



6.4 DWELL TIME ON EACH CHANNEL

6.4.1 LIMIT OF DWELL TIME USED

The average time of occupancy on any channel shall not be greater than 0.4 seconds within a period of 0.4 seconds multiplied by the number of hopping channels employed.

6.4.2 TEST INSTRUMENTS

DESCRIPTION & MANUFACTURER	MODEL NO.	SERIAL NO.	CALIBRATED UNTIL
SPECTRUM ANALYZER	FSEK30	100049	Aug. 14, 2006

NOTES: The calibration interval of the above test instruments is 12 months. And the calibrations are traceable to NML/ROC and NIST/USA.

6.4.3 TEST PROCEDURES

- a. Check the calibration of the measuring instrument (SA) using either an internal calibrator or a known signal from an external generator.
- b. Turn on the EUT and connect its antenna terminal to measurement via a low loss cable. Then set it to any one measured frequency within its operating range and make sure the instrument is operated in its linear range.
- c. Adjust the center frequency of SA on any frequency be measured and set SA to zero span mode. And then, set RBW and VBW of spectrum analyzer to proper value.
- d. Measure the time duration of one transmission on the measured frequency. And then plot the result with time difference of this time duration.
- e. Repeat above procedures until all different time-slot modes have been completed.

6.4.4 DEVIATION FROM TEST STANDARD

No deviation.

6.4.5 TEST SETUP



6.4.6 TEST RESULTS

MODE	NUMBER OF TRANSMISSION IN A 31.6 (79HOPPING * 0.4)	LENGTH OF TRANSMISSION TIME (msec)	RESULT (msec)	LIMIT (msec)
DH1	50 (times / 5 sec) * 6.32 = 316.00 times	0.470	148.52	400
DH3	28 (times / 5 sec) * 6.32 = 176.96 times	1.728	305.79	400
DH5	17 (times / 5 sec) * 6.32 = 107.44 times	2.980	320.17	400

NOTE: Test plots of the transmitting time slot are shown on next 3 pages.



DH1

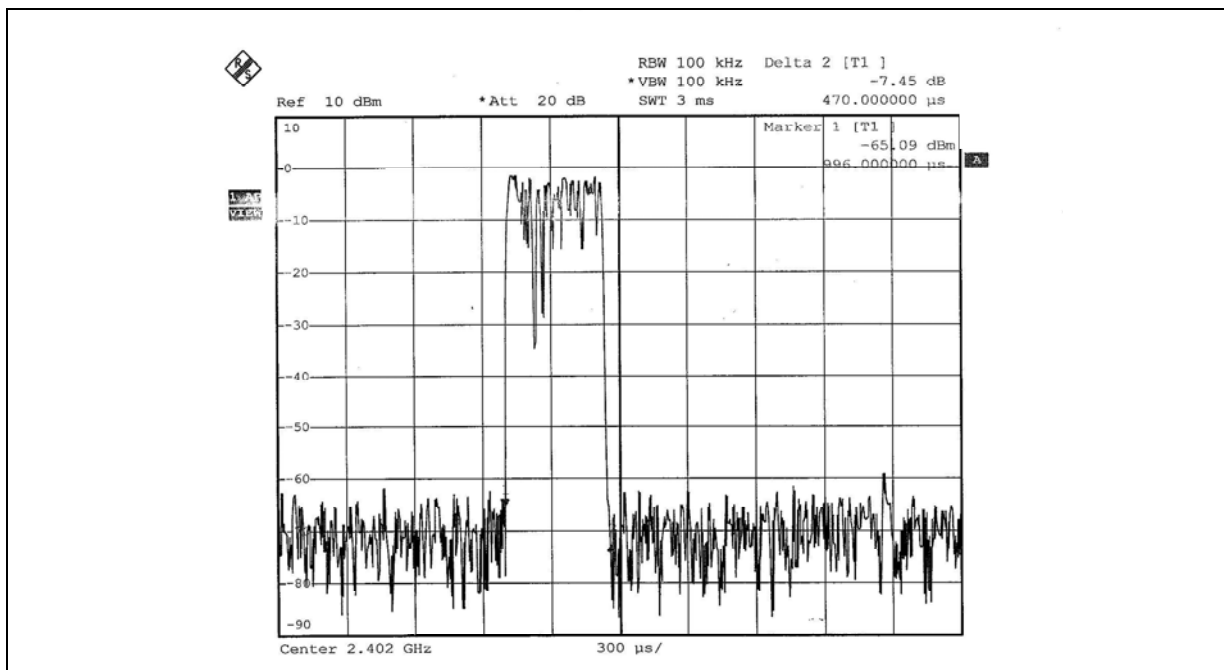
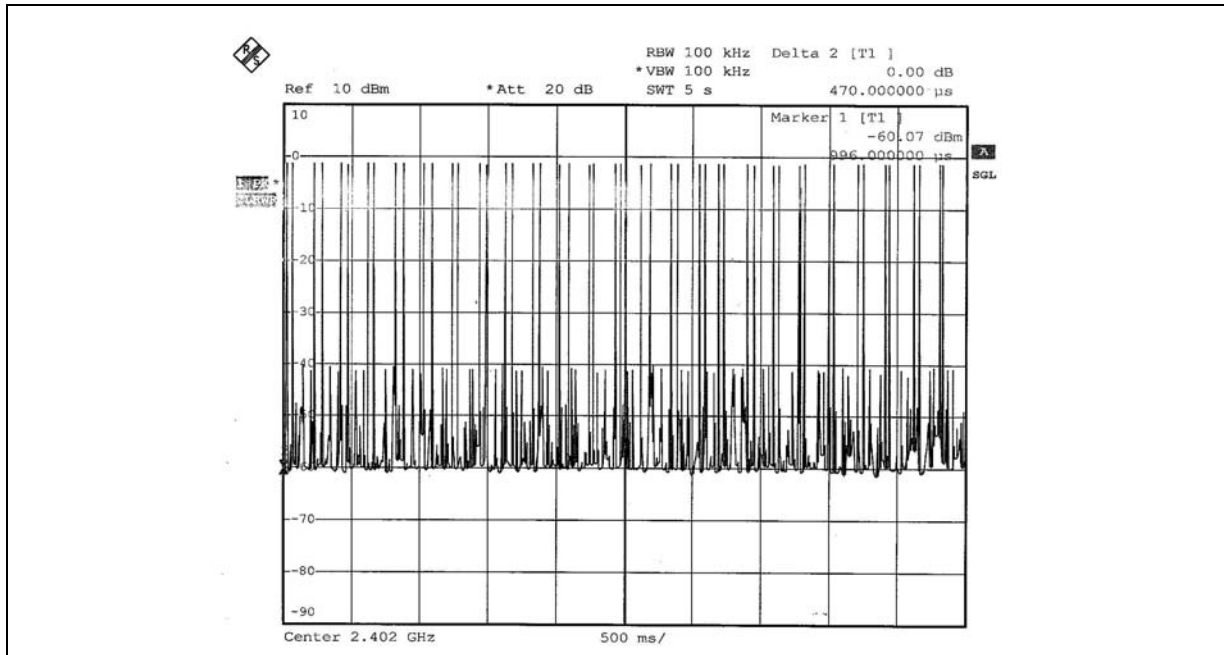



DH3

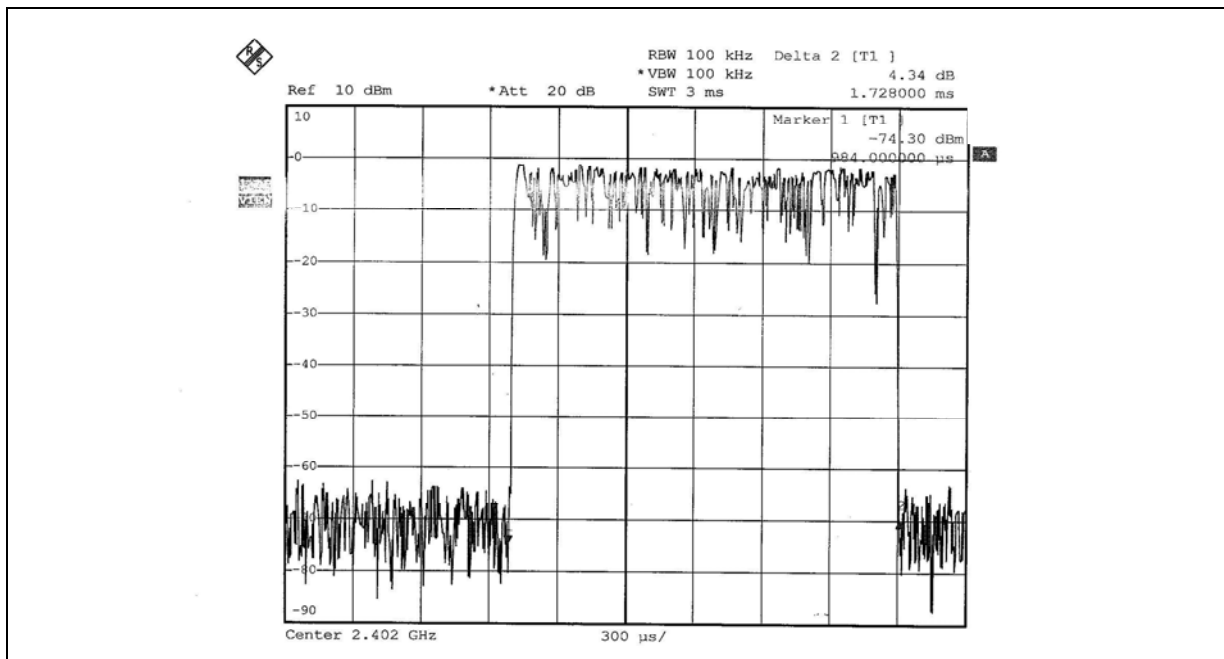
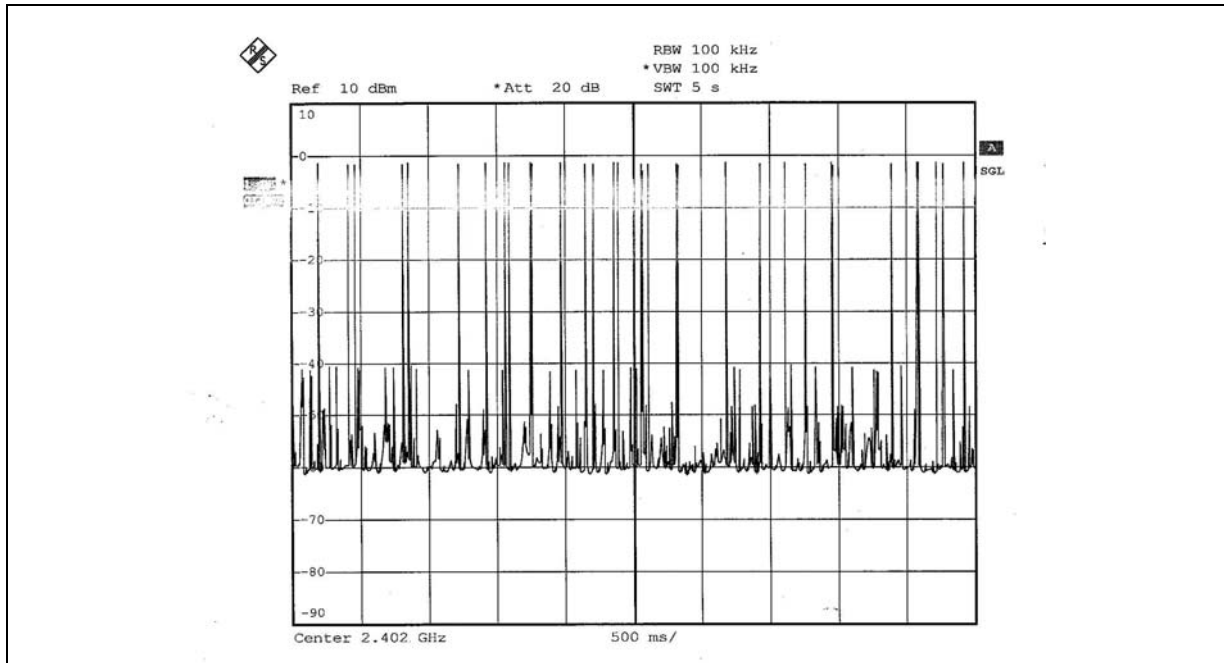



DH5

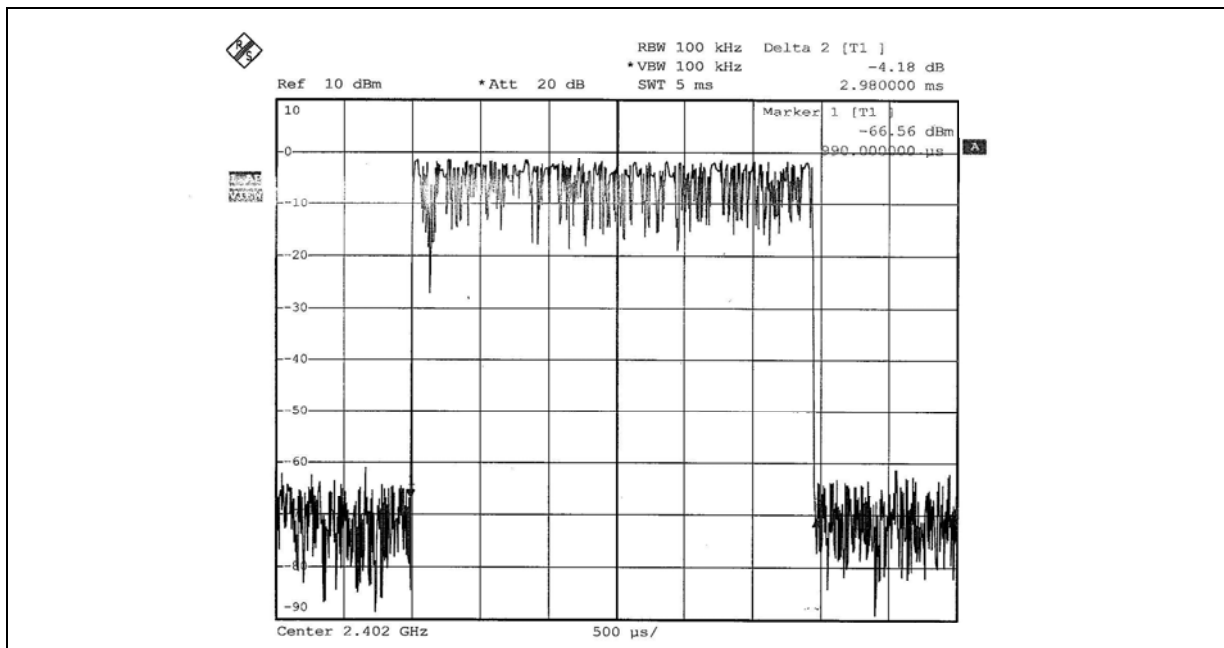
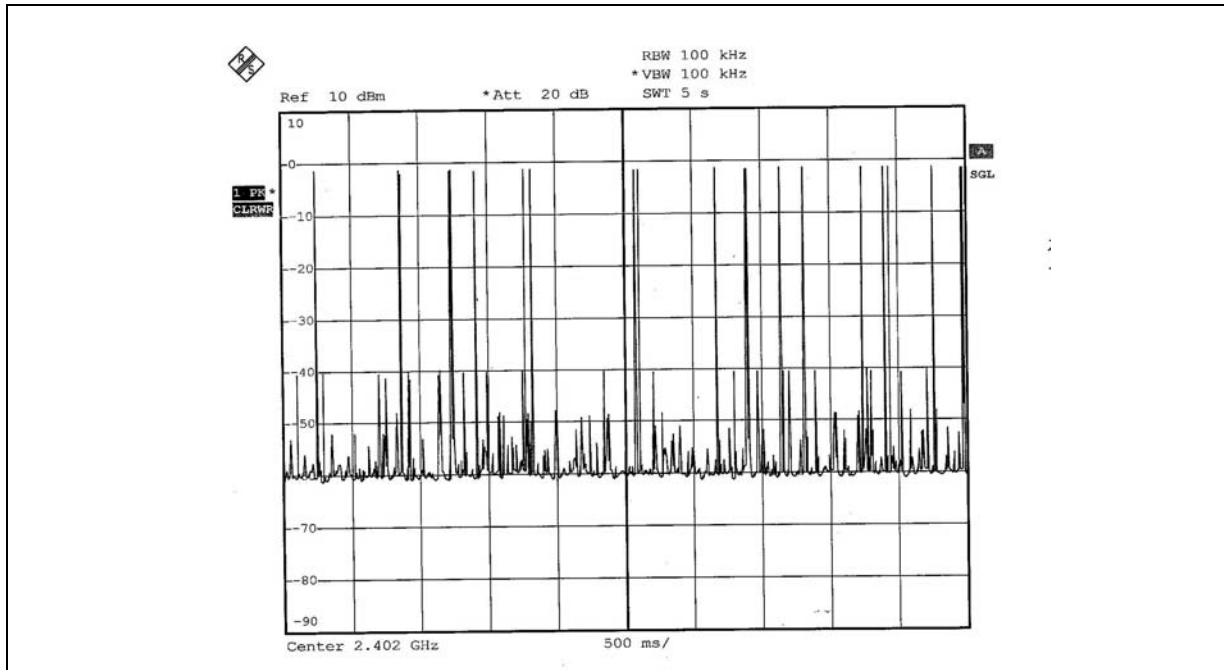



6.5 CHANNEL BANDWIDTH

6.5.1 LIMITS OF CHANNEL BANDWIDTH

For frequency hopping system operating in the 2400-2483.5MHz, If the 20dB bandwidth of hopping channel is greater than 25kHz, the 20dB bandwidth of hopping channel shall be a minimum limit for the hopping channel separation.

6.5.2 TEST INSTRUMENTS

DESCRIPTION & MANUFACTURER	MODEL NO.	SERIAL NO.	CALIBRATED UNTIL
SPECTRUM ANALYZER	FSEK30	100049	Aug. 14, 2006

NOTE: The calibration interval of the above test instruments is 12 months. And the calibrations are traceable to NML/ROC and NIST/USA.

6.5.3 TEST PROCEDURE

- a. Check the calibration of the measuring instrument using either an internal calibrator or a known signal from an external generator.
- b. Turn on the EUT and connect it to measurement instrument. Then set it to any one convenient frequency within its operating range. Set a reference level on the measuring instrument equal to the highest peak value.
- c. Measure the frequency difference of two frequencies that were attenuated 20dB from the reference level. Record the frequency difference as the emission bandwidth.
- d. Repeat above procedures until all frequencies measured were complete.

6.5.4 DEVIATION FROM TEST STANDARD

No deviation.

6.5.5 TEST SETUP



6.5.6 EUT OPERATING CONDITION

The software provided by client enabled the EUT to transmit and receive data at lowest, middle and highest channel frequencies individually.



6.5.7 TEST RESULTS

EUT	EDA (Enterprise Digital Assistant)	MODEL	MC7090
MODULATION TYPE	GFSK	ENVIRONMENTAL CONDITIONS	27deg. C, 63%RH, 991hPa
INPUT POWER (SYSTEM)	120Vac, 60 Hz	TESTED BY	Long Chen

CHANNEL	CHANNEL FREQUENCY (MHz)	20dB BANDWIDTH (MHz)
0	2402	0.924
39	2441	0.948
78	2480	0.948



CH 0

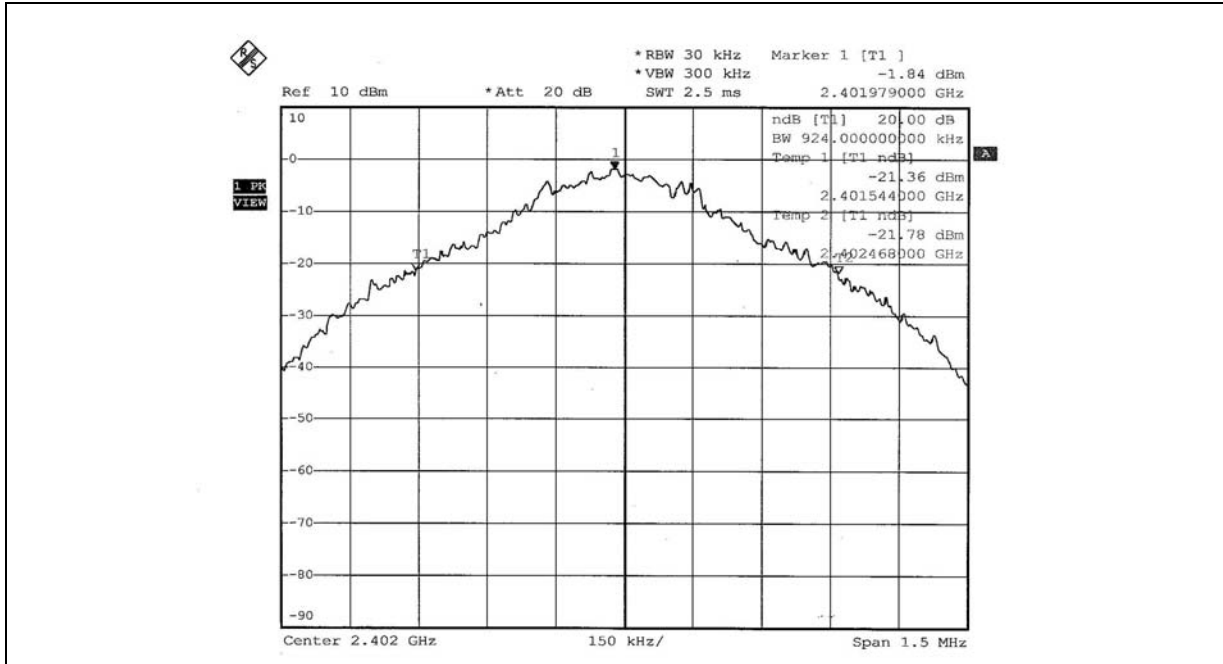

CH 39

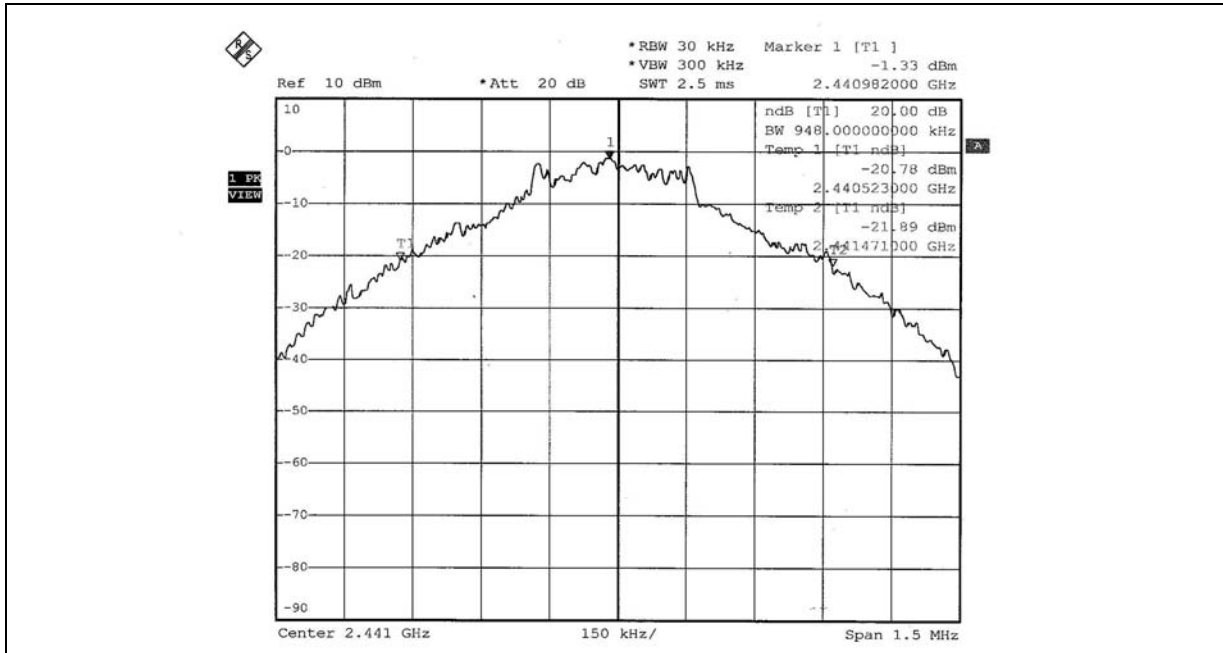



CH 78

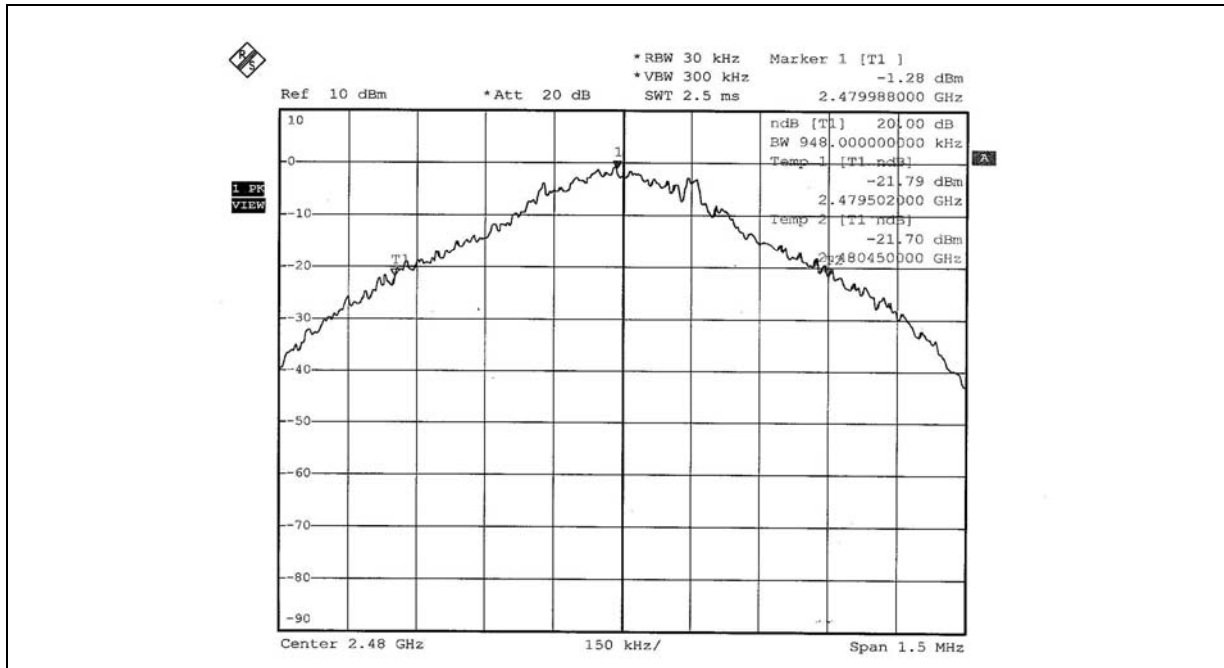

6.6 HOPPING CHANNEL SEPARATION

6.6.1 LIMIT OF HOPPING CHANNEL SEPARATION

At least 25kHz or 20dB hopping channel bandwidth (whichever is greater).

6.6.2 TEST INSTRUMENTS

DESCRIPTION & MANUFACTURER	MODEL NO.	SERIAL NO.	CALIBRATED UNTIL
SPECTRUM ANALYZER	FSEK30	100049	Aug. 14, 2006

NOTES: The calibration interval of the above test instruments is 12 months. And the calibrations are traceable to NML/ROC and NIST/USA.

6.6.3 TEST PROCEDURES

1. Check the calibration of the measuring instrument using either an internal calibrator or a known signal from an external generator.
2. Turn on the EUT and connect it to measurement instrument. Then set it to any one convenient frequency within its operating range.
3. By using the MaxHold function record the separation of two adjacent channels.
4. Measure the frequency difference of these two adjacent channels by SA MARK function. And then plot the result on SA screen.
5. Repeat above procedures until all frequencies measured were complete.

6.6.4 DEVIATION FROM TEST STANDARD

No deviation.

6.6.5 TEST SETUP





6.6.6 TEST RESULTS

EUT	EDA (Enterprise Digital Assistant)	MODEL	MC7090
MODULATION TYPE	GFSK	ENVIRONMENTAL CONDITIONS	27deg. C, 63%RH, 991hPa
INPUT POWER (SYSTEM)	120Vac, 60 Hz	TESTED BY	Long Chen

CHANNEL	FREQUENCY (MHz)	ADJACENT CHANNEL SEPARATION (MHz)	MINIMUM LIMIT (MHz)	PASS / FAIL
0	2402	1.010	0.924	PASS
39	2441	1.005	0.948	PASS
78	2480	1.015	0.948	PASS

NOTE: The minimum limit is 20dB bandwidth. Test results please refer to next two pages.



CH 0

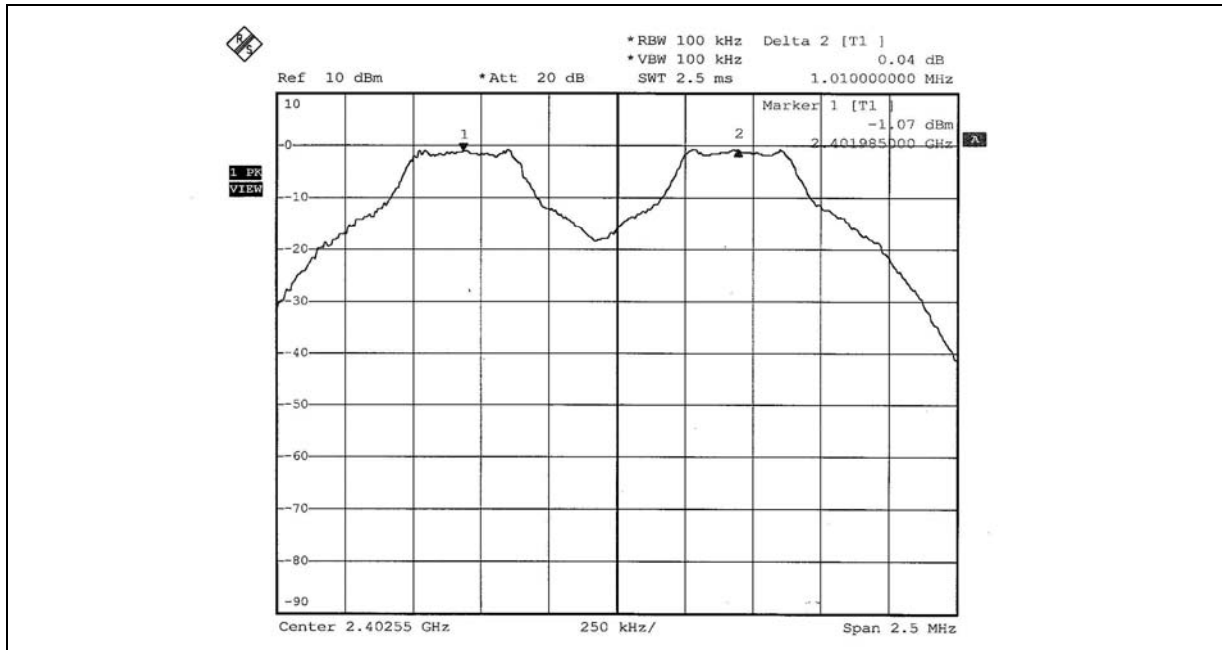

CH 39

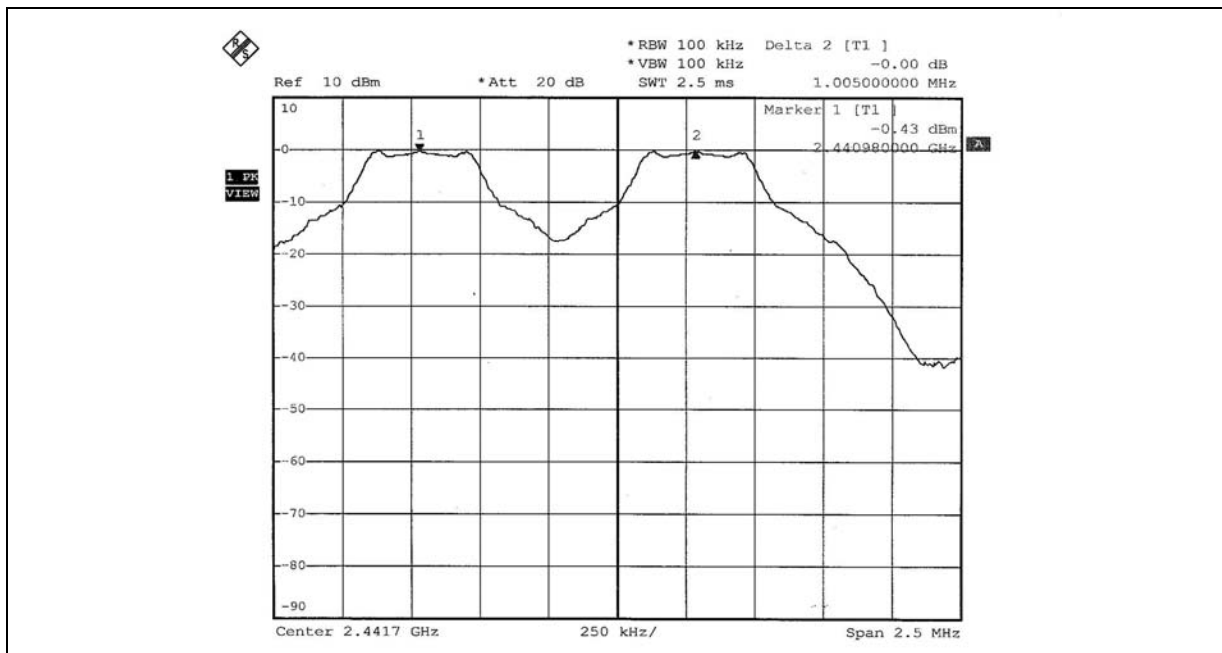



CH 78

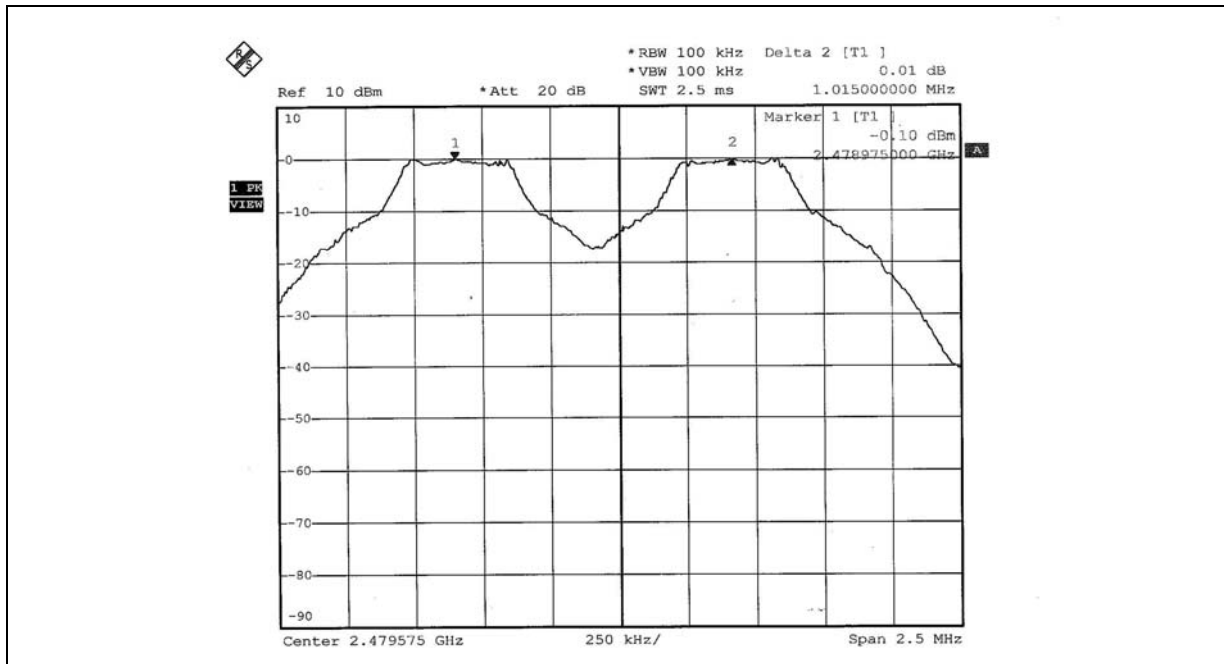



6.7 MAXIMUM PEAK OUTPUT POWER

6.7.1 LIMITS OF MAXIMUM PEAK OUTPUT POWER MEASUREMENT

The Maximum Peak Output Power Measurement is 30dBm.

6.7.2 TEST INSTRUMENTS

DESCRIPTION & MANUFACTURER	MODEL NO.	SERIAL NO.	CALIBRATED UNTIL
SPECTRUM ANALYZER	FSEK30	100049	Aug. 14, 2006

NOTE: The calibration interval of the above test instruments is 12 months and the calibrations are traceable to NML/ROC and NIST/USA.

6.7.3 TEST PROCEDURES

- a. Check the calibration of the measuring instrument using either an internal calibrator or a known signal from an external generator.
- b. Turn on the EUT and connect it to measurement instrument. Then set it to any one convenient frequency within its operating range. Set a reference level on the measuring instrument equal to the highest peak value.
- c. The center frequency of the spectrum analyzer is set to the fundamental frequency and using 1 MHz RBW and 3 MHz VBW.
- d. Measure the captured power within the band and recording the plot.
- e. Repeat above procedures until all frequencies required were complete.

6.7.4 DEVIATION FROM TEST STANDARD

No deviation

6.7.5 TEST SETUP



For the actual test configuration, please refer to the related Item – Photographs of the Test Configuration.

6.7.6 EUT OPERATING CONDITION

The software provided by client enabled the EUT to transmit and receive data at lowest, middle and highest channel frequencies individually.



6.7.7 TEST RESULTS

EUT	EDA (Enterprise Digital Assistant)	MODEL	MC7090
MODULATION TYPE	GFSK	ENVIRONMENTAL CONDITIONS	27deg. C, 63%RH, 991hPa
INPUT POWER (SYSTEM)	120Vac, 60 Hz	TESTED BY	Long Chen

CHANNEL	CHANNEL FREQUENCY (MHz)	PEAK POWER OUTPUT (mW)	PEAK POWER OUTPUT (dBm)	PEAK POWER LIMIT (dBm)	PASS/FAIL
0	2402	0.873	-0.59	30	PASS
39	2441	0.979	-0.09	30	PASS
78	2480	1.057	0.24	30	PASS



CH 0

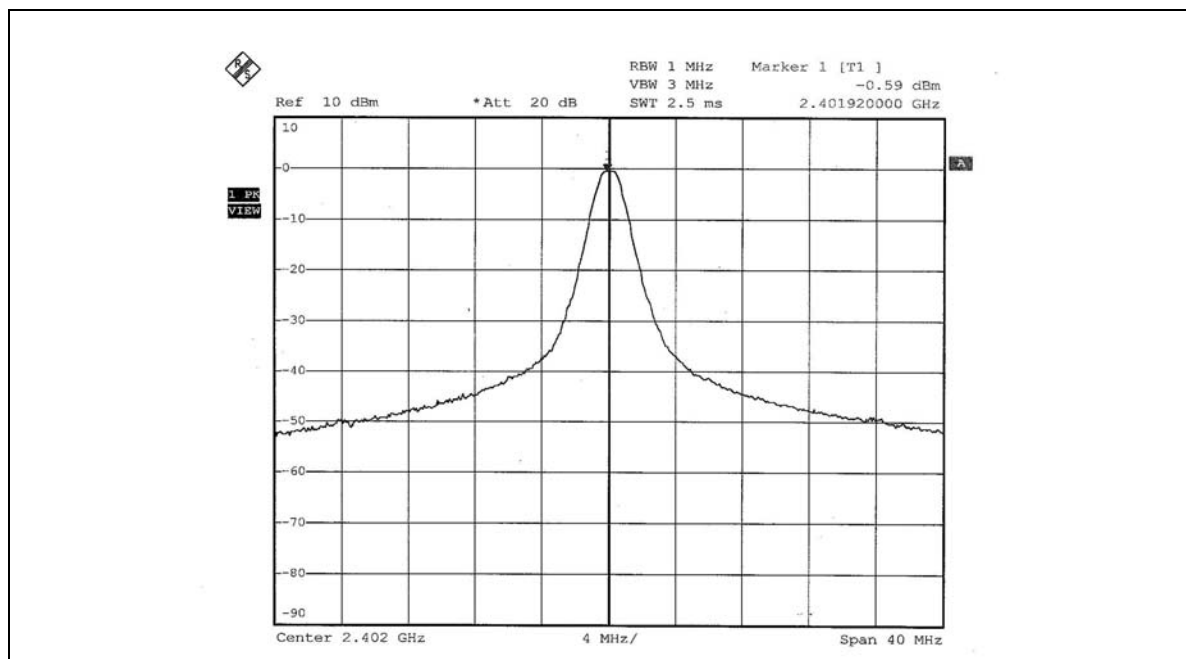

CH 39

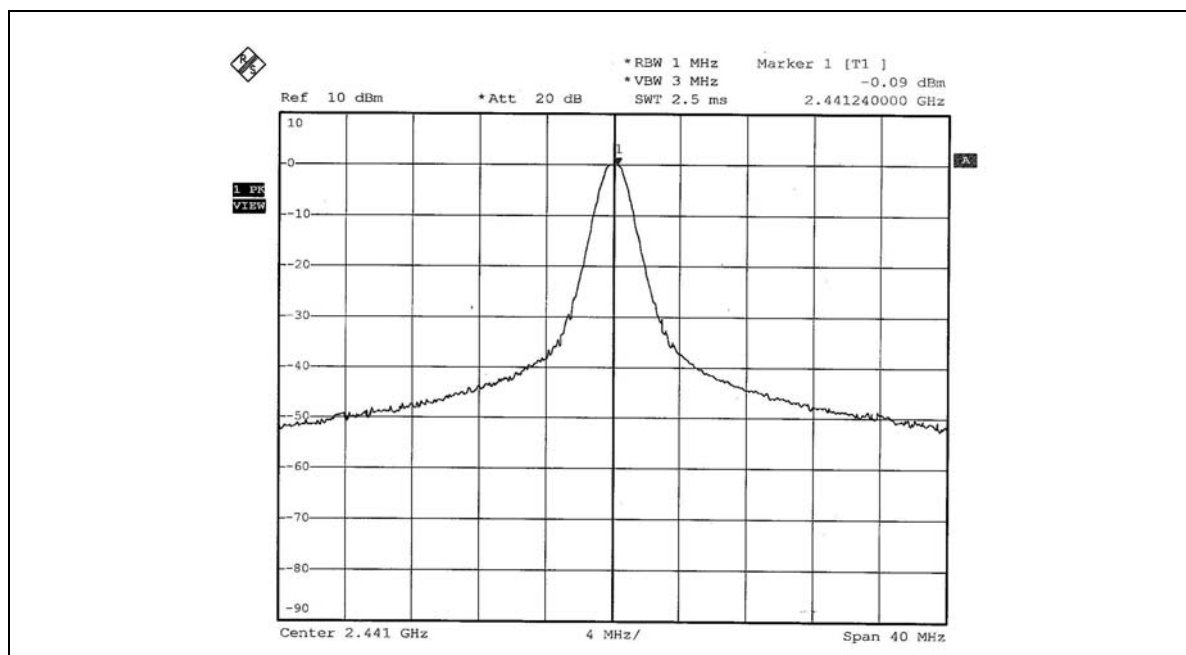



CH 78

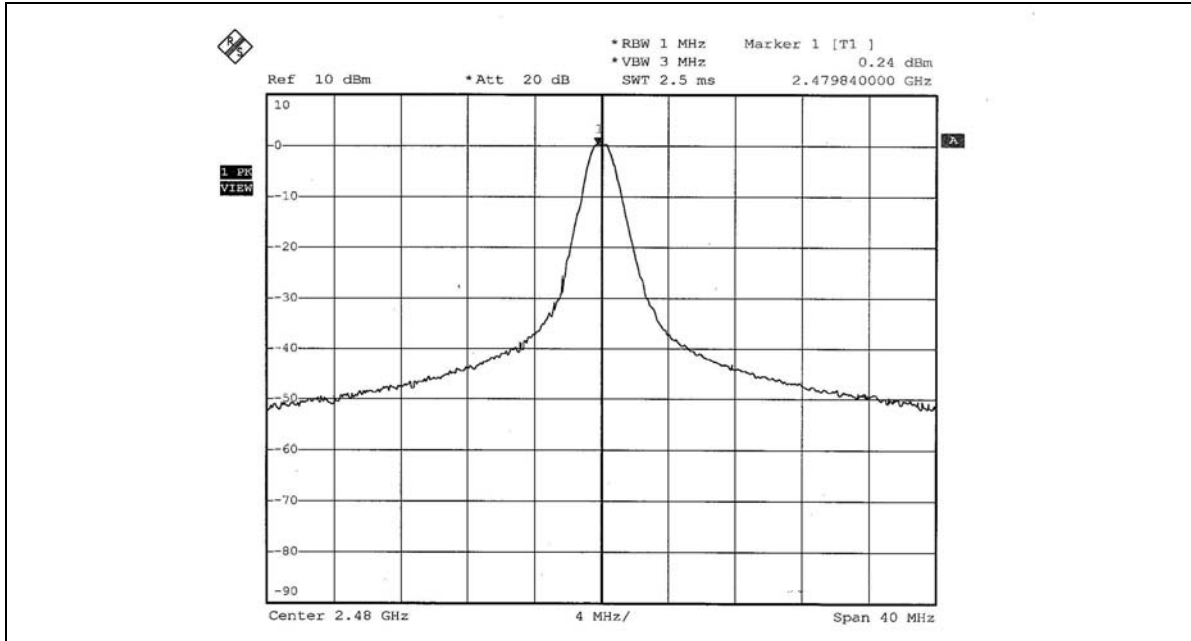



6.8 BAND EDGES MEASUREMENT

6.8.1 LIMITS OF BAND EDGES MEASUREMENT

Below -20dB of the highest emission level of operating band (in 100KHz RBW).

6.8.2 TEST INSTRUMENTS

DESCRIPTION & MANUFACTURER	MODEL NO.	SERIAL NO.	CALIBRATED UNTIL
SPECTRUM ANALYZER	FSEK30	100049	Aug. 14, 2006

NOTES: The calibration interval of the above test instruments is 12 months. And the calibrations are traceable to NML/ROC and NIST/USA.

6.8.3 TEST PROCEDURE

The transmitter output was connected to the spectrum analyzer via a low lose cable. Set both RBW and VBW of spectrum analyzer to 100 kHz with suitable frequency span including 100 MHz bandwidth from band edge. The band edges was measured and recorded.

6.8.4 DEVIATION FROM TEST STANDARD

No deviation.

6.8.5 EUT OPERATING CONDITION

The software provided by client enabled the EUT to transmit and receive data at lowest, middle and highest channel frequencies individually.



6.8.6 TEST RESULTS

The spectrum plots are attached on the following 4 images. D1 line indicates the highest level, D2 line indicates the 20dB offset below D1. It shows compliance with the requirement in part 15.247(d).

NOTE 1:

The band edge emission plot on page 164 shows 56.92dBc between carrier maximum power and local maximum emission in restrict band (2.3714GHz). The emission of carrier strength list in the test result of channel 0 at the item 6.2.7 is 91.97dBuV/m (Peak), so the maximum field strength in restrict band is $91.97-56.92=35.05$ dBuV/m, which is under 74 dBuV/m limit.

The band edge emission plot on page 164 shows 56.92dBc between carrier maximum power and local maximum emission in restrict band (2.3714GHz). The emission of carrier strength list in the test result of channel 0 at the item 6.2.7 is 61.97dBuV/m (Average), so the maximum field strength in restrict band is $61.97-56.92=5.05$ dBuV/m, which is under 54 dBuV/m limit.

NOTE 2:

The band edge emission plot on page 165 shows 53.66dBc between carrier maximum power and local maximum emission in restrict band (2.4839GHz). The emission of carrier strength list in the test result of channel 78 at the item 6.2.7 is 93.42dBuV/m (Peak), so the maximum field strength in restrict band is $93.42-53.66=39.76$ dBuV/m, which is under 74 dBuV/m limit.

The band edge emission plot on page 165 shows 53.66dBc between carrier maximum power and local maximum emission in restrict band (2.4839GHz). The emission of carrier strength list in the test result of channel 78 at the item 6.2.7 is 63.42dBuV/m (Average), so the maximum field strength in restrict band is $63.42-53.66=9.76$ dBuV/m, which is under 54 dBuV/m limit.

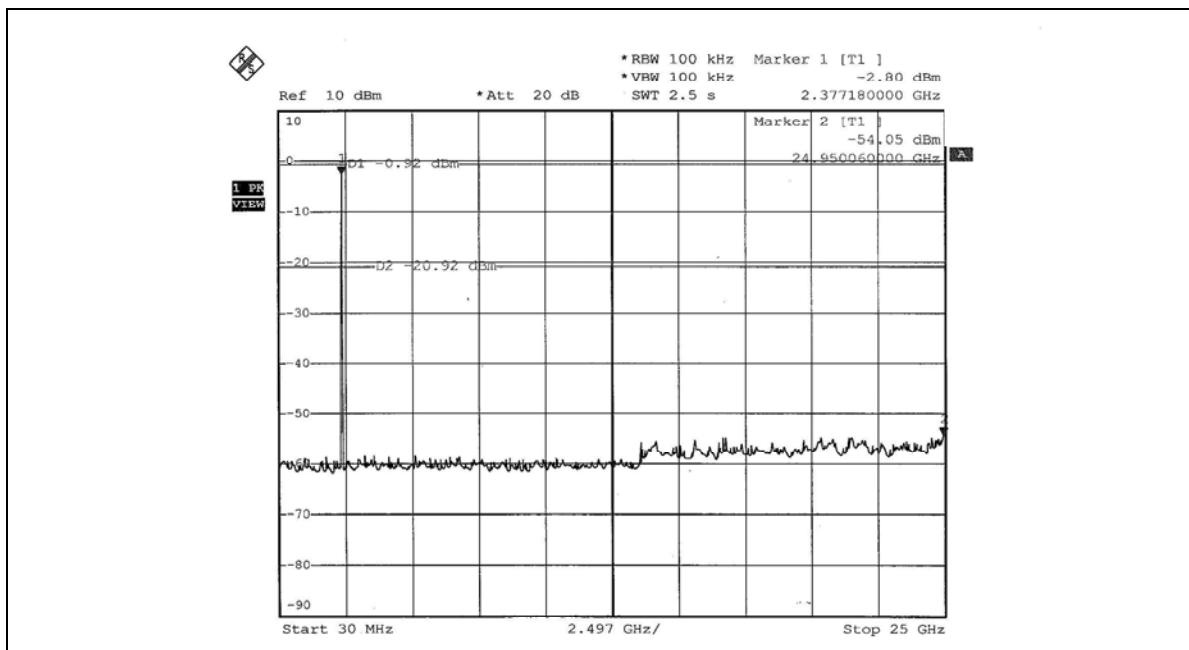
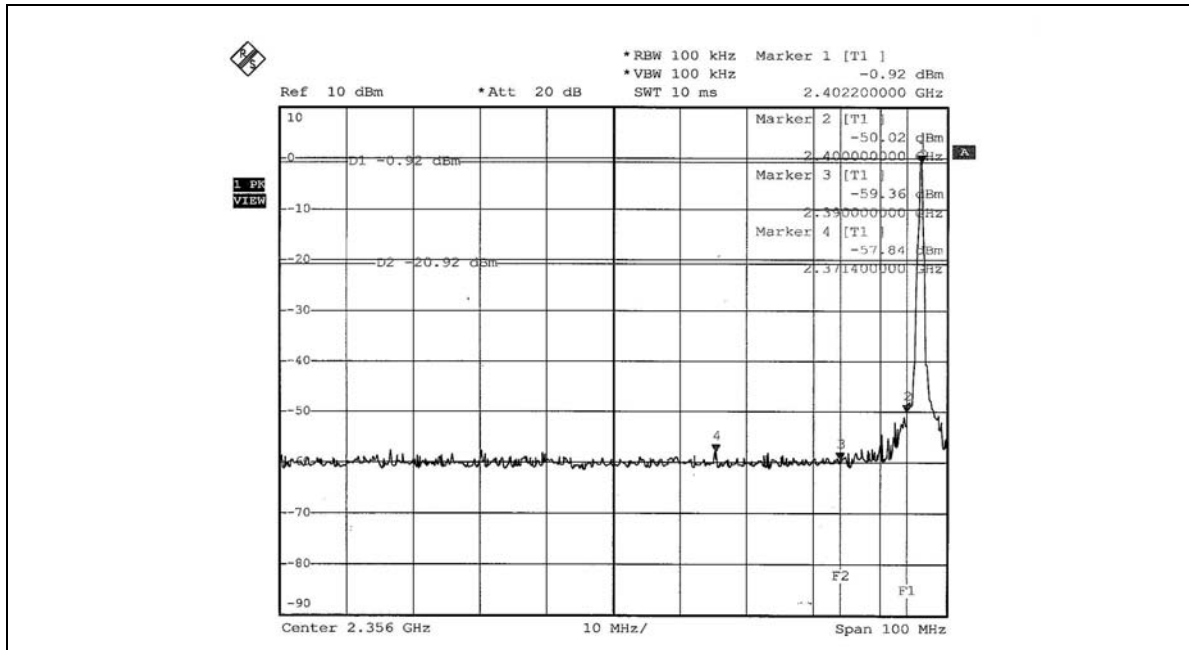

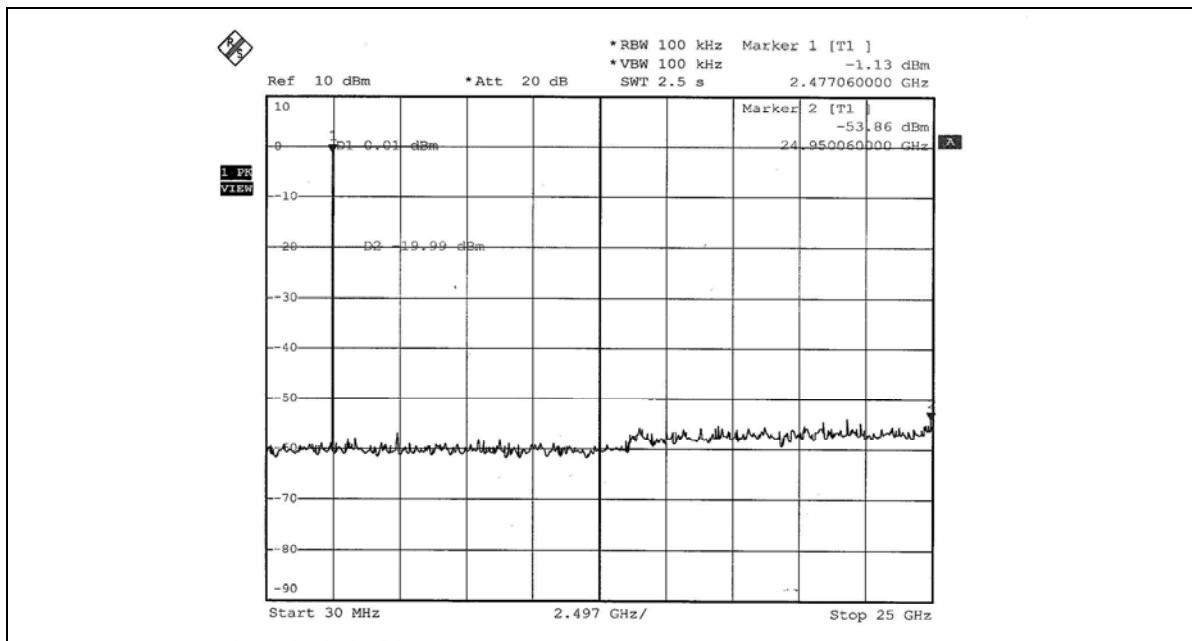
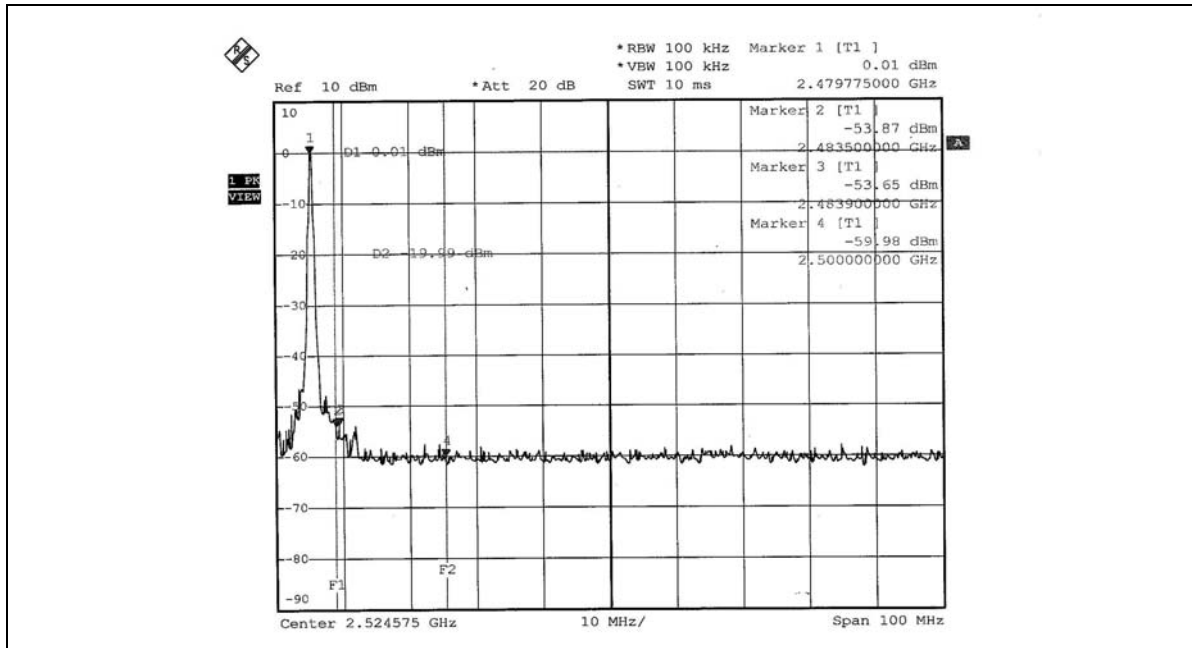



6.9 ANTENNA REQUIREMENT

6.9.1 STANDARD APPLICABLE

For intentional device, according to FCC 47 CFR Section 15.203, an intentional radiator shall be designed to ensure that no antenna other than that furnished by the responsible party shall be used with the device.

And according to FCC 47 CFR Section 15.247 (b), if transmitting antennas of directional gain greater than 6 dBi are used, the power shall be reduced by the amount in dB that the directional gain of the antenna exceeds 6 dBi.

6.9.2 ANTENNA CONNECTED CONSTRUCTION

The antenna used in this product is Chip antenna without antenna connector. The maximum gain of this antenna is 2.0dBi.



7. INFORMATION ON THE TESTING LABORATORIES

We, ADT Corp., were founded in 1988 to provide our best service in EMC, Radio, Telecom and Safety consultation. Our laboratories are accredited and approved by the following approval agencies according to ISO/IEC 17025.

USA	FCC, NVLAP, UL, A2LA
Germany	TUV Rheinland
Japan	VCCI
Norway	NEMKO
Canada	INDUSTRY CANADA , CSA
R.O.C.	CNLA, BSMI, DGT
Netherlands	Telefication
Singapore	PSB , GOST-ASIA(MOU)
Russia	CERTIS(MOU)

Copies of accreditation certificates of our laboratories obtained from approval agencies can be downloaded from our web site:

www.adt.com.tw/index.5/phtml. If you have any comments, please feel free to contact us at the following:

Linko EMC/RF Lab:

Tel: 886-2-26052180

Fax: 886-2-26052943

Hsin Chu EMC/RF Lab:

Tel: 886-3-5935343

Fax: 886-3-5935342

Hwa Ya EMC/RF/Safety Telecom Lab:

Tel: 886-3-3183232

Fax: 886-3-3185050

Linko RF Lab.

Tel: 886-3-3270910

Fax: 886-3-3270892

Web Site: www.adt.com.tw

The address and road map of all our labs can be found in our web site also.



APPENDIX-A

MODIFICATIONS RECORDERS FOR ENGINEERING CHANGES TO THE EUT BY THE LAB

No any modifications are made to the EUT by the lab during the test.