



Specific Absorption Rate (SAR) Test Report
for
Symbol Technologies Inc
on the
EDA (Enterprise Digital Assistant)

Report No. : FA840317B
Trade Name : Symbol
Model Name : MC5574
FCC ID : H9PMC5574
Date of Testing : Apr. 09 and 11, 2008
Date of Report : Apr. 14, 2008
Date of Review : Apr. 14, 2008

- The test results refer exclusively to the presented test model / sample only.
- Without written approval of SPORTON International Inc., the test report shall not be reproduced except in full.
- Report Version: Rev. 01

SPORTON International Inc.

No. 52, Hwa Ya 1st Rd., Hwa Ya Technology Park, Kwei-Shan Hsiang, Tao Yuan Hsien, Taiwan, R.O.C.



Table of Contents

- 1. **Statement of Compliance**1
- 2. **Administration Data**2
 - 2.1 Testing Laboratory2
 - 2.2 Detail of Applicant.....2
 - 2.3 Detail of Manufacturer2
 - 2.4 Application Details2
- 3. **General Information**3
 - 3.1 Description of Device Under Test (DUT).....3
 - 3.2 Basic Description of Equipment under Test4
 - 3.3 Product Photos5
 - 3.4 Applied Standards6
 - 3.5 Device Category and SAR Limits7
 - 3.6 Test Conditions7
 - 3.6.1 Ambient Condition7
 - 3.6.2 Test Configuration.....7
- 4. **Specific Absorption Rate (SAR)**.....8
 - 4.1 Introduction.....8
 - 4.2 SAR Definition8
- 5. **SAR Measurement Setup**9
 - 5.1 DASY4 E-Field Probe System.....10
 - 5.1.1 ET3DV6 E-Field Probe Specification11
 - 5.1.2 ET3DV6 E-Field Probe Calibration11
 - 5.2 DATA Acquisition Electronics (DAE)12
 - 5.3 Robot.....12
 - 5.4 Measurement Server12
 - 5.5 SAM Twin Phantom13
 - 5.6 Device Holder for SAM Twin Phantom14
 - 5.7 Data Storage and Evaluation.....15
 - 5.7.1 Data Storage.....15
 - 5.7.2 Data Evaluation15
 - 5.8 Test Equipment List17
- 6. **Tissue Simulating Liquids**.....18
- 7. **Uncertainty Assessment**20
- 8. **SAR Measurement Evaluation**22
 - 8.1 Purpose of System Performance check22
 - 8.2 System Setup22
 - 8.3 Validation Results24
- 9. **Description for DUT Testing Position**.....25
- 10. **Measurement Procedures**27
 - 10.1 Spatial Peak SAR Evaluation.....27
 - 10.2 Scan Procedures28
 - 10.3 SAR Averaged Methods28
- 11. **SAR Test Results**.....29
 - 11.1 Right Cheek.....29
 - 11.2 Right Tilted29
 - 11.3 Left Cheek29
 - 11.4 Left Tilted.....29
 - 11.5 Front Face with 0cm Gap30
 - 11.6 Rear Face with 0cm Gap.....30
- 12. **References**.....31

Appendix A - System Performance Check Data
Appendix B - SAR Measurement Data
Appendix C - Calibration Data
Appendix D - Product Photos
Appendix E - Test Setup Photos



1. Statement of Compliance

The Specific Absorption Rate (SAR) maximum results found during testing for the **Symbol Technologies Inc EDA (Enterprise Digital Assistant) Symbol MC5574** are as follows (with expanded uncertainty 21.9%):

Position	802.11b/g (W/Kg)
Head	0.431
Body	0.519

Remark :

1. The Volume Scan of GSM850 CH251 and 802.11g CH06 for head SAR is 1.34 W/kg and its position is right tilted.
2. The Volume Scan of GSM1900 CH512 and 802.11g CH06 for head SAR is 0.649 W/kg and its position is left tilted.
3. The Volume Scan of GSM850 CH251 and 802.11g CH06 for head SAR is 1.30 W/kg and its position is front face with 0cm gap.
4. The Volume Scan of GSM1900 CH512 and 802.11g CH06 for head SAR is 0.805 W/kg and its position is front face with 0cm gap.

They are in compliance with Specific Absorption Rate (SAR) for general population/uncontrolled exposure limits specified in FCC 47 CFR part 2 (2.1093) and ANSI/IEEE C95.1-1999 and had been tested in accordance with the measurement methods and procedures specified in OET Bulletin 65 Supplement C (Edition 01-01).

Approved by

Roy Wu
Manager



2. Administration Data

2.1 Testing Laboratory

Company Name : Sporton International Inc.
Department : Antenna Design/SAR
Address : No.52, Hwa-Ya 1st RD., Hwa Ya Technology Park, Kwei-Shan Hsiang,
TaoYuan Hsien, Taiwan, R.O.C.
Telephone Number : 886-3-327-3456
Fax Number : 886-3-328-4978

2.2 Detail of Applicant

Company Name : Symbol Technologies Inc
Address : One Symbol Plaza Holtsville, NY 11742 -1300 United States

2.3 Detail of Manufacturer

Company Name : ASKEY COMPUYER CORP.
Address : 10F, No. 119, CHIENKANG RD., CHUNG-HO, TAIPEI, TAIWAN, 235, R.O.C

2.4 Application Details

Date of reception of application: Apr. 03, 2008
Start of test : Apr. 09, 2008
End of test : Apr. 11, 2008



3. General Information

3.1 Description of Device Under Test (DUT)

Product Feature & Specification	
DUT Type :	EDA (Enterprise Digital Assistant)
Trade Name :	Symbol
Model Name :	MC5574
FCC ID :	H9PMC5574
Tx Frequency :	GSM850 : 824 MHz ~ 849 MHz GSM1900 : 1850 MHz ~1910 MHz Bluetooth : 2400 MHz ~ 2483.5 MHz WLAN : 2400 MHz ~ 2483.5 MHz
Rx Frequency :	GSM850 : 869 MHz ~ 894 MHz GSM1900 : 1930 MHz ~ 1990 MHz Bluetooth : 2400 MHz ~ 2483.5 MHz WLAN : 2400 MHz ~ 2483.5 MHz
Maximum Output Power to Antenna :	GSM850 : 32.43 dBm (GSM) / 32.41 dBm (GPRS8) / 30.62 dBm (GPRS10) / 26.87 dBm (GPRS12) / 25.94 dBm (EGPRS8) / 23.83 dBm (EGPRS10) / 19.67 dBm (EGPRS12) / GSM1900 : 29.50 dBm (GSM) / 29.39 dBm (GPRS8) / 27.55 dBm (GPRS10) / 23.79 dBm (GPRS12) / 25.06 dBm (EGPRS8) / 23.26 dBm (EGPRS10) / 19.22 dBm (EGPRS12) / Bluetooth : 4.76 dBm WLAN : 14.57 dBm (802.11b) / 15.52 dBm (802.11g)
Antenna Type :	GSM : PIFA Antenna Bluetooth : Chip antenna WLAN : PIFA Antenna
Antenna Gain :	Bluetooth : -0.94 dBi WLAN : 1.22 dBi
Power Rating (DC/AC , Voltage and Current of RF element or PA) :	GSM : DC 3.8V / 2A
GPRS / EGPRS Multislot class :	12
Type of Modulation :	GSM / GPRS : GMSK EDGE : 8PSK Bluetooth : GFSK WLAN : DSSS / OFDM
DUT Stage :	Identical Prototype

3.2 Basic Description of Equipment under Test

Equipment	EDA (Enterprise Digital Assistant)	
Trade Name	Symbol	
Model Name	MC5574	
FCC ID	H9PMC5574	
Sample A	1D scanner without camera	
Sample B	2D scanner without camera	
Sample C	1D scanner with camera	
Sample D	2D scanner with camera	
AC Adapter	Brand Name	DELTA
	Model Name	ADP-16GB
	Power Rating	I/P: 100-240Vac, 50-60Hz, 0.4A; O/P: 5.4Vdc, 3A
	AC Power Cord Type	AC: 1.8 meter non-shielded cable with ferrite core DC: 1.8 meter non-shielded cable without ferrite core
Battery	Brand Name	SYMBOL
	Part Number	82-107172-01 Rev A
	Power Rating	3.7Vdc, 2400mAh
	Type	Li-ion
Communication USB charge cable	Brand Name	SYMBOL
	Part Number	25-108022-01R Rev. 1
	Signal Line Type	1.5 meter shielded cable without ferrite core

Remark: Above EUT's information was declared by manufacturer. Please refer to the specifications of manufacturer or User's Manual for more detailed features description.



3.3 Product Photos

Please refer to Appendix D.



3.4 Applied Standards

The Specific Absorption Rate (SAR) testing specification, method and procedure for this EDA (Enterprise Digital Assistant) is in accordance with the following standards:

47 CFR Part 2 (2.1093),
IEEE C95.1-1999,
IEEE C95.3-2002,
IEEE P1528-2003, and
OET Bulletin 65 Supplement C (Edition 01-01)



3.5 Device Category and SAR Limits

This device belongs to portable device category because its radiating structure is allowed to be used within 20 centimeters of the body of the user.

Limit for General Population/Uncontrolled exposure should be applied for this device, it is 1.6 W/kg as averaged over any 1 gram of tissue.

3.6 Test Conditions

3.6.1 Ambient Condition

Item	HSL_2450	MSL_2450
Ambient Temperature (°C)	20-24	
Tissue simulating liquid temperature (°C)	21.5°C	21.6°C
Humidity (%)	<60 %	

3.6.2 Test Configuration

The DUT was set from the emulator to radiate maximum output power during all tests.

For WLAN link mode, engineering testing software installed on the EUT can provide continuous transmitting RF signal. This RF signal utilized in SAR measurement has almost 100% duty cycle and its crest factor is 1. Measurements were performed on the lowest, middle, and highest channel for each testing position. However, measurements were performed only on the middle channel if the SAR is below 3 dB of limit for body SAR testing.

The data rates for WLAN SAR testing were set in 2Mbps for 802.11b and 6Mbps for 802.11g due to the highest RF output power. Power table of 802.11b/g as below:

<802.11b>

Channel	Frequency (MHz)	Data Rate			
		1M bps	2M bps	5.5M bps	11M bps
CH 01	2412 MHz	14.22	14.57	14.54	14.49
CH 06	2437 MHz	14.21	14.33	14.44	14.38
CH 11	2462 MHz	13.52	13.56	14.16	14.13

<802.11g>

Channel	Frequency (MHz)	Data Rate							
		6M bps	9M bps	12M bps	18M bps	24M bps	36M bps	48M bps	54M bps
CH 01	2412 MHz	11.96	11.67	11.61	11.71	11.82	11.93	11.97	11.98
CH 06	2437 MHz	15.52	15.18	14.95	15.16	14.37	14.46	13.57	13.60
CH 11	2462 MHz	11.81	11.66	11.78	11.78	11.77	11.86	11.81	11.70

4. Specific Absorption Rate (SAR)

4.1 Introduction

SAR is related to the rate at which energy is absorbed per unit mass in an object exposed to a radio field. The SAR distribution in a biological body is complicated and is usually carried out by experimental techniques or numerical modeling. The standard recommends limits for two tiers of groups, occupational/controlled and general population/uncontrolled, based on a person's awareness and ability to exercise control over his or her exposure. In general, occupational/controlled exposure limits are higher than the limits for general population/uncontrolled.

4.2 SAR Definition

The SAR definition is the time derivative (rate) of the incremental energy (dW) absorbed by (dissipated in) an incremental mass (dm) contained in a volume element (dv) of a given density.

). The equation description is as below:

$$\mathbf{SAR} = \frac{d}{dt} \left(\frac{dW}{dm} \right) = \frac{d}{dt} \left(\frac{dW}{\rho dv} \right)$$

SAR is expressed in units of Watts per kilogram (W/kg)

SAR measurement can be either related to the temperature elevation in tissue by

$$\mathbf{SAR} = C \frac{\delta T}{\delta t}$$

, where C is the specific heat capacity, δT is the temperature rise and δt the exposure duration,

or related to the electrical field in the tissue by

$$\mathbf{SAR} = \frac{\sigma |E|^2}{\rho}$$

, where σ is the conductivity of the tissue, ρ is the mass density of the tissue and E is the rms electrical field strength.

However for evaluating SAR of low power transmitter, electrical field measurement is typically applied.

5. SAR Measurement Setup

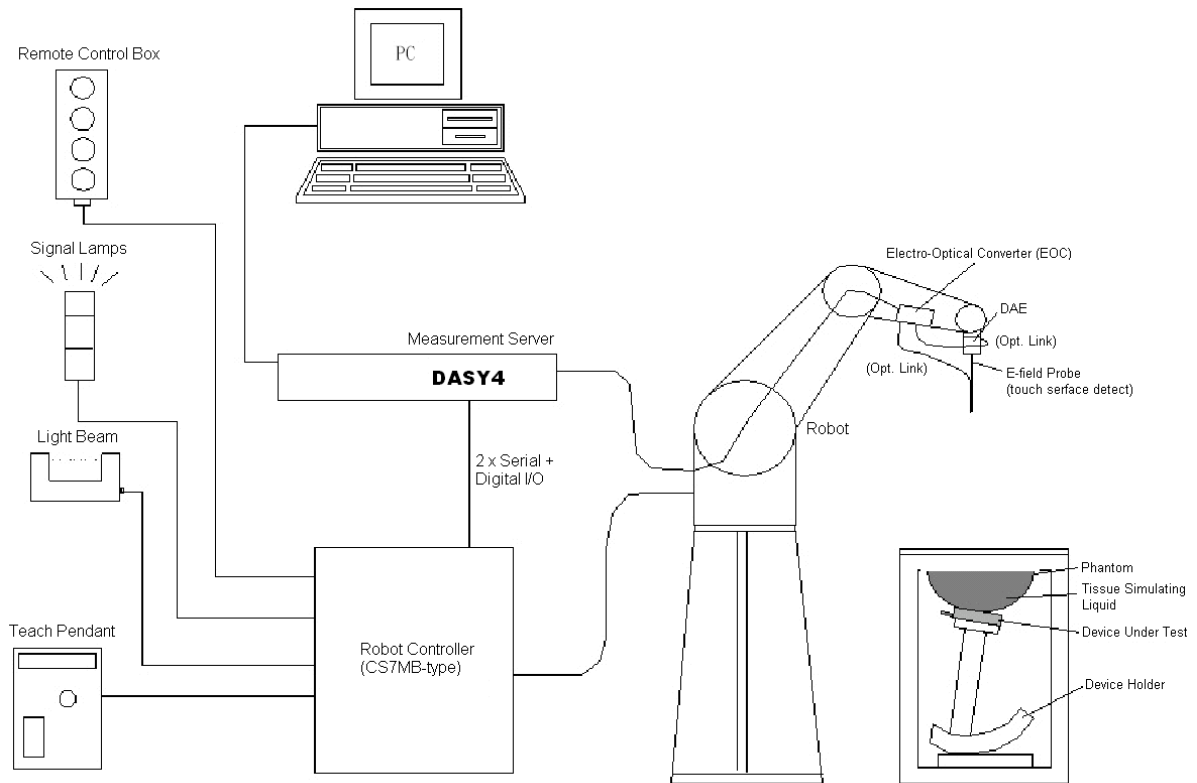

Fig. 5.1 DASY4 System



The DASY4 system for performance compliance tests is illustrated above graphically. This system consists of the following items:

- A standard high precision 6-axis robot with controller, a teach pendant and software
- A data acquisition electronic (DAE) attached to the robot arm extension
- A dosimetric probe equipped with an optical surface detector system
- The electro-optical converter (ECO) performs the conversion between optical and electrical signals
- A measurement server performs the time critical tasks such as signal filtering, control of the robot operation and fast movement interrupts.
- A probe alignment unit which improves the accuracy of the probe positioning
- A computer operating Windows XP
- DASY4 software
- Remote control with teach pendant and additional circuitry for robot safety such as warning lamps, etc.
- The SAM twin phantom
- A device holder
- Tissue simulating liquid
- Dipole for evaluating the proper functioning of the system

Some of the components are described in details in the following sub-sections.

5.1 DASY4 E-Field Probe System

The SAR measurement is conducted with the dosimetric probe ET3DV6 (manufactured by SPEAG). The probe is specially designed and calibrated for use in liquid with high permittivity. The dosimetric probe has special calibration in liquid at different frequency. This probe has a built in optical surface detection system to prevent from collision with phantom.

5.1.1 ET3DV6 E-Field Probe Specification

<ET3DV6>

Construction Symmetrical design with triangular core
 Built-in optical fiber for surface detection system
 Built-in shielding against static charges
 PEEK enclosure material (resistant to organic solvents)

Frequency 10 MHz to 3 GHz

Directivity ± 0.2 dB in brain tissue (rotation around probe axis)
 ± 0.4 dB in brain tissue (rotation perpendicular to probe axis)

Dynamic Range 5 μ W/g to 100mW/g; Linearity: ±0.2dB

Surface Detection ± 0.2 mm repeatability in air and clear liquids on reflecting surface

Dimensions Overall length: 330mm
 Tip length: 16mm
 Body diameter: 12mm
 Tip diameter: 6.8mm
 Distance from probe tip to dipole centers: 2.7mm

Application General dosimetry up to 3GHz
 Compliance tests for mobile phones and Wireless LAN
 Fast automatic scanning in arbitrary phantoms



Fig. 5.2 Probe Setup on Robot

5.1.2 ET3DV6 E-Field Probe Calibration

Each probe needs to be calibrated according to a dosimetric assessment procedure with accuracy better than ± 10%. The spherical isotropy shall be evaluated and within ± 0.25dB. The sensitivity parameters (NormX, NormY, and NormZ), the diode compression parameter (DCP) and the conversion factor (ConvF) of the probe are tested. The calibration data are as below:

➤ **ET3DV6 sn1787**

Sensitivity	X axis : 1.63 μV	Y axis : 1.66 μV	Z axis : 2.08 μV	
Diode compression point	X axis : 92 mV	Y axis : 96 mV	Z axis : 91 mV	
Conversion factor (Head / Body)	Frequency (MHz)	X axis	Y axis	Z axis
	2350~2550	4.50 / 4.02	4.50 / 4.02	4.50 / 4.02
Boundary effect (Head / Body)	Frequency (MHz)	Alpha	Depth	
	2350~2550	0.67 / 0.65	1.81 / 2.15	

NOTE: The probe parameters have been calibrated by the SPEAG.

5.2 DATA Acquisition Electronics (DAE)

The data acquisition electronics (DAE4) consists of a highly sensitive electrometer-grade preamplifier with auto-zeroing, a channel and gain-switching multiplexer, a fast 16 bit AD-converter and a command decoder and control logic unit. Transmission to the measurement server is accomplished through an optical downlink for data and status information as well as an optical uplink for commands and the clock.

The mechanical probe mounting device includes two different sensor systems for frontal and sideways probe contacts. They are used for mechanical surface detection and probe collision detection.

The input impedance of the DAE4 is 200M Ohm; the inputs are symmetrical and floating. Common mode rejection is above 80dB.

5.3 Robot

The DASY4 system uses the high precision robots RX90BL type out of the newer series from Stäubli SA (France). For the 6-axis controller DASY4 system, the CS7MB robot controller version from Stäubli is used. The RX robot series have many features that are important for our application:

- High precision (repeatability 0.02 mm)
- High reliability (industrial design)
- Jerk-free straight movements
- Low ELF interference (the closed metallic construction shields against motor control fields)
- 6-axis controller

5.4 Measurement Server

The DASY4 measurement server is based on a PC/104 CPU board with
166 MHz CPU
32 MB chipset and
64 MB RAM.

Communication with
the DAE4 electronic box
the 16-bit AD-converter system for optical detection and digital I/O interface.

The measurement server performs all the real-time data evaluation for field measurements and surface detection, controls robot movements and handles safety operations.

5.5 SAM Twin Phantom

The SAM twin phantom is a fiberglass shell phantom with 2mm shell thickness (except the ear region where shell thickness increases to 6mm). It has three measurement areas:

- Left head
- Right head
- Flat phantom

The bottom plate contains three pair of bolts for locking the device holder. The device holder positions are adjusted to the standard measurement positions in the three sections. A white cover is provided to tap the phantom during off-periods to prevent water evaporation and changes in the liquid parameters. On the phantom top, three reference markers are provided to identify the phantom position with respect to the robot.

The phantom can be used with the following tissue simulating liquids:

- *Water-sugar based liquid
- *Glycol based liquids

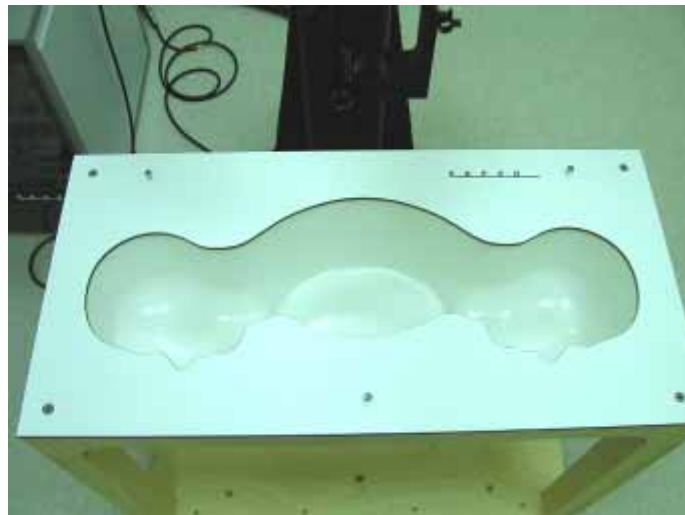

Fig. 5.3 Top View of Twin Phantom



Fig. 5.4 Bottom View of Twin Phantom

5.6 Device Holder for SAM Twin Phantom

The SAR in the Phantom is approximately inversely proportional to the square of the distance between the source and the liquid surface. For a source in 5 mm distance, a positioning uncertainty of $\pm 0.5\text{mm}$ would produce a SAR uncertainty of $\pm 20\%$. An accurate device position is therefore crucial for accurate and repeatable measurement. The position in which the devices must be measured, are defined by the standards.

The DASY4 device holder is designed to cope with different positions given in the standard. It has two scales for the device rotation (with respect to the body axis) and the device inclination (with respect to the line between the ear reference points). The rotation centers for both scales is the ear reference point (EPR).

Thus the device needs no repositioning when changing the angles.

The DASY4 device holder has been made out of low-loss POM material having the following dielectric parameters: relative permittivity $\epsilon_r = 3$ and loss tangent $\delta = 0.02$. The amount of dielectric material has been reduced in the closest vicinity of the device, since measurements have suggested that the influence of the clamp on the test results could thus be lowered.



Fig. 5.5 Device Holder

5.7 Data Storage and Evaluation

5.7.1 Data Storage

The DASY4 software stores the assessed data from the data acquisition electronics as raw data (in microvolt readings from the probe sensors), together with all the necessary software parameters for the data evaluation (probe calibration data, liquid parameters and device frequency and modulation data) in measurement files with the extension .DA4. The post-processing software evaluates the desired unit and format for output each time the data is visualized or exported. This allows verification of the complete software setup even after the measurement and allows correction of erroneous parameter settings. For example, if a measurement has been performed with an incorrect crest factor parameter in the device setup, the parameter can be corrected afterwards and the data can be reevaluated.

The measured data can be visualized or exported in different units or formats, depending on the selected probe type (e.g., [V/m], [A/m], [mW/g]). Some of these units are not available in certain situations or give meaningless results, e.g., a SAR-output in a non-lossy media, will always be zero. Raw data can also be exported to perform the evaluation with other software packages.

5.7.2 Data Evaluation

The DASY4 post-processing software (SEMCAD) automatically executes the following procedures to calculate the field units from the microvolt readings at the probe connector. The parameters used in the evaluation are stored in the configuration modules of the software :

Probe parameters :	- Sensitivity	$Norm_i, a_{i0}, a_{i1}, a_{i2}$
	- Conversion factor	$ConvF_i$
	- Diode compression point	dcp_i
Device parameters :	- Frequency	f
	- Crest factor	cf
Media parameters :	- Conductivity	
	- Density	

These parameters must be set correctly in the software. They can be found in the component documents or they can be imported into the software from the configuration files issued for the DASY4 components. In the direct measuring mode of the multi-meter option, the parameters of the actual system setup are used. In the scan visualization and export modes, the parameters stored in the corresponding document files are used.

The first step of the evaluation is a linearization of the filtered input signal to account for the compression characteristics of the detector diode. The compensation depends on the input signal, the diode type and the DC-transmission factor from the diode to the evaluation electronics. If the exciting field is pulsed, the crest factor of the signal must be known to correctly compensate for peak power.

The formula for each channel can be given as :

$$V_i = U_i + U_i^2 \cdot \frac{cf}{dcp_i}$$

with $V_i =$ compensated signal of channel i ($i = x, y, z$)
 $U_i =$ input signal of channel i ($i = x, y, z$)
 $cf =$ crest factor of exciting field (DASY parameter)
 $dcp_i =$ diode compression point (DASY parameter)

From the compensated input signals, the primary field data for each channel can be evaluated :

E-field probes : $E_i = \sqrt{\frac{V_i}{Norm_i ConvF}}$

H-field probes : $H_i = \sqrt{V_i \frac{a_{i0} + a_{i1}f + a_{i2}f^2}{f}}$

with $V_i =$ compensated signal of channel i ($i = x, y, z$)
 $Norm_i =$ sensor sensitivity of channel i ($i = x, y, z$)
 $\mu V/(V/m)^2$ for E-field Probes
 $ConvF =$ sensitivity enhancement in solution
 $a_{ij} =$ sensor sensitivity factors for H-field probes
 $f =$ carrier frequency [GHz]
 $E_i =$ electric field strength of channel i in V/m
 $H_i =$ magnetic field strength of channel i in A/m

The RSS value of the field components gives the total field strength (Hermitian magnitude) :

$$E_{tot} = \sqrt{E_x^2 + E_y^2 + E_z^2}$$

The primary field data are used to calculate the derived field units.

$$SAR = E_{tot}^2 \cdot \frac{\sigma}{\rho \cdot 1000}$$

with $SAR =$ local specific absorption rate in mW/g
 $E_{tot} =$ total field strength in V/m
 $\sigma =$ conductivity in [mho/m] or [Siemens/m]
 $\rho =$ equivalent tissue density in g/cm³

* Note that the density is set to 1, to account for actual head tissue density rather than the density of the tissue simulating liquid.

The power flow density is calculated assuming the excitation field to be a free space field.

$$P_{pwe} = \frac{E_{tot}^2}{3770} \quad \text{or} \quad P_{pwe} = H_{tot}^2 \cdot 37.7$$

with $P_{pwe} =$ equivalent power density of a plane wave in mW/cm²
 $E_{tot} =$ total electric field strength in V/m
 $H_{tot} =$ total magnetic field strength in A/m



5.8 Test Equipment List

Manufacture	Name of Equipment	Type/Model	Serial Number	Calibration	
				Last Cal.	Due Date
SPEAG	Dosimetric E-Filed Probe	ET3DV6	1787	Aug. 28, 2007	Aug. 28, 2008
SPEAG	2450MHz System Validation Kit	D2450V2	736	Jul. 12, 2007	Jul. 12, 2009
SPEAG	Data Acquisition Electronics	DAE4	778	Sep. 17, 2007	Sep. 17, 2008
SPEAG	Device Holder	N/A	N/A	NCR	NCR
SPEAG	Phantom	QD 000 P40 C	TP-1303	NCR	NCR
SPEAG	Phantom	QD 000 P40 C	TP-1383	NCR	NCR
SPEAG	Phantom	QD 0VA 001 BB	1029	NCR	NCR
SPEAG	Robot	Staubli RX90BL	F03/5W15A1/A/01	NCR	NCR
SPEAG	Software	DASY4 V4.7 Build 55	N/A	NCR	NCR
SPEAG	Software	SEMCAD V1.8 Build 176	N/A	NCR	NCR
SPEAG	Measurement Server	SE UMS 001 BA	1021	NCR	NCR
Agilent	ENA Series Network Analyzer	E5071B	MY42403579	Apr. 09, 2008	Apr. 08, 2009
Agilent	Wireless Communication Test Set	E5515C	GB46311322	Dec. 22, 2006	Dec. 22, 2008
Agilent	Dielectric Probe Kit	85070D	US01440205	NCR	NCR
Agilent	Dual Directional Coupler	778D	50422	NCR	NCR
Agilent	Power Amplifier	8449B	3008A01917	NCR	NCR
Agilent	Power Meter	E4416A	GB41292344	Feb. 21, 2008	Feb. 20, 2009
Agilent	Power Sensor	E9327A	US40441548	Feb. 21, 2008	Feb. 20, 2009

Table 5.1 Test Equipment List

6. Tissue Simulating Liquids

For the measurement of the field distribution inside the SAM phantom with DASY4, the phantom must be filled with around 25 liters of homogeneous tissue simulating liquid. The liquid height from the ear reference point (ERP) of the phantom to the liquid top surface is (head SAR) or from the flat phantom to the liquid top surface (body SAR) is 15.2cm.

The following ingredients for tissue simulating liquid are used:

- **Water:** deionized water (pure H₂O), resistivity $\geq 16\text{M}\Omega$ - as basis for the liquid
- **Sugar:** refined sugar in crystals, as available in food shops – to reduce relative permittivity
- **Salt:** pure NaCl – to increase conductivity
- **Cellulose:** Hydroxyethyl-cellulose, medium viscosity (75-125 mPa.s, 2% in water, 20°C), CAS#54290-to increase viscosity and to keep sugar in solution.
- **Preservative:** Preventol D-7 Bayer AG, D-51368 Leverkusen, CAS#55965-84-9- to prevent the spread of bacteria and molds.
- **DGMBE:** Deithlenglycol-monobuthyl ether (DGMBE), Fluka Chemie GmbH, CAS#112-34-5 – to reduce relative permittivity.

Table 6.1 gives the recipes for one liter of head and body tissue simulating liquid for frequency band 2450 MHz.

Ingredient	HSL-2450	MSL-2450
Water	550.0 ml	698.3 ml
Cellulose	0 g	0 g
Salt	0 g	0 g
Preventol D-7	0 g	0 g
Sugar	0 g	0 g
DGMBE	450.0 ml	301.7 ml
Total amount	1 liter (1.0 kg)	1 liter (1.0 kg)
Dielectric Parameters at 22°	f = 2450MHz $\epsilon_r = 39 \pm 5\%$, $\sigma = 1.84 \pm 5\%$ S/m	f = 2450MHz $\epsilon_r = 52.7 \pm 5\%$, $\sigma = 1.95 \pm 5\%$ S/m

Table 6.1 Recipes for Tissue Simulating Liquid

The dielectric parameters of the liquids were verified prior to the SAR evaluation using an Agilent 85070D Dielectric Probe Kit and an Agilent Network Analyzer.



Table 6.2 shows the measuring results for head and muscle simulating liquid.

Band	Position	Frequency (MHz)	Permittivity (ϵ_r)	Conductivity (σ)	Measurement Date
802.11b/g (2400~2450 MHz)	Head	2412	37.9	1.81	Apr. 11, 2008
		2437	37.8	1.83	
		2462	37.7	1.86	
	Body	2412	53.5	1.92	Apr. 09, 2008
		2437	53.4	1.96	
		2462	53.3	1.99	

Table 6.2 Measuring Results for Simulating Liquid

The measuring data are consistent with $\epsilon_r = 39.2 \pm 5\%$, $\sigma = 1.80 \pm 5\%$ for head 2450 MHz and $\epsilon_r = 52.7 \pm 5\%$, $\sigma = 1.95 \pm 5\%$ for body 2450 MHz.

7. Uncertainty Assessment

The component of uncertainty may generally be categorized according to the methods used to evaluate them. The evaluation of uncertainty by the statistical analysis of a series of observations is termed a Type A evaluation of uncertainty. The evaluation of uncertainty by means other than the statistical analysis of a series of observation is termed a Type B evaluation of uncertainty. Each component of uncertainty, however evaluated, is represented by an estimated standard deviation, termed standard uncertainty, which is determined by the positive square root of the estimated variance.

A Type A evaluation of standard uncertainty may be based on any valid statistical method for treating data. This includes calculating the standard deviation of the mean of a series of independent observations; using the method of least squares to fit a curve to the data in order to estimate the parameter of the curve and their standard deviations; or carrying out an analysis of variance in order to identify and quantify random effects in certain kinds of measurement.

A type B evaluation of standard uncertainty is typically based on scientific judgment using all of the relevant information available. These may include previous measurement data, experience and knowledge of the behavior and properties of relevant materials and instruments, manufacture’s specification, data provided in calibration reports and uncertainties assigned to reference data taken from handbooks. Broadly speaking, the uncertainty is either obtained from an outdoor source or obtained from an assumed distribution, such as the normal distribution, rectangular or triangular distributions indicated in Table 7.1

Uncertainty Distributions	Normal	Rectangular	Triangular	U-shape
Multiplying factor ^(a)	1/k ^(b)	1/ 3	1/ 6	1/ 2

(a) standard uncertainty is determined as the product of the multiplying factor and the estimated range of variations in the measured quantity

(b) is the coverage factor

Table 7.1 Multiplying Factions for Various Distributions

The combined standard uncertainty of the measurement result represents the estimated standard deviation of the result. It is obtained by combining the individual standard uncertainties of both Type A and Type B evaluation using the usual “root-sum-squares” (RSS) methods of combining standard deviations by taking the positive square root of the estimated variances.

Expanded uncertainty is a measure of uncertainty that defines an interval about the measurement result within which the measured value is confidently believed to lie. It is obtained by multiplying the combined standard uncertainty by a coverage factor. Typically, the coverage factor ranges from 2 to 3. Using a coverage factor allows the true value of a measured quantity to be specified with a defined probability within the specified uncertainty range. For purpose of this document, a coverage factor two is used, which corresponds to confidence interval of about 95 %. The DASY4 uncertainty Budget is showed in Table 7.2.



Error Description	Uncertainty Value ± %	Probability Distribution	Divisor	Ci (1g)	Standard Unc. (1g)	vi or Veff
Measurement Equipment						
Probe Calibration	±5.9 %	Normal	1	1	±5.9 %	∞
Axial Isotropy	±4.7 %	Rectangular	√3	0.7	±1.9 %	∞
Hemispherical Isotropy	±9.6 %	Rectangular	√3	0.7	±3.9 %	∞
Boundary Effects	±1.0 %	Rectangular	√3	1	±0.6 %	∞
Linearity	±4.7 %	Rectangular	√3	1	±2.7 %	∞
System Detection Limits	±1.0 %	Rectangular	√3	1	±0.6 %	∞
Readout Electronics	±0.3 %	Normal	1	1	±0.3 %	∞
Response Time	±0.8 %	Rectangular	√3	1	±0.5 %	∞
Integration Time	±2.6 %	Rectangular	√3	1	±1.5 %	∞
RF Ambient Noise	±3.0 %	Rectangular	√3	1	±1.7 %	∞
RF Ambient Reflections	±3.0 %	Rectangular	√3	1	±1.7 %	∞
Probe Positioner	±0.4 %	Rectangular	√3	1	±0.2 %	∞
Probe Positioning	±2.9 %	Rectangular	√3	1	±1.7 %	∞
Max. SAR Eval.	±1.0 %	Rectangular	√3	1	±0.6 %	∞
Test Sample Related						
Device Positioning	±2.9 %	Normal	1	1	±2.9	145
Device Holder	±3.6 %	Normal	1	1	±3.6	5
Power Drift	±5.0 %	Rectangular	√3	1	±2.9	∞
Phantom and Setup						
Phantom Uncertainty	±4.0 %	Rectangular	√3	1	±2.3	∞
Liquid Conductivity (target)	±5.0 %	Rectangular	√3	0.64	±1.8	∞
Liquid Conductivity (meas.)	±2.5 %	Normal	1	0.64	±1.6	∞
Liquid Permittivity (target)	±5.0 %	Rectangular	√3	0.6	±1.7	∞
Liquid Permittivity (meas.)	±2.5 %	Normal	1	0.6	±1.5	∞
Combined Standard Uncertainty					±10.9	387
Coverage Factor for 95 %		K=2				
Expanded uncertainty (Coverage factor = 2)					±21.9	

Table 7.2 Uncertainty Budget of DASY4

8. SAR Measurement Evaluation

Each DASY4 system is equipped with one or more system validation kits. These units, together with the predefined measurement procedures within the DASY4 software, enable the user to conduct the system performance check and system validation. System validation kit includes a dipole, tripod holder to fix it underneath the flat phantom and a corresponding distance holder.

8.1 Purpose of System Performance check

The system performance check verifies that the system operates within its specifications. System and operator errors can be detected and corrected. It is recommended that the system performance check be performed prior to any usage of the system in order to guarantee reproducible results. The system performance check uses normal SAR measurements in a simplified setup with a well characterized source. This setup was selected to give a high sensitivity to all parameters that might fail or vary over time. The system check does not intend to replace the calibration of the components, but indicates situations where the system uncertainty is exceeded due to drift or failure.

8.2 System Setup

In the simplified setup for system evaluation, the DUT is replaced by a calibrated dipole and the power source is replaced by a continuous wave which comes from a signal generator at frequency 2450 MHz. The calibrated dipole must be placed beneath the flat phantom section of the SAM twin phantom with the correct distance holder. The distance holder should touch the phantom surface with a light pressure at the reference marking and be oriented parallel to the long side of the phantom. The equipment setup is shown below:

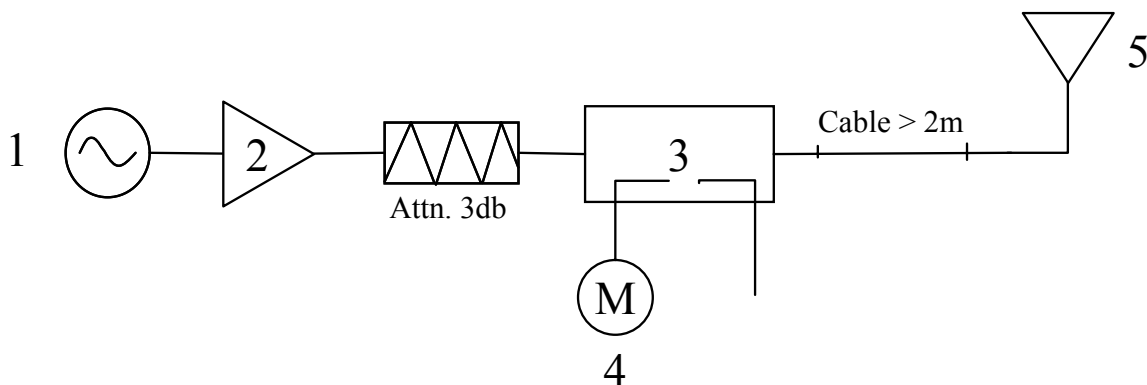

Fig. 8.1 System Setup for System Evaluation

1. Signal Generator
2. Amplifier
3. Directional Coupler
4. Power Meter
5. 2450 MHz Dipole

The output power on dipole port must be calibrated to 20dBm (100mW) before dipole is connected.



Fig 8.2 Dipole Setup



8.3 Validation Results

Comparing to the original SAR value provided by SPEAG, the validation data should be within its specification of 10 %. Table 8.1 shows the target SAR and measured SAR after normalized to 1W input power.

Band	Position	SAR	Target (W/kg)	Measurement Data (W/kg)	Variation	Measurement Date
802.11b/g (2450 MHz)	Head	SAR (1g)	52.7	56.0	6.3 %	Apr. 11, 2008
		SAR (10g)	24.5	26.6	8.6 %	
	Body	SAR (1g)	52.5	52.6	0.2 %	Apr. 09, 2008
		SAR (10g)	24.4	24.8	1.6 %	

Table 8.1 Target and Measurement Data Comparison

The table above indicates the system performance check can meet the variation criterion.



9. Description for DUT Testing Position

This DUT was tested in 6 different positions. They are right cheek, right tilted, left cheek, left tilted, front face with 0cm Gap and rear face with 0cm Gap as illustrated below:

- 1) “ Cheek Position”
 - i) To position the device with the vertical center line of the body of the device and the horizontal line crossing the center piece in a plane parallel to the sagittal plane of the phantom. While maintaining the device in this plane, align the vertical center line with the reference plane containing the three ear and mouth reference point (M, RE and LE) and align the center of the ear piece with the line RE-LE.
 - ii) To move the device towards the phantom with the ear piece aligned with the line LE-RE until the phone touched the ear. While maintaining the device in the reference plane and maintaining the phone contact with the ear, move the bottom of the phone until any point on the front side is in contact with the cheek of the phantom or until contact with the ear is lost (see Fig. 9.1).

- 2) “ Tilted Position”
 - i) To position the device in the “cheek” position described above.
 - ii) While maintaining the device the reference plane described above and pivoting against the ear, move it outward away from the mouth by an angle of 15 degrees or until contact with the ear is lost (see Fig. 9.2).

- 3) “ Body Worn”
 - i) To position the device parallel to the phantom surface.
 - ii) To adjust the phone parallel to the flat phantom.
 - iii) To adjust the distance between the EUT surface and the flat phantom to 0 cm.

Remark: Please refer to Appendix E for the test setup photos.

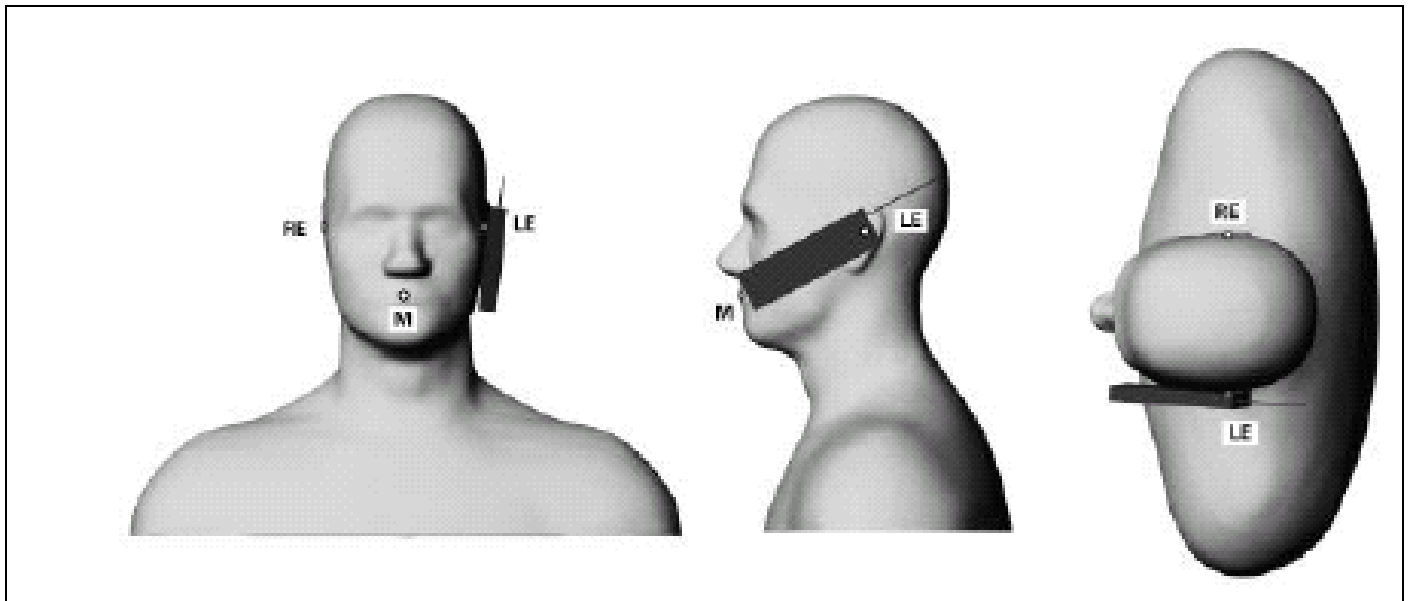

Fig. 9.1 Phone Position 1, “Cheek” or “Touch” Position. The reference points for the right ear (RE), left ear (LE) and mouth (M), which define the plane for phone positioning, are indicated.

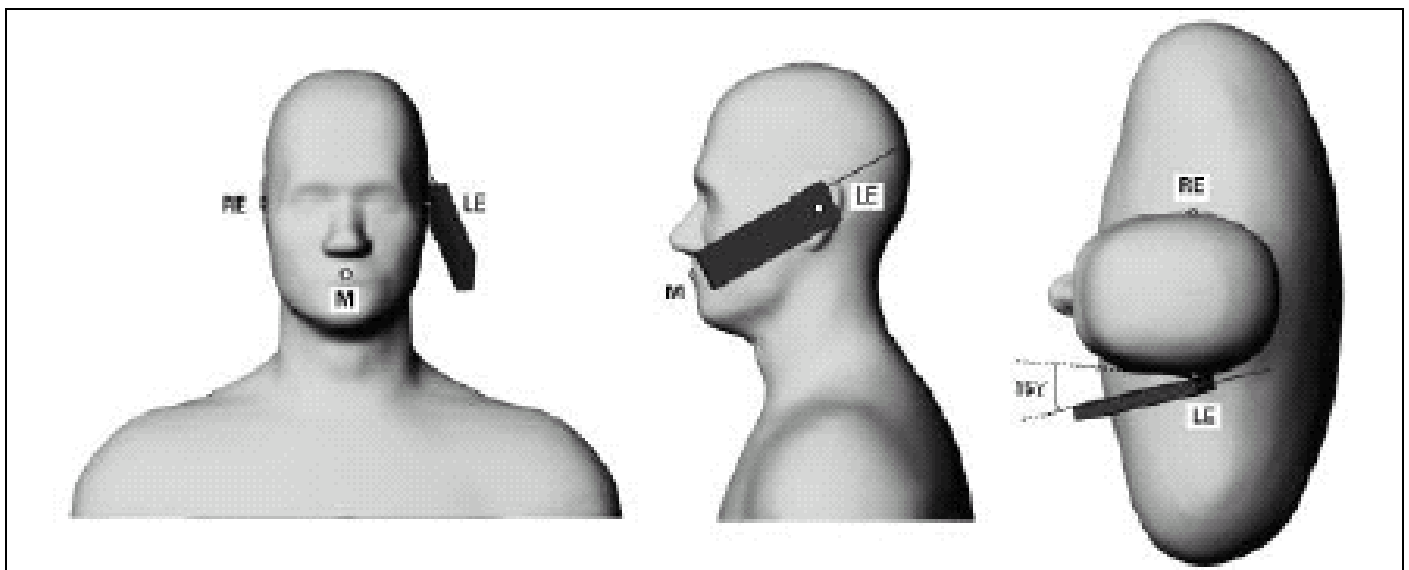

Fig. 9.2 Phone Position 2, “Tilted Position”. The reference point for the right ear (RE), left ear (LE) and mouth (M), which define the plane for phone positioning, are indicated.



10. Measurement Procedures

The measurement procedures are as follows:

- Using engineering software to transmit RF power continuously (continuous Tx)
- Linking DUT with base station emulator CMU200 in middle channel
- Setting CMU200 to allow DUT to radiate maximum output power
- Measuring output power through RF cable and power meter
- Placing the DUT in the positions described in the last section
- Setting scan area, grid size and other setting on the DASY4 software
- Taking data for the lowest, middle, and highest channel on each testing position
- Repeat the previous steps for the middle and high channels.

According to the IEEE P1528 draft standard, the recommended procedure for assessing the peak spatial-average SAR value consists of the following steps:

- Power reference measurement
- Area scan
- Zoom scan
- Power reference measurement

10.1 Spatial Peak SAR Evaluation

The procedure for spatial peak SAR evaluation has been implemented according to the IEEE1528-2003 standard. It can be conducted for 1g and 10g, as well as for user-specific masses. The DASY4 software includes all numerical procedures necessary to evaluate the spatial peak SAR value.

Base on the Draft: SCC-34, SC-2, WG-2-Computational Dosimetry, P1528/D1.2 (Recommended Practice for Determining the Peak Spatial-Average Specific Absorption Rate (SAR) in the Human Head from Wireless Communications Devices: Measurement Techniques), a new algorithm has been implemented. The spatial-peak SAR can be computed over any required mass.

The base for the evaluation is a "cube" measurement. The measured volume must include the 1g and 10g cubes with the highest averaged SAR values. For that purpose, the center of the measured volume is aligned to the interpolated peak SAR value of a previously performed area scan.



The entire evaluation of the spatial peak values is performed within the post-processing engine (SEMCAD). The system always gives the maximum values for the 1g and 10g cubes. The algorithm to find the cube with highest averaged SAR is divided into the following stages:

- extraction of the measured data (grid and values) from the Zoom Scan
- calculation of the SAR value at every measurement point based on all stored data (A/D values and measurement parameters)
- generation of a high-resolution mesh within the measured volume
- interpolation of all measured values from the measurement grid to the high-resolution grid
- extrapolation of the entire 3-D field distribution to the phantom surface over the distance from sensor to surface
- calculation of the averaged SAR within masses of 1g and 10g

10.2 Scan Procedures

First Area Scan is used to locate the approximate location(s) of the local peak SAR value(s). The measurement grid within an Area Scan is defined by the grid extent, grid step size and grid offset. Next, in order to determine the EM field distribution in a three-dimensional spatial extension, Zoom Scan is required. The Zoom Scan measures 5x5x7 points with step size 8, 8 and 5 mm. The Zoom Scan is performed around the highest E-field value to determine the averaged SAR-distribution over 1 g.

10.3 SAR Averaged Methods

In DASY4, the interpolation and extrapolation are both based on the modified Quadratic Shepard's method. The interpolation scheme combines a least-square fitted function method and a weighted average method which are the two basic types of computational interpolation and approximation.

Extrapolation routines are used to obtain SAR values between the lowest measurement points and the inner phantom surface. The extrapolation distance is determined by the surface detection distance and the probe sensor offset. The uncertainty increases with the extrapolation distance. To keep the uncertainty within 1% for the 1 g and 10 g cubes, the extrapolation distance should not be larger than 5 mm.



11. SAR Test Results

11.1 Right Cheek

Mode	Sample	Chan.	Frequency (MHz)	Modulation Type	Conducted Power (dBm)	Power Drift (dB)	Measured 1g SAR (W/kg)	Limit (W/kg)	Result
802.11b	D	1 (Low)	2412	CCK	14.57	-0.136	0.09	1.6	Pass
		6 (Mid)	2437	CCK	14.33	-	-	-	-
		11 (High)	2462	CCK	13.56	-	-	-	-
802.11g	D	1 (Low)	2412	OFDM	11.96	-	-	-	-
		6 (Mid)	2437	OFDM	15.52	-0.176	0.092	1.6	Pass
		11 (High)	2462	OFDM	11.81	-	-	-	-

11.2 Right Tilted

Mode	Sample	Chan.	Frequency (MHz)	Modulation Type	Conducted Power (dBm)	Power Drift (dB)	Measured 1g SAR (W/kg)	Limit (W/kg)	Result
802.11b	D	1 (Low)	2412	CCK	14.57	-	-	-	-
		6 (Mid)	2437	CCK	14.33	-	-	-	-
		11 (High)	2462	CCK	13.56	-	-	-	-
802.11g	D	1 (Low)	2412	OFDM	11.96	-	-	-	-
		6 (Mid)	2437	OFDM	15.52	-0.003	0.122	1.6	Pass
		11 (High)	2462	OFDM	11.81	-	-	-	-

11.3 Left Cheek

Mode	Sample	Chan.	Frequency (MHz)	Modulation Type	Conducted Power (dBm)	Power Drift (dB)	Measured 1g SAR (W/kg)	Limit (W/kg)	Result
802.11b	D	1 (Low)	2412	CCK	14.57	-	-	-	-
		6 (Mid)	2437	CCK	14.33	-	-	-	-
		11 (High)	2462	CCK	13.56	-	-	-	-
802.11g	D	1 (Low)	2412	OFDM	11.96	-	-	-	-
		6 (Mid)	2437	OFDM	15.52	-0.135	0.18	1.6	Pass
		11 (High)	2462	OFDM	11.81	-	-	-	-

11.4 Left Tilted

Mode	Sample	Chan.	Frequency (MHz)	Modulation Type	Conducted Power (dBm)	Power Drift (dB)	Measured 1g SAR (W/kg)	Limit (W/kg)	Result	
802.11b	D	1 (Low)	2412	CCK	14.57	-	-	-	-	
		6 (Mid)	2437	CCK	14.33	-	-	-	-	
		11 (High)	2462	CCK	13.56	-	-	-	-	
802.11g	A	6 (Mid)	2437	OFDM	15.52	-0.151	0.24	1.6	Pass	
		B	6 (Mid)	2437	OFDM	15.52	-0.127	0.225	1.6	Pass
		C	6 (Mid)	2437	OFDM	15.52	-0.143	0.398	1.6	Pass
	D	1 (Low)	2412	OFDM	11.96	-	-	-	-	
		6 (Mid)	2437	OFDM	15.52	-0.111	0.431	1.6	Pass	
		11 (High)	2462	OFDM	11.81	-	-	-	-	

11.5 Front Face with 0cm Gap

Mode	Sample	Chan.	Frequency (MHz)	Modulation Type	Conducted Power (dBm)	Power Drift (dB)	Measured 1g SAR (W/kg)	Limit (W/kg)	Result
802.11b	D	1 (Low)	2412	CCK	14.57	-0.023	0.209	1.6	Pass
		6 (Mid)	2437	CCK	14.33	-	-	-	-
		11 (High)	2462	CCK	13.56	-	-	-	-
802.11g	A	6 (Mid)	2437	OFDM	15.52	-0.088	0.328	1.6	Pass
	B	6 (Mid)	2437	OFDM	15.52	-0.124	0.519	1.6	Pass
	C	6 (Mid)	2437	OFDM	15.52	-0.126	0.506	1.6	Pass
	D	1 (Low)	2412	OFDM	11.96	-	-	-	-
		6 (Mid)	2437	OFDM	15.52	-0.039	0.309	1.6	Pass
		11 (High)	2462	OFDM	11.81	-	-	-	-

11.6 Rear Face with 0cm Gap

Mode	Sample	Chan.	Frequency (MHz)	Modulation Type	Conducted Power (dBm)	Power Drift (dB)	Measured 1g SAR (W/kg)	Limit (W/kg)	Result
802.11b	D	1 (Low)	2412	CCK	14.57	-0.091	0.165	1.6	Pass
		6 (Mid)	2437	CCK	14.33	-	-	-	-
		11 (High)	2462	CCK	13.56	-	-	-	-
802.11g	A	6 (Mid)	2437	OFDM	15.52	-0.12	0.202	1.6	Pass
	B	6 (Mid)	2437	OFDM	15.52	-0.08	0.281	1.6	Pass
	C	6 (Mid)	2437	OFDM	15.52	-0.029	0.284	1.6	Pass
	D	1 (Low)	2412	OFDM	11.96	-	-	-	-
		6 (Mid)	2437	OFDM	15.52	-	-	-	-
		11 (High)	2462	OFDM	11.81	-	-	-	-

Remark :

1. The Volume Scan of GSM850 CH251 and 802.11g CH06 for head SAR is 1.34 W/kg and its position is right tilted.
2. The Volume Scan of GSM1900 CH512 and 802.11g CH06 for head SAR is 0.649 W/kg and its position is left tilted.
3. The Volume Scan of GSM850 CH251 and 802.11g CH06 for head SAR is 1.30 W/kg and its position is front face with 0cm gap.
4. The Volume Scan of GSM1900 CH512 and 802.11g CH06 for head SAR is 0.805 W/kg and its position is front face with 0cm gap.
5. Test Engineer : A-Rod, Eric Huang, Jason Wang, and Gordon Lin.



12. References

- [1] FCC 47 CFR Part 2 “Frequency Allocations and Radio Treaty Matters; General Rules and Regulations”
- [2] IEEE Std. P1528-2003, “Recommended Practice for Determining the Peak Spatial-Average Specific Absorption Rate (SAR) in the Human Head from Wireless Communications Devices: Measurement Techniques”, April 21, 2003
- [3] Supplement C (Edition 01-01) to OET Bulletin 65 (Edition 97-01), “Additional Information for Evaluating Compliance of Mobile and Portable Devices with FCC Limits for Human Exposure to RF Emissions”, June 2001
- [4] IEEE Std. C95.3-2002, “IEEE Recommended Practice for the Measurement of Potentially Hazardous Electromagnetic Fields-RF and Microwave”, 2002
- [5] IEEE Std. C95.1-1999, “IEEE Standard for Safety Levels with Respect to Human Exposure to Radio Frequency Electromagnetic Fields, 3 kHz to 300 GHz”, 1999
- [6] Robert J. Renka, “Multivariate Interpolation Of Large Sets Of Scattered Data”, University of North Texas ACM Transactions on Mathematical Software, vol. 14, no. 2, June 1988, pp. 139-148
- [7] DASY4 System Handbook

Appendix A - System Performance Check Data

Test Laboratory: Sporton International Inc. SAR/HAC Testing Lab

Date: 2008/4/11

System Check_Head_2450MHz

DUT: Dipole 2450 MHz

Communication System: CW; Frequency: 2450 MHz; Duty Cycle: 1:1

Medium: HSL_2450 Medium parameters used: $f = 2450$ MHz; $\sigma = 1.84$ mho/m; $\epsilon_r = 37.8$; $\rho = 1000$ kg/m³

Ambient Temperature : 22.7 °C; Liquid Temperature : 21.5 °C

DASY4 Configuration:

- Probe: ET3DV6 - SN1787; ConvF(4.5, 4.5, 4.5); Calibrated: 2007/8/28
- Sensor-Surface: 4mm (Mechanical And Optical Surface Detection)
- Electronics: DAE4 Sn778; Calibrated: 2007/9/17
- Phantom: SAM-B; Type: QD 000 P40 C; Serial: TP-1383
- Measurement SW: DASY4, V4.7 Build 55; Postprocessing SW: SEMCAD, V1.8 Build 176

Pin=100mW/Area Scan (91x91x1): Measurement grid: dx=10mm, dy=10mm

Maximum value of SAR (interpolated) = 6.34 mW/g

Pin=100mW/Zoom Scan (7x7x7)/Cube 0: Measurement grid: dx=5mm, dy=5mm, dz=5mm

Reference Value = 59.6 V/m; Power Drift = -0.012 dB

Peak SAR (extrapolated) = 12.1 W/kg

SAR(1 g) = 5.6 mW/g; SAR(10 g) = 2.66 mW/g

Maximum value of SAR (measured) = 6.29 mW/g

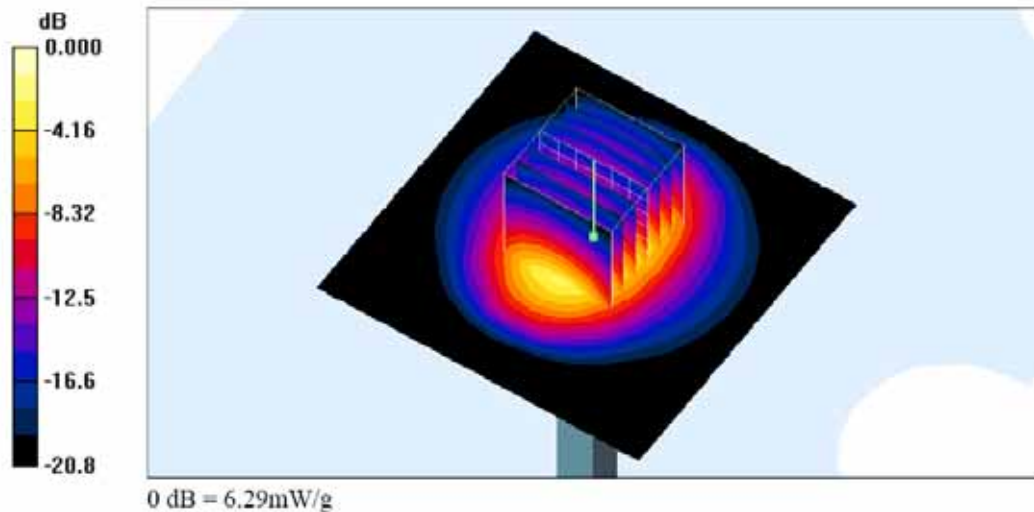

Test Laboratory: Sporton International Inc. SAR/HAC Testing Lab

Date: 2008/4/9

System Check_Body_2450MHz**DUT: Dipole 2450 MHz**

Communication System: CW; Frequency: 2450 MHz; Duty Cycle: 1:1

Medium: MSL_2450 Medium parameters used: $f = 2450$ MHz; $\sigma = 1.97$ mho/m; $\epsilon_r = 53.3$; $\rho = 1000$ kg/m³

Ambient Temperature : 22.9 °C; Liquid Temperature : 21.6 °C

DASY4 Configuration:

- Probe: ET3DV6 - SN1787; ConvF(4.02, 4.02, 4.02); Calibrated: 2007/8/28
- Sensor-Surface: 4mm (Mechanical And Optical Surface Detection) Sensor-Surface: 4mm (Mechanical Surface Detection)
- Electronics: DAE4 Sn778; Calibrated: 2007/9/17
- Phantom: SAM-B; Type: QD 000 P40 C; Serial: TP-1383
- Measurement SW: DASY4, V4.7 Build 55; Postprocessing SW: SEMCAD, V1.8 Build 176

Pin=100mW/Area Scan (91x91x1): Measurement grid: dx=10mm, dy=10mm

Maximum value of SAR (interpolated) = 6.16 mW/g

Pin=100mW/Zoom Scan (7x7x7)/Cube 0: Measurement grid: dx=5mm, dy=5mm, dz=5mm

Reference Value = 57.5 V/m; Power Drift = 0.010 dB

Peak SAR (extrapolated) = 11.2 W/kg

SAR(1 g) = 5.26 mW/g; SAR(10 g) = 2.48 mW/g

Maximum value of SAR (measured) = 5.97 mW/g

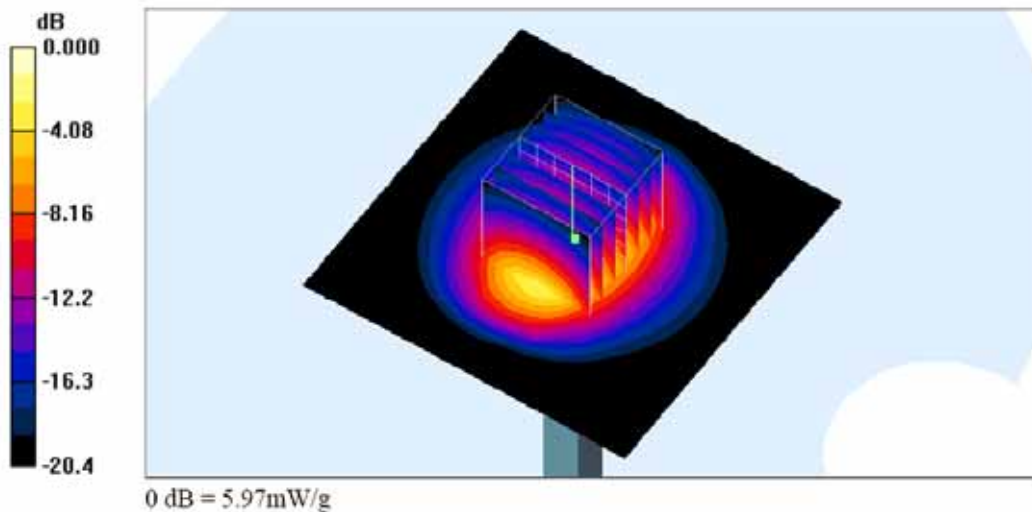

Appendix B - SAR Measurement Data

Test Laboratory: Sporton International Inc. SAR/HAC Testing Lab

Date: 2008/4/11

Right Cheek_802.11b Ch1_Sample D

DUT: 840317

Communication System: 802.11b ; Frequency: 2412 MHz;Duty Cycle: 1:1

Medium: HSL_2450 Medium parameters used: $f = 2412$ MHz; $\sigma = 1.81$ mho/m; $\epsilon_r = 37.9$; $\rho = 1000$ kg/m³

Ambient Temperature : 22.9 °C; Liquid Temperature : 21.5 °C

DASY4 Configuration:

- Probe: ET3DV6 - SN1787; ConvF(4.5, 4.5, 4.5); Calibrated: 2007/8/28
- Sensor-Surface: 4mm (Mechanical Surface Detection)
- Electronics: DAE4 Sn778; Calibrated: 2007/9/17
- Phantom: SAM-B; Type: QD 000 P40 C; Serial: TP-1383
- Measurement SW: DASY4, V4.7 Build 55; Postprocessing SW: SEMCAD, V1.8 Build 176

Ch1/Area Scan (71x121x1): Measurement grid: dx=15mm, dy=15mm

Maximum value of SAR (interpolated) = 0.108 mW/g

Ch1/Zoom Scan (5x5x7)/Cube 0: Measurement grid: dx=8mm, dy=8mm, dz=5mm

Reference Value = 6.93 V/m; Power Drift = -0.136 dB

Peak SAR (extrapolated) = 0.204 W/kg

SAR(1 g) = 0.090 mW/g; SAR(10 g) = 0.045 mW/g

Maximum value of SAR (measured) = 0.102 mW/g

Ch1/Zoom Scan (5x5x7)/Cube 1: Measurement grid: dx=8mm, dy=8mm, dz=5mm

Reference Value = 6.93 V/m; Power Drift = -0.136 dB

Peak SAR (extrapolated) = 0.153 W/kg

SAR(1 g) = 0.085 mW/g; SAR(10 g) = 0.049 mW/g

Maximum value of SAR (measured) = 0.090 mW/g

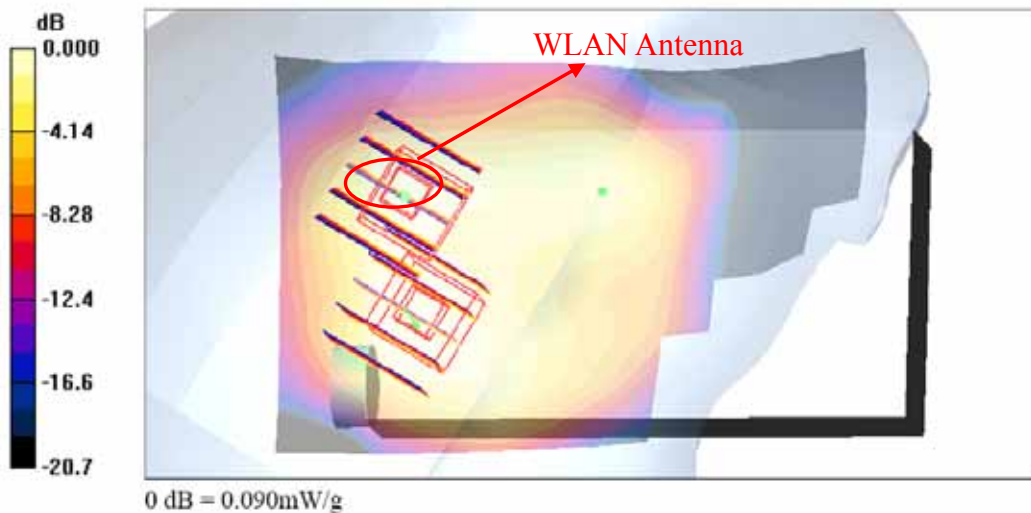

Test Laboratory: Sporton International Inc. SAR/HAC Testing Lab

Date: 2008/4/11

Right Cheek_802.11g Ch6_Sample D

DUT: 840317

Communication System: 802.11g; Frequency: 2437 MHz; Duty Cycle: 1:1

Medium: HSL_2450 Medium parameters used: $f = 2437$ MHz; $\sigma = 1.83$ mho/m; $\epsilon_r = 37.8$; $\rho = 1000$ kg/m³

Ambient Temperature : 22.7 °C; Liquid Temperature : 21.5 °C

DASY4 Configuration:

- Probe: ET3DV6 - SN1787; ConvF(4.5, 4.5, 4.5); Calibrated: 2007/8/28
- Sensor-Surface: 4mm (Mechanical Surface Detection)
- Electronics: DAE4 Sn778; Calibrated: 2007/9/17
- Phantom: SAM-B; Type: QD 000 P40 C; Serial: TP-1383
- Measurement SW: DASY4, V4.7 Build 55; Postprocessing SW: SEMCAD, V1.8 Build 176

Ch6/Area Scan (71x121x1): Measurement grid: dx=15mm, dy=15mm

Maximum value of SAR (interpolated) = 0.107 mW/g

Ch6/Zoom Scan (5x5x7)/Cube 0: Measurement grid: dx=8mm, dy=8mm, dz=5mm

Reference Value = 6.95 V/m; Power Drift = -0.176 dB

Peak SAR (extrapolated) = 0.171 W/kg

SAR(1 g) = 0.092 mW/g; SAR(10 g) = 0.053 mW/g

Maximum value of SAR (measured) = 0.096 mW/g

Ch6/Zoom Scan (5x5x7)/Cube 1: Measurement grid: dx=8mm, dy=8mm, dz=5mm

Reference Value = 6.95 V/m; Power Drift = -0.176 dB

Peak SAR (extrapolated) = 0.196 W/kg

SAR(1 g) = 0.086 mW/g; SAR(10 g) = 0.043 mW/g

Maximum value of SAR (measured) = 0.095 mW/g

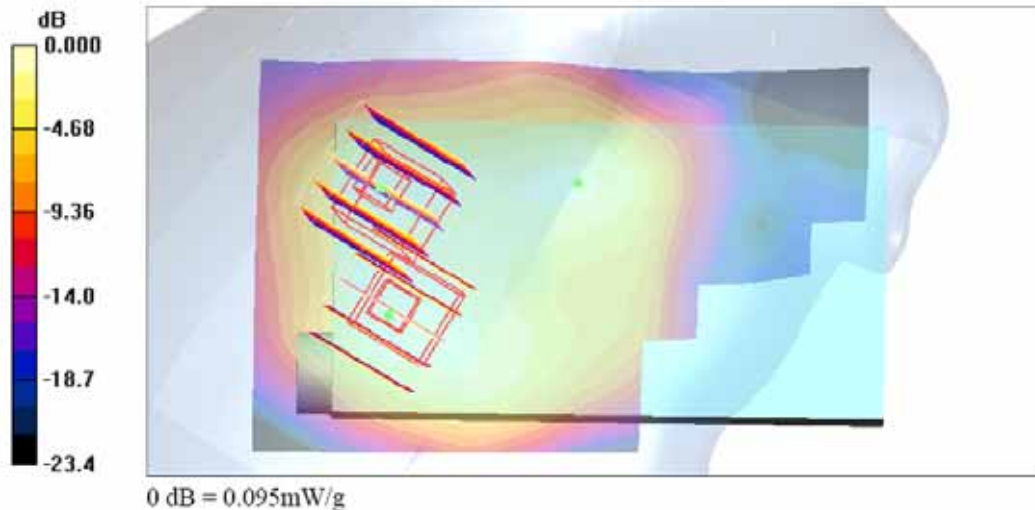

Test Laboratory: Sporton International Inc. SAR/HAC Testing Lab

Date: 2008/4/11

Right Tilted_802.11g Ch6_Sample D**DUT: 840317**

Communication System: 802.11g; Frequency: 2437 MHz; Duty Cycle: 1:1

Medium: HSL_2450 Medium parameters used: $f = 2437$ MHz; $\sigma = 1.83$ mho/m; $\epsilon_r = 37.8$; $\rho = 1000$ kg/m³

Ambient Temperature : 22.7 °C; Liquid Temperature : 21.5 °C

DASY4 Configuration:

- Probe: ET3DV6 - SN1787; ConvF(4.5, 4.5, 4.5); Calibrated: 2007/8/28
- Sensor-Surface: 4mm (Mechanical Surface Detection)
- Electronics: DAE4 Sn778; Calibrated: 2007/9/17
- Phantom: SAM-B; Type: QD 000 P40 C; Serial: TP-1383
- Measurement SW: DASY4, V4.7 Build 55; Postprocessing SW: SEMCAD, V1.8 Build 176

Ch6/Area Scan (71x121x1): Measurement grid: dx=15mm, dy=15mm

Maximum value of SAR (interpolated) = 0.143 mW/g

Ch6/Zoom Scan (5x5x7)/Cube 0: Measurement grid: dx=8mm, dy=8mm, dz=5mm

Reference Value = 7.57 V/m; Power Drift = -0.003 dB

Peak SAR (extrapolated) = 0.233 W/kg

SAR(1 g) = 0.122 mW/g; SAR(10 g) = 0.066 mW/g

Maximum value of SAR (measured) = 0.131 mW/g

Ch6/Zoom Scan (5x5x7)/Cube 1: Measurement grid: dx=8mm, dy=8mm, dz=5mm

Reference Value = 7.57 V/m; Power Drift = -0.003 dB

Peak SAR (extrapolated) = 0.268 W/kg

SAR(1 g) = 0.114 mW/g; SAR(10 g) = 0.054 mW/g

Maximum value of SAR (measured) = 0.126 mW/g

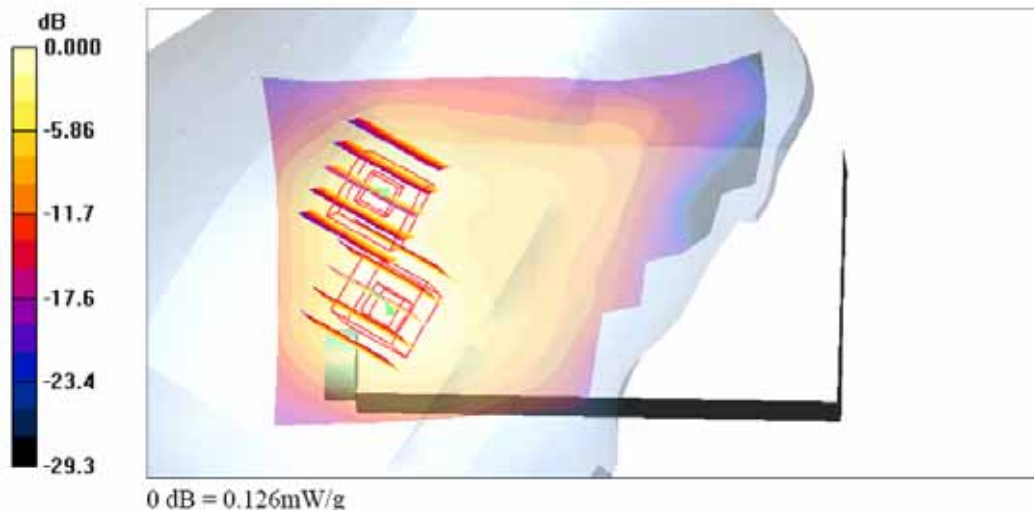

Test Laboratory: Sporton International Inc. SAR/HAC Testing Lab

Date: 2008/4/11

Left Cheek_802.11g Ch6_Sample D**DUT: 840317**

Communication System: 802.11g; Frequency: 2437 MHz; Duty Cycle: 1:1

Medium: HSL_2450 Medium parameters used: $f = 2437$ MHz; $\sigma = 1.83$ mho/m; $\epsilon_r = 37.8$; $\rho = 1000$ kg/m³

Ambient Temperature : 22.6 °C; Liquid Temperature : 21.5 °C

DASY4 Configuration:

- Probe: ET3DV6 - SN1787; ConvF(4.5, 4.5, 4.5); Calibrated: 2007/8/28
- Sensor-Surface: 4mm (Mechanical Surface Detection)
- Electronics: DAE4 Sn778; Calibrated: 2007/9/17
- Phantom: SAM-B; Type: QD 000 P40 C; Serial: TP-1383
- Measurement SW: DASY4, V4.7 Build 55; Postprocessing SW: SEMCAD, V1.8 Build 176

Ch6/Area Scan (71x121x1): Measurement grid: dx=15mm, dy=15mm

Maximum value of SAR (interpolated) = 0.228 mW/g

Ch6/Zoom Scan (5x5x7)/Cube 0: Measurement grid: dx=8mm, dy=8mm, dz=5mm

Reference Value = 7.06 V/m; Power Drift = -0.135 dB

Peak SAR (extrapolated) = 0.356 W/kg

SAR(1 g) = 0.180 mW/g; SAR(10 g) = 0.091 mW/g

Maximum value of SAR (measured) = 0.205 mW/g

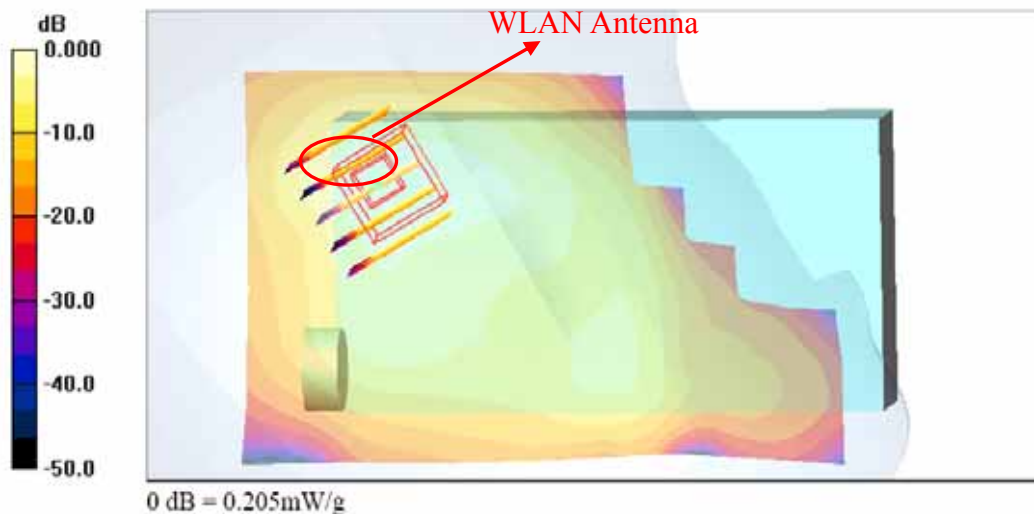

Test Laboratory: Sporton International Inc. SAR/HAC Testing Lab

Date: 2008/4/12

Left Tilted_802.11g Ch6_Sample A

DUT: 840317

Communication System: 802.11g; Frequency: 2437 MHz; Duty Cycle: 1:1

Medium: HSL_2450 Medium parameters used: $f = 2437$ MHz; $\sigma = 1.83$ mho/m; $\epsilon_r = 37.8$; $\rho = 1000$ kg/m³

Ambient Temperature : 22.7 °C; Liquid Temperature : 21.5 °C

DASY4 Configuration:

- Probe: ET3DV6 - SN1787; ConvF(4.5, 4.5, 4.5); Calibrated: 2007/8/28
- Sensor-Surface: 4mm (Mechanical Surface Detection)
- Electronics: DAE4 Sn778; Calibrated: 2007/9/17
- Phantom: SAM-B; Type: QD 000 P40 C; Serial: TP-1383
- Measurement SW: DASY4, V4.7 Build 55; Postprocessing SW: SEMCAD, V1.8 Build 176

Ch6/Area Scan (71x121x1): Measurement grid: dx=15mm, dy=15mm
 Maximum value of SAR (interpolated) = 0.276 mW/g

Ch6/Zoom Scan (5x5x7)/Cube 0: Measurement grid: dx=8mm, dy=8mm, dz=5mm
 Reference Value = 7.27 V/m; Power Drift = -0.151 dB
 Peak SAR (extrapolated) = 0.595 W/kg
SAR(1 g) = 0.240 mW/g; SAR(10 g) = 0.115 mW/g
 Maximum value of SAR (measured) = 0.263 mW/g

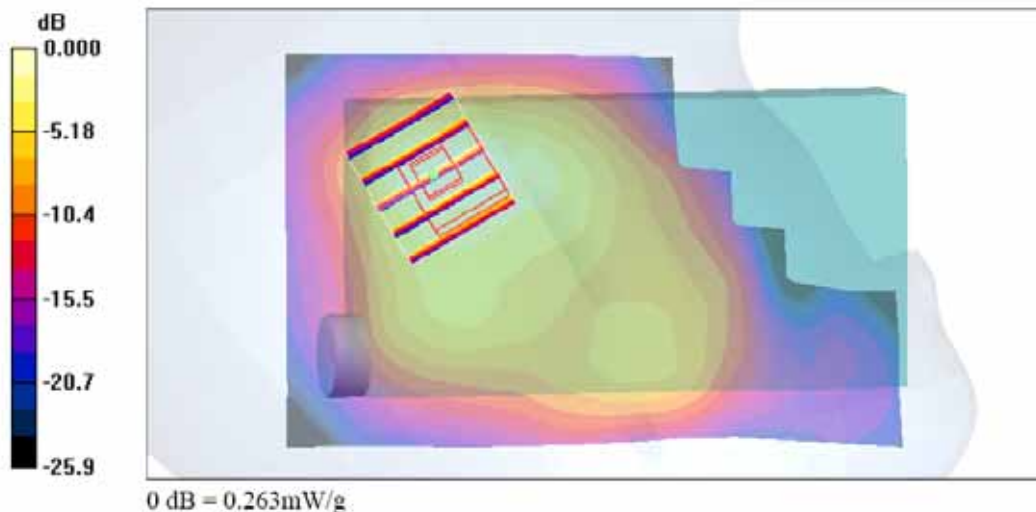

Test Laboratory: Sporton International Inc. SAR/HAC Testing Lab

Date: 2008/4/11

Left Tilted_802.11g Ch6_Sample B**DUT: 840317**

Communication System: 802.11g; Frequency: 2437 MHz; Duty Cycle: 1:1

Medium: HSL_2450 Medium parameters used: $f = 2437$ MHz; $\sigma = 1.83$ mho/m; $\epsilon_r = 37.8$; $\rho = 1000$ kg/m³

Ambient Temperature : 22.6 °C; Liquid Temperature : 21.5 °C

DASY4 Configuration:

- Probe: ET3DV6 - SN1787; ConvF(4.5, 4.5, 4.5); Calibrated: 2007/8/28
- Sensor-Surface: 4mm (Mechanical Surface Detection)
- Electronics: DAE4 Sn778; Calibrated: 2007/9/17
- Phantom: SAM-B; Type: QD 000 P40 C; Serial: TP-1383
- Measurement SW: DASY4, V4.7 Build 55; Postprocessing SW: SEMCAD, V1.8 Build 176

Ch6/Area Scan (71x121x1): Measurement grid: dx=15mm, dy=15mm

Maximum value of SAR (interpolated) = 0.262 mW/g

Ch6/Zoom Scan (5x5x7)/Cube 0: Measurement grid: dx=8mm, dy=8mm, dz=5mm

Reference Value = 7.97 V/m; Power Drift = -0.127 dB

Peak SAR (extrapolated) = 0.564 W/kg

SAR(1 g) = 0.225 mW/g; SAR(10 g) = 0.102 mW/g

Maximum value of SAR (measured) = 0.251 mW/g

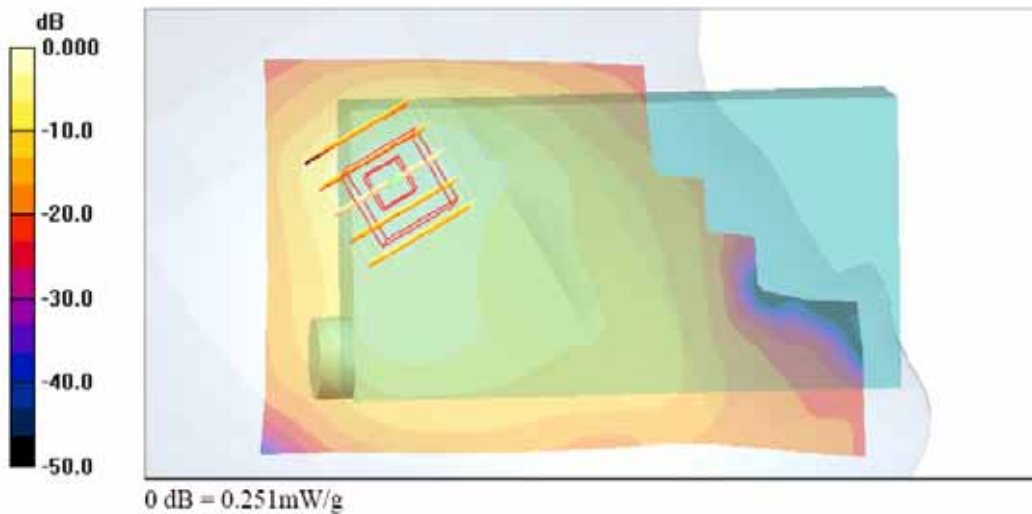

Test Laboratory: Sporton International Inc. SAR/HAC Testing Lab

Date: 2008/4/12

Left Tilted_802.11g Ch6_Sample C**DUT: 840317**

Communication System: 802.11g; Frequency: 2437 MHz; Duty Cycle: 1:1

Medium: HSL_2450 Medium parameters used: $f = 2437$ MHz; $\sigma = 1.83$ mho/m; $\epsilon_r = 37.8$; $\rho = 1000$ kg/m³

Ambient Temperature : 22.7 °C; Liquid Temperature : 21.5 °C

DASY4 Configuration:

- Probe: ET3DV6 - SN1787; ConvF(4.5, 4.5, 4.5); Calibrated: 2007/8/28
- Sensor-Surface: 4mm (Mechanical Surface Detection)
- Electronics: DAE4 Sn778; Calibrated: 2007/9/17
- Phantom: SAM-B; Type: QD 000 P40 C; Serial: TP-1383
- Measurement SW: DASY4, V4.7 Build 55; Postprocessing SW: SEMCAD, V1.8 Build 176

Ch6/Area Scan (71x121x1): Measurement grid: dx=15mm, dy=15mm

Maximum value of SAR (interpolated) = 0.479 mW/g

Ch6/Zoom Scan (5x5x7)/Cube 0: Measurement grid: dx=8mm, dy=8mm, dz=5mm

Reference Value = 10.6 V/m; Power Drift = -0.143 dB

Peak SAR (extrapolated) = 1.00 W/kg

SAR(1 g) = 0.398 mW/g; SAR(10 g) = 0.180 mW/g

Maximum value of SAR (measured) = 0.433 mW/g

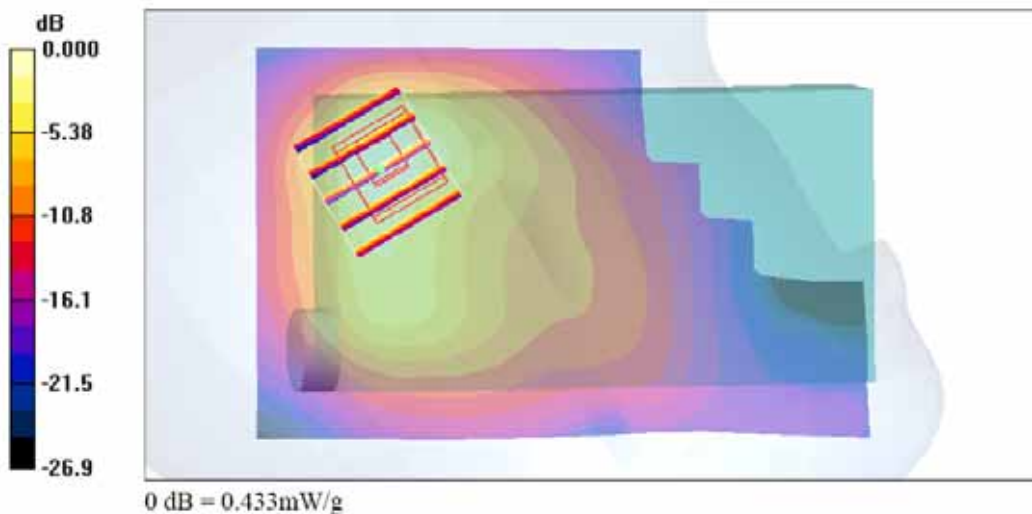

Test Laboratory: Sporton International Inc. SAR/HAC Testing Lab

Date: 2008/4/11

Left Tilted_802.11g Ch6_Sample D**DUT: 840317**

Communication System: 802.11g; Frequency: 2437 MHz; Duty Cycle: 1:1

Medium: HSL_2450 Medium parameters used: $f = 2437$ MHz; $\sigma = 1.83$ mho/m; $\epsilon_r = 37.8$; $\rho = 1000$ kg/m³

Ambient Temperature : 22.8 °C; Liquid Temperature : 21.5 °C

DASY4 Configuration:

- Probe: ET3DV6 - SN1787; ConvF(4.5, 4.5, 4.5); Calibrated: 2007/8/28
- Sensor-Surface: 4mm (Mechanical Surface Detection)
- Electronics: DAE4 Sn778; Calibrated: 2007/9/17
- Phantom: SAM-B; Type: QD 000 P40 C; Serial: TP-1383
- Measurement SW: DASY4, V4.7 Build 55; Postprocessing SW: SEMCAD, V1.8 Build 176

Ch6/Area Scan (71x121x1): Measurement grid: dx=15mm, dy=15mm

Maximum value of SAR (interpolated) = 0.512 mW/g

Ch6/Zoom Scan (5x5x7)/Cube 0: Measurement grid: dx=8mm, dy=8mm, dz=5mm

Reference Value = 11.7 V/m; Power Drift = -0.111 dB

Peak SAR (extrapolated) = 1.10 W/kg

SAR(1 g) = 0.431 mW/g; SAR(10 g) = 0.195 mW/g

Maximum value of SAR (measured) = 0.471 mW/g

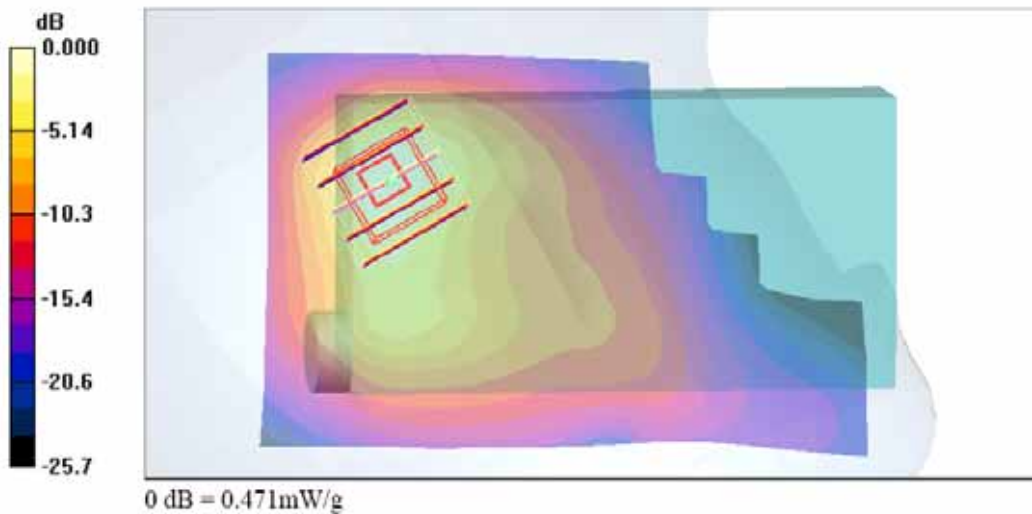

Test Laboratory: Sporton International Inc. SAR/HAC Testing Lab

Date: 2008/4/9

Body_802.11b Ch1_Front Face with 0cm Gap_Sample D

DUT: 840317

Communication System: 802.11b ; Frequency: 2412 MHz;Duty Cycle: 1:1

Medium: MSL_2450 Medium parameters used: $f = 2412$ MHz; $\sigma = 1.92$ mho/m; $\epsilon_r = 53.5$; $\rho = 1000$ kg/m³

Ambient Temperature : 22.9 °C; Liquid Temperature : 21.6 °C

DASY4 Configuration:

- Probe: ET3DV6 - SN1787; ConvF(4.02, 4.02, 4.02); Calibrated: 2007/8/28
- Sensor-Surface: 4mm (Mechanical Surface Detection)
- Electronics: DAE4 Sn778; Calibrated: 2007/9/17
- Phantom: SAM-B; Type: QD 000 P40 C; Serial: TP-1383
- Measurement SW: DASY4, V4.7 Build 55; Postprocessing SW: SEMCAD, V1.8 Build 176

Ch1/Area Scan (71x121x1): Measurement grid: dx=15mm, dy=15mm
Maximum value of SAR (interpolated) = 0.235 mW/g

Ch1/Zoom Scan (5x5x7)/Cube 0: Measurement grid: dx=8mm, dy=8mm, dz=5mm
Reference Value = 7.35 V/m; Power Drift = -0.023 dB
Peak SAR (extrapolated) = 0.520 W/kg
SAR(1 g) = 0.209 mW/g; SAR(10 g) = 0.091 mW/g
Maximum value of SAR (measured) = 0.220 mW/g

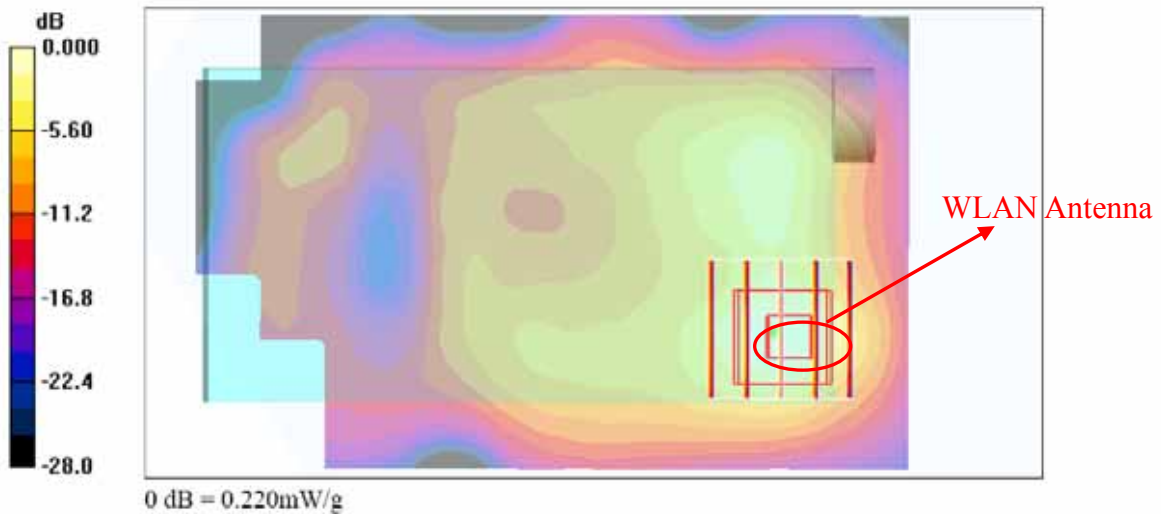

Test Laboratory: Sporton International Inc. SAR/HAC Testing Lab

Date: 2008/4/9

Body_802.11g Ch6_Front Face with 0cm Gap_Sample A**DUT: 840317**

Communication System: 802.11g; Frequency: 2437 MHz; Duty Cycle: 1:1

Medium: MSL_2450 Medium parameters used: $f = 2437$ MHz; $\sigma = 1.96$ mho/m; $\epsilon_r = 53.4$; $\rho = 1000$ kg/m³

Ambient Temperature : 22.9 °C; Liquid Temperature : 21.6 °C

DASY4 Configuration:

- Probe: ET3DV6 - SN1787; ConvF(4.02, 4.02, 4.02); Calibrated: 2007/8/28
- Sensor-Surface: 4mm (Mechanical Surface Detection)
- Electronics: DAE4 Sn778; Calibrated: 2007/9/17
- Phantom: SAM-B; Type: QD 000 P40 C; Serial: TP-1383
- Measurement SW: DASY4, V4.7 Build 55; Postprocessing SW: SEMCAD, V1.8 Build 176

Ch6/Area Scan (71x121x1): Measurement grid: dx=15mm, dy=15mm

Maximum value of SAR (interpolated) = 0.362 mW/g

Ch6/Zoom Scan (5x5x7)/Cube 0: Measurement grid: dx=8mm, dy=8mm, dz=5mm

Reference Value = 8.21 V/m; Power Drift = -0.088 dB

Peak SAR (extrapolated) = 0.826 W/kg

SAR(1 g) = 0.328 mW/g; SAR(10 g) = 0.142 mW/g

Maximum value of SAR (measured) = 0.369 mW/g

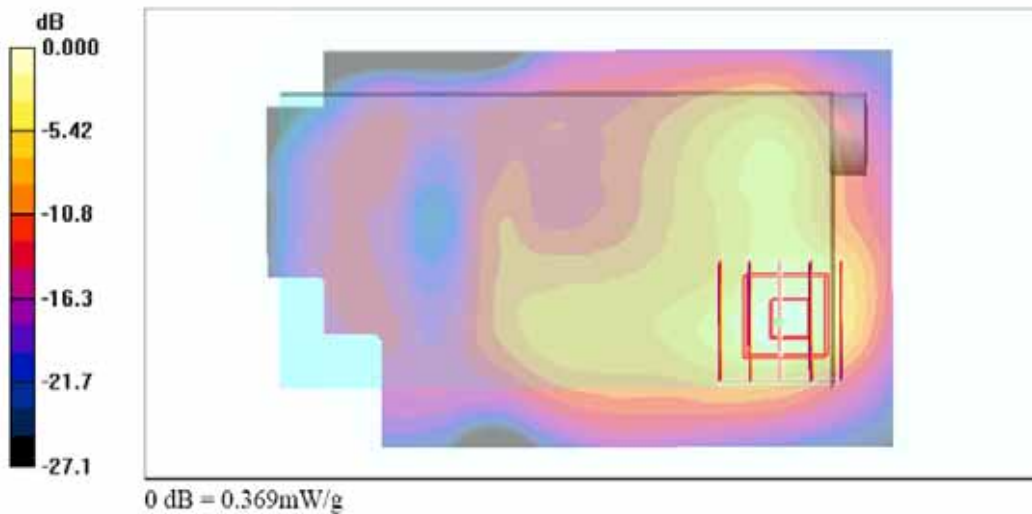

Test Laboratory: Sporton International Inc. SAR/HAC Testing Lab

Date: 2008/4/9

Body_802.11g Ch6_Front Face with 0cm Gap_Sample B**DUT: 840317**

Communication System: 802.11g; Frequency: 2437 MHz; Duty Cycle: 1:1

Medium: MSL_2450 Medium parameters used: $f = 2437$ MHz; $\sigma = 1.96$ mho/m; $\epsilon_r = 53.4$; $\rho = 1000$ kg/m³

Ambient Temperature : 22.9 °C; Liquid Temperature : 21.6 °C

DASY4 Configuration:

- Probe: ET3DV6 - SN1787; ConvF(4.02, 4.02, 4.02); Calibrated: 2007/8/28
- Sensor-Surface: 4mm (Mechanical Surface Detection)
- Electronics: DAE4 Sn778; Calibrated: 2007/9/17
- Phantom: SAM-B; Type: QD 000 P40 C; Serial: TP-1383
- Measurement SW: DASY4, V4.7 Build 55; Postprocessing SW: SEMCAD, V1.8 Build 176

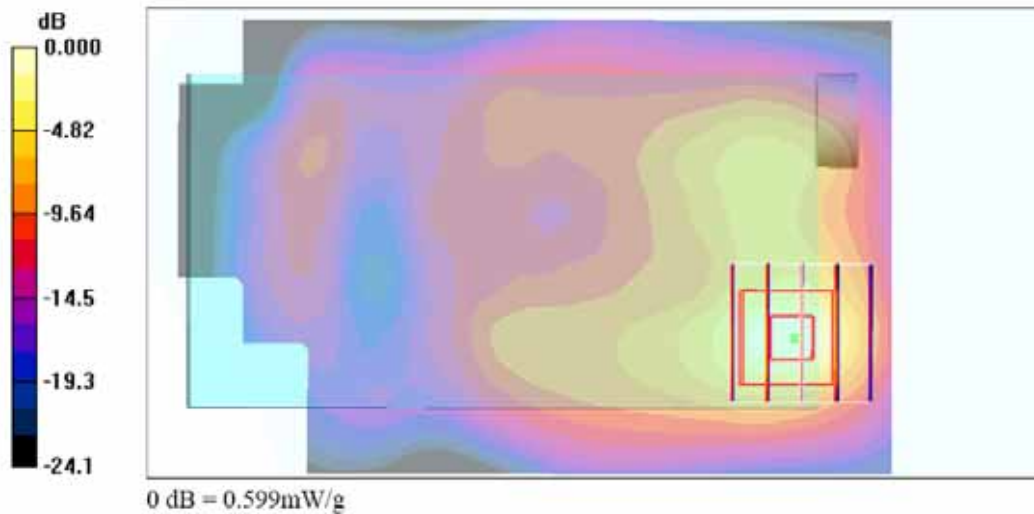
Ch6/Area Scan (71x121x1): Measurement grid: dx=15mm, dy=15mm
Maximum value of SAR (interpolated) = 0.523 mW/g**Ch6/Zoom Scan (5x5x7)/Cube 0:** Measurement grid: dx=8mm, dy=8mm, dz=5mm
Reference Value = 9.17 V/m; Power Drift = -0.124 dB
Peak SAR (extrapolated) = 1.31 W/kg
SAR(1 g) = 0.519 mW/g; SAR(10 g) = 0.222 mW/g
Maximum value of SAR (measured) = 0.599 mW/g

Test Laboratory: Sporton International Inc. SAR/HAC Testing Lab

Date: 2008/4/9

Body_802.11g Ch6_Front Face with 0cm Gap_Sample C

DUT: 840317

Communication System: 802.11g; Frequency: 2437 MHz; Duty Cycle: 1:1

Medium: MSL_2450 Medium parameters used: $f = 2437$ MHz; $\sigma = 1.96$ mho/m; $\epsilon_r = 53.4$; $\rho = 1000$ kg/m³

Ambient Temperature : 22.9 °C; Liquid Temperature : 21.6 °C

DASY4 Configuration:

- Probe: ET3DV6 - SN1787; ConvF(4.02, 4.02, 4.02); Calibrated: 2007/8/28
- Sensor-Surface: 4mm (Mechanical Surface Detection)
- Electronics: DAE4 Sn778; Calibrated: 2007/9/17
- Phantom: SAM-B; Type: QD 000 P40 C; Serial: TP-1383
- Measurement SW: DASY4, V4.7 Build 55; Postprocessing SW: SEMCAD, V1.8 Build 176

Ch6/Area Scan (71x121x1): Measurement grid: dx=15mm, dy=15mm

Maximum value of SAR (interpolated) = 0.519 mW/g

Ch6/Zoom Scan (5x5x7)/Cube 0: Measurement grid: dx=8mm, dy=8mm, dz=5mm

Reference Value = 8.78 V/m; Power Drift = -0.126 dB

Peak SAR (extrapolated) = 1.28 W/kg

SAR(1 g) = 0.506 mW/g; SAR(10 g) = 0.216 mW/g

Maximum value of SAR (measured) = 0.556 mW/g

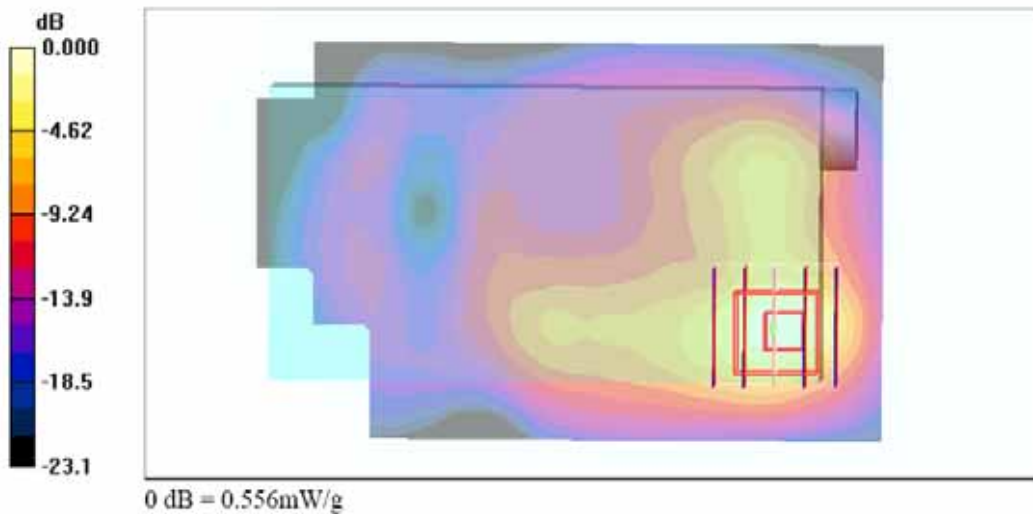

Test Laboratory: Sporton International Inc. SAR/HAC Testing Lab

Date: 2008/4/9

Body_802.11g Ch6_Front Face with 0cm Gap_Sample D**DUT: 840317**

Communication System: 802.11g; Frequency: 2437 MHz; Duty Cycle: 1:1

Medium: MSL_2450 Medium parameters used: $f = 2437$ MHz; $\sigma = 1.96$ mho/m; $\epsilon_r = 53.4$; $\rho = 1000$ kg/m³

Ambient Temperature : 22.9 °C; Liquid Temperature : 21.6 °C

DASY4 Configuration:

- Probe: ET3DV6 - SN1787; ConvF(4.02, 4.02, 4.02); Calibrated: 2007/8/28
- Sensor-Surface: 4mm (Mechanical Surface Detection)
- Electronics: DAE4 Sn778; Calibrated: 2007/9/17
- Phantom: SAM-B; Type: QD 000 P40 C; Serial: TP-1383
- Measurement SW: DASY4, V4.7 Build 55; Postprocessing SW: SEMCAD, V1.8 Build 176

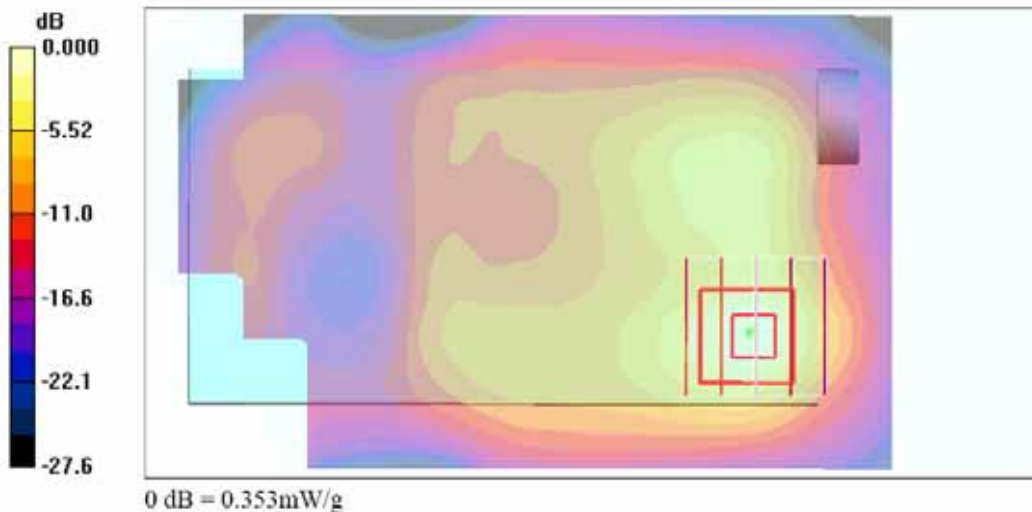
Ch6/Area Scan (71x121x1): Measurement grid: dx=15mm, dy=15mm
Maximum value of SAR (interpolated) = 0.373 mW/g**Ch6/Zoom Scan (5x5x7)/Cube 0:** Measurement grid: dx=8mm, dy=8mm, dz=5mm
Reference Value = 7.91 V/m; Power Drift = -0.039 dB
Peak SAR (extrapolated) = 0.764 W/kg
SAR(1 g) = 0.309 mW/g; SAR(10 g) = 0.133 mW/g
Maximum value of SAR (measured) = 0.353 mW/g

Test Laboratory: Sporton International Inc. SAR/HAC Testing Lab

Date: 2008/4/9

Body_802.11g Ch6_Rear Face with 0cm Gap_Sample A

DUT: 840317

Communication System: 802.11g; Frequency: 2437 MHz; Duty Cycle: 1:1

Medium: MSL_2450 Medium parameters used: $f = 2437$ MHz; $\sigma = 1.96$ mho/m; $\epsilon_r = 53.4$; $\rho = 1000$ kg/m³

Ambient Temperature : 22.9 °C; Liquid Temperature : 21.5 °C

DASY4 Configuration:

- Probe: ET3DV6 - SN1787; ConvF(4.02, 4.02, 4.02); Calibrated: 2007/8/28
- Sensor-Surface: 4mm (Mechanical Surface Detection)
- Electronics: DAE4 Sn778; Calibrated: 2007/9/17
- Phantom: SAM-B; Type: QD 000 P40 C; Serial: TP-1383
- Measurement SW: DASY4, V4.7 Build 55; Postprocessing SW: SEMCAD, V1.8 Build 176

Ch6/Area Scan (71x121x1): Measurement grid: dx=15mm, dy=15mm

Maximum value of SAR (interpolated) = 0.233 mW/g

Ch6/Zoom Scan (5x5x7)/Cube 0: Measurement grid: dx=8mm, dy=8mm, dz=5mm

Reference Value = 7.44 V/m; Power Drift = -0.120 dB

Peak SAR (extrapolated) = 0.438 W/kg

SAR(1 g) = 0.202 mW/g; SAR(10 g) = 0.109 mW/g

Maximum value of SAR (measured) = 0.218 mW/g

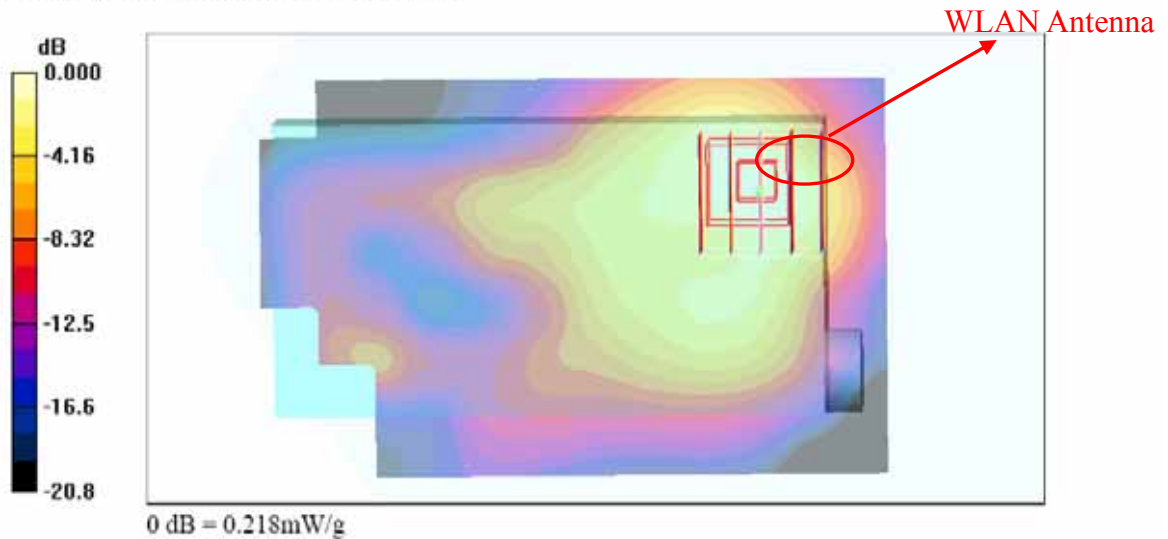

Test Laboratory: Sporton International Inc. SAR/HAC Testing Lab

Date: 2008/4/9

Body_802.11g Ch6_Rear Face with 0cm Gap_Sample B

DUT: 840317

Communication System: 802.11g; Frequency: 2437 MHz; Duty Cycle: 1:1

Medium: MSL_2450 Medium parameters used: $f = 2437 \text{ MHz}$; $\sigma = 1.96 \text{ mho/m}$; $\epsilon_r = 53.4$; $\rho = 1000 \text{ kg/m}^3$

Ambient Temperature : 22.9 °C; Liquid Temperature : 21.6 °C

DASY4 Configuration:

- Probe: ET3DV6 - SN1787; ConvF(4.02, 4.02, 4.02); Calibrated: 2007/8/28
- Sensor-Surface: 4mm (Mechanical Surface Detection)
- Electronics: DAE4 Sn778; Calibrated: 2007/9/17
- Phantom: SAM-B; Type: QD 000 P40 C; Serial: TP-1383
- Measurement SW: DASY4, V4.7 Build 55; Postprocessing SW: SEMCAD, V1.8 Build 176

Ch6/Area Scan (71x121x1): Measurement grid: dx=15mm, dy=15mm

Maximum value of SAR (interpolated) = 0.307 mW/g

Ch6/Zoom Scan (5x5x7)/Cube 0: Measurement grid: dx=8mm, dy=8mm, dz=5mm

Reference Value = 9.95 V/m; Power Drift = -0.080 dB

Peak SAR (extrapolated) = 0.556 W/kg

SAR(1 g) = 0.281 mW/g; SAR(10 g) = 0.159 mW/g

Maximum value of SAR (measured) = 0.300 mW/g

Ch6/Zoom Scan (5x5x7)/Cube 1: Measurement grid: dx=8mm, dy=8mm, dz=5mm

Reference Value = 9.95 V/m; Power Drift = -0.080 dB

Peak SAR (extrapolated) = 0.376 W/kg

SAR(1 g) = 0.179 mW/g; SAR(10 g) = 0.112 mW/g

Maximum value of SAR (measured) = 0.205 mW/g

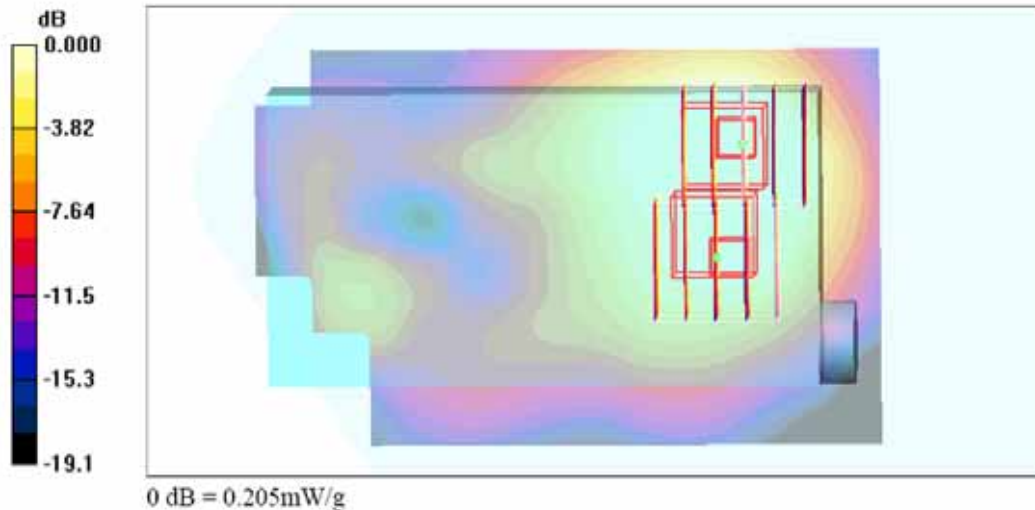

Test Laboratory: Sporton International Inc. SAR/HAC Testing Lab

Date: 2008/4/9

Body_802.11g Ch6_Rear Face with 0cm Gap_Sample C**DUT: 840317**

Communication System: 802.11g; Frequency: 2437 MHz; Duty Cycle: 1:1

Medium: MSL_2450 Medium parameters used: $f = 2437$ MHz; $\sigma = 1.96$ mho/m; $\epsilon_r = 53.4$; $\rho = 1000$ kg/m³

Ambient Temperature : 22.9 °C; Liquid Temperature : 21.6 °C

DASY4 Configuration:

- Probe: ET3DV6 - SN1787; ConvF(4.02, 4.02, 4.02); Calibrated: 2007/8/28
- Sensor-Surface: 4mm (Mechanical Surface Detection)
- Electronics: DAE4 Sn778; Calibrated: 2007/9/17
- Phantom: SAM-B; Type: QD 000 P40 C; Serial: TP-1383
- Measurement SW: DASY4, V4.7 Build 55; Postprocessing SW: SEMCAD, V1.8 Build 176

Ch6/Area Scan (71x121x1): Measurement grid: dx=15mm, dy=15mm

Maximum value of SAR (interpolated) = 0.325 mW/g

Ch6/Zoom Scan (5x5x7)/Cube 0: Measurement grid: dx=8mm, dy=8mm, dz=5mm

Reference Value = 6.79 V/m; Power Drift = -0.029 dB

Peak SAR (extrapolated) = 0.587 W/kg

SAR(1 g) = 0.284 mW/g; SAR(10 g) = 0.153 mW/g

Maximum value of SAR (measured) = 0.304 mW/g

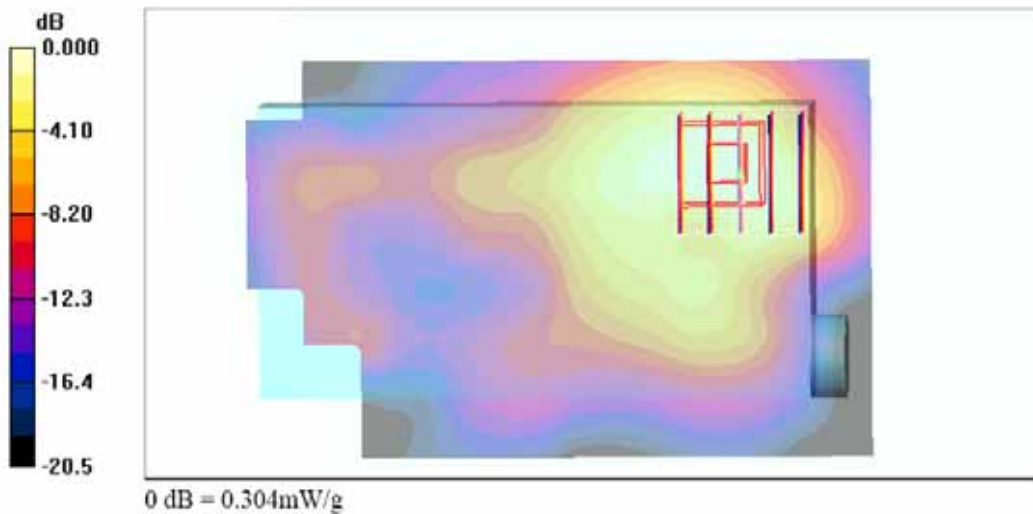

Test Laboratory: Sporton International Inc. SAR/HAC Testing Lab

Date: 2008/4/9

Body_802.11b Ch1_Rear Face with 0cm Gap_Sample D**DUT: 840317**

Communication System: 802.11b ; Frequency: 2412 MHz;Duty Cycle: 1:1

Medium: MSL_2450 Medium parameters used: $f = 2412$ MHz; $\sigma = 1.92$ mho/m; $\epsilon_r = 53.5$; $\rho = 1000$ kg/m³

Ambient Temperature : 22.9 °C; Liquid Temperature : 21.6 °C

DASY4 Configuration:

- Probe: ET3DV6 - SN1787; ConvF(4.02, 4.02, 4.02); Calibrated: 2007/8/28
- Sensor-Surface: 4mm (Mechanical Surface Detection)
- Electronics: DAE4 Sn778; Calibrated: 2007/9/17
- Phantom: SAM-B; Type: QD 000 P40 C; Serial: TP-1383
- Measurement SW: DASY4, V4.7 Build 55; Postprocessing SW: SEMCAD, V1.8 Build 176

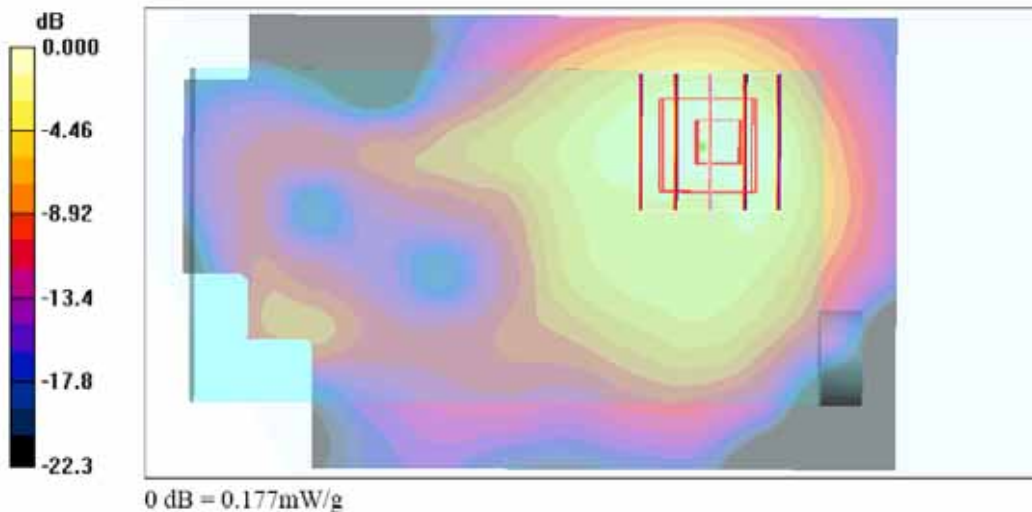
Ch1/Area Scan (71x121x1): Measurement grid: dx=15mm, dy=15mm
Maximum value of SAR (interpolated) = 0.173 mW/g**Ch1/Zoom Scan (5x5x7)/Cube 0:** Measurement grid: dx=8mm, dy=8mm, dz=5mm
Reference Value = 6.40 V/m; Power Drift = -0.091 dB
Peak SAR (extrapolated) = 0.330 W/kg
SAR(1 g) = 0.165 mW/g; SAR(10 g) = 0.088 mW/g
Maximum value of SAR (measured) = 0.177 mW/g

Test Laboratory: Sporton International Inc. SAR/HAC Testing Lab

Right Tilted_802.11g Ch6_Volume Scan

DUT: 840317

Communication System: 802.11g; Frequency: 2437 MHz; Duty Cycle: 1:1

Medium: HSL_2450 Medium parameters used: $f = 2437$ MHz; $\sigma = 1.83$ mho/m; $\epsilon_r = 37.8$; $\rho = 1000$ kg/m³

Phantom section: Right Section

Measurement Standard: DASy4 (High Precision Assessment)

- Probe: ET3DV6 - SN1787; ConvF(4.5, 4.5, 4.5); Calibrated: 2007/8/28
- Sensor-Surface: 4mm (Mechanical Surface Detection)
- Electronics: DAE4 Sn778; Calibrated: 2007/9/17
- Phantom: SAM-B; Type: QD 000 P40 C; Serial: TP-1383
- Measurement SW: DASy4, V4.7 Build 55

Test Laboratory: Sporton International Inc. SAR/HAC Testing Lab

Right Tilted_GSM850 Ch251_Volume Scan

DUT: 840317

Communication System: GSM850; Frequency: 848.8 MHz; Duty Cycle: 1:8.3

Medium: HSL_850 Medium parameters used: $f = 849$ MHz; $\sigma = 0.919$ mho/m; $\epsilon_r = 40.5$; $\rho = 1000$ kg/m³

Phantom section: Right Section

Measurement Standard: DASy4 (High Precision Assessment)

- Probe: ET3DV6 - SN1787; ConvF(6.58, 6.58, 6.58); Calibrated: 2007/8/28
- Sensor-Surface: 4mm (Mechanical Surface Detection)
- Electronics: DAE4 Sn778; Calibrated: 2007/9/17
- Phantom: SAM-B; Type: QD 000 P40 C; Serial: TP-1383
- Measurement SW: DASy4, V4.7 Build 55

Multi Band Result:

SAR(1 g) = 1.34 mW/g; SAR(10 g) = 0.551 mW/g

Maximum value of SAR (measured) = 1.43 mW/g

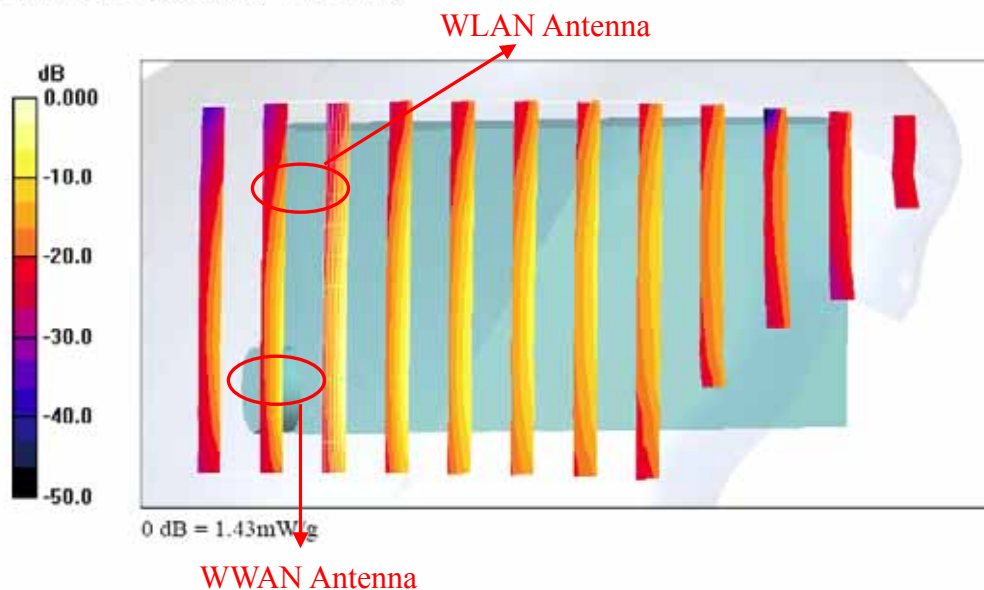

Test Laboratory: Sporton International Inc. SAR/HAC Testing Lab

Left Tilted_802.11g Ch6_Volume Scan

DUT: 840317

Communication System: 802.11g; Frequency: 2437 MHz; Duty Cycle: 1:1

Medium: HSL_2450 Medium parameters used: $f = 2437$ MHz; $\sigma = 1.83$ mho/m; $\epsilon_r = 37.8$; $\rho = 1000$ kg/m³

Phantom section: Left Section

Measurement Standard: DASY4 (High Precision Assessment)

- Probe: ET3DV6 - SN1787; ConvF(4.5, 4.5, 4.5); Calibrated: 2007/8/28
- Sensor-Surface: 4mm (Mechanical Surface Detection)
- Electronics: DAE4 Sn778; Calibrated: 2007/9/17
- Phantom: SAM-B; Type: QD 000 P40 C; Serial: TP-1383
- Measurement SW: DASY4, V4.7 Build 55

Test Laboratory: Sporton International Inc. SAR/HAC Testing Lab

Left Tilted_GSM1900 Ch512_Volume Scan

DUT: 840317

Communication System: PCS; Frequency: 1850.2 MHz; Duty Cycle: 1:8.3

Medium: HSL_1900 Medium parameters used : $f = 1850.2$ MHz; $\sigma = 1.38$ mho/m; $\epsilon_r = 39.2$; $\rho = 1000$ kg/m³

Phantom section: Left Section

Measurement Standard: DASY4 (High Precision Assessment)

- Probe: ET3DV6 - SN1787; ConvF(5.16, 5.16, 5.16); Calibrated: 2007/8/28
- Sensor-Surface: 4mm (Mechanical Surface Detection)
- Electronics: DAE4 Sn778; Calibrated: 2007/9/17
- Phantom: SAM-B; Type: QD 000 P40 C; Serial: TP-1383
- Measurement SW: DASY4, V4.7 Build 55

Multi Band Result:

SAR(1 g) = 0.649 mW/g; SAR(10 g) = 0.398 mW/g

Maximum value of SAR (measured) = 0.677 mW/g

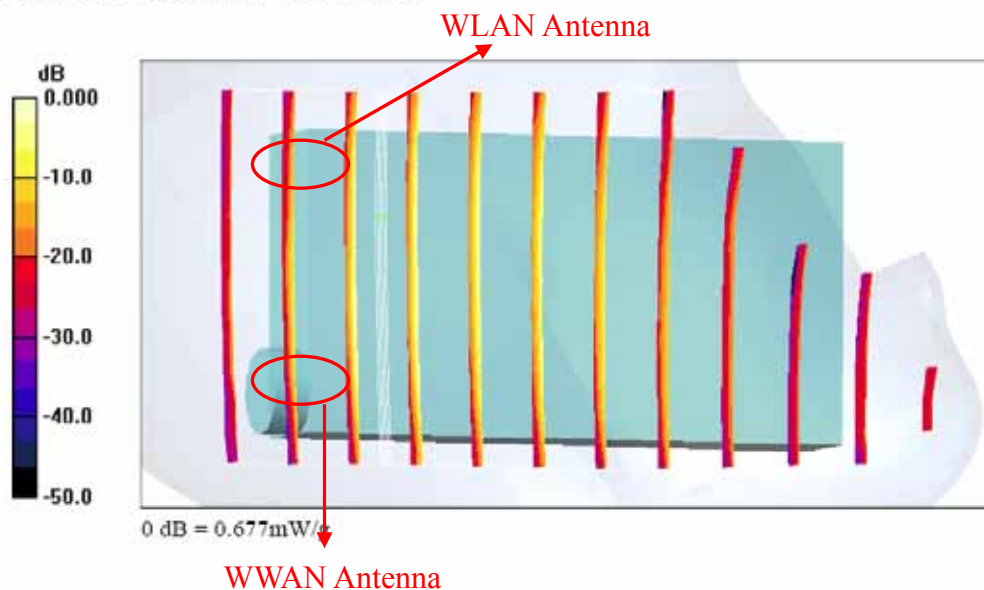

Test Laboratory: Sporton International Inc. SAR/HAC Testing Lab

Body_802.11g Ch6_Front Face with 0cm Gap_Volume Scan

DUT: 840317

Communication System: 802.11g; Frequency: 2437 MHz; Duty Cycle: 1:1

Medium: MSL_2450 Medium parameters used: $f = 2437$ MHz; $\sigma = 1.96$ mho/m; $\epsilon_r = 53.4$; $\rho = 1000$ kg/m³

Phantom section: Flat Section

Measurement Standard: DASy4 (High Precision Assessment)

- Probe: ET3DV6 - SN1787; ConvF(4.02, 4.02, 4.02); Calibrated: 2007/8/28
- Sensor-Surface: 4mm (Mechanical Surface Detection)
- Electronics: DAE4 Sn778; Calibrated: 2007/9/17
- Phantom: SAM-B; Type: QD 000 P40 C; Serial: TP-1383
- Measurement SW: DASy4, V4.7 Build 55

Test Laboratory: Sporton International Inc. SAR/HAC Testing Lab

Body_GSM850 Ch251_Front Face with 0cm Gap_Volume Scan

DUT: 840317

Communication System: GSM850; Frequency: 848.8 MHz; Duty Cycle: 1:4

Medium: MSL_850 Medium parameters used: $f = 849$ MHz; $\sigma = 1$ mho/m; $\epsilon_r = 56.1$; $\rho = 1000$ kg/m³

Phantom section: Flat Section

Measurement Standard: DASy4 (High Precision Assessment)

- Probe: ET3DV6 - SN1787; ConvF(6.1, 6.1, 6.1); Calibrated: 2007/8/28
- Sensor-Surface: 4mm (Mechanical Surface Detection)
- Electronics: DAE4 Sn778; Calibrated: 2007/9/17
- Phantom: SAM-B; Type: QD 000 P40 C; Serial: TP-1383
- Measurement SW: DASy4, V4.7 Build 55

Multi Band Result:

SAR(1 g) = 1.30 mW/g; SAR(10 g) = 0.710 mW/g

Maximum value of SAR (measured) = 1.42 mW/g

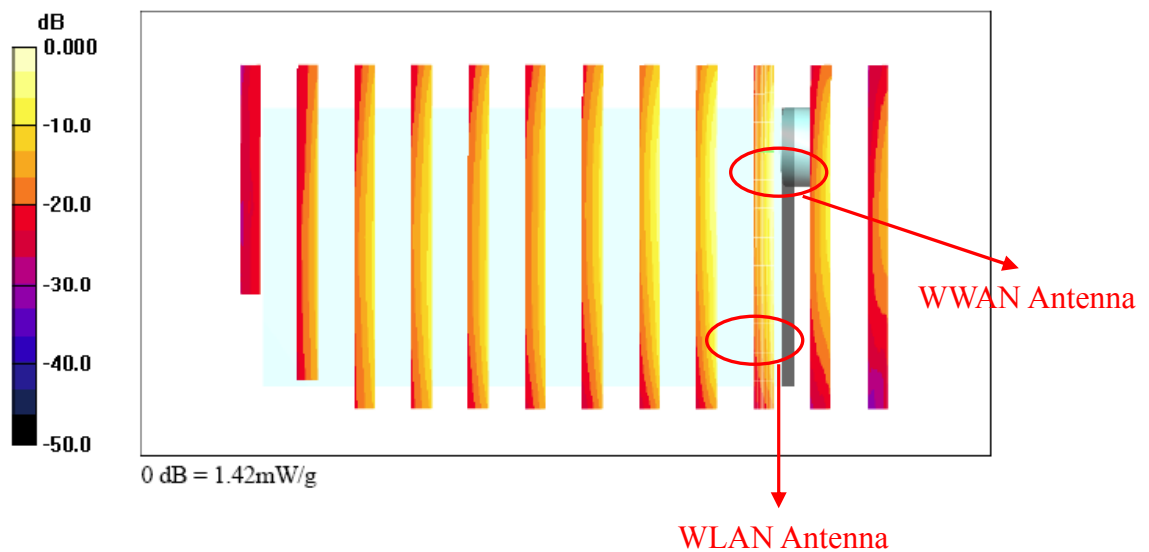

Test Laboratory: Sporton International Inc. SAR/HAC Testing Lab

Body_802.11g Ch6_Front Face with 0cm Gap_Volume Scan

DUT: 840317

Communication System: 802.11g; Frequency: 2437 MHz; Duty Cycle: 1:1

Medium: MSL_2450 Medium parameters used: $f = 2437$ MHz; $\sigma = 1.96$ mho/m; $\epsilon_r = 53.4$; $\rho = 1000$ kg/m³

Phantom section: Flat Section

Measurement Standard: DASY4 (High Precision Assessment)

- Probe: ET3DV6 - SN1787; ConvF(4.02, 4.02, 4.02); Calibrated: 2007/8/28
- Sensor-Surface: 4mm (Mechanical Surface Detection)
- Electronics: DAE4 Sn778; Calibrated: 2007/9/17
- Phantom: SAM-B; Type: QD 000 P40 C; Serial: TP-1383
- Measurement SW: DASY4, V4.7 Build 55

Test Laboratory: Sporton International Inc. SAR/HAC Testing Lab

Body_GSM1900 Ch512_Front Face with 0cm Gap_Volume Scan

DUT: 840317

Communication System: PCS 1900; Frequency: 1850.2 MHz; Duty Cycle: 1:4

Medium: MSL_1900 Medium parameters used : $f = 1850.2$ MHz; $\sigma = 1.17$ mho/m; $\epsilon_r = 51.4$; $\rho = 1000$ kg/m³

Phantom section: Flat Section

Measurement Standard: DASY4 (High Precision Assessment)

- Probe: ET3DV6 - SN1787; ConvF(4.68, 4.68, 4.68); Calibrated: 2007/8/28
- Sensor-Surface: 4mm (Mechanical Surface Detection)
- Electronics: DAE4 Sn778; Calibrated: 2007/9/17
- Phantom: SAM-B; Type: QD 000 P40 C; Serial: TP-1383
- Measurement SW: DASY4, V4.7 Build 55

Multi Band Result:

SAR(1 g) = 0.805 mW/g; SAR(10 g) = 0.479 mW/g

Maximum value of SAR (measured) = 0.863 mW/g

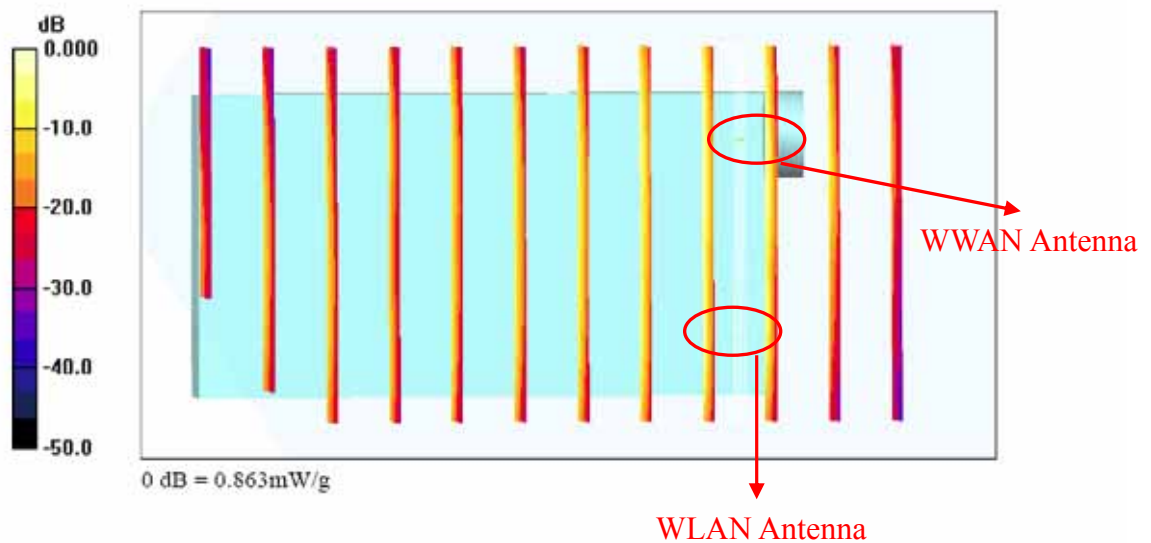



Test Laboratory: Sporton International Inc. SAR/HAC Testing Lab

Date: 2008/4/11

Left Tilted_802.11g Ch6_Sample D_2D

DUT: 840317

Communication System: 802.11g; Frequency: 2437 MHz; Duty Cycle: 1:1

Medium: HSL_2450 Medium parameters used: $f = 2437$ MHz; $\sigma = 1.83$ mho/m; $\epsilon_r = 37.8$; $\rho = 1000$ kg/m³

Ambient Temperature : 22.8 °C; Liquid Temperature : 21.5 °C

DASY4 Configuration:

- Probe: ET3DV6 - SN1787; ConvF(4.5, 4.5, 4.5); Calibrated: 2007/8/28
- Sensor-Surface: 4mm (Mechanical Surface Detection)
- Electronics: DAE4 Sn778; Calibrated: 2007/9/17
- Phantom: SAM-B; Type: QD 000 P40 C; Serial: TP-1383
- Measurement SW: DASY4, V4.7 Build 55; Postprocessing SW: SEMCAD, V1.8 Build 176

Ch6/Area Scan (71x121x1): Measurement grid: dx=15mm, dy=15mm
Maximum value of SAR (interpolated) = 0.512 mW/g

Ch6/Zoom Scan (5x5x7)/Cube 0: Measurement grid: dx=8mm, dy=8mm, dz=5mm
Reference Value = 11.7 V/m; Power Drift = -0.111 dB
Peak SAR (extrapolated) = 1.10 W/kg
SAR(1 g) = 0.431 mW/g; SAR(10 g) = 0.195 mW/g
Maximum value of SAR (measured) = 0.471 mW/g





Test Laboratory: Sporton International Inc. SAR/HAC Testing Lab

Date: 2008/4/9

Body_802.11g Ch6_Front Face with 0cm Gap_Sample B_2D

DUT: 840317

Communication System: 802.11g; Frequency: 2437 MHz; Duty Cycle: 1:1

Medium: MSL_2450 Medium parameters used: $f = 2437$ MHz; $\sigma = 1.96$ mho/m; $\epsilon_r = 53.4$; $\rho = 1000$ kg/m³

Ambient Temperature : 22.9 °C; Liquid Temperature : 21.6 °C

DASY4 Configuration:

- Probe: ET3DV6 - SN1787; ConvF(4.02, 4.02, 4.02); Calibrated: 2007/8/28
- Sensor-Surface: 4mm (Mechanical Surface Detection)
- Electronics: DAE4 Sn778; Calibrated: 2007/9/17
- Phantom: SAM-B; Type: QD 000 P40 C; Serial: TP-1383
- Measurement SW: DASY4, V4.7 Build 55; Postprocessing SW: SEMCAD, V1.8 Build 176

Ch6/Area Scan (71x121x1): Measurement grid: dx=15mm, dy=15mm

Maximum value of SAR (interpolated) = 0.523 mW/g

Ch6/Zoom Scan (5x5x7)/Cube 0: Measurement grid: dx=8mm, dy=8mm, dz=5mm

Reference Value = 9.17 V/m; Power Drift = -0.124 dB

Peak SAR (extrapolated) = 1.31 W/kg

SAR(1 g) = 0.519 mW/g; SAR(10 g) = 0.222 mW/g

Maximum value of SAR (measured) = 0.599 mW/g

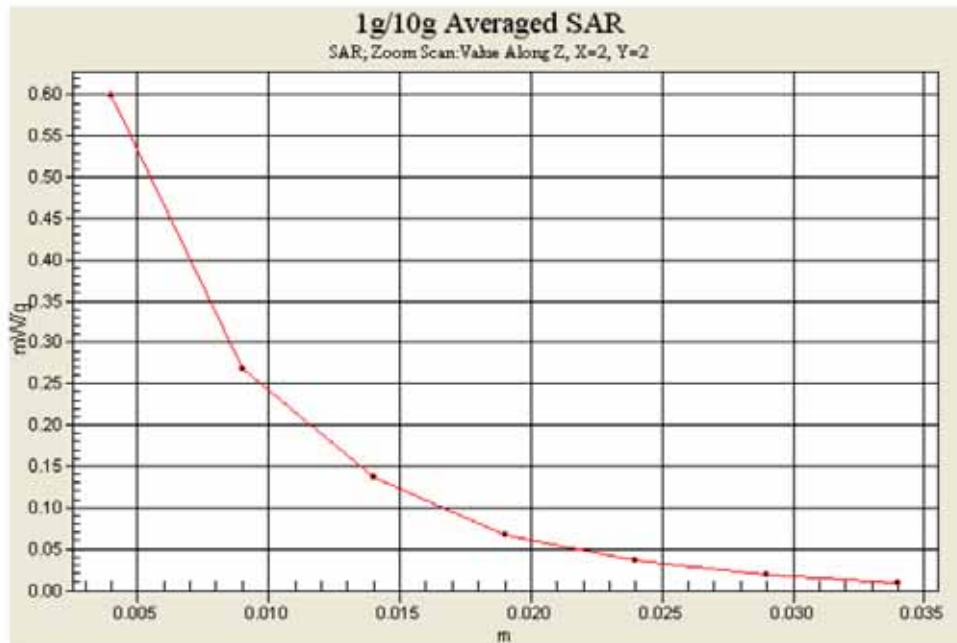



Appendix C – Calibration Data

Calibration Laboratory of Schmid & Partner Engineering AG



S Schweizerischer Kalibrierdienst
C Service suisse d'etalonnage
S Servizio svizzero di taratura
S Swiss Calibration Service

Accredited by the Swiss Federal Office of Metrology and Accreditation
The Swiss Accreditation Service is one of the signatories to the EA Multilateral Agreement for the recognition of calibration certificates

Accreditation No.: SCS 108

Client Sporton (Auden)

Certificate No: D2450V2-736_Jul07

CALIBRATION CERTIFICATE
Object: D2450V2 - SN: 736
Calibration procedure(s): QA CAL-05.v6
Calibration date: July 12, 2007
Condition of the calibrated item: In Tolerance
This calibration certificate documents the traceability to national standards...
All calibrations have been conducted in the closed laboratory facility...
Calibration Equipment used (M&TE critical for calibration)
Primary Standards table with columns: Primary Standards, ID #, Cal Date (Calibrated by, Certificate No.), Scheduled Calibration
Secondary Standards table with columns: Secondary Standards, ID #, Check Date (in house), Scheduled Check
Calibrated by: Mike Mell, Laboratory Technician
Approved by: Katja Pokovic, Technical Manager
Issued: July 12, 2007

**Calibration Laboratory of
Schmid & Partner
Engineering AG**
Zeughausstrasse 43, 8004 Zurich, Switzerland



S Schweizerischer Kalibrierdienst
C Service suisse d'étalonnage
S Servizio svizzero di taratura
S Swiss Calibration Service

Accredited by the Swiss Federal Office of Metrology and Accreditation
The Swiss Accreditation Service is one of the signatories to the EA
Multilateral Agreement for the recognition of calibration certificates

Accreditation No.: **SCS 108**

Glossary:

TSL	tissue simulating liquid
ConvF	sensitivity in TSL / NORM x,y,z
N/A	not applicable or not measured

Calibration is Performed According to the Following Standards:

- IEEE Std 1528-2003, "IEEE Recommended Practice for Determining the Peak Spatial-Averaged Specific Absorption Rate (SAR) in the Human Head from Wireless Communications Devices: Measurement Techniques", December 2003
- IEC 62209-1, "Procedure to measure the Specific Absorption Rate (SAR) for hand-held devices used in close proximity to the ear (frequency range of 300 MHz to 3 GHz)", February 2005
- Federal Communications Commission Office of Engineering & Technology (FCC OET), "Evaluating Compliance with FCC Guidelines for Human Exposure to Radiofrequency Electromagnetic Fields; Additional Information for Evaluating Compliance of Mobile and Portable Devices with FCC Limits for Human Exposure to Radiofrequency Emissions", Supplement C (Edition 01-01) to Bulletin 65

Additional Documentation:

- DASY4 System Handbook

Methods Applied and Interpretation of Parameters:

- Measurement Conditions:** Further details are available from the Validation Report at the end of the certificate. All figures stated in the certificate are valid at the frequency indicated.
- Antenna Parameters with TSL:** The dipole is mounted with the spacer to position its feed point exactly below the center marking of the flat phantom section, with the arms oriented parallel to the body axis.
- Feed Point Impedance and Return Loss:** These parameters are measured with the dipole positioned under the liquid filled phantom. The impedance stated is transformed from the measurement at the SMA connector to the feed point. The Return Loss ensures low reflected power. No uncertainty required.
- Electrical Delay:** One-way delay between the SMA connector and the antenna feed point. No uncertainty required.
- SAR measured:** SAR measured at the stated antenna input power.
- SAR normalized:** SAR as measured, normalized to an input power of 1 W at the antenna connector.
- SAR for nominal TSL parameters:** The measured TSL parameters are used to calculate the nominal SAR result.



Measurement Conditions

DASY system configuration, as far as not given on page 1.

DASY Version	DASY4	V4.7
Extrapolation	Advanced Extrapolation	
Phantom	Modular Flat Phantom V5.0	
Distance Dipole Center - TSL	10 mm	with Spacer
Zoom Scan Resolution	dx, dy, dz = 5 mm	
Frequency	2450 MHz ± 1 MHz	

Head TSL parameters

The following parameters and calculations were applied.

	Temperature	Permittivity	Conductivity
Nominal Head TSL parameters	22.0 °C	39.2	1.80 mho/m
Measured Head TSL parameters	(22.0 ± 0.2) °C	38.6 ± 6 %	1.81 mho/m ± 6 %
Head TSL temperature during test	(22.0 ± 0.2) °C	-----	-----

SAR result with Head TSL

SAR averaged over 1 cm ³ (1 g) of Head TSL	condition	
SAR measured	250 mW input power	13.3 mW / g
SAR normalized	normalized to 1W	53.2 mW / g
SAR for nominal Head TSL parameters ¹	normalized to 1W	52.7 mW / g ± 17.0 % (k=2)

SAR averaged over 10 cm ³ (10 g) of Head TSL	condition	
SAR measured	250 mW input power	6.17 mW / g
SAR normalized	normalized to 1W	24.7 mW / g
SAR for nominal Head TSL parameters ¹	normalized to 1W	24.5 mW / g ± 16.5 % (k=2)

¹ Correction to nominal TSL parameters according to d), chapter "SAR Sensitivities"



Body TSL parameters

The following parameters and calculations were applied.

	Temperature	Permittivity	Conductivity
Nominal Body TSL parameters	22.0 °C	52.7	1.95 mho/m
Measured Body TSL parameters	(22.0 ± 0.2) °C	53.5 ± 8 %	1.94 mho/m ± 6 %
Body TSL temperature during test	(22.0 ± 0.2) °C	----	----

SAR result with Body TSL

SAR averaged over 1 cm ³ (1 g) of Body TSL	Condition	
SAR measured	250 mW input power	13.0 mW / g
SAR normalized	normalized to 1W	52.0 mW / g
SAR for nominal Body TSL parameters ²	normalized to 1W	52.5 mW / g ± 17.0 % (k=2)

SAR averaged over 10 cm ³ (10 g) of Body TSL	Condition	
SAR measured	250 mW input power	6.05 mW / g
SAR normalized	normalized to 1W	24.2 mW / g
SAR for nominal Body TSL parameters ²	normalized to 1W	24.4 mW / g ± 16.5 % (k=2)

² Correction to nominal TSL parameters according to d), chapter "SAR Sensitivities"



Appendix

Antenna Parameters with Head TSL

Impedance, transformed to feed point	53.1 Ω + 3.0 j Ω
Return Loss	- 27.6 dB

Antenna Parameters with Body TSL

Impedance, transformed to feed point	48.7 Ω + 4.6 j Ω
Return Loss	- 26.3 dB

General Antenna Parameters and Design

Electrical Delay (one direction)	1.158 ns
----------------------------------	----------

After long term use with 100W radiated power, only a slight warming of the dipole near the feedpoint can be measured.

The dipole is made of standard semirigid coaxial cable. The center conductor of the feeding line is directly connected to the second arm of the dipole. The antenna is therefore short-circuited for DC-signals.

No excessive force must be applied to the dipole arms, because they might bend or the soldered connections near the feedpoint may be damaged.

Additional EUT Data

Manufactured by	SPEAG
Manufactured on	August 26, 2003

DASY4 Validation Report for Head TSL

Date/Time: 12.07.2007 11:00:03

Test Laboratory: SPEAG, Zurich, Switzerland

DUT: Dipole 2450 MHz; Type: D2450V2; Serial: D2450V2 - SN736

Communication System: CW-2450; Frequency: 2450 MHz; Duty Cycle: 1:1

Medium: HSL U10 BB;

Medium parameters used: $f = 2450$ MHz; $\sigma = 1.81$ mho/m; $\epsilon_r = 38.6$; $\rho = 1000$ kg/m³

Phantom section: Flat Section

Measurement Standard: DASY4 (High Precision Assessment)

DASY4 Configuration:

- Probe: ES3DV2 - SN3025 (HF); ConvP(4.5, 4.5, 4.5); Calibrated: 19.10.2006
- Sensor-Surface: 4mm (Mechanical Surface Detection)
- Electronics: DAE4 Sn601; Calibrated: 30.01.2007
- Phantom: Flat Phantom 5.0 (front); Type: QD00P50AA
- Measurement SW: DASY4, V4.7 Build 53; Postprocessing SW: SEMCAD, V1.8 Build 172

Pin = 250 mW; d = 10 mm/Zoom Scan (7x7x7)/Cube 0:

Measurement grid: dx=5mm, dy=5mm, dz=5mm

Reference Value = 93.0 V/m; Power Drift = -0.004 dB

Peak SAR (extrapolated) = 28.1 W/kg

SAR(1 g) = 13.3 mW/g; SAR(10 g) = 6.17 mW/g

Maximum value of SAR (measured) = 15.0 mW/g

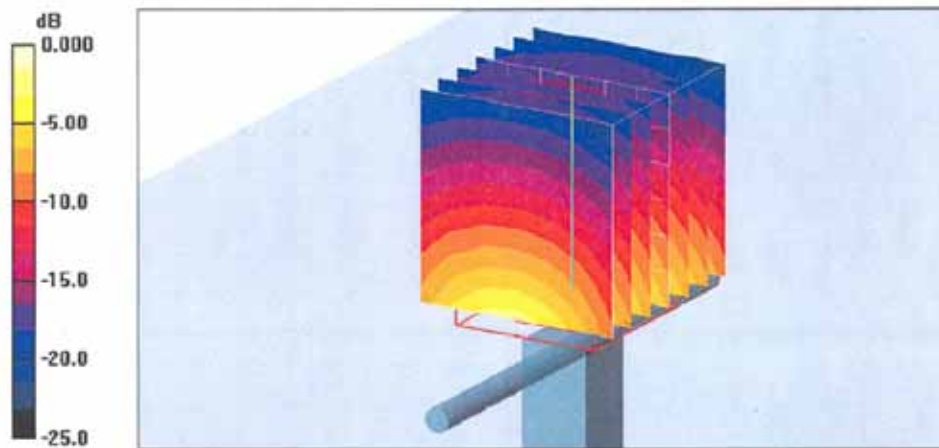

0 dB = 15.0mW/g



Impedance Measurement Plot for Head TSL

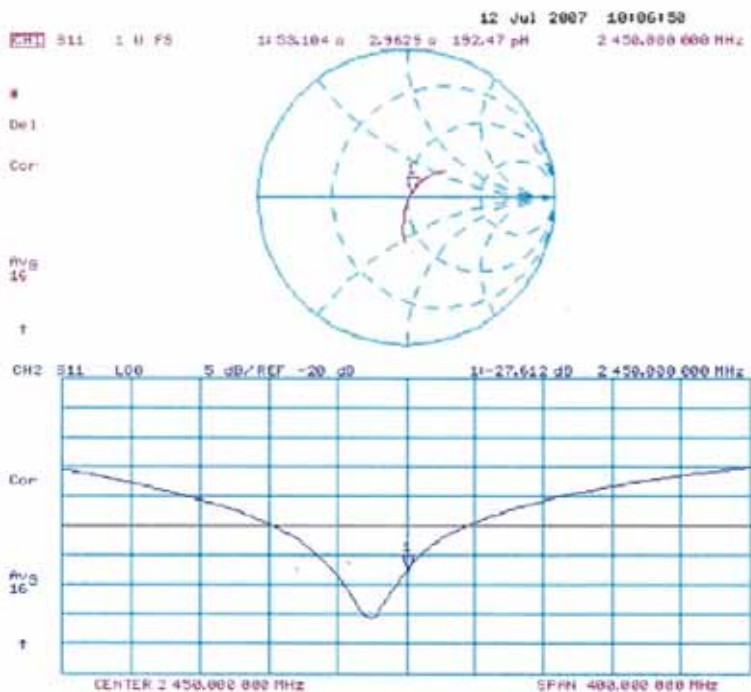

DASY4 Validation Report for Body TSL

Date/Time: 12.07.2007 12:28:49

Test Laboratory: SPEAG, Zurich, Switzerland

DUT: Dipole 2450 MHz; Type: D2450V2; Serial: D2450V2 - SN736

Communication System: CW-2450; Frequency: 2450 MHz; Duty Cycle: 1:1

Medium: MSL U10 BB;

Medium parameters used: $f = 2450$ MHz; $\sigma = 1.94$ mho/m; $\epsilon_r = 53.5$; $\rho = 1000$ kg/m³

Phantom section: Flat Section

Measurement Standard: DASY4 (High Precision Assessment)

DASY4 Configuration:

- Probe: ES3DV2 - SN3025 (HF); ConvF(4 16, 4 16, 4 16); Calibrated: 19.10.2006
- Sensor-Surface: 4mm (Mechanical Surface Detection)
- Electronics: DAE4 Sn601; Calibrated: 30.01.2007
- Phantom: Flat Phantom 5.0 (back); Type: QD000P50AA
- Measurement SW: DASY4, V4.7 Build 53; Postprocessing SW: SEMCAD, V1.8 Build 172

Pin = 250 mW; d = 10 mm/Zoom Scan (7x7x7)/Cube 0:

Measurement grid: dx=5mm, dy=5mm, dz=5mm

Reference Value = 88.6 V/m; Power Drift = 0.005 dB

Peak SAR (extrapolated) = 27.0 W/kg

SAR(1 g) = 13 mW/g; SAR(10 g) = 6.05 mW/g

Maximum value of SAR (measured) = 14.8 mW/g

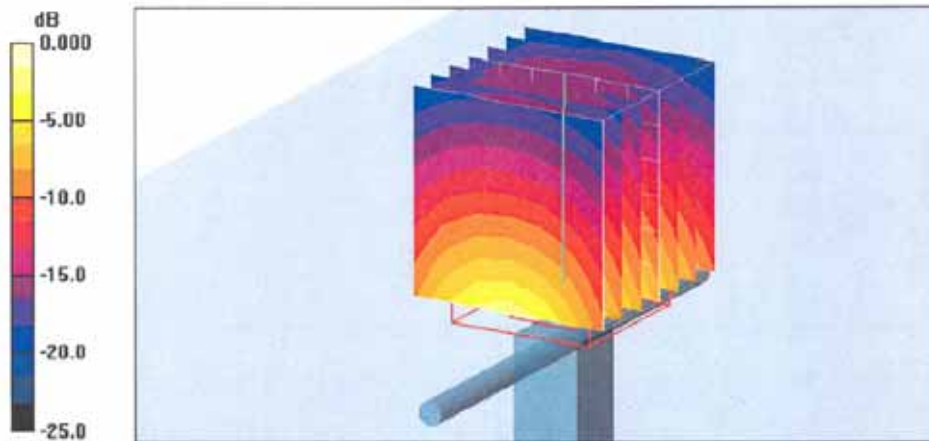

0 dB = 14.8mW/g



Impedance Measurement Plot for Body TSL

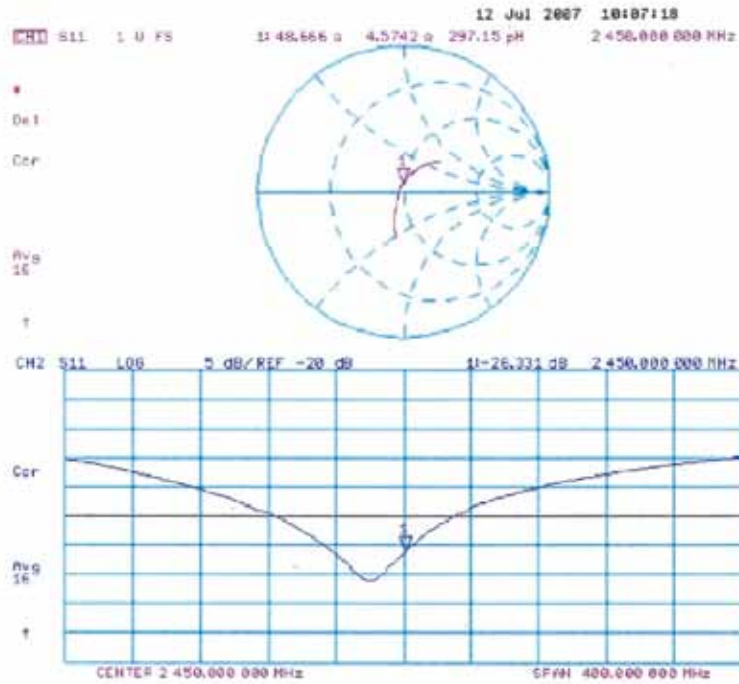



Calibration Laboratory of Schmid & Partner Engineering AG Zeughausstrasse 43, 8004 Zurich, Switzerland



S Schweizerischer Kalibrierdienst
C Service suisse d'etalonnage
S Servizio svizzero di taratura
S Swiss Calibration Service

Accredited by the Swiss Federal Office of Metrology and Accreditation The Swiss Accreditation Service is one of the signatories to the EA Multilateral Agreement for the recognition of calibration certificates

Accreditation No.: SCS 108

Client Sporton (Autoren)

Certificate No: DAE4-778_Sep07

CALIBRATION CERTIFICATE

Object: DAE4 - SD 000 D04 BG - SN: 778
Calibration procedure(s): QA CAL-06.v12 Calibration procedure for the data acquisition electronics (DAE)
Calibration date: September 17, 2007
Condition of the calibrated item: In Tolerance

This calibration certificate documents the traceability to national standards, which realize the physical units of measurements (SI). The measurements and the uncertainties with confidence probability are given on the following pages and are part of the certificate.

All calibrations have been conducted in the closed laboratory facility: environment temperature (22 ± 3)°C and humidity < 70%.

Calibration Equipment used (M&TE critical for calibration)

Table with 4 columns: Primary Standards, ID #, Cal Date (Calibrated by, Certificate No.), Scheduled Calibration. Includes entries for Fluke Process Calibrator Type 702 and Keithley Multimeter Type 2001.

Table with 4 columns: Secondary Standards, ID #, Check Date (in house), Scheduled Check. Includes entry for Calibrator Box V1.1.

Calibrated by: Dominique Steffen, Technician
Approved by: Fin Bomholt, R&D Director

Signatures of Dominique Steffen and Fin Bomholt

Issued: September 17, 2007

This calibration certificate shall not be reproduced except in full without written approval of the laboratory.

**Calibration Laboratory of
Schmid & Partner
Engineering AG**
Zeughausstrasse 43, 8004 Zurich, Switzerland



S Schweizerischer Kalibrierdienst
C Service suisse d'étalonnage
S Servizio svizzero di taratura
S Swiss Calibration Service

Accredited by the Swiss Federal Office of Metrology and Accreditation
The Swiss Accreditation Service is one of the signatories to the EA
Multilateral Agreement for the recognition of calibration certificates

Accreditation No.: **SCS 108**

Glossary

DAE data acquisition electronics
Connector angle information used in DASY system to align probe sensor X to the robot coordinate system.

Methods Applied and Interpretation of Parameters

- **DC Voltage Measurement:** Calibration Factor assessed for use in DASY system by comparison with a calibrated instrument traceable to national standards. The figure given corresponds to the full scale range of the voltmeter in the respective range.
- **Connector angle:** The angle of the connector is assessed measuring the angle mechanically by a tool inserted. Uncertainty is not required.
- The following parameters contain technical information as a result from the performance test and require no uncertainty.
- **DC Voltage Measurement Linearity:** Verification of the Linearity at +10% and -10% of the nominal calibration voltage. Influence of offset voltage is included in this measurement.
- **Common mode sensitivity:** Influence of a positive or negative common mode voltage on the differential measurement.
- **Channel separation:** Influence of a voltage on the neighbor channels not subject to an input voltage.
- **AD Converter Values with inputs shorted:** Values on the internal AD converter corresponding to zero input voltage
- **Input Offset Measurement:** Output voltage and statistical results over a large number of zero voltage measurements.
- **Input Offset Current:** Typical value for information; Maximum channel input offset current, not considering the input resistance.
- **Input resistance:** DAE input resistance at the connector, during internal auto-zeroing and during measurement.
- **Low Battery Alarm Voltage:** Typical value for information. Below this voltage, a battery alarm signal is generated.
- **Power consumption:** Typical value for information. Supply currents in various operating modes.



DC Voltage Measurement

A/D - Converter Resolution nominal

High Range: 1LSB = 6.1µV , full range = -100...+300 mV

Low Range: 1LSB = 61nV , full range = -1.....+3mV

DASY measurement parameters: Auto Zero Time: 3 sec; Measuring time: 3 sec

Calibration Factors	X	Y	Z
High Range	404.715 ± 0.1% (k=2)	403.520 ± 0.1% (k=2)	405.065 ± 0.1% (k=2)
Low Range	3.99539 ± 0.7% (k=2)	3.96323 ± 0.7% (k=2)	3.97102 ± 0.7% (k=2)

Connector Angle

Connector Angle to be used in DASY system	309 ° ± 1 °
---	-------------

Appendix

1. DC Voltage Linearity

High Range	Input (μV)	Reading (μV)	Error (%)
Channel X + Input	200000	199999.5	0.00
Channel X + Input	20000	20004.41	0.02
Channel X - Input	20000	-20002.56	0.01
Channel Y + Input	200000	200000.3	0.00
Channel Y + Input	20000	20003.67	0.02
Channel Y - Input	20000	-20003.41	0.02
Channel Z + Input	200000	200000.3	0.00
Channel Z + Input	20000	20002.49	0.01
Channel Z - Input	20000	-20006.25	0.03

Low Range	Input (μV)	Reading (μV)	Error (%)
Channel X + Input	2000	1999.9	0.00
Channel X + Input	200	199.47	-0.26
Channel X - Input	200	-200.56	0.28
Channel Y + Input	2000	2000.1	0.00
Channel Y + Input	200	199.15	-0.43
Channel Y - Input	200	-200.77	0.39
Channel Z + Input	2000	2000	0.00
Channel Z + Input	200	199.22	-0.39
Channel Z - Input	200	-201.39	0.69

2. Common mode sensitivity

DASY measurement parameters: Auto Zero Time: 3 sec; Measuring time: 3 sec

	Common mode Input Voltage (mV)	High Range Average Reading (μV)	Low Range Average Reading (μV)
Channel X	200	-6.00	-6.42
	- 200	7.17	6.60
Channel Y	200	-2.49	-2.64
	- 200	2.04	1.25
Channel Z	200	-10.83	-10.80
	- 200	9.19	8.80

3. Channel separation

DASY measurement parameters: Auto Zero Time: 3 sec; Measuring time: 3 sec

	Input Voltage (mV)	Channel X (μV)	Channel Y (μV)	Channel Z (μV)
Channel X	200	-	2.57	0.15
Channel Y	200	0.11	-	4.08
Channel Z	200	-1.80	1.03	-

4. AD-Converter Values with inputs shorted

DASY measurement parameters: Auto Zero Time: 3 sec; Measuring time: 3 sec

	High Range (LSB)	Low Range (LSB)
Channel X	16068	16321
Channel Y	16180	16239
Channel Z	16405	16167

5. Input Offset Measurement

DASY measurement parameters: Auto Zero Time: 3 sec; Measuring time: 3 sec

Input 10MΩ

	Average (μV)	min. Offset (μV)	max. Offset (μV)	Std. Deviation (μV)
Channel X	-0.14	-1.23	0.61	0.34
Channel Y	-0.85	-2.24	0.48	0.49
Channel Z	-1.24	-2.43	0.38	0.51

6. Input Offset Current

Nominal Input circuitry offset current on all channels: <25fA

7. Input Resistance

	Zeroing (MOhm)	Measuring (MOhm)
Channel X	0.2000	201.7
Channel Y	0.2000	201.7
Channel Z	0.1999	202.5

8. Low Battery Alarm Voltage (verified during pre test)

Typical values	Alarm Level (VDC)
Supply (+ Vcc)	+7.9
Supply (- Vcc)	-7.6

9. Power Consumption (verified during pre test)

Typical values	Switched off (mA)	Stand by (mA)	Transmitting (mA)
Supply (+ Vcc)	+0.0	+6	+14
Supply (- Vcc)	-0.01	-8	-9



Calibration Laboratory of Schmid & Partner Engineering AG



S Schweizerischer Kalibrierdienst
C Service suisse d'etalonnage
S Servizio svizzero di taratura
S Swiss Calibration Service

Accredited by the Swiss Federal Office of Metrology and Accreditation
The Swiss Accreditation Service is one of the signatories to the EA Multilateral Agreement for the recognition of calibration certificates

Accreditation No.: SCS 108

Client Sporton (Auden)

Certificate No: ET3-1787_Aug07

CALIBRATION CERTIFICATE

Object ET3DV6 - SN:1787

Calibration procedure(s) QA CAL-01.v6
Calibration procedure for dosimetric E-field probes

Calibration date: August 28, 2007

Condition of the calibrated item In Tolerance

This calibration certificate documents the traceability to national standards, which realize the physical units of measurements (SI).
The measurements and the uncertainties with confidence probability are given on the following pages and are part of the certificate.

All calibrations have been conducted in the closed laboratory facility: environment temperature (22 ± 3)°C and humidity < 70%.

Calibration Equipment used (M&E critical for calibration)

Table with 4 columns: Primary Standards, ID #, Cal Date (Calibrated by, Certificate No.), Scheduled Calibration. Lists various power meters, sensors, attenuators, and probes with their respective IDs and calibration dates.

Table with 4 columns: Secondary Standards, ID #, Check Date (in house), Scheduled Check. Lists an RF generator and a network analyzer with their in-house check dates.

Calibrated by: Katja Pokovic, Technical Manager

Approved by: Niels Kuster, Quality Manager

Handwritten signatures of Katja Pokovic and Niels Kuster.

Issued: August 29, 2007

This calibration certificate shall not be reproduced except in full without written approval of the laboratory.

Calibration Laboratory of
Schmid & Partner
Engineering AG
Zeughausstrasse 43, 8004 Zurich, Switzerland



S Schweizerischer Kalibrierdienst
C Service suisse d'étalonnage
S Servizio svizzero di taratura
S Swiss Calibration Service

Accredited by the Swiss Federal Office of Metrology and Accreditation
The Swiss Accreditation Service is one of the signatories to the EA
Multilateral Agreement for the recognition of calibration certificates

Accreditation No.: SCS 108

Glossary:

TSL	tissue simulating liquid
NORM _{x,y,z}	sensitivity in free space
ConvF	sensitivity in TSL / NORM _{x,y,z}
DCP	diode compression point
Polarization φ	φ rotation around probe axis
Polarization ϑ	ϑ rotation around an axis that is in the plane normal to probe axis (at measurement center), i.e., $\vartheta = 0$ is normal to probe axis

Calibration is Performed According to the Following Standards:

- a) IEEE Std 1528-2003, "IEEE Recommended Practice for Determining the Peak Spatial-Averaged Specific Absorption Rate (SAR) in the Human Head from Wireless Communications Devices: Measurement Techniques", December 2003
- b) IEC 62209-1, "Procedure to measure the Specific Absorption Rate (SAR) for hand-held devices used in close proximity to the ear (frequency range of 300 MHz to 3 GHz)", February 2005

Methods Applied and Interpretation of Parameters:

- **NORM_{x,y,z}**: Assessed for E-field polarization $\vartheta = 0$ ($f \leq 900$ MHz in TEM-cell; $f > 1800$ MHz: R22 waveguide). NORM_{x,y,z} are only intermediate values, i.e., the uncertainties of NORM_{x,y,z} does not effect the E²-field uncertainty inside TSL (see below ConvF).
- **NORM(f)_{x,y,z} = NORM_{x,y,z} * frequency_response** (see Frequency Response Chart). This linearization is implemented in DASY4 software versions later than 4.2. The uncertainty of the frequency response is included in the stated uncertainty of ConvF.
- **DCP_{x,y,z}**: DCP are numerical linearization parameters assessed based on the data of power sweep (no uncertainty required). DCP does not depend on frequency nor media.
- **ConvF and Boundary Effect Parameters**: Assessed in flat phantom using E-field (or Temperature Transfer Standard for $f \leq 800$ MHz) and inside waveguide using analytical field distributions based on power measurements for $f > 800$ MHz. The same setups are used for assessment of the parameters applied for boundary compensation (alpha, depth) of which typical uncertainty values are given. These parameters are used in DASY4 software to improve probe accuracy close to the boundary. The sensitivity in TSL corresponds to NORM_{x,y,z} * ConvF whereby the uncertainty corresponds to that given for ConvF. A frequency dependent ConvF is used in DASY version 4.4 and higher which allows extending the validity from ± 50 MHz to ± 100 MHz.
- **Spherical isotropy (3D deviation from isotropy)**: in a field of low gradients realized using a flat phantom exposed by a patch antenna.
- **Sensor Offset**: The sensor offset corresponds to the offset of virtual measurement center from the probe tip (on probe axis). No tolerance required.



ET3DV6 SN:1787

August 28, 2007

Probe ET3DV6

SN:1787

Manufactured:	May 28, 2003
Last calibrated:	May 31, 2006
Recalibrated:	August 28, 2007

Calibrated for DASY Systems

(Note: non-compatible with DASY2 system!)



ET3DV6 SN:1787

August 28, 2007

DASY - Parameters of Probe: ET3DV6 SN:1787

Sensitivity in Free Space^A

Diode Compression^B

NormX	1.53 ± 10.1%	$\mu V/(V/m)^2$	DCP X	92 mV
NormY	1.66 ± 10.1%	$\mu V/(V/m)^2$	DCP Y	96 mV
NormZ	2.08 ± 10.1%	$\mu V/(V/m)^2$	DCP Z	91 mV

Sensitivity in Tissue Simulating Liquid (Conversion Factors)

Please see Page 8.

Boundary Effect

TSL 900 MHz Typical SAR gradient: 5 % per mm

Sensor Center to Phantom Surface Distance		3.7 mm	4.7 mm
SAR _{iso} [%]	Without Correction Algorithm	4.7	2.0
SAR _{iso} [%]	With Correction Algorithm	0.1	0.0

TSL 1810 MHz Typical SAR gradient: 10 % per mm

Sensor Center to Phantom Surface Distance		3.7 mm	4.7 mm
SAR _{iso} [%]	Without Correction Algorithm	11.8	7.0
SAR _{iso} [%]	With Correction Algorithm	0.2	0.4

Sensor Offset

Probe Tip to Sensor Center 2.7 mm

The reported uncertainty of measurement is stated as the standard uncertainty of measurement multiplied by the coverage factor k=2, which for a normal distribution corresponds to a coverage probability of approximately 95%.

^A The uncertainties of NormX,Y,Z do not affect the E²-field uncertainty inside TSL (see Page 8).

^B Numerical linearization parameter: uncertainty not required.



ET3DV6 SN:1787

August 28, 2007

Frequency Response of E-Field

(TEM-Cell:ifi110 EXX, Waveguide: R22)

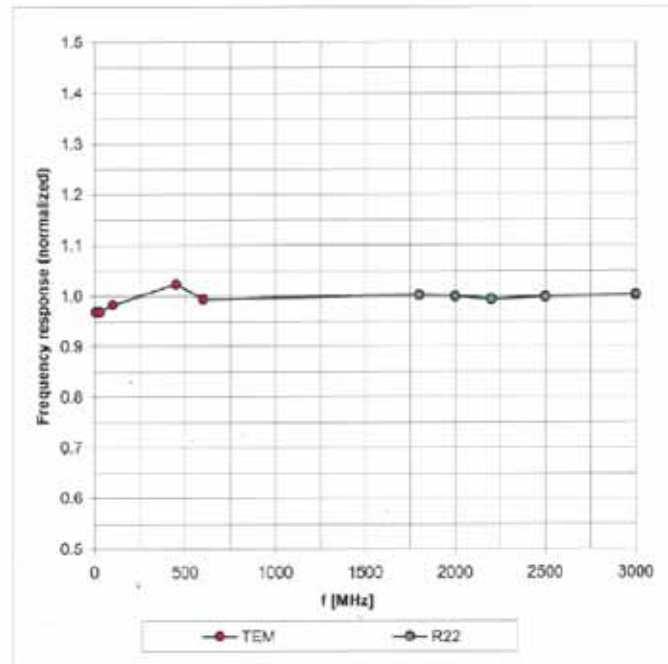

Uncertainty of Frequency Response of E-field: $\pm 6.3\%$ (k=2)

ET3DV6 SN:1787

August 28, 2007

Receiving Pattern (ϕ), $\theta = 0^\circ$

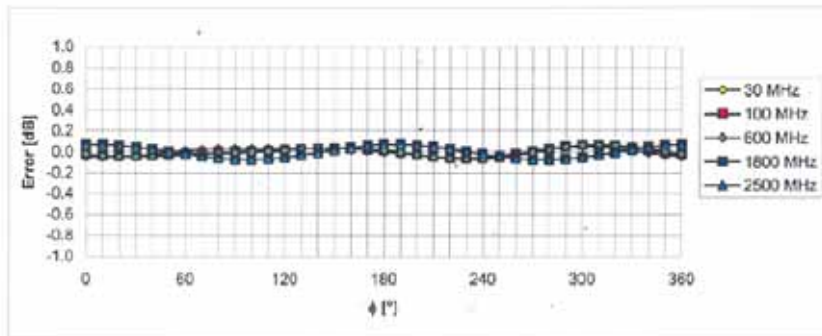
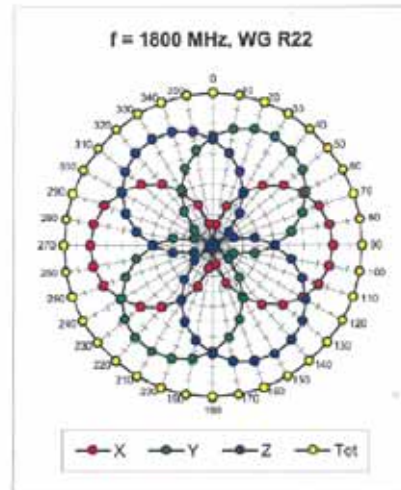
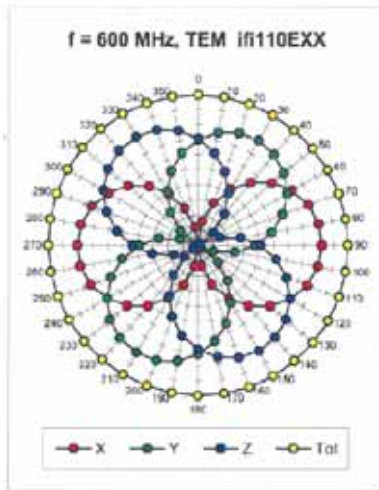

Uncertainty of Axial Isotropy Assessment: $\pm 0.5\%$ (k=2)



ET3DV6 SN:1787

August 28, 2007

Dynamic Range $f(\text{SAR}_{\text{head}})$ (Waveguide R22, $f = 1800 \text{ MHz}$)

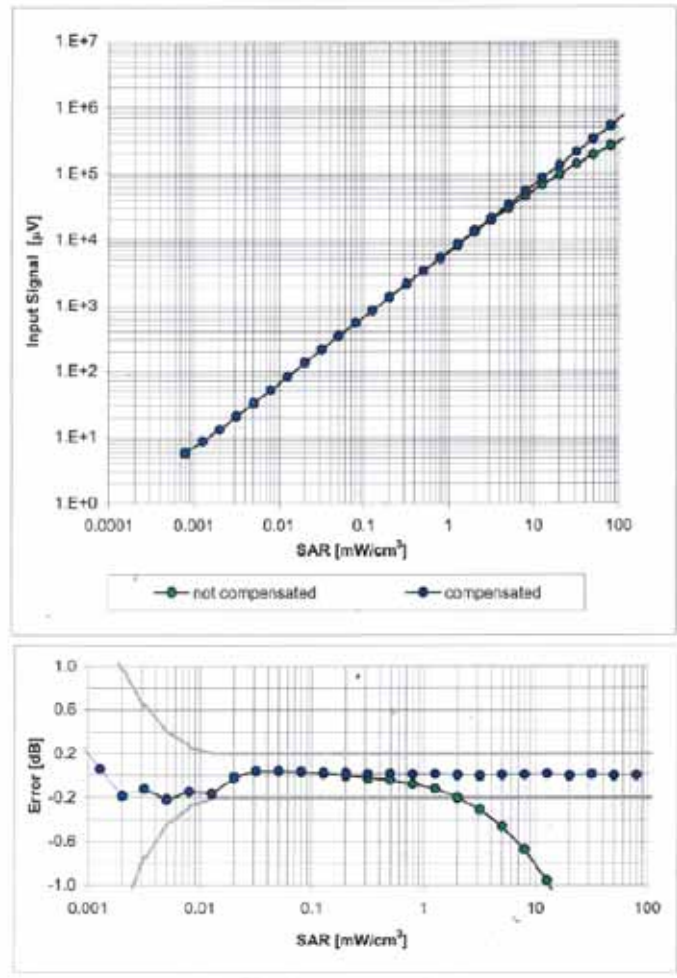

Uncertainty of Linearity Assessment: $\pm 0.6\%$ ($k=2$)

ET3DV6 SN:1787

August 28, 2007

Conversion Factor Assessment

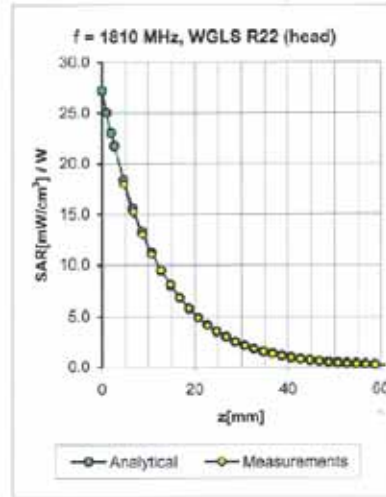
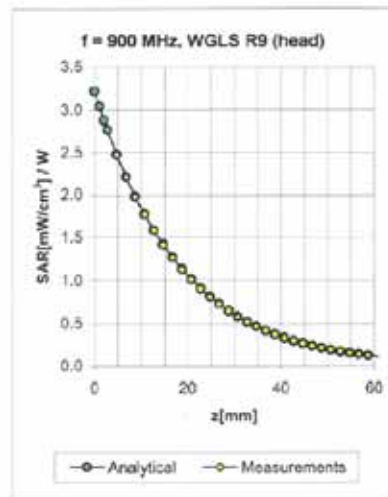

f [MHz]	Validity [MHz] ^c	TSL	Permittivity	Conductivity	Alpha	Depth	ConvF Uncertainty
900	± 50 / ± 100	Head	41.5 ± 5%	0.97 ± 5%	0.32	2.42	6.58 ± 11.0% (k=2)
1810	± 50 / ± 100	Head	40.0 ± 5%	1.40 ± 5%	0.50	2.61	5.16 ± 11.0% (k=2)
2000	± 50 / ± 100	Head	40.0 ± 5%	1.40 ± 5%	0.55	2.45	4.80 ± 11.0% (k=2)
2450	± 50 / ± 100	Head	39.2 ± 5%	1.80 ± 5%	0.67	1.81	4.50 ± 11.8% (k=2)
900	± 50 / ± 100	Body	55.0 ± 5%	1.05 ± 5%	0.36	2.52	6.10 ± 11.0% (k=2)
1810	± 50 / ± 100	Body	53.3 ± 5%	1.52 ± 5%	0.61	2.56	4.68 ± 11.0% (k=2)
2000	± 50 / ± 100	Body	53.3 ± 5%	1.52 ± 5%	0.60	2.40	4.30 ± 11.0% (k=2)
2450	± 50 / ± 100	Body	52.7 ± 5%	1.95 ± 5%	0.65	2.15	4.02 ± 11.8% (k=2)

^c The validity of ± 100 MHz only applies for DASV v4.4 and higher (see Page 2). The uncertainty is the RSS of the ConvF uncertainty at calibration frequency and the uncertainty for the indicated frequency band.

ET3DV6 SN:1787

August 28, 2007

Deviation from Isotropy in HSL

Error (θ, ϕ), $f = 900$ MHz

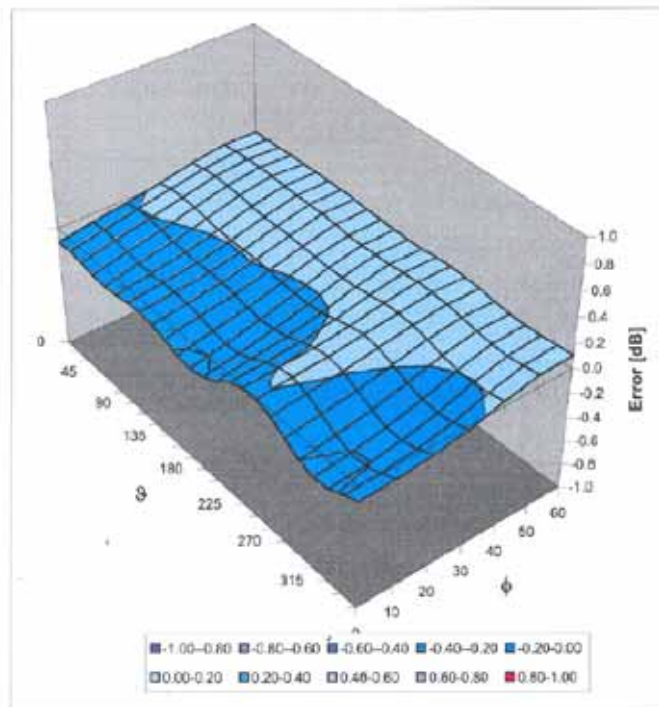

Uncertainty of Spherical Isotropy Assessment: $\pm 2.6\%$ (k=2)