



FCC TEST REPORT (PART 22)

REPORT NO.: RF951013L01

MODEL NO.: MC3504

RECEIVED: Oct. 13, 2006

TESTED: Oct. 13 ~ Oct. 20, 2006

ISSUED: Nov. 06, 2006

APPLICANT: Symbol Technologies, Inc.

ADDRESS: One Symbol Plaza
Holtsville, NY United States
11742-1300

ISSUED BY: Advance Data Technology Corporation

LAB ADDRESS: No. 47, 14th Ling, Chia Pau Tsuen, Lin Kou Hsiang
244, Taipei Hsien, Taiwan, R.O.C.

TEST LOCATION: No. 19, Hwa Ya 2nd Rd., Wen Hwa Tsuen, Kwei
Shan Hsiang, Taoyuan Hsien 333, Taiwan, R.O.C.

This test report consists of 59 pages in total. It may be duplicated completely for legal use with the approval of the applicant. It should not be reproduced except in full, without the written approval of our laboratory. The client should not use it to claim product endorsement by CNLA, A2LA or any government agencies. The test results in the report only apply to the tested sample.





TABLE OF CONTENTS

| | | |
|-------|---|----|
| 1 | CERTIFICATION..... | 4 |
| 2 | SUMMARY OF TEST RESULTS | 5 |
| 2.1 | MEASUREMENT UNCERTAINTY..... | 6 |
| 3 | GENERAL INFORMATION..... | 7 |
| 3.1 | GENERAL DESCRIPTION OF EUT | 7 |
| 3.2 | DESCRIPTION OF TEST MODES..... | 9 |
| 3.2.1 | CONFIGURATION OF SYSTEM UNDER TEST | 10 |
| 3.2.2 | TEST MODE APPLICABILITY AND TESTED CHANNEL DETAIL | 11 |
| 3.3 | GENERAL DESCRIPTION OF APPLIED STANDARDS | 13 |
| 3.4 | DESCRIPTION OF SUPPORT UNITS | 13 |
| 4 | TEST TYPES AND RESULTS | 14 |
| 4.1 | OUTPUT POWER MEASUREMENT..... | 14 |
| 4.1.1 | LIMITS OF OUTPUT POWER MEASUREMENT | 14 |
| 4.1.2 | TEST INSTRUMENTS..... | 15 |
| 4.1.3 | TEST PROCEDURES | 16 |
| 4.1.4 | TEST SETUP..... | 17 |
| 4.1.5 | EUT OPERATING CONDITIONS | 18 |
| 4.1.6 | TEST RESULTS | 19 |
| 4.2 | FREQUENCY STABILITY MEASUREMENT..... | 21 |
| 4.2.1 | LIMITS OF FREQUENCY STABILITY MEASUREMENT | 21 |
| 4.2.2 | TEST INSTRUMENTS..... | 21 |
| 4.2.3 | TEST PROCEDURE..... | 22 |
| 4.2.4 | TEST SETUP..... | 22 |
| 4.2.5 | TEST RESULTS | 23 |
| 4.3 | OCCUPIED BANDWIDTH MEASUREMENT | 26 |
| 4.3.1 | LIMITS OF OCCUPIED BANDWIDTH MEASUREMENT..... | 26 |
| 4.3.2 | TEST INSTRUMENTS..... | 26 |
| 4.3.3 | TEST SETUP..... | 27 |
| 4.3.4 | TEST PROCEDURES | 27 |
| 4.3.5 | TEST RESULTS | 28 |
| 4.4 | BAND EDGE MEASUREMENT..... | 34 |
| 4.4.1 | LIMITS OF BAND EDGE MEASUREMENT | 34 |
| 4.4.2 | TEST INSTRUMENTS..... | 34 |
| 4.4.3 | TEST SETUP..... | 34 |
| 4.4.4 | TEST PROCEDURES | 35 |
| 4.4.5 | EUT OPERATING CONDITION..... | 35 |
| 4.4.6 | TEST RESULTS | 36 |
| 4.5 | CONDUCTED SPURIOUS EMISSIONS | 39 |



| | | |
|-------|---|----|
| 4.5.1 | LIMITS OF CONDUCTED SPURIOUS EMISSIONS MEASUREMENT..... | 39 |
| 4.5.2 | TEST INSTRUMENTS..... | 39 |
| 4.5.3 | TEST PROCEDURE..... | 40 |
| 4.5.4 | TEST SETUP..... | 40 |
| 4.5.5 | EUT OPERATING CONDITIONS | 40 |
| 4.5.6 | TEST RESULTS | 41 |
| 4.6 | RADIATED EMISSION MEASUREMENT (BELOW 1GHz)..... | 47 |
| 4.6.1 | LIMITS OF RADIATED EMISSION MEASUREMENT | 47 |
| 4.6.2 | TEST INSTRUMENTS..... | 48 |
| 4.6.3 | TEST PROCEDURES | 49 |
| 4.6.4 | DEVIATION FROM TEST STANDARD..... | 49 |
| 4.6.5 | TEST SETUP..... | 50 |
| 4.6.6 | EUT OPERATING CONDITIONS | 50 |
| 4.6.7 | TEST RESULTS | 51 |
| 4.7 | RADIATED EMISSION MEASUREMENT (ABOVE 1GHz) | 52 |
| 4.7.1 | LIMITS OF RADIATED EMISSION MEASUREMENT | 52 |
| 4.7.2 | TEST INSTRUMENTS..... | 53 |
| 4.7.3 | TEST PROCEDURES | 54 |
| 4.7.4 | DEVIATION FROM TEST STANDARD..... | 54 |
| 4.7.5 | TEST SETUP..... | 55 |
| 4.7.6 | EUT OPERATING CONDITIONS | 55 |
| 4.7.7 | TEST RESULTS | 56 |
| 5 | INFORMATION ON THE TESTING LABORATORIES | 59 |



1 CERTIFICATION

PRODUCT: EDA (Enterprise Digital Assistant)

MODEL: MC3504

BRAND NAME: Symbol

APPLICANT: Symbol Technologies, Inc.

TESTED: Oct. 13 ~ Oct. 20, 2006

TEST SAMPLE: ENGINEERING SAMPLE

TEST STANDARDS: FCC Part 22, Subpart H
ANSI C63.4-2003

The above equipment has been tested by **Advance Data Technology Corporation**, and found compliance with the requirement of the above standards. The test record, data evaluation & Equipment Under Test (EUT) configurations represented herein are true and accurate accounts of the measurements of the sample's EMC characteristics under the conditions specified in this report.

PREPARED BY :  , **DATE:** Nov. 06, 2006
Stephanie Hung

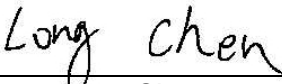
TECHNICAL ACCEPTANCE :  , **DATE:** Nov. 06, 2006
RESPONSIBLE FOR RF Long Chen

APPROVED BY :  , **DATE:** Nov. 06, 2006
Gary Chang / Supervisor

2 SUMMARY OF TEST RESULTS

The EUT has been tested according to the following specifications:

| APPLIED STANDARD: FCC Part 22 & Part 2 / IC RSS-132 | | | |
|---|--|--------|---|
| STANDARD SECTION | TEST TYPE AND LIMIT | RESULT | REMARK |
| 2.1046 22.913 (a) | Maximum Peak Output Power Limit: max. 7 watts e.r.p peak power | PASS | Meet the requirement of limit. Minimum passing margin is 29.11dBm at 848.8MHz. |
| 2.1055 | Frequency Stability AFC Freq. Error vs. Voltage AFC Freq. Error vs. Temperature Limit: max. ± 2.5 ppm | PASS | Meet the requirement of limit. |
| 2.1049 (h) | Occupied Bandwidth | PASS | Meet the requirement of limit. |
| 22.917 | Band Edge Measurements | PASS | Meet the requirement of limit. |
| 2.1051 22.917 | Conducted Spurious Emissions | PASS | Meet the requirement of limit. |
| 2.1053 22.917 | Radiated Spurious Emissions | PASS | Meet the requirement of limit. Minimum passing margin is -49.01 dB at 955.29MHz. |

2.1 MEASUREMENT UNCERTAINTY

Where relevant, the following measurement uncertainty levels have been estimated for tests performed on the EUT as specified in CISPR 16-4:

| MEASUREMENT | FREQUENCY | UNCERTAINTY |
|---------------------|-----------------|-------------|
| Conducted emissions | 9kHz ~ 30MHz | 2.44dB |
| Radiated emissions | 30MHz ~ 200MHz | 3.59dB |
| | 200MHz ~1000MHz | 3.61dB |
| | 1GHz ~ 18GHz | 2.26dB |
| | 18GHz ~ 40GHz | 1.94dB |

This uncertainty represents an expanded uncertainty expressed at approximately the 95% confidence level using a coverage factor of $k = 2$.



3 GENERAL INFORMATION

3.1 GENERAL DESCRIPTION OF EUT

| | |
|---|---|
| PRODUCT | EDA (Enterprise Digital Assistant) |
| MODEL NO. | MC3504 |
| FCC ID | H9PMC3504 |
| POWER SUPPLY | 3.7Vdc from rechargeable lithium battery 5.0Vdc from power adapter 5.0Vdc from host equipment |
| MODULATION TYPE | GMSK, 8-PSK for GSM, GPRS, EDGE |
| FREQUENCY RANGE | Tx: 824.2MHz ~ 848.8MHz Rx: 869.2MHz ~ 893.8MHz |
| NUMBER OF CHANNEL | 124 |
| MAX. CONDUCTED PEAK OUTPUT POWER | GSM: 32.70dBm (1.862W) GPRS: 32.60dBm (1.820W) E-GPRS: 29.80dBm (0.955W) |
| MAX. ERP POWER | GSM: 29.11dBm (0.815W) GPRS: 28.96dBm (0.787W) E-GPRS: 26.04dBm (0.402W) |
| ANTENNA TYPE | Fix internal antenna with -1.46dBi gain |
| DATA CABLE | 1.6m USB shielded cable with one core |
| I/O PORTS | Refer to user's manual |
| ASSOCIATED DEVICES | Adapter, 2 x lithium battery |
| EUT EXTREME VOL. RANGE | 3.3Vdc to 4.2Vdc |

NOTE:

1. The applicant defined the normal working voltage of the battery is from 3.3Vdc to 4.2Vdc.
2. The EUT is a GSM850/ PCS1900 EDA (Enterprise Digital Assistant) with bluetooth, and GPS functions. This report is only covered the functions of GSM850. The bluetooth function is covered in another test report, which standard used is FCC Part 15. And the PCS1900 mobile phone function is covered in another test report, which standard used is FCC Part 24.
3. The EUT have two different types, one is with CCD camera, and the other one is without.
4. The EUT have lithium batteries listed as below:

| | |
|-----------------------|-----------------|
| THICK BATTERY: | |
| BRAND: | Symbol |
| MODEL: | BTRY-MC35EABO2 |
| RATING: | 3.7Vdc, 2740mAh |

| THIN BATTERY: | |
|----------------|-----------------|
| BRAND: | Symbol |
| MODEL: | BTRY-35EABOE |
| RATING: | 3.7Vdc, 1370mAh |

NOTE: After pre-tested both batteries, found thick battery is worse, therefore all the test results came out from this.

- The EUT was operated with following power adapters:

| ADAPTER: | |
|--------------------|--|
| BRAND: | PHIHONG |
| MODEL: | PSM11R-050 |
| INPUT: | 100-240Vac, 50-60Hz, 0.3A, 26-34VA |
| OUTPUT: | 5.0Vdc, 2A max. |
| POWER LINE: | DC 1.85m non-shielded cable without core |

- IMEI code: 355634000000000-355634009999999.
- Hardware version: 1D.
- Software version: X12.
- The above EUT information was declared by manufacturer and for more detailed features description, please refers to the manufacturer's specifications or User's Manual.

3.2 DESCRIPTION OF TEST MODES

124 channels are provided to this EUT in the GSM850 band. Therefore, the low, middle and high channels are chosen for testing.

| | CHANNEL | FREQUENCY | MODE |
|--------|---------|-----------|-------------------|
| LOW | 128 | 824.2 MHz | GSM, GPRS, E-GPRS |
| MIDDLE | 190 | 836.6 MHz | GSM, GPRS, E-GPRS |
| HIGH | 251 | 848.8 MHz | GSM, GPRS, E-GPRS |

NOTE:

1. Below 1 GHz, the channel 128, 190, and 251 were pre-tested in chamber. The channel 128 was chosen for final test.
2. Above 1 GHz, the channel 128, 190, and 251 were tested individually.
3. When the Power Control Level set 5, the worst case, was chosen for final test.
4. The channel space is 0.2MHz.
5. Since the EUT is considered a portable unit, it was pre-tested on the positioned of each 3 axis. The worst case was found when positioned on Z-plane. Therefore only the test data of this Z-plane was used for radiated emission measurement test.
6. The EUT supports two battery options, think (high capacity) and thin (normal). Both options were assessed and the think battery was found to be worst case and was selected for the final test configuration.
7. The EUT is a GPRS class 12 device, which provide 4 up-link. The up-link with 1 time slot has been chosen for the worst case to do the final output power, frequency stability, occupied bandwidth, band edge test and recorded.
8. The EUT is an E-GPRS class 10 device, which provide 4 up-link. The up-link with 1 time slot has been chosen for the worst case to do the final output power, frequency stability, occupied bandwidth, band edge test and recorded.
9. The EUT have GSM, GPRS, E-GPRS functions. After pre-testing, GSM function is the worst case for all the emission tests.

3.2.1 CONFIGURATION OF SYSTEM UNDER TEST

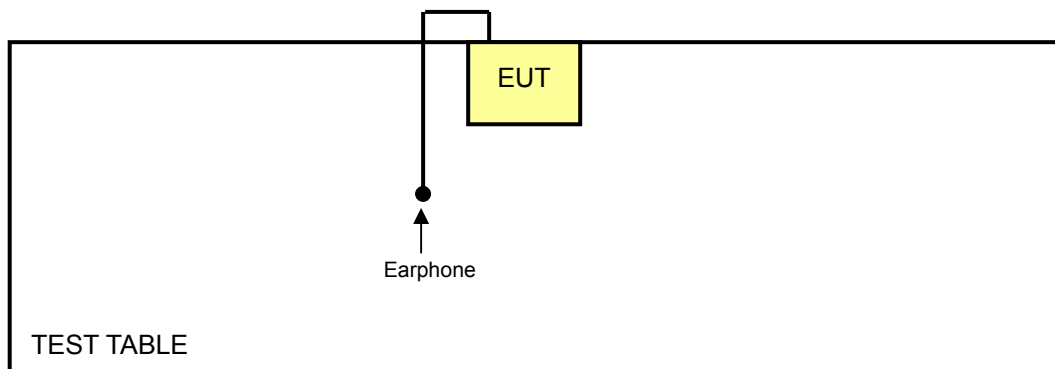

3.2.2 TEST MODE APPLICABILITY AND TESTED CHANNEL DETAIL

| EUT CONFIGURE MODE | APPLICABLE TO | | | | | | | DESCRIPTION |
|--------------------|---------------|----|----|----|----|-------|-------|-------------|
| | OP | FS | OB | BE | CE | RE<1G | RE≥1G | |
| - | √ | √ | √ | √ | √ | √ | √ | - |

Where **OP**: Output power **FS**: Frequency stability
OB: Occupied bandwidth **BE**: Band edge
CE: Conducted spurious emissions **RE<1G**: Radiated emission below 1GHz
RE≥1G: Radiated emission above 1GHz

OUTPUT POWER MEASUREMENT:

- Pre-Scan has been conducted to determine the worst-case mode from all possible combinations between available modulations, data rates, xyz axis and antenna ports (if EUT with antenna diversity architecture).
- Following channel(s) was (were) selected for the final test as listed below.

| AVAILABLE CHANNEL | TESTED CHANNEL | MODULATION TECHNOLOGY | AXIS |
|-------------------|----------------|-----------------------|------|
| 128 to 251 | 128, 190, 251 | GSM, GPRS, E-GPRS | Z |

FREQUENCY STABILITY MEASUREMENT:

- Pre-Scan has been conducted to determine the worst-case mode from all possible combinations between available modulations, data rates, and antenna ports (if EUT with antenna diversity architecture).
- Following channel(s) was (were) selected for the final test as listed below.

| AVAILABLE CHANNEL | TESTED CHANNEL | MODULATION TECHNOLOGY |
|-------------------|----------------|-----------------------|
| 128 to 251 | 128 | GSM, GPRS, E-GPRS |

OCCUPIED BANDWIDTH MEASUREMENT:

- Pre-Scan has been conducted to determine the worst-case mode from all possible combinations between available modulations, data rates, and antenna ports (if EUT with antenna diversity architecture).
- Following channel(s) was (were) selected for the final test as listed below.

| AVAILABLE CHANNEL | TESTED CHANNEL | MODULATION TECHNOLOGY |
|-------------------|----------------|-----------------------|
| 128 to 251 | 128, 190, 251 | GSM, GPRS, E-GPRS |



BAND EDGE MEASUREMENT:

- Pre-Scan has been conducted to determine the worst-case mode from all possible combinations between available modulations, data rates, and antenna ports (if EUT with antenna diversity architecture).
- Following channel(s) was (were) selected for the final test as listed below.

| AVAILABLE CHANNEL | TESTED CHANNEL | MODULATION TECHNOLOGY |
|-------------------|----------------|-----------------------|
| 128 to 251 | 128, 251 | GSM, GPRS, E-GPRS |

CONDUCTED SPURIOUS EMISSIONS MEASUREMENT:

- Pre-Scan has been conducted to determine the worst-case mode from all possible combinations between available modulations, data rates, and antenna ports (if EUT with antenna diversity architecture).
- Following channel(s) was (were) selected for the final test as listed below.

| AVAILABLE CHANNEL | TESTED CHANNEL | MODULATION TECHNOLOGY |
|-------------------|----------------|-----------------------|
| 128 to 251 | 128, 190, 251 | GSM |

RADIATED EMISSION MEASUREMENT (BELOW 1 GHz):

- Pre-Scan has been conducted to determine the worst-case mode from all possible combinations between available modulations, data rates, xyz axis and antenna ports (if EUT with antenna diversity architecture).
- Following channel(s) was (were) selected for the final test as listed below.

| AVAILABLE CHANNEL | TESTED CHANNEL | MODULATION TECHNOLOGY | AXIS |
|-------------------|----------------|-----------------------|------|
| 128 to 251 | 128 | GSM | Z |
| 128 to 251 | 128 | GSM | Z |

RADIATED EMISSION MEASUREMENT (ABOVE 1 GHz):

- Pre-Scan has been conducted to determine the worst-case mode from all possible combinations between available modulations, data rates, xyz axis and antenna ports (if EUT with antenna diversity architecture).
- Following channel(s) was (were) selected for the final test as listed below.

| AVAILABLE CHANNEL | TESTED CHANNEL | MODULATION TECHNOLOGY | AXIS |
|-------------------|----------------|-----------------------|------|
| 128 to 251 | 128, 190, 251 | GSM | Z |



3.3 GENERAL DESCRIPTION OF APPLIED STANDARDS

The EUT is a EDA (Enterprise Digital Assistant). According to the specifications of the manufacturer, it must comply with the requirements of the following standards:

FCC 47 CFR Part 2

FCC 47 CFR Part 22

IC RSS-132

ANSI C63.4-2003

ANSI/TIA/EIA-603-A

NOTE: All test items have been performed and recorded as per the above standards.

3.4 DESCRIPTION OF SUPPORT UNITS

The EUT has been tested as an independent unit together with other necessary accessories or support units. The following support units or accessories were used to form a representative test configuration during the tests.

| NO. | PRODUCT | BRAND | MODEL NO. | SERIAL NO. | CAL. DATE |
|-----|--------------------------------------|-------|-----------|------------|---------------|
| 1 | Universal Radio Communication Tester | R&S | CMU200 | 104484 | Jan. 23, 2007 |

| NO. | SIGNAL CABLE DESCRIPTION OF THE ABOVE SUPPORT UNITS |
|-----|---|
| 1 | NA |

NOTE: All power cords of the above support units are non shielded (1.8m).

4 TEST TYPES AND RESULTS

4.1 OUTPUT POWER MEASUREMENT

4.1.1 LIMITS OF OUTPUT POWER MEASUREMENT

The radiated peak output power shall be according to the specific rule Part 22.913 (a) that “Mobile / Portable station are limited to 7 watts e.r.p”.

4.1.2 TEST INSTRUMENTS

| DESCRIPTION & MANUFACTURER | MODEL NO. | SERIAL NO. | CALIBRATED UNTIL |
|---|--------------------|-------------|------------------|
| Test Receiver ROHDE & SCHWARZ | ESI7 | 100033 | May. 22, 2007 |
| Spectrum Analyzer ROHDE & SCHWARZ | FSP40 | 100025 | Dec. 05, 2006 |
| BILOG Antenna SCHWARZBECK | VULB9168 | 9168-160 | May 31, 2007 |
| HORN Antenna SCHWARZBECK | 9120D | 9120D-408 | Jan. 08, 2007 |
| HORN Antenna SCHWARZBECK | BBHA 9170 | BBHA9170243 | Jan. 19, 2007 |
| Preamplifier Agilent | 8447D | 2944A10633 | Oct. 26, 2007 |
| Preamplifier Agilent | 8449B | 3008A01964 | Oct. 26, 2007 |
| RF signal cable HUBER+SUHNNER | SUCOFLEX 104 | 214377/4 | Dec. 13, 2006 |
| RF signal cable HUBER+SUHNNER | SUCOFLEX 104 | 219272/4 | Dec. 13, 2006 |
| Software ADT. | ADT_Radiated_V5.14 | NA | NA |
| Antenna Tower inn-co GmbH | MA 4000 | 013303 | NA |
| Antenna Tower Controller inn-co GmbH | CO2000 | 017303 | NA |
| Turn Table ADT. | TT100. | TT93021703 | NA |
| Turn Table Controller ADT. | SC100. | SC93021703 | NA |

- NOTE:**
1. The calibration interval of the above test instruments is 12 months and the calibrations are traceable to NML/ROC and NIST/USA.
 2. The test was performed in HwaYa Chamber 3.
 3. The horn antenna and HP preamplifier (model: 8449B) are used only for the measurement of emission frequency above 1GHz if tested.
 4. The VCCI Site Registration No. is R-237.
 5. The IC Site Registration No. is IC4924-3.

4.1.3 TEST PROCEDURES

- a. The EUT was set up for the maximum peak power with GSM link data modulation. The power was measured with R&S Spectrum Analyzer. All measurements were done at 3 channels: 128, 190 and 251 (low, middle and high operational frequency range).
- b. The conducted peak output power used the power splitter via EUT RF power connector between simulation base station and spectrum analyzer. The path loss included the splitter loss, cable loss and 20dB pad loss. The spectrum set RB/VB 3MHz, then read peak power value and record to the test. (All transmitted path loss shall be considered in the test report data.)
- c. E.I.R.P peak power measurement. In the fully anechoic chamber, EUT placed on the 1.5m height of Turn Table, rotated the table around 360 degrees to search the maximum radiation power and receiver antenna shall be rotated vertical and horizontal polarization to find the maximum polar radiated power. The “Read Value” is the spectrum reading the maximum power value.
- d. The substitution horn antenna is substituted for EUT at the same position and signals generator export the CW signal to the calibration antenna. Rotated the Turn Table to find the maximum radiation power. “Raw” is the spectrum reading value, “SG” is signal generator export power, “TX Gain” is calibration antenna isotropic gain value, “TX cable” is the transmitted cable loss between the calibration antenna and signal generator. The “Factor” means that the transmission path loss is equal to “SG” - “TX cable” + “TX Gain” – “Raw”.
- e. Actually the real E.I.R.P peak power is equal to “Read Value” + “Factor”.
- f. E.R.P power can be calculated form E.I.R.P power by subtracting the gain of dipole, E.R.P power = E.I.P.R power - 2.15dBi.

4.1.4 TEST SETUP

EIRP POWER MEASUREMENT:

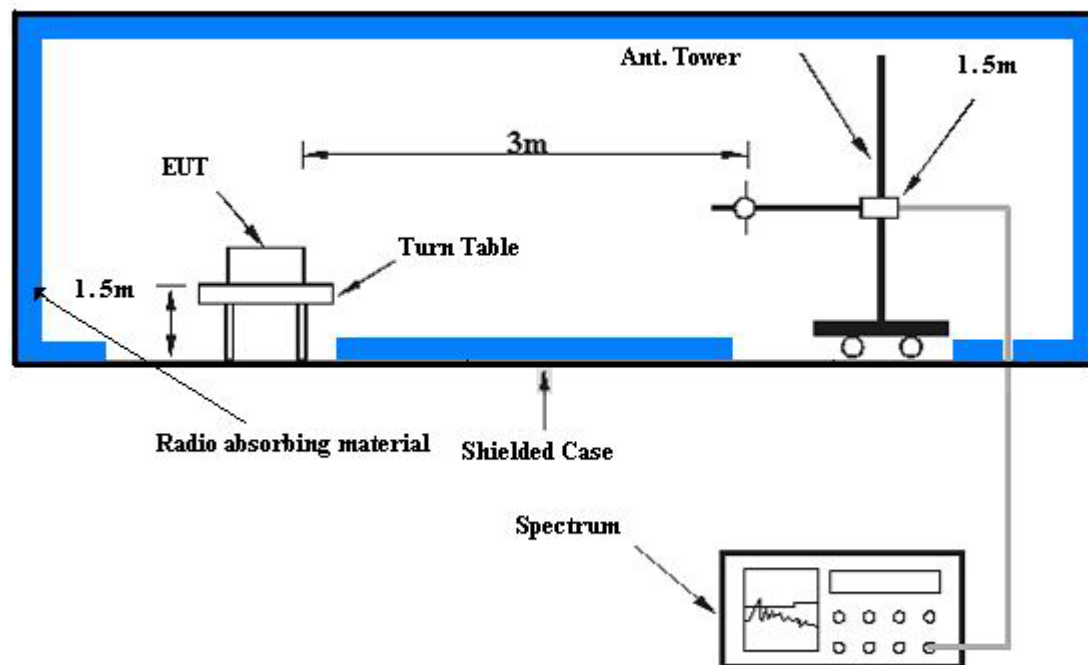

For the actual test configuration, please refer to the related item – Photographs of the Test Configuration.

CONDUCTED POWER MEASUREMENT:

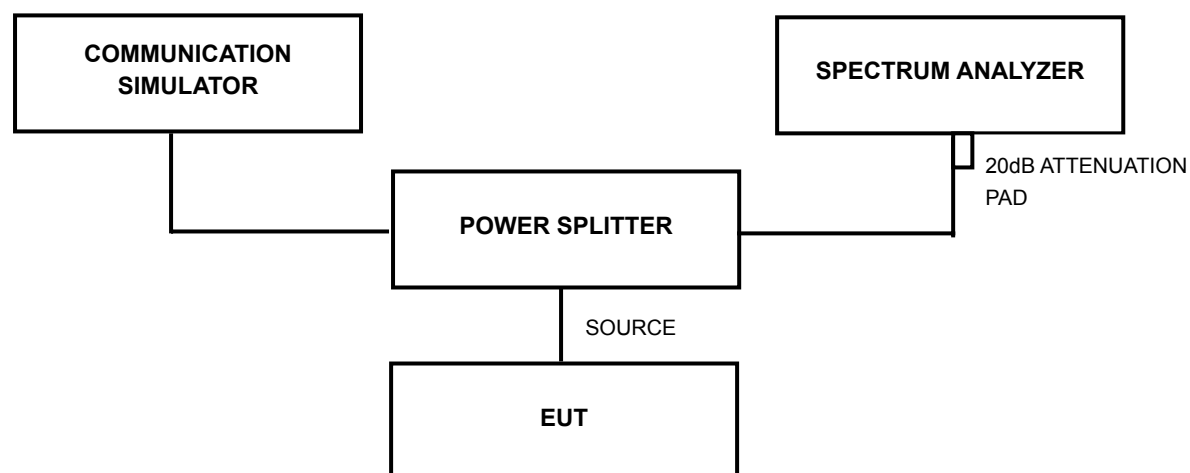

For the actual test configuration, please refer to the related item – Photographs of the Test Configuration.

4.1.5 EUT OPERATING CONDITIONS

- a. The EUT makes a phone call to the communication simulator.
- b. The communication simulator station system controlled an EUT to export maximum output power under transmission mode and specific channel frequency.

4.1.6 TEST RESULTS

| | | | |
|-----------------------------|--------------|---------------------------------|------------------------|
| MODE | TX connected | DETECTOR FUNCTION | Average |
| INPUT POWER (SYSTEM) | 120Vac, 60Hz | ENVIRONMENTAL CONDITIONS | 26deg°C, 65%RH, 991hPa |
| TESTED BY | Long Chen | | |

FOR GSM MODE (UP-LINK WITH 1 TIME SLOT)

| CONDUCTED PEAK OUTPUT POWER | | | | | |
|-----------------------------|-----------------|-----------------|------------------------|-------------------|--------------|
| CHANNEL NO. | FREQUENCY (MHz) | RAW VALUE (dBm) | CORRECTION FACTOR (dB) | PEAK OUTPUT POWER | |
| | | | | dBm | Watt |
| 128 | 824.2 | 20.7 | 12.0 | 32.7 | 1.862 |
| 190 | 836.6 | 20.4 | 12.0 | 32.4 | 1.738 |
| 251 | 848.8 | 20.2 | 12.0 | 32.2 | 1.660 |

FOR GPRS MODE (UP-LINK WITH 1 TIME SLOT)

| CONDUCTED PEAK OUTPUT POWER | | | | | |
|-----------------------------|-----------------|-----------------|------------------------|-------------------|-------|
| CHANNEL NO. | FREQUENCY (MHz) | RAW VALUE (dBm) | CORRECTION FACTOR (dB) | PEAK OUTPUT POWER | |
| | | | | dBm | Watt |
| 128 | 824.2 | 20.6 | 12.0 | 32.6 | 1.820 |
| 190 | 836.6 | 20.2 | 12.0 | 32.2 | 1.660 |
| 251 | 848.8 | 20.1 | 12.0 | 32.1 | 1.622 |

FOR E-GPRS MODE (UP-LINK WITH 1 TIME SLOT)

| CONDUCTED PEAK OUTPUT POWER | | | | | |
|-----------------------------|-----------------|-----------------|------------------------|-------------------|-------|
| CHANNEL NO. | FREQUENCY (MHz) | RAW VALUE (dBm) | CORRECTION FACTOR (dB) | PEAK OUTPUT POWER | |
| | | | | dBm | Watt |
| 128 | 824.2 | 17.8 | 12.0 | 29.8 | 0.955 |
| 190 | 836.6 | 17.8 | 12.0 | 29.8 | 0.955 |
| 251 | 848.8 | 17.7 | 12.0 | 29.7 | 0.933 |

- REMARKS:**
1. Peak Output Power (dBm) = Raw Value (dBm) + Correction Factor (dB).
 2. Correction Factor (dB) = Power Splitter Loss (dB) + Cable Loss (dB).
 3. The value in bold is the worst.

| | | | |
|-----------------------------|--------------|---------------------------------|------------------------|
| MODE | TX connected | DETECTOR FUNCTION | Average |
| INPUT POWER (SYSTEM) | 120Vac, 60Hz | ENVIRONMENTAL CONDITIONS | 26deg°C, 65%RH, 991hPa |
| TESTED BY | Long Chen | | |

FOR GSM MODE (UP-LINK WITH 1 TIME SLOT)

| ERP POWER | | | | | |
|-------------|-----------------|-----------------|------------------------|-------------------|--------------|
| CHANNEL NO. | FREQUENCY (MHz) | RAW VALUE (dBm) | CORRECTION FACTOR (dB) | PEAK OUTPUT POWER | |
| | | | | dBm | Watt |
| 128 | 824.2 | -10.97 | 40.03 | 29.06 | 0.805 |
| 190 | 836.6 | -11.34 | 40.32 | 28.98 | 0.791 |
| 251 | 848.8 | -11.51 | 40.62 | 29.11 | 0.815 |

FOR GPRS MODE (UP-LINK WITH 1 TIME SLOT)

| ERP POWER | | | | | |
|-------------|-----------------|-----------------|------------------------|-------------------|-------|
| CHANNEL NO. | FREQUENCY (MHz) | RAW VALUE (dBm) | CORRECTION FACTOR (dB) | PEAK OUTPUT POWER | |
| | | | | dBm | Watt |
| 128 | 824.2 | -11.07 | 40.03 | 28.96 | 0.787 |
| 190 | 836.6 | -11.65 | 40.32 | 28.67 | 0.736 |
| 251 | 848.8 | -11.69 | 40.62 | 28.93 | 0.782 |

FOR E-GPRS MODE (UP-LINK WITH 1 TIME SLOT)

| ERP POWER | | | | | |
|-------------|-----------------|-----------------|------------------------|-------------------|-------|
| CHANNEL NO. | FREQUENCY (MHz) | RAW VALUE (dBm) | CORRECTION FACTOR (dB) | PEAK OUTPUT POWER | |
| | | | | dBm | Watt |
| 128 | 824.2 | -14.04 | 40.03 | 25.99 | 0.397 |
| 190 | 836.6 | -14.37 | 40.32 | 25.95 | 0.394 |
| 251 | 848.8 | -14.58 | 40.62 | 26.04 | 0.402 |

- REMARKS:**
1. Peak Output Power (dBm) = Raw Value (dBm) + Correction Factor (dB).
 2. Correction Factor (dB) = Receiver Antenna Gain (dBi) + Cable Loss (dB) + Free Space Loss (dB).
 3. The value in bold is the worst.



4.2 FREQUENCY STABILITY MEASUREMENT

4.2.1 LIMITS OF FREQUENCY STABILITY MEASUREMENT

According to the FCC part 2.4235 shall be tested the frequency stability. The rule is defined that "The frequency stability shall be sufficient to ensure that the fundamental emission stays within the authorized frequency block." The frequency error rate is according to the JTC standard that the frequency error rate shall be accurate to within 2.5ppm of the received frequency from the base station. The test extreme voltage is according to the 2.1055(d)(1) Vary primary supply voltage from 85 to 115 percent of the nominal value for other than hand carried battery equipment and the extreme temperature rule is comply with the 2.1055(a)(1) -30°C ~ 50°C.

4.2.2 TEST INSTRUMENTS

| DESCRIPTION & MANUFACTURER | MODEL NO. | SERIAL NO. | CALIBRATED UNTIL |
|---|-------------|------------|------------------|
| * ROHDE & SCHWARZ Spectrum Analyzer | FSP40 | 100035 | Mar. 29, 2007 |
| * Hewlett Packard RF cable | 8120-6192 | 01428251 | NA |
| * Suhner RF cable | Sucoflex104 | 204850/4 | NA |
| * WIT Standard Temperature & Humidity Chamber | TH-4S-C | W981030 | Jul. 10, 2007 |

- NOTE:** 1. The calibration interval of the above test instruments is 12 months. And the calibrations are traceable to NML/ROC and NIST/USA.
2. "*" = These equipments are used for the final measurement.
3. The test was performed in ADT RF OVEN room.

4.2.3 TEST PROCEDURE

- a. Because of the measure the carrier frequency under the condition of the AFC lock, it shall be used the mobile station in the GSM / GPRS / E-GPRS link mode. This is accomplished with the use of the communication simulator station. The oven room could control the temperatures and humidity. The GSM link channel is the 128.
- b. Power must be removed when changing from one temperature to another or one voltage to another voltage. Power warm up is at least 15 min and power applied should perform before recording frequency error.
- c. EUT is connected the external power supply to control the DC input power. The various Volts from the minimum 3.3Volts to 4.2 Volts. Each step shall be record the frequency error rate.
- d. The temperature range step is 10 degrees in this test items. All temperature levels shall be hold the $\pm 0.5^{\circ}\text{C}$ during the measurement testing.
- e. The each temperature step shall be at least 0.5 hours, consider the EUT could be test under the stability condition.

NOTE: The frequency error was recorded frequency error from the GSM simulator.

4.2.4 TEST SETUP

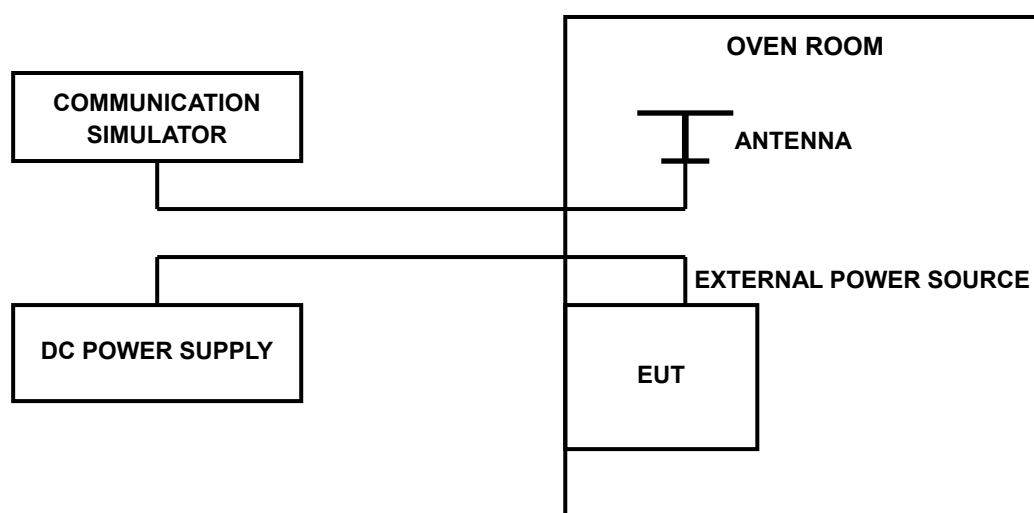

4.2.5 TEST RESULTS

| | | | |
|-----------------------------|--------------|---------------------------------|------------------------|
| MODE | Channel 128 | ENVIRONMENTAL CONDITIONS | 26deg°C, 65%RH, 991hPa |
| INPUT POWER (SYSTEM) | 120Vac, 60Hz | TESTED BY | Long Chen |

FOR GSM MODE (UP-LINK WITH 1 TIME SLOT)

| AFC FREQUENCY ERROR VS. VOLTAGE | | | |
|---------------------------------|----------------------|-----------------------|-------------|
| VOLTAGE (Volts) | FREQUENCY ERROR (Hz) | FREQUENCY ERROR (ppm) | LIMIT (ppm) |
| 3.3 | 13 | 0.015539087 | 0.1 |
| 3.7 | 13 | 0.015539087 | 0.1 |
| 4.2 | 11 | 0.013148458 | 0.1 |

FOR GPRS MODE (UP-LINK WITH 1 TIME SLOT)

| AFC FREQUENCY ERROR VS. VOLTAGE | | | |
|---------------------------------|----------------------|-----------------------|-------------|
| VOLTAGE (Volts) | FREQUENCY ERROR (Hz) | FREQUENCY ERROR (ppm) | LIMIT (ppm) |
| 3.3 | 14 | 0.016734401 | 0.1 |
| 3.7 | 13 | 0.015539087 | 0.1 |
| 4.2 | 12 | 0.014343772 | 0.1 |

FOR E-GPRS MODE (UP-LINK WITH 1 TIME SLOT)

| AFC FREQUENCY ERROR VS. VOLTAGE | | | |
|---------------------------------|----------------------|-----------------------|-------------|
| VOLTAGE (Volts) | FREQUENCY ERROR (Hz) | FREQUENCY ERROR (ppm) | LIMIT (ppm) |
| 3.3 | 13 | 0.015539087 | 0.1 |
| 3.7 | 13 | 0.015539087 | 0.1 |
| 4.2 | 11 | 0.013148458 | 0.1 |

NOTE: The applicant defined the normal working voltage of the battery is from 3.3Vdc to 4.2Vdc.



| | | | |
|-----------------------------|--------------|---------------------------------|------------------------|
| MODE | Channel 128 | ENVIRONMENTAL CONDITIONS | 26deg°C, 65%RH, 991hPa |
| INPUT POWER (SYSTEM) | 120Vac, 60Hz | TESTED BY | Long Chen |

FOR GSM MODE (UP-LINK WITH 1 TIME SLOT)

| AFC FREQUENCY ERROR VS. TEMP. | | | |
|--------------------------------------|-----------------------------|------------------------------|--------------------|
| TEMP. (°C) | FREQUENCY ERROR (Hz) | FREQUENCY ERROR (ppm) | LIMIT (ppm) |
| 50 | 14 | 0.016734401 | 0.1 |
| 40 | 12 | 0.014343772 | 0.1 |
| 30 | 11 | 0.013148458 | 0.1 |
| 20 | 5 | 0.005976572 | 0.1 |
| 10 | 4 | 0.004781257 | 0.1 |
| 0 | 5 | 0.005976572 | 0.1 |
| -10 | 6 | 0.007171886 | 0.1 |
| -20 | 8 | 0.009562515 | 0.1 |
| -30 | 9 | 0.010757829 | 0.1 |

FOR GPRS MODE (UP-LINK WITH 1 TIME SLOT)

| AFC FREQUENCY ERROR VS. TEMP. | | | |
|--------------------------------------|-----------------------------|------------------------------|--------------------|
| TEMP. (°C) | FREQUENCY ERROR (Hz) | FREQUENCY ERROR (ppm) | LIMIT (ppm) |
| 50 | 13 | 0.015539087 | 0.1 |
| 40 | 12 | 0.014343772 | 0.1 |
| 30 | 10 | 0.011953144 | 0.1 |
| 20 | 7 | 0.008367201 | 0.1 |
| 10 | 5 | 0.005976572 | 0.1 |
| 0 | 6 | 0.007171886 | 0.1 |
| -10 | 9 | 0.010757829 | 0.1 |
| -20 | 10 | 0.011953144 | 0.1 |
| -30 | 11 | 0.013148458 | 0.1 |

FOR E-GPRS MODE (UP-LINK WITH 1 TIME SLOT)

| AFC FREQUENCY ERROR VS. TEMP. | | | |
|--------------------------------------|-----------------------------|------------------------------|--------------------|
| TEMP. (°C) | FREQUENCY ERROR (Hz) | FREQUENCY ERROR (ppm) | LIMIT (ppm) |
| 50 | 14 | 0.016734401 | 0.1 |
| 40 | 13 | 0.015539087 | 0.1 |
| 30 | 12 | 0.014343772 | 0.1 |
| 20 | 8 | 0.009562515 | 0.1 |
| 10 | 6 | 0.007171886 | 0.1 |
| 0 | 6 | 0.007171886 | 0.1 |
| -10 | 8 | 0.009562515 | 0.1 |
| -20 | 10 | 0.011953144 | 0.1 |
| -30 | 11 | 0.013148458 | 0.1 |



4.3 OCCUPIED BANDWIDTH MEASUREMENT

4.3.1 LIMITS OF OCCUPIED BANDWIDTH MEASUREMENT

According to FCC 2.1049 (h) specified that emission bandwidth is defined as the width of the signal between two points, one below the carrier center frequency and one above the carrier center frequency, outside of which all emissions are attenuated at least 26dB below the transmitter power.

4.3.2 TEST INSTRUMENTS

| DESCRIPTION & MANUFACTURER | MODEL NO. | SERIAL NO. | CALIBRATED UNTIL |
|--|--------------|------------|------------------|
| * ROHDE & SCHWARZ Spectrum Analyzer | FSP40 | 100035 | Mar. 29, 2007 |
| * Mini-Circuits Power Splitter | ZAPD-4 | 400005 | NA |
| * Hewlett Packard RF cable | 8120-6192 | 01428251 | NA |
| * JFW 20dB attenuation | 50HF-020-SMA | NA | NA |
| * Suhner RF cable | Sucoflex104 | 204850/4 | NA |

NOTE: 1. The calibration interval of the above test instruments is 12 months. And the calibrations are traceable to NML/ROC and NIST/USA.

2. "*" = These equipments are used for the final measurement.

4.3.3 TEST SETUP

Same as Item 4.2.4 (Conducted Power Setup)

4.3.4 TEST PROCEDURES

- a. The EUT makes a phone call to the communication simulator. The power was measured with R&S Spectrum Analyzer. All measurements were done at 3 channels: 128, 190 and 251 (low, middle and high operational frequency range).
- b. The conducted occupied bandwidth used the power splitter via EUT RF power connector between simulation base station and spectrum analyzer. This splitter, attenuator, and cable loss is the worst loss 12dB in the transmitted path track.
- c. The communication simulator station system controlled a EUT to export maximum output power under transmission mode and specific channel frequency. FCC 2.1049 (h) required a measurement bandwidth is the fundamental emission below 26dB bandwidth.

4.3.5 TEST RESULTS

FOR GSM MODE (UP-LINK WITH 1 TIME SLOT)

| FREQUENCY (MHz) | MAX. OUTPUT POWER -26 dBc BANDWIDTH (kHz) |
|-----------------|---|
| 824.2 | 312 |
| 836.6 | 312 |
| 848.8 | 306 |

CH 128 MAX. POWER

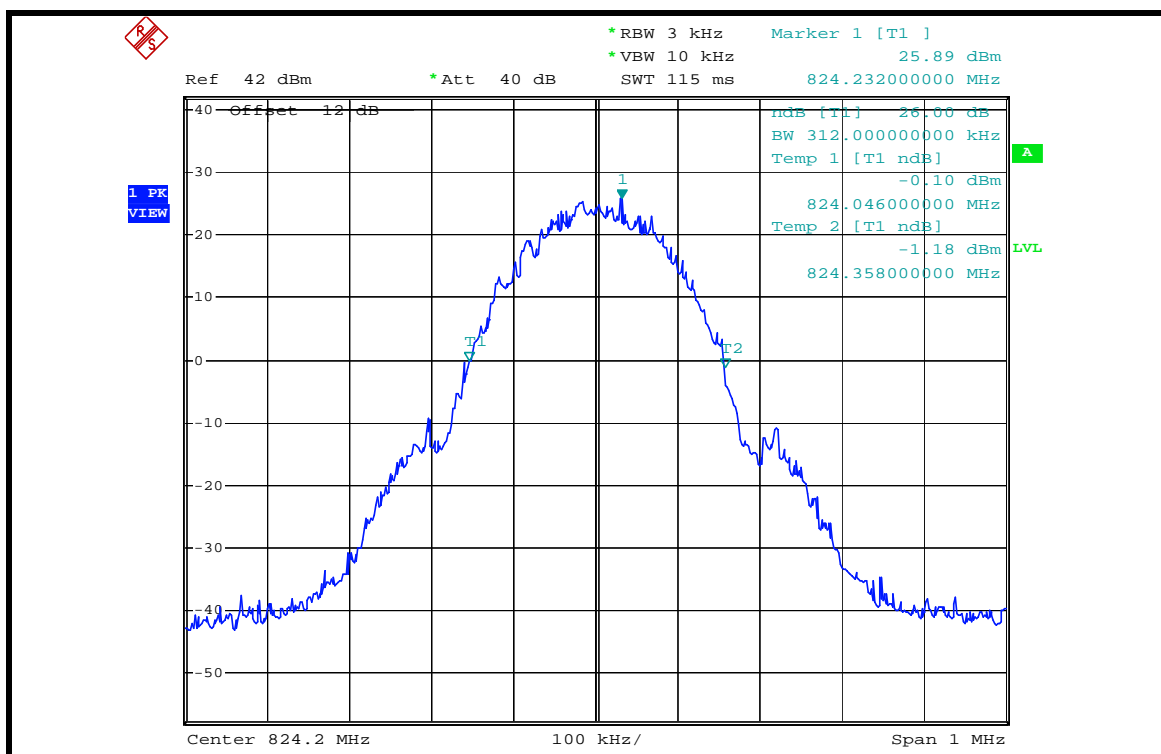

CH 190 MAX. POWER

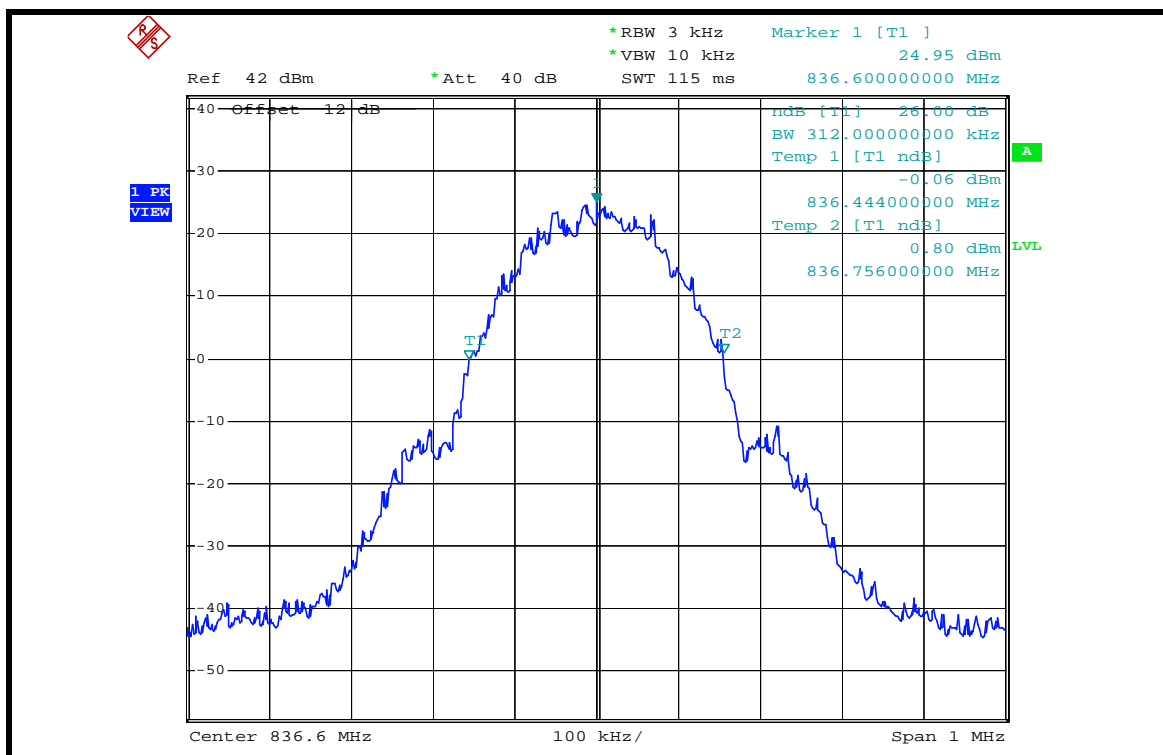

CH 251 MAX. POWER

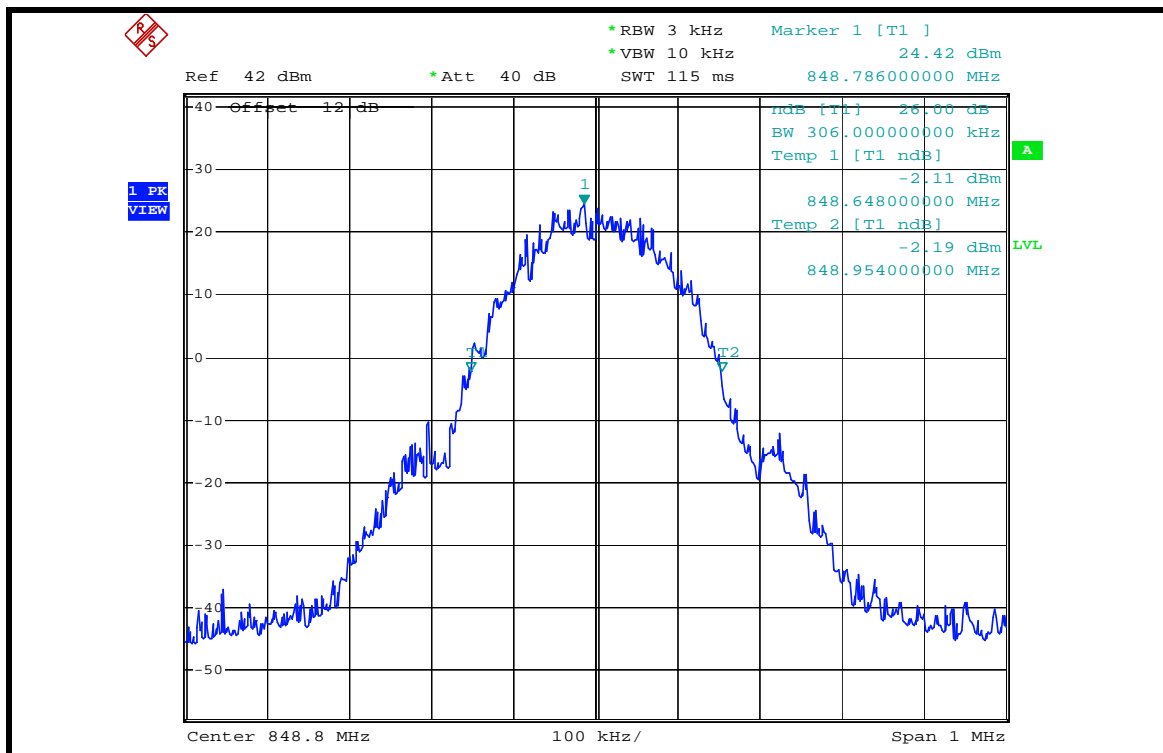

FOR GPRS MODE (UP-LINK WITH 1 TIME SLOT)

| FREQUENCY (MHz) | MAX. OUTPUT POWER -26 dBc BANDWIDTH (kHz) |
|-----------------|---|
| 824.2 | 312 |
| 836.6 | 310 |
| 848.8 | 308 |

CH 128 MAX. POWER

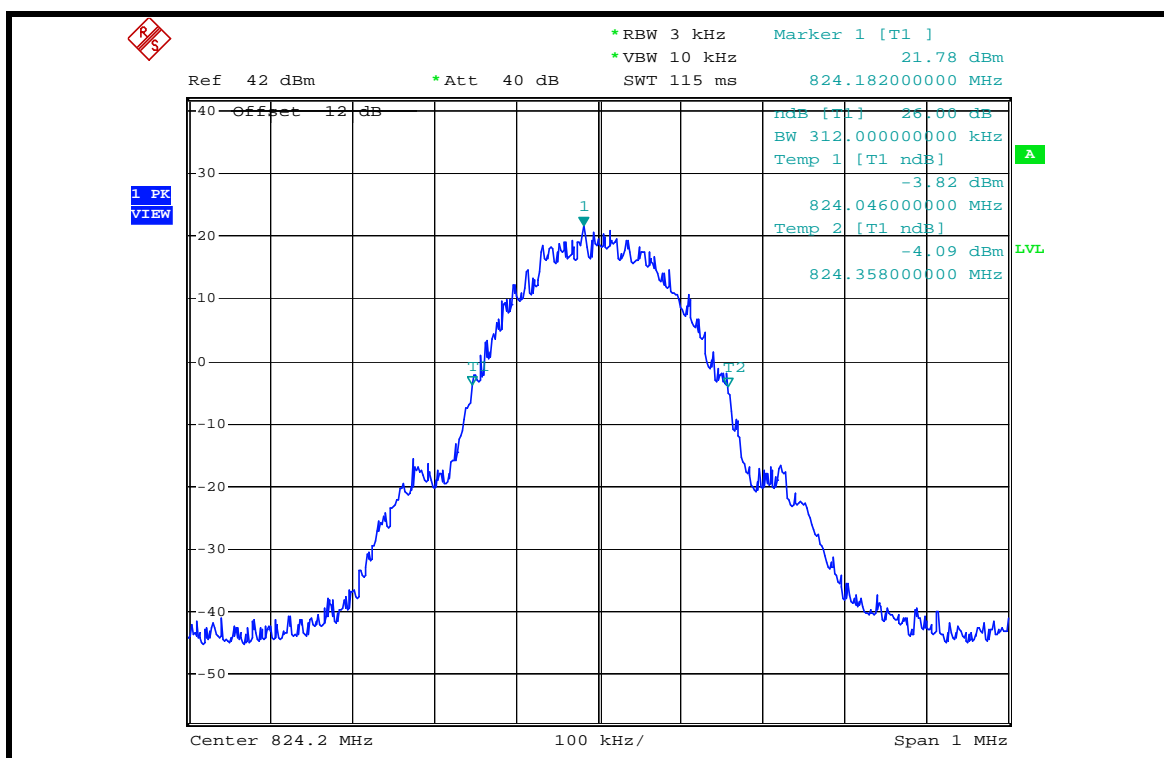

CH 190 MAX. POWER

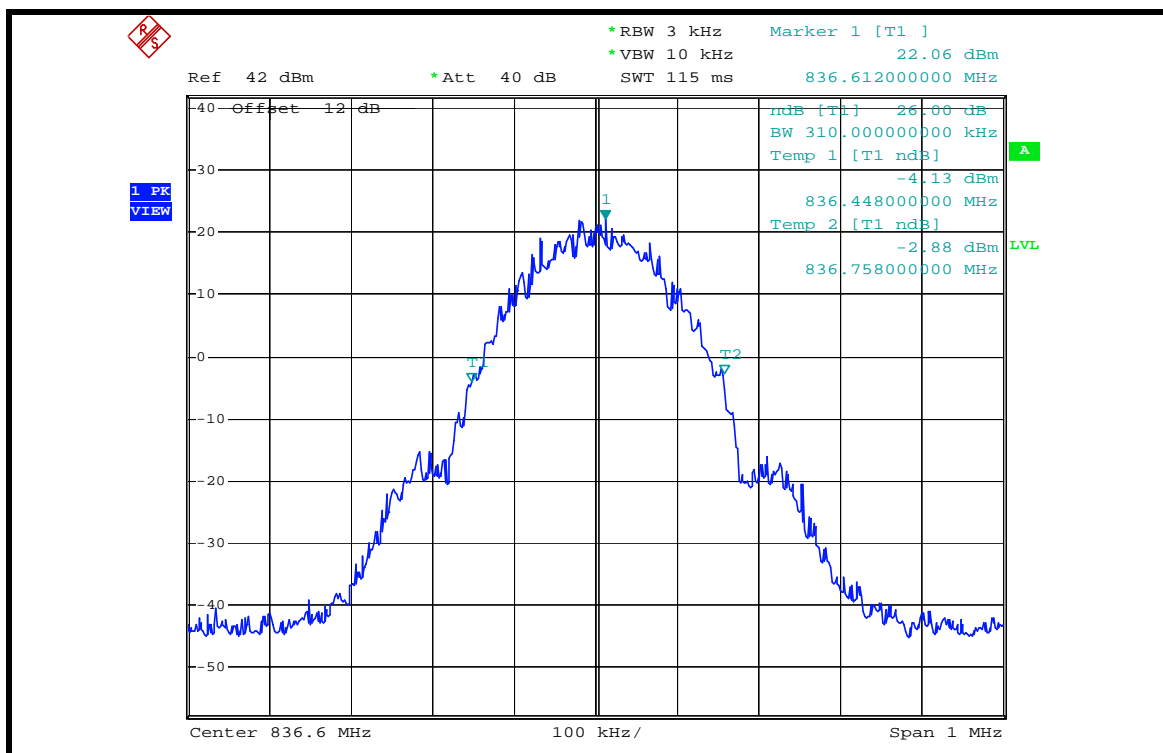

CH 251 MAX. POWER

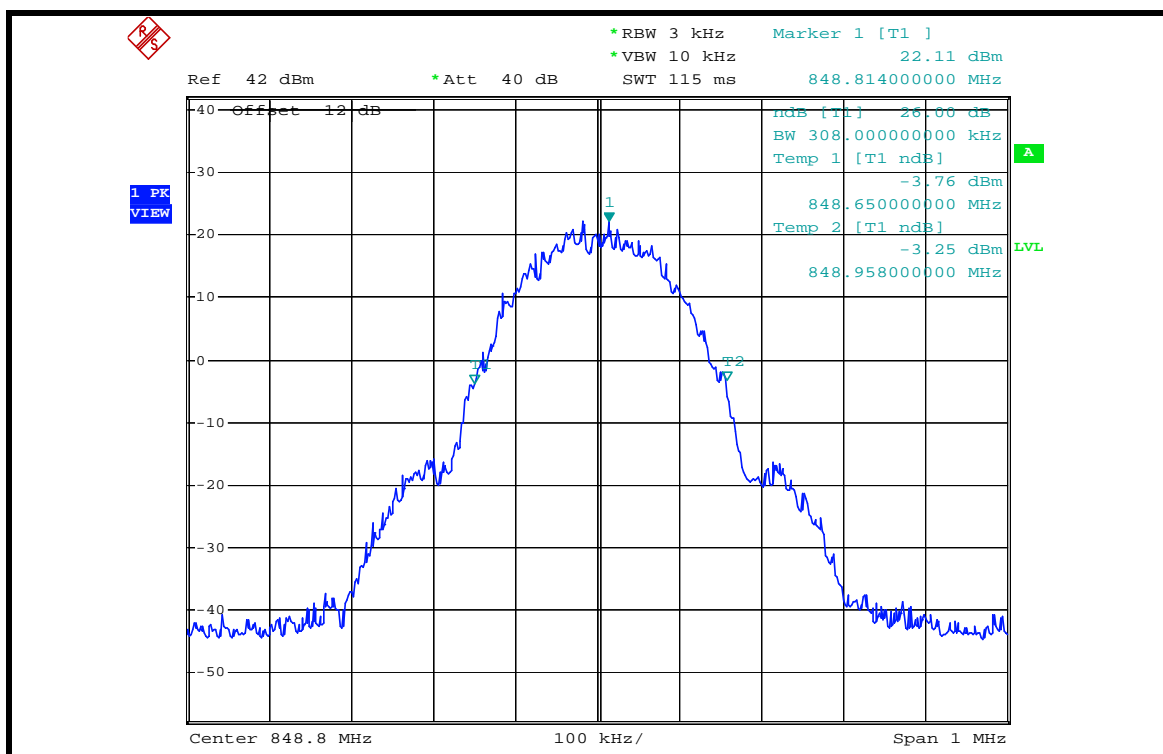

FOR E-GPRS MODE (UP-LINK WITH 1 TIME SLOT)

| FREQUENCY (MHz) | MAX. OUTPUT POWER -26 dBc BANDWIDTH (kHz) |
|-----------------|---|
| 824.2 | 310 |
| 836.6 | 302 |
| 848.8 | 294 |

CH 128 MAX. POWER

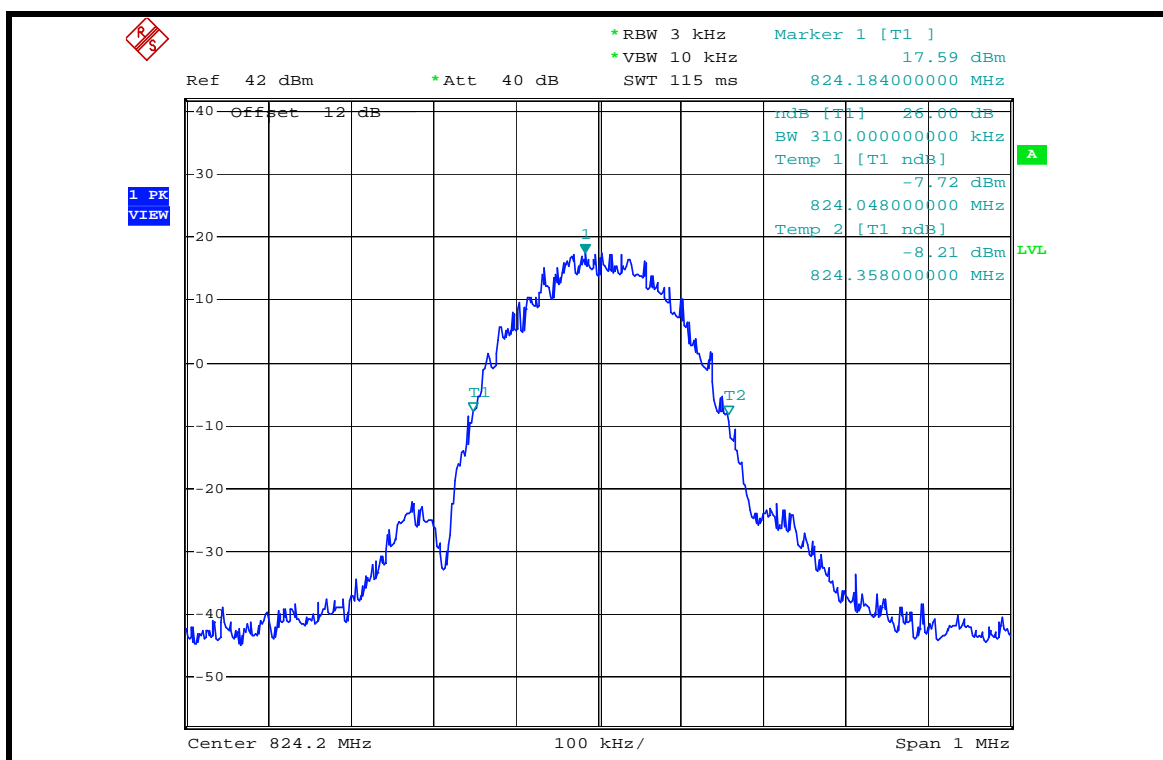

CH 190 MAX. POWER

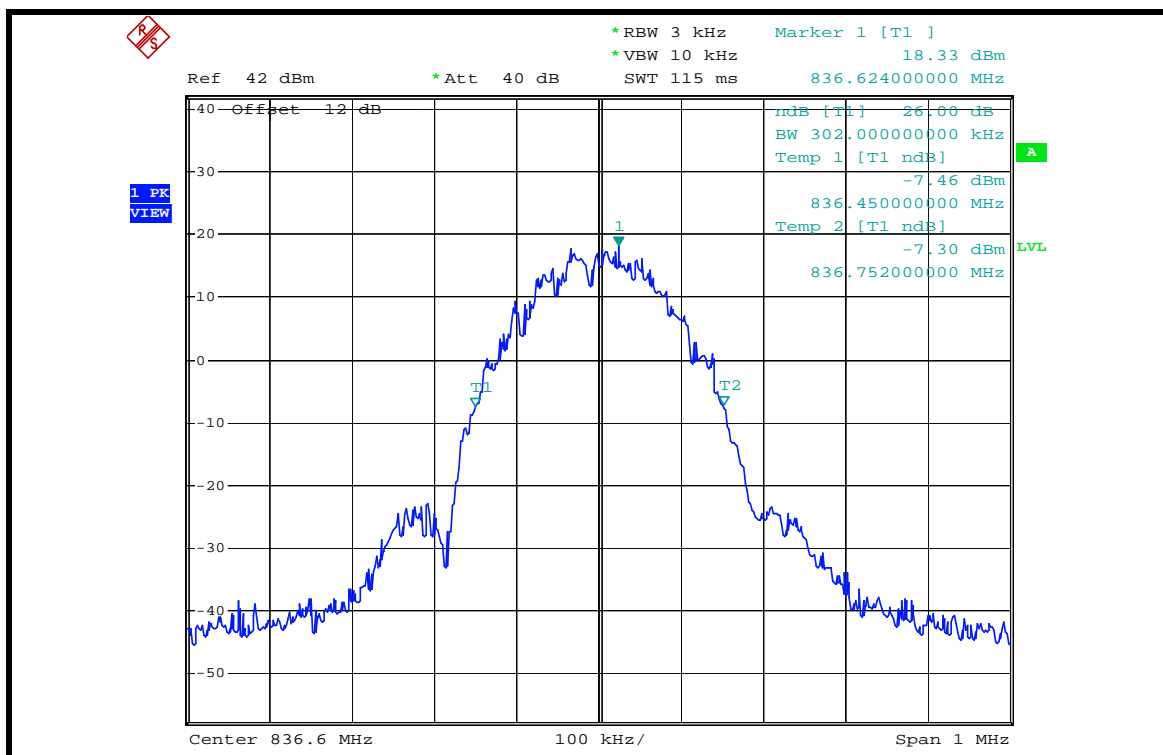

CH 251 MAX. POWER

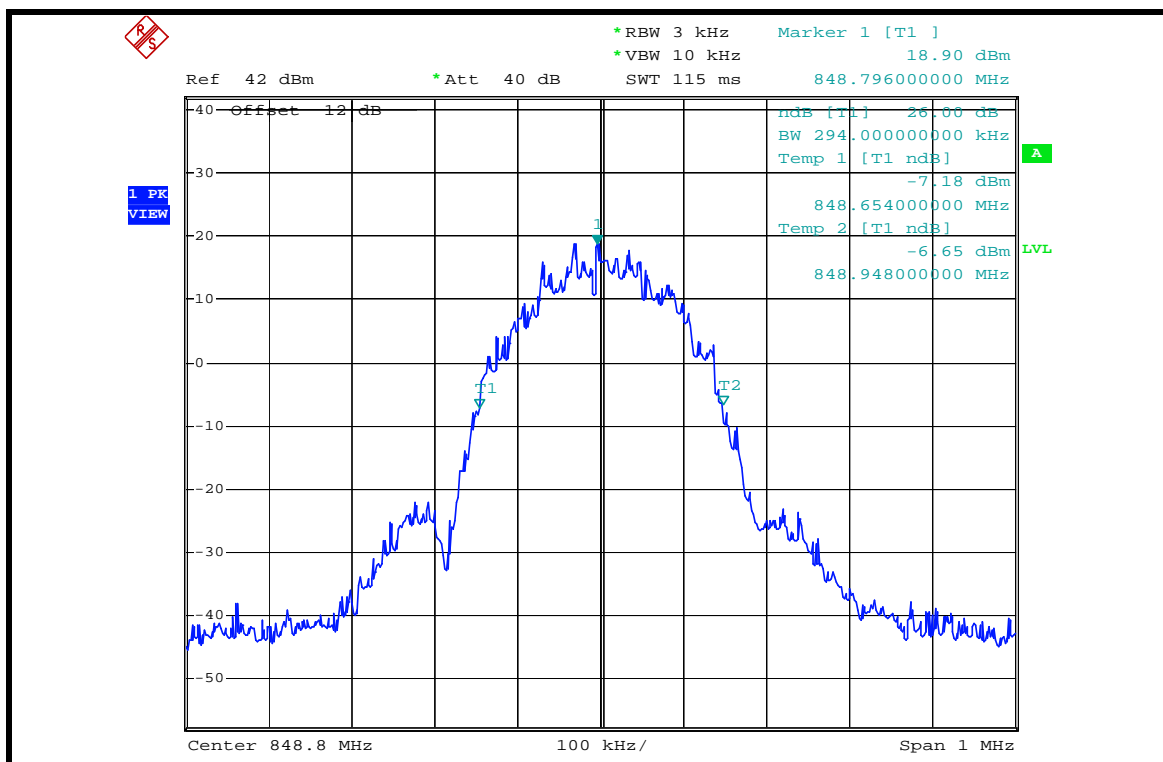

4.4 BAND EDGE MEASUREMENT

4.4.1 LIMITS OF BAND EDGE MEASUREMENT

According to FCC 22.917 specified that power of any emission outside of the authorized operating frequency ranges must be attenuated below the transmitting power (P) by a factor of at least $43 + 10 \log(P)$ dB. In the 1MHz bands immediately outside and adjacent to the frequency block a resolution bandwidth of at least one percent of the emission bandwidth of the fundamental emission of the transmitter may be employed.

4.4.2 TEST INSTRUMENTS

| DESCRIPTION & MANUFACTURER | MODEL NO. | SERIAL NO. | CALIBRATED UNTIL |
|--|--------------|------------|------------------|
| * ROHDE & SCHWARZ Spectrum Analyzer | FSP40 | 100035 | Mar. 29, 2007 |
| * Mini-Circuits Power Splitter | ZAPD-4 | 400005 | NA |
| * Hewlett Packard RF cable | 8120-6192 | 01428251 | NA |
| * JFW 20dB attenuation | 50HF-020-SMA | NA | NA |
| * Suhner RF cable | Sucoflex104 | 204850/4 | NA |

NOTE: 1. The calibration interval of the above test instruments is 12 months. And the calibrations are traceable to NML/ROC and NIST/USA.

2. "*" = These equipments are used for the final measurement.

4.4.3 TEST SETUP

Same as Item 4.2.4 (Conducted Power Setup)

4.4.4 TEST PROCEDURES

- a. The EUT was set up for the maximum peak power with GSM link data modulation. The power was measured with R&S Spectrum Analyzer. All measurements were done at 2 channels: 128 and 251 (low and high operational frequency range).
- b. The band edge measurement used the power splitter via EUT RF power connector between simulation base station and spectrum analyzer. This splitter, attenuator, and cable loss is the worst loss 12dB in the transmitted path track.
- c. The center frequency of spectrum is the band edge frequency and span is 1.5MHz. RB of the spectrum is 3kHz and VB of the spectrum is 10kHz.
- d. Record the max trace plot into the test report.

4.4.5 EUT OPERATING CONDITION

- a. The EUT makes a phone call to the communication simulator.
- b. The communication simulator station system controlled a EUT to export maximum output power under transmission mode and specific channel frequency.

4.4.6 TEST RESULTS

FOR GSM MODE (UP-LINK WITH 1 TIME SLOT)

LOWER BAND EDGE

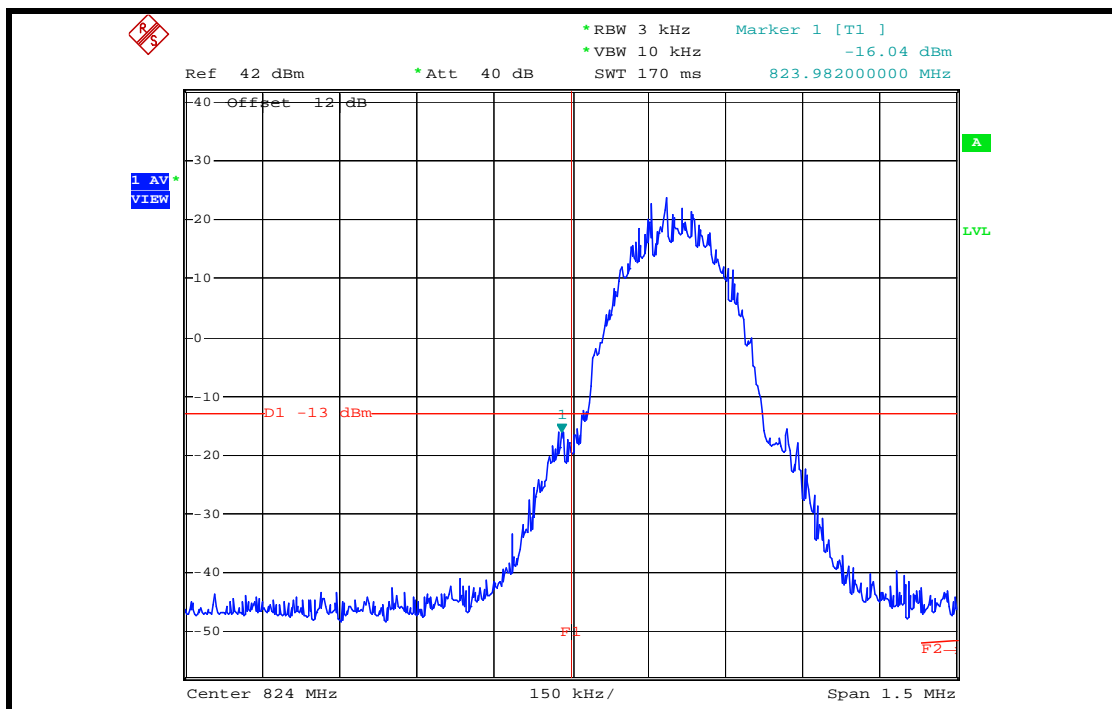

HIGHER BAND EDGE

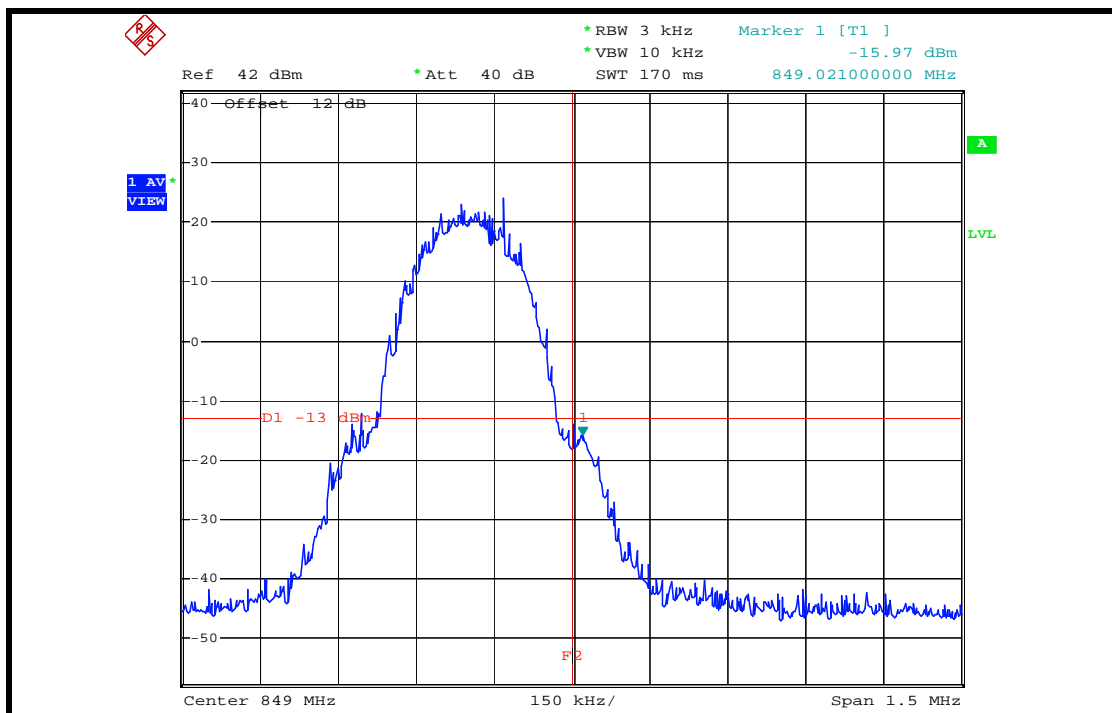

FOR GPRS MODE (UP-LINK WITH 1 TIME SLOT)

LOWER BAND EDGE

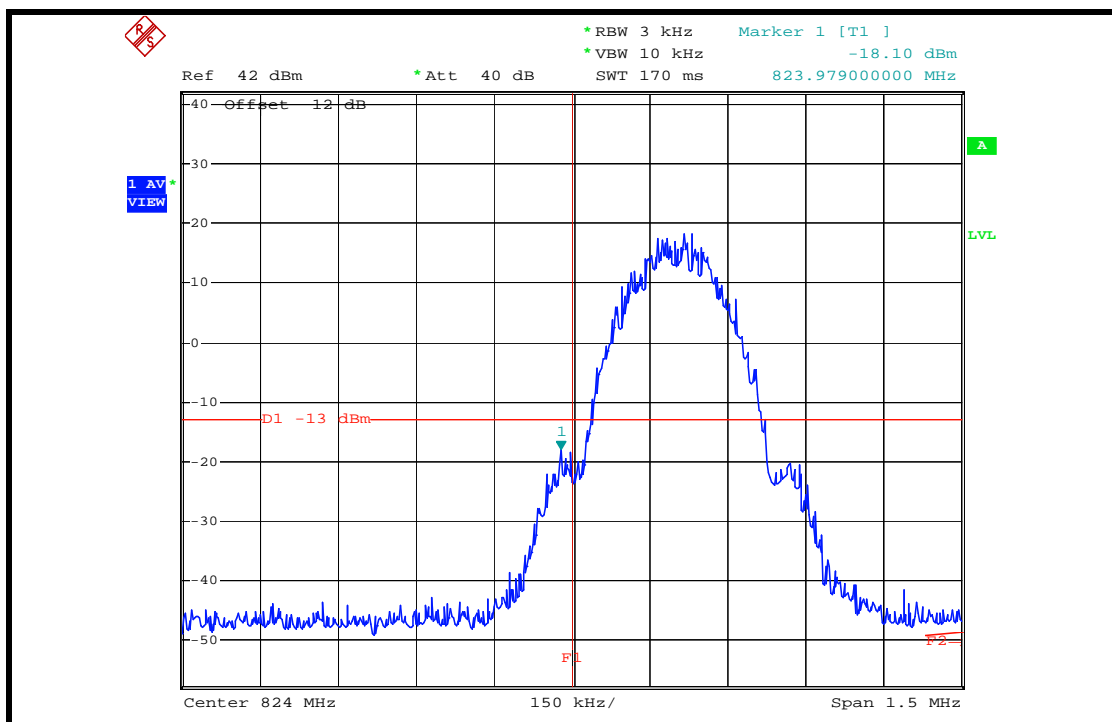

HIGHER BAND EDGE

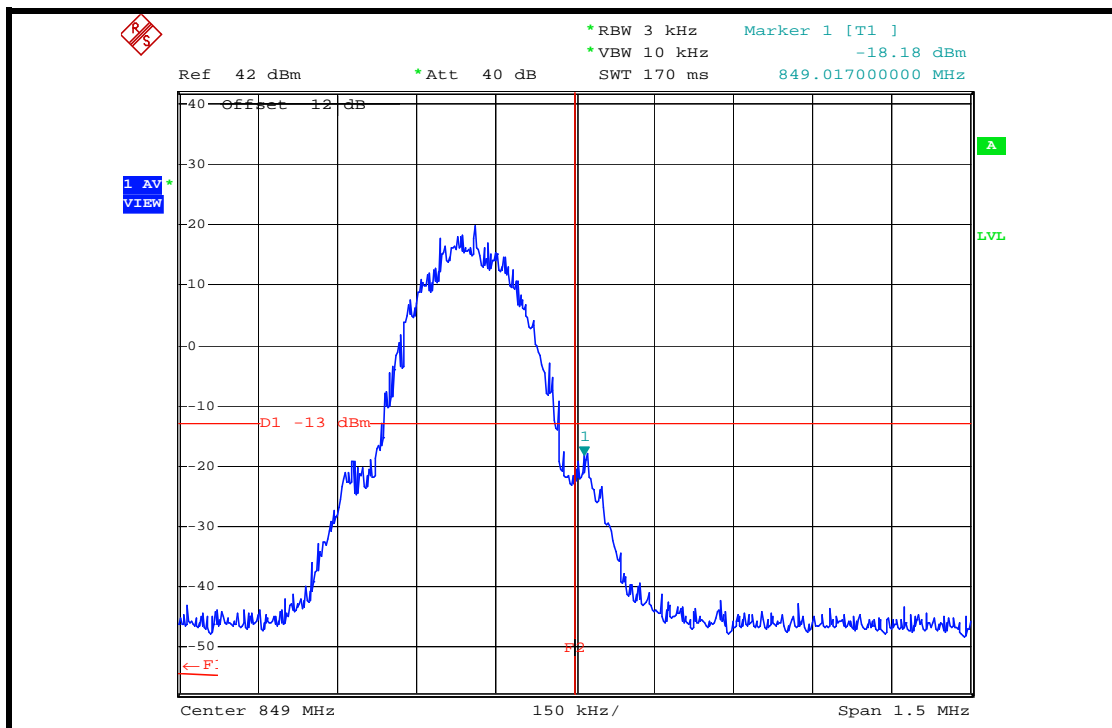

FOR E-GPRS MODE (UP-LINK WITH 1 TIME SLOT)

LOWER BAND EDGE

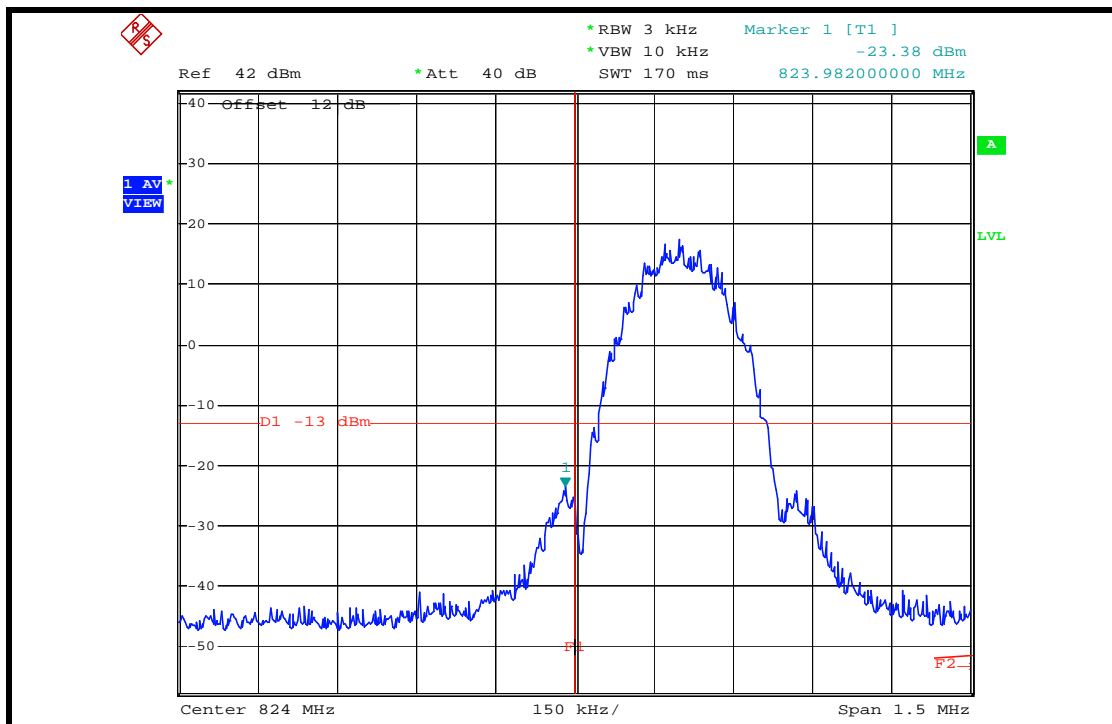

HIGHER BAND EDGE

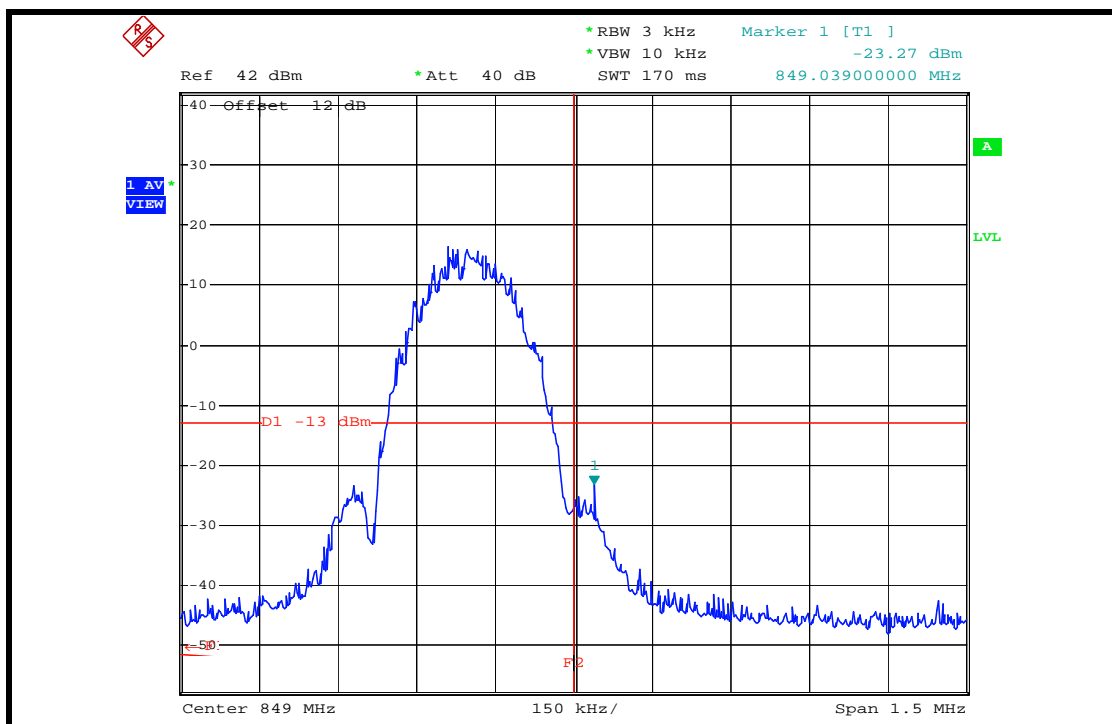



4.5 CONDUCTED SPURIOUS EMISSIONS

4.5.1 LIMITS OF CONDUCTED SPURIOUS EMISSIONS MEASUREMENT

In the FCC 22.917, On any frequency outside a licensee's frequency block within GSM850 spectrum, the power of any emission shall be attenuated below the transmitter power (P) by at least $43 + 10 \log (P)$ dB. The specified minimum attenuation becomes 43dB and the limit of emission equal to -13 dBm.

4.5.2 TEST INSTRUMENTS

| DESCRIPTION & MANUFACTURER | MODEL NO. | SERIAL NO. | CALIBRATED UNTIL |
|--|---|------------|------------------|
| * ROHDE & SCHWARZ Spectrum Analyzer | FSP40 | 100035 | Mar. 29, 2007 |
| * Wainwright Instruments Band Reject Filter | WRCG1850/1910- 1830/1930-60/10S S | SN1 | NA |
| * Wainwright Instruments High Pass Filter | WHK3.1/18G-10SS | SN1 | NA |
| * Mini-Circuits Power Splitter | ZAPD-4 | 400005 | NA |
| * Hewlett Packard RF cable | 8120-6192 | 01428251 | NA |
| * JFW 20dB attenuation | 50HF-020-SMA | NA | NA |
| * Suhner RF cable | Sucoflex104 | 204850/4 | NA |

- NOTE:**
1. The calibration interval of the above test instruments is 12 months. And the calibrations are traceable to NML/ROC and NIST/USA.
 2. "*" = These equipments are used for the final measurement.

4.5.3 TEST PROCEDURE

- a. The EUT was set up for the maximum peak power with GSM link data modulation. The power was measured with R&S Spectrum Analyzer. All measurements were done at 3 channels: 128, 190 and 251 (low, middle and high operational frequency range).
- b. The conducted spurious emission used the power splitter via EUT RF power connector between simulation base station and spectrum analyzer. This splitter loss and cable loss are the worst loss 2dB in the transmitted path track.
- c. When the spectrum scanned from 9kHz to 4GHz, it shall be connected to the band reject filter attenuated the carried frequency. The spectrum set RB/VB 1MHz.
- d. When the spectrum scanned from 4GHz to 9GHz, it shall be connected to the high pass filter attenuated the carried frequency. The spectrum set RB/VB 1MHz.

4.5.4 TEST SETUP

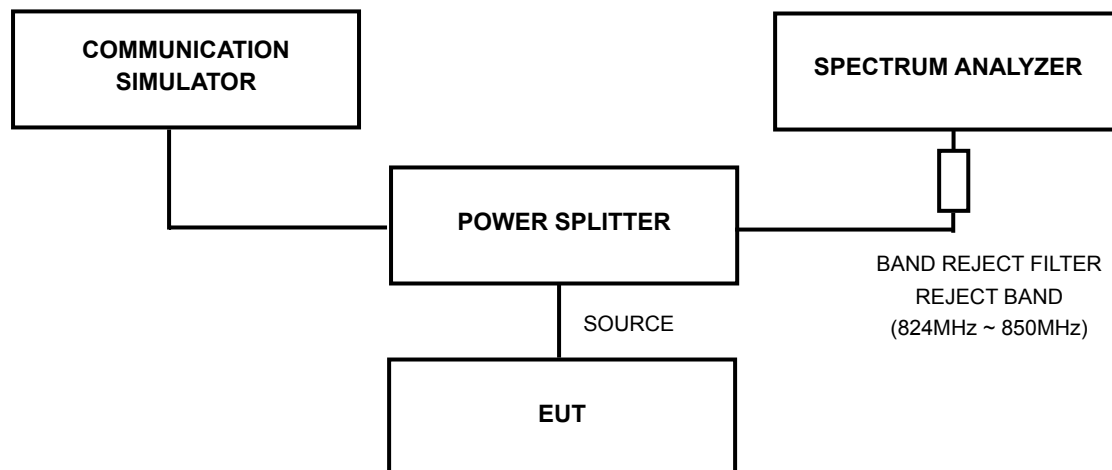

4.5.5 EUT OPERATING CONDITIONS

- a. The EUT makes a phone call to the communication simulator
- b. The communication simulator station system controlled a EUT to export maximum output power under transmission mode and specific channel frequency.

4.5.6 TEST RESULTS

CH 128: 9kHz ~ 1GHz:

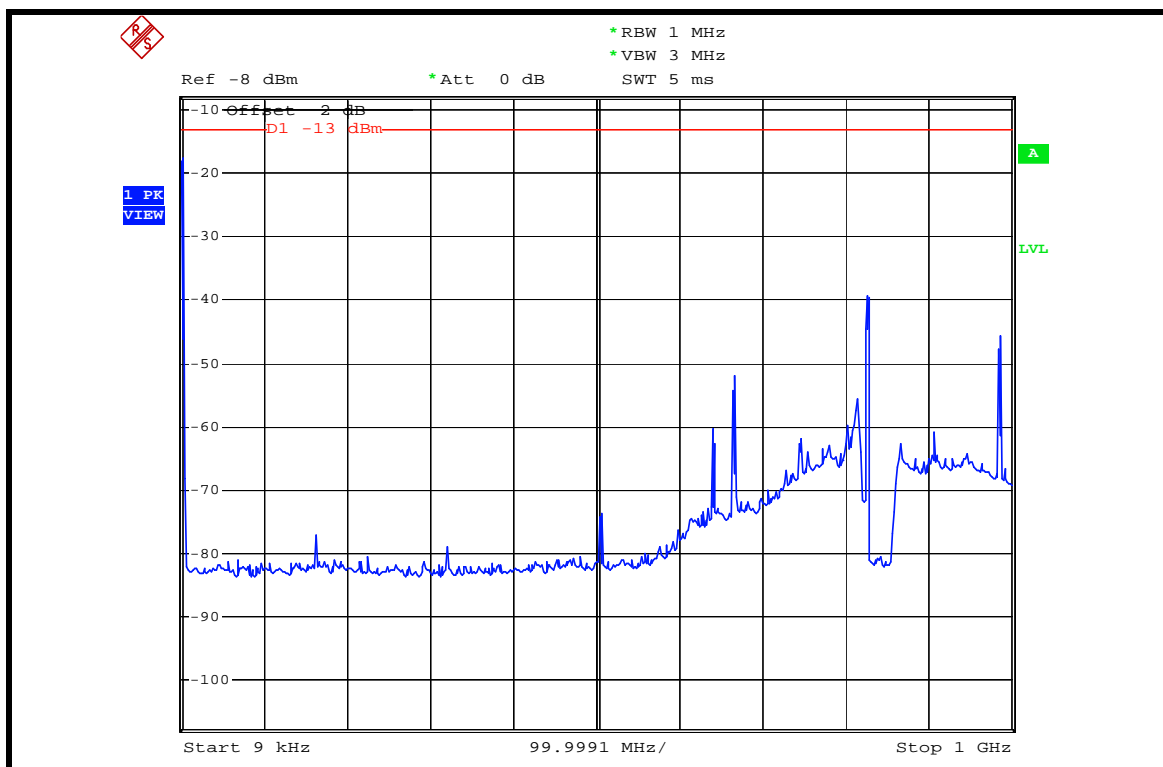

1GHz ~ 4GHz:

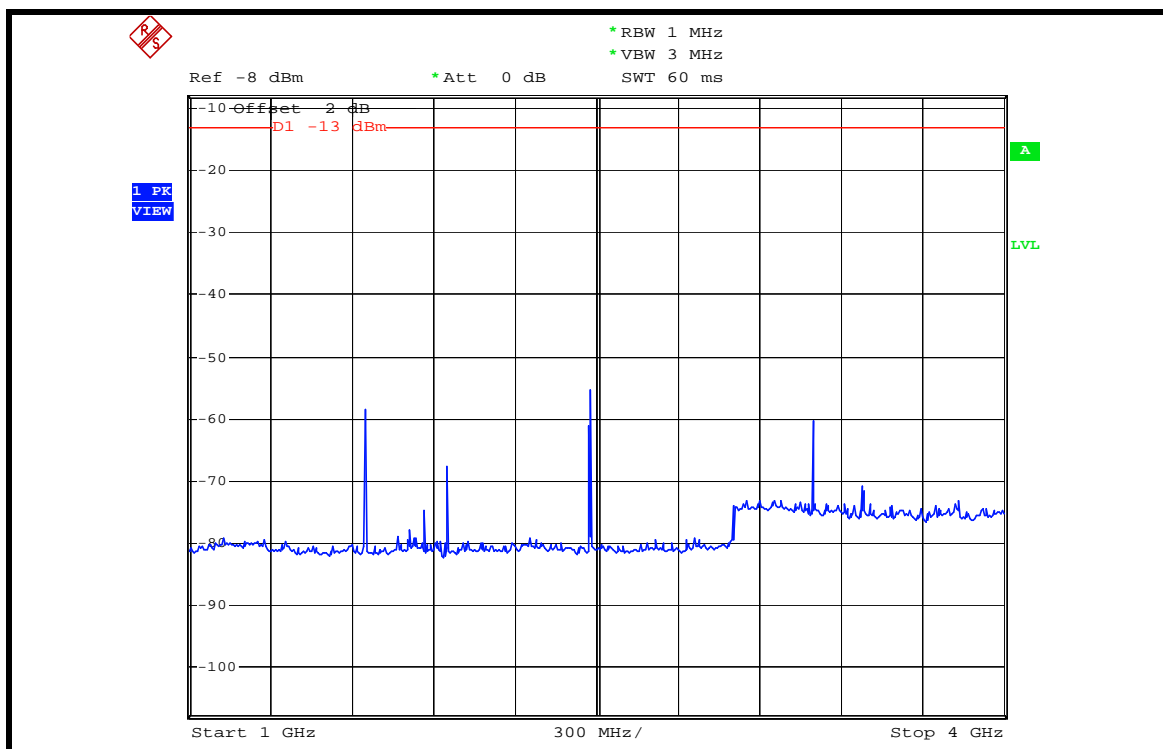

4GHz ~ 7GHz:

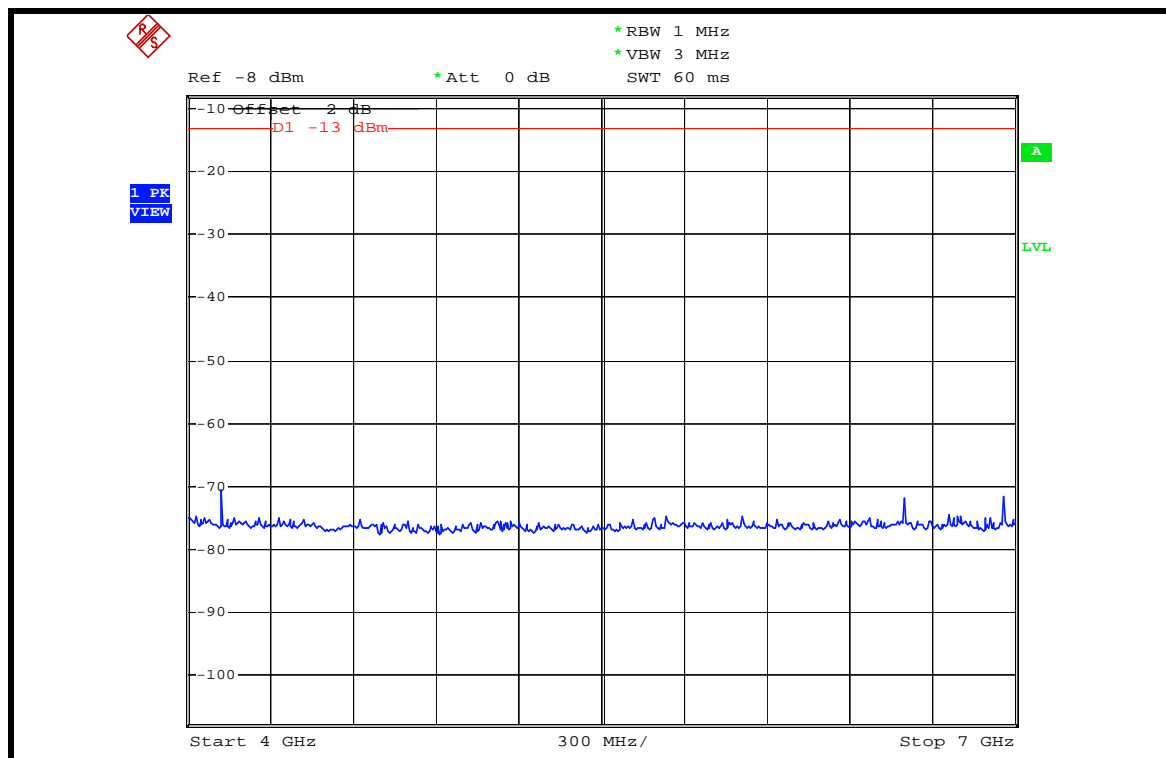

7GHz ~ 9GHz:

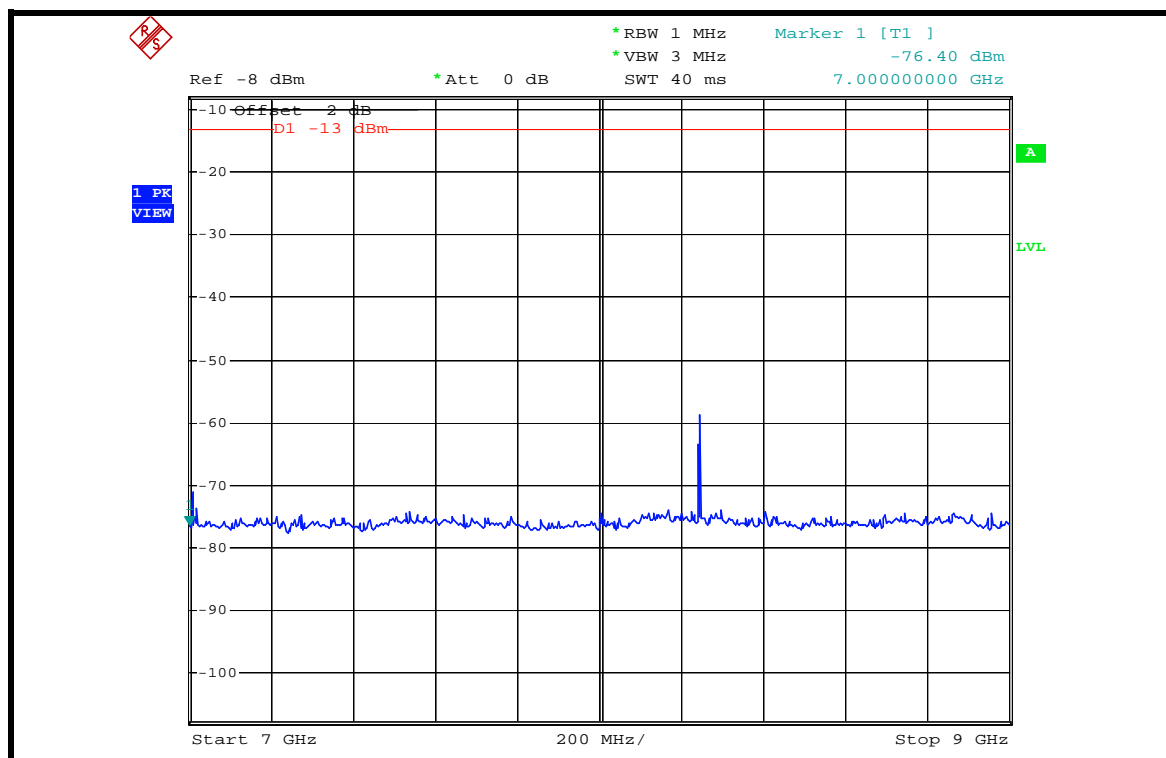

CH 190: 9kHz ~ 1GHz:

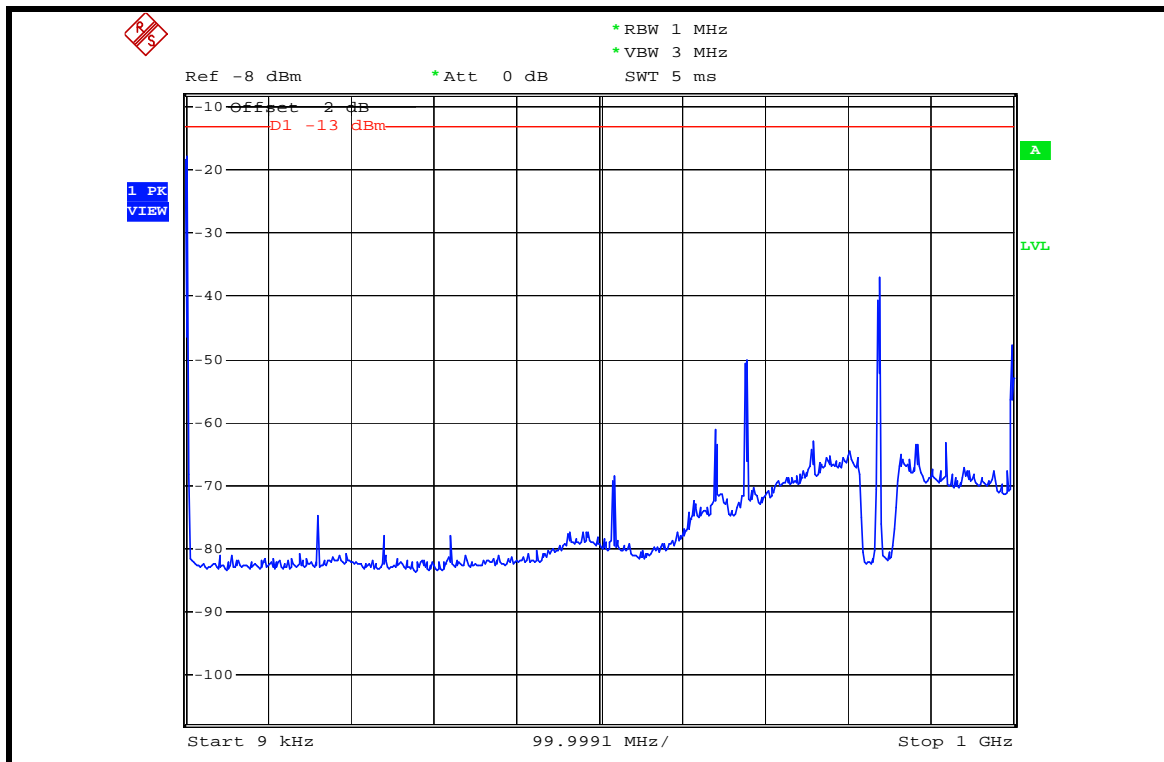

1GHz ~ 4GHz:

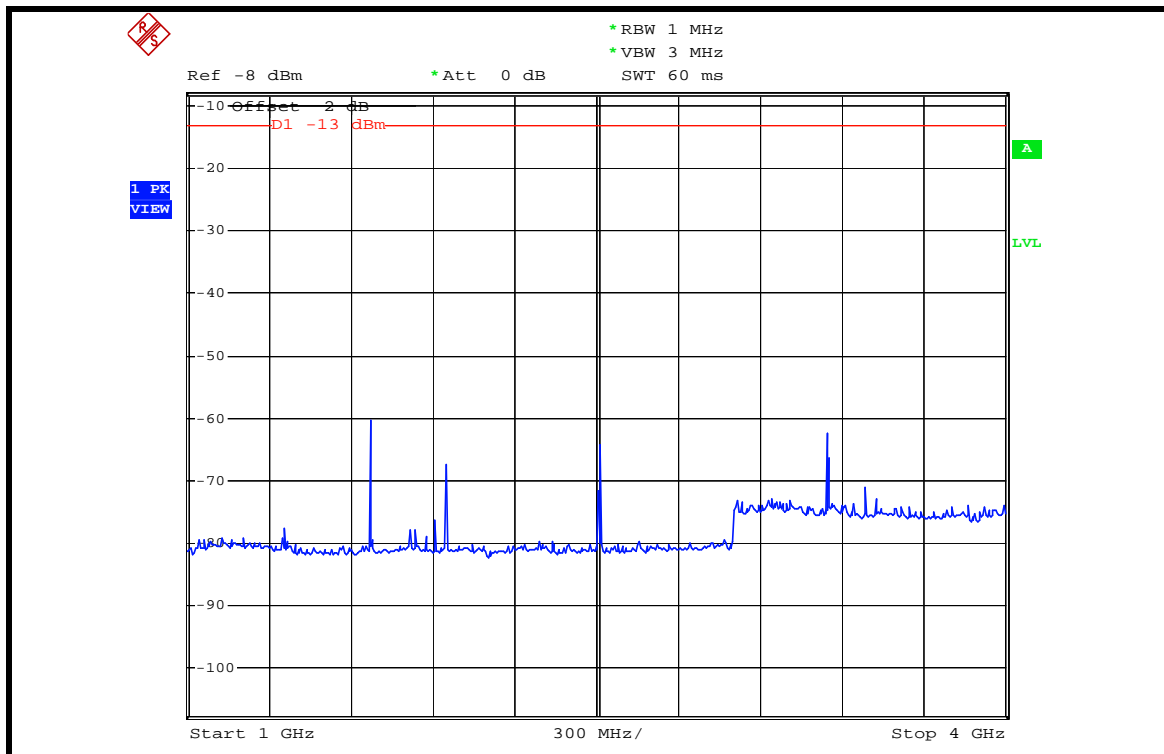

4GHz ~ 7GHz:

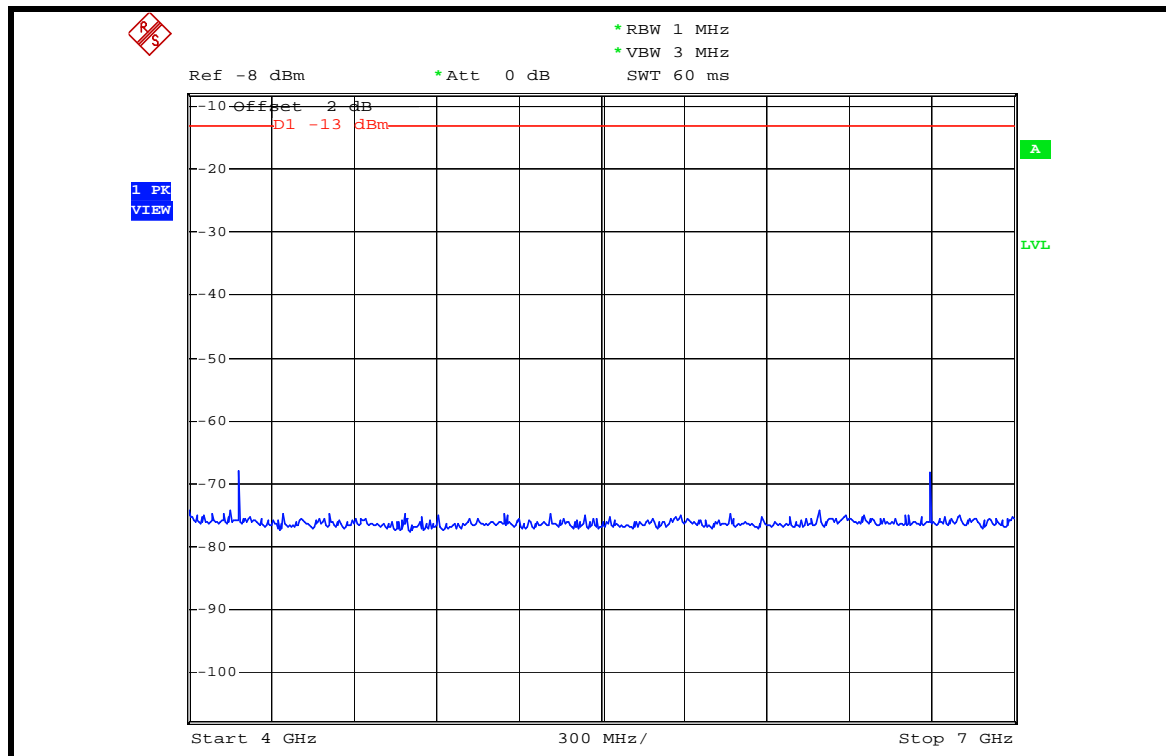

7GHz ~ 9GHz:

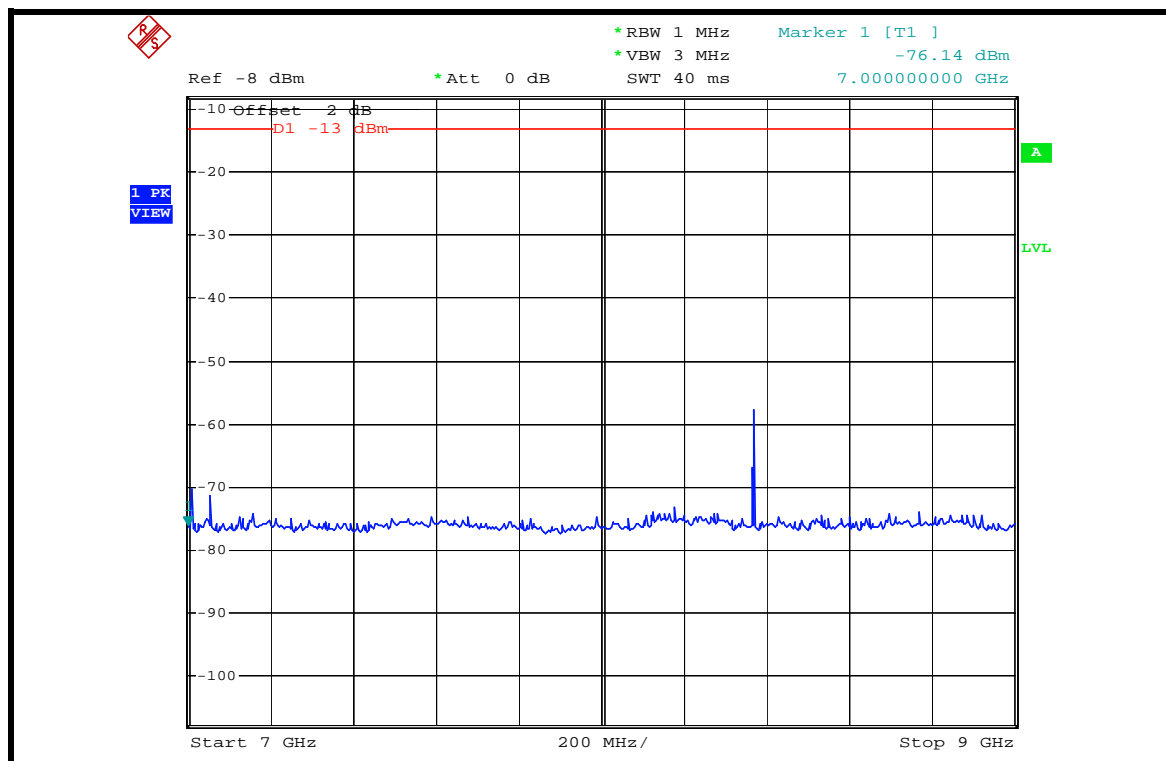

CH 251: 9kHz ~ 1GHz:

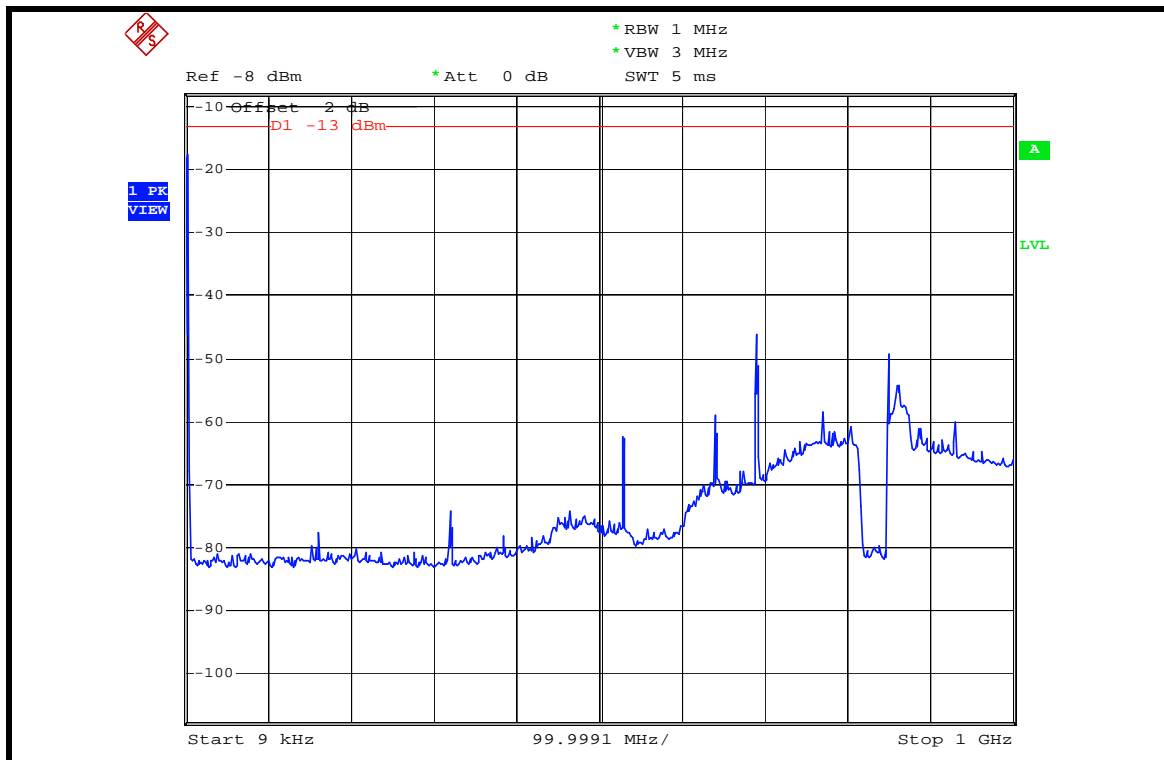

1GHz ~ 4GHz:

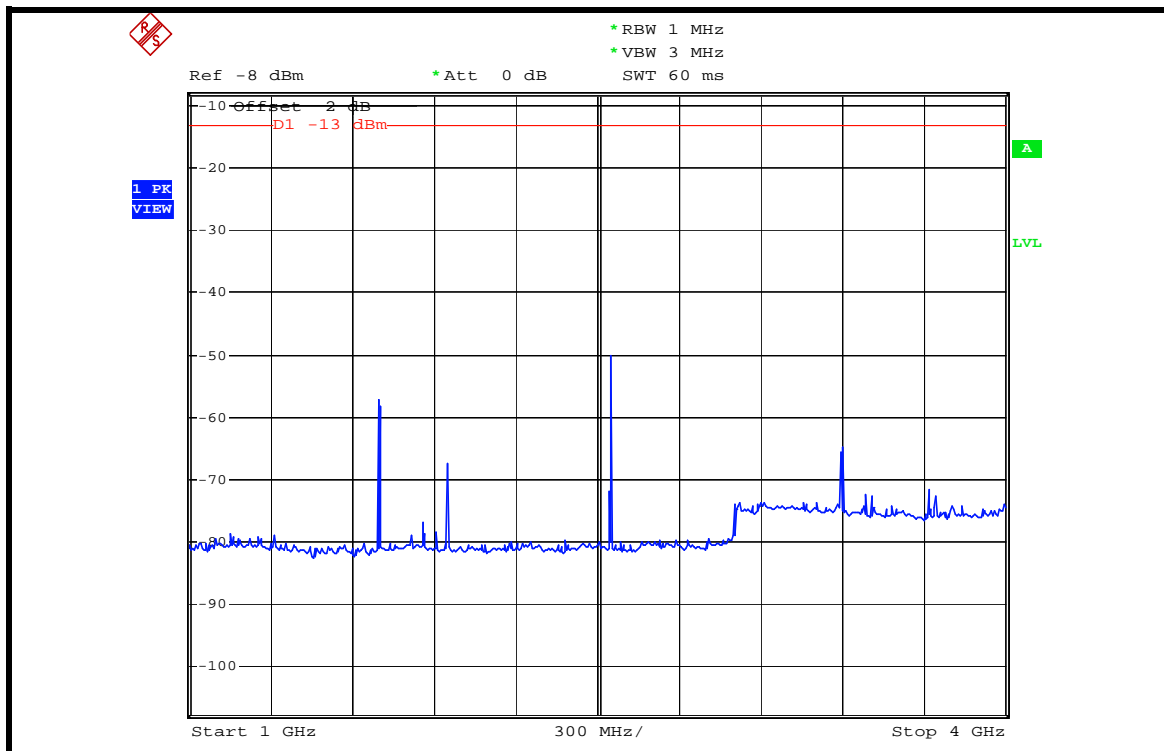

4GHz ~ 7GHz:

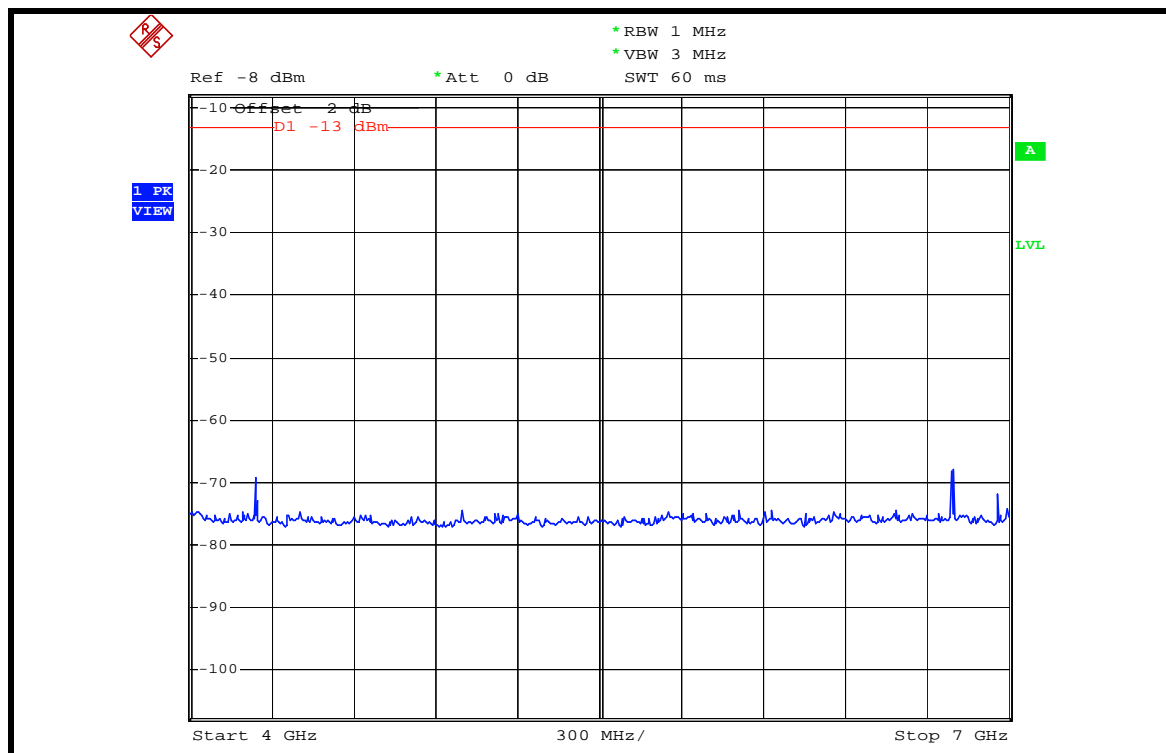

7GHz ~ 9GHz:

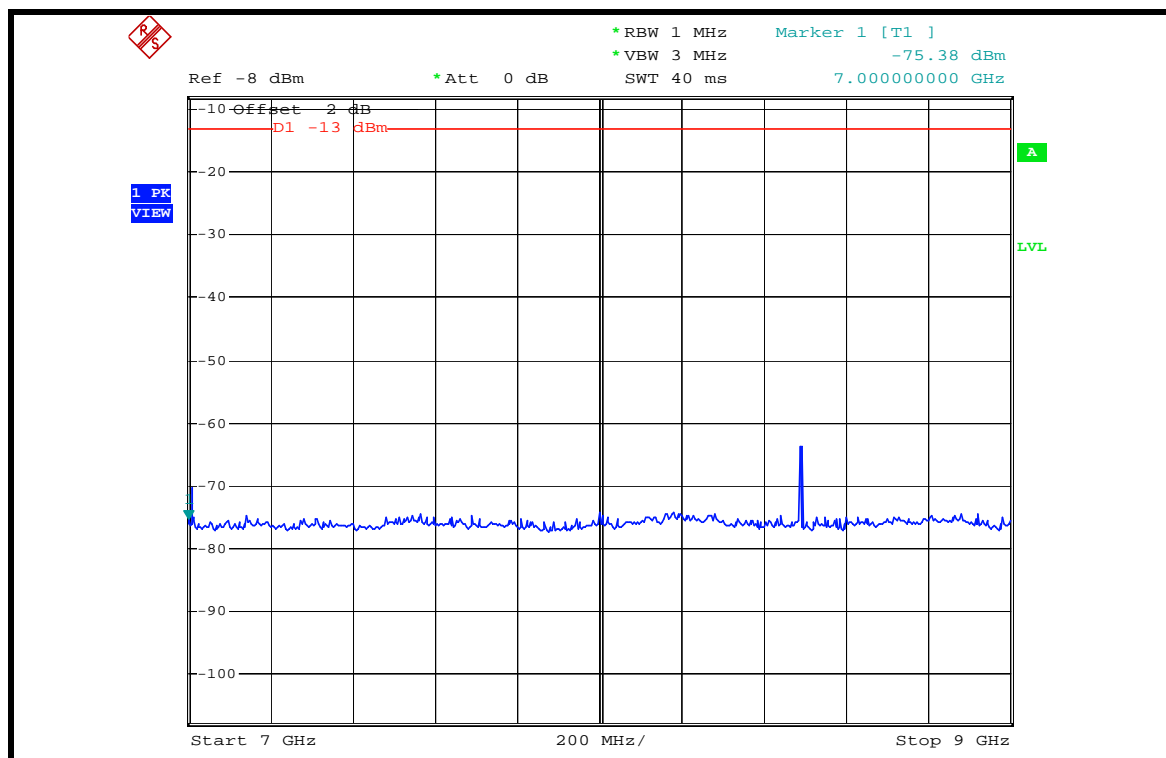

4.6 RADIATED EMISSION MEASUREMENT (BELOW 1GHz)

4.6.1 LIMITS OF RADIATED EMISSION MEASUREMENT

In the FCC 22.917, On any frequency outside a licensee's frequency block within GSM850 spectrum, the power of any emission shall be attenuated below the transmitter power (P) by at least $43 + 10 \log(P)$ dB. The specified minimum attenuation becomes 43dB and the limit of emission equal to -13 dBm. So the limit of emission is the same absolute specified line.

| LIMIT (dBm) | EQUIVALENT FIELD STRENGTH AT 3m (dBuV/m) (NOTE) |
|-------------|---|
| -13 | 82.22 |

NOTE: The following formula is used to convert the equipment radiated power to field strength.

$$E = [1000000\sqrt{(30P)}] / 3 \text{ uV/m, where P is Watts.}$$

4.6.2 TEST INSTRUMENTS

| DESCRIPTION & MANUFACTURER | MODEL NO. | SERIAL NO. | CALIBRATED UNTIL |
|---|--------------------|-------------|------------------|
| Test Receiver ROHDE & SCHWARZ | ESI7 | 100033 | May. 22, 2007 |
| Spectrum Analyzer ROHDE & SCHWARZ | FSP40 | 100025 | Dec. 05, 2006 |
| BILOG Antenna SCHWARZBECK | VULB9168 | 9168-160 | May 31, 2007 |
| HORN Antenna SCHWARZBECK | 9120D | 9120D-408 | Jan. 08, 2007 |
| HORN Antenna SCHWARZBECK | BBHA 9170 | BBHA9170243 | Jan. 19, 2007 |
| Preamplifier Agilent | 8447D | 2944A10633 | Oct. 26, 2007 |
| Preamplifier Agilent | 8449B | 3008A01964 | Oct. 26, 2007 |
| RF signal cable HUBER+SUHNNER | SUCOFLEX 104 | 214377/4 | Dec. 13, 2006 |
| RF signal cable HUBER+SUHNNER | SUCOFLEX 104 | 219272/4 | Dec. 13, 2006 |
| Software ADT. | ADT_Radiated_V5.14 | NA | NA |
| Antenna Tower inn-co GmbH | MA 4000 | 013303 | NA |
| Antenna Tower Controller inn-co GmbH | CO2000 | 017303 | NA |
| Turn Table ADT. | TT100. | TT93021703 | NA |
| Turn Table Controller ADT. | SC100. | SC93021703 | NA |

- NOTE:**
1. The calibration interval of the above test instruments is 12 months and the calibrations are traceable to NML/ROC and NIST/USA.
 2. The test was performed in HwaYa Chamber 3.
 3. The horn antenna and HP preamplifier (model: 8449B) are used only for the measurement of emission frequency above 1GHz if tested.
 4. The VCCI Site Registration No. is R-237.
 5. The IC Site Registration No. is IC4924-3.

4.6.3 TEST PROCEDURES

- a. The EUT was placed on the top of a rotating table 0.8 meters above the ground. The table was rotated 360 degrees to determine the position of the highest radiation.
- b. The EUT was set 3 meters away from the receiving antenna, which was mounted on antenna tower and its position at 0.8 m above the ground.
- c. For each suspected emission, the EUT was arranged to its worst case and the rotatable table was turned from 0 degrees to 360 degrees to find the maximum reading and recorded the value.
- d. Repeat step a ~ c for horizontal polarization.

NOTE: The resolution bandwidth of spectrum analyzer is 1MHz and the video bandwidth is 3MHz.

4.6.4 DEVIATION FROM TEST STANDARD

No deviation

4.6.5 TEST SETUP

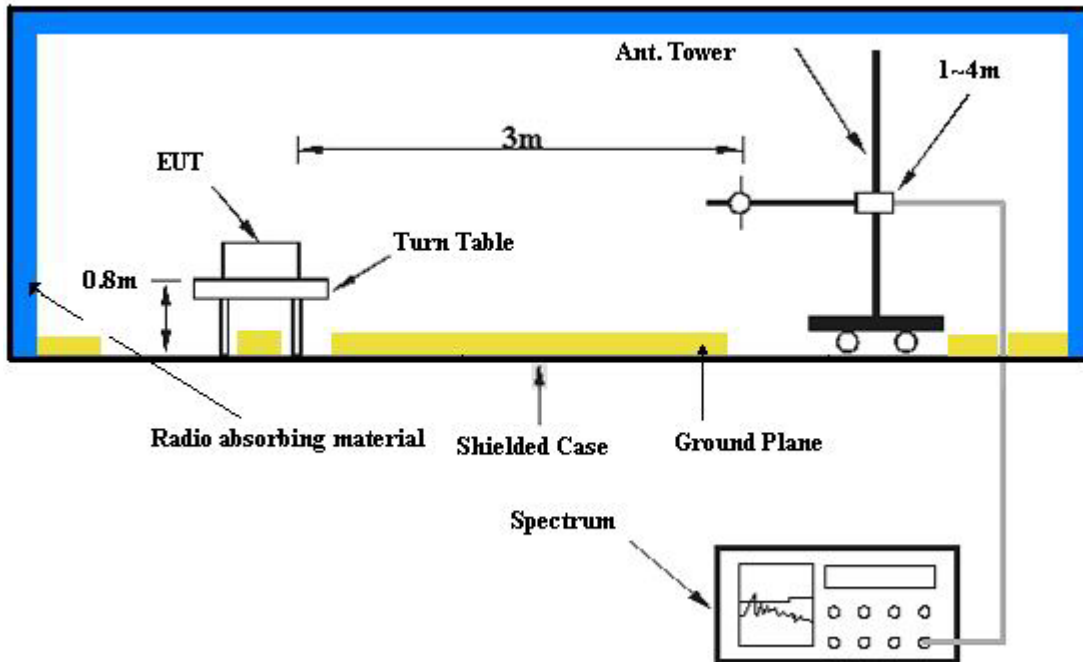

For the actual test configuration, please refer to the related item – Photographs of the Test Configuration.

4.6.6 EUT OPERATING CONDITIONS

- a. The EUT makes a phone call to the communication simulator.
- b. The communication simulator station system controlled an EUT to export maximum output power under transmission mode and specific channel frequency.

4.6.7 TEST RESULTS

| | | | |
|---------------------------------|------------------------|-----------------------------|--------------|
| MODE | Channel 128 | DETECTOR FUNCTION | Quasi-Peak |
| FREQUENCY RANGE | Below 1000MHz | INPUT POWER (SYSTEM) | 120Vac, 60Hz |
| ENVIRONMENTAL CONDITIONS | 24deg°C, 69%RH, 991hPa | TESTED BY | Morgan Chen |

| ANTENNA POLARITY & TEST DISTANCE: HORIZONTAL AT 3m | | | | | | | | |
|--|-------------|-------------------------|----------------|-------------|--------------------|----------------------|------------------|--------------------------|
| NO. | FREQ. (MHz) | EMISSION LEVEL (dBuV/m) | LIMIT (dBuV/m) | MARGIN (dB) | ANTENNA HEIGHT (m) | TABLE ANGLE (Degree) | RAW VALUE (dBuV) | CORRECTION FACTOR (dB/m) |
| 1 | 80.54 | 24.49 QP | 82.22 | -57.73 | 1.50 H | 175 | 14.51 | 9.98 |
| 2 | 543.19 | 25.28 QP | 82.22 | -56.94 | 1.50 H | 175 | 5.82 | 19.46 |
| 3 | 653.99 | 25.54 QP | 82.22 | -56.68 | 1.00 H | 320 | 4.11 | 21.44 |
| 4 | 687.03 | 26.38 QP | 82.22 | -55.84 | 1.00 H | 320 | 4.25 | 22.12 |
| 5 | 710.36 | 27.16 QP | 82.22 | -55.06 | 1.00 H | 118 | 4.45 | 22.71 |
| 6 | 722.02 | 27.63 QP | 82.22 | -54.59 | 1.50 H | 35 | 4.57 | 23.06 |
| 7 | 768.68 | 26.37 QP | 82.22 | -55.85 | 1.50 H | 54 | 2.43 | 23.94 |
| 8 | 803.67 | 25.53 QP | 82.22 | -56.69 | 1.00 H | 118 | 1.50 | 24.03 |
| 9 | 815.33 | 26.12 QP | 82.22 | -56.10 | 1.50 H | 35 | 1.95 | 24.18 |
| 10 | 931.96 | 25.97 QP | 82.22 | -56.25 | 1.50 H | 42 | -0.52 | 26.48 |
| 11 | 955.29 | 33.21 QP | 82.22 | -49.01 | 1.50 H | 54 | 5.99 | 27.21 |

| ANTENNA POLARITY & TEST DISTANCE: VERTICAL AT 3m | | | | | | | | |
|--|-------------|-------------------------|----------------|-------------|--------------------|----------------------|------------------|--------------------------|
| NO. | FREQ. (MHz) | EMISSION LEVEL (dBuV/m) | LIMIT (dBuV/m) | MARGIN (dB) | ANTENNA HEIGHT (m) | TABLE ANGLE (Degree) | RAW VALUE (dBuV) | CORRECTION FACTOR (dB/m) |
| 1 | 749.24 | 23.12 QP | 82.22 | -59.10 | 1.00 V | 263 | -0.77 | 23.89 |
| 2 | 780.34 | 22.92 QP | 82.22 | -59.30 | 1.00 V | 263 | -1.04 | 23.96 |
| 3 | 790.06 | 23.05 QP | 82.22 | -59.17 | 1.00 V | 80 | -0.92 | 23.97 |
| 4 | 821.16 | 23.24 QP | 82.22 | -58.98 | 1.00 V | 80 | -1.00 | 24.25 |
| 5 | 850.32 | 23.60 QP | 82.22 | -58.62 | 1.00 V | 308 | -1.00 | 24.61 |
| 6 | 898.92 | 24.07 QP | 82.22 | -58.15 | 1.00 V | 156 | -0.85 | 24.92 |
| 7 | 935.85 | 25.95 QP | 82.22 | -56.27 | 1.00 V | 263 | -0.72 | 26.67 |
| 8 | 955.29 | 32.81 QP | 82.22 | -49.41 | 1.00 V | 238 | 5.59 | 27.21 |

NOTE:

1. Emission level (dBuV/m) = Raw Value (dBuV) + Correction Factor (dB).
2. Correction Factor (dB/m) = Antenna Factor (dB/m) + Cable Factor (dB).
3. The other emission levels were very low against the limit.
4. Margin value = Emission level – Limit value.
5. This is valid for all 3 channels.



4.7 RADIATED EMISSION MEASUREMENT (ABOVE 1GHz)

4.7.1 LIMITS OF RADIATED EMISSION MEASUREMENT

In the FCC 22.917 (a), On any frequency outside a licensee's frequency block within GSM spectrum, the power of any emission shall be attenuated below the transmitter power (P) by at least $43 + 10 \log (P)$ dB. The specified minimum attenuation becomes 43dB and the limit of emission equal to -13 dBm.

4.7.2 TEST INSTRUMENTS

| DESCRIPTION & MANUFACTURER | MODEL NO. | SERIAL NO. | CALIBRATED UNTIL |
|---|--------------------|-------------|------------------|
| Test Receiver ROHDE & SCHWARZ | ESI7 | 100033 | May. 22, 2007 |
| Spectrum Analyzer ROHDE & SCHWARZ | FSP40 | 100025 | Dec. 05, 2006 |
| BILOG Antenna SCHWARZBECK | VULB9168 | 9168-160 | May 31, 2007 |
| HORN Antenna SCHWARZBECK | 9120D | 9120D-408 | Jan. 08, 2007 |
| HORN Antenna SCHWARZBECK | BBHA 9170 | BBHA9170243 | Jan. 19, 2007 |
| Preamplifier Agilent | 8447D | 2944A10633 | Oct. 26, 2007 |
| Preamplifier Agilent | 8449B | 3008A01964 | Oct. 26, 2007 |
| RF signal cable HUBER+SUHNNER | SUCOFLEX 104 | 214377/4 | Dec. 13, 2006 |
| RF signal cable HUBER+SUHNNER | SUCOFLEX 104 | 219272/4 | Dec. 13, 2006 |
| Software ADT. | ADT_Radiated_V5.14 | NA | NA |
| Antenna Tower inn-co GmbH | MA 4000 | 013303 | NA |
| Antenna Tower Controller inn-co GmbH | CO2000 | 017303 | NA |
| Turn Table ADT. | TT100. | TT93021703 | NA |
| Turn Table Controller ADT. | SC100. | SC93021703 | NA |
| SIGNAL GENERATOR AGILENT | E8257C | MY43320668 | Dec. 07, 2006 |

- NOTE:**
1. The calibration interval of the above test instruments is 12 months and the calibrations are traceable to NML/ROC and NIST/USA.
 2. The test was performed in HwaYa Chamber 3.
 3. The horn antenna and HP preamplifier (model: 8449B) are used only for the measurement of emission frequency above 1GHz if tested.
 4. The VCCI Site Registration No. is R-237.
 5. The IC Site Registration No. is IC4924-3.

4.7.3 TEST PROCEDURES

- a. The EUT was placed on the top of a rotating table 0.8 meters above the ground. The table was rotated 360 degrees to determine the position of the highest radiation.
- b. The EUT was set 3 meters away from the receiving antenna, which was mounted on antenna tower and its position at 0.8 m above the ground.
- c. For each suspected emission, the EUT was arranged to its worst case and the rotatable table was turned from 0 degrees to 360 degrees to find the maximum reading and recorded the value.
- d. The EUT is replaced by a horn antenna connected to a signal generator tuned to the frequency of emission.
- e. The signal generator level has to be adjusted to have the same emission nature.
- f. The radiated power can be calculated via the factor and antenna gain.
- g. Repeat step a ~ f for horizontal polarization.

NOTE: The resolution bandwidth of spectrum analyzer is 1MHz and the video bandwidth is 3MHz.

4.7.4 DEVIATION FROM TEST STANDARD

No deviation

4.7.5 TEST SETUP

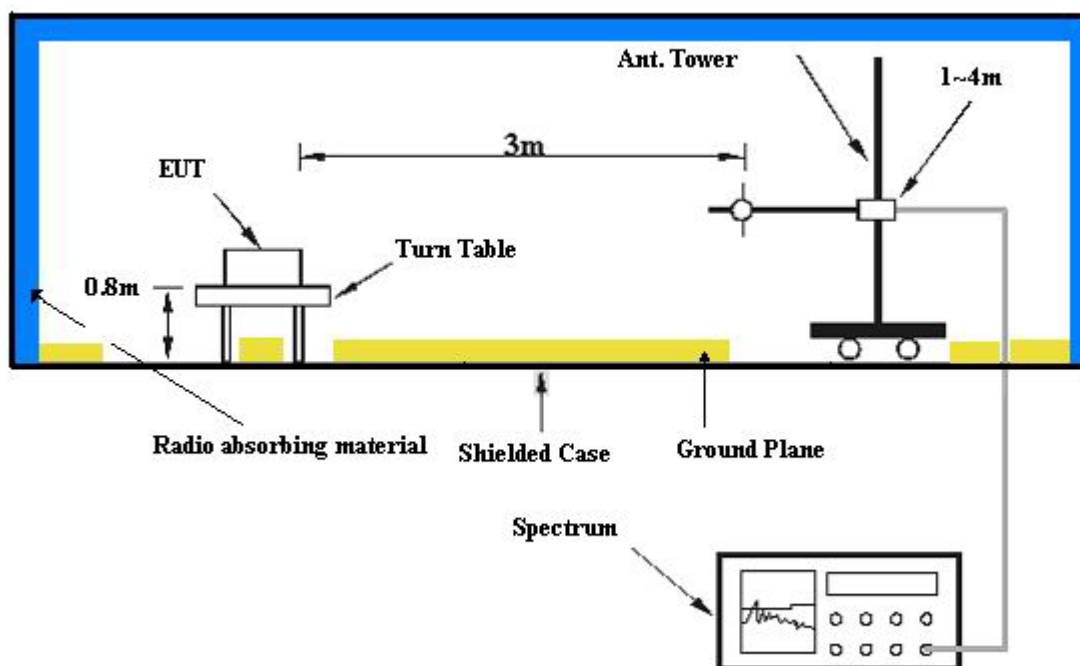

For the actual test configuration, please refer to the related item – Photographs of the Test Configuration.

4.7.6 EUT OPERATING CONDITIONS

- a. The EUT makes a phone call to the communication simulator.
- b. The communication simulator station system controlled an EUT to export maximum output power under transmission mode and specific channel frequency.



4.7.7 TEST RESULTS

| | | | |
|-----------------------------|--------------|---------------------------------|------------------------|
| MODE | Channel 128 | FREQUENCY RANGE | Above 1000MHz |
| INPUT POWER (SYSTEM) | 120Vac, 60Hz | ENVIRONMENTAL CONDITIONS | 25deg°C, 67%RH, 991hPa |
| TESTED BY | Morgan Chen | | |

| ANTENNA POLARITY & TEST DISTANCE: HORIZONTAL AT 3m | | | | | | |
|--|-------------|-----------------------|-------------|-----------------------|------------------------|-------------------|
| NO. | FREQ. (MHz) | EMISSION LEVEL (dBuV) | LIMIT (dBm) | S.G POWER VALUE (dBm) | CORRECTION FACTOR (dB) | POWER VALUE (dBm) |
| 1 | 1648.00 | 46.35 | -13.00 | -59.00 | 10.12 | -48.88 |
| 2 | 2472.00 | 50.85 | -13.00 | -55.87 | 11.49 | -44.38 |
| 3 | 3296.00 | 43.24 | -13.00 | -64.49 | 12.50 | -51.99 |

| ANTENNA POLARITY & TEST DISTANCE: VERTICAL AT 3m | | | | | | |
|--|-------------|-----------------------|-------------|-----------------------|------------------------|-------------------|
| NO. | FREQ. (MHz) | EMISSION LEVEL (dBuV) | LIMIT (dBm) | S.G POWER VALUE (dBm) | CORRECTION FACTOR (dB) | POWER VALUE (dBm) |
| 1 | 1648.00 | 58.55 | -13.00 | -46.80 | 10.12 | -36.68 |
| 2 | 2472.00 | 53.56 | -13.00 | -53.16 | 11.49 | -41.67 |
| 3 | 3296.00 | 49.26 | -13.00 | -58.47 | 12.50 | -45.97 |

NOTE: Power Value (dBum) = S.G Power Value (dBm) + Correction Factor (dB).



| | | | |
|-----------------------------|--------------|---------------------------------|------------------------|
| MODE | Channel 190 | FREQUENCY RANGE | Above 1000MHz |
| INPUT POWER (SYSTEM) | 120Vac, 60Hz | ENVIRONMENTAL CONDITIONS | 25deg°C, 67%RH, 991hPa |
| TESTED BY | Morgan Chen | | |

| ANTENNA POLARITY & TEST DISTANCE: HORIZONTAL AT 3m | | | | | | |
|---|--------------------|------------------------------|--------------------|------------------------------|-------------------------------|--------------------------|
| NO. | FREQ. (MHz) | EMISSION LEVEL (dBuV) | LIMIT (dBm) | S.G POWER VALUE (dBm) | CORRECTION FACTOR (dB) | POWER VALUE (dBm) |
| 1 | 1673.00 | 44.15 | -13.00 | -61.20 | 10.12 | -51.08 |
| 2 | 2510.00 | 47.68 | -13.00 | -59.04 | 11.49 | -47.55 |
| 3 | 3346.00 | 40.78 | -13.00 | -66.95 | 12.50 | -54.45 |

| ANTENNA POLARITY & TEST DISTANCE: VERTICAL AT 3m | | | | | | |
|---|--------------------|------------------------------|--------------------|------------------------------|-------------------------------|--------------------------|
| NO. | FREQ. (MHz) | EMISSION LEVEL (dBuV) | LIMIT (dBm) | S.G POWER VALUE (dBm) | CORRECTION FACTOR (dB) | POWER VALUE (dBm) |
| 1 | 1673.00 | 57.25 | -13.00 | -48.10 | 10.12 | -37.98 |
| 2 | 2510.00 | 52.86 | -13.00 | -53.86 | 11.49 | -42.37 |
| 3 | 3346.00 | 48.52 | -13.00 | -59.21 | 12.50 | -46.71 |

NOTE: Power Value (dBum) = S.G Power Value (dBm) + Correction Factor (dB).



| | | | |
|-----------------------------|--------------|---------------------------------|------------------------|
| MODE | Channel 251 | FREQUENCY RANGE | Above 1000MHz |
| INPUT POWER (SYSTEM) | 120Vac, 60Hz | ENVIRONMENTAL CONDITIONS | 25deg°C, 67%RH, 991hPa |
| TESTED BY | Morgan Chen | | |

| ANTENNA POLARITY & TEST DISTANCE: HORIZONTAL AT 3m | | | | | | |
|--|-------------|-----------------------|-------------|-----------------------|------------------------|-------------------|
| NO. | FREQ. (MHz) | EMISSION LEVEL (dBuV) | LIMIT (dBm) | S.G POWER VALUE (dBm) | CORRECTION FACTOR (dB) | POWER VALUE (dBm) |
| 1 | 1698.00 | 44.98 | -13.00 | -60.42 | 10.17 | -50.25 |
| 2 | 2546.00 | 48.65 | -13.00 | -58.07 | 11.49 | -46.58 |
| 3 | 3395.00 | 42.53 | -13.00 | -65.26 | 12.56 | -52.70 |

| ANTENNA POLARITY & TEST DISTANCE: VERTICAL AT 3m | | | | | | |
|--|-------------|-----------------------|-------------|-----------------------|------------------------|-------------------|
| NO. | FREQ. (MHz) | EMISSION LEVEL (dBuV) | LIMIT (dBm) | S.G POWER VALUE (dBm) | CORRECTION FACTOR (dB) | POWER VALUE (dBm) |
| 1 | 1698.00 | 56.68 | -13.00 | -48.72 | 10.17 | -38.55 |
| 2 | 2546.00 | 51.00 | -13.00 | -55.72 | 11.49 | -44.23 |
| 3 | 3395.00 | 47.89 | -13.00 | -59.90 | 12.56 | -47.34 |

NOTE: Power Value (dBum) = S.G Power Value (dBm) + Correction Factor (dB).



5 INFORMATION ON THE TESTING LABORATORIES

We, ADT Corp., were founded in 1988 to provide our best service in EMC, Radio, Telecom and Safety consultation. Our laboratories are accredited and approved by the following approval agencies according to ISO/IEC 17025.

| | |
|--------------------|-----------------------|
| USA | FCC, UL, A2LA |
| GERMANY | TUV Rheinland |
| JAPAN | VCCI |
| NORWAY | NEMKO |
| CANADA | INDUSTRY CANADA , CSA |
| R.O.C. | CNLA, BSMI, NCC |
| NETHERLANDS | Telefication |
| SINGAPORE | PSB , GOST-ASIA (MOU) |
| RUSSIA | CERTIS (MOU) |

Copies of accreditation certificates of our laboratories obtained from approval agencies can be downloaded from our web site:

www.adt.com.tw/index.5/phtml. If you have any comments, please feel free to contact us at the following:

Linko EMC/RF Lab:

Tel: 886-2-26052180
Fax: 886-2-26051924

Hsin Chu EMC/RF Lab:

Tel: 886-3-5935343
Fax: 886-3-5935342

Hwa Ya EMC/RF/Safety/Telecom Lab:

Tel: 886-3-3183232
Fax: 886-3-3185050

Web Site: www.adt.com.tw

The address and road map of all our labs can be found in our web site also.