



1190
ILAC MRA

Specific Absorption Rate (SAR) Test Report
for
SYMBOL Technologies, Inc.
on the
Mobile Computer

Report No. : FA591501-1-2-01
Trade Name : SYMBOL
Type number of RF module : 21-21160
MODEL OF HOST : MC3090BT (with 11a/b/g module)
FCC ID : H9PMC3090BT
Date of Testing : Sep. 14, 2005
Date of Report : Sep. 21, 2005
Date of Review : Sep. 21, 2005

- The test results refer exclusively to the presented test model / sample only.
- Without written approval of SPORTON International Inc., the test report shall not be reproduced except in full.
- Report Version: Rev. 01

SPORTON International Inc.

6F, No.106, Sec. 1, Hsin Tai Wu Rd., Hsi Chih, Taipei Hsien, Taiwan, R.O.C.



Table of Contents

1. Statement of Compliance	1
2. Administration Data	2
2.1 Testing Laboratory	2
2.2 Detail of Applicant.....	2
2.3 Detail of Manufacturer	2
2.4 Application Detail.....	2
3. Scope	3
3.1 Description of Device Under Test (DUT)	3
3.2 Product Photo	4
3.3 Applied Standards:	7
3.4 Device Category and SAR Limits	8
3.5 Test Conditons	8
3.5.1 Ambient Condition:	8
3.5.2 Test Configuration:.....	8
4. Specific Absorption Rate (SAR)	9
4.1 Introduction	9
4.2 SAR Definition.....	9
5. SAR Measurement Setup	10
5.1 DAS4 E-Field Probe System.....	11
5.1.1 EX3DV3 E-Field Probe Specification.....	12
5.1.2 EX3DV3 E-Field Probe Calibration.....	12
5.2 DATA Acquisition Electronics (DAE)	13
5.3 Robot.....	14
5.4 Measurement Server.....	14
5.5 SAM Twin Phantom.....	14
5.6 Data Storage and Evaluation.....	16
5.6.1 Data Storage.....	16
5.6.2 Data Evaluation	16
5.7 Test Equipment List	19
6. Tissue Simulating Liquids	20
7. Uncertainty Assessment	21
8. SAR Measurement Evaluation	23
8.1 Purpose of System Performance check	23
8.2 System Setup.....	23
8.3 Validation Results.....	25
9. Description for DUT Testing Position	26
10. Measurement Procedures	29
10.1 Spatial Peak SAR Evaluation	29
10.2 Scan Procedures.....	30
10.3 SAR Averaged Methods	30
11. SAR Test Results	31
11.1 Keypad Up with Touch.....	31
11.2 Keypad Down with Touch	31



11.3 Right Side.....	31
11.4 Left Side.....	32
11.5 Holster.....	32
12. References.....	33

Appendix A – System Performance Check Data

Appendix B – SAR Measurement Data

Appendix C – Calibration Data



1. Statement of Compliance

The Specific Absorption Rate (SAR) maximum result found during testing for the **SYMBOL Technologies, Inc. Mobile Computer MC3090BT** are as follows (with expanded uncertainty 25.6%):

Item Model Name	5200 body (W/kg) <Band 1>	5300 body (W/kg) <Band 2>	5800 body (W/kg) <Band 3>
MC3090BT	0.258	0.637	0.397

It is in compliance with Specific Absorption Rate (SAR) for general population/uncontrolled exposure limits specified in FCC 47 CFR part 2 (2.1093) and ANSI/IEEE C95.1-1999 and had been tested in accordance with the measurement methods and procedures specified in OET Bulletin 65 Supplement C (Edition 01-01).

Tested by

Approved by

Steven Yeh
Test Engineer

Dr. C.H. Daniel Lee
SAR Lab. Manager



2. Administration Data

2.1 Testing Laboratory

Company Name : Sporton International Inc.
Department : Antenna Design/SAR
Address : No.52, Hwa-Ya 1st RD., Hwa Ya Technology Park, Kwei-Shan Hsiang, TaoYuan Hsien, Taiwan, R.O.C.
Telephone Number : 886-3-327-3456
Fax Number : 886-3-327-0973

2.2 Detail of Applicant

Company Name : SYMBOL Technologies, Inc.
Address : One Symbol Plaza Holtsville, New York, 11742-1300 U.S.A.

2.3 Detail of Manufacturer

Company Name : Universal Scientific Industrial Co., Ltd.
Address : 141, Lane 351, Taiping Road, Sec. 1, Tsao Tuen, Nan-Tou, Taiwan, R.O.C.
Telephone Number : 886-49-2261876
Fax Number : 886-49-2254838
Contact Person : tc1126@ms.usi.com.tw

2.4 Application Detail

Date of reception of application: Sep. 13, 2005
Start of test : Sep. 14, 2005
End of test : Sep. 14, 2005



3. Scope

3.1 Description of Device Under Test (DUT)

DUT Type :	Mobile Computer
Trade Name :	SYMBOL
Model Name :	MC3090BT
FCC ID :	H9PMC3090BT
Type of Modulation :	OFDM (BPSK/QPSK/16QAM/64QAM) for 802.11a
Frequency Band :	5150~5250 MHz for Band 1 5250~5350 MHz for Band 2 5725~5825 MHz for Band 3
Antenna Connector :	N/A
Antenna Type :	PIFA Antenna
Antenna Gain :	Antenna 1: 4.9 dBi Antenna 2: 5 dBi
Maximum Output Power to Antenna :	17.7 dBm for Band 1 18.76 dBm for Band 2 18.65 dBm for Band 3
Power Rating (DC/AC Voltage) :	Battery: 3.7Vdc Adapter: 100Vac to 240Vac
Temperature Range (Operating) :	-20 ~+55 0%~95%
DUT Stage :	Production Unit
Application Type :	Certification
Accessory :	Battery: Symbol, 55-060112-86 Adapter: Delta, ADP-16GB



3.2 Product Photo



Front View of Rotating



Back View of Rotating



Front View of Holster



Back View of Holster



Front View of Gun Type Holster



Back View of Gun Type Holster



Right Side View of DUT



Left Side View of DUT



Front View of Battery



Back View of Battery



Right View of Gun Type Holster



Left View of Gun Type Holster



Front View of Gun



3.3 Applied Standards:

The Specific Absorption Rate (SAR) testing specification, method and procedure for this Mobile Computer is in accordance with the following standards:

47 CFR Part 2 (2.1093),
IEEE C95.1-1999,
IEEE C95.3-2002,
IEEE P1528 -2003, and
OET Bulletin 65 Supplement C (Edition 01-01)



3.4 Device Category and SAR Limits

This device belongs to portable device category because its radiating structure is allowed to be used within 20 centimeters of the body of the user. Limit for General Population/Uncontrolled exposure should be applied for this device, it is 1.6 W/kg as averaged over any 1 gram of tissue.

3.5 Test Conditons

3.5.1 Ambient Condition:

Item	5200 <Band 1>	5300 <Band 2>	5800 <Band 3>
Ambient Temperature (°C)	20 ~ 24		
Tissue simulating liquid temperature (°C)	22.2	22.2	22.3
Humidity (%)	< 60%		

3.5.2 Test Configuration:

Engineering testing software installed on EUT can provide continuous transmitting RF signal. This RF signal utilized in SAR measurement has almost 100% duty cycle and its crest factor is 1.

This EUT has lots of optional components as the following table.

Display	1) Color W/Touch Panel 2) Mono W/Touch Panel 3) Color W/O Touch Panel 4) Mono W/O Touch Panel
Keypad	1) 28 2) 38 3) 48
Scanner	1) SE800hP 2) PICO Imager
Battery	1) 1X (SAMSUNG) 3.7V 2600mAh 2) 2X (SANYO) 3.7V 4400mAh

The EUT was fixed at “Keypad Up” and “Keypad Down” testing position and was fixed at 802.11b channel 6 to search for the worst case component combinations. The tested combinations are (1) Mono/48/PICO/2X (2) Color/48/PICO/2X (3) Mono/28/PICO/2X (4) Mono/38/PICO/2X (5) Mono/38/SE800hp/2X and (6) Mono/38/SE800hp/1X.

The worst combination is combination (5) with keypad up. All the following testing is based on this combination. The Rotating type was tested in “Keypad Up” and “Keypad Down”. The Gun type was tested in “Right Side” and “Left Side”.



4. Specific Absorption Rate (SAR)

4.1 Introduction

SAR is related to the rate at which energy is absorbed per unit mass in an object exposed to a radio field. The SAR distribution in a biological body is complicated and is usually carried out by experimental techniques or numerical modeling. The FCC recommends limits for two tiers of groups, occupational/controlled and general population/uncontrolled, based on a person’s awareness and ability to exercise control over his or her exposure. In general, occupational/controlled exposure limits are higher than the limits for general population/uncontrolled.

4.2 SAR Definition

The SAR definition is the time derivative (rate) of the incremental energy (dW) absorbed by (dissipated in) an incremental mass (dm) contained in a volume element (dv) of a given density.

). The equation description is as below:

$$\mathbf{SAR} = \frac{d}{dt} \left(\frac{dW}{dm} \right) = \frac{d}{dt} \left(\frac{dW}{\rho dv} \right)$$

SAR is expressed in units of Watts per kilogram (W/kg)

SAR measurement can be either related to the temperature elevation in tissue by

$$\mathbf{SAR} = C \frac{\delta T}{\delta t}$$

, where C is the specific head capacity, δT is the temperature rise and δt the exposure duration,

or related to the electrical field in the tissue by

$$\mathbf{SAR} = \frac{\sigma |E|^2}{\rho}$$

, where σ is the conductivity of the tissue, ρ is the mass density of the tissue and E is the rms electrical field strength.

However for evaluating SAR of low power transmitter, electrical field measurement is typically applied.

5. SAR Measurement Setup

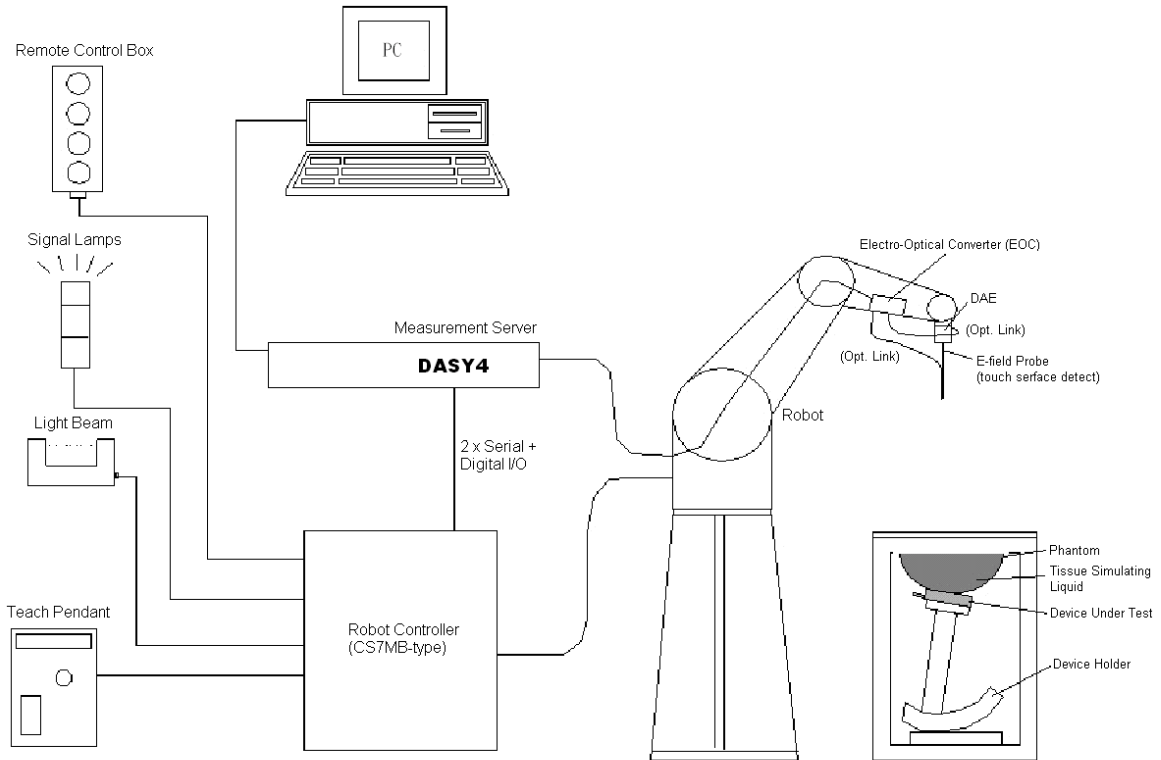

Fig. 5.1 DASY4 system



The DASY4 system for performance compliance tests is illustrated above graphically. This system consists of the following items:

- A standard high precision 6-axis robot with controller, a teach pendant and software
- A data acquisition electronic (DAE) attached to the robot arm extension
- A dosimetric probe equipped with an optical surface detector system
- The electro-optical converter (ECO) performs the conversion between optical and electrical signals
- A measurement server performs the time critical tasks such as signal filtering, control of the robot operation and fast movement interrupts.
- A probe alignment unit which improves the accuracy of the probe positioning
- A computer operating Windows XP
- DASY4 software
- Remove control with teach pendant and additional circuitry for robot safety such as warning lamps, etc.
- The SAM twin phantom
- A device holder
- Tissue simulating liquid
- Dipole for evaluating the proper functioning of the system

Some of the components are described in details in the following sub-sections.

5.1 DASY4 E-Field Probe System

The SAR measurement is conducted with the dosimetric probe EX3DV3 (manufactured by SPEAG). The probe is specially designed and calibrated for use in liquid with high permittivity. The dosimetric probe has special calibration in liquid at different frequency.



5.1.1 EX3DV3 E-Field Probe Specification

Construction	Symmetrical design with triangular core Built-in shielding against static charges PEEK enclosure material (resistant to organic solvents)
Calibration	Basic Broad Band Calibration in air: 10-3000 MHz Conversion Factors (CF) for HSL 900 and HSL 1800 Additional CF for other liquids and frequencies upon request
Frequency	10 MHz to > 6 GHz; Linearity: ± 0.2 dB (30 MHz to 3 GHz)
Directivity	± 0.3 dB in HSL (rotation around probe axis) ± 0.5 dB in tissue material (rotation normal to probe axis)
Dynamic Range	10 μ W/g to > 100 mW/g; Linearity: ± 0.2 dB (noise: typically < 1 μ W/g)
Dimensions	Overall length: 330 mm (Tip: 20 mm) Tip diameter: 2.5 mm (Body: 12 mm) Typical distance from probe tip to dipole centers: 1 mm
Application	High precision dosimetric measurements in any exposure scenario (e.g., very strong gradient fields). Only probe which enables compliance testing for frequencies up to 6 GHz with precision of better 30%.



Fig. 5.2 EX3DV3 E-field Probe

5.1.2 EX3DV3 E-Field Probe Calibration

Each probe needs to be calibrated according to a dosimetric assessment procedure with accuracy better than $\pm 10\%$. The spherical isotropy shall be evaluated and within ± 0.25 dB. The sensitivity parameters (NormX, NormY, and NormZ), the diode compression parameter (DCP) and the conversion factor (ConvF) of the probe are tested. The calibration data are as below:



Sensitivity	X axis : 0.66 μ V	Y axis : 0.67 μ V	Z axis : 0.60 μ V	
Diode compression point	X axis : 97 mV	Y axis : 97 mV	Z axis : 97 mV	
Conversion factor (Head/Body)	Frequency (MHz)	X axis	Y axis	Z axis
	4940~5460	4.88/4.14	4.88/4.14	4.88/4.14
	5510~6090	4.38/3.85	4.38/3.85	4.38/3.85
Boundary effect (Head/Body)	Frequency (MHz)	Alpha	Depth	
	4940~5460	0.42/0.45	1.8/1.9	
	5510~6090	0.42/0.43	1.8/1.9	

NOTE:

1. The probe parameters have been calibrated by the SPEAG.
2. For the detailed calibration data is shown in Appendix C.

5.2 DATA Acquisition Electronics (DAE)

The data acquisition electronics (DAE4) consists of a highly sensitive electrometer-grade preamplifier with auto-zeroing, a channel and gain-switching multiplexer, a fast 16 bit AD-converter and a command decoder and control logic unit. Transmission to the measurement server is accomplished through an optical downlink for data and status information as well as an optical uplink for commands and the clock.

The mechanical probe mounting device includes two different sensor systems for frontal and sideways probe contacts. They are used for mechanical surface detection and probe collision detection.

The input impedance of the DAE4 is 200M Ohm; the inputs are symmetrical and floating. Common mode rejection is above 80dB.

Calibration data is attached in Appendix C.



5.3 Robot

The DASY4 system uses the high precision robots RX90BL type out of the newer series from Stäubli SA (France). For the 6-axis controller DASYS system, the CS7MB robot controller version from Stäubli is used. The RX robot series have many features that are important for our application:

- High precision (repeatability 0.02 mm)
- High reliability (industrial design)
- Jerk-free straight movements
- Low ELF interference (the closed metallic construction shields against motor control fields)
- 6-axis controller

5.4 Measurement Server

The DASY4 measurement server is based on a PC/104 CPU board with
166 MHz CPU
32 MB chipset and
64 MB RAM.

Communication with
the DAE4 electronic box
the 16-bit AD-converter system for optical detection and digital I/O interface.

The measurement server performs all the real-time data evaluation for field measurements and surface detection, controls robot movements and handles safety operations.

5.5 SAM Twin Phantom

The SAM twin phantom is a fiberglass shell phantom with 2mm shell thickness (except the ear region where shell thickness increases to 6mm). It has three measurement areas:

- Left head
- Right head
- Flat phantom

The bottom plate contains three pair of bolts for locking the device holder. The device holder positions are adjusted to the standard measurement positions in the three sections.



A white cover is provided to tap the phantom during off-periods to prevent water evaporation and changes in the liquid parameters.

On the phantom top, three reference markers are provided to identify the phantom position with respect to the robot.

The phantom can be used with the following tissue simulating liquids:

- *Water-sugar based liquid
- *Glycol based liquids

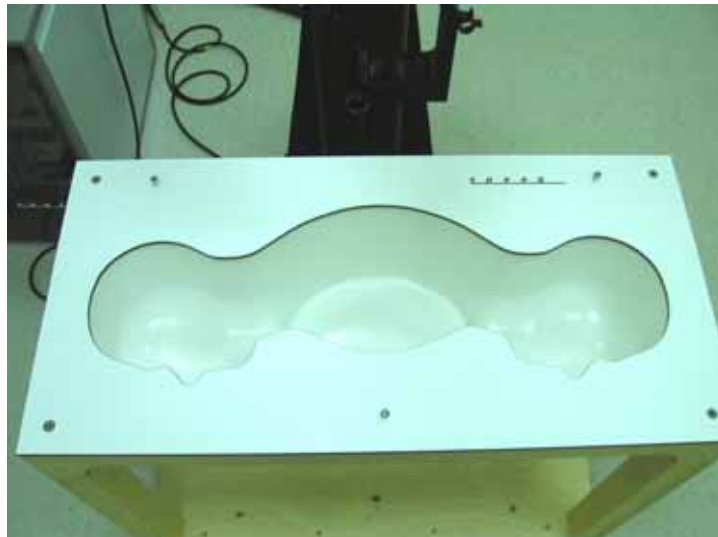

Fig. 5.3 Top view of twin phantom



Fig. 5.4 Bottom view of twin phantom



5.6 Data Storage and Evaluation

5.6.1 Data Storage

The DASY4 software stores the assessed data from the data acquisition electronics as raw data (in microvolt readings from the probe sensors), together with all the necessary software parameters for the data evaluation (probe calibration data, liquid parameters and device frequency and modulation data) in measurement files with the extension .DA4. The postprocessing software evaluates the desired unit and format for output each time the data is visualized or exported. This allows verification of the complete software setup even after the measurement and allows correction of erroneous parameter settings. For example, if a measurement has been performed with an incorrect crest factor parameter in the device setup, the parameter can be corrected afterwards and the data can be reevaluated.

The measured data can be visualized or exported in different units or formats, depending on the selected probe type (e.g., [V/m], [A/m], [mW/g]). Some of these units are not available in certain situations or give meaningless results, e.g., a SAR-output in a loseless media, will always be zero. Raw data can also be exported to perform the evaluation with other software packages.

5.6.2 Data Evaluation

The DASY4 postprocessing software (SEMCAD) automatically executes the following procedures to calculate the field units from the microvolt readings at the probe connector. The parameters used in the evaluation are stored in the configuration modules of the software :

- Probe parameters :**
 - Sensitivity Norm_i, a_{i0}, a_{i1}, a_{i2}
 - Conversion factor ConvF_i
 - Diode compression point dcp_i
- Device parameters :**
 - Frequency f
 - Crest factor cf
- Media parameters :**
 - Conductivity
 - Density

These parameters must be set correctly in the software. They can be found in the component documents or they can be imported into the software from the configuration files issued for the DASY components. In the direct measuring mode of the multimeter option, the parameters of the actual system setup are used. In the scan visualization and export modes, the parameters stored in the corresponding document files are used. The first step of the evaluation is a linearization of the filtered input signal to account for the compression characteristics of the detector diode. The compensation depends on the input signal, the diode type and the DC-transmission factor from the diode to the evaluation electronics. If the exciting field is pulsed, the crest factor of the signal must be known to correctly compensate for peak power. The formula for each channel



can be given as :

$$V_i = U_i + U_i^2 \cdot \frac{cf}{dcp_i}$$

with $V_i =$ compensated signal of channel i ($i = x, y, z$)
 $U_i =$ input signal of channel i ($i = x, y, z$)
 $cf =$ crest factor of exciting field (DASY parameter)
 $dcp_i =$ diode compression point (DASY parameter)

From the compensated input signals, the primary field data for each channel can be evaluated :

E-field probes : $E_i = \sqrt{\frac{V_i}{Norm_i ConvF}}$

H-field probes : $H_i = \sqrt{V_i \frac{a_{i0} + a_{i1}f + a_{i2}f^2}{f}}$

with $V_i =$ compensated signal of channel i ($i = x, y, z$)
 $Norm_i =$ sensor sensitivity of channel i ($i = x, y, z$)
 $\mu V/(V/m)^2$ for E-field Probes
 $ConvF =$ sensitivity enhancement in solution
 $a_{ij} =$ sensor sensitivity factors for H-field probes
 $f =$ carrier frequency [GHz]
 $E_i =$ electric field strength of channel i in V/m
 $H_i =$ magnetic field strength of channel i in A/m

The RSS value of the field components gives the total field strength (Hermitian magnitude) :

$$E_{tot} = \sqrt{E_x^2 + E_y^2 + E_z^2}$$

The primary field data are used to calculate the derived field units.

$$SAR = E_{tot}^2 \cdot \frac{\sigma}{\rho \cdot 1000}$$

with $SAR =$ local specific absorption rate in mW/g
 $E_{tot} =$ total field strength in V/m
 $\sigma =$ conductivity in [mho/m] or [Siemens/m]
 $\rho =$ equivalent tissue density in g/ cm³



* Note that the density is set to 1, to account for actual head tissue density rather than the density of the tissue simulating liquid.

The power flow density is calculated assuming the excitation field to be a free space field.

$$P_{pwe} = \frac{E_{tot}^2}{3770} \quad \text{or} \quad P_{pwe} = H_{tot}^2 \cdot 37.7$$

with P_{pwe} = equivalent power density of a plane wave in mW/cm²
 E_{tot} = total electric field strength in V/m
 H_{tot} = total magnetic field strength in A/m



5.7 Test Equipment List

Manufacture	Name of Equipment	Type/Model	Serial Number	Calibration	
				Last Cal.	Due Date
SPEAG	Dosimetric E-Filed Probe	EX3DV3	3514	Jan. 23, 2004	Jan. 23, 2006
SPEAG	835MHz System Validation Kit	D835V2	499	Feb. 12, 2004	Feb. 12, 2006
SPEAG	900MHz System Validation Kit	D900V2	190	Jul. 19, 2005	Jul. 19, 2007
SPEAG	1800MHz System Validation Kit	D1800V2	2d076	Jul. 20, 2005	Jul. 20, 2007
SPEAG	1900MHz System Validation Kit	D1900V2	5d041	Feb. 17, 2004	Feb. 17, 2006
SPEAG	2450MHz System Validation Kit	D2450V2	712	Feb. 10, 2005	Feb. 10, 2007
SPEAG	5200MHz System Validation Kit	D5GHzV2	1006	Jan. 22, 2004	Jan. 22, 2006
SPEAG	Data Acquisition Electronics	DAE3	577	Nov. 17, 2004	Nov. 17, 2005
SPEAG	Device Holder	N/A	N/A	NCR	NCR
SPEAG	Phantom	QD 000 P40 C	TP-1150	NCR	NCR
SPEAG	Robot	Staubli RX90BL	F03/5W15A1/A/01	NCR	NCR
SPEAG	Software	DASY4 V4.5Build 19	N/A	NCR	NCR
SPEAG	Software	SEMCAD V1.8 Build 146	N/A	NCR	NCR
SPEAG	Measurement Server	SE UMS 001 BA	1021	NCR	NCR
Agilent	S-Parameter Network Analyzer (PNA)	E8358A	US40260131	Nov. 24, 2004	Nov. 24, 2005
Agilent	Dielectric Probe Kit	85070D	US01440205	NCR	NCR
Agilent	Dual Directional Coupler	778D	50422	NCR	NCR
Agilent	Power Amplifier	8449B	3008A01917	NCR	NCR
R & S	Radio Communication Tester	CMU200	105934	Aug. 24, 2004	Aug. 24, 2006
Agilent	Power Meter	E4416A	GB41292344	Jan. 21, 2005	Jan. 21, 2006
Agilent	Signal Generator	E8247C	MY43320596	Feb. 10, 2004	Feb. 10, 2006
Agilent	Base Station Emulator	E5515C	GB43460754	Jan. 12, 2004	Jan. 12, 2006

Table 5.1 Test Equipment List



6. Tissue Simulating Liquids

For the measurement of the field distribution inside the SAM phantom with DASY4, the phantom must be filled with around 25 liters of homogeneous body tissue simulating liquid. The liquid height from the bottom of the phantom body is 15.2 centimeters.

The dielectric parameters of the liquids were verified prior to the SAR evaluation using an Agilent 85070D Dielectric Probe Kit and an Agilent E8358A Network Analyzer.

Table 6.2 shows the measuring results for muscle simulating liquid.

Bands	Frequency(MHz)	Permittivity (ϵ_r)	Conductivity (σ)	Measurement date
5150-5250 MHz <Band 1>	5180	47.6	5.28	Sep. 14, 2005
	5240	47.4	5.34	
5250-5350 MHz <Band 2>	5260	47.4	5.38	Sep. 14, 2005
	5320	47.3	5.47	
5725-5825 MHz <Band 3>	5745	46.9	6.08	Sep. 14, 2005
	5785	46.8	6.14	
	5805	46.7	6.18	

Table 6.2

The measuring data are consistent with $\epsilon_r = 49.0 \pm 5\%$ and $\sigma = 5.30 \pm 5\%$ for band I/band II and $\epsilon_r = 48.2 \pm 5\%$ and $\sigma = 6.0 \pm 5\%$ for band III.



7. Uncertainty Assessment

The component of uncertainty may generally be categorized according to the methods used to evaluate them. The evaluation of uncertainty by the statistical analysis of a series of observations is termed a Type A evaluation of uncertainty. The evaluation of uncertainty by means other than the statistical analysis of a series of observation is termed a Type B evaluation of uncertainty. Each component of uncertainty, however evaluated, is represented by an estimated standard deviation, termed standard uncertainty, which is determined by the positive square root of the estimated variance.

A Type A evaluation of standard uncertainty may be based on any valid statistical method for treating data. This includes calculating the standard deviation of the mean of a series of independent observations; using the method of least squares to fit a curve to the data in order to estimate the parameter of the curve and their standard deviations; or carrying out an analysis of variance in order to identify and quantify random effects in certain kinds of measurement.

A type B evaluation of standard uncertainty is typically based on scientific judgment using all of the relevant information available. These may include previous measurement data, experience and knowledge of the behavior and properties of relevant materials and instruments, manufacture’s specification, data provided in calibration reports and uncertainties assigned to reference data taken from handbooks. Broadly speaking, the uncertainty is either obtained from an outdoor source or obtained from an assumed distribution, such as the normal distribution, rectangular or triangular distributions indicated in Table 7.1

Uncertainty Distributions	Normal	Rectangular	Triangular	U-shape
Multiplying factor ^(a)	1/k (b)	1/ 3	1/ 6	1/ 2

(a) standard uncertainty is determined as the product of the multiplying factor and the estimated range of variations in the measured quantity
(b) is the coverage factor

Table 7.1

The combined standard uncertainty of the measurement result represents the estimated standard deviation of the result. It is obtained by combining the individual standard uncertainties of both Type A and Type B evaluation using the usual “root-sum-squares” (RSS) methods of combining standard deviations by taking the positive square root of the estimated variances.

Expanded uncertainty is a measure of uncertainty that defines an interval about the measurement result within which the measured value is confidently believed to lie. It is obtained by multiplying the combined standard uncertainty by a coverage factor. Typically, the coverage factor ranges from 2 to 3. Using a coverage factor allows the true value of a measured quantity to be specified with a defined probability within the specified uncertainty range. For purpose of this document, a coverage factor two is used, which corresponds to confidence interval of about 95 %. The DASY4 uncertainty Budget is showed in Table 7.2.



Error Description	Uncertainty Value \pm %	Probability Distribution	Divisor	C_i I_g	Standard Unc. (1-g)	v_i or V_{eff}
Measurement System						
Probe Calibration	± 6.8	Normal	1	1	± 6.8 %	
Axial Isotropy	± 4.7	Rectangular	$\sqrt{3}$	0.7	± 1.9 %	
Hemispherical Isotropy	± 9.6	Rectangular	$\sqrt{3}$	0.7	± 3.9 %	
Boundary Effect	± 2.0	Rectangular	$\sqrt{3}$	1	± 1.2 %	
Linearity	± 4.7	Rectangular	$\sqrt{3}$	1	± 2.7 %	
System Detection Limit	± 1.0	Rectangular	$\sqrt{3}$	1	± 0.6 %	
Readout Electronics	± 0.3	Normal	1	1	± 0.3 %	
Response Time	± 0.8	Rectangular	$\sqrt{3}$	1	± 0.5 %	
Integration Time	± 2.6	Rectangular	$\sqrt{3}$	1	± 1.5 %	
RF Ambient Conditions	± 3.0	Rectangular	$\sqrt{3}$	1	± 1.7 %	
Probe Positioner	± 0.8	Rectangular	$\sqrt{3}$	1	± 0.5 %	
Probe Positioning	± 5.7	Normal	1	1	± 5.7 %	
Max. SAR Eval.	± 4.0	Rectangular	$\sqrt{3}$	1	± 2.3 %	
Test Sample Related						
Device Positioning	± 2.9	Normal	1	1	± 2.9 %	145
Device Holder	± 3.6	Normal	1	1	± 3.6 %	5
Power Drift	± 5.0	Rectangular	$\sqrt{3}$	1	± 2.9 %	
Phantom and Setup						
Phantom Uncertainty	± 4.0	Rectangular	$\sqrt{3}$	1	± 2.3 %	
Liquid Conductivity (target)	± 5.0	Rectangular	$\sqrt{3}$	0.64	± 1.8 %	
Liquid Conductivity (meas.)	± 2.5	Normal	1	0.64	± 1.6 %	
Liquid Permittivity (target)	± 5.0	Rectangular	$\sqrt{3}$	0.6	± 1.7 %	
Liquid Permittivity (meas.)	± 2.5	Normal	1	0.6	± 1.5 %	
Combined Std. Uncertainty					± 12.8 %	330
Expanded STD Uncertainty					± 25.6 %	

Table 7.2. Uncertainty Budget of DASY4

8. SAR Measurement Evaluation

Each DASY system is equipped with one or more system validation kits. These units, together with the predefined measurement procedures within the DASY software, enable the user to conduct the system performance check and system validation. System validation kit includes a dipole, tripod holder to fix it underneath the flat phantom and a corresponding distance holder.

8.1 Purpose of System Performance check

The system performance check verifies that the system operates within its specifications. System and operator errors can be detected and corrected. It is recommended that the system performance check be performed prior to any usage of the system in order to guarantee reproducible results. The system performance check uses normal SAR measurements in a simplified setup with a well characterized source. This setup was selected to give a high sensitivity to all parameters that might fail or vary over time. The system check does not intend to replace the calibration of the components, but indicates situations where the system uncertainty is exceeded due to drift or failure.

8.2 System Setup

In the simplified setup for system evaluation, the DUT is replaced by a calibrated dipole and the power source is replaced by a continuous wave which comes from a signal generator at frequency 5200 MHz and 5800 MHz. The calibrated dipole must be placed beneath the flat phantom section of the SAM twin phantom with the correct distance holder. The distance holder should touch the phantom surface with a light pressure at the reference marking and be oriented parallel to the long side of the phantom. The equipment setup is shown below:

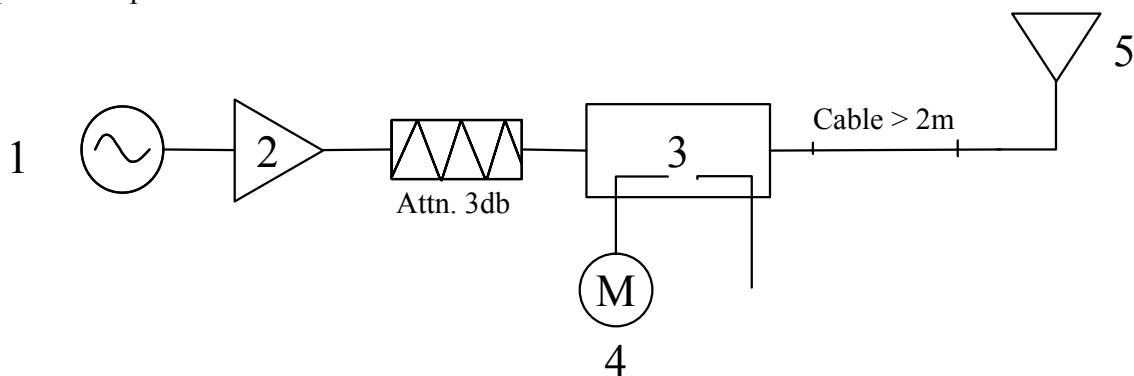

Fig. 8.1



1. Signal Generator
2. Amplifier
3. Directional Coupler
4. Power Meter
5. 5200 MHz and 5800 MHz Dipole

The output power on dipole port must be calibrated to 85~87 mW before dipole is connected.



Fig 8.2 Dipole Setup



8.3 Validation Results

Comparing to the original SAR value provided by Speag, the validation data should within its specification of 10 %. Table 8.1 shows the target SAR and measured SAR after normalized to 1W input power.

Band		Target (W/kg)	Measurement data (W/kg)	Variation	Measurement date
ISM band (5200 MHz)	SAR (1g)	78	85.2	9.2 %	Sep. 14, 2005
	SAR (10g)	22	23.9	8.6 %	
ISM band (5800 MHz)	SAR (1g)	76.6	81.6	6.6 %	Sep. 14, 2005
	SAR (10g)	21.1	22.5	6.5 %	

Table 8.1

The table above indicates the system performance check can meet the variation criterion.

9. Description for DUT Testing Position

This DUT was tested in 5 different positions. This first one is “Keypad Up with Touch” for rotating type shown in Fig. 9.1, and the second one is “Keypad Down with Touch” for rotating type shown in Fig. 9.2, and the third one is “Right Side” for Gun Type shown in Fig. 9.3, and the four one is “Left Side” for Gun Type shown in Fig. 9.4, and the five one is “Holster” for rotating type shown in Fig. 9.5.



Fig. 9.1 Keypad Up with Touch

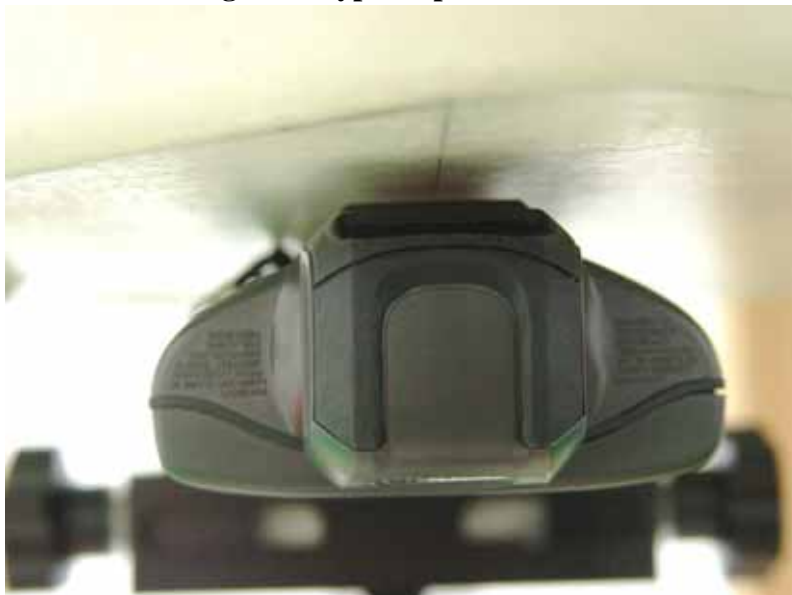

Fig. 9.2 Keypad Down with Touch



Fig. 9.3 Right Side for Gun Type



Fig. 9.4 Left Side for Gun Type



Fig. 9.5 Holster



10. Measurement Procedures

The measurement procedures are as follows:

- Plugging DUT into the notebook
- Using engineering software to transmit RF power continuously (continuous Tx) in the low channel
- Placing the DUT in the positions described in the last section
- Setting scan area, grid size and other setting on the DASY4 software
- Taking data for the low channel
- Repeat the previous steps for the middle and high channels.

According to the IEEE P1528 draft standard, the recommended procedure for assessing the peak spatial-average SAR value consists of the following steps:

- Power reference measurement
- Area scan
- Zoom scan
- Power reference measurement

10.1 Spatial Peak SAR Evaluation

The procedure for spatial peak SAR evaluation has been implemented according to the IEEE1528-2003 standard. It can be conducted for 1g and 10g, as well as for user-specific masses. The DASY4 software includes all numerical procedures necessary to evaluate the spatial peak SAR value.

Base on the Draft: SCC-34, SC-2, WG-2-Computational Dosimetry, P1528/D1.2 (Recommended Practice for Determining the Peak Spatial-Average Specific Absorption Rate (SAR) in the Human Head from Wireless Communications Devices: Measurement Techniques), a new algorithm has been implemented. The spatial-peak SAR can be computed over any required mass.

The base for the evaluation is a "cube" measurement. The measured volume must include the 1g and 10g cubes with the highest averaged SAR values. For that purpose , the center of the measured volume is aligned to the interpolated peak SAR value of a previously performed area scan.



The entire evaluation of the spatial peak values is performed within the postprocessing engine (SEMCAD). The system always gives the maximum values for the 1g and 10g cubes. The algorithm to find the cube with highest averaged SAR is divided into the following stages:

- extraction of the measured data (grid and values) from the Zoom Scan
- calculation of the SAR value at every measurement point based on all stored data (A/D values and measurement parameters)
- generation of a high-resolution mesh within the measured volume
- interpolation of all measured values from the measurement grid to the high-resolution grid
- extrapolation of the entire 3-D field distribution to the phantom surface over the distance from sensor to surface
- calculation of the averaged SAR within masses of 1g and 10g

10.2 Scan Procedures

First **Area Scan** is used to locate the approximate location(s) of the local peak SAR value(s). The measurement grid within an **Area Scan** is defined by the grid extent, grid step size and grid offset. Next, in order to determine the EM field distribution in a three-dimensional spatial extension, **Zoom Scan** is required. The **Zoom Scan** measures 8x8x8 points with step size 4.3, 4.3 and 3 mm. The **Zoom Scan** is performed around the highest E-field value to determine the averaged SAR-distribution over 1 g.

10.3 SAR Averaged Methods

In DAS4, the interpolation and extrapolation are both based on the modified Quadratic Shepard's method. The interpolation scheme combines a least-square fitted function method and a weighted average method which are the two basic types of computational interpolation and approximation.

Extrapolation routines are used to obtain SAR values between the lowest measurement points and the inner phantom surface. The extrapolation distance is determined by the surface detection distance and the probe sensor offset. The uncertainty increases with the extrapolation distance. To keep the uncertainty within 1% for the 1 g and 10 g cubes, the extrapolation distance should not be larger than 5 mm.



11. SAR Test Results

11.1 Keypad Up with Touch

Bands	Chan.	Freq (MHz)	Modulation Type	Conducted Power (dBm)	Power Drift (dB)	Measured 1g SAR (W/kg)	Limit (W/kg)	Results
Band 1 (5200 MHz)	36	5180 (Low)	OFDM	16.64	-	-	-	-
	48	5240 (High)	OFDM	17.7	-	-	-	-
Band 2 (5300 MHz)	52	5260 (Low)	OFDM	18.76	-	-	-	-
	64	5320 (High)	OFDM	18.57	-0.14	0.165	1.6	Pass
Band 3 (5800 MHz)	149	5745 (Low)	OFDM	18.35	-	-	-	-
	157	5785 (Mid)	OFDM	18.24	-	-	-	-
	161	5805 (High)	OFDM	18.65	-	-	-	-

11.2 Keypad Down with Touch

Bands	Chan.	Freq (MHz)	Modulation Type	Conducted Power (dBm)	Power Drift (dB)	Measured 1g SAR (W/kg)	Limit (W/kg)	Results
Band 1 (5200 MHz)	36	5180 (Low)	OFDM	16.64	-	-	-	-
	48	5240 (High)	OFDM	17.7	-	-	-	-
Band 2 (5300 MHz)	52	5260 (Low)	OFDM	18.76	-	-	-	-
	64	5320 (High)	OFDM	18.57	0.173	0.461	1.6	Pass
Band 3 (5800 MHz)	149	5745 (Low)	OFDM	18.35	-	-	-	-
	157	5785 (Mid)	OFDM	18.24	-	-	-	-
	161	5805 (High)	OFDM	18.65	-	-	-	-

11.3 Right Side

Bands	Chan.	Freq (MHz)	Modulation Type	Conducted Power (dBm)	Power Drift (dB)	Measured 1g SAR (W/kg)	Limit (W/kg)	Results
Band 1 (5200 MHz)	36	5180 (Low)	OFDM	16.64	-	-	-	-
	48	5240 (High)	OFDM	17.7	-	-	-	-
Band 2 (5300 MHz)	52	5260 (Low)	OFDM	18.76	-	-	-	-
	64	5320 (High)	OFDM	18.57	-0.147	0.524	1.6	Pass
Band 3 (5800 MHz)	149	5745 (Low)	OFDM	18.35	-	-	-	-
	157	5785 (Mid)	OFDM	18.24	-	-	-	-
	161	5805 (High)	OFDM	18.65	-	-	-	-



11.4 Left Side

Bands	Chan.	Freq (MHz)	Modulation Type	Conducted Power (dBm)	Power Drift (dB)	Measured 1g SAR (W/kg)	Limit (W/kg)	Results
Band 1 (5200 MHz)	36	5180 (Low)	OFDM	16.64	0.157	0.258	1.6	Pass
	48	5240 (High)	OFDM	17.7	0.1	0.109	1.6	Pass
Band 2 (5300 MHz)	52	5260 (Low)	OFDM	18.76	-0.153	0.363	1.6	Pass
	64	5320 (High)	OFDM	18.57	-0.122	0.637	1.6	Pass
Band 3 (5800 MHz)	149	5745 (Low)	OFDM	18.35	-0.115	0.397	1.6	Pass
	157	5785 (Mid)	OFDM	18.24	0.151	0.039	1.6	Pass
	161	5805 (High)	OFDM	18.65	-0.01	0.176	1.6	Pass

11.5 Holster

The SAR value is too low to be taken.

Remark :

The worst position is based on 802.11a Band 2 (5300 MHz) channel 64. The full testings were focused on worst position.



12. References

- [1] FCC 47 CFR Part 2 “Frequency Allocations and Radio Treaty Matters; General Rules and Regulations”
- [2] IEEE Std. P1528-2003, “Recommended Practice for Determining the Peak Spatial-Average Specific Absorption Rate (SAR) in the Human Head from Wireless Communications Devices: Measurement Techniques”, April 21,2003.
- [3] Supplement C (Edition 01-01) to OET Bulletin 65 (Edition 97-01), “Additional Information for Evaluating Compliance of Mobile and Portable Devices with FCC Limits for Human Exposure to RF Emissions”, June 2001
- [4] IEEE Std. C95.3-2002, “IEEE Recommended Practice for the Measurement of Potentially Hazardous Electromagnetic Fields-RF and Microwave”, 2002
- [5] IEEE Std. C95.1-1999, “IEEE Standard for Safety Levels with Respect to Human Exposure to Radio Frequency Electromagnetic Fields, 3 kHz to 300 GHz”, 1999
- [6] Robert J. Renka, “Multivariate Interpolation Of Large Sets Of Scattered Data”, University of North Texas ACM Transactions on Mathematical Software, vol. 14, no. 2, June 1988, pp. 139-148
- [7] DAYS4 System Handbook



Appendix A - System Performance Check Data

Test Laboratory: Sporton International Inc. SAR Testing Lab

Date/Time: 9/14/2005 9:39:15 AM

System Check_Body_5200MHz_20050914

DUT: Dipole 5GHz; Type: D5GHzV2; Serial: D5GHzV2 - SN:1006

Communication System: 802.11a; Frequency: 5200 MHz; Duty Cycle: 1:1

Medium: MSL_5200 Medium parameters used: $f = 5200$ MHz; $\sigma = 5.3$ mho/m; $\epsilon_r = 47.5$; $\rho = 1000$ kg/m³

Ambient Temperature : 22.6 °C; Liquid Temperature : 22.2 °C

DASY4 Configuration:

- Probe: EX3DV3 - SN3514; ConvF(4.14, 4.14, 4.14); Calibrated: 1/23/2004

- Sensor-Surface: 2mm (Mechanical Surface Detection)

- Electronics: DAE3 Sn577; Calibrated: 11/17/2004

- Phantom: SAM 12; Type: QD 000 P40 C; Serial: TP-1150

- Measurement SW: DASY4, V4.5 Build 19; Postprocessing SW: SEMCAD, V1.8 Build 146

Pin=87.09636mW/Area Scan (91x91x1): Measurement grid: dx=10mm, dy=10mm

Maximum value of SAR (interpolated) = 15.5 mW/g

Pin=87.09636mW/Zoom Scan (8x8x8)/Cube 0: Measurement grid: dx=4.3mm, dy=4.3mm, dz=3mm

Reference Value = 58.6 V/m; Power Drift = -0.144 dB

Peak SAR (extrapolated) = 28.8 W/kg

SAR(1 g) = 7.42 mW/g; SAR(10 g) = 2.08 mW/g

Maximum value of SAR (measured) = 14.5 mW/g

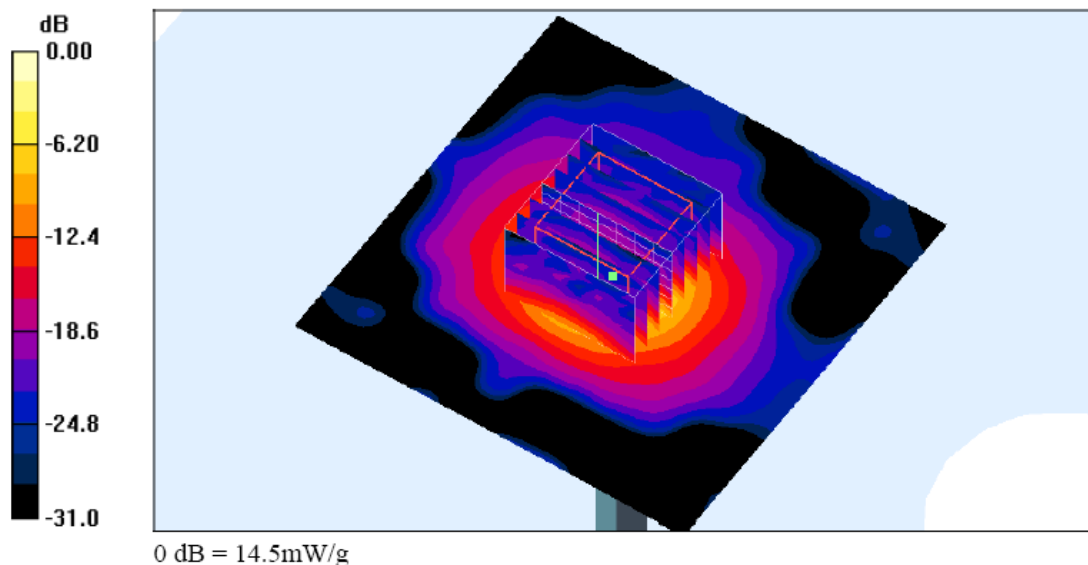



Test Laboratory: Sporton International Inc. SAR Testing Lab

Date/Time: 9/14/2005 10:13:12 AM

System Check_Body_5800MHz_20050914

DUT: Dipole 5GHz; Type: D5GHzV2; Serial: D5GHzV2 - SN:1006

Communication System: 802.11a; Frequency: 5800 MHz;Duty Cycle: 1:1

Medium: MSL_5800 Medium parameters used: $f = 5800$ MHz; $\sigma = 6.16$ mho/m; $\epsilon_r = 46.7$; $\rho = 1000$ kg/m³

Ambient Temperature : 22.5 °C; Liquid Temperature : 22.3 °C

DASY4 Configuration:

- Probe: EX3DV3 - SN3514; ConvF(3.85, 3.85, 3.85); Calibrated: 1/23/2004
- Sensor-Surface: 2mm (Mechanical Surface Detection)
- Electronics: DAE3 Sn577; Calibrated: 11/17/2004
- Phantom: SAM 12; Type: QD 000 P40 C; Serial: TP-1150
- Measurement SW: DASY4, V4.5 Build 19; Postprocessing SW: SEMCAD, V1.8 Build 146

Pin=85mW/Area Scan (91x91x1): Measurement grid: dx=10mm, dy=10mm

Maximum value of SAR (interpolated) = 14.8 mW/g

Pin=85mW/Zoom Scan (8x8x8)/Cube 0: Measurement grid: dx=4.3mm, dy=4.3mm, dz=3mm

Reference Value = 52.2 V/m; Power Drift = -0.099 dB

Peak SAR (extrapolated) = 30.6 W/kg

SAR(1 g) = 6.94 mW/g; SAR(10 g) = 1.91 mW/g

Maximum value of SAR (measured) = 14.1 mW/g

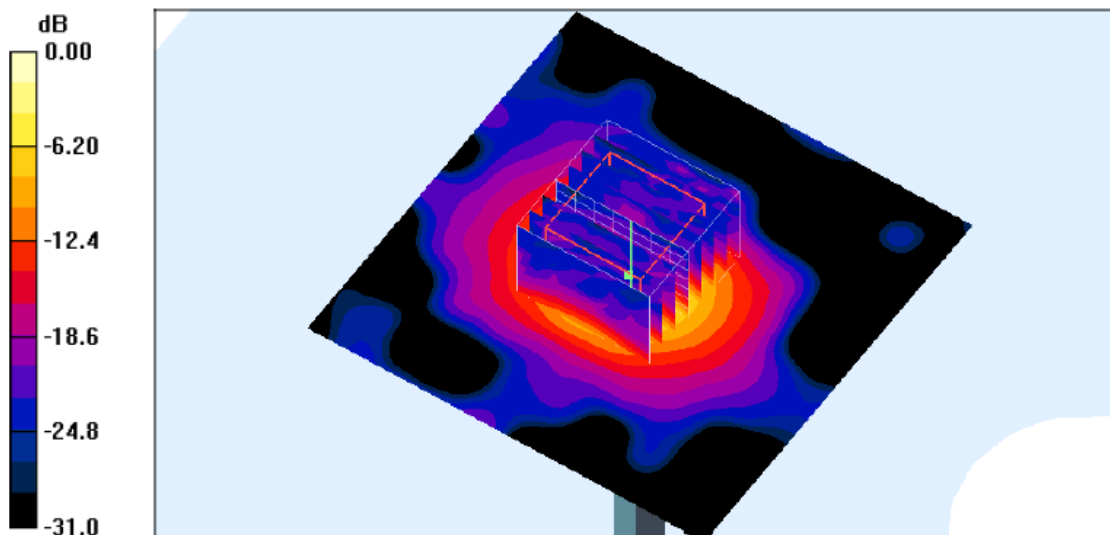



Appendix B - SAR Measurement Data

Test Laboratory: Sporton International Inc. SAR Testing Lab

Date/Time: 9/14/2005 12:01:37 PM

Body_802.11a Ch64_Keypad UP With Touch_20050914

DUT: 591501; Type: Mobile Computer; Serial: Rotating

Communication System: 802.11a; Frequency: 5320 MHz; Duty Cycle: 1:1

Medium: MSL_5200 Medium parameters used: $f = 5320$ MHz; $\sigma = 5.47$ mho/m; $\epsilon_r = 47.3$; $\rho = 1000$ kg/m³

Ambient Temperature : 22.4 °C; Liquid Temperature : 22.1 °C

DASY4 Configuration:

- Probe: EX3DV3 - SN3514; ConvF(4.14, 4.14, 4.14); Calibrated: 1/23/2004
- Sensor-Surface: 2.5mm (Mechanical Surface Detection)
- Electronics: DAE3 Sn577; Calibrated: 11/17/2004
- Phantom: SAM 12; Type: QD 000 P40 C; Serial: TP-1150
- Measurement SW: DASY4, V4.5 Build 19; Postprocessing SW: SEMCAD, V1.8 Build 146

Ch64/Area Scan (71x101x1): Measurement grid: dx=10mm, dy=10mm

Maximum value of SAR (interpolated) = 0.468 mW/g

Ch64/Zoom Scan (8x8x8)/Cube 0: Measurement grid: dx=4.3mm, dy=4.3mm, dz=3mm

Reference Value = 3.54 V/m; Power Drift = -0.14 dB

Peak SAR (extrapolated) = 0.899 W/kg

SAR(1 g) = 0.165 mW/g; SAR(10 g) = 0.045 mW/g

Maximum value of SAR (measured) = 0.390 mW/g

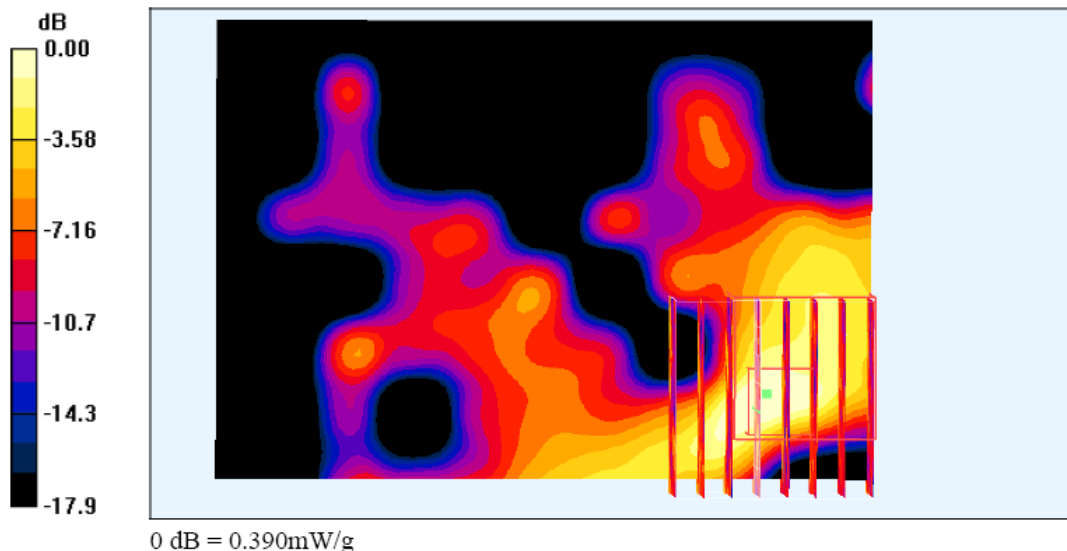



Test Laboratory: Sporton International Inc. SAR Testing Lab

Date/Time: 9/14/2005 1:11:30 PM

Body_802.11a Ch64_Keypad Down With Touch_20050914

DUT: 591501; Type: Mobile Computer; Serial: Rotating

Communication System: 802.11a; Frequency: 5320 MHz; Duty Cycle: 1:1

Medium: MSL_5200 Medium parameters used: $f = 5320$ MHz; $\sigma = 5.47$ mho/m; $\epsilon_r = 47.3$; $\rho = 1000$ kg/m³

Ambient Temperature : 22.5 °C ; Liquid Temperature : 22.1 °C

DASY4 Configuration:

- Probe: EX3DV3 - SN3514; ConvF(4.14, 4.14, 4.14); Calibrated: 1/23/2004
- Sensor-Surface: 2.5mm (Mechanical Surface Detection)
- Electronics: DAE3 Sn577; Calibrated: 11/17/2004
- Phantom: SAM 12; Type: QD 000 P40 C; Serial: TP-1150
- Measurement SW: DASY4, V4.5 Build 19; Postprocessing SW: SEMCAD, V1.8 Build 146

Ch64/Area Scan (71x101x1): Measurement grid: dx=10mm, dy=10mm

Maximum value of SAR (interpolated) = 0.836 mW/g

Ch64/Zoom Scan (8x8x8)/Cube 0: Measurement grid: dx=4.3mm, dy=4.3mm, dz=3mm

Reference Value = 4.34 V/m; Power Drift = 0.173 dB

Peak SAR (extrapolated) = 1.33 W/kg

SAR(1 g) = 0.461 mW/g; SAR(10 g) = 0.182 mW/g

Maximum value of SAR (measured) = 0.766 mW/g

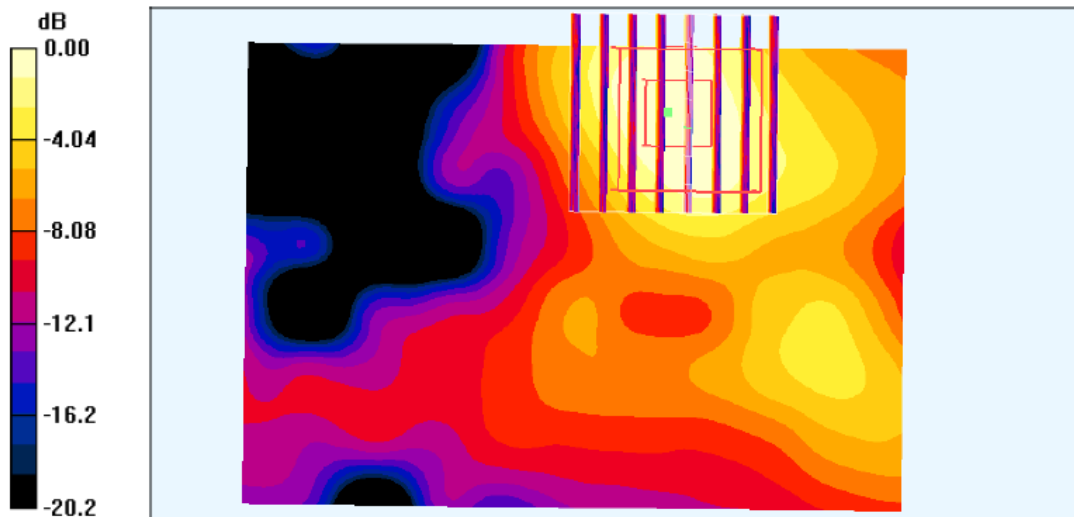



Test Laboratory: Sporton International Inc. SAR Testing Lab

Date/Time: 9/14/2005 11:27:49 AM

Body_802.11a Ch64_Right Touch_20050914_Holster

DUT: 591501; Type: Mobile Computer; Serial: GUN

Communication System: 802.11a; Frequency: 5320 MHz; Duty Cycle: 1:1

Medium: MSL_5200 Medium parameters used: $f = 5320$ MHz; $\sigma = 5.47$ mho/m; $\epsilon_r = 47.3$; $\rho = 1000$ kg/m³

Ambient Temperature : 22.6 °C; Liquid Temperature : 22.3 °C

DASY4 Configuration:

- Probe: EX3DV3 - SN3514; ConvF(4.14, 4.14, 4.14); Calibrated: 1/23/2004
- Sensor-Surface: 2.5mm (Mechanical Surface Detection)
- Electronics: DAE3 Sn577; Calibrated: 11/17/2004
- Phantom: SAM 12; Type: QD 000 P40 C; Serial: TP-1150
- Measurement SW: DASY4, V4.5 Build 19; Postprocessing SW: SEMCAD, V1.8 Build 146

Ch64/Area Scan (71x101x1): Measurement grid: dx=10mm, dy=10mm

Maximum value of SAR (interpolated) = 0.907 mW/g

Ch64/Zoom Scan (8x8x8)/Cube 0: Measurement grid: dx=4.3mm, dy=4.3mm, dz=3mm

Reference Value = 8.50 V/m; Power Drift = -0.147 dB

Peak SAR (extrapolated) = 1.51 W/kg

SAR(1 g) = 0.524 mW/g; SAR(10 g) = 0.215 mW/g

Maximum value of SAR (measured) = 0.886 mW/g

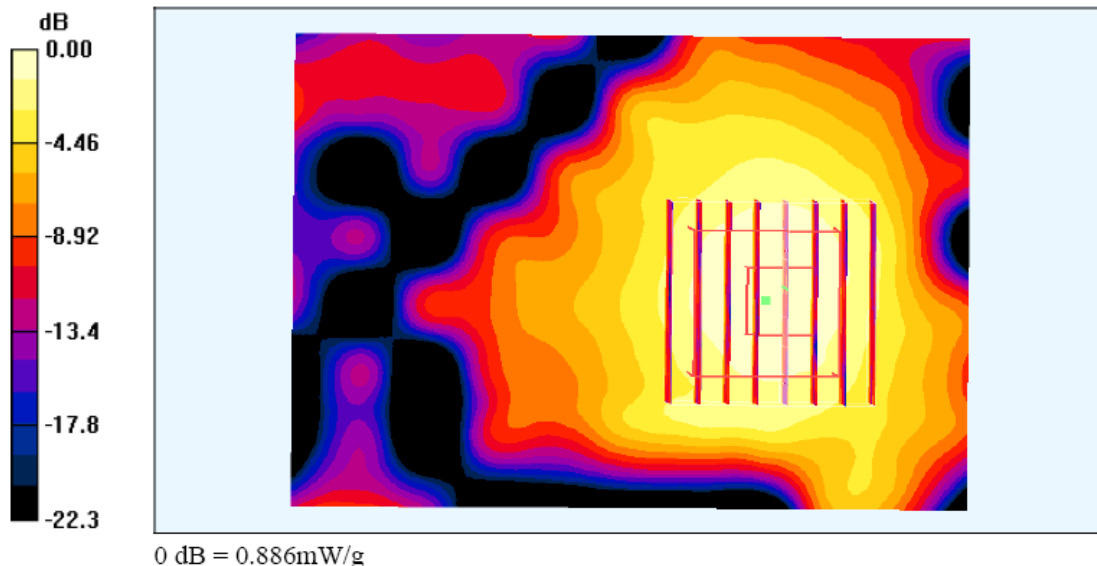



Test Laboratory: Sporton International Inc. SAR Testing Lab

Date/Time: 9/14/2005 1:52:22 PM

Body_802.11a_Ch36_Left Touch_20050914_Holster

DUT: 591501; Type: Mobile Computer; Serial: GUN

Communication System: 802.11a; Frequency: 5180 MHz; Duty Cycle: 1:1

Medium: MSL_5200 Medium parameters used: $f = 5180$ MHz; $\sigma = 5.28$ mho/m; $\epsilon_r = 47.6$; $\rho = 1000$ kg/m³

Ambient Temperature : 21.6 °C; Liquid Temperature : 21.4 °C

DASY4 Configuration:

- Probe: EX3DV3 - SN3514; ConvF(4.14, 4.14, 4.14); Calibrated: 1/23/2004
- Sensor-Surface: 2.5mm (Mechanical Surface Detection)
- Electronics: DAE3 Sn577; Calibrated: 11/17/2004
- Phantom: SAM 12; Type: QD 000 P40 C; Serial: TP-1150
- Measurement SW: DASY4, V4.5 Build 19; Postprocessing SW: SEMCAD, V1.8 Build 146

Ch36/Area Scan (71x101x1): Measurement grid: dx=10mm, dy=10mm

Maximum value of SAR (interpolated) = 0.382 mW/g

Ch36/Zoom Scan (8x8x8)/Cube 0: Measurement grid: dx=4.3mm, dy=4.3mm, dz=3mm

Reference Value = 4.23 V/m; Power Drift = 0.157 dB

Peak SAR (extrapolated) = 1.79 W/kg

SAR(1 g) = 0.258 mW/g; SAR(10 g) = 0.108 mW/g

Maximum value of SAR (measured) = 0.443 mW/g

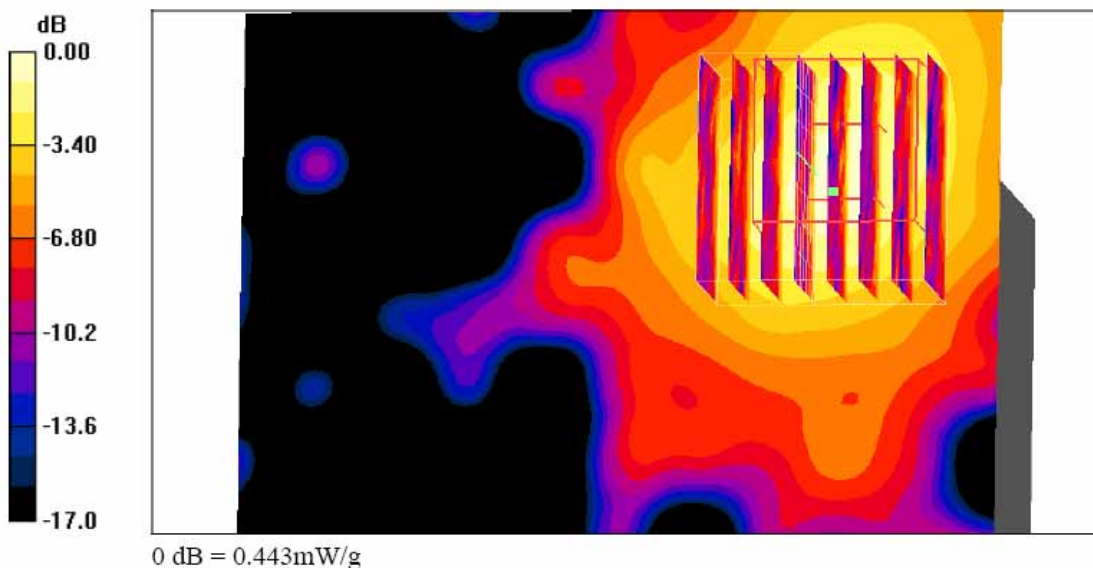



Test Laboratory: Sporton International Inc. SAR Testing Lab

Date/Time: 9/14/2005 3:28:33 PM

Body_802.11a Ch52_Left Touch_20050914_Holster

DUT: 591501; Type: Mobile Computer; Serial: GUN

Communication System: 802.11a; Frequency: 5260 MHz; Duty Cycle: 1:1

Medium: MSL_5200 Medium parameters used: $f = 5260$ MHz; $\sigma = 5.38$ mho/m; $\epsilon_r = 47.4$; $\rho = 1000$ kg/m³

Ambient Temperature : 22.3 °C; Liquid Temperature : 22.0 °C

DASY4 Configuration:

- Probe: EX3DV3 - SN3514; ConvF(4.14, 4.14, 4.14); Calibrated: 1/23/2004
- Sensor-Surface: 2.5mm (Mechanical Surface Detection)
- Electronics: DAE3 Sn577; Calibrated: 11/17/2004
- Phantom: SAM 12; Type: QD 000 P40 C; Serial: TP-1150
- Measurement SW: DASY4, V4.5 Build 19; Postprocessing SW: SEMCAD, V1.8 Build 146

Ch52/Area Scan (71x101x1): Measurement grid: dx=10mm, dy=10mm

Maximum value of SAR (interpolated) = 0.560 mW/g

Ch52/Zoom Scan (8x8x8)/Cube 0: Measurement grid: dx=4.3mm, dy=4.3mm, dz=3mm

Reference Value = 4.89 V/m; Power Drift = -0.153 dB

Peak SAR (extrapolated) = 2.66 W/kg

SAR(1 g) = 0.363 mW/g; SAR(10 g) = 0.146 mW/g

Maximum value of SAR (measured) = 0.533 mW/g

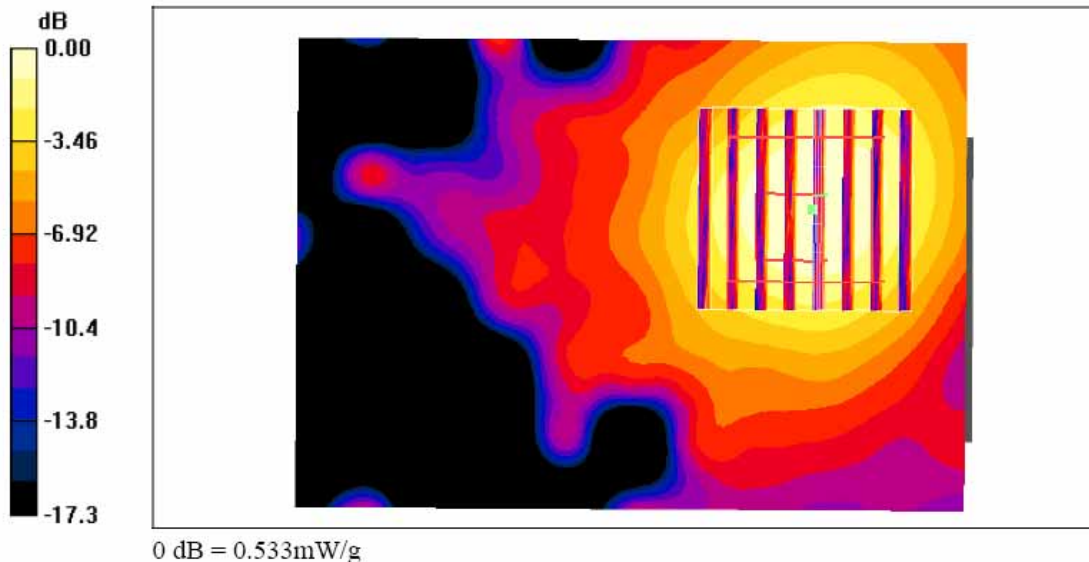



Test Laboratory: Sporton International Inc. SAR Testing Lab

Date/Time: 9/14/2005 10:57:10 AM

Body_802.11a Ch64_Left Touch_20050914_Holster

DUT: 591501; Type: Mobile Computer; Serial: GUN

Communication System: 802.11a; Frequency: 5320 MHz; Duty Cycle: 1:1

Medium: MSL_5200 Medium parameters used: $f = 5320$ MHz; $\sigma = 5.47$ mho/m; $\epsilon_r = 47.3$; $\rho = 1000$ kg/m³

Ambient Temperature : 22.2 °C ; Liquid Temperature : 22.0 °C

DASY4 Configuration:

- Probe: EX3DV3 - SN3514; ConvF(4.14, 4.14, 4.14); Calibrated: 1/23/2004
- Sensor-Surface: 2.5mm (Mechanical Surface Detection)
- Electronics: DAE3 Sn577; Calibrated: 11/17/2004
- Phantom: SAM 12; Type: QD 000 P40 C; Serial: TP-1150
- Measurement SW: DASY4, V4.5 Build 19; Postprocessing SW: SEMCAD, V1.8 Build 146

Ch64/Area Scan (71x101x1): Measurement grid: dx=10mm, dy=10mm

Maximum value of SAR (interpolated) = 1.12 mW/g

Ch64/Zoom Scan (8x8x8)/Cube 0: Measurement grid: dx=4.3mm, dy=4.3mm, dz=3mm

Reference Value = 10.6 V/m; Power Drift = -0.122 dB

Peak SAR (extrapolated) = 2.22 W/kg

SAR(1 g) = 0.637 mW/g; SAR(10 g) = 0.243 mW/g

Maximum value of SAR (measured) = 0.995 mW/g

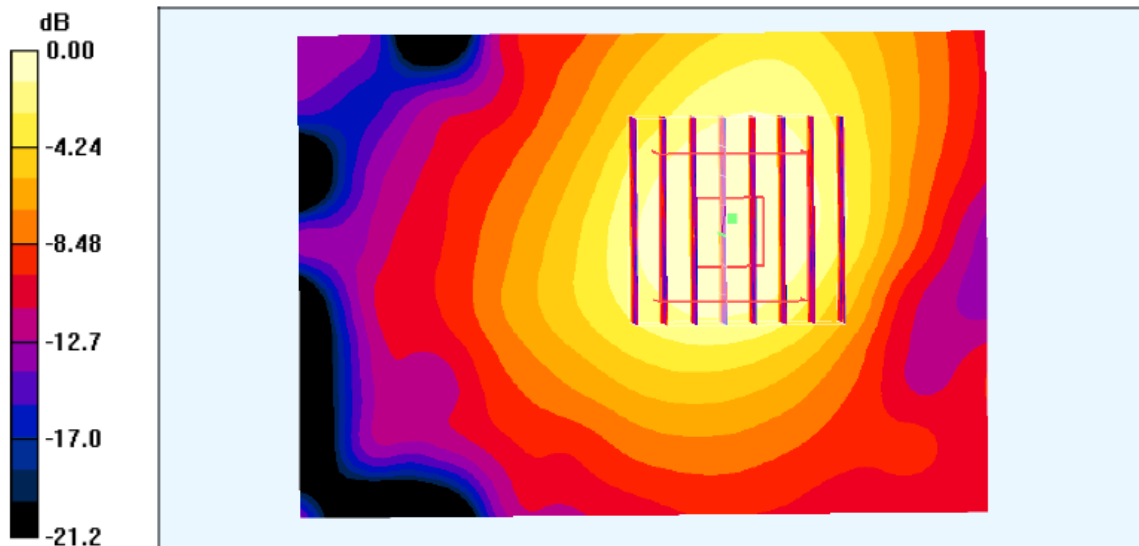

0 dB = 0.995mW/g



Test Laboratory: Sporton International Inc. SAR Testing Lab

Date/Time: 9/14/2005 4:51:02 PM

Body_802.11a Ch149_Left Touch_20050914_Holster

DUT: 591501; Type: Mobile Computer; Serial: GUN

Communication System: 802.11a; Frequency: 5745 MHz; Duty Cycle: 1:1

Medium: MSL_5800 Medium parameters used: $f = 5745$ MHz; $\sigma = 6.08$ mho/m; $\epsilon_r = 46.9$; $\rho = 1000$ kg/m³

Ambient Temperature : 21.6 °C; Liquid Temperature : 21.3 °C

DASY4 Configuration:

- Probe: EX3DV3 - SN3514; ConvF(3.85, 3.85, 3.85); Calibrated: 1/23/2004
- Sensor-Surface: 2.5mm (Mechanical Surface Detection)
- Electronics: DAE3 Sn577; Calibrated: 11/17/2004
- Phantom: SAM 12; Type: QD 000 P40 C; Serial: TP-1150
- Measurement SW: DASY4, V4.5 Build 19; Postprocessing SW: SEMCAD, V1.8 Build 146

Ch149/Area Scan (71x101x1): Measurement grid: dx=10mm, dy=10mm

Maximum value of SAR (interpolated) = 0.662 mW/g

Ch149/Zoom Scan (8x8x8)/Cube 0: Measurement grid: dx=4.3mm, dy=4.3mm, dz=3mm

Reference Value = 4.71 V/m; Power Drift = -0.115 dB

Peak SAR (extrapolated) = 2.63 W/kg

SAR(1 g) = 0.397 mW/g; SAR(10 g) = 0.156 mW/g

Maximum value of SAR (measured) = 0.636 mW/g

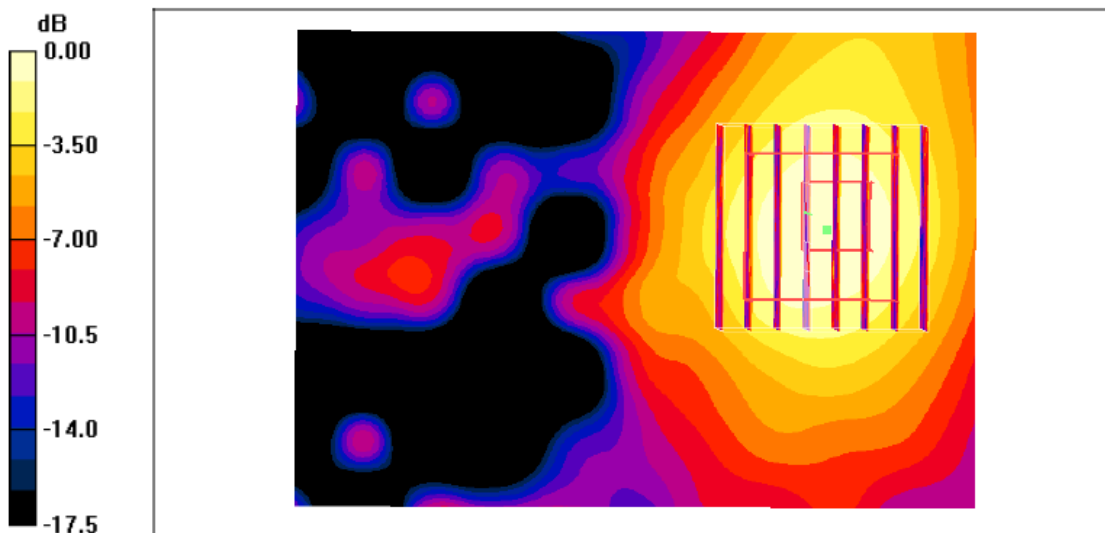



Test Laboratory: Sporton International Inc. SAR Testing Lab

Date/Time: 9/14/2005 2:01:16 PM

Body_802.11a_Ch36_Left Touch_20050914_Holster

DUT: 591501; Type: Mobile Computet; Serial: GUN

Communication System: 802.11a; Frequency: 5180 MHz;Duty Cycle: 1:1

Medium: MSL_5200 Medium parameters used: $f = 5180$ MHz; $\sigma = 5.28$ mho/m; $\epsilon_r = 47.6$; $\rho = 1000$ kg/m³

Ambient Temperature : 21.6 °C ; Liquid Temperature : 21.4 °C

DASY4 Configuration:

- Probe: EX3DV3 - SN3514; ConvF(4.14, 4.14, 4.14); Calibrated: 1/23/2004
- Sensor-Surface: 2.5mm (Mechanical Surface Detection)
- Electronics: DAE3 Sn577; Calibrated: 11/17/2004
- Phantom: SAM 12; Type: QD 000 P40 C; Serial: TP-1150
- Measurement SW: DASY4, V4.5 Build 19; Postprocessing SW: SEMCAD, V1.8 Build 146

Ch36/Zoom Scan (8x8x8)/Cube 0: Measurement grid: dx=4.3mm, dy=4.3mm, dz=3mm

Reference Value = 4.23 V/m; Power Drift = 0.257 dB

Peak SAR (extrapolated) = 1.79 W/kg

SAR(1 g) = 0.258 mW/g; SAR(10 g) = 0.108 mW/g

Maximum value of SAR (measured) = 0.443 mW/g

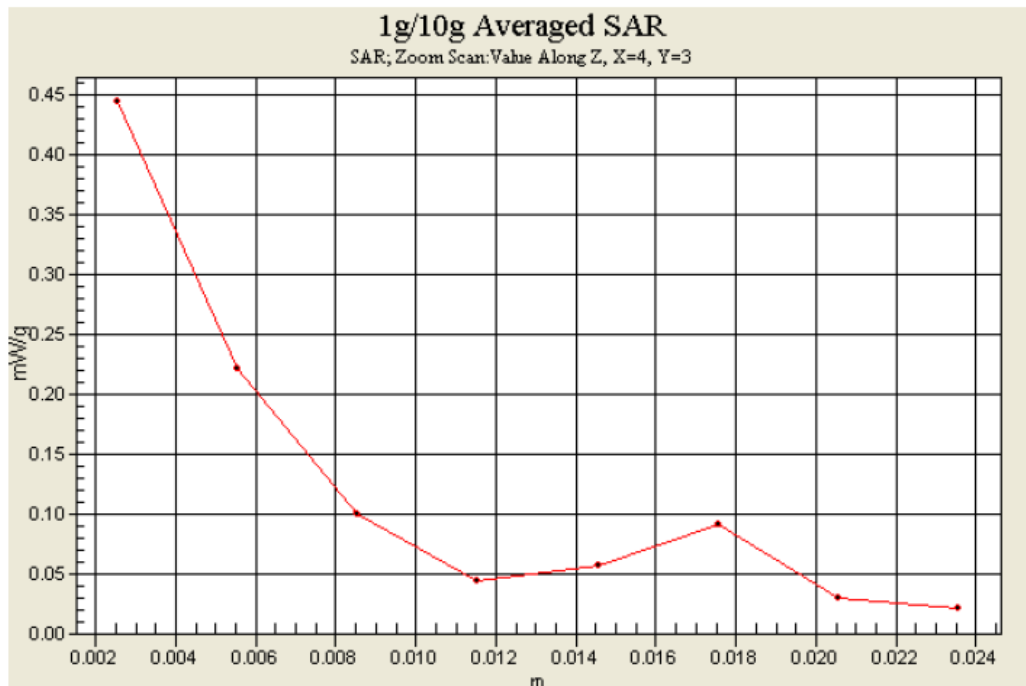



Test Laboratory: Sporton International Inc. SAR Testing Lab

Date/Time: 9/14/2005 10:57:10 AM

Body_802.11a Ch64_Left Touch_20050914_Holster

DUT: 591501; Type: Mobile Computer; Serial: GUN

Communication System: 802.11a; Frequency: 5320 MHz; Duty Cycle: 1:1

Medium: MSL_5200 Medium parameters used: $f = 5320$ MHz; $\sigma = 5.47$ mho/m; $\epsilon_r = 47.3$; $\rho = 1000$ kg/m³

Ambient Temperature : 22.2 °C; Liquid Temperature : 22.0 °C

DASY4 Configuration:

- Probe: EX3DV3 - SN3514; ConvF(4.14, 4.14, 4.14); Calibrated: 1/23/2004
- Sensor-Surface: 2.5mm (Mechanical Surface Detection)
- Electronics: DAE3 Sn577; Calibrated: 11/17/2004
- Phantom: SAM 12; Type: QD 000 P40 C; Serial: TP-1150
- Measurement SW: DASY4, V4.5 Build 19; Postprocessing SW: SEMCAD, V1.8 Build 146

Ch64/Area Scan (71x101x1): Measurement grid: dx=10mm, dy=10mm

Maximum value of SAR (interpolated) = 1.12 mW/g

Ch64/Zoom Scan (8x8x8)/Cube 0: Measurement grid: dx=4.3mm, dy=4.3mm, dz=3mm

Reference Value = 10.6 V/m; Power Drift = -0.122 dB

Peak SAR (extrapolated) = 2.22 W/kg

SAR(1 g) = 0.637 mW/g; SAR(10 g) = 0.243 mW/g

Maximum value of SAR (measured) = 0.995 mW/g

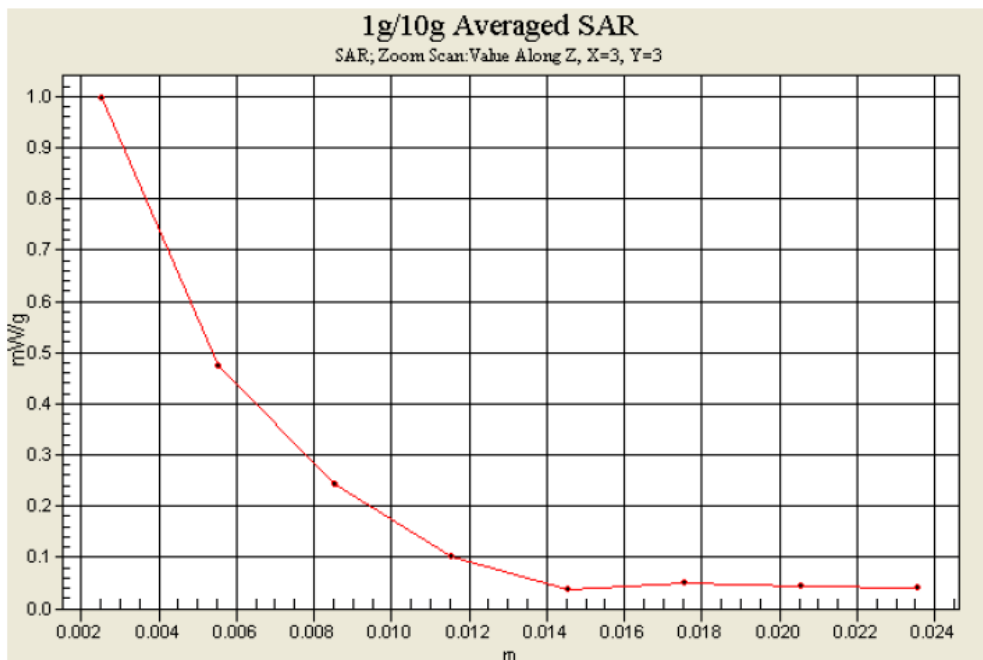



Test Laboratory: Sporton International Inc. SAR Testing Lab

Date/Time: 9/14/2005 4:51:02 PM

Body_802.11a Ch149_Left Touch_20050914_Holster

DUT: 591501; Type: Mobile Computer; Serial: GUN

Communication System: 802.11a; Frequency: 5745 MHz; Duty Cycle: 1:1

Medium: MSL_5800 Medium parameters used: $f = 5745$ MHz; $\sigma = 6.08$ mho/m; $\epsilon_r = 46.9$; $\rho = 1000$ kg/m³

Ambient Temperature : 21.6 °C ; Liquid Temperature : 21.3 °C

DASY4 Configuration:

- Probe: EX3DV3 - SN3514; ConvF(3.85, 3.85, 3.85); Calibrated: 1/23/2004
- Sensor-Surface: 2.5mm (Mechanical Surface Detection)
- Electronics: DAE3 Sn577; Calibrated: 11/17/2004
- Phantom: SAM 12; Type: QD 000 P40 C; Serial: TP-1150
- Measurement SW: DASY4, V4.5 Build 19; Postprocessing SW: SEMCAD, V1.8 Build 146

Ch149/Area Scan (71x101x1): Measurement grid: dx=10mm, dy=10mm

Maximum value of SAR (interpolated) = 0.662 mW/g

Ch149/Zoom Scan (8x8x8)/Cube 0: Measurement grid: dx=4.3mm, dy=4.3mm, dz=3mm

Reference Value = 4.71 V/m; Power Drift = -0.115 dB

Peak SAR (extrapolated) = 2.63 W/kg

SAR(1 g) = 0.397 mW/g; SAR(10 g) = 0.156 mW/g

Maximum value of SAR (measured) = 0.636 mW/g

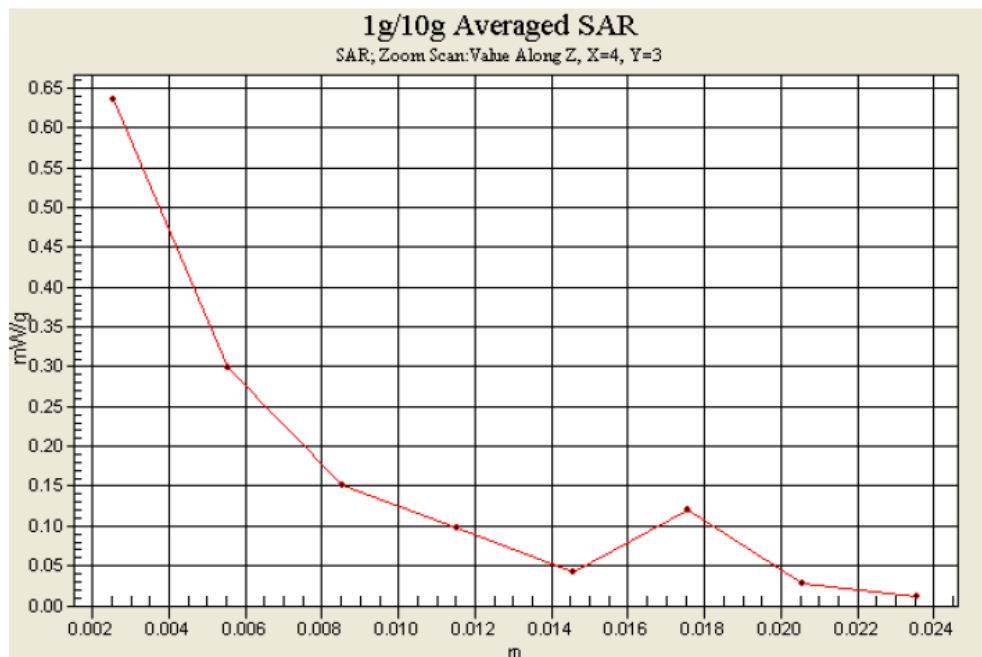



Appendix C – Calibration Data

Calibration Laboratory of
Schmid & Partner
Engineering AG
Zeughausstrasse 43, 8004 Zurich, Switzerland

Client Sporton (Auden)

CALIBRATION CERTIFICATE
Object(s) D5GHzV2 - SN:1006
Calibration procedure(s) QA CAL-05.v2
Calibration date: January 22, 2004
Condition of the calibrated item In Tolerance (according to the specific calibration document)
This calibration statement documents traceability of M&T&E used in the calibration procedures and conformity of the procedures with the ISO/IEC 17025 International standard.
All calibrations have been conducted in the closed laboratory facility: environment temperature 22 +/- 2 degrees Celsius and humidity < 75%.
Calibration Equipment used (M&T&E critical for calibration)
Model Type ID # Cal Date (Calibrated by, Certificate No.) Scheduled Calibration
Power meter EPM E4419B GS41293674 2-Apr-03 (METAS, No 252-0250) Apr-04
Power sensor E4412A MY41435277 2-Apr-03 (METAS, No 252-0250) Apr-04
Power sensor HP 8481A MY41052317 18-Oct-02 (Agilent, No. 20021018) Oct-04
RF generator R&S SMT05 100058 23-May-01 (SPEAG, in house check May-03) In house check: May-05
Network Analyzer HP 8753E US37390585 18-Oct-01 (SPEAG, in house check Nov-03) In house check: Oct 05
Calibrated by: Name Function Signature
Katja Pokovic Laboratory Director
Approved by: Name Function Signature
Fin Bombart R&D Director
Date issued: January 26, 2004
This calibration certificate is issued as an intermediate solution until the accreditation process (based on ISO/IEC 17025 International Standard) for Calibration Laboratory of Schmid & Partner Engineering AG is completed.



Schmid & Partner Engineering AG

s p e a g

Zeughausstrasse 43, 8004 Zurich, Switzerland
Phone +41 1 245 9700, Fax +41 1 245 9779
info@speag.com, <http://www.speag.com>

DASY

Dipole Validation Kit

Type: D5GHzV2

Serial: 1006

Manufactured: August 28, 2003
Calibrated: January 22, 2004



1. Measurement Conditions

The measurements were performed in the flat section of the SAM twin phantom filled with **head simulating solution** of the following electrical parameters:

Frequency:	5200 MHz	
Relative Dielectricity	36.3	± 5%
Conductivity	4.57 mho/m	± 5%
Frequency:	5800 MHz	
Relative Dielectricity	35.4	± 5%
Conductivity	5.20 mho/m	± 5%

The DASY4 System with a dosimetric E-field probe EX3DV3 - SN:3503 was used for the measurements. The dipole was mounted on the small tripod so that the dipole feedpoint was positioned below the center marking of the flat phantom section and the dipole was oriented parallel to the body axis (the long side of the phantom). The standard measuring distance was 10mm from dipole center to the solution surface. Lossless spacer was used during measurements for accurate distance positioning.

The coarse grid with a grid spacing of 10mm was aligned with the dipole. Special 8x8x8 fine cube was chosen for cube integration (dx=dy=4.3mm, dz=3mm). Distance between probe sensors and phantom surface was set to 2.5 mm. The dipole input power (forward power) was 250mW ± 3 %. The results are normalized to 1W input power.

2. SAR Measurement with DASY System

Standard SAR-measurements were performed according to the measurement conditions described in section 1. The results (see figures supplied) have been normalized to a dipole input power of 1W (forward power). The resulting averaged SAR-values measured at **5200 MHz (Head Tissue)** with the dosimetric probe EX3DV3 SN:3503 and applying the advanced extrapolation are:

averaged over 1 cm ³ (1 g) of tissue:	84.0 mW/g ± 20.3 % (k=2)¹
averaged over 10 cm ³ (10 g) of tissue:	23.4 mW/g ± 19.8 % (k=2)¹

The resulting averaged SAR-values measured at **5800 MHz (Head Tissue)** with the dosimetric probe EX3DV3 SN:3503 and applying the advanced extrapolation are:

averaged over 1 cm ³ (1 g) of tissue:	84.0 mW/g ± 20.3 % (k=2)²
averaged over 10 cm ³ (10 g) of tissue:	23.5 mW/g ± 19.8 % (k=2)²

¹ Target dipole values determined by FDTD (feedpoint impedance set to 50 Ohm). The values are SAR_{1g}=76.5 mW/g, SAR_{10g}=21.6 mW/g and SAR_{peak}=310.3 mW/g.

² Target dipole values determined by FDTD (feedpoint impedance set to 50 Ohm). The values are SAR_{1g}=78.0 mW/g, SAR_{10g}=21.9 mW/g and SAR_{peak}=340.9 mW/g.



3. Dipole Transformation Parameters

The impedance was measured at the SMA-connector with a network analyzer and numerically transformed to the dipole feedpoint (please refer to the graphics attached to this document). The transformation parameters from the SMA-connector to the dipole feedpoint are:

Electrical delay: **1.201ns** (one direction)
Transmission factor: **0.974** (voltage transmission, one direction)

4. Measurement Conditions

The measurements were performed in the flat section of the SAM twin phantom filled with **body simulating solution** of the following electrical parameters:

Frequency:	5200 MHz	
Relative Dielectricity	49.7	± 5%
Conductivity	5.18 mho/m	± 5%
Frequency:	5800 MHz	
Relative Dielectricity	48.5	± 5%
Conductivity	6.01 mho/m	± 5%

The DASY3 System with a dosimetric E-field probe EX3DV3 - SN:3503 was used for the measurements. The dipole was mounted on the small tripod so that the dipole feedpoint was positioned below the center marking of the flat phantom section and the dipole was oriented parallel to the body axis (the long side of the phantom). The standard measuring distance was 10mm from dipole center to the solution surface. Lossless spacer was used during measurements for accurate distance positioning.

The coarse grid with a grid spacing of 10mm was aligned with the dipole. The 8x8x8 fine cube was chosen for cube integration (dx=dy=4.3mm, dz=3mm). Distance between probe sensors and phantom surface was set to 2.5 mm. The dipole input power (forward power) was 250mW ± 3 %. The results are normalized to 1W input power.



5. SAR Measurement with DASYS System

Standard SAR-measurements were performed according to the measurement conditions described in section 4. The results (see figures supplied) have been normalized to a dipole input power of 1 W (forward power). The resulting averaged SAR-values measured at **5200 MHz (Body Tissue)** with the dosimetric probe EX3DV3 SN:3503 and applying the advanced extrapolation are:

averaged over 1 cm³ (1 g) of tissue: **78.0 mW/g ± 20.3 % (k=2)³**

averaged over 10 cm³ (10 g) of tissue: **22.0 mW/g ± 19.8 % (k=2)³**

The resulting averaged SAR-values measured at **5800 MHz (Body Tissue)** with the dosimetric probe EX3DV3 SN:3503 and applying the advanced extrapolation are:

averaged over 1 cm³ (1 g) of tissue: **76.6 mW/g ± 20.3 % (k=2)⁴**

averaged over 10 cm³ (10 g) of tissue: **21.1 mW/g ± 19.8 % (k=2)⁴**

6. Handling

Do not apply excessive force to the dipole arms, because they might bend. Bending of the dipole arms stresses the soldered connections near the feedpoint leading to a damage of the dipole.

7. Design

The dipole is made of standard semirigid coaxial cable. The center conductor of the feeding line is directly connected to the second arm of the dipole. The antenna is therefore short-circuited for DC-signals.

Small end caps have been added to the dipole arms in order to increase frequency bandwidth at the position as explained in Sections 1 and 4.

8. Power Test

After long term use with 40W radiated power, only a slight warming of the dipole near the feedpoint can be measured.

³ Target dipole values determined by FDTD (feedpoint impedance set to 50 Ohm). The values are SAR_1g=71.8 mW/g, SAR_10g=20.1 mW/g and SAR_peak=284.7 mW/g.

⁴ Target dipole values determined by FDTD (feedpoint impedance set to 50 Ohm). The values are SAR_1g=74.1 mW/g, SAR_10g=20.5 mW/g and SAR_peak=324.7 mW/g.



Test Laboratory: SPEAG, Zurich, Switzerland

DUT: Dipole 5GHz; Serial: D5GHzV2 - SN:1006

Communication System: CW-5GHz; Duty Cycle: 1:1; Medium: HSL5800

Medium parameters used: $f = 5200$ MHz; $\sigma = 4.57$ mho/m; $\epsilon_r = 36.3$; $\rho = 1000$ kg/m³

Medium parameters used: $f = 5800$ MHz; $\sigma = 5.2$ mho/m; $\epsilon_r = 35.4$; $\rho = 1000$ kg/m³

DASY4 Configuration:

- Probe: EX3DV3 - SN3503; ConvF(5.7, 5.7, 5.7)
ConvF(5, 5, 5); Calibrated: 6/27/2003
- Sensor-Surface: 2.5mm (Mechanical Surface Detection)
- Electronics: DAE4 600; Calibrated: 9/30/2003
- Phantom: SAM with CRP - TP:1312; Phantom section: Flat Section
- Measurement SW: DASY4, V4.2 Build 21; Postprocessing SW: SEMCAD, V2.0 Build 14

d=10mm, Pin=250mW, f=5200 MHz/Area Scan (91x91x1): Measurement grid: dx=10mm, dy=10mm

Reference Value = 95.1 V/m

Power Drift = -0.1 dB

Maximum value of SAR = 39 mW/g

d=10mm, Pin=250mW, f=5800 MHz/Zoom Scan (8x8x8), dist=2.5mm (7x7x8)/Cube 0:

Measurement grid: dx=4.3mm, dy=4.3mm, dz=3mm

Peak SAR (extrapolated) = 86.5 W/kg

SAR(1 g) = 21 mW/g; SAR(10 g) = 5.88 mW/g

d=10mm, Pin=250mW, f=5200 MHz/Zoom Scan (8x8x8), dist=2.5mm (7x7x8)/Cube 0:

Measurement grid: dx=4.3mm, dy=4.3mm, dz=3mm

Peak SAR (extrapolated) = 81.9 W/kg

SAR(1 g) = 21 mW/g; SAR(10 g) = 5.84 mW/g

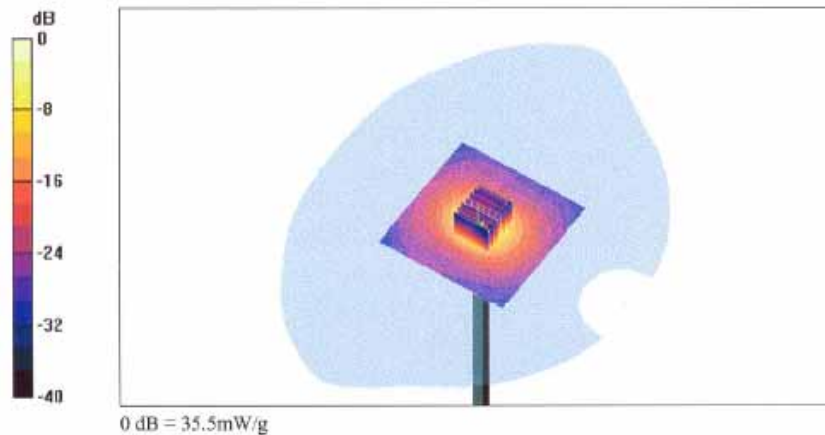



Test Laboratory: SPEAG, Zurich, Switzerland

DUT: Dipole 5GHz; Serial: D5GHzV2 - SN:1006

Communication System: CW-5GHz;Duty Cycle: 1:1;Medium: MSL5800

Medium parameters used: $f = 5200$ MHz; $\sigma = 5.18$ mho/m; $\epsilon_r = 49.7$; $\rho = 1000$ kg/m³

Medium parameters used: $f = 5800$ MHz; $\sigma = 6.01$ mho/m; $\epsilon_r = 48.5$; $\rho = 1000$ kg/m³

DASY4 Configuration:

- Probe: ESX3DV3 - SN3503; ConvF(5, 5, 5)
ConvF(4.6, 4.6, 4.6); Calibrated: 6/27/2003
- Sensor-Surface: 2.5mm (Mechanical Surface Detection)
- Electronics: DAE4 600; Calibrated: 9/30/2003
- Phantom: SAM with CRP - TP.1312; Phantom section: Flat Section
- Measurement SW: DASY4, V4.2 Build 21; Postprocessing SW: SEMCAD, V2.0 Build 14

d=10mm, Pin=250mW, f=5200 MHz/Area Scan (91x91x1); Measurement grid: dx=10mm, dy=10mm

Reference Value = 80.2 V/m

Power Drift = -0.007 dB

Maximum value of SAR = 36.8 mW/g

d=10mm, Pin=250mW, f=5800 MHz/Zoom Scan (8x8x8), dist=2.5mm (7x7x8)/Cube 0:

Measurement grid: dx=4.3mm, dy=4.3mm, dz=3mm

Peak SAR (extrapolated) = 78.4 W/kg

SAR(1 g) = 19.2 mW/g; SAR(10 g) = 5.28 mW/g

d=10mm, Pin=250mW, f=5200 MHz/Zoom Scan (8x8x8), dist=2.5mm (7x7x8)/Cube 0:

Measurement grid: dx=4.3mm, dy=4.3mm, dz=3mm

Peak SAR (extrapolated) = 69.7 W/kg

SAR(1 g) = 19.5 mW/g; SAR(10 g) = 5.49 mW/g

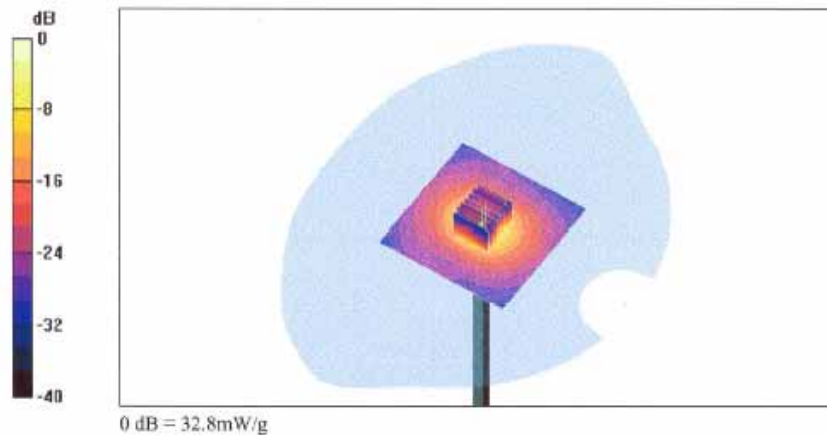



100G
Head

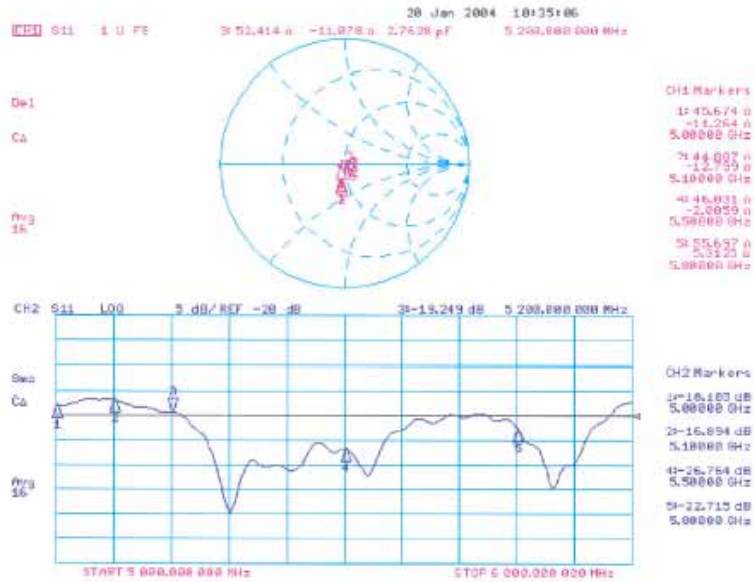



100G
Body

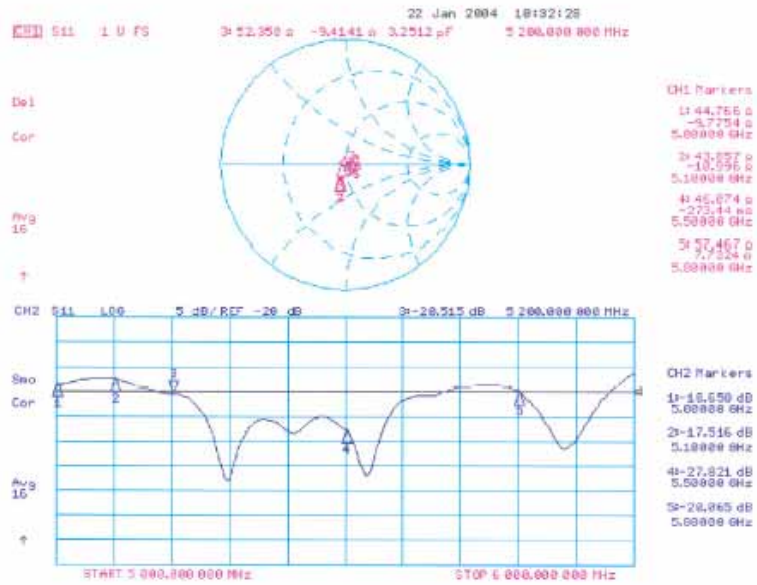



Calibration Laboratory of
Schmid & Partner
Engineering AG
Zeughausstrasse 43, 8004 Zurich, Switzerland

Client Sporton International Inc. (Auden)

CALIBRATION CERTIFICATE																																			
Object(s)	EX3DV3 - SN:3514																																		
Calibration procedure(s)	QA CAL-01.v2 Calibration procedure for dosimetric E-field probes																																		
Calibration date	January 23, 2004																																		
Condition of the calibrated item	In Tolerance (according to the specific calibration document)																																		
<p>This calibration certificate documents the traceability to national standards, which realize the physical units of measurements (SI). The measurements and the uncertainties with confidence probability are given on the following pages and are part of the certificate.</p> <p>All calibrations have been conducted in the closed laboratory facility; environment temperature 22 +/- 2 degrees Celsius and humidity < 75%.</p> <p>Calibration Equipment used (M&TE critical for calibration)</p> <table border="1"> <thead> <tr> <th>Model Type</th> <th>ID #</th> <th>Cal Date (Calibrated by, Certificate No.)</th> <th>Scheduled Calibration</th> </tr> </thead> <tbody> <tr> <td>Power meter EPM E4419B</td> <td>GB41293874</td> <td>2-Apr-03 (METAS, No 252-0250)</td> <td>Apr-04</td> </tr> <tr> <td>Power sensor E4412A</td> <td>MY41496277</td> <td>2-Apr-03 (METAS, No 252-0250)</td> <td>Apr-04</td> </tr> <tr> <td>Reference 20 dB Attenuator</td> <td>SN: 5086 (20c)</td> <td>3-Apr-03 (METAS, No. 251-0340)</td> <td>Apr-04</td> </tr> <tr> <td>Fuke Process Calibrator Type 702</td> <td>SN: 6266803</td> <td>8-Sep-03 (Sintrel SCS No. E-030020)</td> <td>Sep-04</td> </tr> <tr> <td>Power sensor HP 8481A</td> <td>MY41092160</td> <td>18-Sep-02 (SPEAG, in house check Oct-03)</td> <td>in house check: Oct 05</td> </tr> <tr> <td>RF generator R&S SMT06</td> <td>100058</td> <td>23-May-01 (SPEAG, in house check May-03)</td> <td>in house check: May-05</td> </tr> <tr> <td>Network Analyzer HP 8753E</td> <td>US37390585</td> <td>16-Oct-01 (SPEAG, in house check Oct-03)</td> <td>in house check: Oct 05</td> </tr> </tbody> </table>				Model Type	ID #	Cal Date (Calibrated by, Certificate No.)	Scheduled Calibration	Power meter EPM E4419B	GB41293874	2-Apr-03 (METAS, No 252-0250)	Apr-04	Power sensor E4412A	MY41496277	2-Apr-03 (METAS, No 252-0250)	Apr-04	Reference 20 dB Attenuator	SN: 5086 (20c)	3-Apr-03 (METAS, No. 251-0340)	Apr-04	Fuke Process Calibrator Type 702	SN: 6266803	8-Sep-03 (Sintrel SCS No. E-030020)	Sep-04	Power sensor HP 8481A	MY41092160	18-Sep-02 (SPEAG, in house check Oct-03)	in house check: Oct 05	RF generator R&S SMT06	100058	23-May-01 (SPEAG, in house check May-03)	in house check: May-05	Network Analyzer HP 8753E	US37390585	16-Oct-01 (SPEAG, in house check Oct-03)	in house check: Oct 05
Model Type	ID #	Cal Date (Calibrated by, Certificate No.)	Scheduled Calibration																																
Power meter EPM E4419B	GB41293874	2-Apr-03 (METAS, No 252-0250)	Apr-04																																
Power sensor E4412A	MY41496277	2-Apr-03 (METAS, No 252-0250)	Apr-04																																
Reference 20 dB Attenuator	SN: 5086 (20c)	3-Apr-03 (METAS, No. 251-0340)	Apr-04																																
Fuke Process Calibrator Type 702	SN: 6266803	8-Sep-03 (Sintrel SCS No. E-030020)	Sep-04																																
Power sensor HP 8481A	MY41092160	18-Sep-02 (SPEAG, in house check Oct-03)	in house check: Oct 05																																
RF generator R&S SMT06	100058	23-May-01 (SPEAG, in house check May-03)	in house check: May-05																																
Network Analyzer HP 8753E	US37390585	16-Oct-01 (SPEAG, in house check Oct-03)	in house check: Oct 05																																
Calibrated by:	Name Nico Vetterli	Function Technician	Signature 																																
Approved by:	Name Kaja Pokovic	Function Laboratory Director	Signature 																																
Date issued: January 28, 2004																																			
<p>This calibration certificate is issued as an intermediate solution until the accreditation process (based on ISO/IEC 17025 International Standard) for Calibration Laboratory of Schmid & Partner Engineering AG is completed.</p>																																			



Probe EX3DV3

SN:3514

Manufactured: December 15, 2003
Last calibrated: January 23, 2004

Calibrated for DASYS Systems

(Note: non-compatible with DASYS2 system!)



EX3DV3 SN:3514

January 23, 2004

DASY - Parameters of Probe: EX3DV3 SN:3514

Sensitivity in Free Space		Diode Compression [^]	
NormX	0.66 $\mu\text{V}/(\text{V}/\text{m})^2$	DCP X	97 mV
NormY	0.67 $\mu\text{V}/(\text{V}/\text{m})^2$	DCP Y	97 mV
NormZ	0.60 $\mu\text{V}/(\text{V}/\text{m})^2$	DCP Z	97 mV

Sensitivity in Tissue Simulating Liquid (Conversion Factors)

Please see Page 7.

Boundary Effect

Head	900 MHz	Typical SAR gradient: 5 % per mm	
	Sensor Center to Phantom Surface Distance	2.0 mm	3.0 mm
	SAR _{iso} [%] Without Correction Algorithm	3.2	1.2
	SAR _{iso} [%] With Correction Algorithm	0.6	0.1
Head	1800 MHz	Typical SAR gradient: 10 % per mm	
	Sensor to Surface Distance	2.0 mm	3.0 mm
	SAR _{iso} [%] Without Correction Algorithm	4.9	3.1
	SAR _{iso} [%] With Correction Algorithm	1.7	0.5

Sensor Offset

Probe Tip to Sensor Center **1.0** mm

The reported uncertainty of measurement is stated as the standard uncertainty of measurement multiplied by the coverage factor k=2, which for a normal distribution corresponds to a coverage probability of approximately 95%.

[^] numerical linearization parameter: uncertainty not required