

# FCC TEST REPORT

**CATEGORY** : Portable End Product

**PRODUCT NAME** : Mobile Computer

**FCC ID.** : H9PMC3070

**FILING TYPE** : Certification

**BRAND NAME** : SYMBOL

**MODEL NAME** : MC3070

**APPLICANT** : **SYMBOL Technologies, Inc.**  
One Symbol Plaza Holtsville, New York, 11742-1300 U.S.A

**MANUFACTURER:** **Universal Scientific Industrial Co., Ltd.**  
141, Lane 351, Taiping Road, Sec.1, Tsao Yuen,  
Nan-Tou, Taiwan, R.O.C.

**ISSUED BY** : **SPORTON INTERNATIONAL INC.**  
6F, No. 106, Sec. 1, Hsin Tai Wu Rd., His Chih, Taipei Hsien,  
Taiwan, R.O.C.

## Statements:

The test result in this report refers exclusively to the presented test model / sample.

Without written approval of SPORTON International Inc., the test report shall not be reproduced except in full.

Certificate or Test Report could not be used by the applicant to claim the product endorsement by CNLA, NVLAP or any agency of U.S. government.

The test equipment used to perform the test are calibrated and traceable to NML/ROC or NIST/USA.



**Dr. Alan Lane**  
Vice General Manager  
Sporton International Inc.



Lab Code: 200079-0



## Table of Contents

History of this test report.....	ii
<b>1. General Description of Equipment under Test.....</b>	<b>3</b>
1.1. Applicant.....	3
1.2. Manufacturer .....	3
1.3. Basic Description of Equipment under Test .....	3
1.4. Features of Equipment under Test.....	3
1.5. Table for Carrier Frequencies .....	4
<b>2. Test Configuration of the Equipment under Test.....</b>	<b>5</b>
2.1. Description of the Test .....	5
2.2. Frequency Range Investigated .....	5
2.3. Test Mode .....	5
2.4. Description of Test Supporting Units.....	6
2.5. Connection Diagram of Test System .....	6
2.6. Test Software .....	7
<b>3. Test Location and Standards .....</b>	<b>8</b>
3.1. Test Location.....	8
3.2. Test Conditions .....	8
3.3. Standards for Methods of Measurement.....	8
3.4. DoC Statement.....	8
<b>4. List of Measurements.....</b>	<b>9</b>
4.1. Summary of the Test Results .....	9
<b>5. Test Result .....</b>	<b>10</b>
5.1. Test of Spectrum Bandwidth of a Direct Sequence Spread Spectrum System (6 dB Bandwidth) .....	10
5.2. Test of Maximum Peak Output Power .....	15
5.3. Test of Peak Power Spectral Density.....	17
5.4. Test of Band Edges of the Operating Frequency.....	22
5.5. Test of AC Power Line Conducted Emission .....	27
5.6. Test of Spurious Radiated Emission .....	32
5.7. Antenna Requirements .....	43
<b>6. List of Measuring Equipments Used .....</b>	<b>44</b>
<b>Appendix A. Photographs of EUT.....</b>	<b>A1 ~ A113</b>



### History of this test report

No additional attachment.

Additional attachment were issued as following record:

Attachment No.	Issue Date	Description



## 1. General Description of Equipment under Test

### 1.1. Applicant

**SYMBOL Technologies, Inc.**

One Symbol Plaza Holtsville, New York, 11742-1300 U.S.A

### 1.2. Manufacturer

**Universal Scientific Industrial Co., Ltd.**

141, Lane 351, Taiping, Sec. 1, Tsao Yuen, Nan-Tou, Taiwan, R.O.C.

### 1.3. Basic Description of Equipment under Test

The device supplied for testing is a mobile computer with 21-21160 RF Module which offers 2.4GHz wireless local area network connectivity employing IEEE 802.11 b/g technologies. The technical data has been listed on section " Features of Equipment under Test ".

### 1.4. Features of Equipment under Test

ITEMS	DESCRIPTION
Type of Modulation	DSSS (CCK / QPSK / BPSK ), OFDM (16, 64 QAM)
Number of Channel	11
Frequency Band	2400 ~ 2483.5 MHz
Carrier Frequencies	Please reference section 1.5.
Output Power	CCK :19.30dBm (peak) OFDM : 19.07dBm (peak)
Channel Bandwidth	16 MHz
Function Type	Transceiver
Antenna / Gain	PIFA Antenna / 1dBi
Power Rating (DC/AC, Voltage)	AC input 100~240V, DC output 5.4V
Temperature Range (Operating)	-20 ~ +55 °C



### 1.5. Table for Carrier Frequencies

Channel	Frequency	Channel	Frequency	Channel	Frequency	Channel	Frequency
1	2412 MHz	5	2432 MHz	9	2452 MHz		
2	2417 MHz	6	2437 MHz	10	2457 MHz		
3	2422 MHz	7	2442 MHz	11	2462 MHz		
4	2427 MHz	8	2447 MHz				



## 2. Test Configuration of the Equipment under Test

### 2.1. Description of the Test

- a. Spurious emission below 1GHz is independent of channel selection, so only channel 11 was tested.
- b. For spurious emission above 1GHz , DSSS with 11Mbps data rate was tested, OFDM with 54Mbps data rate was tested.
- c. The EUT has been programmed to continuously transmit or receive during testing. The used peripherals as well as the configuration fulfill the requirements of ANSI C63.4:2001.
- d. 3 meters measurement distance of semi-anechoic chamber was used in this test.

### 2.2. Frequency Range Investigated

- a. Conducted power line test: from 150 kHz to 30 MHz
- b. Radiated emission test: from 30 MHz to 25000 MHz

### 2.3. Test Modes

The following are the configuration of host MC3070.

Test Mode	Model 1	Model 2
Mechanical	Straight Shooter - Brick	Straight Shooter - Brick
Processor	Intel Bulverde 520MHz	Intel Bulverde 416MHz
Flash	64MB	32MB
SDRAM	64MB	32MB
LCD Panel	Sharp LQ030B7DD01 (Color)	Sharp LQ030B7DD01 (Color)
Touch Panel	Liyitec TR4-030F-14G	NA
Keypad	48 Key	38 Key
Scanning	Symbol PICO Imager (20-60000-XX)	Symbol SE800hp
WLAN	Symbol Photon 802.11b/g (21-21160)	Symbol Photon 802.11b/g (21-21160)
Battery	Symbol 55-060112-86 3.7V 4400mAh	Symbol 55-060114-86 3.7V 2600mAh

Test Mode	Model 3	Model 4
Mechanical	Rotating Head – Brick	Rotating Head – Brick
Processor	Intel Bulverde 520MHz	Intel Bulverde 416MHz
Flash	64MB	32MB
SDRAM	64MB	32MB
LCD Panel	EDT ES50512FLWP (Mono)	EDT ES50512FLWP (Mono)
Touch Panel	Liyitec TR4-030F-14G	NA
Keypad	28 Key	38 Key
Scanning	Symbol SE800hp	Symbol SE800hp
WLAN	Symbol Photon 802.11b/g (21-21160)	Symbol Photon 802.11b/g (21-21160)
Battery	Symbol 55-060112-86 3.7V 4400mAh	Symbol 55-060114-86 3.7V 2600mAh

The above 4 models have been verified. Model 1 with RS232 accessory was found to be the worst case. So, only this model will be shown in this test report.

## 2.4. Description of Test Supporting Units

### Support Unit 1. – Notebook (DELL)

FCC ID : N/A  
Model No. : PP10L  
Serial No. : SP0031  
Remark : This support device was tested to comply with FCC standards and authorized under Declaration of Conformity.

### Support Unit 2. – Printer (EPSON)

FCC ID : N/A  
Model No. : Stylus Color 680  
Serial No. : SP0016  
Remark : This support device was tested to comply with FCC standards and authorized under Declaration of Conformity and data cable is 1.35m of the shielded.

## 2.5. Connection Diagram of Test System

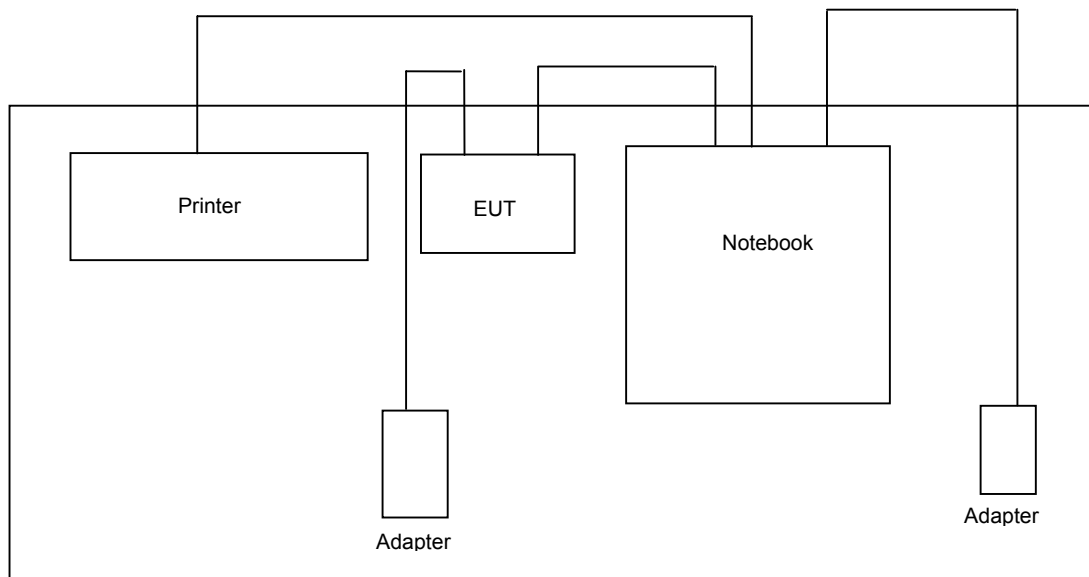



## **2.6. Test Software**

Channel & Power Controlling Software: This was provided by the manufacturer and is able to let the test engineer select the operating channel as well as the RF output power. The parameters for channel selection is trying to offer the test engineer the ability to fix the operating channel for testing, both normal data and continuously transmitting modes are allowed, and that for RF output power selection is for the setting of RF output power expected by the customer and is going to be fixed on the firmware of the final end product.





---

### 3. Test Location and Standards

#### 3.1. Test Location

**Test Location** : Sporton Hwa Ya Testing Building  
**Address** : No. 52, Hwa Ya 1<sup>st</sup> Rd., Hwa Ya Technology Park, Kwei-Shan Hsiang, Tao Yuan Hsien, Taiwan, R.O.C.  
Tel: +886 3 327 3456 Fax: +886 3 318 0055  
**Test Site No.** : CO04-HY, 03CH03-HY

#### 3.2. Test Conditions

Normal Voltage : 120V/60Hz (power adapter)  
Extreme Voltage : 138V and 102V (power adapter)  
Normal Temperature : 20 °C  
Extreme Temperature : -20 °C and 50 °C

#### 3.3. Standards for Methods of Measurement

Here is the list of the standards followed in this test report.

**ANSI C63.4-2001**

**47 CFR Part 15 Subpart C ( Section 15.247 )**

#### 3.4. DoC Statement

This EUT is also classified as a device of computer peripheral Class B which DoC has to be followed. It has been verified according to the rule of 47 CFR part 15 Subpart B, and found that all the requirements has been fulfilled.



## 4. List of Measurements

### 4.1. Summary of the Test Results

Applied Standard: 47 CFR Part 15 and Part 2			
Paragraph	FCC Rule	Description of Test	Result
5.1	15.247(a)(2)	Spectrum Bandwidth of a Direct Sequence Spread Spectrum System(6 dB Bandwidth)	Pass
5.2	15.247(b)	Maximum Peak Output Power	Pass
5.3	15.247(d)	Peak Power Spectral Density	Pass
5.4	15.247(c)	Band Edges of the Operating Frequency	Pass
5.5	15.107/15.207	AC Power Line Conducted Emission	Pass
5.6	15.209/15.247(c)	Spurious Radiated Emission	Pass
5.7	15.203	Antenna Requirement	Pass

## 5. Test Result

### 5.1. Test of Spectrum Bandwidth of a Direct Sequence Spread Spectrum System (6 dB Bandwidth)

#### 5.1.1 Measuring Instruments

Item 9 of the table on section 6.

#### 5.1.2 Test Procedures

1. The transmitter output was connected to the spectrum analyzer through an attenuator.
2. Set RBW of spectrum analyzer to 100KHz and VBW to 100KHz.
3. The 6dB bandwidth is defined as the spectrum width with level higher than 6dB below the peak level.
4. Repeat above 1~3 points for the middle and highest channel of the EUT.

#### 5.1.3 Test Setup Layout

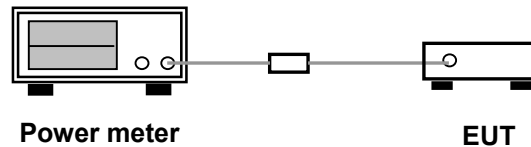

#### 5.1.4 Test Result: See spectrum analyzer plots below

- Modulation Type: CCK
- Temperature: 24°C
- Relative humidity: 60 %
- Test Engineer: Bunny Yao

Channel	Frequency (MHz)	6dB Bandwidth (MHz)	Min. Limit (MHz)
01	2412	11.52	0.5
06	2437	11.52	0.5
11	2462	11.42	0.5



CCK (Channel 01) :

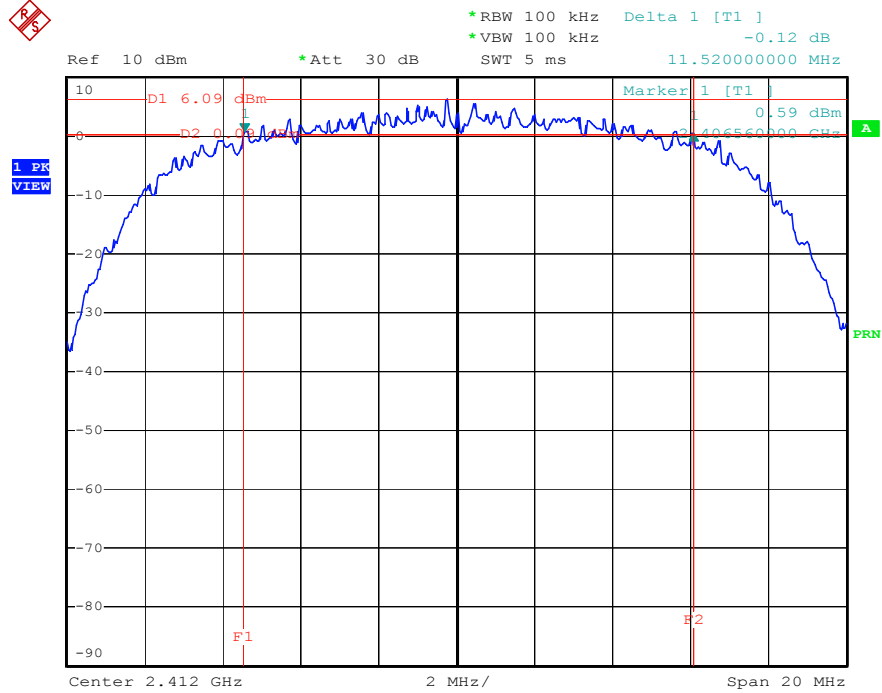

Date: 30.AUG.2004 09:43:12

CCK (Channel 06) :

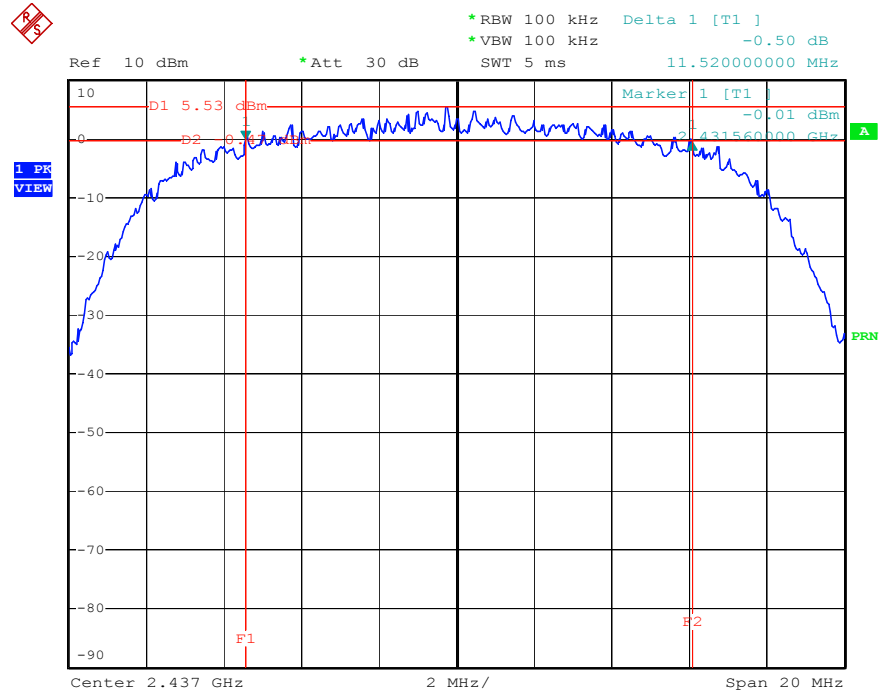

Date: 30.AUG.2004 09:45:22



CCK (Channel 11) :

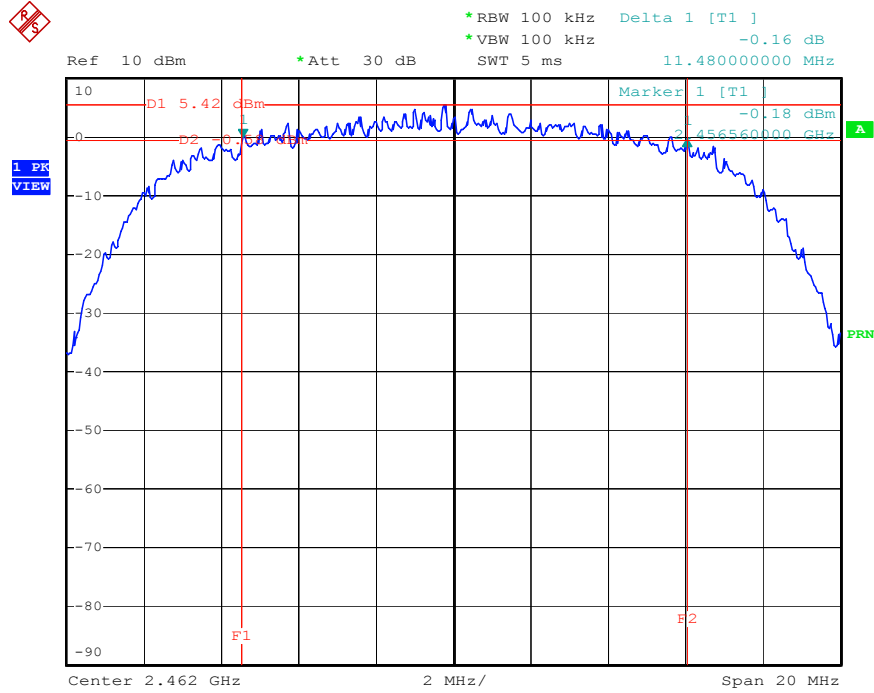

Date: 30.AUG.2004 09:47:31

5.1.5 Test Result: See spectrum analyzer plots below

- Modulation Type: OFDM
- Temperature: 24°C
- Relative humidity: 60 %
- Test Engineer: Bunny Yao

Channel	Frequency (MHz)	6dB Bandwidth (MHz)	Min. Limit (MHz)
01	2412	16.44	0.5
06	2437	16.44	0.5
11	2462	16.48	0.5



OFDM (Channel 01) :

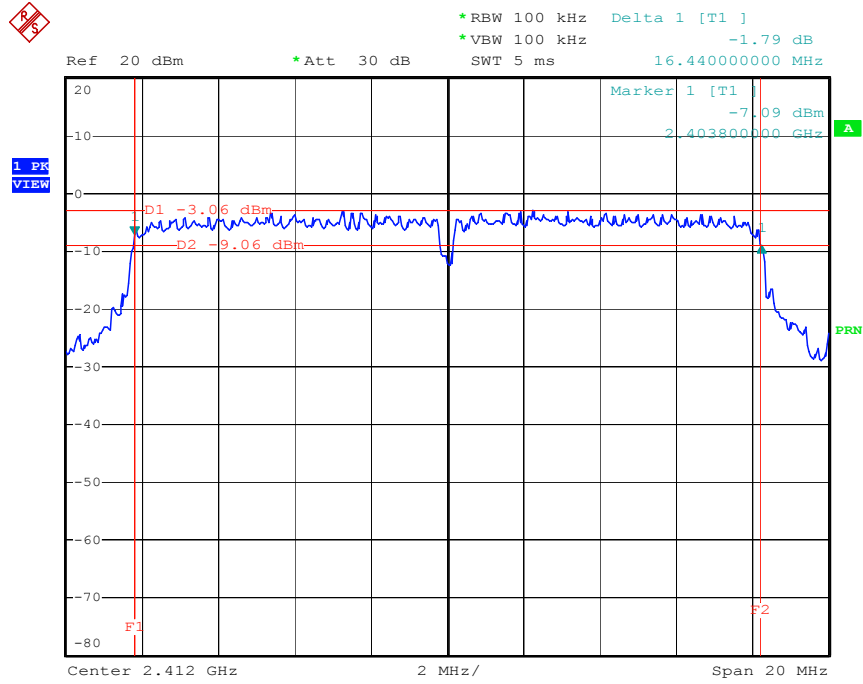

Date: 30.AUG.2004 10:27:05

OFDM (Channel 06) :

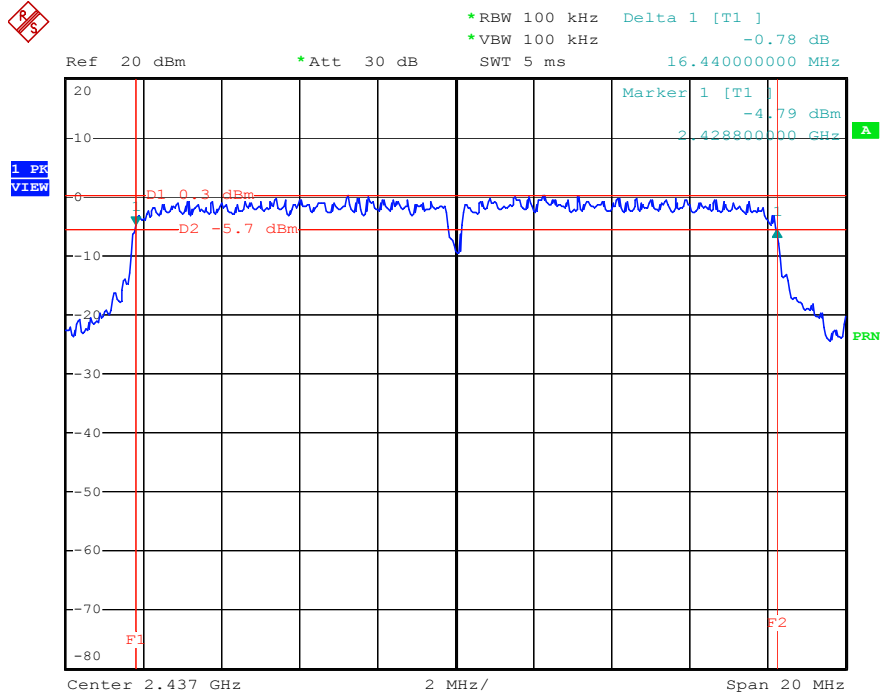

Date: 30.AUG.2004 10:28:53



OFDM (Channel 11) :

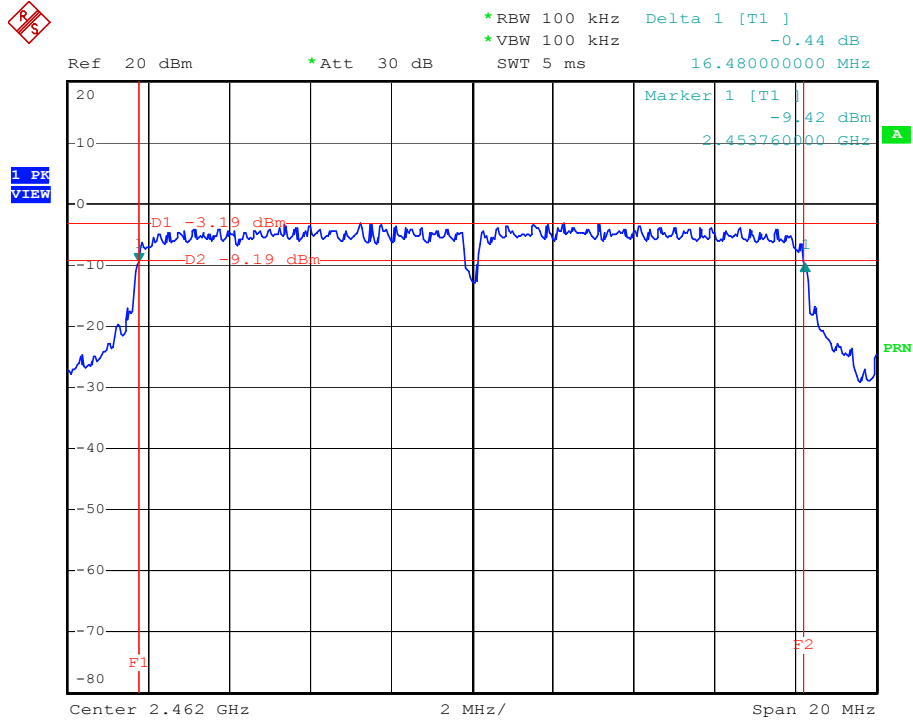

Date: 30.AUG.2004 10:33:11

## 5.2. Test of Maximum Peak Output Power

### 5.2.1 Measuring Instruments

Item 9 of the table on section 6.

### 5.2.2 Test Procedures

1. The transmitter output was connected to the vertical channel of the oscilloscope through a detector.
2. Record peak value from the meter.
3. Replace the EUT by signal generator, record the power level which can reach the same level on oscilloscope.
4. Repeated the 1~3 for the middle and highest channel of the EUT.

### 5.2.3 Test Setup Layout

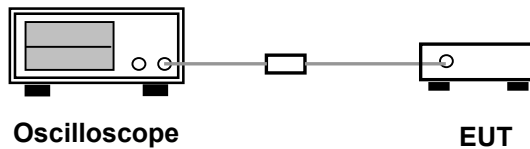

### 5.2.4 Test Result

- Modulation Type: CCK
- Temperature: 24°C
- Relative humidity: 60 %
- Test Engineer: Bunny Yao

Channel	Frequency (MHz)	Output Power (dBm)	Output Power (mWatt)	Limits (dBm )
01	2412	19.00	79.43	30 dBm
06	2437	19.30	85.11	30 dBm
11	2462	18.90	77.63	30 dBm





### 5.2.5 Test Result

- Modulation Type: OFDM
- Temperature: 24°C
- Relative humidity: 60 %
- Test Engineer: Bunny Yao

Channel	Frequency (MHz)	Output Power (dBm)	Output Power (mWatt)	Limits (dBm )
01	2412	16.78	47.64	30 dBm
06	2437	19.07	80.72	30 dBm
11	2462	17.30	53.70	30 dBm

### 5.3. Test of Peak Power Spectral Density

#### 5.3.1 Measuring Instruments

Item 9 of the table on section 6.

#### 5.3.2 Test Procedures

1. The transmitter output is connected to the spectrum analyzer through an attenuator.
2. Set RBW of spectrum analyzer to 3kHz and VBW to 30kHz.
3. Mark the frequency with maximum peak power as the center of the display of the spectrum
4. Set the span to 1.5MHz and the sweep time to 500s and record the maximum peak value.
5. Repeated the 1~4 for the middle and highest channel of the EUT.

#### 5.3.3 Test Setup Layout

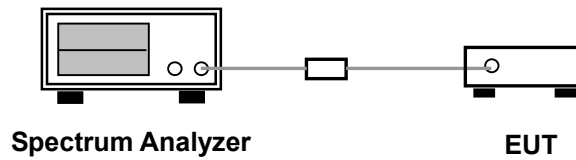

#### 5.3.4 Test Result : See spectrum analyzer plots below

- Modulation Type: CCK
- Temperature: 24°C
- Relative Humidity: 60 %
- Test Engineer: Bunny Yao

Channel	Frequency (MHz)	Power Density (dBm)	Limits (dBm)
01	2412	-5.78	8
06	2437	-6.24	8
11	2462	-6.94	8



CCK (Channel 01) :

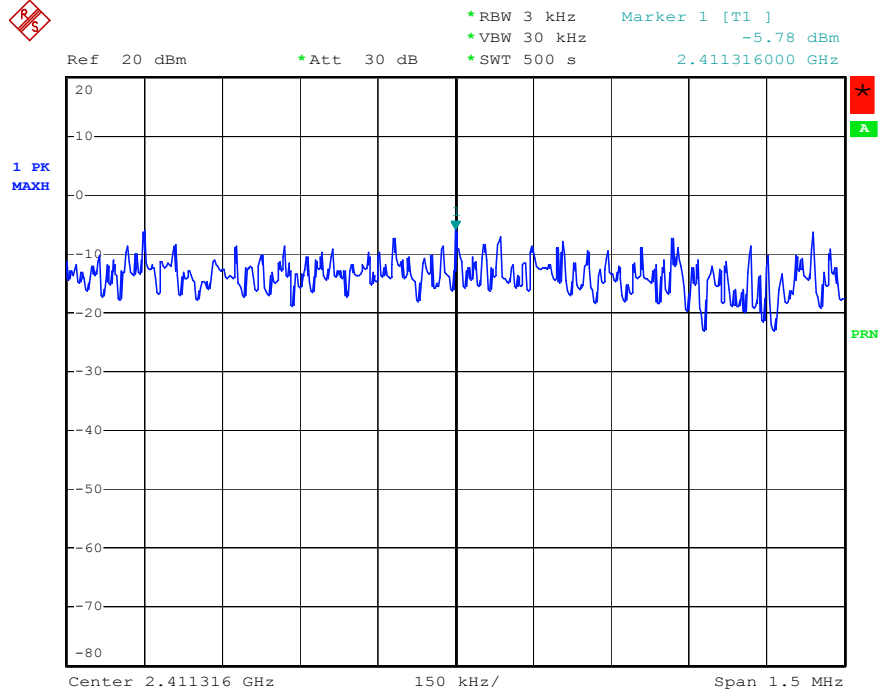

Date: 1.NOV.2004 15:00:23

CCK (Channel 06) :

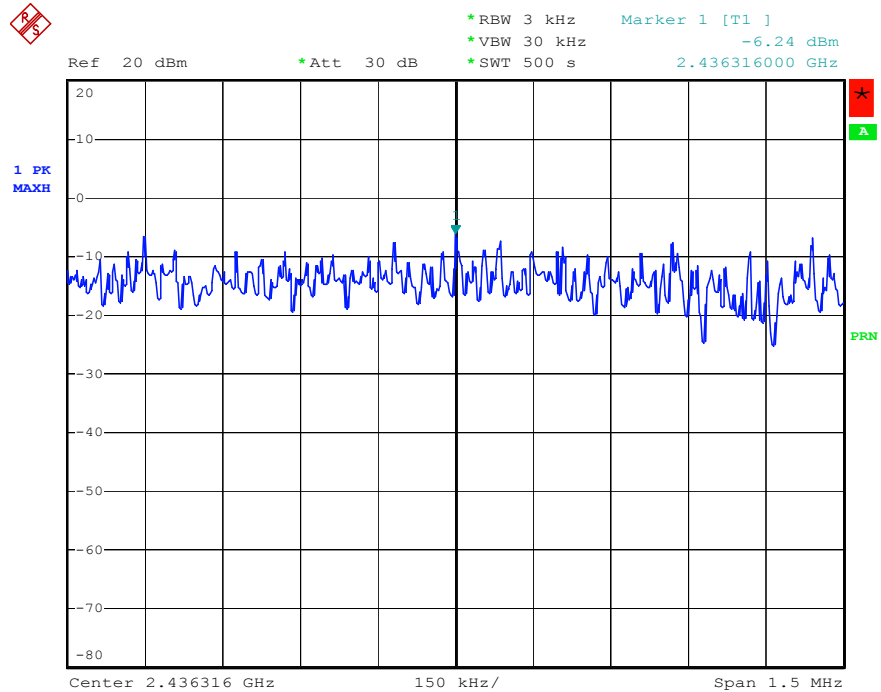

Date: 1.NOV.2004 15:01:23



CCK (Channel 11) :

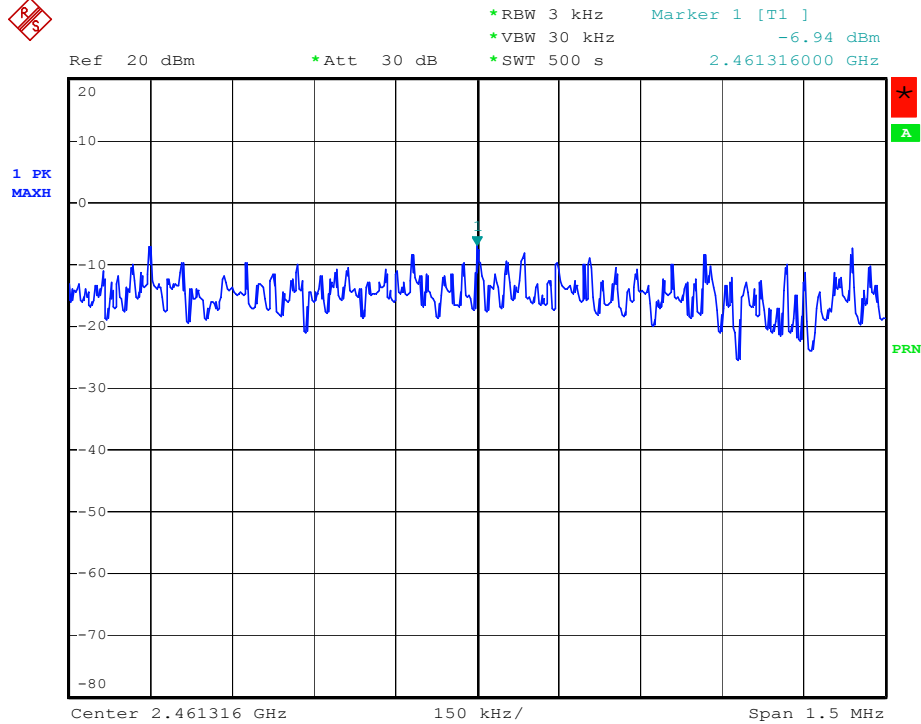

Date: 1.NOV.2004 15:02:16

5.3.5 Test Result : See spectrum analyzer plots below

- Modulation Type: OFDM
- Temperature: 24°C
- Relative Humidity: 60 %
- Test Engineer: Bunny Yao

Channel	Frequency (MHz)	Power Density (dBm)	Limits (dBm)
01	2412	-14.82	8
06	2437	-12.21	8
11	2462	-14.88	8



OFDM (Channel 01) :

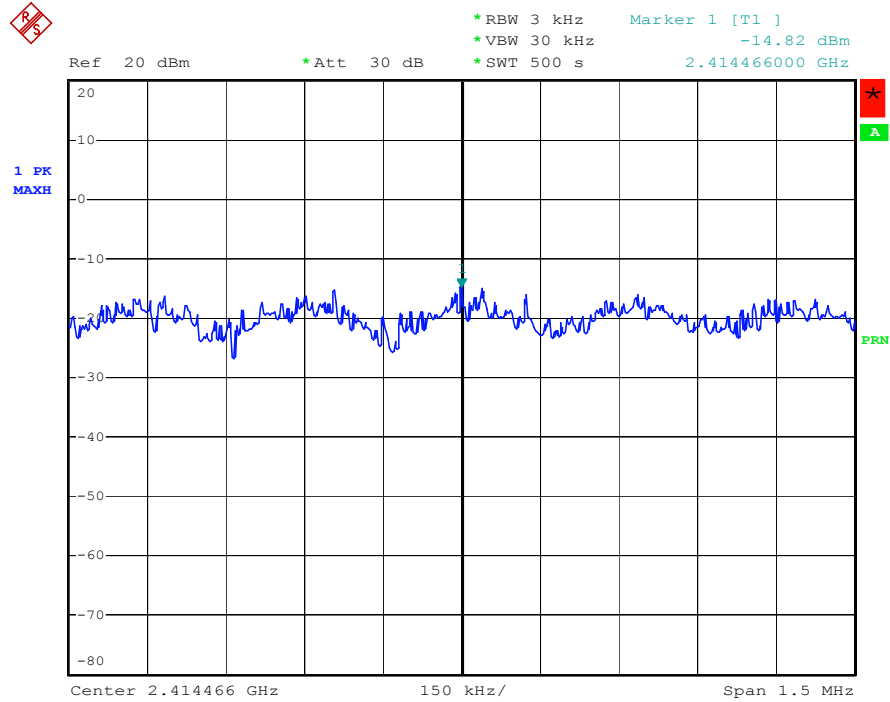

Date: 1.NOV.2004 14:50:15

OFDM (Channel 06) :

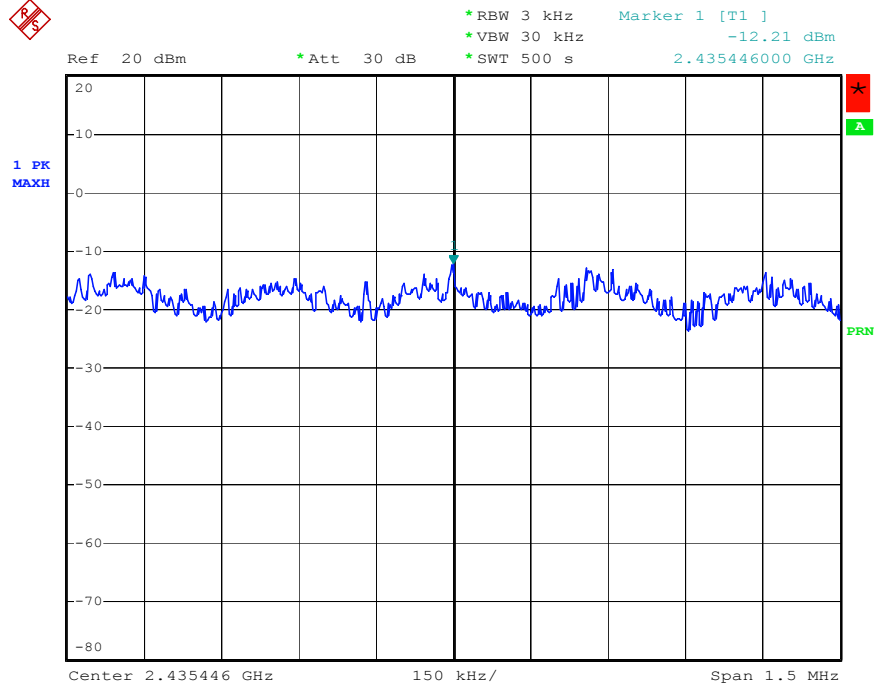

Date: 1.NOV.2004 14:51:26





## 5.4. Test of Band Edges of the Operating Frequency

### 5.4.1 Measuring Instruments

Item 9 of the table on section 6.

### 5.4.2 Test Procedures

1. The transmitter is set to the lowest channel.
2. The transmitter output was connected to the spectrum analyzer via a cable and cable loss is used as the offset of the spectrum analyzer.
3. Set both RBW and VBW of spectrum analyzer to 100KHz with convenient frequency span including 100MHz bandwidth from lower band edge.
4. The lowest band edges emission was measured and recorded.
5. The transmitter set to the highest channel and repeated 2~4.

### 5.4.3 Test Result

Test Result in lower band (Channel 01) :	PASS
Test Result in higher band(Channel 11) :	PASS



5.4.4 Note on Band edge Emission

Modulation Type : CCK

(A) Left Edge

The band edge emission plot shows 58.22dB delta between carrier maximum power and local maximum emission in the restricted band.

CH01 Carrier power strength (dB $\mu$ V/m)	Delta (dB)	The maximum field strength in restrict band (dB $\mu$ V/m)	Limit (dB $\mu$ V/m)	Margin (dB)
97.42	58.22	39.20	54.00	-14.80

(B) Right Edge

The band edge emission plot shows 57.61dB delta between carrier maximum power and local maximum emission in the restricted band.

CH11 Carrier power strength (dB $\mu$ V/m)	Delta (dB)	The maximum field strength in restrict band (dB $\mu$ V/m)	Limit (dB $\mu$ V/m)	Margin (dB)
93.27	57.61	35.66	54.00	-18.34

\* The maximum field strength in restricted band is the emission of carrier power strength subtract to the delta between carrier maximum power and local maximum emission in the restricted band.





CCK (Channel 01) :

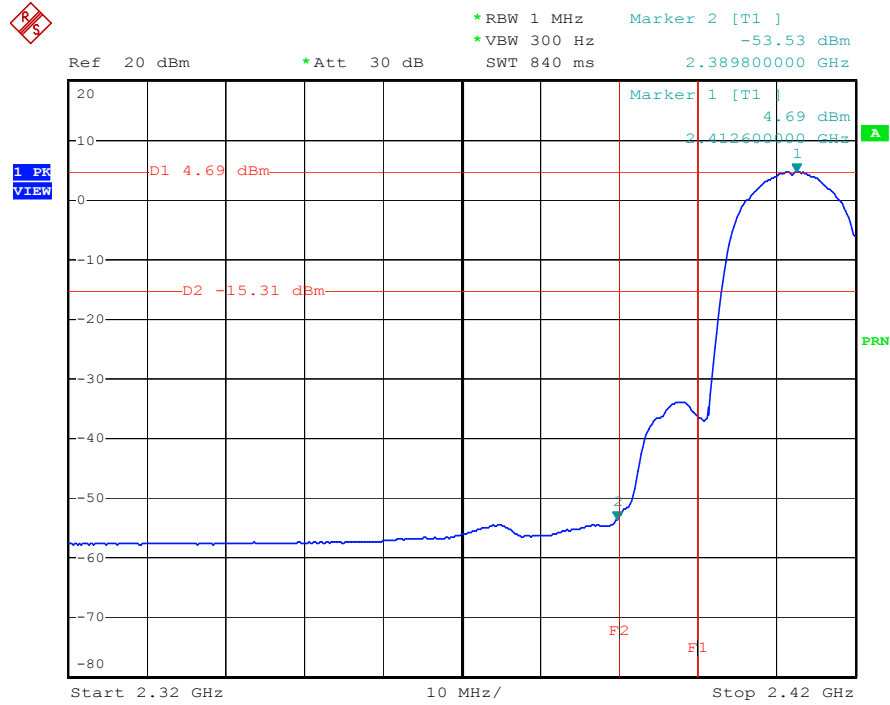

CCK (Channel 11) :

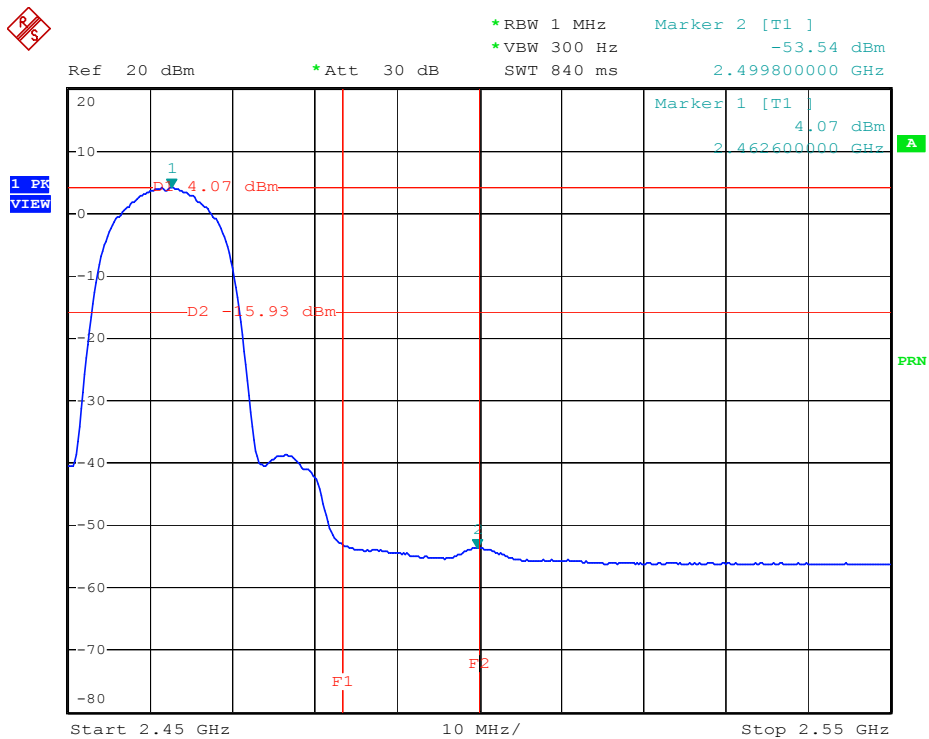

Observation : All emissions in the 100kHz bandwidth are 20dB lower than the carrier strength.



5.4.5 Note on Band edge Emission

Modulation Type : OFDM

(A) Left Edge

The band edge emission plot shows 51.53dB delta between carrier maximum power and local maximum emission in the restricted band.

CH01 Carrier power strength (dB $\mu$ V/m)	Delta (dB)	The maximum field strength in restrict band (dB $\mu$ V/m)	Limit (dB $\mu$ V/m)	Margin (dB)
93.75	51.53	42.22	54.00	-11.78

(B) Right Edge

The band edge emission plot shows 51.10dB delta between carrier maximum power and local maximum emission in the restricted band.

CH11 Carrier power strength (dB $\mu$ V/m)	Delta (dB)	The maximum field strength in restrict band (dB $\mu$ V/m)	Limit (dB $\mu$ V/m)	Margin (dB)
88.10	51.10	37.00	54.00	-17.00

\* The maximum field strength in restricted band is the emission of carrier power strength subtract to the delta between carrier maximum power and local maximum emission in the restricted band.

OFDM (Channel 01) :

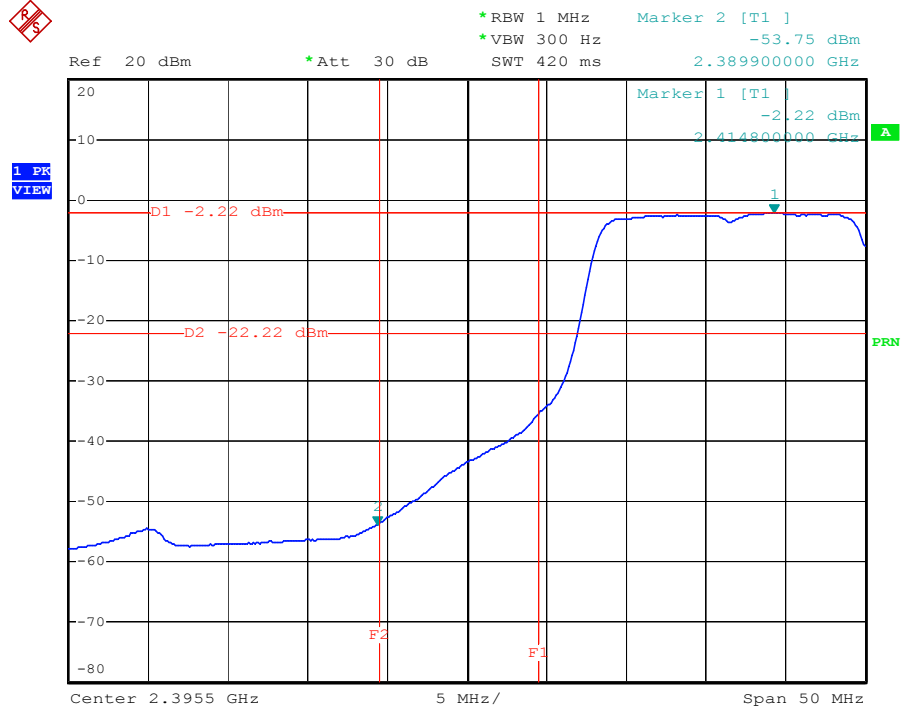

OFDM (Channel 11) :

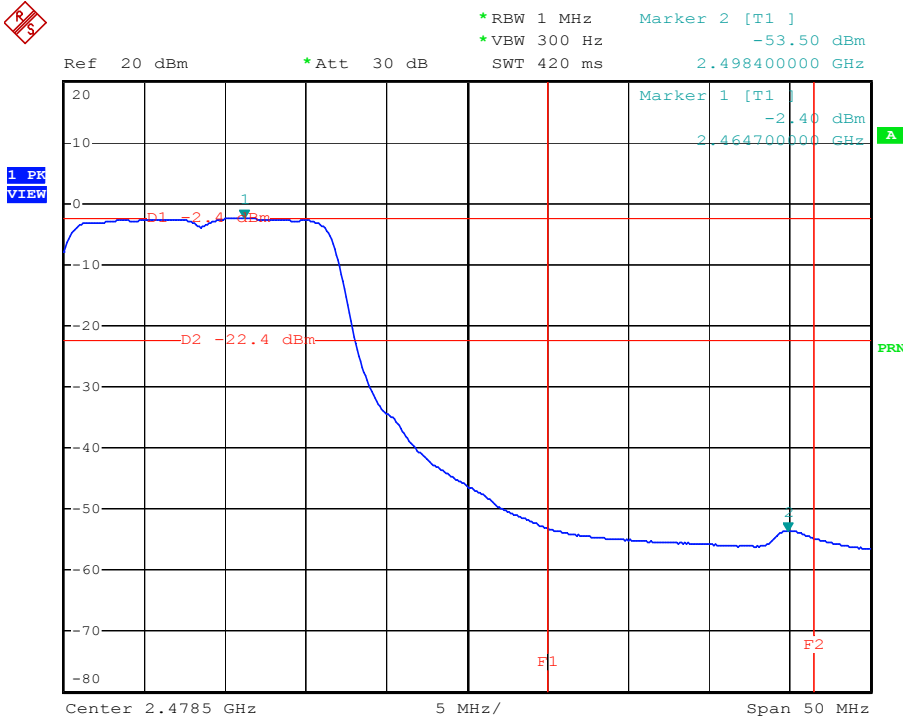

Observation : All emissions in the 100kHz bandwidth are 20dB lower than the carrier strength.



---

## 5.5. Test of AC Power Line Conducted Emission

### 5.5.1 Measuring Instruments

Please reference item 1~7 in chapter 6 for the instruments used for testing.

### 5.5.2 Test Procedures

1. Configure the EUT according to ANSI C63.4.
2. The EUT has to be placed 0.4 meter far from the conducting wall of the shielding room and at least 80 centimeters from any other grounded conducting surface.
3. Connect EUT to the power mains through a line impedance stabilization network (LISN).
4. All the support units are connected to the other LISNs. The LISN should provides 50uH/50ohms coupling impedance.
5. The frequency range from 150 KHz to 30 MHz was searched.
6. Use the Channel & Power Controlling software to make the EUT working on selected channel and expected output power, then use the "H" Patter Generator software to make the supporting equipments stay on working condition.
7. Set the test-receiver system to Peak Detect Function and Specified Bandwidth with Maximum Hold Mode.
8. The measurement has to be done between each power line and ground at the power terminal for each RF channel. Only one RF channel has to be investigated since this test is independent with the RF channel selection.



5.5.3 Test Result of Conducted Emission

<b>Modulation Type</b>	CCK		
<b>Test Mode</b>	Mode 1	<b>Tested By</b>	Brian Lin
<b>Temperature / Humidity</b>	27 deg. C / 44%		

*Line to Ground*

	Freq	Level	Over Limit	Limit Line	Read Level	LISN Factor	Cable Loss	Remark
	MHz	dBuV	dB	dBuV	dBuV	dB	dB	
1	@0.1514870	44.70	-21.22	65.92	44.59	0.10	0.01	QP
2	0.1514870	18.62	-37.30	55.92	18.51	0.10	0.01	Average
3	@0.1913520	45.90	-18.08	63.98	45.79	0.10	0.01	QP
4	@0.1913520	33.44	-20.54	53.98	33.33	0.10	0.01	Average
5	@0.1917970	34.30	-19.66	53.96	34.19	0.10	0.01	Average
6	@0.1917970	46.76	-17.20	63.96	46.65	0.10	0.01	QP
7	@0.2163110	48.47	-14.49	62.96	48.36	0.10	0.01	QP
8	0.2163110	15.17	-37.79	52.96	15.06	0.10	0.01	Average
9	@0.2495110	28.01	-23.76	51.77	27.90	0.10	0.01	Average
10	@0.2495110	38.13	-23.64	61.77	38.02	0.10	0.01	QP
11	@0.2515110	28.01	-23.70	51.71	27.90	0.10	0.01	Average
12	@0.2515110	39.49	-22.22	61.71	39.38	0.10	0.01	QP
13	@ 3.010	30.44	-25.56	56.00	30.23	0.16	0.05	QP
14	3.010	7.44	-38.56	46.00	7.23	0.16	0.05	Average

*Neutral to Ground*

	Freq	Level	Over Limit	Limit Line	Read Level	LISN Factor	Cable Loss	Remark
	MHz	dBuV	dB	dBuV	dBuV	dB	dB	
1	@0.1564950	44.97	-20.68	65.65	44.86	0.10	0.01	QP
2	0.1564950	23.95	-31.70	55.65	23.84	0.10	0.01	Average
3	@0.1885450	33.90	-20.20	54.10	33.79	0.10	0.01	Average
4	@0.1885450	46.26	-17.84	64.10	46.15	0.10	0.01	QP
5	@0.1922450	31.36	-22.58	53.94	31.25	0.10	0.01	Average
6	@0.1922450	44.67	-19.27	63.94	44.56	0.10	0.01	QP
7	@0.2333330	37.35	-24.98	62.33	37.24	0.10	0.01	QP
8	0.2333330	11.18	-41.15	52.33	11.07	0.10	0.01	Average
9	@0.2481360	26.48	-25.34	51.82	26.37	0.10	0.01	Average
10	@0.2481360	37.31	-24.51	61.82	37.20	0.10	0.01	QP
11	2.715	9.39	-36.61	46.00	9.25	0.10	0.04	Average
12	@ 2.715	32.92	-23.08	56.00	32.78	0.10	0.04	QP



<b>Modulation Type</b>	OFDM		
<b>Test Mode</b>	Mode 1	<b>Tested By</b>	Brian Lin
<b>Temperature / Humidity</b>	27 deg. C / 44%		

**Line to Ground**

	<b>Freq</b>	<b>Level</b>	<b>Over Limit</b>	<b>Limit Line</b>	<b>Read Level</b>	<b>LISN Factor</b>	<b>Cable Loss</b>	<b>Remark</b>
	<b>MHz</b>	<b>dBuV</b>	<b>dB</b>	<b>dBuV</b>	<b>dBuV</b>	<b>dB</b>	<b>dB</b>	
1	@0.1532130	44.68	-21.14	65.82	44.57	0.10	0.01	QP
2	0.1532130	19.04	-36.78	55.82	18.93	0.10	0.01	Average
3	@0.1694400	42.76	-22.23	64.99	42.65	0.10	0.01	QP
4	0.1694400	15.98	-39.01	54.99	15.87	0.10	0.01	Average
5	@0.1892300	46.68	-17.39	64.07	46.57	0.10	0.01	QP
6	@0.1892300	35.04	-19.03	54.07	34.93	0.10	0.01	Average
7	@0.2007870	40.09	-23.49	63.58	39.98	0.10	0.01	QP
8	0.2007870	18.58	-35.00	53.58	18.47	0.10	0.01	Average
9	@0.2534510	38.20	-23.44	61.64	38.09	0.10	0.01	QP
10	@0.2534510	27.25	-24.39	51.64	27.14	0.10	0.01	Average
11	@ 2.877	29.67	-26.33	56.00	29.47	0.15	0.05	QP
12	2.877	6.24	-39.76	46.00	6.04	0.15	0.05	Average

**Neutral to Ground**

	<b>Freq</b>	<b>Level</b>	<b>Over Limit</b>	<b>Limit Line</b>	<b>Read Level</b>	<b>LISN Factor</b>	<b>Cable Loss</b>	<b>Remark</b>
	<b>MHz</b>	<b>dBuV</b>	<b>dB</b>	<b>dBuV</b>	<b>dBuV</b>	<b>dB</b>	<b>dB</b>	
1	@0.1590020	43.94	-21.58	65.52	43.83	0.10	0.01	QP
2	0.1590020	15.52	-40.00	55.52	15.41	0.10	0.01	Average
3	@0.1907340	44.63	-19.37	64.00	44.52	0.10	0.01	QP
4	@0.1907340	32.11	-21.89	54.00	32.00	0.10	0.01	Average
5	@0.2127940	39.46	-23.64	63.10	39.35	0.10	0.01	QP
6	0.2127940	11.72	-41.38	53.10	11.61	0.10	0.01	Average
7	@0.2520240	37.77	-23.92	61.69	37.66	0.10	0.01	QP
8	@0.2520240	26.59	-25.10	51.69	26.48	0.10	0.01	Average
9	@0.3165430	22.50	-27.30	49.80	22.38	0.10	0.02	Average
10	@0.3165430	32.14	-27.66	59.80	32.02	0.10	0.02	QP
11	3.450	10.38	-35.62	46.00	10.22	0.10	0.06	Average
12	@ 3.450	29.87	-26.13	56.00	29.71	0.10	0.06	QP

#### 5.5.4 Photographs of Radiated Emission Test Configuration

- The photographs show the configuration that generates the maximum emission.

##### Mode 1

FRONT VIEW



REAR VIEW

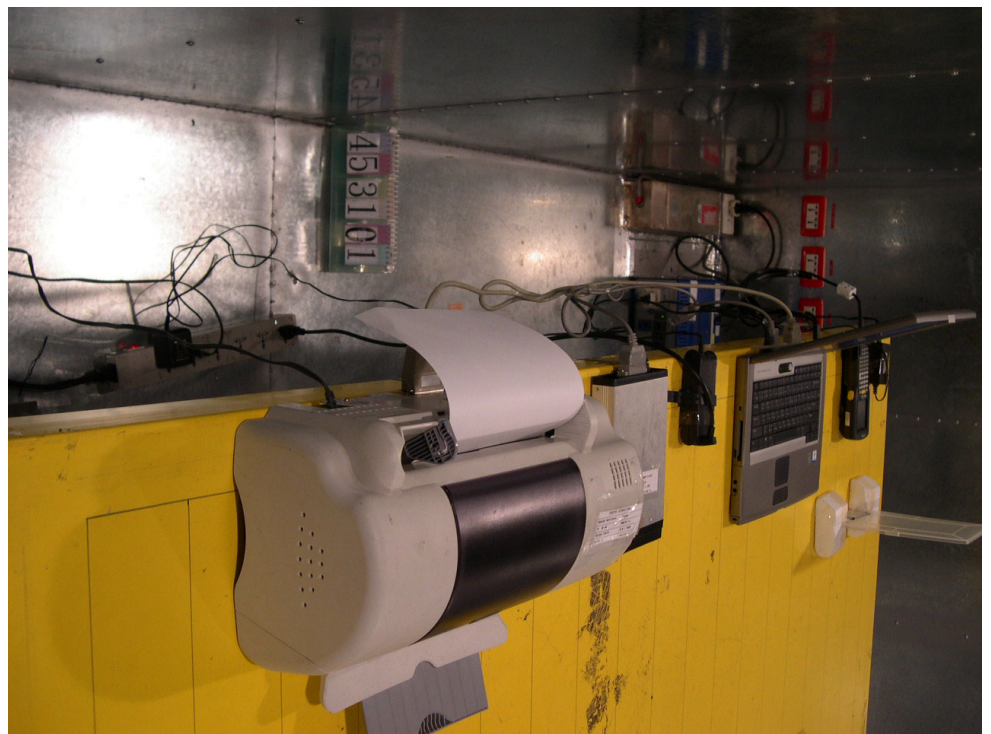

SIDE VIEW

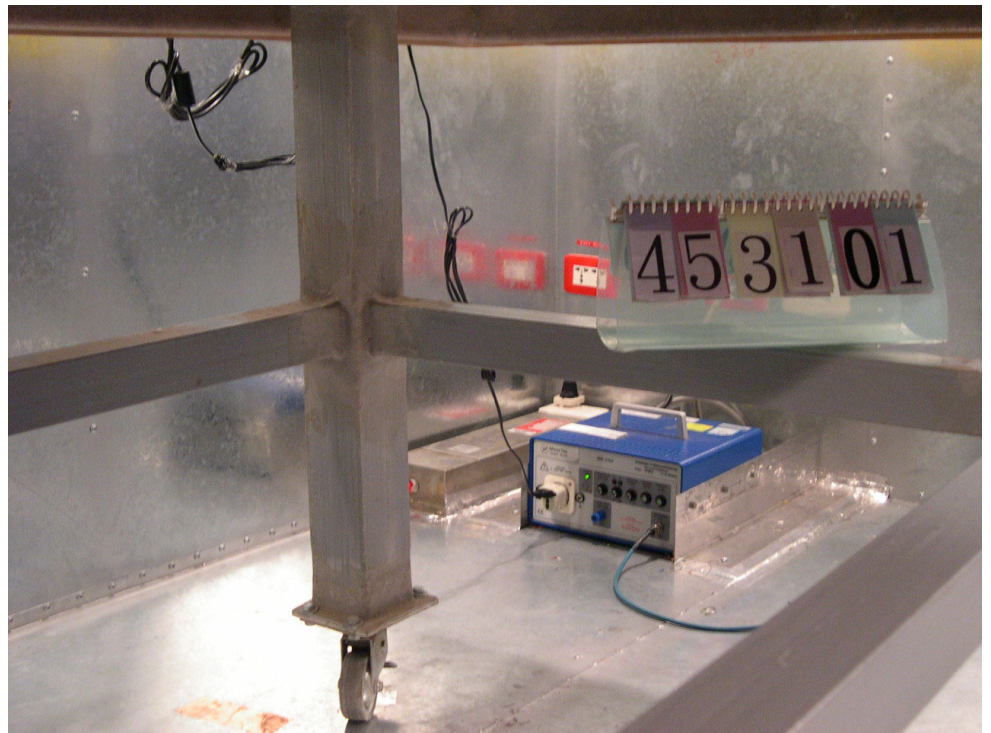





## 5.6. Test of Spurious Radiated Emission

### 5.6.1 Measuring Instruments

Please reference item 8~19 in chapter 6 for the instruments used for testing.

### 5.6.2 Test Procedures

1. Configure the EUT according to ANSI C63.4.
2. The EUT was placed on the top of the turn table 0.8 meter above ground.
3. The phase center of the receiving antenna mounted on the top of a height-variable antenna tower was placed 3 meters far away from the turn table.
4. Power on the EUT and all the supporting units.
5. The turn table was rotated by 360 degrees to determine the position of the highest radiation.
6. The height of the broadband receiving antenna was varied between one meter and four meters above ground to find the maximum emission field strength of both horizontal and vertical polarization.
7. For each suspected emission, the antenna tower was scan (from 1 M to 4 M) and then the turn table was rotated (from 0 degree to 360 degrees) to find the maximum reading.
8. Set the test-receiver system to Peak or CISPR quasi-peak Detect Function with specified bandwidth under Maximum Hold Mode.
9. For emission above 1GHz, use 1MHz VBW and RBW for peak reading. Then 1MHz RBW and 300Hz VBW for average reading in spectrum analyzer.
10. If the emission level of the EUT in peak mode was 3 dB lower than the average limit specified, then testing will be stopped and peak values of EUT will be reported, otherwise, the emissions which do not have 3 dB margin will be repeated one by one using the quasi-peak method for below 1GHz and average method for above the 1GHz. the reported.
11. For testing above 1GHz, the emission level of the EUT in peak mode was 20dB higher than average limit (that means the emission level in peak mode also complies with the limit in average mode), then testing will be stopped and peak values of EUT will be reported, otherwise, the emissions will be measured in average mode again and reported.

5.6.3 Test Setup Layout

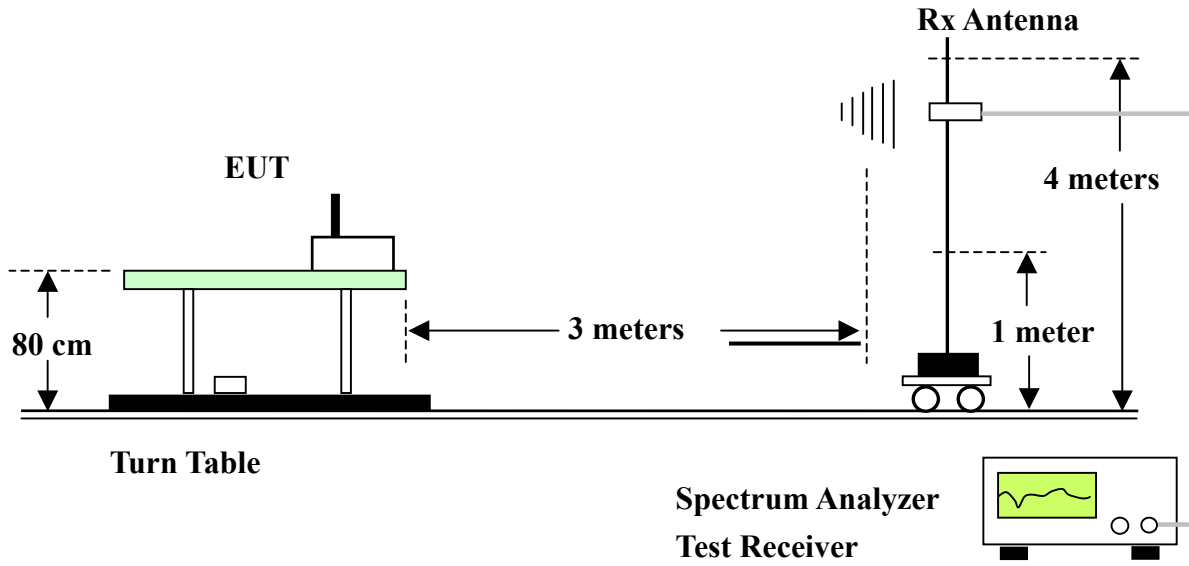



5.6.4 Test Results and Limit

**Note:**

Emission level (dBuV/m) = 20 log Emission level (uV/m)

Corrected Reading: Probe Factor + Cable Loss + Read Level - Preamp Factor = Level

<b>Modulation Type</b>	CCK				
<b>Test Mode</b>	CH 11	<b>Temperature</b>	25 deg. C	<b>Tested By</b>	Steve Chen
<b>Freq. Range</b>	30MHz~1GHz	<b>Humidity</b>	63%		

**(A) Polarization: Horizontal**

	Freq	Level	Over Limit	Limit Line	Read Level	Probe Factor	Cable Loss	Preamp Factor	Remark	Ant Pos	Table Pos
	MHz	dBuV/m	dB	dBuV/m	dBuV	dB	dB	dB		cm	deg
1	107.860	31.51	-11.99	43.50	47.41	10.13	1.85	27.88	Peak	---	---
2	166.510	24.94	-18.56	43.50	37.06	13.31	2.34	27.77	Peak	---	---
3	197.620	29.63	-13.87	43.50	39.18	15.60	2.55	27.70	Peak	---	---
1	265.600	37.73	-8.27	46.00	49.47	12.77	2.93	27.44	Peak	---	---
2	832.000	34.61	-11.39	46.00	36.19	21.84	5.22	28.64	Peak	---	---
3	998.400	35.41	-18.59	54.00	34.06	23.86	5.69	28.20	Peak	---	---

**(B) Polarization: Vertical**

	Freq	Level	Over Limit	Limit Line	Read Level	Probe Factor	Cable Loss	Preamp Factor	Remark	Ant Pos	Table Pos
	MHz	dBuV/m	dB	dBuV/m	dBuV	dB	dB	dB		cm	deg
1	33.060	32.57	-7.43	40.00	47.29	12.33	0.99	28.04	Peak	121	147
2	62.980	24.84	-15.16	40.00	41.19	10.29	1.33	27.97	Peak	---	---
3	170.420	26.94	-16.56	43.50	38.61	13.72	2.37	27.76	Peak	---	---
1	663.200	32.58	-13.42	46.00	36.07	20.59	4.66	28.74	Peak	---	---
2	832.000	33.29	-12.71	46.00	34.87	21.84	5.22	28.64	Peak	---	---
3	998.400	34.79	-19.21	54.00	33.44	23.86	5.69	28.20	Peak	---	---



<b>Modulation Type</b>	CCK				
<b>Test Mode</b>	CH 01	<b>Temperature</b>	25 deg. C	<b>Tested By</b>	Steve Chen
<b>Freq. Range</b>	1GHz~25GHz	<b>Humidity</b>	63%		

**(A) Polarization: Horizontal**

	Freq	Level	Over Limit	Limit Line	Read Level	Probe Factor	Cable Loss	Preamp Factor	Remark	Ant Pos	Table Pos
	MHz	dBuV/m	dB	dBuV/m	dBuV	dB	dB	dB		cm	deg
1	1000.000	46.78	-7.22	54.00	64.27	23.80	1.11	42.40	Peak	---	---
2	1326.000	45.28	-8.72	54.00	61.71	24.75	1.35	42.53	Average	---	---
3	2174.000	46.70	-7.30	54.00	60.10	27.57	1.69	42.66	Average	---	---
4	2380.000	47.89	-6.11	54.00	60.69	28.11	1.71	42.62	Average	105	144
1	4822.000	51.08	-22.92	74.00	59.75	33.23	2.47	44.37	Peak	---	---
2	4822.000	39.88	-14.12	54.00	48.55	33.23	2.47	44.37	Average	---	---

**(B) Polarization: Vertical**

	Freq	Level	Over Limit	Limit Line	Read Level	Probe Factor	Cable Loss	Preamp Factor	Remark	Ant Pos	Table Pos
	MHz	dBuV/m	dB	dBuV/m	dBuV	dB	dB	dB		cm	deg
1	1998.000	43.79	-10.21	54.00	57.86	27.11	1.52	42.70	Average	---	---
2	2212.000	45.57	-8.43	54.00	58.85	27.67	1.70	42.65	Average	---	---
3	2340.000	47.40	-6.60	54.00	60.33	28.01	1.69	42.63	Average	---	---
1	4822.000	56.00	-18.00	74.00	64.67	33.23	2.47	44.37	Peak	---	---
2	4822.000	44.44	-9.56	54.00	53.11	33.23	2.47	44.37	Average	---	---



<b>Modulation Type</b>	CCK				
<b>Test Mode</b>	CH 06	<b>Temperature</b>	25 deg. C	<b>Tested By</b>	Steve Chen
<b>Freq. Range</b>	1GHz~25GHz	<b>Humidity</b>	63%		

**(A) Polarization: Horizontal**

	Freq	Level	Over Limit	Limit Line	Read Level	Probe Factor	Cable Loss	Preamp Factor	Remark	Ant Pos	Table Pos
	MHz	dBuV/m	dB	dBuV/m	dBuV	dB	dB	dB		cm	deg
1	1000.000	46.62	-7.38	54.00	64.11	23.80	1.11	42.40	Average	---	---
2	2182.000	46.05	-7.95	54.00	59.43	27.59	1.69	42.66	Average	---	---
3	2358.000	47.37	-6.63	54.00	60.25	28.06	1.69	42.63	Average	102	151
1	4876.000	49.03	-24.97	74.00	57.57	33.35	2.52	44.41	Peak	---	---
2	4876.000	38.66	-15.34	54.00	47.20	33.35	2.52	44.41	Average	---	---

**(B) Polarization: Vertical**

	Freq	Level	Over Limit	Limit Line	Read Level	Probe Factor	Cable Loss	Preamp Factor	Remark	Ant Pos	Table Pos
	MHz	dBuV/m	dB	dBuV/m	dBuV	dB	dB	dB		cm	deg
1	1990.000	43.88	-10.12	54.00	57.98	27.08	1.52	42.70	Average	---	---
2	2196.000	46.25	-7.75	54.00	59.59	27.63	1.69	42.66	Average	---	---
3	2340.000	46.08	-7.92	54.00	59.01	28.01	1.69	42.63	Average	---	---
1	4876.000	54.26	-19.74	74.00	62.80	33.35	2.52	44.41	Peak	---	---
2	4876.000	41.81	-12.19	54.00	50.35	33.35	2.52	44.41	Average	---	---



<b>Modulation Type</b>	CCK				
<b>Test Mode</b>	CH 11	<b>Temperature</b>	25 deg. C	<b>Tested By</b>	Steve Chen
<b>Freq. Range</b>	1GHz~25GHz	<b>Humidity</b>	64%		

**(A) Polarization: Horizontal**

	Freq	Level	Over Limit	Limit Line	Read Level	Probe Factor	Cable Loss	Preamp Factor	Remark	Ant Pos	Table Pos
	MHz	dBuV/m	dB	dBuV/m	dBuV	dB	dB	dB		cm	deg
1	1332.000	40.79	-13.21	54.00	57.20	24.77	1.35	42.53	Average	---	---
2	2156.000	46.19	-7.81	54.00	59.65	27.52	1.69	42.67	Average	---	---
3	2358.000	47.20	-6.80	54.00	60.08	28.06	1.69	42.63	Average	---	---
1	4926.000	46.97	-7.03	54.00	55.49	33.46	2.47	44.45	Average	---	---

**(B) Polarization: Vertical**

	Freq	Level	Over Limit	Limit Line	Read Level	Probe Factor	Cable Loss	Preamp Factor	Remark	Ant Pos	Table Pos
	MHz	dBuV/m	dB	dBuV/m	dBuV	dB	dB	dB		cm	deg
1	2004.000	43.89	-10.11	54.00	57.93	27.12	1.54	42.70	Average	---	---
2	2214.000	45.26	-8.74	54.00	58.53	27.68	1.70	42.65	Average	---	---
3	2356.000	47.36	-6.64	54.00	60.25	28.05	1.69	42.63	Average	104	186
1	4924.000	50.44	-23.56	74.00	58.96	33.46	2.47	44.45	Peak	---	---
2	4924.000	38.27	-15.73	54.00	46.79	33.46	2.47	44.45	Average	---	---



<b>Modulation Type</b>	OFDM				
<b>Test Mode</b>	CH 11	<b>Temperature</b>	25 deg. C	<b>Tested By</b>	Steve Chen
<b>Freq. Range</b>	30MHz~1GHz	<b>Humidity</b>	63%		

**(A) Polarization: Horizontal**

	Freq	Level	Over Limit	Limit Line	Read Level	Probe Factor	Cable Loss	Preamp Factor	Remark	Ant Pos	Table Pos
	MHz	dBuV/m	dB	dBuV/m	dBuV	dB	dB	dB		cm	deg
1	107.350	30.03	-13.47	43.50	45.99	10.07	1.85	27.88	Peak	---	---
2	135.910	25.43	-18.07	43.50	38.77	12.49	2.00	27.83	Peak	---	---
3	196.940	30.53	-12.97	43.50	40.14	15.56	2.54	27.71	Peak	---	---
1	256.000	35.67	-10.33	46.00	47.78	12.50	2.87	27.48	Peak	---	---
2	265.600	36.68	-9.32	46.00	48.42	12.77	2.93	27.44	Peak	---	---
3	998.400	31.65	-22.35	54.00	30.30	23.86	5.69	28.20	Peak	---	---

**(B) Polarization: Vertical**

	Freq	Level	Over Limit	Limit Line	Read Level	Probe Factor	Cable Loss	Preamp Factor	Remark	Ant Pos	Table Pos
	MHz	dBuV/m	dB	dBuV/m	dBuV	dB	dB	dB		cm	deg
1	32.550	32.78	-7.22	40.00	47.39	12.45	0.98	28.04	Peak	142	145
2	101.230	23.33	-20.17	43.50	40.25	9.18	1.80	27.90	Peak	---	---
3	129.790	26.23	-17.27	43.50	39.63	12.33	2.11	27.84	Peak	---	---
1	666.400	32.89	-13.11	46.00	36.37	20.60	4.65	28.73	Peak	---	---
2	832.800	33.05	-12.95	46.00	34.62	21.83	5.23	28.63	Peak	---	---
3	1000.000	32.39	-21.61	54.00	31.00	23.90	5.69	28.20	Peak	---	---



<b>Modulation Type</b>	OFDM				
<b>Test Mode</b>	CH 01	<b>Temperature</b>	25 deg. C	<b>Tested By</b>	Steve Chen
<b>Freq. Range</b>	1GHz~25GHz	<b>Humidity</b>	64%		

**(A) Polarization: Horizontal**

	Freq	Level	Over Limit	Limit Line	Read Level	Probe Factor	Cable Loss	Preamp Factor	Remark	Ant Pos	Table Pos
	MHz	dBuV/m	dB	dBuV/m	dBuV	dB	dB	dB		cm	deg
1	1000.000	45.06	-8.94	54.00	62.55	23.80	1.11	42.40	Average	---	---
2	2180.000	45.07	-8.93	54.00	58.45	27.59	1.69	42.66	Average	---	---
3	2374.000	46.96	-7.04	54.00	59.77	28.10	1.71	42.62	Average	105	157
1	4828.000	43.79	-10.21	54.00	52.43	33.24	2.49	44.37	Average	---	---

**(B) Polarization: Vertical**

	Freq	Level	Over Limit	Limit Line	Read Level	Probe Factor	Cable Loss	Preamp Factor	Remark	Ant Pos	Table Pos
	MHz	dBuV/m	dB	dBuV/m	dBuV	dB	dB	dB		cm	deg
1	1990.000	43.25	-10.75	54.00	57.35	27.08	1.52	42.70	Average	---	---
2	2236.000	44.98	-9.02	54.00	58.19	27.73	1.71	42.65	Average	---	---
3	2374.000	46.57	-7.43	54.00	59.38	28.10	1.71	42.62	Average	---	---
1	4828.000	45.67	-8.33	54.00	54.31	33.24	2.49	44.37	Average	---	---





<b>Modulation Type</b>	OFDM				
<b>Test Mode</b>	CH 06	<b>Temperature</b>	25 deg. C	<b>Tested By</b>	Steve Chen
<b>Freq. Range</b>	1GHz~25GHz	<b>Humidity</b>	63%		

**(A) Polarization: Horizontal**

	Freq	Level	Over Limit	Limit Line	Read Level	Probe Factor	Cable Loss	Preamp Factor	Remark	Ant Pos	Table Pos
	MHz	dBuV/m	dB	dBuV/m	dBuV	dB	dB	dB		cm	deg
1	1332.000	46.36	-7.64	54.00	62.77	24.77	1.35	42.53	Average	102	162
2	2190.000	46.06	-7.94	54.00	59.42	27.61	1.69	42.66	Average	---	---
3	2372.000	45.22	-8.78	54.00	58.05	28.09	1.70	42.62	Average	---	---
1	4878.000	50.88	-23.12	74.00	59.42	33.36	2.51	44.41	Peak	---	---
2	4878.000	35.98	-18.02	54.00	44.52	33.36	2.51	44.41	Average	---	---

**(B) Polarization: Vertical**

	Freq	Level	Over Limit	Limit Line	Read Level	Probe Factor	Cable Loss	Preamp Factor	Remark	Ant Pos	Table Pos
	MHz	dBuV/m	dB	dBuV/m	dBuV	dB	dB	dB		cm	deg
1	1996.000	44.19	-9.81	54.00	58.28	27.10	1.51	42.70	Average	---	---
2	2212.000	44.90	-9.10	54.00	58.18	27.67	1.70	42.65	Average	---	---
3	2342.000	45.64	-8.36	54.00	58.57	28.01	1.69	42.63	Average	---	---
1	4876.000	52.23	-21.77	74.00	60.77	33.35	2.52	44.41	Peak	---	---
2	4876.000	40.22	-13.78	54.00	48.76	33.35	2.52	44.41	Average	---	---



<b>Modulation Type</b>	OFDM				
<b>Test Mode</b>	CH 11	<b>Temperature</b>	25 deg. C	<b>Tested By</b>	Steve Chen
<b>Freq. Range</b>	1GHz~25GHz	<b>Humidity</b>	63%		

**(A) Polarization: Horizontal**

	Freq	Level	Over Limit	Limit Line	Read Level	Probe Factor	Cable Loss	Preamp Factor	Remark	Ant Pos	Table Pos
	MHz	dBuV/m	dB	dBuV/m	dBuV	dB	dB	dB		cm	deg
1	1000.000	43.22	-10.78	54.00	60.71	23.80	1.11	42.40	Average	---	---
2	2204.000	44.42	-9.58	54.00	57.74	27.65	1.69	42.66	Average	---	---
3	2324.000	45.09	-8.91	54.00	58.03	27.97	1.72	42.63	Average	---	---

**(B) Polarization: Vertical**

	Freq	Level	Over Limit	Limit Line	Read Level	Probe Factor	Cable Loss	Preamp Factor	Remark	Ant Pos	Table Pos
	MHz	dBuV/m	dB	dBuV/m	dBuV	dB	dB	dB		cm	deg
1	1000.000	47.75	-6.25	54.00	65.24	23.80	1.11	42.40	Average	106	171
2	1998.000	43.70	-10.30	54.00	57.77	27.11	1.52	42.70	Average	---	---
3	2334.000	45.16	-8.84	54.00	58.10	27.99	1.70	42.63	Average	---	---
1	4924.000	42.76	-11.24	54.00	51.28	33.46	2.47	44.45	Average	---	---

### 5.6.5 Photographs of Radiated Emission Test Configuration

- The photographs show the configuration that generates the maximum emission.

FRONT VIEW



REAR VIEW

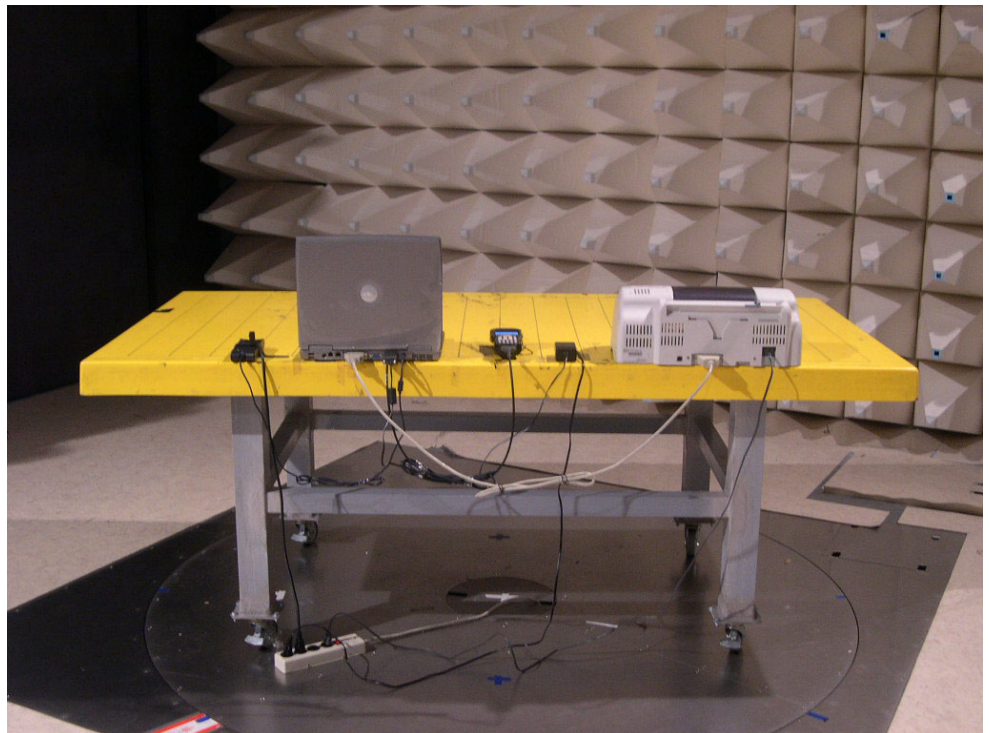



---

## 5.7. Antenna Requirements

### 5.7.1 Standard Applicable

47 CFR Part15 Section 15.203:

An intentional radiator shall be designed to ensure that no antenna other than that furnished by the responsible party shall be used with the device.

47 CFR Part15 Section 15.247 (b):

If transmitting antennas of directional gain greater than 6 dBi are used, the peak output power from the intentional radiator shall be reduced by the amount in dB that the directional gain of the antenna exceeds 6 dBi.

If the intentional radiator is used exclusively for fixed, point-to-point operations may employ transmitting antennas with directional gain greater than 6 dBi provided the maximum peak output power of the intentional radiator is reduced by 1 dB for every 3 dB that the directional gain of the antenna exceeds 6 dBi.

### 5.7.2 Antenna Connected Construction

The antenna used in this product is PIFA antenna, antenna connectoris Hirose (U.FL-R-SMT).



## 6. List of Measuring Equipments Used

Items	Instrument	Manufacturer	Model No.	Serial No.	Characteristics	Calibration Date	Remark
1	EMC Receiver	R&S	ESCS 30	100174	9 KHz – 2.75 GHz	Feb. 16, 2004	Conduction (CO04-HY)
2	LISN	MessTec	NNB-2/16Z	2001/004	9 KHz – 30 MHz	Jun. 09, 2004	Conduction (CO04-HY)
3	LISN (Support Unit)	MessTec	NNB-2/16Z	99041	9 KHz – 30 MHz	Apr. 27, 2004	Conduction (CO04-HY)
4	EMI Filter	LINDGREN	LRE-2030	2651	< 450 Hz	N/A	Conduction (CO04-HY)
5	RF Cable-CON	UTIFLEX	3102-26886-4	CB044	9KHz~30MHz	Apr. 21, 2004	Conduction (CO04-HY)
6	3m Semi Anechoic Chamber	SIDT FRANKONIA	SAC-3M	03CH03-HY	30MHz~1GHz 3m	Jun. 21, 2004	Radiation (03CH03-HY)
7	Spectrum analyzer	R&S	FSP30	100023	9KHZ~30GHz	Aug. 02, 2004	Radiation (03CH03-HY)
8	Amplifier	HP	8447D	2944A09072	100KHz – 1.3GHz	Nov. 05, 2003	Radiation (03CH03-HY)
9	Biconical Antenna	SCHWARZBECK	VHBB 9124	301	30MHz –200MHz	Jul. 28, 2004	Radiation (03CH03-HY)
10	Log Antenna	SCHWARZBECK	VUSLP 9111	221	200MHz -1GHz	Jul. 28, 2004	Radiation (03CH03-HY)
11	RF Cable-R03m	Jye Bao	RG142	CB021	30MHz~1GHz	Dec. 03, 2003	Radiation (03CH03-HY)
12	Amplifier	MITEQ	AFS44	849984	100MHz~26.5GHz	Mar. 26, 2004	Radiation (03CH03-HY)
13	Horn Antenna	EMCO	3115	6821	1GHz – 18GHz	Apr. 19, 2004	Radiation (03CH03-HY)
14	Turn Table	HD	DS 420	420/650/00	0 ~ 360 degree	N/A	Radiation (03CH03-HY)
15	Antenna Mast	HD	MA 240	240/560/00	1 m - 4 m	N/A	Radiation (03CH03-HY)
16	Horn Antenna	Schwarzbeck	BBHA9170	154	18GHz~40GHz	Jun. 09, 2004	Radiation (03CH03-HY)
17	RF Cable-HIGH	Jye Bao	RG142	CB030-HIGH	1GHz~29.5GHz	Dec. 05, 2003	Radiation (03CH03-HY)

※ Calibration Interval of instruments listed above is one year.



Items	Instrument	Manufacturer	Model No.	Serial No.	Characteristics	Calibration Date	Remark
18	Spectrum analyzer	R&S	FSP7	838858/014	9KHZ~7GHZ	Sep. 02, 2004	Conducted (TH01-HY)
19	Power meter	R&S	NRVS	100444	DC~40GHz	Jun. 15, 2004	Conducted (TH01-HY)
20	Power sensor	R&S	NRV-Z55	100049	DC~40GHz	Jun. 15, 2004	Conducted (TH01-HY)
21	Power Sensor	R&S	NRV-Z32	100057	30MHz-6GHz	Jun. 15, 2004	Conducted (TH01-HY)
22	AC power source	HPC	HPA-500W	HPA-9100024	AC 0~300V	Jun. 16, 2004	Conducted (TH01-HY)
23	AC power source	G.W.	GPC-6030D	C671845	DC 1V~60V	Nov. 06, 2003	Conducted (TH01-HY)
24	Temp. and Humidity Chamber	KSON	THS-C3L	612	N/A	Oct. 01, 2003	Conducted (TH01-HY)
25	RF CABLE-1m	Jye Bao	RG142	CB034-1m	20MHz~7GHz	Jan. 01, 2004	Conducted (TH01-HY)
26	RF CABLE-2m	Jye Bao	RG142	CB035-2m	20MHz~1GHz	Jan. 01, 2004	Conducted (TH01-HY)

※ Calibration Interval of instruments listed above is one year.