



VARIANT FCC SAR Test Report

Report No. : SA140609E04B R1
Applicant : Symbol Technologies, Inc.
Address : 1 Zebra Plaza Holtsville, NY 11742
Product : MC18 Personal Shopper - Barcode Scanner
FCC ID : H9PMC18N0
Brand : Symbol
Model No. : MC18N0
Standards : FCC 47 CFR Part 2 (2.1093) / IEEE C95.1:1992 / IEEE 1528:2003
 IEEE 1528a-2005 / KDB 865664 D01 v01r03 / KDB 865664 D02 v01r01
 KDB 248227 D01 v01r02 / KDB 447498 D01 v05r02
Sample Received Date : Jun. 09, 2014
Date of Testing : Jun. 28, 2014 ~ Jun. 29, 2014

CERTIFICATION: The above equipment have been tested by **Bureau Veritas Consumer Products Services (H.K.) Ltd., Taoyuan Branch – Lin Kou Laboratories**, and found compliance with the requirement of the above standards. The test record, data evaluation & Equipment Under Test (EUT) configurations represented herein are true and accurate accounts of the measurements of the sample’s SAR characteristics under the conditions specified in this report. It should not be reproduced except in full, without the written approval of our laboratory. The client should not use it to claim product certification, approval, or endorsement by TAF or any government agencies.

This is a duplicate report to the original report no.: SE140609E04. The difference compared with the original report is updating latest version standards. Due to 5G band 4 down power no effect on SAR test item, we did not re-test.

Prepared By : Evonne Liu
 Evonne Liu / Specialist
Approved By : Gordon Lin
 Gordon Lin / Assistant Manager



This report is for your exclusive use. Any copying or replication of this report to or for any other person or entity, or use of our name or trademark, is permitted only with our prior written permission. This report sets forth our findings solely with respect to the test samples identified herein. The results set forth in this report are not indicative or representative of the quality or characteristics of the lot from which a test sample was taken or any similar or identical product unless specifically and expressly noted. Our report includes all of the tests requested by you and the results thereof based upon the information that you provided to us. You have 60 days from date of issuance of this report to notify us of any material error or omission caused by our negligence, provided, however, that such notice shall be in writing and shall specifically address the issue you wish to raise. A failure to raise such issue within the prescribed time shall constitute your unqualified acceptance of the completeness of this report, the tests conducted and the correctness of the report contents. Unless specific mention, the uncertainty of measurement has been explicitly taken into account to declare the compliance or non-compliance to the specification.



Table of Contents

- Release Control Record 3
- 1. Summary of Maximum SAR Value 4
- 2. Description of Equipment Under Test 5
- 3. SAR Measurement System 6
 - 3.1 Definition of Specific Absorption Rate (SAR) 6
 - 3.2 SPEAG DASY System 6
 - 3.2.1 Robot..... 7
 - 3.2.2 Probes..... 8
 - 3.2.3 Data Acquisition Electronics (DAE) 8
 - 3.2.4 Phantoms 9
 - 3.2.5 Device Holder..... 10
 - 3.2.6 System Validation Dipoles 10
 - 3.2.7 Tissue Simulating Liquids..... 11
 - 3.3 SAR System Verification 14
 - 3.4 SAR Measurement Procedure 15
 - 3.4.1 Area & Zoom Scan Procedure 15
 - 3.4.2 Volume Scan Procedure..... 15
 - 3.4.3 Power Drift Monitoring..... 16
 - 3.4.4 Spatial Peak SAR Evaluation 16
 - 3.4.5 SAR Averaged Methods 16
- 4. SAR Measurement Evaluation 17
 - 4.1 EUT Configuration and Setting..... 17
 - 4.2 EUT Testing Position 17
 - 4.3 Tissue Verification 17
 - 4.4 System Validation..... 18
 - 4.5 System Verification..... 18
 - 4.6 Maximum Output Power..... 19
 - 4.6.1 Maximum Conducted Power 19
 - 4.6.2 Measured Conducted Power Result..... 19
 - 4.7 SAR Testing Results 20
 - 4.7.1 SAR Results for Body (Separation Distance is 1.0 cm Gap)..... 20
 - 4.7.2 SAR Results for Limbs (Separation Distance is 0 cm Gap)..... 21
 - 4.7.3 SAR Measurement Variability..... 22
- 5. Calibration of Test Equipment..... 23
- 6. Measurement Uncertainty 24
- 7. Information on the Testing Laboratories 26

Appendix A. SAR Plots of System Verification
 Appendix B. SAR Plots of SAR Measurement
 Appendix C. Calibration Certificate for Probe and Dipole
 Appendix D. Photographs of EUT and Setup



Release Control Record

Report No.	Reason for Change	Date Issued
SA140609E04B	Initial release	Mar. 23, 2015
SA140609E04B R1	Update applicant address	May 07, 2015



FCC SAR Test Report

1. Summary of Maximum SAR Value

Equipment Class	Mode	Highest Reported Body SAR _{1g} (1.0 cm Gap) (W/kg)	Highest Reported Limbs SAR _{10g} (0 cm Gap) (W/kg)
DTS	2.4G WLAN	0.10	0.16
NII	5.2G WLAN	1.24	1.29
	5.3G WLAN	1.42	1.73
	5.6G WLAN	1.21	1.28
	5.8G WLAN	1.19	0.81
DSS	Bluetooth	N/A	N/A

Note:

1. The SAR limit (**Body: SAR_{1g} 1.6 W/kg, Limbs: SAR_{10g} 4.0 W/kg**) for general population / uncontrolled exposure is specified in FCC 47 CFR part 2 (2.1093) and ANSI/IEEE C95.1-1992.



FCC SAR Test Report

2. Description of Equipment Under Test

EUT Type	MC18 Personal Shopper - Barcode Scanner
FCC ID	H9PMC18N0
Brand Name	Symbol
Model Name	MC18N0
HW Version	Terminal: MC18 MB V2.1 1-slot cradle: MC18_Easy_Swap_Cradle_V2.0 3-slot cradle: MC18_3-slot_Cradle_V2.1
SW Version	System: WinCE OS Name: Symbol MC18 OS version: 07.00.2824 OEM version: 99.45.10
Wireless (Fusion)	Part Number: 31-FUSION-X2.01 Fusion version: X_2.01.0.0.074R WLAN Firmware: X_2.01.0.0.180
XW2DMT (WLAN RF)	Version: X_2.01.0.0.3 Symbol version: X_2.01.0.0.171 WLAN Firmware: X_2.01.0.0.180
BTRegTest (WLAN BT)	Version: 4.1
Tx Frequency Bands (Unit: MHz)	WLAN : 2412 ~ 2462, 5180 ~ 5240, 5260 ~ 5320, 5500 ~ 5700, 5745 ~ 5825 Bluetooth : 2402 ~ 2480
Uplink Modulations	802.11b : DSSS 802.11a/g/n : OFDM Bluetooth : GFSK
Maximum Tune-up Conducted Power (Unit: dBm)	WLAN 2.4G : 18.11 WLAN 5.2G : 15.92 WLAN 5.3G : 17.91 WLAN 5.6G : 17.93 WLAN 5.8G : 17.69 Bluetooth : 1.98
Antenna Type	PIFA Antenna
EUT Stage	MASS-PRODUCTION sample

Note:

1. This is a duplicate report to the original report no.: SE140609E04. The difference compared with the original report is updating latest version standards. Due to 5G band 4 down power no effect on SAR test item, we did not re-test.
2. The above EUT information is declared by manufacturer and for more detailed features description please refers to the manufacturer's specifications or User's Manual.

List of Accessory:

Battery	Brand Name	Symbol
	Model Name	N/A
	Power Rating	3.7Vdc, 2725mAh, 10.08Wh
	Type	Li-ion

3. SAR Measurement System

3.1 Definition of Specific Absorption Rate (SAR)

SAR is related to the rate at which energy is absorbed per unit mass in an object exposed to a radio field. The SAR distribution in a biological body is complicated and is usually carried out by experimental techniques or numerical modeling. The standard recommends limits for two tiers of groups, occupational/controlled and general population/uncontrolled, based on a person's awareness and ability to exercise control over his or her exposure. In general, occupational/controlled exposure limits are higher than the limits for general population/uncontrolled.

The SAR definition is the time derivative (rate) of the incremental energy (dW) absorbed by (dissipated in) an incremental mass (dm) contained in a volume element (dv) of a given density (ρ). The equation description is as below:

$$\text{SAR} = \frac{d}{dt} \left(\frac{dW}{dm} \right) = \frac{d}{dt} \left(\frac{dW}{\rho dv} \right)$$

SAR is expressed in units of Watts per kilogram (W/kg)

SAR measurement can be related to the electrical field in the tissue by

$$\text{SAR} = \frac{\sigma |E|^2}{\rho}$$

Where: σ is the conductivity of the tissue, ρ is the mass density of the tissue and E is the RMS electrical field strength.

3.2 SPEAG DASY System

DASY system consists of high precision robot, probe alignment sensor, phantom, robot controller, controlled measurement server and near-field probe. The robot includes six axes that can move to the precision position of the DASY4/5 software defined. The DASY software can define the area that is detected by the probe. The robot is connected to controlled box. Controlled measurement server is connected to the controlled robot box. The DAE includes amplifier, signal multiplexing, AD converter, offset measurement and surface detection. It is connected to the Electro-optical coupler (ECO). The ECO performs the conversion from the optical into digital electric signal of the DAE and transfers data to the PC.

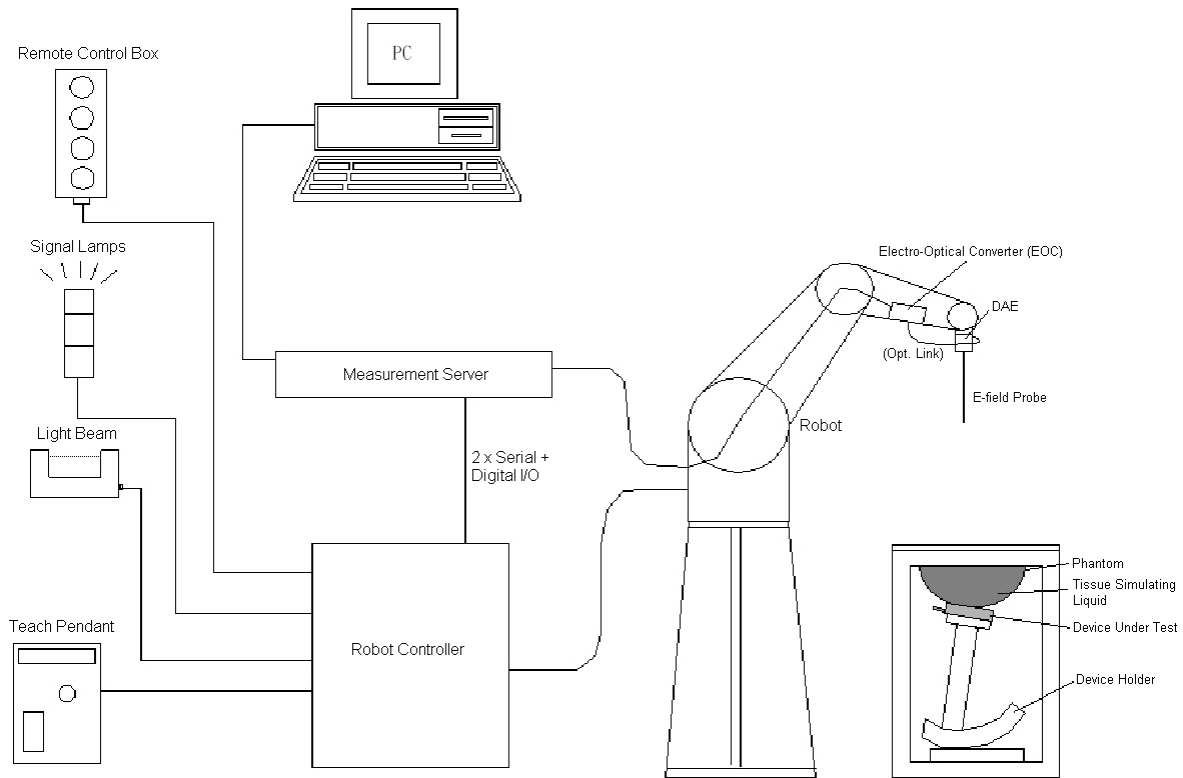

Fig-3.1 DASY System Setup

3.2.1 Robot

The DASY system uses the high precision robots from Stäubli SA (France). For the 6-axis controller system, the robot controller version (DASY4: CS7MB; DASY5: CS8c) from Stäubli is used. The Stäubli robot series have many features that are important for our application:

- High precision (repeatability ± 0.035 mm)
- High reliability (industrial design)
- Jerk-free straight movements
- Low ELF interference (the closed metallic construction shields against motor control fields)



Fig-3.2 DASY4





Fig-3.3 DASY5

FCC SAR Test Report

3.2.2 Probes

The SAR measurement is conducted with the dosimetric probe. The probe is specially designed and calibrated for use in liquid with high permittivity. The dosimetric probe has special calibration in liquid at different frequency.

Model	EX3DV4	
Construction	Symmetrical design with triangular core. Built-in shielding against static charges. PEEK enclosure material (resistant to organic solvents, e.g., DGBE).	
Frequency	10 MHz to 6 GHz Linearity: ± 0.2 dB	
Directivity	± 0.3 dB in HSL (rotation around probe axis) ± 0.5 dB in tissue material (rotation normal to probe axis)	
Dynamic Range	10 μ W/g to 100 mW/g Linearity: ± 0.2 dB (noise: typically < 1 μ W/g)	
Dimensions	Overall length: 337 mm (Tip: 20 mm) Tip diameter: 2.5 mm (Body: 12 mm) Typical distance from probe tip to dipole centers: 1 mm	

Model	ES3DV3	
Construction	Symmetrical design with triangular core. Interleaved sensors. Built-in shielding against static charges. PEEK enclosure material (resistant to organic solvents, e.g., DGBE).	
Frequency	10 MHz to 4 GHz Linearity: ± 0.2 dB	
Directivity	± 0.2 dB in HSL (rotation around probe axis) ± 0.3 dB in tissue material (rotation normal to probe axis)	
Dynamic Range	5 μ W/g to 100 mW/g Linearity: ± 0.2 dB	
Dimensions	Overall length: 337 mm (Tip: 20 mm) Tip diameter: 3.9 mm (Body: 12 mm) Distance from probe tip to dipole centers: 2.0 mm	

3.2.3 Data Acquisition Electronics (DAE)

Model	DAE3, DAE4	
Construction	Signal amplifier, multiplexer, A/D converter and control logic. Serial optical link for communication with DASY embedded system (fully remote controlled). Two step probe touch detector for mechanical surface detection and emergency robot stop.	
Measurement Range	-100 to +300 mV (16 bit resolution and two range settings: 4mV, 400mV)	
Input Offset Voltage	< 5 μ V (with auto zero)	
Input Bias Current	< 50 fA	
Dimensions	60 x 60 x 68 mm	

FCC SAR Test Report

3.2.4 Phantoms

Model	Twin SAM	
Construction	The shell corresponds to the specifications of the Specific Anthropomorphic Mannequin (SAM) phantom defined in IEEE 1528 and IEC 62209-1. It enables the dosimetric evaluation of left and right hand phone usage as well as body mounted usage at the flat phantom region. A cover prevents evaporation of the liquid. Reference markings on the phantom allow the complete setup of all predefined phantom positions and measurement grids by teaching three points with the robot.	
Material	Vinylester, glass fiber reinforced (VE-GF)	
Shell Thickness	2 ± 0.2 mm (6 ± 0.2 mm at ear point)	
Dimensions	Length: 1000 mm Width: 500 mm Height: adjustable feet	
Filling Volume	approx. 25 liters	

Model	ELI	
Construction	Phantom for compliance testing of handheld and body-mounted wireless devices in the frequency range of 30 MHz to 6 GHz. ELI is fully compatible with the IEC 62209-2 standard and all known tissue simulating liquids. ELI has been optimized regarding its performance and can be integrated into our standard phantom tables. A cover prevents evaporation of the liquid. Reference markings on the phantom allow installation of the complete setup, including all predefined phantom positions and measurement grids, by teaching three points. The phantom is compatible with all SPEAG dosimetric probes and dipoles.	
Material	Vinylester, glass fiber reinforced (VE-GF)	
Shell Thickness	2.0 ± 0.2 mm (bottom plate)	
Dimensions	Major axis: 600 mm Minor axis: 400 mm	
Filling Volume	approx. 30 liters	

FCC SAR Test Report

3.2.5 Device Holder

Model	Mounting Device	
Construction	In combination with the Twin SAM Phantom or ELI4, the Mounting Device enables the rotation of the mounted transmitter device in spherical coordinates. Rotation point is the ear opening point. Transmitter devices can be easily and accurately positioned according to IEC, IEEE, FCC or other specifications. The device holder can be locked for positioning at different phantom sections (left head, right head, flat).	
Material	POM	

Model	Laptop Extensions Kit	
Construction	Simple but effective and easy-to-use extension for Mounting Device that facilitates the testing of larger devices according to IEC 62209-2 (e.g., laptops, cameras, etc.). It is lightweight and fits easily on the upper part of the Mounting Device in place of the phone positioner.	
Material	POM, Acrylic glass, Foam	

3.2.6 System Validation Dipoles

Model	D-Serial	
Construction	Symmetrical dipole with 1/4 balun. Enables measurement of feed point impedance with NWA. Matched for use near flat phantoms filled with tissue simulating solutions.	
Frequency	750 MHz to 5800 MHz	
Return Loss	> 20 dB	
Power Capability	> 100 W (f < 1GHz), > 40 W (f > 1GHz)	

FCC SAR Test Report

3.2.7 Tissue Simulating Liquids

For SAR measurement of the field distribution inside the phantom, the phantom must be filled with homogeneous tissue simulating liquid to a depth of at least 15 cm. For head SAR testing, the liquid height from the ear reference point (ERP) of the phantom to the liquid top surface is larger than 15 cm. For body SAR testing, the liquid height from the center of the flat phantom to the liquid top surface is larger than 15 cm. The nominal dielectric values of the tissue simulating liquids in the phantom and the tolerance of 5% are listed in Table-3.1.

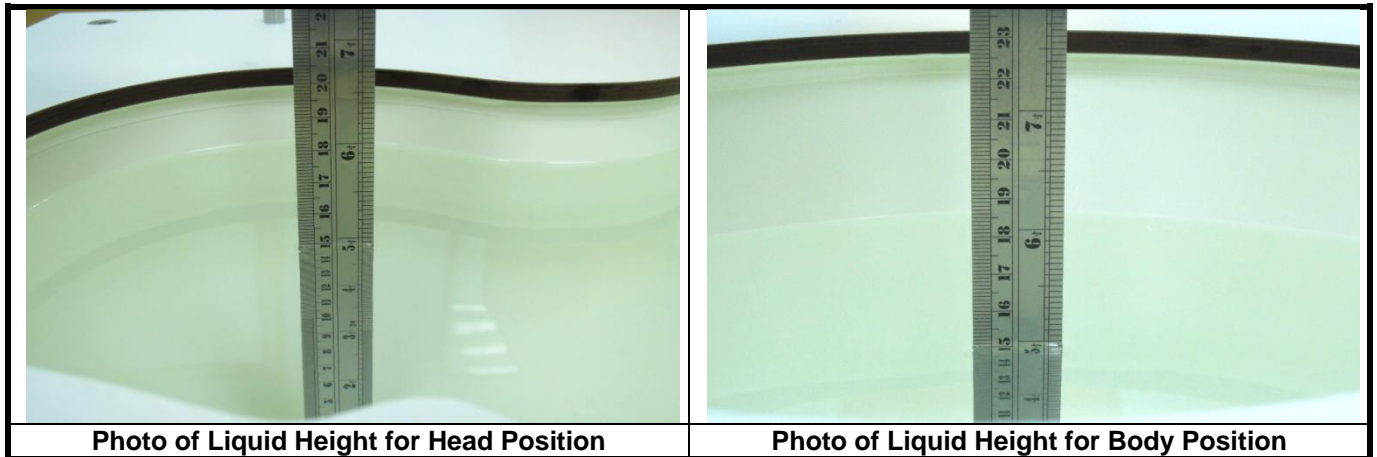

The dielectric properties of the head tissue simulating liquids are defined in IEEE 1528, and KDB 865664 D01 Appendix A. For the body tissue simulating liquids, the dielectric properties are defined in KDB 865664 D01 Appendix A. The dielectric properties of the tissue simulating liquids were verified prior to the SAR evaluation using an Agilent 85070D Dielectric Probe Kit and an Agilent Network Analyzer.



FCC SAR Test Report

Table-3.1 Targets of Tissue Simulating Liquid

Frequency (MHz)	Target Permittivity	Range of $\pm 5\%$	Target Conductivity	Range of $\pm 5\%$
For Head				
750	41.9	39.8 ~ 44.0	0.89	0.85 ~ 0.93
835	41.5	39.4 ~ 43.6	0.90	0.86 ~ 0.95
900	41.5	39.4 ~ 43.6	0.97	0.92 ~ 1.02
1450	40.5	38.5 ~ 42.5	1.20	1.14 ~ 1.26
1640	40.3	38.3 ~ 42.3	1.29	1.23 ~ 1.35
1750	40.1	38.1 ~ 42.1	1.37	1.30 ~ 1.44
1800	40.0	38.0 ~ 42.0	1.40	1.33 ~ 1.47
1900	40.0	38.0 ~ 42.0	1.40	1.33 ~ 1.47
2000	40.0	38.0 ~ 42.0	1.40	1.33 ~ 1.47
2300	39.5	37.5 ~ 41.5	1.67	1.59 ~ 1.75
2450	39.2	37.2 ~ 41.2	1.80	1.71 ~ 1.89
2600	39.0	37.1 ~ 41.0	1.96	1.86 ~ 2.06
3500	37.9	36.0 ~ 39.8	2.91	2.76 ~ 3.06
5200	36.0	34.2 ~ 37.8	4.66	4.43 ~ 4.89
5300	35.9	34.1 ~ 37.7	4.76	4.52 ~ 5.00
5500	35.6	33.8 ~ 37.4	4.96	4.71 ~ 5.21
5600	35.5	33.7 ~ 37.3	5.07	4.82 ~ 5.32
5800	35.3	33.5 ~ 37.1	5.27	5.01 ~ 5.53
For Body				
750	55.5	52.7 ~ 58.3	0.96	0.91 ~ 1.01
835	55.2	52.4 ~ 58.0	0.97	0.92 ~ 1.02
900	55.0	52.3 ~ 57.8	1.05	1.00 ~ 1.10
1450	54.0	51.3 ~ 56.7	1.30	1.24 ~ 1.37
1640	53.8	51.1 ~ 56.5	1.40	1.33 ~ 1.47
1750	53.4	50.7 ~ 56.1	1.49	1.42 ~ 1.56
1800	53.3	50.6 ~ 56.0	1.52	1.44 ~ 1.60
1900	53.3	50.6 ~ 56.0	1.52	1.44 ~ 1.60
2000	53.3	50.6 ~ 56.0	1.52	1.44 ~ 1.60
2300	52.9	50.3 ~ 55.5	1.81	1.72 ~ 1.90
2450	52.7	50.1 ~ 55.3	1.95	1.85 ~ 2.05
2600	52.5	49.9 ~ 55.1	2.16	2.05 ~ 2.27
3500	51.3	48.7 ~ 53.9	3.31	3.14 ~ 3.48
5200	49.0	46.6 ~ 51.5	5.30	5.04 ~ 5.57
5300	48.9	46.5 ~ 51.3	5.42	5.15 ~ 5.69
5500	48.6	46.2 ~ 51.0	5.65	5.37 ~ 5.93
5600	48.5	46.1 ~ 50.9	5.77	5.48 ~ 6.06
5800	48.2	45.8 ~ 50.6	6.00	5.70 ~ 6.30



FCC SAR Test Report

The following table gives the recipes for tissue simulating liquids.

Table-3.2 Recipes of Tissue Simulating Liquid

Tissue Type	Bactericide	DGBE	HEC	NaCl	Sucrose	Triton X-100	Water	Diethylene Glycol Mono-hexylether
H750	0.2	-	0.2	1.5	56.0	-	42.1	-
H835	0.2	-	0.2	1.5	57.0	-	41.1	-
H900	0.2	-	0.2	1.4	58.0	-	40.2	-
H1450	-	43.3	-	0.6	-	-	56.1	-
H1640	-	45.8	-	0.5	-	-	53.7	-
H1750	-	47.0	-	0.4	-	-	52.6	-
H1800	-	44.5	-	0.3	-	-	55.2	-
H1900	-	44.5	-	0.2	-	-	55.3	-
H2000	-	44.5	-	0.1	-	-	55.4	-
H2300	-	44.9	-	0.1	-	-	55.0	-
H2450	-	45.0	-	0.1	-	-	54.9	-
H2600	-	45.1	-	0.1	-	-	54.8	-
H3500	-	8.0	-	0.2	-	20.0	71.8	-
H5G	-	-	-	-	-	17.2	65.5	17.3
B750	0.2	-	0.2	0.8	48.8	-	50.0	-
B835	0.2	-	0.2	0.9	48.5	-	50.2	-
B900	0.2	-	0.2	0.9	48.2	-	50.5	-
B1450	-	34.0	-	0.3	-	-	65.7	-
B1640	-	32.5	-	0.3	-	-	67.2	-
B1750	-	31.0	-	0.2	-	-	68.8	-
B1800	-	29.5	-	0.4	-	-	70.1	-
B1900	-	29.5	-	0.3	-	-	70.2	-
B2000	-	30.0	-	0.2	-	-	69.8	-
B2300	-	31.0	-	0.1	-	-	68.9	-
B2450	-	31.4	-	0.1	-	-	68.5	-
B2600	-	31.8	-	0.1	-	-	68.1	-
B3500	-	28.8	-	0.1	-	-	71.1	-
B5G	-	-	-	-	-	10.7	78.6	10.7

3.3 SAR System Verification

The system check verifies that the system operates within its specifications. It is performed daily or before every SAR measurement. The system check uses normal SAR measurements in the flat section of the phantom with a matched dipole at a specified distance. The system verification setup is shown as below.

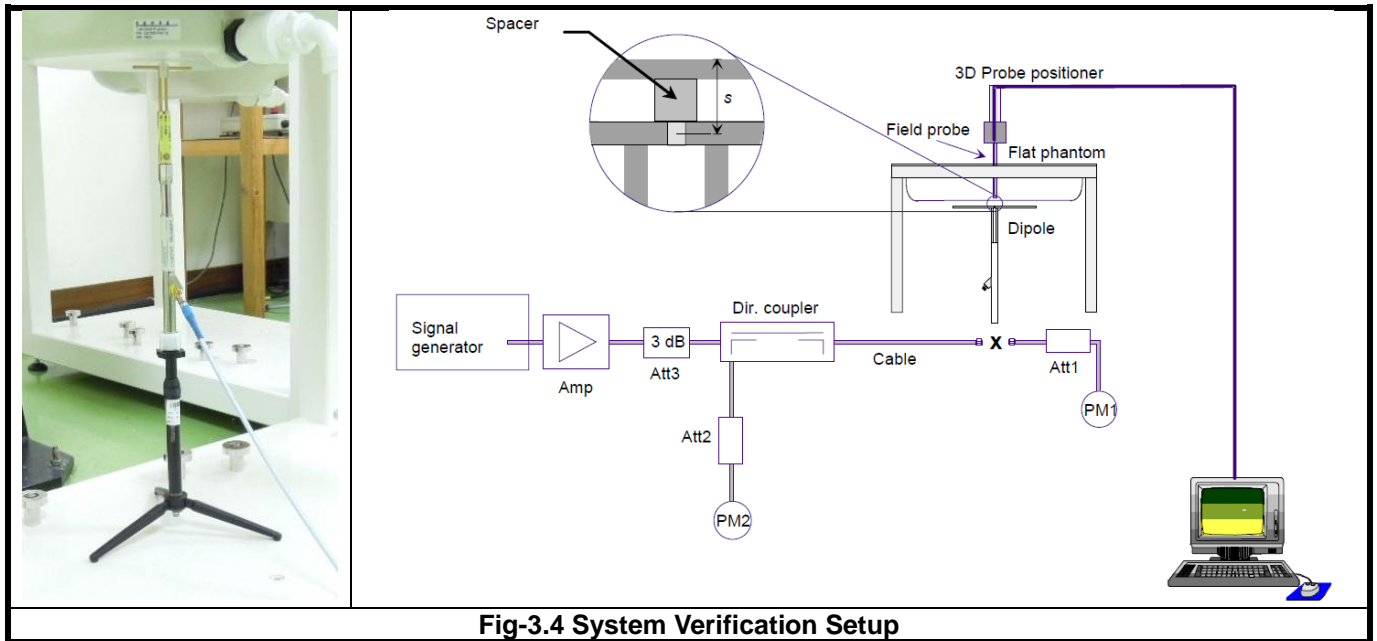

Fig-3.4 System Verification Setup

The validation dipole is placed beneath the flat phantom with the specific spacer in place. The distance spacer is touch the phantom surface with a light pressure at the reference marking and be oriented parallel to the long side of the phantom. The power meter PM1 measures the forward power at the location of the system check dipole connector. The signal generator is adjusted for the desired forward power (250 mW is used for 700 MHz to 3 GHz, 100 mW is used for 3.5 GHz to 6 GHz) at the dipole connector and the power meter PM2 is read at that level. After connecting the cable to the dipole, the signal generator is readjusted for the same reading at power meter PM2.

After system check testing, the SAR result will be normalized to 1W forward input power and compared with the reference SAR value derived from validation dipole certificate report. The deviation of system check should be within 10 %.

3.4 SAR Measurement Procedure

According to the SAR test standard, the recommended procedure for assessing the peak spatial-average SAR value consists of the following steps:

- (a) Power reference measurement
- (b) Area scan
- (c) Zoom scan
- (d) Power drift measurement

The SAR measurement procedures for each of test conditions are as follows:

- (a) Make EUT to transmit maximum output power
- (b) Measure conducted output power through RF cable
- (c) Place the EUT in the specific position of phantom
- (d) Perform SAR testing steps on the DASY system
- (e) Record the SAR value

3.4.1 Area & Zoom Scan Procedure

First Area Scan is used to locate the approximate location(s) of the local peak SAR value(s). The measurement grid within an Area Scan is defined by the grid extent, grid step size and grid offset. Next, in order to determine the EM field distribution in a three-dimensional spatial extension, Zoom Scan is required. The Zoom Scan is performed around the highest E-field value to determine the averaged SAR-distribution over 10 g. According to KDB 865664 D01, the resolution for Area and Zoom scan is specified in the table below.

Items	<= 2 GHz	2-3 GHz	3-4 GHz	4-5 GHz	5-6 GHz
Area Scan ($\Delta x, \Delta y$)	<= 15 mm	<= 12 mm	<= 12 mm	<= 10 mm	<= 10 mm
Zoom Scan ($\Delta x, \Delta y$)	<= 8 mm	<= 5 mm	<= 5 mm	<= 4 mm	<= 4 mm
Zoom Scan (Δz)	<= 5 mm	<= 5 mm	<= 4 mm	<= 3 mm	<= 2 mm
Zoom Scan Volume	>= 30 mm	>= 30 mm	>= 28 mm	>= 25 mm	>= 22 mm

Note:

When zoom scan is required and report SAR is <= 1.4 W/kg, the zoom scan resolution of $\Delta x / \Delta y$ (2-3GHz: <= 8 mm, 3-4GHz: <= 7 mm, 4-6GHz: <= 5 mm) may be applied.

3.4.2 Volume Scan Procedure

The volume scan is used for assess overlapping SAR distributions for antennas transmitting in different frequency bands. It is equivalent to an oversized zoom scan used in standalone measurements. The measurement volume will be used to enclose all the simultaneous transmitting antennas. For antennas transmitting simultaneously in different frequency bands, the volume scan is measured separately in each frequency band. In order to sum correctly to compute the 1g aggregate SAR, the EUT remain in the same test position for all measurements and all volume scan use the same spatial resolution and grid spacing. When all volume scan were completed, the software, SEMCAD postprocessor can combine and subsequently superpose these measurement data to calculating the multiband SAR.

FCC SAR Test Report

3.4.3 Power Drift Monitoring

All SAR testing is under the EUT install full charged battery and transmit maximum output power. In DASY measurement software, the power reference measurement and power drift measurement procedures are used for monitoring the power drift of EUT during SAR test. Both these procedures measure the field at a specified reference position before and after the SAR testing. The software will calculate the field difference in dB. If the power drift more than 5%, the SAR will be retested.

3.4.4 Spatial Peak SAR Evaluation

The procedure for spatial peak SAR evaluation has been implemented according to the test standard. It can be conducted for 1g and 10g, as well as for user-specific masses. The DASY software includes all numerical procedures necessary to evaluate the spatial peak SAR value.

The base for the evaluation is a "cube" measurement. The measured volume must include the 1g and 10g cubes with the highest averaged SAR values. For that purpose, the center of the measured volume is aligned to the interpolated peak SAR value of a previously performed area scan.

The entire evaluation of the spatial peak values is performed within the post-processing engine (SEMCAD). The system always gives the maximum values for the 1g and 10g cubes. The algorithm to find the cube with highest averaged SAR is divided into the following stages:

- (a) Extraction of the measured data (grid and values) from the Zoom Scan
- (b) Calculation of the SAR value at every measurement point based on all stored data (A/D values and measurement parameters)
- (c) Generation of a high-resolution mesh within the measured volume
- (d) Interpolation of all measured values from the measurement grid to the high-resolution grid
- (e) Extrapolation of the entire 3-D field distribution to the phantom surface over the distance from sensor to surface
- (f) Calculation of the averaged SAR within masses of 1g and 10g

3.4.5 SAR Averaged Methods

In DASY, the interpolation and extrapolation are both based on the modified Quadratic Shepard's method. The interpolation scheme combines a least-square fitted function method and a weighted average method which are the two basic types of computational interpolation and approximation.

Extrapolation routines are used to obtain SAR values between the lowest measurement points and the inner phantom surface. The extrapolation distance is determined by the surface detection distance and the probe sensor offset. The uncertainty increases with the extrapolation distance. To keep the uncertainty within 1% for the 1 g and 10 g cubes, the extrapolation distance should not be larger than 5 mm.

4. SAR Measurement Evaluation

4.1 EUT Configuration and Setting

For WLAN SAR testing, the EUT has installed WLAN engineering testing software which can provide continuous transmitting RF signal. According to KDB 248227 D01, WLAN SAR should be tested at the lowest data rate, and testing at higher data rate is not required when the maximum average output power is less than 1/4 dB higher than those measured at the lowest data rate. Since the WLAN power at lowest data rate has highest output power, WLAN SAR for this device was performed at the lowest data rate.

4.2 EUT Testing Position

This hand-held device was tested on the body and limbs exposure conditions. Body SAR was tested on the front face and antenna side (the edge closest to transmitting antenna) with 1 cm separation distance. Limbs SAR was tested on antenna side without separation distance.

According to KDB 447498 D01, the SAR test exclusion condition is based on source-based time-averaged maximum conducted output power, adjusted for tune-up tolerance, and the minimum test separation distance required for the exposure conditions. The SAR exclusion threshold is determined by the following formula.

$$\frac{\text{Max. Tune up Power}_{(mW)}}{\text{Min. Test Separation Distance}_{(mm)}} \times \sqrt{f_{(GHz)}} \leq 3.0 \text{ for SAR-1g, } \leq 7.5 \text{ for SAR-10g}$$

When the minimum test separation distance is < 5 mm, a distance of 5 mm is applied to determine SAR test exclusion.

Mode	Max. Tune-up Power (dBm)	Max. Tune-up Power (mW)	Body			Limbs		
			Ant. to Surface (mm)	Calculated Result	Require SAR Testing?	Ant. to Surface (mm)	Calculated Result	Require SAR Testing?
BT (2.48 GHz)	1.98	2	10	0.3	No	0	0.6	No

4.3 Tissue Verification

The measuring results for tissue simulating liquid are shown as below.

Test Date	Tissue Type	Frequency (MHz)	Liquid Temp. (°C)	Measured Conductivity (σ)	Measured Permittivity (ε _r)	Target Conductivity (σ)	Target Permittivity (ε _r)	Conductivity Deviation (%)	Permittivity Deviation (%)
Jun. 29, 2014	Body	2450	21.3	1.989	51.463	1.95	52.7	2.00	-2.35
Jun. 28, 2014	Body	5200	21.1	5.399	47.771	5.30	49.0	1.87	-2.51
Jun. 28, 2014	Body	5300	21.1	5.542	47.565	5.42	48.9	2.25	-2.73
Jun. 28, 2014	Body	5600	21.1	5.960	46.959	5.77	48.5	3.29	-3.18
Jun. 28, 2014	Body	5800	21.1	6.237	46.574	6.00	48.2	3.95	-3.37

Note:

The dielectric properties of the tissue simulating liquid must be measured within 24 hours before the SAR testing and within ±5% of the target values. Liquid temperature during the SAR testing must be within ±2 °C.

4.4 System Validation

The SAR measurement system was validated according to procedures in KDB 865664 D01. The validation status in tabulated summary is as below.

Test Date	Probe S/N	Calibration Point		Measured Conductivity (σ)	Measured Permittivity (ϵ_r)	Validation for CW			Validation for Modulation		
						Sensitivity Range	Probe Linearity	Probe Isotropy	Modulation Type	Duty Factor	PAR
Jun. 29, 2014	3590	Body	2450	1.989	51.463	Pass	Pass	Pass	OFDM	N/A	Pass
Jun. 28, 2014	3971	Body	5200	5.399	47.771	Pass	Pass	Pass	OFDM	N/A	Pass
Jun. 28, 2014	3971	Body	5300	5.542	47.565	Pass	Pass	Pass	OFDM	N/A	Pass
Jun. 28, 2014	3971	Body	5600	5.960	46.959	Pass	Pass	Pass	OFDM	N/A	Pass
Jun. 28, 2014	3971	Body	5800	6.237	46.574	Pass	Pass	Pass	OFDM	N/A	Pass
Jun. 29, 2014	3590	Body	2450	1.989	51.463	Pass	Pass	Pass	OFDM	N/A	Pass
Jun. 28, 2014	3820	Body	5200	5.399	47.771	Pass	Pass	Pass	OFDM	N/A	Pass
Jun. 28, 2014	3820	Body	5300	5.542	47.565	Pass	Pass	Pass	OFDM	N/A	Pass
Jun. 28, 2014	3820	Body	5600	5.960	46.959	Pass	Pass	Pass	OFDM	N/A	Pass
Jun. 28, 2014	3820	Body	5800	6.237	46.574	Pass	Pass	Pass	OFDM	N/A	Pass

4.5 System Verification

The measuring result for system verification is tabulated as below.

Test Date	Mode	Frequency (MHz)	1W Target SAR-1g (W/kg)	Measured SAR-1g (W/kg)	Normalized to 1W SAR-1g (W/kg)	Deviation (%)	Dipole S/N	Probe S/N	DAE S/N
Jun. 29, 2014	Body	2450	50.00	13.2	52.80	5.60	716	3590	579
Jun. 28, 2014	Body	5200	74.90	7.80	78.00	4.14	1018	3971	861
Jun. 28, 2014	Body	5300	75.70	7.76	77.60	2.51	1018	3971	861
Jun. 28, 2014	Body	5600	80.40	7.95	79.50	-1.12	1018	3971	861
Jun. 28, 2014	Body	5800	74.90	7.91	79.10	5.61	1018	3971	861

Test Date	Mode	Frequency (MHz)	1W Target SAR-10g (W/kg)	Measured SAR-10g (W/kg)	Normalized to 1W SAR-10g (W/kg)	Deviation (%)	Dipole S/N	Probe S/N	DAE S/N
Jun. 29, 2014	Body	2450	23.40	6.03	24.12	3.08	716	3590	579
Jun. 28, 2014	Body	5200	21.00	2.04	20.40	-2.86	1018	3820	1431
Jun. 28, 2014	Body	5300	21.30	2.12	21.20	-0.47	1018	3820	1431
Jun. 28, 2014	Body	5600	22.40	2.21	22.10	-1.34	1018	3820	1431
Jun. 28, 2014	Body	5800	20.80	2.00	20.00	-3.85	1018	3820	1431

Note:

Comparing to the reference SAR value provided by SPEAG, the validation data should be within its specification of 10 %. The result indicates the system check can meet the variation criterion and the plots can be referred to Appendix A of this report.

FCC SAR Test Report

4.6 Maximum Output Power

4.6.1 Maximum Conducted Power

The maximum conducted average power (Unit: dBm) including tune-up tolerance is shown as below.

Mode	2.4G WLAN	5.2G WLAN	5.3G WLAN	5.6G WLAN	5.8G WLAN
802.11b	18.11	N/A	N/A	N/A	N/A
802.11g	17.78	N/A	N/A	N/A	N/A
802.11a	N/A	15.92	17.91	17.87	17.68
802.11n HT20	17.87	15.86	17.81	17.93	17.69

Mode	Bluetooth
All	1.98

4.6.2 Measured Conducted Power Result

The measuring conducted average power (Unit: dBm) is shown as below.

<WLAN 2.4G>

Mode	802.11b		
Channel / Frequency (MHz)	1 (2412)	6 (2437)	11 (2462)
Average Power	18.05	18.11	18.07
Mode	802.11g		
Channel / Frequency (MHz)	1 (2412)	6 (2437)	11 (2462)
Average Power	15.20	17.78	15.84
Mode	802.11n (HT20)		
Channel / Frequency (MHz)	1 (2412)	6 (2437)	11 (2462)
Average Power	14.80	17.87	15.99

<WLAN 5.2G>

Mode	802.11a			
Channel / Frequency (MHz)	36 (5180)	40 (5200)	44 (5220)	48 (5240)
Average Power	15.83	15.81	15.92	15.83
Mode	802.11n (HT20)			
Channel / Frequency (MHz)	36 (5180)	40 (5200)	44 (5220)	48 (5240)
Average Power	15.82	15.86	15.76	15.72

<WLAN 5.3G>

Mode	802.11a			
Channel / Frequency (MHz)	52 (5260)	56 (5280)	60 (5300)	64 (5320)
Average Power	17.87	17.84	17.91	16.21
Mode	802.11n (HT20)			
Channel / Frequency (MHz)	52 (5260)	56 (5280)	60 (5300)	64 (5320)
Average Power	17.81	17.73	17.76	16.08

<WLAN 5.6G>

Mode	802.11a							
Channel / Frequency (MHz)	100 (5500)	104 (5520)	108 (5540)	112 (5560)	116 (5580)	132 (5660)	136 (5680)	140 (5700)
Average Power	17.02	17.72	17.81	17.74	17.78	17.72	17.87	15.83
Mode	802.11n (HT20)							
Channel / Frequency (MHz)	100 (5500)	104 (5520)	108 (5540)	112 (5560)	116 (5580)	132 (5660)	136 (5680)	140 (5700)
Average Power	16.41	17.82	17.83	17.76	17.93	17.53	17.73	15.76

<WLAN 5.8G>

Mode	802.11a				
Channel / Frequency (MHz)	149 (5745)	153 (5765)	157 (5785)	161 (5805)	165 (5825)
Average Power	17.68	17.61	17.63	17.46	17.32
Mode	802.11n (HT20)				
Channel / Frequency (MHz)	149 (5745)	153 (5765)	157 (5785)	161 (5805)	165 (5825)
Average Power	17.62	17.58	17.64	17.63	17.69

4.7 SAR Testing Results

4.7.1 SAR Results for Body (Separation Distance is 1.0 cm Gap)

Plot No.	Band	Mode	Test Position	Ch.	Max. Tune-up Power (dBm)	Measured Conducted Power (dBm)	Scaling Factor	Power Drift (dB)	Measured SAR-1g (W/kg)	Scaled SAR-1g (W/kg)
01	802.11b	-	Front Face	6	18.11	18.11	1.00	-0.03	0.074	0.07
	802.11b	-	ANT Side	6	18.11	18.11	1.00	0.06	0.096	0.10
	802.11n	HT20	ANT Side	6	17.87	17.87	1.00	0.11	0.051	0.05
02	802.11a	-	Front Face	44	15.92	15.92	1.00	-0.08	0.37	0.37
	802.11a	-	ANT Side	44	15.92	15.92	1.00	0.04	1.01	1.01
	802.11a	-	ANT Side	36	15.92	15.83	1.02	0.08	0.849	0.87
	802.11n	HT20	ANT Side	40	15.86	15.86	1.00	0.06	1.05	1.05
	802.11n	HT20	ANT Side	44	15.86	15.76	1.02	0.01	1.21	1.24
03	802.11n	HT20	ANT Side	44	15.86	15.76	1.02	0.07	1.18	1.21
	802.11a	-	Front Face	60	17.91	17.91	1.00	-0.13	0.479	0.48
	802.11a	-	ANT Side	60	17.91	17.91	1.00	-0.04	1.42	1.42
	802.11a	-	ANT Side	52	17.91	17.87	1.01	-0.07	1.31	1.32
	802.11n	HT20	ANT Side	52	17.81	17.81	1.00	0.07	1.09	1.09
	802.11n	HT20	ANT Side	60	17.81	17.76	1.01	-0.07	1.34	1.36
	802.11a	-	ANT Side	60	17.91	17.91	1.00	-0.06	1.41	1.41

Note:

1. According to KDB 248227, when the extrapolated maximum peak SAR for the maximum output power channel is ≤ 1.6 W/kg and the 1g averaged SAR is ≤ 0.8 W/kg, WLAN SAR testing for other channels is not required.
2. SAR testing for 802.11g is not required when its maximum power is less than 1/4 dB higher than 802.11b.

Plot No.	Band	Mode	Test Position	Ch.	Max. Tune-up Power (dBm)	Measured Conducted Power (dBm)	Scaling Factor	Power Drift (dB)	Measured SAR-1g (W/kg)	Scaled SAR-1g (W/kg)
	802.11a	-	Front Face	136	17.87	17.87	1.00	-0.02	0.443	0.44
	802.11a	-	ANT Side	136	17.87	17.87	1.00	0.01	1.17	1.17
04	802.11a	-	ANT Side	108	17.87	17.81	1.01	0.07	1.19	1.21
	802.11a	-	ANT Side	116	17.87	17.78	1.02	-0.05	1.13	1.15
	802.11n	HT20	ANT Side	116	17.93	17.93	1.00	-0.04	1.12	1.12
	802.11n	HT20	ANT Side	108	17.93	17.83	1.02	0.03	1.17	1.20
	802.11n	HT20	ANT Side	136	17.93	17.73	1.05	0.03	1.09	1.14
	802.11a	-	ANT Side	108	17.87	17.81	1.01	0.06	1.15	1.17
	802.11a	-	Front Face	149	17.68	17.68	1.00	-0.02	0.403	0.40
	802.11a	-	ANT Side	149	17.68	17.68	1.00	0.09	0.975	0.98
	802.11a	-	ANT Side	157	17.68	17.63	1.01	-0.08	0.901	0.91
	802.11a	-	ANT Side	161	17.68	17.46	1.05	-0.04	1.09	1.15
	802.11n	HT20	ANT Side	165	17.69	17.69	1.00	-0.04	0.866	0.87
05	802.11n	HT20	ANT Side	149	17.69	17.62	1.02	0.07	1.17	1.19
	802.11n	HT20	ANT Side	157	17.69	17.64	1.01	-0.09	1.04	1.05
	802.11n	HT20	ANT Side	149	17.69	17.62	1.02	-0.06	1.11	1.13

Note:

1. According to KDB 248227, when the extrapolated maximum peak SAR for the maximum output power channel is ≤ 1.6 W/kg and the 1g averaged SAR is ≤ 0.8 W/kg, WLAN SAR testing for other channels is not required.
2. SAR testing for 802.11g is not required when its maximum power is less than 1/4 dB higher than 802.11b.

4.7.2 SAR Results for Limbs (Separation Distance is 0 cm Gap)

Plot No.	Band	Mode	Test Position	Ch.	Max. Tune-up Power (dBm)	Measured Conducted Power (dBm)	Scaling Factor	Power Drift (dB)	Measured SAR-10g (W/kg)	Scaled SAR-10g (W/kg)
06	802.11b	-	ANT Side	6	18.11	18.11	1.00	0.03	0.157	0.16
	802.11n	HT20	ANT Side	6	17.87	17.87	1.00	0.06	0.145	0.15
07	802.11a	-	ANT Side	44	15.92	15.92	1.00	0.05	1.29	1.29
	802.11n	HT20	ANT Side	40	15.86	15.86	1.00	-0.12	1.19	1.19
08	802.11a	-	ANT Side	60	17.91	17.91	1.00	-0.05	1.73	1.73
	802.11a	-	ANT Side	52	17.91	17.87	1.01	-0.02	1.54	1.55
	802.11n	HT20	ANT Side	52	17.81	17.81	1.00	0.06	1.54	1.54
	802.11a	-	ANT Side	136	17.87	17.87	1.00	-0.04	0.934	0.93
09	802.11n	HT20	ANT Side	116	17.93	17.93	1.00	0.07	1.28	1.28
	802.11a	-	ANT Side	149	17.68	17.68	1.00	-0.09	0.726	0.73
10	802.11n	HT20	ANT Side	165	17.69	17.69	1.00	0.03	0.806	0.81

Note:

1. Since the 10g averaged SAR is ≤ 2.0 W/kg, WLAN SAR testing for other channels is not required.

FCC SAR Test Report

4.7.3 SAR Measurement Variability

According to KDB 865664 D01, SAR measurement variability was assessed for each frequency band, which is determined by the SAR probe calibration point and tissue-equivalent medium used for the device measurements. When both head and body tissue-equivalent media are required for SAR measurements in a frequency band, the variability measurement procedures should be applied to the tissue medium with the highest measured SAR, using the highest measured SAR configuration for that tissue-equivalent medium. Alternatively, if the highest measured SAR for both head and body tissue-equivalent media are ≤ 1.45 W/kg and the ratio of these highest SAR values, i.e., largest divided by smallest value, is ≤ 1.10 , the highest SAR configuration for either head or body tissue-equivalent medium may be used to perform the repeated measurement. These additional measurements are repeated after the completion of all measurements requiring the same head or body tissue-equivalent medium in a frequency band. The test device should be returned to ambient conditions (normal room temperature) with the battery fully charged before it is re-mounted on the device holder for the repeated measurement(s) to minimize any unexpected variations in the repeated results.

SAR repeated measurement procedure:

1. When the highest measured SAR is < 0.80 W/kg, repeated measurement is not required.
2. When the highest measured SAR is ≥ 0.80 W/kg, repeat that measurement once.
3. If the ratio of largest to smallest SAR for the original and first repeated measurements is > 1.20 , or when the original or repeated measurement is ≥ 1.45 W/kg, perform a second repeated measurement.
4. If the ratio of largest to smallest SAR for the original, first and second repeated measurements is > 1.20 , and the original, first or second repeated measurement is ≥ 1.5 W/kg, perform a third repeated measurement.

Band	Mode	Test Position	Ch.	Original Measured SAR-1g (W/kg)	1st Repeated SAR-1g (W/kg)	L/S Ratio	2nd Repeated SAR-1g (W/kg)	L/S Ratio	3rd Repeated SAR-1g (W/kg)	L/S Ratio
802.11n	HT20	ANT Side	44	1.21	1.18	1.03	N/A	N/A	N/A	N/A
802.11a	-	ANT Side	60	1.42	1.41	1.01	N/A	N/A	N/A	N/A
802.11a	-	ANT Side	108	1.19	1.15	1.03	N/A	N/A	N/A	N/A
802.11n	HT20	ANT Side	149	1.17	1.11	1.05	N/A	N/A	N/A	N/A

Test Engineer : Willy Chang, and Ulysses Liu



5. Calibration of Test Equipment

Equipment	Manufacturer	Model	SN	Cal. Date	Cal. Interval
System Validation Dipole	SPEAG	D2450V2	716	Jul. 31, 2013	2 Years
System Validation Dipole	SPEAG	D5GHzV2	1018	Jul. 24, 2013	2 Years
Dosimetric E-Field Probe	SPEAG	EX3DV4	3590	Mar. 04, 2014	1 Year
Dosimetric E-Field Probe	SPEAG	EX3DV4	3820	May 15, 2014	1 Year
Dosimetric E-Field Probe	SPEAG	EX3DV4	3971	Mar. 31, 2014	1 Year
Data Acquisition Electronics	SPEAG	DAE3	579	Apr. 23, 2014	1 Year
Data Acquisition Electronics	SPEAG	DAE4	861	Apr. 23, 2014	1 Year
Data Acquisition Electronics	SPEAG	DAE4	1431	Mar. 24, 2014	1 Year
ENA Series Network Analyzer	Agilent	E5071C	MY46214281	Jun. 13, 2014	1 Year
EXA Spectrum Analyzer	Agilent	N9010A	MY53400225	Sep. 18, 2013	1 Year
MXG Analog Signal Generator	Agilent	N5182B	MY53050430	Nov. 19, 2013	1 Year
Power Meter	Anritsu	ML2495A	1232002	Aug. 23, 2013	1 Year
Power Sensor	Anritsu	MA2411B	1207325	Aug. 23, 2013	1 Year
Thermometer	YFE	YF-160A	110600361	Feb. 27, 2014	1 Year

6. Measurement Uncertainty

Error Description	Uncertainty Value (±%)	Probability Distribution	Divisor	C _i (1g)	Standard Uncertainty (1g)	V _i
Measurement System						
Probe Calibration	6.0	Normal	1	1	± 6.0 %	∞
Axial Isotropy	4.7	Rectangular	√3	0.7	± 1.9 %	∞
Hemispherical Isotropy	9.6	Rectangular	√3	0.7	± 3.9 %	∞
Boundary Effects	1.0	Rectangular	√3	1	± 0.6 %	∞
Linearity	4.7	Rectangular	√3	1	± 2.7 %	∞
System Detection Limits	1.0	Rectangular	√3	1	± 0.6 %	∞
Readout Electronics	0.6	Normal	1	1	± 0.6 %	∞
Response Time	0.0	Rectangular	√3	1	± 0.0 %	∞
Integration Time	1.7	Rectangular	√3	1	± 1.0 %	∞
RF Ambient Noise	3.0	Rectangular	√3	1	± 1.7 %	∞
RF Ambient Reflections	3.0	Rectangular	√3	1	± 1.7 %	∞
Probe Positioner	0.5	Rectangular	√3	1	± 0.3 %	∞
Probe Positioning	2.9	Rectangular	√3	1	± 1.7 %	∞
Max. SAR Eval.	2.3	Rectangular	√3	1	± 1.3 %	∞
Test Sample Related						
Device Positioning	3.9	Normal	1	1	± 3.9 %	31
Device Holder	2.7	Normal	1	1	± 2.7 %	19
Power Drift	5.0	Rectangular	√3	1	± 2.9 %	∞
Phantom and Setup						
Phantom Uncertainty	4.0	Rectangular	√3	1	± 2.3 %	∞
Liquid Conductivity (Target)	5.0	Rectangular	√3	0.64	± 1.8 %	∞
Liquid Conductivity (Meas.)	5.0	Normal	1	0.64	± 3.2 %	29
Liquid Permittivity (Target)	5.0	Rectangular	√3	0.6	± 1.7 %	∞
Liquid Permittivity (Meas.)	5.0	Normal	1	0.6	± 3.0 %	29
Combined Standard Uncertainty					± 11.7 %	
Expanded Uncertainty (K=2)					± 23.4 %	

Uncertainty budget for frequency range 300 MHz to 3 GHz



FCC SAR Test Report

A D T

Error Description	Uncertainty Value (±%)	Probability Distribution	Divisor	Ci (1g)	Standard Uncertainty (1g)	Vi
Measurement System						
Probe Calibration	6.55	Normal	1	1	± 6.55 %	∞
Axial Isotropy	4.7	Rectangular	√3	0.7	± 1.9 %	∞
Hemispherical Isotropy	9.6	Rectangular	√3	0.7	± 3.9 %	∞
Boundary Effects	2.0	Rectangular	√3	1	± 1.2 %	∞
Linearity	4.7	Rectangular	√3	1	± 2.7 %	∞
System Detection Limits	1.0	Rectangular	√3	1	± 0.6 %	∞
Readout Electronics	0.3	Normal	1	1	± 0.3 %	∞
Response Time	0.8	Rectangular	√3	1	± 0.5 %	∞
Integration Time	2.6	Rectangular	√3	1	± 1.5 %	∞
RF Ambient Noise	3.0	Rectangular	√3	1	± 1.7 %	∞
RF Ambient Reflections	3.0	Rectangular	√3	1	± 1.7 %	∞
Probe Positioner	0.8	Rectangular	√3	1	± 0.5 %	∞
Probe Positioning	9.9	Rectangular	√3	1	± 5.7 %	∞
Max. SAR Eval.	4.0	Rectangular	√3	1	± 2.3 %	∞
Test Sample Related						
Device Positioning	3.9	Normal	1	1	± 3.9 %	31
Device Holder	2.7	Normal	1	1	± 2.7 %	19
Power Drift	5.0	Rectangular	√3	1	± 2.9 %	∞
Phantom and Setup						
Phantom Uncertainty	4.0	Rectangular	√3	1	± 2.3 %	∞
Liquid Conductivity (Target)	5.0	Rectangular	√3	0.64	± 1.8 %	∞
Liquid Conductivity (Meas.)	5.0	Normal	1	0.64	± 3.2 %	30
Liquid Permittivity (Target)	5.0	Rectangular	√3	0.6	± 1.7 %	∞
Liquid Permittivity (Meas.)	5.0	Normal	1	0.6	± 3.0 %	30
Combined Standard Uncertainty					± 13.4 %	
Expanded Uncertainty (K=2)					± 26.8 %	

Uncertainty budget for frequency range 3 GHz to 6 GHz



FCC SAR Test Report

7. Information on the Testing Laboratories

We, Bureau Veritas Consumer Products Services (H.K.) Ltd., Taoyuan Branch, were founded in 1988 to provide our best service in EMC, Radio, Telecom and Safety consultation. Our laboratories are accredited and approved according to ISO/IEC 17025.

If you have any comments, please feel free to contact us at the following:

Taiwan HwaYa EMC/RF/Safety/Telecom Lab:

Add: No. 19, Hwa Ya 2nd Rd, Wen Hwa Vil., Kwei Shan Hsiang, Taoyuan Hsien 333, Taiwan, R.O.C.

Tel: 886-3-318-3232

Fax: 886-3-327-0892

Taiwan LinKo EMC/RF Lab:

Add: No. 47, 14th Ling, Chia Pau Vil., Linkou Dist., New Taipei City 244, Taiwan, R.O.C.

Tel: 886-2-2605-2180

Fax: 886-2-2605-1924

Taiwan HsinChu EMC/RF Lab:

Add: No. 81-1, Lu Liao Keng, 9th Ling, Wu Lung Vil., Chiung Lin Township, Hsinchu County 307, Taiwan, R.O.C.

Tel: 886-3-593-5343

Fax: 886-3-593-5342

Email: service.adt@tw.bureauveritas.com

Web Site: www.adt.com.tw

The road map of all our labs can be found in our web site also.

---END---



Appendix A. SAR Plots of System Verification

The plots for system verification with largest deviation for each SAR system combination are shown as follows.

System Check_B2450_140629

DUT: Dipole 2450 MHz; Type: D2450V2; SN: 716

Communication System: CW; Frequency: 2450 MHz; Duty Cycle: 1:1

Medium: B24T25N2_0629 Medium parameters used: $f = 2450$ MHz; $\sigma = 1.989$ S/m; $\epsilon_r = 51.463$; $\rho = 1000$ kg/m³

Ambient Temperature : 21.9°C; Liquid Temperature : 21.3°C

DASY5 Configuration:

- Probe: EX3DV4 - SN3590; ConvF(7.72, 7.72, 7.72); Calibrated: 2014/03/04;
- Sensor-Surface: 2mm (Mechanical Surface Detection)
- Electronics: DAE3 Sn579; Calibrated: 2014/04/23
- Phantom: SAM Phantom_Front; Type: SAM V4.0; Serial: TP 1485
- Measurement SW: DASY52, Version 52.8 (8); SEMCAD X Version 14.6.10 (7331)

Pin=250mW/Area Scan (81x81x1): Interpolated grid: dx=1.200 mm, dy=1.200 mm
Maximum value of SAR (interpolated) = 20.5 W/kg

Pin=250mW/Zoom Scan (7x7x7)/Cube 0: Measurement grid: dx=5mm, dy=5mm, dz=5mm
Reference Value = 102.2 V/m; Power Drift = -0.05 dB
Peak SAR (extrapolated) = 28.5 W/kg
SAR(1 g) = 13.2 W/kg; SAR(10 g) = 6.03 W/kg
Maximum value of SAR (measured) = 20.7 W/kg

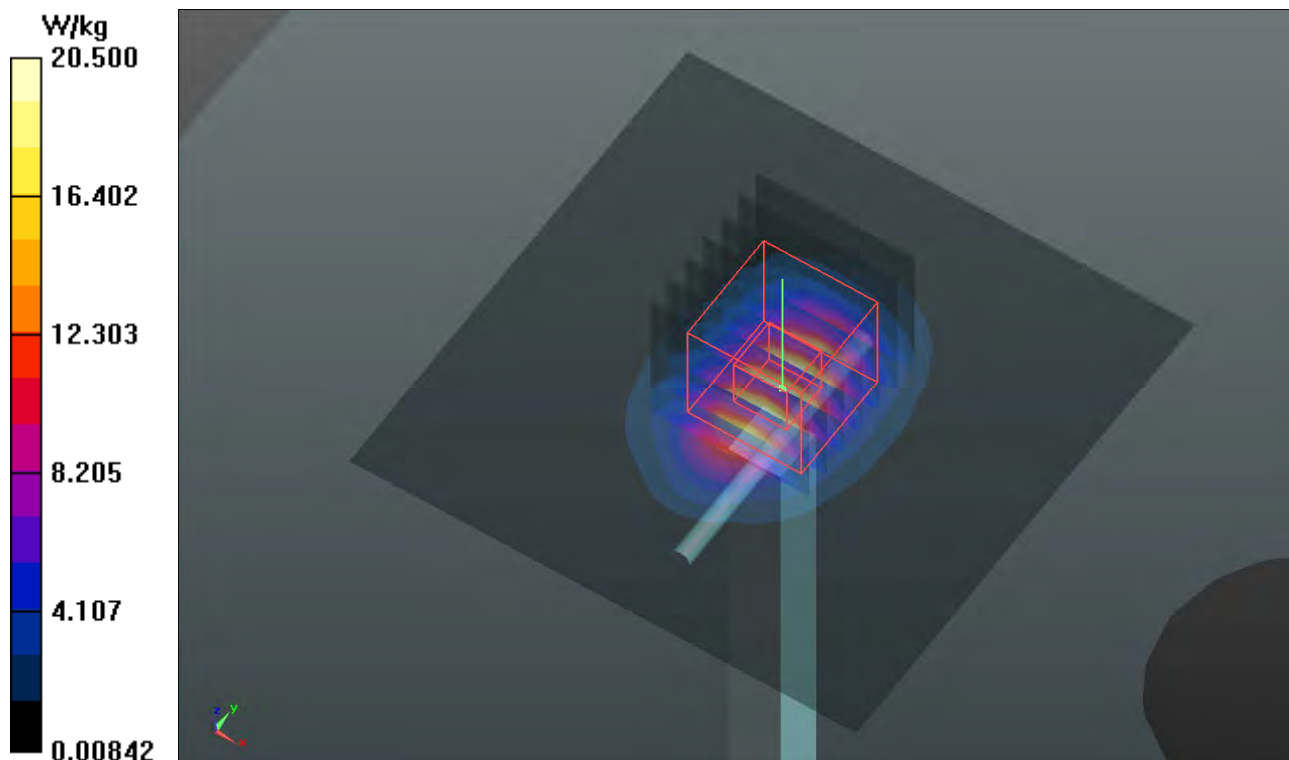

System Check_B5200_140628

DUT: Dipole 5 GHz; Type: D5GHzV2; SN: 1018

Communication System: CW; Frequency: 5200 MHz; Duty Cycle: 1:1

Medium: B50T60N1_0628 Medium parameters used: $f = 5200$ MHz; $\sigma = 5.399$ S/m; $\epsilon_r = 47.771$; $\rho = 1000$ kg/m³

Ambient Temperature : 21.9 °C; Liquid Temperature : 21.1 °C

DASY5 Configuration:

- Probe: EX3DV4 - SN3971; ConvF(4.59, 4.59, 4.59); Calibrated: 2014/03/31;
- Sensor-Surface: 2mm (Mechanical Surface Detection)
- Electronics: DAE4 Sn861; Calibrated: 2014/04/23
- Phantom: SAM Phantom_Front; Type: SAM V4.0; Serial: TP 1202
- Measurement SW: DASY52, Version 52.8 (8); SEMCAD X Version 14.6.10 (7331)

Pin=100mW/Area Scan (91x91x1): Interpolated grid: dx=1.000 mm, dy=1.000 mm

Maximum value of SAR (interpolated) = 16.2 W/kg

Pin=100mW/Zoom Scan (7x7x12)/Cube 0: Measurement grid: dx=4mm, dy=4mm, dz=2mm

Reference Value = 58.06 V/m; Power Drift = 0.10 dB

Peak SAR (extrapolated) = 30.1 W/kg

SAR(1 g) = 7.8 W/kg; SAR(10 g) = 2.22 W/kg

Maximum value of SAR (measured) = 16.3 W/kg

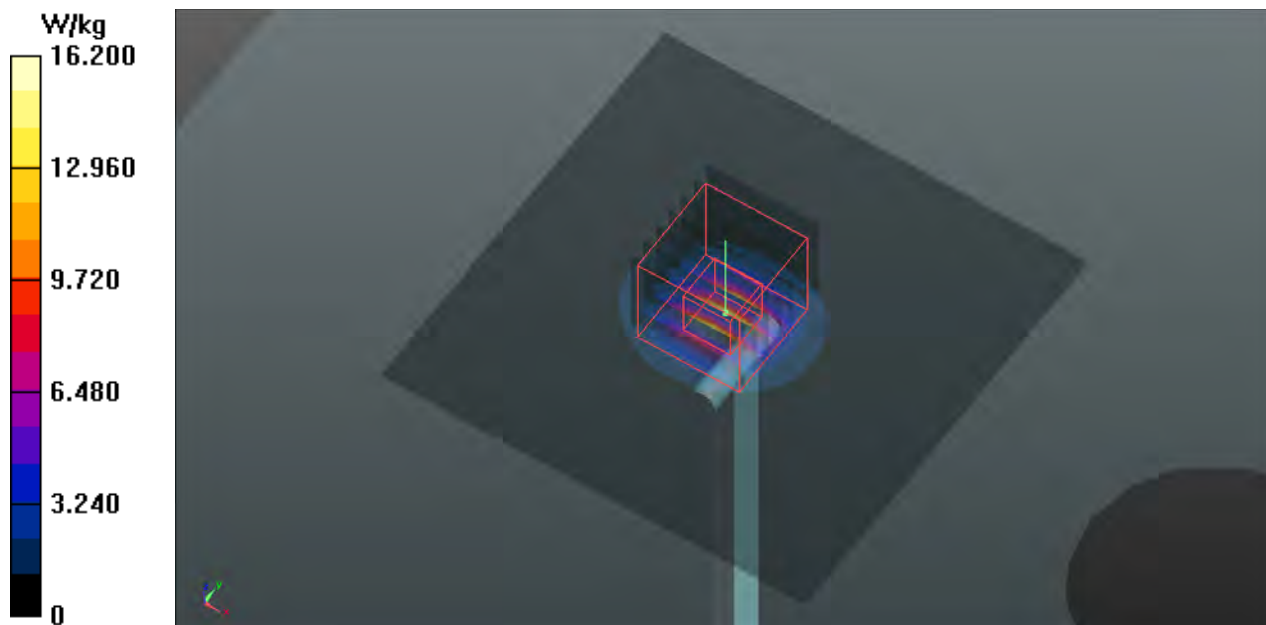

System Check_B5300_140628

DUT: Dipole 5 GHz; Type: D5GHzV2; SN: 1018

Communication System: CW; Frequency: 5300 MHz; Duty Cycle: 1:1

Medium: B50T60N1_0628 Medium parameters used: $f = 5300$ MHz; $\sigma = 5.542$ S/m; $\epsilon_r = 47.565$; $\rho = 1000$ kg/m³

Ambient Temperature : 21.9 °C; Liquid Temperature : 21.1 °C

DASY5 Configuration:

- Probe: EX3DV4 - SN3971; ConvF(4.19, 4.19, 4.19); Calibrated: 2014/03/31;
- Sensor-Surface: 2mm (Mechanical Surface Detection)
- Electronics: DAE4 Sn861; Calibrated: 2014/04/23
- Phantom: SAM Phantom_Front; Type: SAM V4.0; Serial: TP 1202
- Measurement SW: DASY52, Version 52.8 (8); SEMCAD X Version 14.6.10 (7331)

Pin=100mW/Area Scan (91x91x1): Interpolated grid: dx=1.000 mm, dy=1.000 mm

Maximum value of SAR (interpolated) = 16.4 W/kg

Pin=100mW/Zoom Scan (7x7x12)/Cube 0: Measurement grid: dx=4mm, dy=4mm, dz=2mm

Reference Value = 58.89 V/m; Power Drift = 0.03 dB

Peak SAR (extrapolated) = 30.8 W/kg

SAR(1 g) = 7.76 W/kg; SAR(10 g) = 2.21 W/kg

Maximum value of SAR (measured) = 16.0 W/kg

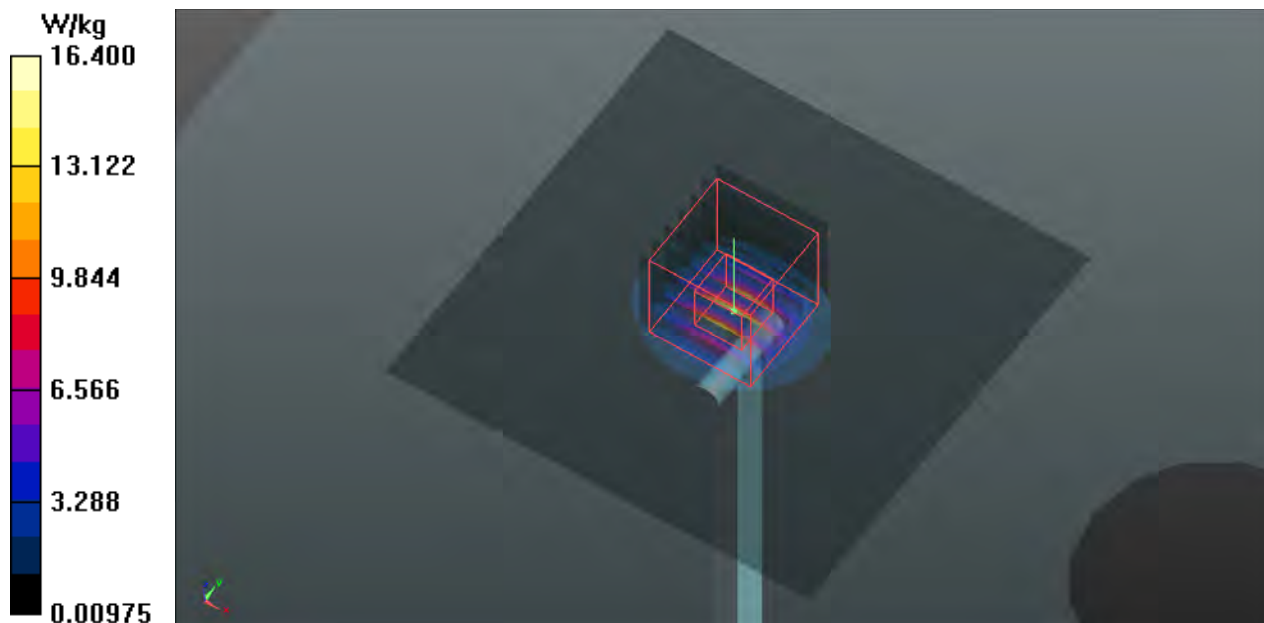

System Check_B5600_140628

DUT: Dipole 5 GHz; Type: D5GHzV2; SN: 1018

Communication System: CW; Frequency: 5600 MHz; Duty Cycle: 1:1

Medium: B50T60N1_0628 Medium parameters used: $f = 5600$ MHz; $\sigma = 5.96$ S/m; $\epsilon_r = 46.959$; $\rho = 1000$ kg/m³

Ambient Temperature : 21.9 °C; Liquid Temperature : 21.1 °C

DASY5 Configuration:

- Probe: EX3DV4 - SN3971; ConvF(3.87, 3.87, 3.87); Calibrated: 2014/03/31;
- Sensor-Surface: 2mm (Mechanical Surface Detection)
- Electronics: DAE4 Sn861; Calibrated: 2014/04/23
- Phantom: SAM Phantom_Front; Type: SAM V4.0; Serial: TP 1202
- Measurement SW: DASY52, Version 52.8 (8); SEMCAD X Version 14.6.10 (7331)

Pin=100mW/Area Scan (91x91x1): Interpolated grid: dx=1.000 mm, dy=1.000 mm

Maximum value of SAR (interpolated) = 16.4 W/kg

Pin=100mW/Zoom Scan (7x7x12)/Cube 0: Measurement grid: dx=4mm, dy=4mm, dz=2mm

Reference Value = 59.94 V/m; Power Drift = 0.00 dB

Peak SAR (extrapolated) = 30.7 W/kg

SAR(1 g) = 7.95 W/kg; SAR(10 g) = 2.26 W/kg

Maximum value of SAR (measured) = 16.6 W/kg

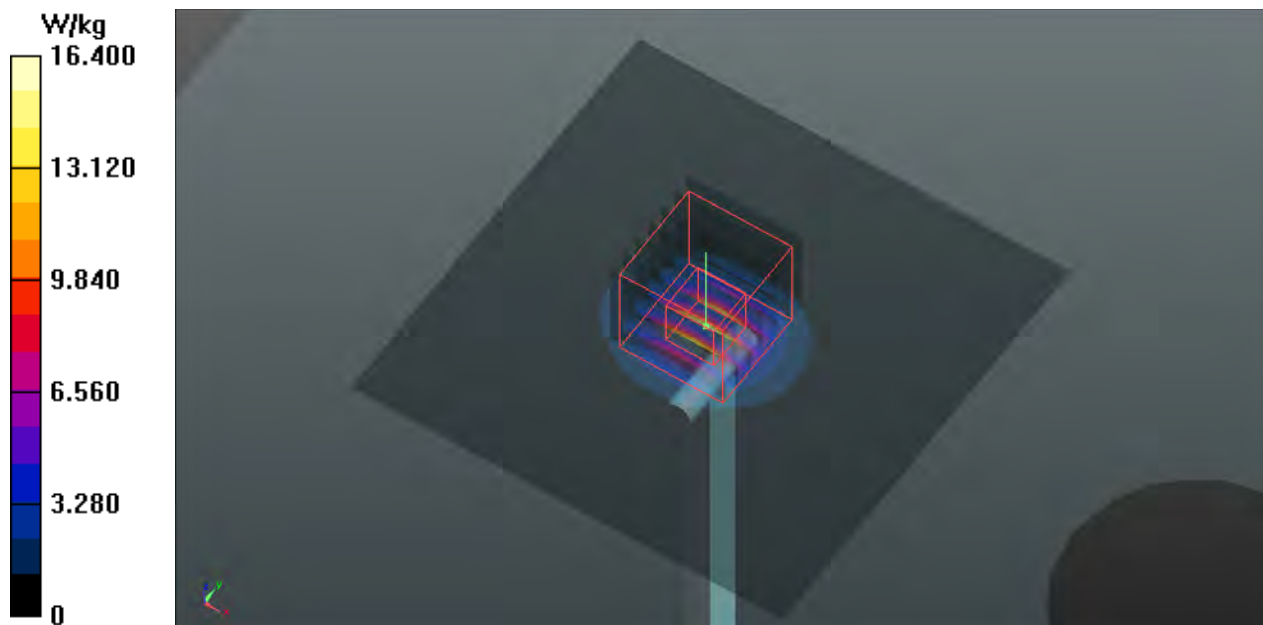

System Check_B5800_140628

DUT: Dipole 5 GHz; Type: D5GHzV2; SN: 1018

Communication System: CW; Frequency: 5800 MHz; Duty Cycle: 1:1

Medium: B50T60N1_0628 Medium parameters used: $f = 5800$ MHz; $\sigma = 6.237$ S/m; $\epsilon_r = 46.574$; $\rho = 1000$ kg/m³

Ambient Temperature : 21.9 °C; Liquid Temperature : 21.1 °C

DASY5 Configuration:

- Probe: EX3DV4 - SN3971; ConvF(4.12, 4.12, 4.12); Calibrated: 2014/03/31;
- Sensor-Surface: 2mm (Mechanical Surface Detection)
- Electronics: DAE4 Sn861; Calibrated: 2014/04/23
- Phantom: SAM Phantom_Front; Type: SAM V4.0; Serial: TP 1202
- Measurement SW: DASY52, Version 52.8 (8); SEMCAD X Version 14.6.10 (7331)

Pin=100mW/Area Scan (91x91x1): Interpolated grid: dx=1.000 mm, dy=1.000 mm

Maximum value of SAR (interpolated) = 29.8 W/kg

Pin=100mW/Zoom Scan (7x7x12)/Cube 0: Measurement grid: dx=4mm, dy=4mm, dz=2mm

Reference Value = 78.24 V/m; Power Drift = -0.04 dB

Peak SAR (extrapolated) = 34.6 W/kg

SAR(1 g) = 7.91 W/kg; SAR(10 g) = 2.23 W/kg

Maximum value of SAR (measured) = 16.9 W/kg

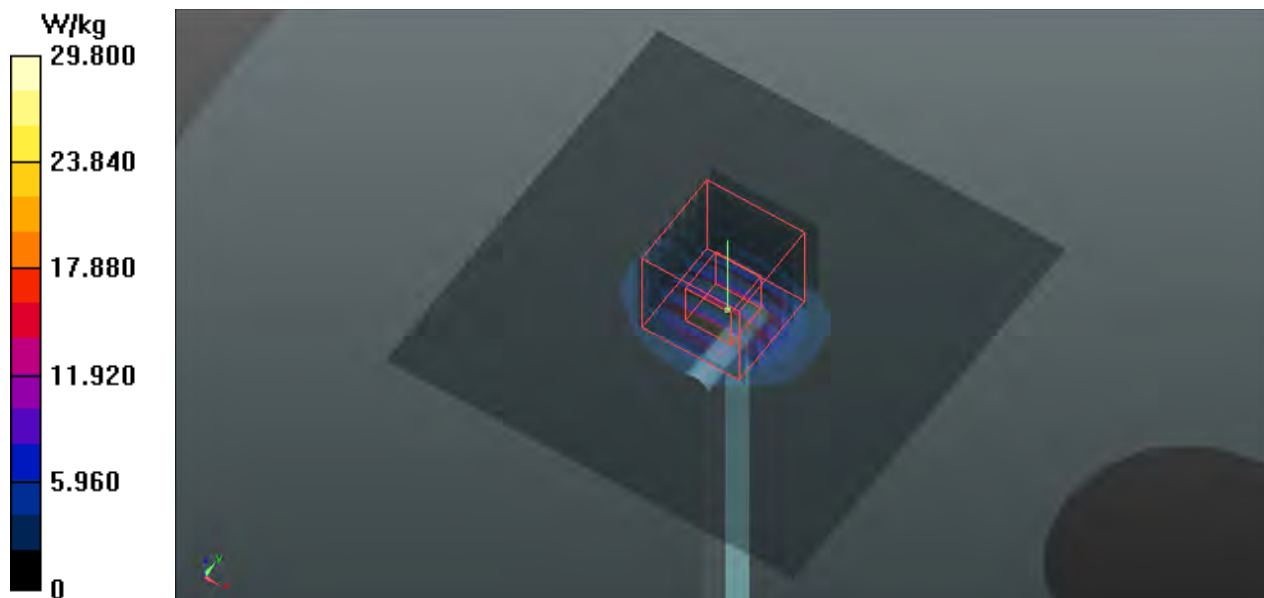

System Check_B2450_140629

DUT: Dipole 2450 MHz; Type: D2450V2; SN: 716

Communication System: CW; Frequency: 2450 MHz; Duty Cycle: 1:1

Medium: B24T25N2_0629 Medium parameters used: $f = 2450$ MHz; $\sigma = 1.989$ S/m; $\epsilon_r = 51.463$; $\rho = 1000$ kg/m³

Ambient Temperature : 21.9°C; Liquid Temperature : 21.3°C

DASY5 Configuration:

- Probe: EX3DV4 - SN3590; ConvF(7.72, 7.72, 7.72); Calibrated: 2014/03/04;
- Sensor-Surface: 2mm (Mechanical Surface Detection)
- Electronics: DAE3 Sn579; Calibrated: 2014/04/23
- Phantom: SAM Phantom_Front; Type: SAM V4.0; Serial: TP 1485
- Measurement SW: DASY52, Version 52.8 (8); SEMCAD X Version 14.6.10 (7331)

Pin=250mW/Area Scan (81x81x1): Interpolated grid: dx=1.200 mm, dy=1.200 mm
Maximum value of SAR (interpolated) = 20.5 W/kg

Pin=250mW/Zoom Scan (7x7x7)/Cube 0: Measurement grid: dx=5mm, dy=5mm, dz=5mm
Reference Value = 102.2 V/m; Power Drift = -0.05 dB
Peak SAR (extrapolated) = 28.5 W/kg
SAR(1 g) = 13.2 W/kg; SAR(10 g) = 6.03 W/kg
Maximum value of SAR (measured) = 20.7 W/kg

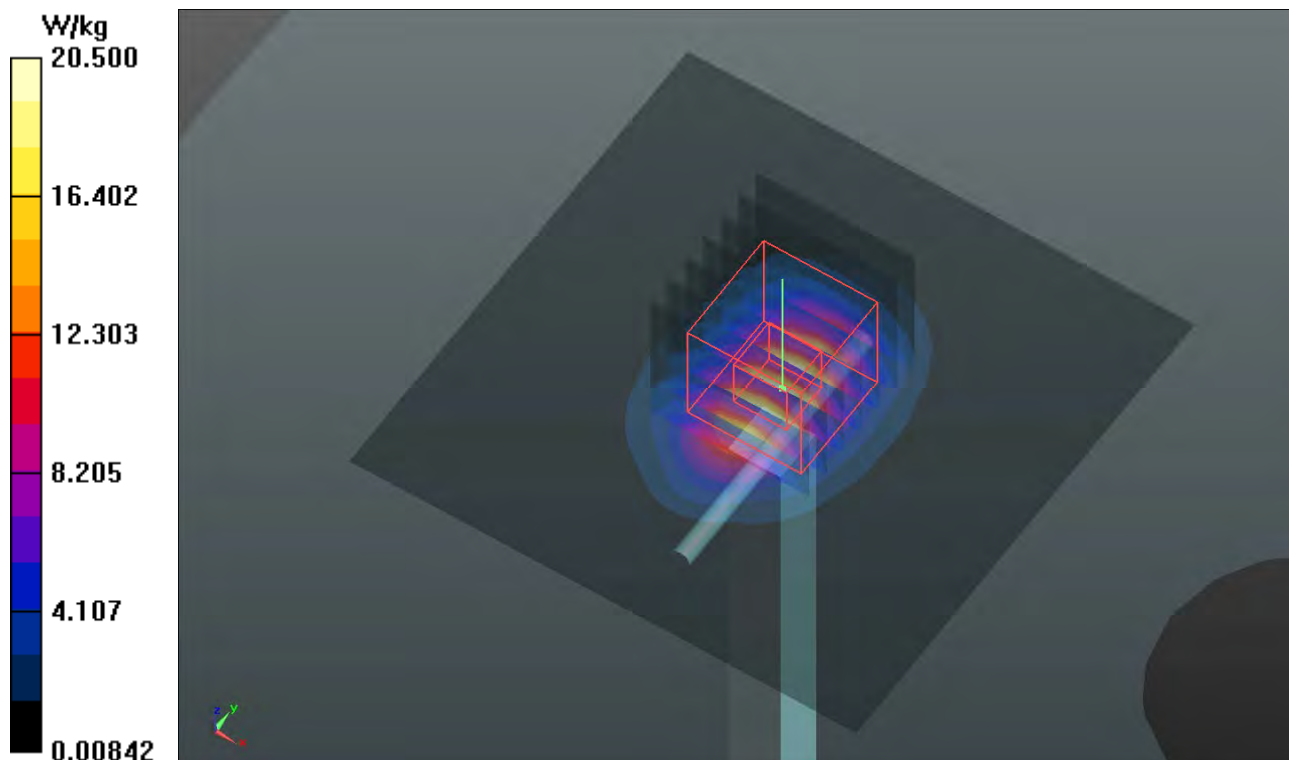

System Check_B5200_140628

DUT: Dipole 5 GHz; Type: D5GHzV2; SN: 1018

Communication System: CW; Frequency: 5200 MHz; Duty Cycle: 1:1

Medium: B50T60N1_0628 Medium parameters used: $f = 5200$ MHz; $\sigma = 5.399$ S/m; $\epsilon_r = 47.771$; $\rho = 1000$ kg/m³

Ambient Temperature : 21.2 °C; Liquid Temperature : 20.7 °C

DASY5 Configuration:

- Probe: EX3DV4 - SN3820; ConvF(4.44, 4.44, 4.44); Calibrated: 2014/05/15;
- Sensor-Surface: 2mm (Mechanical Surface Detection)
- Electronics: DAE4 Sn1431; Calibrated: 2014/03/24
- Phantom: SAM Phantom_Left; Type: SAM V4.0; Serial: TP 1653
- Measurement SW: DASY52, Version 52.8 (8); SEMCAD X Version 14.6.10 (7331)

Pin=100mW/Area Scan (91x91x1): Interpolated grid: dx=1.000 mm, dy=1.000 mm
Maximum value of SAR (interpolated) = 15.3 W/kg

Pin=100mW/Zoom Scan (7x7x12)/Cube 0: Measurement grid: dx=4mm, dy=4mm, dz=2mm
Reference Value = 56.11 V/m; Power Drift = -0.06 dB
Peak SAR (extrapolated) = 29.2 W/kg
SAR(1 g) = 7.17 W/kg; SAR(10 g) = 2.04 W/kg
Maximum value of SAR (measured) = 14.7 W/kg

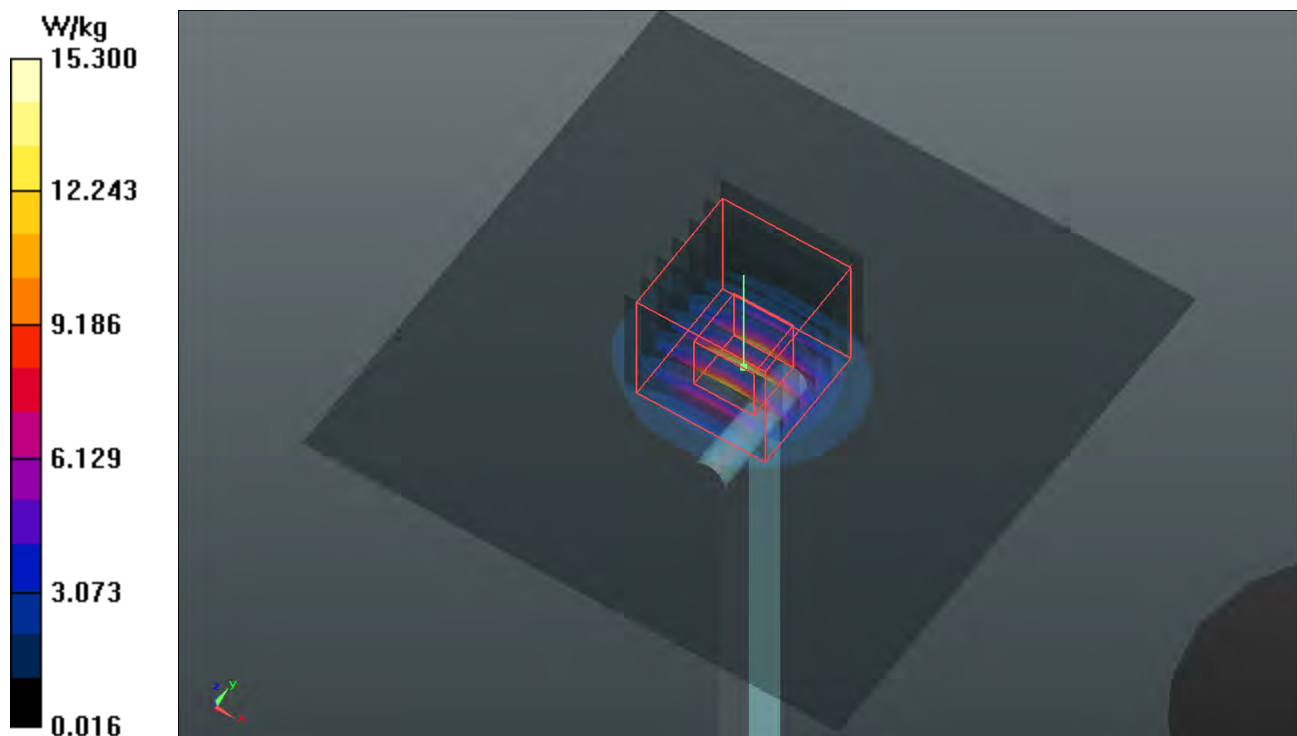

System Check_B5300_140628

DUT: Dipole 5 GHz; Type: D5GHzV2; SN: 1018

Communication System: CW; Frequency: 5300 MHz; Duty Cycle: 1:1

Medium: B50T60N1_0628 Medium parameters used: $f = 5300$ MHz; $\sigma = 5.542$ S/m; $\epsilon_r = 47.565$; $\rho = 1000$ kg/m³

Ambient Temperature : 21.2 °C; Liquid Temperature : 20.7 °C

DASY5 Configuration:

- Probe: EX3DV4 - SN3820; ConvF(4.25, 4.25, 4.25); Calibrated: 2014/05/15;
- Sensor-Surface: 2mm (Mechanical Surface Detection)
- Electronics: DAE4 Sn1431; Calibrated: 2014/03/24
- Phantom: SAM Phantom_Left; Type: SAM V4.0; Serial: TP 1653
- Measurement SW: DASY52, Version 52.8 (8); SEMCAD X Version 14.6.10 (7331)

Pin=100mW/Area Scan (91x91x1): Interpolated grid: dx=1.000 mm, dy=1.000 mm
Maximum value of SAR (interpolated) = 15.8 W/kg

Pin=100mW/Zoom Scan (7x7x12)/Cube 0: Measurement grid: dx=4mm, dy=4mm, dz=2mm
Reference Value = 57.24 V/m; Power Drift = 0.03 dB
Peak SAR (extrapolated) = 30.5 W/kg
SAR(1 g) = 7.46 W/kg; SAR(10 g) = 2.12 W/kg
Maximum value of SAR (measured) = 15.5 W/kg

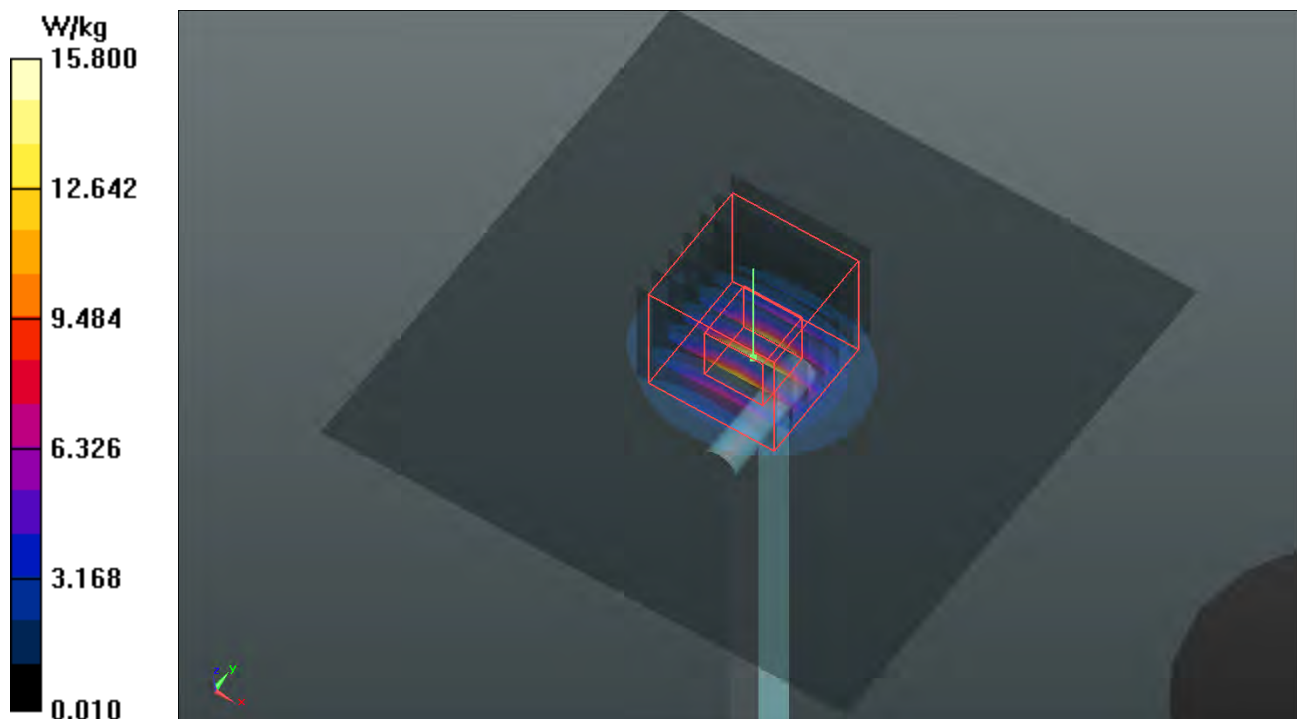

System Check_B5600_140628

DUT: Dipole 5 GHz; Type: D5GHzV2; SN: 1018

Communication System: CW; Frequency: 5600 MHz; Duty Cycle: 1:1

Medium: B50T60N1_0628 Medium parameters used: $f = 5600$ MHz; $\sigma = 5.96$ S/m; $\epsilon_r = 46.959$; $\rho = 1000$ kg/m³

Ambient Temperature : 21.2 °C; Liquid Temperature : 20.7 °C

DASY5 Configuration:

- Probe: EX3DV4 - SN3820; ConvF(3.83, 3.83, 3.83); Calibrated: 2014/05/15;
- Sensor-Surface: 2mm (Mechanical Surface Detection)
- Electronics: DAE4 Sn1431; Calibrated: 2014/03/24
- Phantom: SAM Phantom_Left; Type: SAM V4.0; Serial: TP 1653
- Measurement SW: DASY52, Version 52.8 (8); SEMCAD X Version 14.6.10 (7331)

Pin=100mW/Area Scan (91x91x1): Interpolated grid: dx=1.000 mm, dy=1.000 mm
Maximum value of SAR (interpolated) = 15.6 W/kg

Pin=100mW/Zoom Scan (7x7x12)/Cube 0: Measurement grid: dx=4mm, dy=4mm, dz=2mm
Reference Value = 55.90 V/m; Power Drift = 0.09 dB
Peak SAR (extrapolated) = 32.6 W/kg
SAR(1 g) = 7.79 W/kg; SAR(10 g) = 2.21 W/kg
Maximum value of SAR (measured) = 16.5 W/kg

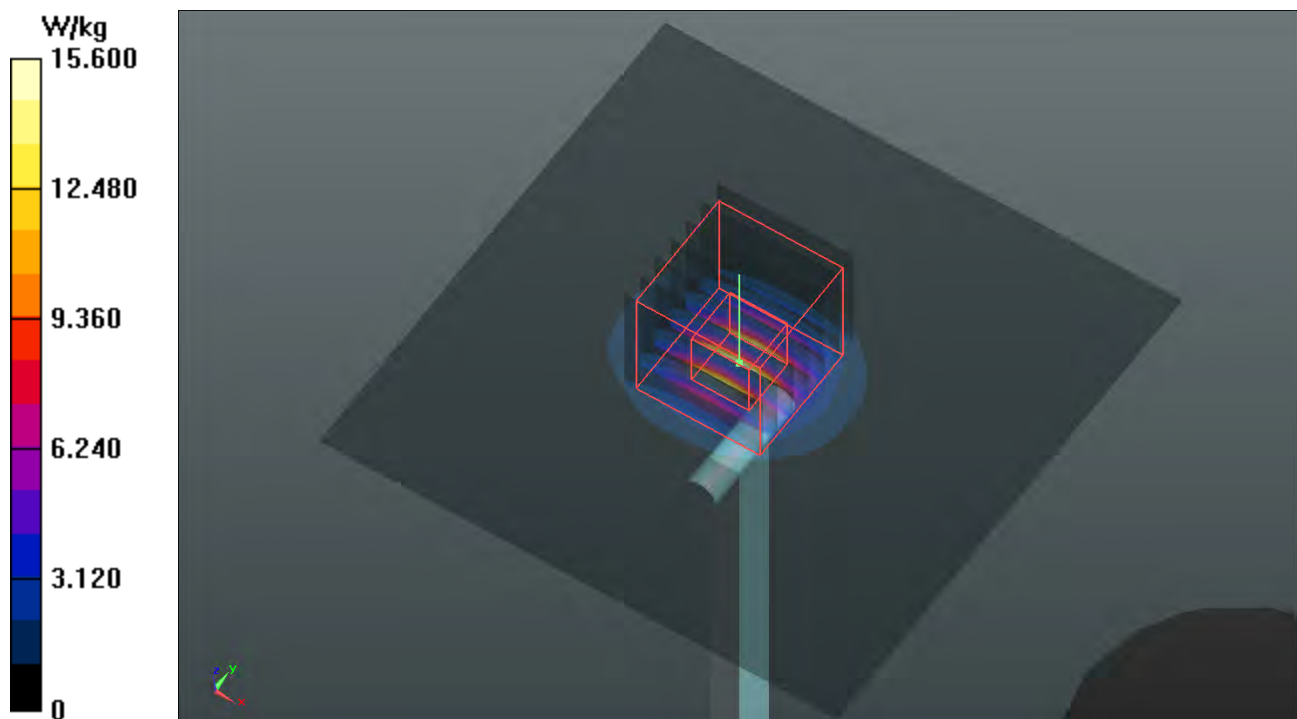

System Check_B5800_140628

DUT: Dipole 5 GHz; Type: D5GHzV2; SN: 1018

Communication System: CW; Frequency: 5800 MHz; Duty Cycle: 1:1

Medium: B50T60N1_0628 Medium parameters used: $f = 5800$ MHz; $\sigma = 6.237$ S/m; $\epsilon_r = 46.574$; $\rho = 1000$ kg/m³

Ambient Temperature : 21.2 °C; Liquid Temperature : 20.7 °C

DASY5 Configuration:

- Probe: EX3DV4 - SN3820; ConvF(4, 4, 4); Calibrated: 2014/05/15;
- Sensor-Surface: 2mm (Mechanical Surface Detection)
- Electronics: DAE4 Sn1431; Calibrated: 2014/03/24
- Phantom: SAM Phantom_Left; Type: SAM V4.0; Serial: TP 1653
- Measurement SW: DASY52, Version 52.8 (8); SEMCAD X Version 14.6.10 (7331)

Pin=100mW/Area Scan (91x91x1): Interpolated grid: dx=1.000 mm, dy=1.000 mm
Maximum value of SAR (interpolated) = 14.9 W/kg

Pin=100mW/Zoom Scan (7x7x12)/Cube 0: Measurement grid: dx=4mm, dy=4mm, dz=2mm
Reference Value = 53.48 V/m; Power Drift = 0.06 dB
Peak SAR (extrapolated) = 30.5 W/kg
SAR(1 g) = 7.02 W/kg; SAR(10 g) = 2 W/kg
Maximum value of SAR (measured) = 15.0 W/kg

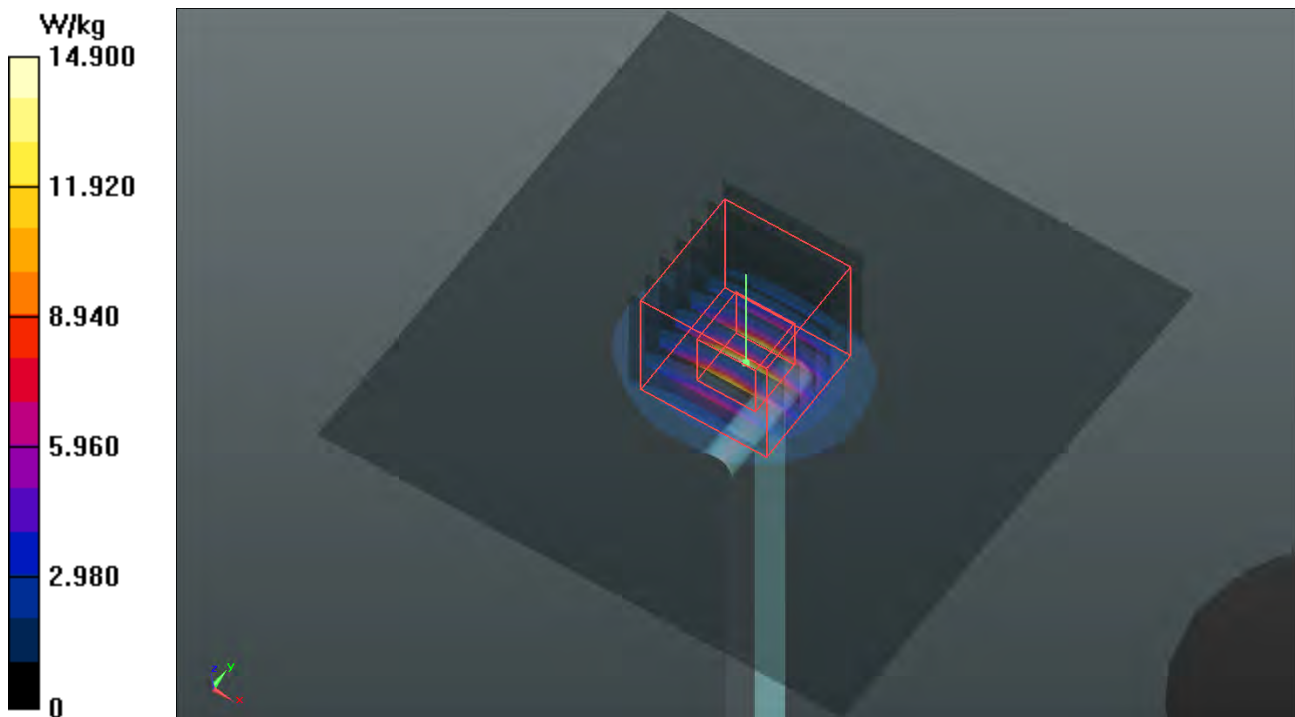



Appendix B. SAR Plots of SAR Measurement

The SAR plots for highest measured SAR in each exposure configuration, wireless mode and frequency band combination, and measured SAR > 1.5 W/kg are shown as follows.

P01 802.11b_Body-ANT Side_1cm_Ch6

DUT: 140609E04

Communication System: WLAN_2.4G; Frequency: 2437 MHz; Duty Cycle: 1:1

Medium: B24T25N2_0629 Medium parameters used: $f = 2437$ MHz; $\sigma = 1.968$ S/m; $\epsilon_r = 51.462$; $\rho = 1000$ kg/m³

Ambient Temperature : 21.9°C; Liquid Temperature : 21.3°C

DASY5 Configuration:

- Probe: EX3DV4 - SN3590; ConvF(7.72, 7.72, 7.72); Calibrated: 2014/03/04;
- Sensor-Surface: 2mm (Mechanical Surface Detection)
- Electronics: DAE3 Sn579; Calibrated: 2014/04/23
- Phantom: SAM Phantom_Front; Type: SAM V4.0; Serial: TP 1485
- Measurement SW: DASY52, Version 52.8 (8); SEMCAD X Version 14.6.10 (7331)

- **Area Scan (41x131x1):** Interpolated grid: dx=1.200 mm, dy=1.200 mm

Maximum value of SAR (interpolated) = 0.141 W/kg

- **Zoom Scan (5x5x7)/Cube 0:** Measurement grid: dx=8mm, dy=8mm, dz=5mm

Reference Value = 6.574 V/m; Power Drift = 0.06 dB

Peak SAR (extrapolated) = 0.183 W/kg

SAR(1 g) = 0.096 W/kg; SAR(10 g) = 0.051 W/kg

Maximum value of SAR (measured) = 0.138 W/kg

- **Zoom Scan (5x5x7)/Cube 1:** Measurement grid: dx=8mm, dy=8mm, dz=5mm

Reference Value = 6.574 V/m; Power Drift = 0.06 dB

Peak SAR (extrapolated) = 0.137 W/kg

SAR(1 g) = 0.076 W/kg; SAR(10 g) = 0.042 W/kg

Maximum value of SAR (measured) = 0.106 W/kg

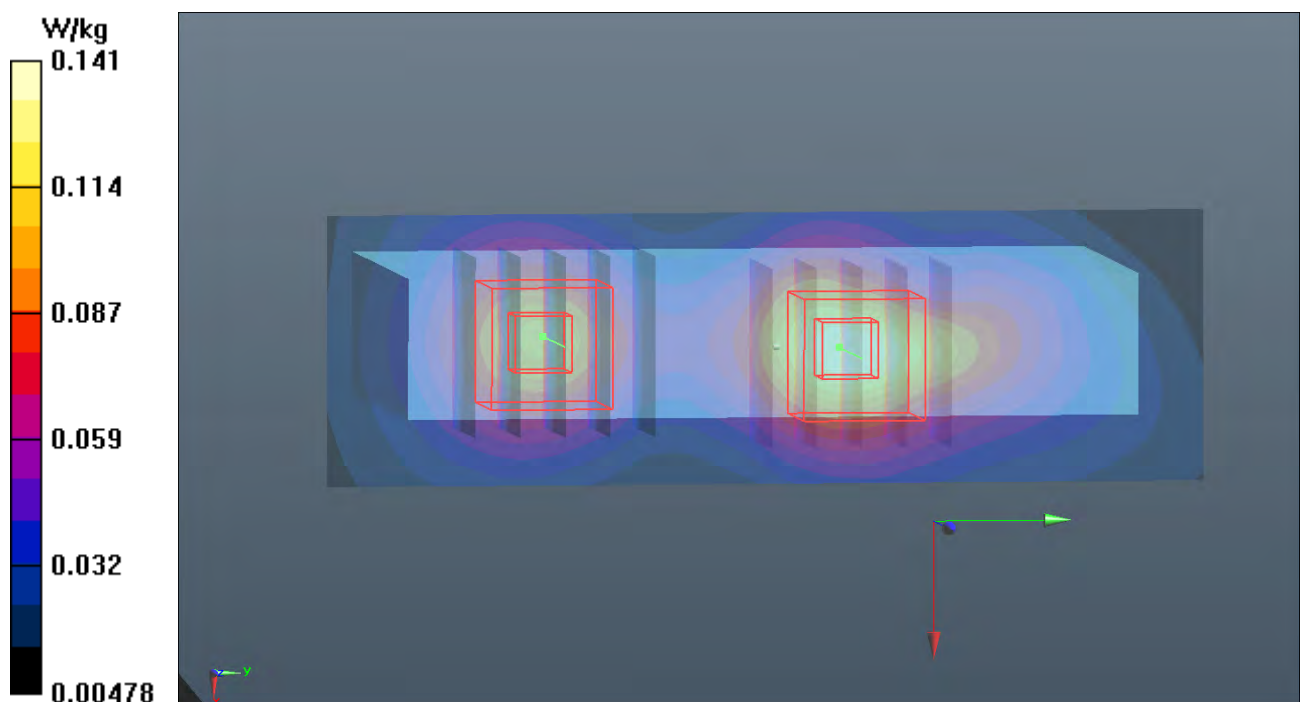

P02 802.11n_HT20_Body-ANT Side_1cm_Ch44

DUT: 140609E04

Communication System: WLAN_5G; Frequency: 5220 MHz; Duty Cycle: 1:1.09

Medium: B50T60N1_0628 Medium parameters used: $f = 5220$ MHz; $\sigma = 5.427$ S/m; $\epsilon_r = 47.715$; $\rho = 1000$ kg/m³

Ambient Temperature : 21.9 °C; Liquid Temperature : 21.1 °C

DASY5 Configuration:

- Probe: EX3DV4 - SN3971; ConvF(4.59, 4.59, 4.59); Calibrated: 2014/03/31;
- Sensor-Surface: 2mm (Mechanical Surface Detection)
- Electronics: DAE4 Sn861; Calibrated: 2014/04/23
- Phantom: SAM Phantom_Front; Type: SAM V4.0; Serial: TP 1202
- Measurement SW: DASY52, Version 52.8 (8); SEMCAD X Version 14.6.10 (7331)

- **Area Scan (41x161x1):** Interpolated grid: dx=1.000 mm, dy=1.000 mm

Maximum value of SAR (interpolated) = 2.32 W/kg

- **Zoom Scan (6x6x12)/Cube 0:** Measurement grid: dx=5mm, dy=5mm, dz=2mm

Reference Value = 3.150 V/m; Power Drift = 0.01 dB

Peak SAR (extrapolated) = 4.45 W/kg

SAR(1 g) = 1.21 W/kg; SAR(10 g) = 0.402 W/kg

Maximum value of SAR (measured) = 2.08 W/kg

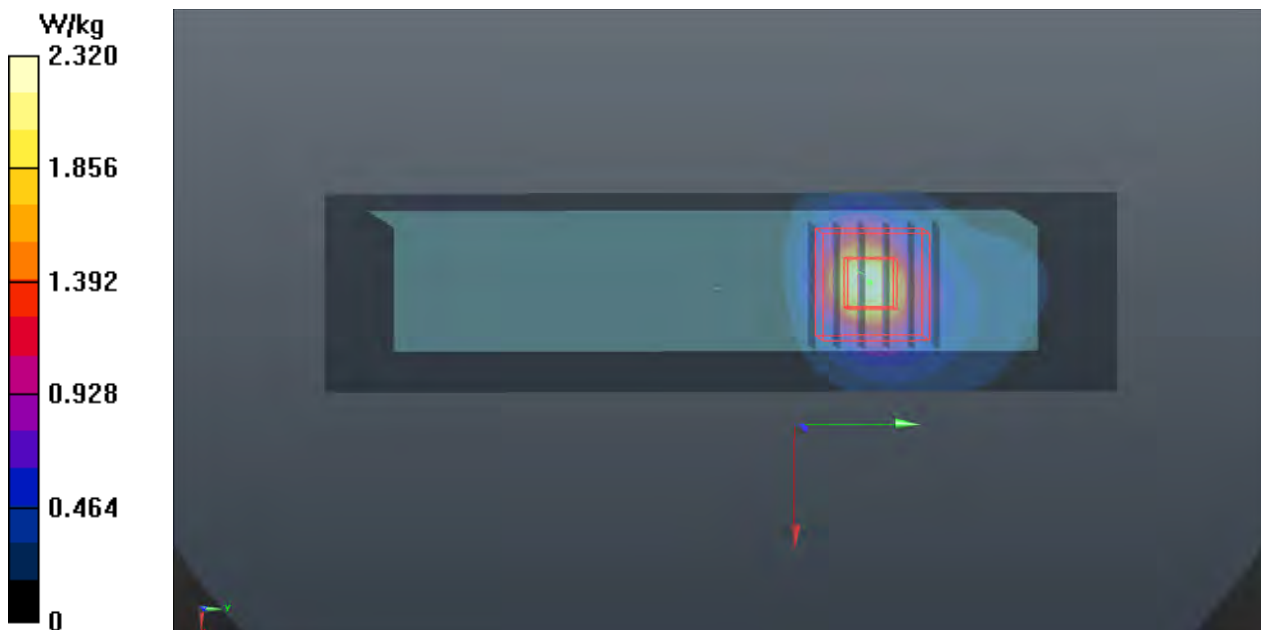

P03 802.11a_Body-ANT Side_1cm_Ch60

DUT: 140609E04

Communication System: WLAN_5G; Frequency: 5300 MHz; Duty Cycle: 1:1.07

Medium: B50T60N1_0628 Medium parameters used: $f = 5300$ MHz; $\sigma = 5.542$ S/m; $\epsilon_r = 47.565$; $\rho = 1000$ kg/m³

Ambient Temperature : 21.9 °C; Liquid Temperature : 21.1 °C

DASY5 Configuration:

- Probe: EX3DV4 - SN3971; ConvF(4.19, 4.19, 4.19); Calibrated: 2014/03/31;
- Sensor-Surface: 2mm (Mechanical Surface Detection)
- Electronics: DAE4 Sn861; Calibrated: 2014/04/23
- Phantom: SAM Phantom_Front; Type: SAM V4.0; Serial: TP 1202
- Measurement SW: DASY52, Version 52.8 (8); SEMCAD X Version 14.6.10 (7331)

- **Area Scan (41x161x1)**: Interpolated grid: dx=1.000 mm, dy=1.000 mm

Maximum value of SAR (interpolated) = 2.91 W/kg

- **Zoom Scan (7x7x12)/Cube 0**: Measurement grid: dx=4mm, dy=4mm, dz=2mm

Reference Value = 3.422 V/m; Power Drift = -0.04 dB

Peak SAR (extrapolated) = 4.95 W/kg

SAR(1 g) = 1.42 W/kg; SAR(10 g) = 0.512 W/kg

Maximum value of SAR (measured) = 2.63 W/kg

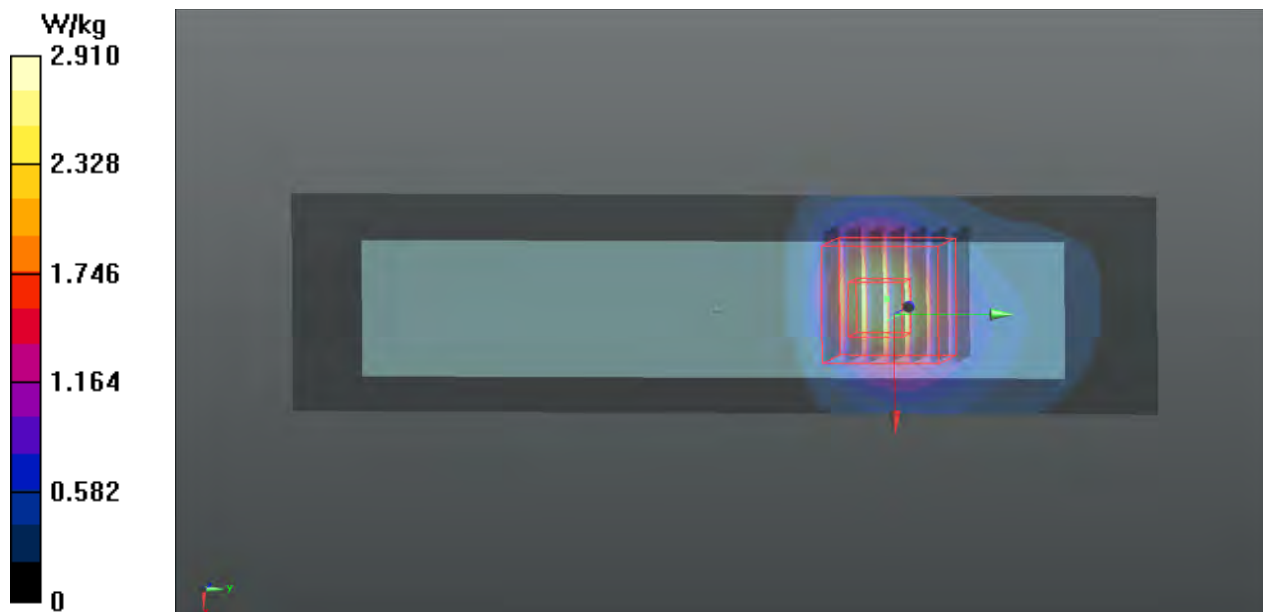

P04 802.11a_Body-ANT Side_1cm_Ch108

DUT: 140609E04

Communication System: WLAN_5G; Frequency: 5540 MHz; Duty Cycle: 1:1.06

Medium: B50T60N1_0628 Medium parameters used: $f = 5540$ MHz; $\sigma = 5.869$ S/m; $\epsilon_r = 47.078$; $\rho = 1000$ kg/m³

Ambient Temperature : 21.9 °C; Liquid Temperature : 21.1 °C

DASY5 Configuration:

- Probe: EX3DV4 - SN3971; ConvF(3.87, 3.87, 3.87); Calibrated: 2014/03/31;
- Sensor-Surface: 2mm (Mechanical Surface Detection)
- Electronics: DAE4 Sn861; Calibrated: 2014/04/23
- Phantom: SAM Phantom_Front; Type: SAM V4.0; Serial: TP 1202
- Measurement SW: DASY52, Version 52.8 (8); SEMCAD X Version 14.6.10 (7331)

- **Area Scan (41x161x1):** Interpolated grid: dx=1.000 mm, dy=1.000 mm

Maximum value of SAR (interpolated) = 2.29 W/kg

- **Zoom Scan (6x6x12)/Cube 0:** Measurement grid: dx=5mm, dy=5mm, dz=2mm

Reference Value = 2.647 V/m; Power Drift = 0.07 dB

Peak SAR (extrapolated) = 4.31 W/kg

SAR(1 g) = 1.19 W/kg; SAR(10 g) = 0.421 W/kg

Maximum value of SAR (measured) = 2.20 W/kg

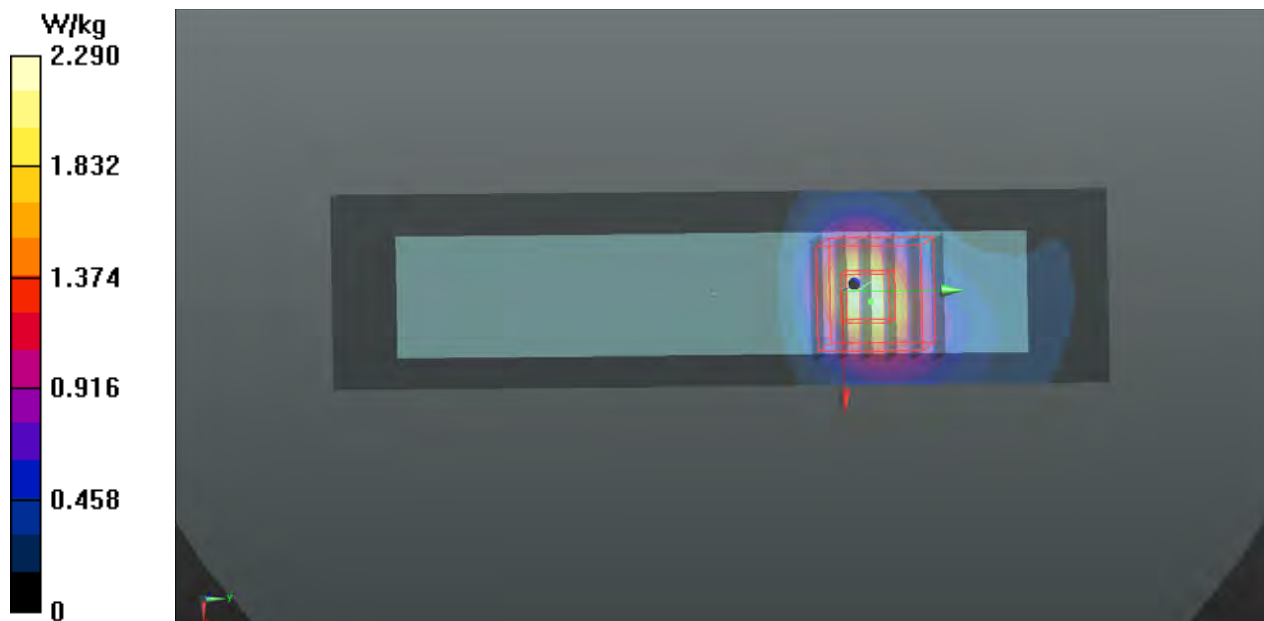

P05 802.11n_HT20_Body-ANT Side_1cm_Ch149

DUT: 140609E04

Communication System: WLAN_5G; Frequency: 5745 MHz; Duty Cycle: 1:1.08

Medium: B50T60N1_0628 Medium parameters used: $f = 5745$ MHz; $\sigma = 6.167$ S/m; $\epsilon_r = 46.701$; $\rho = 1000$ kg/m³

Ambient Temperature : 21.9 °C; Liquid Temperature : 21.1 °C

DASY5 Configuration:

- Probe: EX3DV4 - SN3971; ConvF(4.12, 4.12, 4.12); Calibrated: 2014/03/31;
- Sensor-Surface: 2mm (Mechanical Surface Detection)
- Electronics: DAE4 Sn861; Calibrated: 2014/04/23
- Phantom: SAM Phantom_Front; Type: SAM V4.0; Serial: TP 1202
- Measurement SW: DASY52, Version 52.8 (8); SEMCAD X Version 14.6.10 (7331)

- **Area Scan (41x161x1):** Interpolated grid: dx=1.000 mm, dy=1.000 mm

Maximum value of SAR (interpolated) = 2.30 W/kg

- **Zoom Scan (6x6x12)/Cube 0:** Measurement grid: dx=5mm, dy=5mm, dz=2mm

Reference Value = 4.096 V/m; Power Drift = 0.07 dB

Peak SAR (extrapolated) = 4.56 W/kg

SAR(1 g) = 1.17 W/kg; SAR(10 g) = 0.390 W/kg

Maximum value of SAR (measured) = 2.21 W/kg

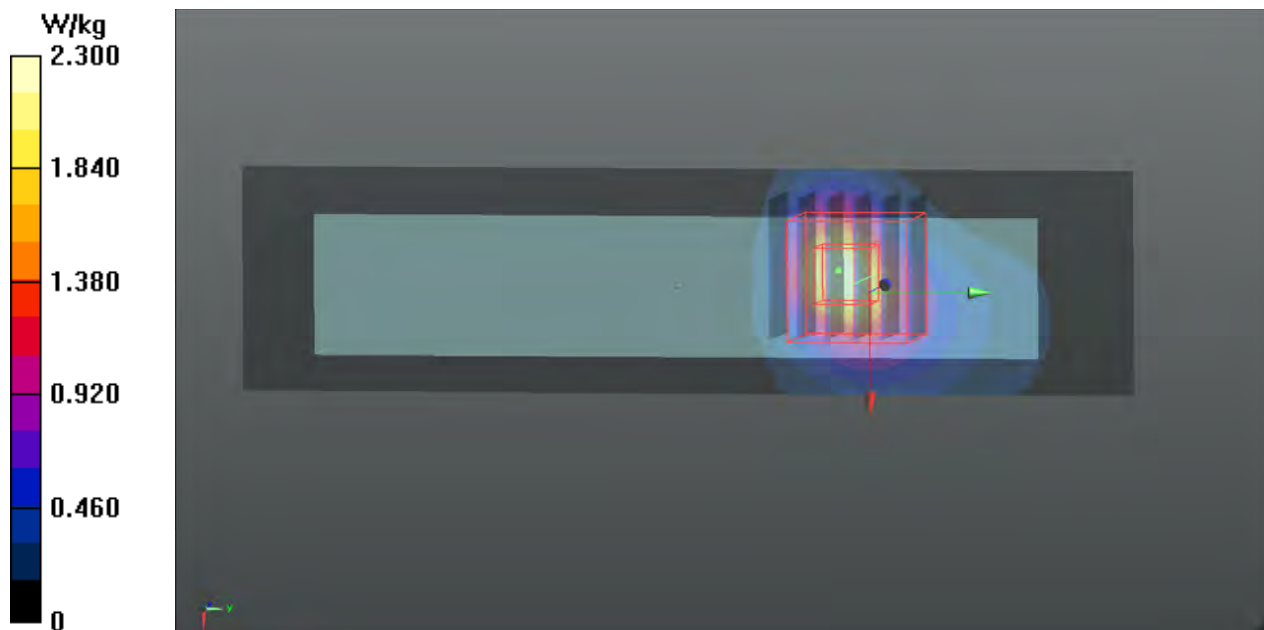

P06 802.11b_Limbs-ANT Side_0cm_Ch6

DUT: 140609E04

Communication System: WLAN_2.4G; Frequency: 2437 MHz; Duty Cycle: 1:1

Medium: B24T25N2_0629 Medium parameters used: $f = 2437$ MHz; $\sigma = 1.968$ S/m; $\epsilon_r = 51.462$; $\rho = 1000$ kg/m³

Ambient Temperature : 21.9°C; Liquid Temperature : 21.3°C

DASY5 Configuration:

- Probe: EX3DV4 - SN3590; ConvF(7.72, 7.72, 7.72); Calibrated: 2014/03/04;
- Sensor-Surface: 2mm (Mechanical Surface Detection)
- Electronics: DAE3 Sn579; Calibrated: 2014/04/23
- Phantom: SAM Phantom_Front; Type: SAM V4.0; Serial: TP 1485
- Measurement SW: DASY52, Version 52.8 (8); SEMCAD X Version 14.6.10 (7331)

- **Area Scan (41x131x1):** Interpolated grid: dx=1.200 mm, dy=1.200 mm

Maximum value of SAR (interpolated) = 0.806 W/kg

- **Zoom Scan (5x5x7)/Cube 0:** Measurement grid: dx=8mm, dy=8mm, dz=5mm

Reference Value = 13.24 V/m; Power Drift = 0.03 dB

Peak SAR (extrapolated) = 0.973 W/kg

SAR(1 g) = 0.399 W/kg; SAR(10 g) = 0.157 W/kg

Maximum value of SAR (measured) = 0.802 W/kg

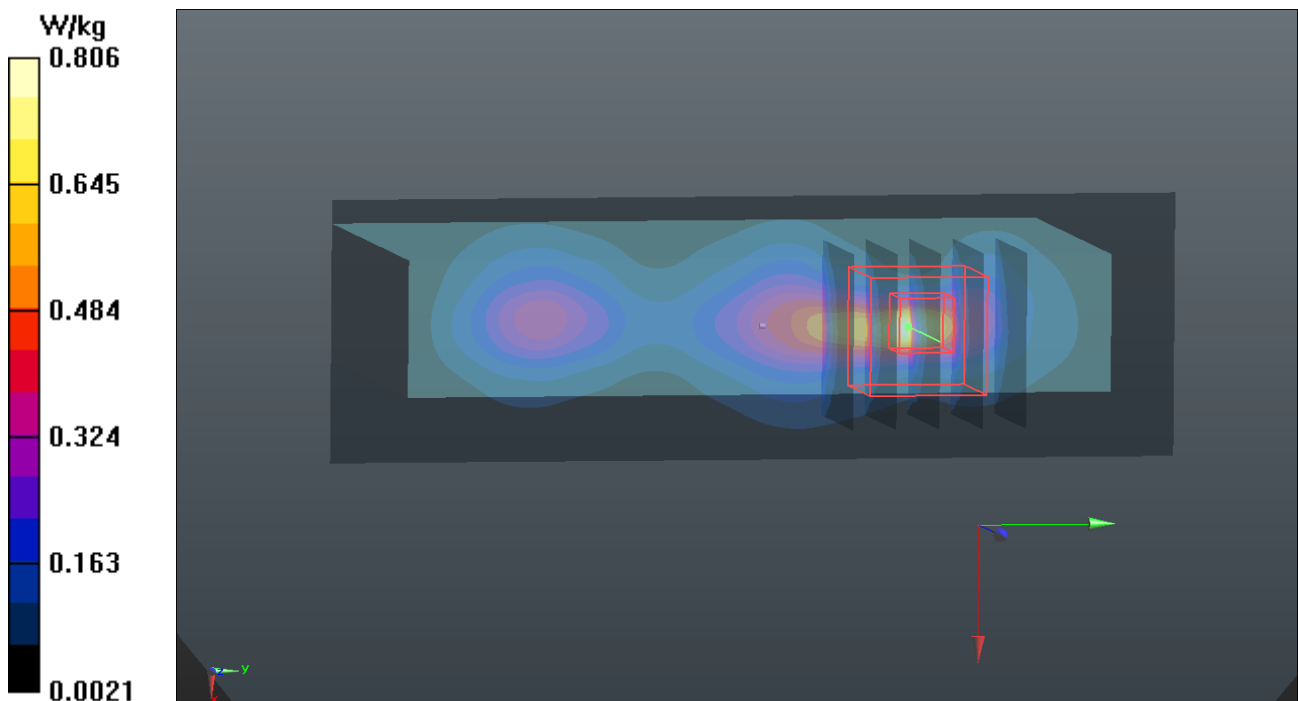

P07 802.11a_Limbs-ANT Side_0cm_Ch44

DUT: 140609E04

Communication System: WLAN_5G; Frequency: 5220 MHz; Duty Cycle: 1:1.06

Medium: B50T60N1_0628 Medium parameters used: $f = 5220$ MHz; $\sigma = 5.427$ S/m; $\epsilon_r = 47.715$; $\rho = 1000$ kg/m³

Ambient Temperature : 21.2 °C; Liquid Temperature : 20.7 °C

DASY5 Configuration:

- Probe: EX3DV4 - SN3820; ConvF(4.44, 4.44, 4.44); Calibrated: 2014/05/15;
- Sensor-Surface: 2mm (Mechanical Surface Detection)
- Electronics: DAE4 Sn1431; Calibrated: 2014/03/24
- Phantom: SAM Phantom_Left; Type: SAM V4.0; Serial: TP 1653
- Measurement SW: DASY52, Version 52.8 (8); SEMCAD X Version 14.6.10 (7331)

- **Area Scan (41x161x1):** Interpolated grid: dx=1.000 mm, dy=1.000 mm

Maximum value of SAR (interpolated) = 17.5 W/kg

- **Zoom Scan (7x7x12)/Cube 0:** Measurement grid: dx=4mm, dy=4mm, dz=2mm

Reference Value = 9.448 V/m; Power Drift = 0.05 dB

Peak SAR (extrapolated) = 38.4 W/kg

SAR(1 g) = 6.3 W/kg; SAR(10 g) = 1.29 W/kg

Maximum value of SAR (measured) = 15.1 W/kg

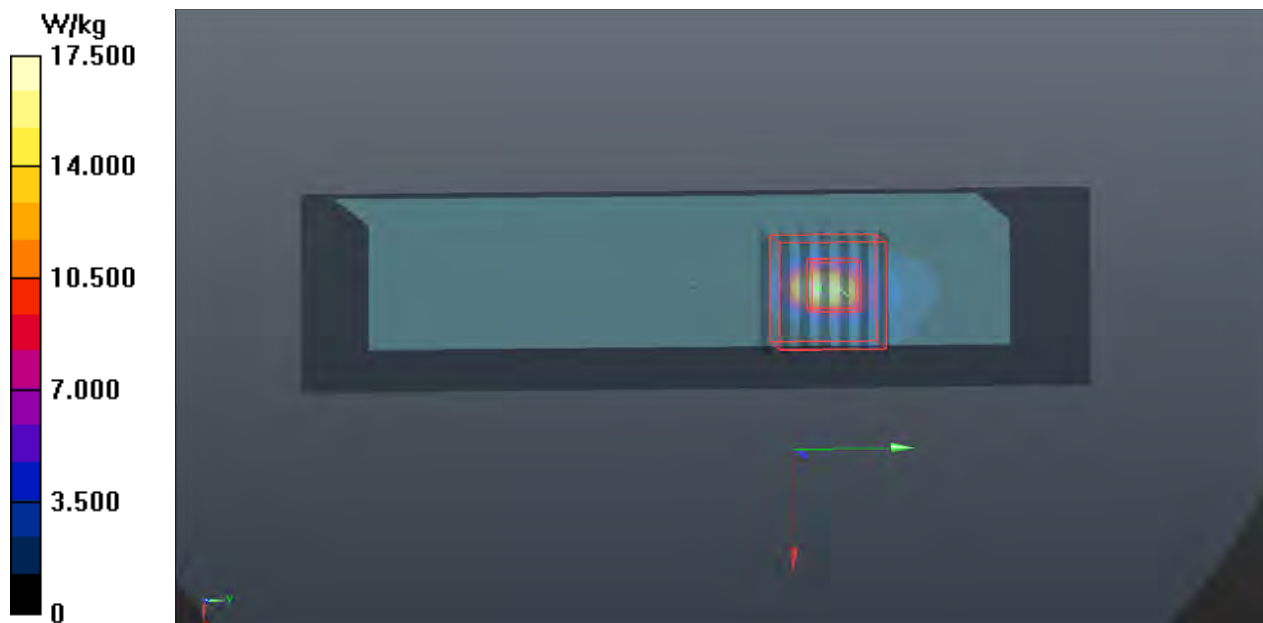

P08 802.11a_Limbs-ANT Side_0cm_Ch60

DUT: 140609E04

Communication System: WLAN_5G; Frequency: 5300 MHz; Duty Cycle: 1:1.07

Medium: B50T60N1_0628 Medium parameters used: $f = 5300$ MHz; $\sigma = 5.542$ S/m; $\epsilon_r = 47.565$; $\rho = 1000$ kg/m³

Ambient Temperature : 21.2 °C; Liquid Temperature : 20.7 °C

DASY5 Configuration:

- Probe: EX3DV4 - SN3820; ConvF(4.25, 4.25, 4.25); Calibrated: 2014/05/15;
- Sensor-Surface: 2mm (Mechanical Surface Detection)
- Electronics: DAE4 Sn1431; Calibrated: 2014/03/24
- Phantom: SAM Phantom_Left; Type: SAM V4.0; Serial: TP 1653
- Measurement SW: DASY52, Version 52.8 (8); SEMCAD X Version 14.6.10 (7331)

- **Area Scan (41x161x1):** Interpolated grid: dx=1.000 mm, dy=1.000 mm

Maximum value of SAR (interpolated) = 23.2 W/kg

- **Zoom Scan (7x7x12)/Cube 0:** Measurement grid: dx=4mm, dy=4mm, dz=2mm

Reference Value = 12.72 V/m; Power Drift = -0.05 dB

Peak SAR (extrapolated) = 52.1 W/kg

SAR(1 g) = 8.52 W/kg; SAR(10 g) = 1.73 W/kg

Maximum value of SAR (measured) = 20.7 W/kg

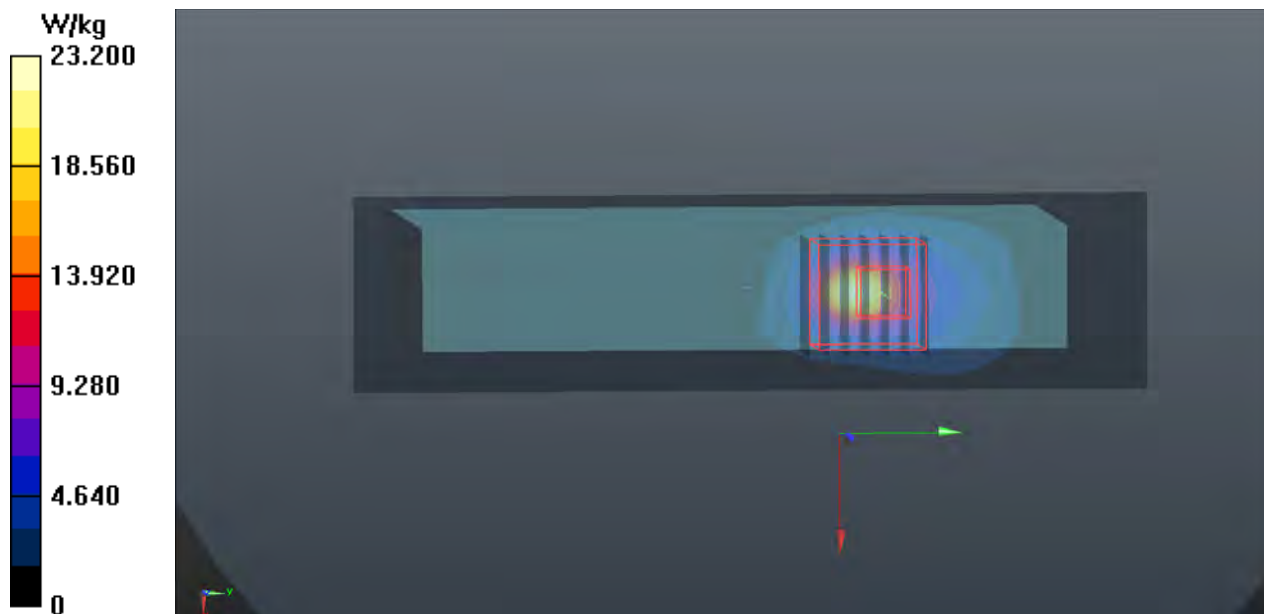

P09 802.11n_HT20_Limbs-ANT Side_0cm_Ch116

DUT: 140609E04

Communication System: WLAN_5G; Frequency: 5580 MHz; Duty Cycle: 1:1.07

Medium: B50T60N1_0628 Medium parameters used: $f = 5580$ MHz; $\sigma = 5.929$ S/m; $\epsilon_r = 46.998$; $\rho = 1000$ kg/m³

Ambient Temperature : 21.2 °C; Liquid Temperature : 20.7 °C

DASY5 Configuration:

- Probe: EX3DV4 - SN3820; ConvF(3.83, 3.83, 3.83); Calibrated: 2014/05/15;
- Sensor-Surface: 2mm (Mechanical Surface Detection)
- Electronics: DAE4 Sn1431; Calibrated: 2014/03/24
- Phantom: SAM Phantom_Left; Type: SAM V4.0; Serial: TP 1653
- Measurement SW: DASY52, Version 52.8 (8); SEMCAD X Version 14.6.10 (7331)

- **Area Scan (41x161x1)**: Interpolated grid: dx=1.000 mm, dy=1.000 mm

Maximum value of SAR (interpolated) = 15.5 W/kg

- **Zoom Scan (7x7x12)/Cube 0**: Measurement grid: dx=4mm, dy=4mm, dz=2mm

Reference Value = 12.52 V/m; Power Drift = 0.07 dB

Peak SAR (extrapolated) = 38.4 W/kg

SAR(1 g) = 6.01 W/kg; SAR(10 g) = 1.28 W/kg

Maximum value of SAR (measured) = 14.0 W/kg

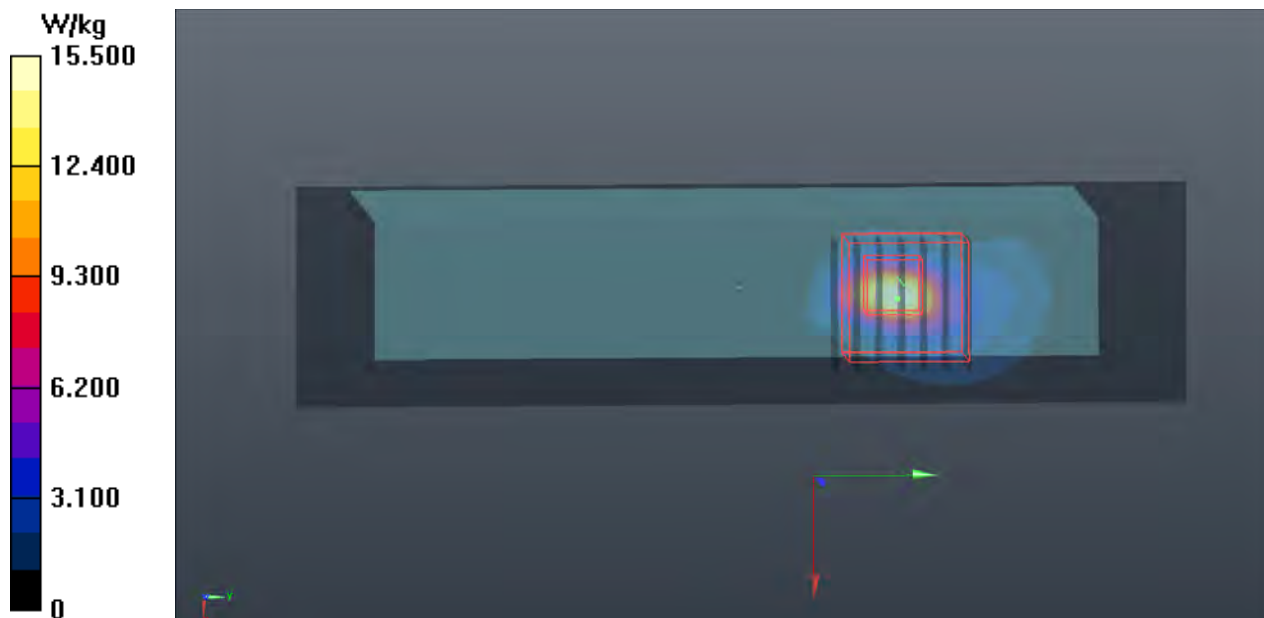

P10 802.11n_HT20_Limbs-ANT Side_0cm_Ch165

DUT: 140609E04

Communication System: WLAN_5G; Frequency: 5825 MHz; Duty Cycle: 1:1.08

Medium: B50T60N1_0628 Medium parameters used: $f = 5825$ MHz; $\sigma = 6.281$ S/m; $\epsilon_r = 46.511$; $\rho = 1000$ kg/m³

Ambient Temperature : 21.2 °C; Liquid Temperature : 20.7 °C

DASY5 Configuration:

- Probe: EX3DV4 - SN3820; ConvF(4, 4, 4); Calibrated: 2014/05/15;
- Sensor-Surface: 2mm (Mechanical Surface Detection)
- Electronics: DAE4 Sn1431; Calibrated: 2014/03/24
- Phantom: SAM Phantom_Left; Type: SAM V4.0; Serial: TP 1653
- Measurement SW: DASY52, Version 52.8 (8); SEMCAD X Version 14.6.10 (7331)

- **Area Scan (41x161x1):** Interpolated grid: dx=1.000 mm, dy=1.000 mm

Maximum value of SAR (interpolated) = 11.2 W/kg

- **Zoom Scan (7x7x12)/Cube 0:** Measurement grid: dx=4mm, dy=4mm, dz=2mm

Reference Value = 12.47 V/m; Power Drift = 0.03 dB

Peak SAR (extrapolated) = 23.5 W/kg

SAR(1 g) = 3.66 W/kg; SAR(10 g) = 0.806 W/kg

Maximum value of SAR (measured) = 9.62 W/kg

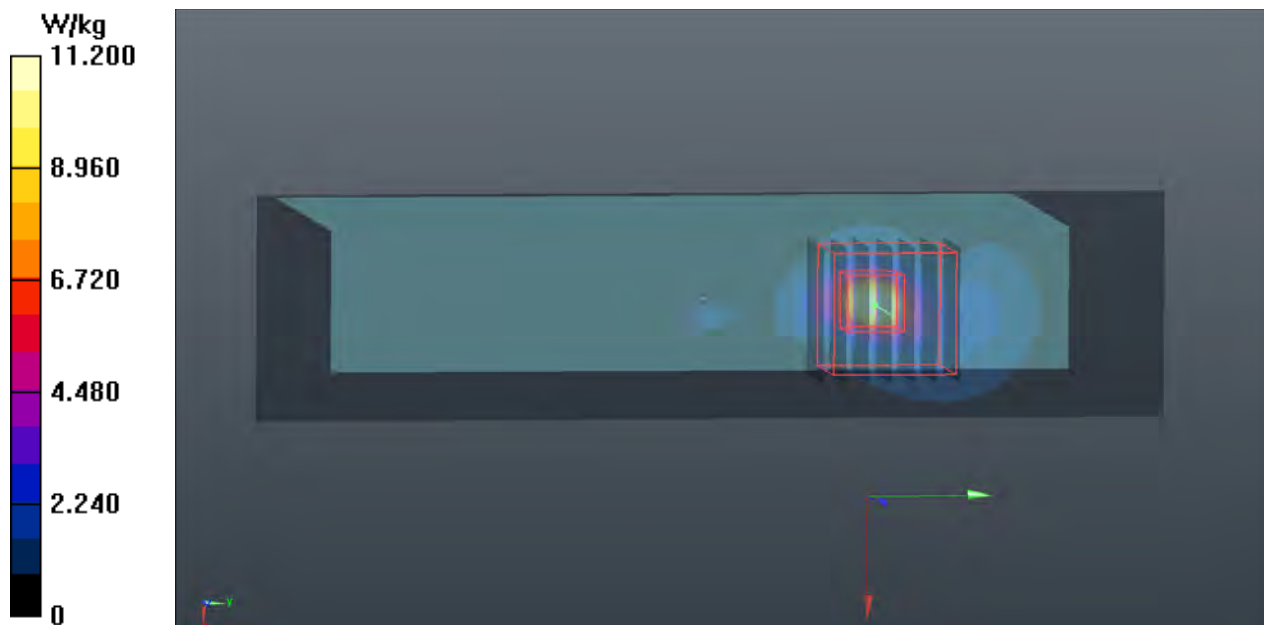



Appendix C. Calibration Certificate for Probe and Dipole

The SPEAG calibration certificates are shown as follows.



Accredited by the Swiss Accreditation Service (SAS)
The Swiss Accreditation Service is one of the signatories to the EA
Multilateral Agreement for the recognition of calibration certificates

Accreditation No.: **SCS 108**

Client **B.V. ADT (Auden)**

Certificate No: **D2450V2-716_Jul13**

CALIBRATION CERTIFICATE

Object **D2450V2 - SN: 716**

Calibration procedure(s) **QA CAL-05.v9
Calibration procedure for dipole validation kits above 700 MHz**

Calibration date: **July 31, 2013**

This calibration certificate documents the traceability to national standards, which realize the physical units of measurements (SI).
The measurements and the uncertainties with confidence probability are given on the following pages and are part of the certificate.



All calibrations have been conducted in the closed laboratory facility: environment temperature (22 ± 3)°C and humidity < 70%.

Calibration Equipment used (M&TE critical for calibration)

Primary Standards	ID #	Cal Date (Certificate No.)	Scheduled Calibration
Power meter EPM-442A	GB37480704	01-Nov-12 (No. 217-01640)	Oct-13
Power sensor HP 8481A	US37292783	01-Nov-12 (No. 217-01640)	Oct-13
Reference 20 dB Attenuator	SN: 5058 (20k)	04-Apr-13 (No. 217-01736)	Apr-14
Type-N mismatch combination	SN: 5047.3 / 06327	04-Apr-13 (No. 217-01739)	Apr-14
Reference Probe ES3DV3	SN: 3205	28-Dec-12 (No. ES3-3205_Dec12)	Dec-13
DAE4	SN: 601	25-Apr-13 (No. DAE4-601_Apr13)	Apr-14
Secondary Standards	ID #	Check Date (in house)	Scheduled Check
Power sensor HP 8481A	MY41092317	18-Oct-02 (in house check Oct-11)	In house check: Oct-13
RF generator R&S SMT-06	100005	04-Aug-99 (in house check Oct-11)	In house check: Oct-13
Network Analyzer HP 8753E	US37390585 S4206	18-Oct-01 (in house check Oct-12)	In house check: Oct-13

Calibrated by: **Israe El-Naouq** Name: **Israe El-Naouq** Function: **Laboratory Technician**

Approved by: **Katja Pokovic** Name: **Katja Pokovic** Function: **Technical Manager**

Signature



Issued: July 31, 2013

This calibration certificate shall not be reproduced except in full without written approval of the laboratory.



Accredited by the Swiss Accreditation Service (SAS)
The Swiss Accreditation Service is one of the signatories to the EA
Multilateral Agreement for the recognition of calibration certificates

Glossary:

TSL	tissue simulating liquid
ConvF	sensitivity in TSL / NORM x,y,z
N/A	not applicable or not measured

Calibration is Performed According to the Following Standards:

- IEEE Std 1528-2003, "IEEE Recommended Practice for Determining the Peak Spatial-Averaged Specific Absorption Rate (SAR) in the Human Head from Wireless Communications Devices: Measurement Techniques", December 2003
- IEC 62209-1, "Procedure to measure the Specific Absorption Rate (SAR) for hand-held devices used in close proximity to the ear (frequency range of 300 MHz to 3 GHz)", February 2005
- Federal Communications Commission Office of Engineering & Technology (FCC OET), "Evaluating Compliance with FCC Guidelines for Human Exposure to Radiofrequency Electromagnetic Fields; Additional Information for Evaluating Compliance of Mobile and Portable Devices with FCC Limits for Human Exposure to Radiofrequency Emissions", Supplement C (Edition 01-01) to Bulletin 65

Additional Documentation:

- DASY4/5 System Handbook

Methods Applied and Interpretation of Parameters:

- Measurement Conditions:** Further details are available from the Validation Report at the end of the certificate. All figures stated in the certificate are valid at the frequency indicated.
- Antenna Parameters with TSL:** The dipole is mounted with the spacer to position its feed point exactly below the center marking of the flat phantom section, with the arms oriented parallel to the body axis.
- Feed Point Impedance and Return Loss:** These parameters are measured with the dipole positioned under the liquid filled phantom. The impedance stated is transformed from the measurement at the SMA connector to the feed point. The Return Loss ensures low reflected power. No uncertainty required.
- Electrical Delay:** One-way delay between the SMA connector and the antenna feed point. No uncertainty required.
- SAR measured:** SAR measured at the stated antenna input power.
- SAR normalized:** SAR as measured, normalized to an input power of 1 W at the antenna connector.
- SAR for nominal TSL parameters:** The measured TSL parameters are used to calculate the nominal SAR result.

The reported uncertainty of measurement is stated as the standard uncertainty of measurement multiplied by the coverage factor $k=2$, which for a normal distribution corresponds to a coverage probability of approximately 95%.

Measurement Conditions

DASY system configuration, as far as not given on page 1.

DASY Version	DASY5	V52.8.7
Extrapolation	Advanced Extrapolation	
Phantom	Modular Flat Phantom	
Distance Dipole Center - TSL	10 mm	with Spacer
Zoom Scan Resolution	dx, dy, dz = 5 mm	
Frequency	2450 MHz \pm 1 MHz	

Head TSL parameters

The following parameters and calculations were applied.

	Temperature	Permittivity	Conductivity
Nominal Head TSL parameters	22.0 °C	39.2	1.80 mho/m
Measured Head TSL parameters	(22.0 \pm 0.2) °C	37.8 \pm 6 %	1.81 mho/m \pm 6 %
Head TSL temperature change during test	< 0.5 °C	----	----

SAR result with Head TSL

SAR averaged over 1 cm³ (1 g) of Head TSL	Condition	
SAR measured	250 mW input power	13.4 W/kg
SAR for nominal Head TSL parameters	normalized to 1W	53.0 W/kg \pm 17.0 % (k=2)

SAR averaged over 10 cm³ (10 g) of Head TSL	condition	
SAR measured	250 mW input power	6.21 W/kg
SAR for nominal Head TSL parameters	normalized to 1W	24.7 W/kg \pm 16.5 % (k=2)

Body TSL parameters

The following parameters and calculations were applied.

	Temperature	Permittivity	Conductivity
Nominal Body TSL parameters	22.0 °C	52.7	1.95 mho/m
Measured Body TSL parameters	(22.0 \pm 0.2) °C	50.5 \pm 6 %	2.01 mho/m \pm 6 %
Body TSL temperature change during test	< 0.5 °C	----	----

SAR result with Body TSL

SAR averaged over 1 cm³ (1 g) of Body TSL	Condition	
SAR measured	250 mW input power	12.8 W/kg
SAR for nominal Body TSL parameters	normalized to 1W	50.0 W/kg \pm 17.0 % (k=2)

SAR averaged over 10 cm³ (10 g) of Body TSL	condition	
SAR measured	250 mW input power	5.93 W/kg
SAR for nominal Body TSL parameters	normalized to 1W	23.4 W/kg \pm 16.5 % (k=2)

Appendix

Antenna Parameters with Head TSL

Impedance, transformed to feed point	54.5 Ω + 1.7 j Ω
Return Loss	- 26.8 dB

Antenna Parameters with Body TSL

Impedance, transformed to feed point	50.8 Ω + 3.8 j Ω
Return Loss	- 28.3 dB

General Antenna Parameters and Design

Electrical Delay (one direction)	1.142 ns
----------------------------------	----------

After long term use with 100W radiated power, only a slight warming of the dipole near the feedpoint can be measured.

The dipole is made of standard semirigid coaxial cable. The center conductor of the feeding line is directly connected to the second arm of the dipole. The antenna is therefore short-circuited for DC-signals. On some of the dipoles, small end caps are added to the dipole arms in order to improve matching when loaded according to the position as explained in the "Measurement Conditions" paragraph. The SAR data are not affected by this change. The overall dipole length is still according to the Standard.

No excessive force must be applied to the dipole arms, because they might bend or the soldered connections near the feedpoint may be damaged.

Additional EUT Data

Manufactured by	SPEAG
Manufactured on	September 10, 2002

DASY5 Validation Report for Head TSL

Date: 31.07.2013

Test Laboratory: SPEAG, Zurich, Switzerland

DUT: Dipole 2450 MHz; Type: D2450V2; Serial: D2450V2 - SN: 716

Communication System: UID 0 - CW; Frequency: 2450 MHz

Medium parameters used: $f = 2450$ MHz; $\sigma = 1.81$ S/m; $\epsilon_r = 37.8$; $\rho = 1000$ kg/m³

Phantom section: Flat Section

Measurement Standard: DASY5 (IEEE/IEC/ANSI C63.19-2007)

DASY52 Configuration:

- Probe: ES3DV3 - SN3205; ConvF(4.52, 4.52, 4.52); Calibrated: 28.12.2012;
- Sensor-Surface: 3mm (Mechanical Surface Detection)
- Electronics: DAE4 Sn601; Calibrated: 25.04.2013
- Phantom: Flat Phantom 5.0 (front); Type: QD000P50AA; Serial: 1001
- DASY52 52.8.7(1137); SEMCAD X 14.6.10(7164)

Dipole Calibration for Head Tissue/Pin=250 mW, d=10mm/Zoom Scan (7x7x7)/Cube 0:

Measurement grid: dx=5mm, dy=5mm, dz=5mm

Reference Value = 94.443 V/m; Power Drift = 0.02 dB

Peak SAR (extrapolated) = 27.7 W/kg

SAR(1 g) = 13.4 W/kg; SAR(10 g) = 6.21 W/kg

Maximum value of SAR (measured) = 17.2 W/kg

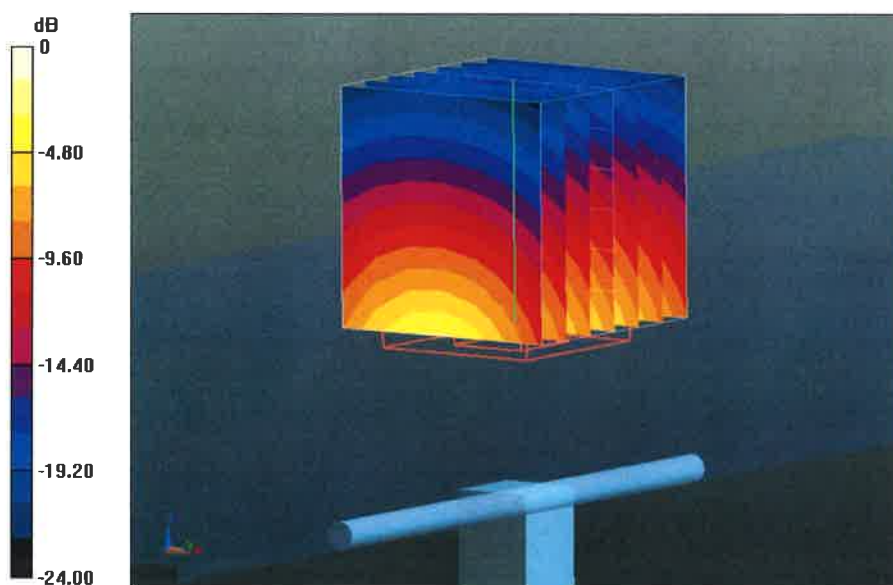

0 dB = 17.2 W/kg = 12.36 dBW/kg

Impedance Measurement Plot for Head TSL

31 Jul 2013 10:31:38
CH1 S11 1 U FS 1: 54.498 Ω 1.6699 Ω 108.48 pF 2 450.000 000 MHz

*
De 1

CA

Avg
16

H1 d

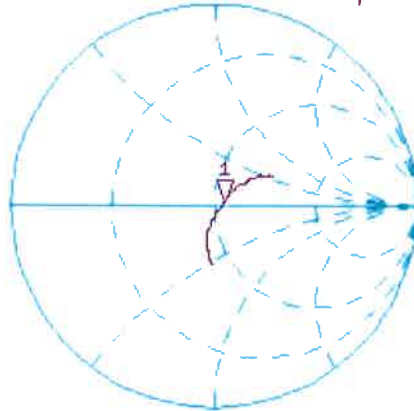

CH2 S11 LOG 5 dB/REF -20 dB 1: -26.757 dB 2 450.000 000 MHz

CA

Avg
16

H1 d



DASY5 Validation Report for Body TSL

Date: 31.07.2013

Test Laboratory: SPEAG, Zurich, Switzerland

DUT: Dipole 2450 MHz; Type: D2450V2; Serial: D2450V2 - SN: 716

Communication System: UID 0 - CW; Frequency: 2450 MHz

Medium parameters used: $f = 2450$ MHz; $\sigma = 2.01$ S/m; $\epsilon_r = 50.5$; $\rho = 1000$ kg/m³

Phantom section: Flat Section

Measurement Standard: DASY5 (IEEE/IEC/ANSI C63.19-2007)

DASY52 Configuration:

- Probe: ES3DV3 - SN3205; ConvF(4.42, 4.42, 4.42); Calibrated: 28.12.2012;
- Sensor-Surface: 3mm (Mechanical Surface Detection)
- Electronics: DAE4 Sn601; Calibrated: 25.04.2013
- Phantom: Flat Phantom 5.0 (back); Type: QD000P50AA; Serial: 1002
- DASY52 52.8.7(1137); SEMCAD X 14.6.10(7164)

Dipole Calibration for Body Tissue/Pin=250 mW, d=10mm/Zoom Scan (7x7x7)/Cube 0:

Measurement grid: dx=5mm, dy=5mm, dz=5mm

Reference Value = 94.443 V/m; Power Drift = 0.02 dB

Peak SAR (extrapolated) = 26.6 W/kg

SAR(1 g) = 12.8 W/kg; SAR(10 g) = 5.93 W/kg

Maximum value of SAR (measured) = 16.9 W/kg

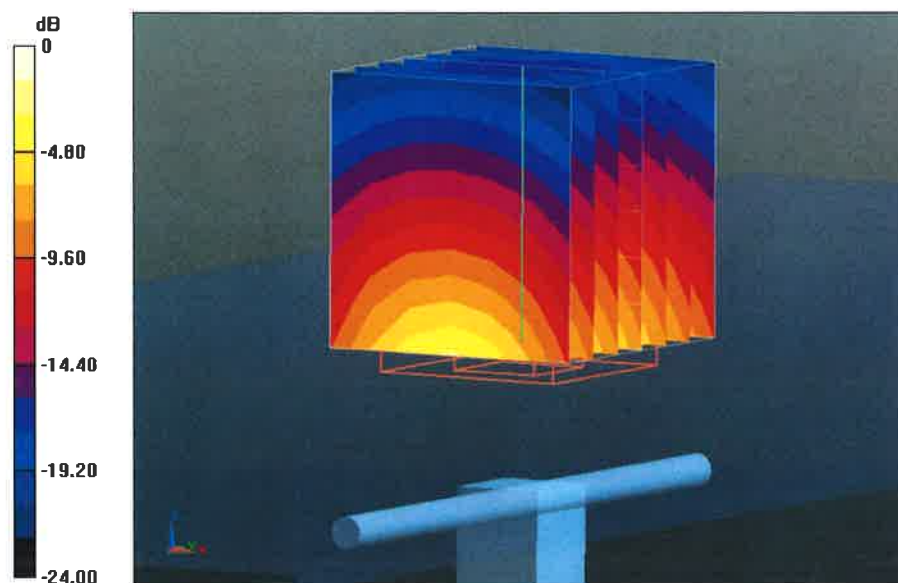

Impedance Measurement Plot for Body TSL

31 Jul 2013 10:30:34
CH1 S11 1 U FS 1: 50.787 Ω 3.7910 Ω 246.27 pF 2 450.000 000 MHz

*
De1

CA

Av9
16

H1d

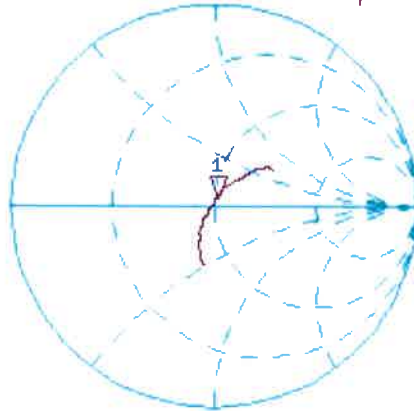

CH2 S11 LOG 5 dB/REF -20 dB 1:-28.308 dB 2 450.000 000 MHz

CA

Av9
16

H1d

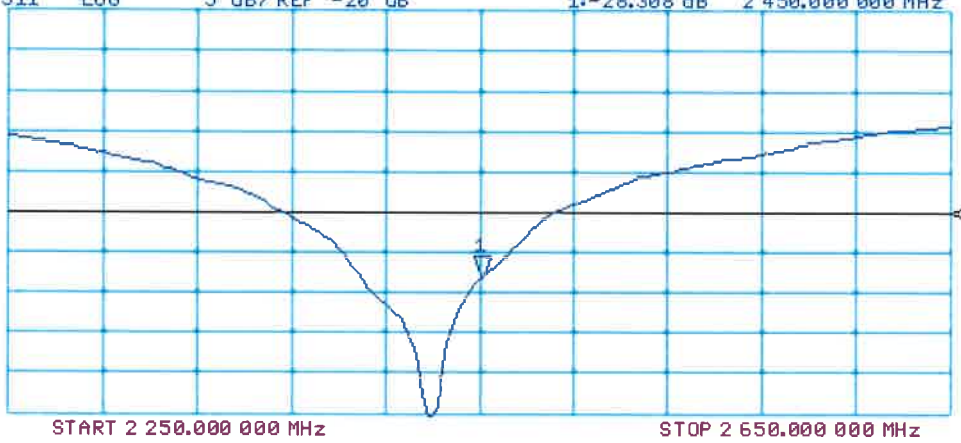



Accredited by the Swiss Accreditation Service (SAS)
The Swiss Accreditation Service is one of the signatories to the EA
Multilateral Agreement for the recognition of calibration certificates

Accreditation No.: **SCS 108**

Client **B.V. ADT (Auden)**

Certificate No: **D5GHzV2-1018_Jul13**

CALIBRATION CERTIFICATE

Object **D5GHzV2 - SN: 1018**

Calibration procedure(s) **QA CAL-22.v2
Calibration procedure for dipole validation kits between 3-6 GHz**

Calibration date: **July 24, 2013**

This calibration certificate documents the traceability to national standards, which realize the physical units of measurements (SI).
The measurements and the uncertainties with confidence probability are given on the following pages and are part of the certificate.

All calibrations have been conducted in the closed laboratory facility: environment temperature (22 ± 3)°C and humidity < 70%.

Calibration Equipment used (M&TE critical for calibration)

Primary Standards	ID #	Cal Date (Certificate No.)	Scheduled Calibration
Power meter EPM-442A	GB37480704	01-Nov-12 (No. 217-01640)	Oct-13
Power sensor HP 8481A	US37292783	01-Nov-12 (No. 217-01640)	Oct-13
Reference 20 dB Attenuator	SN: 5058 (20k)	04-Apr-13 (No. 217-01736)	Apr-14
Type-N mismatch combination	SN: 5047.3 / 06327	04-Apr-13 (No. 217-01739)	Apr-14
Reference Probe EX3DV4	SN: 3503	28-Dec-12 (No. EX3-3503_Dec12)	Dec-13
DAE4	SN: 601	25-Apr-13 (No. DAE4-601_Apr13)	Apr-14

Secondary Standards	ID #	Check Date (in house)	Scheduled Check
Power sensor HP 8481A	MY41092317	18-Oct-02 (in house check Oct-11)	In house check: Oct-13
RF generator R&S SMT-06	100005	04-Aug-99 (in house check Oct-11)	In house check: Oct-13
Network Analyzer HP 8753E	US37390585 S4206	18-Oct-01 (in house check Oct-12)	In house check: Oct-13

Calibrated by: **Jeton Kastrati** Name: **Jeton Kastrati** Function: **Laboratory Technician**

Approved by: **Katja Pokovic** Name: **Katja Pokovic** Function: **Technical Manager**

Signature



Issued: July 24, 2013

This calibration certificate shall not be reproduced except in full without written approval of the laboratory.



Accredited by the Swiss Accreditation Service (SAS)

The Swiss Accreditation Service is one of the signatories to the EA
Multilateral Agreement for the recognition of calibration certificates

Accreditation No.: **SCS 108**

Glossary:

TSL	tissue simulating liquid
ConvF	sensitivity in TSL / NORM x,y,z
N/A	not applicable or not measured

Calibration is Performed According to the Following Standards:

- a) IEC 62209-2, "Evaluation of Human Exposure to Radio Frequency Fields from Handheld and Body-Mounted Wireless Communication Devices in the Frequency Range of 30 MHz to 6 GHz: Human models, Instrumentation, and Procedures"; Part 2: "Procedure to determine the Specific Absorption Rate (SAR) for including accessories and multiple transmitters", March 2010
- b) Federal Communications Commission Office of Engineering & Technology (FCC OET), "Evaluating Compliance with FCC Guidelines for Human Exposure to Radiofrequency Electromagnetic Fields; Additional Information for Evaluating Compliance of Mobile and Portable Devices with FCC Limits for Human Exposure to Radiofrequency Emissions", Supplement C (Edition 01-01) to Bulletin 65

Additional Documentation:

- c) DASY4/5 System Handbook

Methods Applied and Interpretation of Parameters:

- *Measurement Conditions:* Further details are available from the Validation Report at the end of the certificate. All figures stated in the certificate are valid at the frequency indicated.
- *Antenna Parameters with TSL:* The dipole is mounted with the spacer to position its feed point exactly below the center marking of the flat phantom section, with the arms oriented parallel to the body axis.
- *Feed Point Impedance and Return Loss:* These parameters are measured with the dipole positioned under the liquid filled phantom. The impedance stated is transformed from the measurement at the SMA connector to the feed point. The Return Loss ensures low reflected power. No uncertainty required.
- *Electrical Delay:* One-way delay between the SMA connector and the antenna feed point. No uncertainty required.
- *SAR measured:* SAR measured at the stated antenna input power.
- *SAR normalized:* SAR as measured, normalized to an input power of 1 W at the antenna connector.
- *SAR for nominal TSL parameters:* The measured TSL parameters are used to calculate the nominal SAR result.

The reported uncertainty of measurement is stated as the standard uncertainty of measurement multiplied by the coverage factor $k=2$, which for a normal distribution corresponds to a coverage probability of approximately 95%.

Measurement Conditions

DASY system configuration, as far as not given on page 1.

DASY Version	DASY5	V52.8.7
Extrapolation	Advanced Extrapolation	
Phantom	Modular Flat Phantom V5.0	
Distance Dipole Center - TSL	10 mm	with Spacer
Zoom Scan Resolution	dx, dy = 4.0 mm, dz = 1.4 mm	Graded Ratio = 1.4 (Z direction)
Frequency	5200 MHz ± 1 MHz 5300 MHz ± 1 MHz 5600 MHz ± 1 MHz 5800 MHz ± 1 MHz	

Head TSL parameters at 5200 MHz

The following parameters and calculations were applied.

	Temperature	Permittivity	Conductivity
Nominal Head TSL parameters	22.0 °C	36.0	4.66 mho/m
Measured Head TSL parameters	(22.0 ± 0.2) °C	35.2 ± 6 %	4.46 mho/m ± 6 %
Head TSL temperature change during test	< 0.5 °C	----	----

SAR result with Head TSL at 5200 MHz

SAR averaged over 1 cm³ (1 g) of Head TSL	Condition	
SAR measured	100 mW input power	7.97 W/kg
SAR for nominal Head TSL parameters	normalized to 1W	79.2 W/kg ± 19.9 % (k=2)

SAR averaged over 10 cm³ (10 g) of Head TSL	condition	
SAR measured	100 mW input power	2.29 W/kg
SAR for nominal Head TSL parameters	normalized to 1W	22.7 W/kg ± 19.5 % (k=2)

Head TSL parameters at 5300 MHz

The following parameters and calculations were applied.

	Temperature	Permittivity	Conductivity
Nominal Head TSL parameters	22.0 °C	35.9	4.76 mho/m
Measured Head TSL parameters	(22.0 ± 0.2) °C	35.1 ± 6 %	4.55 mho/m ± 6 %
Head TSL temperature change during test	< 0.5 °C	----	----

SAR result with Head TSL at 5300 MHz

SAR averaged over 1 cm ³ (1 g) of Head TSL	Condition	
SAR measured	100 mW input power	8.31 W/kg
SAR for nominal Head TSL parameters	normalized to 1W	82.6 W / kg ± 19.9 % (k=2)

SAR averaged over 10 cm ³ (10 g) of Head TSL	condition	
SAR measured	100 mW input power	2.39 W/kg
SAR for nominal Head TSL parameters	normalized to 1W	23.7 W/kg ± 19.5 % (k=2)

Head TSL parameters at 5600 MHz

The following parameters and calculations were applied.

	Temperature	Permittivity	Conductivity
Nominal Head TSL parameters	22.0 °C	35.5	5.07 mho/m
Measured Head TSL parameters	(22.0 ± 0.2) °C	34.7 ± 6 %	4.85 mho/m ± 6 %
Head TSL temperature change during test	< 0.5 °C	----	----

SAR result with Head TSL at 5600 MHz

SAR averaged over 1 cm ³ (1 g) of Head TSL	Condition	
SAR measured	100 mW input power	8.34 W/kg
SAR for nominal Head TSL parameters	normalized to 1W	82.8 W/kg ± 19.9 % (k=2)

SAR averaged over 10 cm ³ (10 g) of Head TSL	condition	
SAR measured	100 mW input power	2.38 W/kg
SAR for nominal Head TSL parameters	normalized to 1W	23.6 W/kg ± 19.5 % (k=2)

Head TSL parameters at 5800 MHz

The following parameters and calculations were applied.

	Temperature	Permittivity	Conductivity
Nominal Head TSL parameters	22.0 °C	35.3	5.27 mho/m
Measured Head TSL parameters	(22.0 ± 0.2) °C	34.4 ± 6 %	5.05 mho/m ± 6 %
Head TSL temperature change during test	< 0.5 °C	----	----

SAR result with Head TSL at 5800 MHz

SAR averaged over 1 cm ³ (1 g) of Head TSL	Condition	
SAR measured	100 mW input power	8.01 W/kg
SAR for nominal Head TSL parameters	normalized to 1W	79.5 W/kg ± 19.9 % (k=2)

SAR averaged over 10 cm ³ (10 g) of Head TSL	condition	
SAR measured	100 mW input power	2.28 W/kg
SAR for nominal Head TSL parameters	normalized to 1W	22.6 W/kg ± 19.5 % (k=2)

Body TSL parameters at 5200 MHz

The following parameters and calculations were applied.

	Temperature	Permittivity	Conductivity
Nominal Body TSL parameters	22.0 °C	49.0	5.30 mho/m
Measured Body TSL parameters	(22.0 ± 0.2) °C	48.9 ± 6 %	5.40 mho/m ± 6 %
Body TSL temperature change during test	< 0.5 °C	----	----

SAR result with Body TSL at 5200 MHz

SAR averaged over 1 cm ³ (1 g) of Body TSL	Condition	
SAR measured	100 mW input power	7.49 W/kg
SAR for nominal Body TSL parameters	normalized to 1W	74.9 W/kg ± 19.9 % (k=2)

SAR averaged over 10 cm ³ (10 g) of Body TSL	condition	
SAR measured	100 mW input power	2.10 W/kg
SAR for nominal Body TSL parameters	normalized to 1W	21.0 W/kg ± 19.5 % (k=2)

Body TSL parameters at 5300 MHz

The following parameters and calculations were applied.

	Temperature	Permittivity	Conductivity
Nominal Body TSL parameters	22.0 °C	48.9	5.42 mho/m
Measured Body TSL parameters	(22.0 ± 0.2) °C	46.8 ± 6 %	5.55 mho/m ± 6 %
Body TSL temperature change during test	< 0.5 °C	----	----

SAR result with Body TSL at 5300 MHz

SAR averaged over 1 cm ³ (1 g) of Body TSL	Condition	
SAR measured	100 mW input power	7.63 W/kg
SAR for nominal Body TSL parameters	normalized to 1W	75.7 W/kg ± 19.9 % (k=2)

SAR averaged over 10 cm ³ (10 g) of Body TSL	condition	
SAR measured	100 mW input power	2.15 W/kg
SAR for nominal Body TSL parameters	normalized to 1W	21.3 W/kg ± 19.5 % (k=2)

Body TSL parameters at 5600 MHz

The following parameters and calculations were applied.

	Temperature	Permittivity	Conductivity
Nominal Body TSL parameters	22.0 °C	48.5	5.77 mho/m
Measured Body TSL parameters	(22.0 ± 0.2) °C	48.2 ± 6 %	5.93 mho/m ± 6 %
Body TSL temperature change during test	< 0.5 °C	----	----

SAR result with Body TSL at 5600 MHz

SAR averaged over 1 cm ³ (1 g) of Body TSL	Condition	
SAR measured	100 mW input power	8.04 W/kg
SAR for nominal Body TSL parameters	normalized to 1W	80.4 W/kg ± 19.9 % (k=2)

SAR averaged over 10 cm ³ (10 g) of Body TSL	condition	
SAR measured	100 mW input power	2.24 W/kg
SAR for nominal Body TSL parameters	normalized to 1W	22.4 W/kg ± 19.5 % (k=2)

Body TSL parameters at 5800 MHz

The following parameters and calculations were applied.

	Temperature	Permittivity	Conductivity
Nominal Body TSL parameters	22.0 °C	48.2	6.00 mho/m
Measured Body TSL parameters	(22.0 ± 0.2) °C	47.9 ± 6 %	6.21 mho/m ± 6 %
Body TSL temperature change during test	< 0.5 °C	----	----

SAR result with Body TSL at 5800 MHz

SAR averaged over 1 cm ³ (1 g) of Body TSL	Condition	
SAR measured	100 mW input power	7.49 W/kg
SAR for nominal Body TSL parameters	normalized to 1W	74.9 W/kg ± 19.9 % (k=2)

SAR averaged over 10 cm ³ (10 g) of Body TSL	condition	
SAR measured	100 mW input power	2.08 W/kg
SAR for nominal Body TSL parameters	normalized to 1W	20.8 W/kg ± 19.5 % (k=2)

Appendix

Antenna Parameters with Head TSL at 5200 MHz

Impedance, transformed to feed point	52.0 Ω - 8.6 j Ω
Return Loss	- 21.3 dB

Antenna Parameters with Head TSL at 5300 MHz

Impedance, transformed to feed point	54.0 Ω - 1.4 j Ω
Return Loss	- 27.9 dB

Antenna Parameters with Head TSL at 5600 MHz

Impedance, transformed to feed point	54.7 Ω - 6.5 j Ω
Return Loss	- 22.4 dB

Antenna Parameters with Head TSL at 5800 MHz

Impedance, transformed to feed point	54.3 Ω + 0.8 j Ω
Return Loss	- 27.6 dB

Antenna Parameters with Body TSL at 5200 MHz

Impedance, transformed to feed point	51.1 Ω - 8.4 j Ω
Return Loss	- 21.5 dB

Antenna Parameters with Body TSL at 5300 MHz

Impedance, transformed to feed point	53.7 Ω - 1.8 j Ω
Return Loss	- 28.1 dB

Antenna Parameters with Body TSL at 5600 MHz

Impedance, transformed to feed point	56.2 Ω - 3.1 j Ω
Return Loss	- 23.7 dB

Antenna Parameters with Body TSL at 5800 MHz

Impedance, transformed to feed point	57.1 Ω + 3.7 j Ω
Return Loss	- 22.6 dB

General Antenna Parameters and Design

Electrical Delay (one direction)	1.202 ns
----------------------------------	----------

After long term use with 100W radiated power, only a slight warming of the dipole near the feedpoint can be measured.

The dipole is made of standard semirigid coaxial cable. The center conductor of the feeding line is directly connected to the second arm of the dipole. The antenna is therefore short-circuited for DC-signals. On some of the dipoles, small end caps are added to the dipole arms in order to improve matching when loaded according to the position as explained in the "Measurement Conditions" paragraph. The SAR data are not affected by this change. The overall dipole length is still according to the Standard.

No excessive force must be applied to the dipole arms, because they might bend or the soldered connections near the feedpoint may be damaged.

Additional EUT Data

Manufactured by	SPEAG
Manufactured on	February 05, 2004

DASY5 Validation Report for Head TSL

Date: 23.07.2013

Test Laboratory: SPEAG, Zurich, Switzerland

DUT: Dipole 5GHz; Type: D5GHzV2; Serial: D5GHzV2 - SN: 1018

Communication System: UID 0 - CW ; Frequency: 5200 MHz, Frequency: 5300 MHz, Frequency: 5600 MHz, Frequency: 5800 MHz

Medium parameters used: $f = 5200$ MHz; $\sigma = 4.46$ S/m; $\epsilon_r = 35.2$; $\rho = 1000$ kg/m³, Medium parameters used: $f = 5300$ MHz; $\sigma = 4.55$ S/m; $\epsilon_r = 35.1$; $\rho = 1000$ kg/m³, Medium parameters used: $f = 5600$ MHz; $\sigma = 4.85$ S/m; $\epsilon_r = 34.7$; $\rho = 1000$ kg/m³, Medium parameters used: $f = 5800$ MHz; $\sigma = 5.05$ S/m; $\epsilon_r = 34.4$; $\rho = 1000$ kg/m³

Phantom section: Flat Section

Measurement Standard: DASY5 (IEEE/IEC/ANSI C63.19-2007)

DASY52 Configuration:

- Probe: EX3DV4 - SN3503; ConvF(5.41, 5.41, 5.41); Calibrated: 28.12.2012, ConvF(5.1, 5.1, 5.1); Calibrated: 28.12.2012, ConvF(4.76, 4.76, 4.76); Calibrated: 28.12.2012, ConvF(4.81, 4.81, 4.81); Calibrated: 28.12.2012;
- Sensor-Surface: 1.4mm (Mechanical Surface Detection)
- Electronics: DAE4 Sn601; Calibrated: 25.04.2013
- Phantom: Flat Phantom 5.0 (front); Type: QD000P50AA; Serial: 1001
- DASY52 52.8.7(1137); SEMCAD X 14.6.10(7164)

Dipole Calibration for Head Tissue/Pin=100mW, dist=10mm, f=5200 MHz/Zoom Scan, dist=1.4mm (8x8x7)/Cube 0: Measurement grid: dx=4mm, dy=4mm, dz=1.4mm

Reference Value = 63.126 V/m; Power Drift = 0.09 dB

Peak SAR (extrapolated) = 28.9 W/kg

SAR(1 g) = 7.97 W/kg; SAR(10 g) = 2.29 W/kg

Maximum value of SAR (measured) = 18.4 W/kg

Dipole Calibration for Head Tissue/Pin=100mW, dist=10mm, f=5300 MHz/Zoom Scan, dist=1.4mm (8x8x7)/Cube 0: Measurement grid: dx=4mm, dy=4mm, dz=1.4mm

Reference Value = 64.006 V/m; Power Drift = 0.01 dB

Peak SAR (extrapolated) = 30.8 W/kg

SAR(1 g) = 8.31 W/kg; SAR(10 g) = 2.39 W/kg

Maximum value of SAR (measured) = 19.5 W/kg

Dipole Calibration for Head Tissue/Pin=100mW, dist=10mm, f=5600 MHz/Zoom Scan, dist=1.4mm (8x8x7)/Cube 0: Measurement grid: dx=4mm, dy=4mm, dz=1.4mm

Reference Value = 62.606 V/m; Power Drift = 0.08 dB

Peak SAR (extrapolated) = 32.4 W/kg

SAR(1 g) = 8.34 W/kg; SAR(10 g) = 2.38 W/kg

Maximum value of SAR (measured) = 20.0 W/kg

Dipole Calibration for Head Tissue/Pin=100mW, dist=10mm, f=5800 MHz/Zoom Scan, dist=1.4mm (8x8x7)/Cube 0: Measurement grid: dx=4mm, dy=4mm, dz=1.4mm
Reference Value = 60.010 V/m; Power Drift = 0.09 dB
Peak SAR (extrapolated) = 32.6 W/kg
SAR(1 g) = 8.01 W/kg; SAR(10 g) = 2.28 W/kg

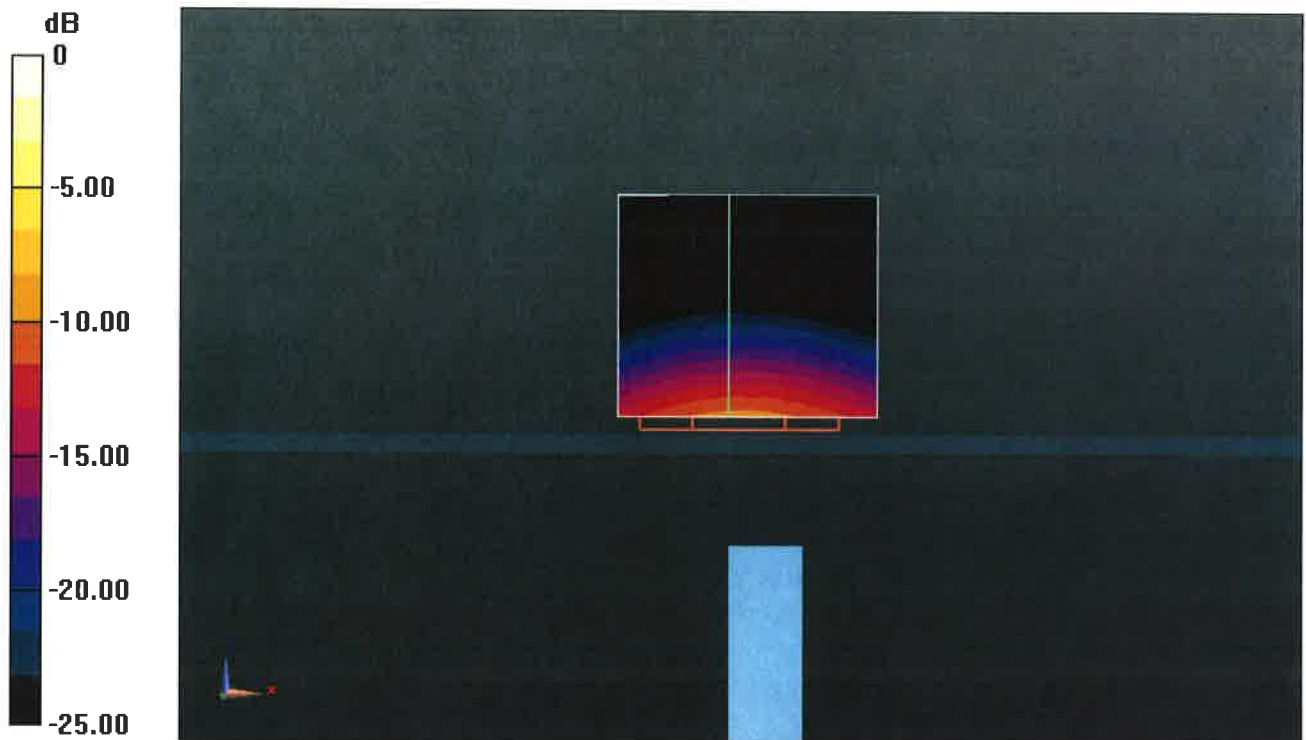

0 dB = 19.5 W/kg = 12.90 dBW/kg

Impedance Measurement Plot for Head TSL

23 Jul 2013 12:09:28

CH1 S11 1 U FS

1: 51.992 Ω -8.6035 Ω 3.5575 pF 5 200.000 000 MHz

*
De1
Cor
Avg
16
H1 d

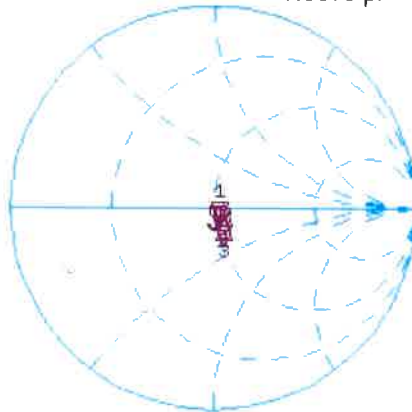

CH1 Markers
2: 53.961 Ω
-1.4277 Ω
5.30000 GHz
3: 54.682 Ω
-6.4609 Ω
5.60000 GHz
4: 54.260 Ω
0.8125 Ω
5.80000 GHz

CH2 S11 L06 5 dB/REF -20 dB 1: -21.282 dB 5 200.000 000 MHz

Cor
Avg
16
H1 d



CH2 Markers
2: -27.851 dB
5.30000 GHz
3: -22.371 dB
5.60000 GHz
4: -27.623 dB
5.80000 GHz

START 5 000.000 000 MHz

STOP 6 000.000 000 MHz

DASY5 Validation Report for Body TSL

Date: 24.07.2013

Test Laboratory: SPEAG, Zurich, Switzerland

DUT: Dipole 5GHz; Type: D5GHzV2; Serial: D5GHzV2 - SN: 1018

Communication System: UID 0 - CW ; Frequency: 5200 MHz, Frequency: 5300 MHz, Frequency: 5600 MHz, Frequency: 5800 MHz

Medium parameters used: $f = 5200$ MHz; $\sigma = 5.4$ S/m; $\epsilon_r = 48.9$; $\rho = 1000$ kg/m³, Medium parameters used: $f = 5300$ MHz; $\sigma = 5.55$ S/m; $\epsilon_r = 46.8$; $\rho = 1000$ kg/m³, Medium parameters used: $f = 5600$ MHz; $\sigma = 5.93$ S/m; $\epsilon_r = 48.2$; $\rho = 1000$ kg/m³, Medium parameters used: $f = 5800$ MHz; $\sigma = 6.21$ S/m; $\epsilon_r = 47.9$; $\rho = 1000$ kg/m³

Phantom section: Flat Section

Measurement Standard: DASY5 (IEEE/IEC/ANSI C63.19-2007)

DASY52 Configuration:

- Probe: EX3DV4 - SN3503; ConvF(4.91, 4.91, 4.91); Calibrated: 28.12.2012, ConvF(4.67, 4.67, 4.67); Calibrated: 28.12.2012, ConvF(4.22, 4.22, 4.22); Calibrated: 28.12.2012, ConvF(4.38, 4.38, 4.38); Calibrated: 28.12.2012;
- Sensor-Surface: 1.4mm (Mechanical Surface Detection)
- Electronics: DAE4 Sn601; Calibrated: 25.04.2013
- Phantom: Flat Phantom 5.0 (back); Type: QD000P50AA; Serial: 1002
- DASY52 52.8.7(1137); SEMCAD X 14.6.10(7164)

Dipole Calibration for Body Tissue/Pin=100mW, dist=10mm, f=5200 MHz/Zoom Scan, dist=1.4mm (8x8x7)/Cube 0: Measurement grid: dx=4mm, dy=4mm, dz=1.4mm

Reference Value = 59.030 V/m; Power Drift = -0.03 dB

Peak SAR (extrapolated) = 29.0 W/kg

SAR(1 g) = 7.49 W/kg; SAR(10 g) = 2.1 W/kg

Maximum value of SAR (measured) = 17.4 W/kg

Dipole Calibration for Body Tissue/Pin=100mW, dist=10mm, f=5300 MHz/Zoom Scan, dist=1.4mm (8x8x7)/Cube 0: Measurement grid: dx=4mm, dy=4mm, dz=1.4mm

Reference Value = 59.012 V/m; Power Drift = -0.01 dB

Peak SAR (extrapolated) = 30.3 W/kg

SAR(1 g) = 7.63 W/kg; SAR(10 g) = 2.15 W/kg

Maximum value of SAR (measured) = 17.8 W/kg

Dipole Calibration for Body Tissue/Pin=100mW, dist=10mm, f=5600 MHz/Zoom Scan, dist=1.4mm (8x8x7)/Cube 0: Measurement grid: dx=4mm, dy=4mm, dz=1.4mm

Reference Value = 58.525 V/m; Power Drift = -0.02 dB

Peak SAR (extrapolated) = 34.9 W/kg

SAR(1 g) = 8.04 W/kg; SAR(10 g) = 2.24 W/kg

Maximum value of SAR (measured) = 19.4 W/kg

Dipole Calibration for Body Tissue/Pin=100mW, dist=10mm, f=5800 MHz/Zoom Scan, dist=1.4mm (8x8x7)/Cube 0: Measurement grid: dx=4mm, dy=4mm, dz=1.4mm
Reference Value = 55.098 V/m; Power Drift = 0.01 dB
Peak SAR (extrapolated) = 34.3 W/kg
SAR(1 g) = 7.49 W/kg; SAR(10 g) = 2.08 W/kg
Maximum value of SAR (measured) = 18.3 W/kg

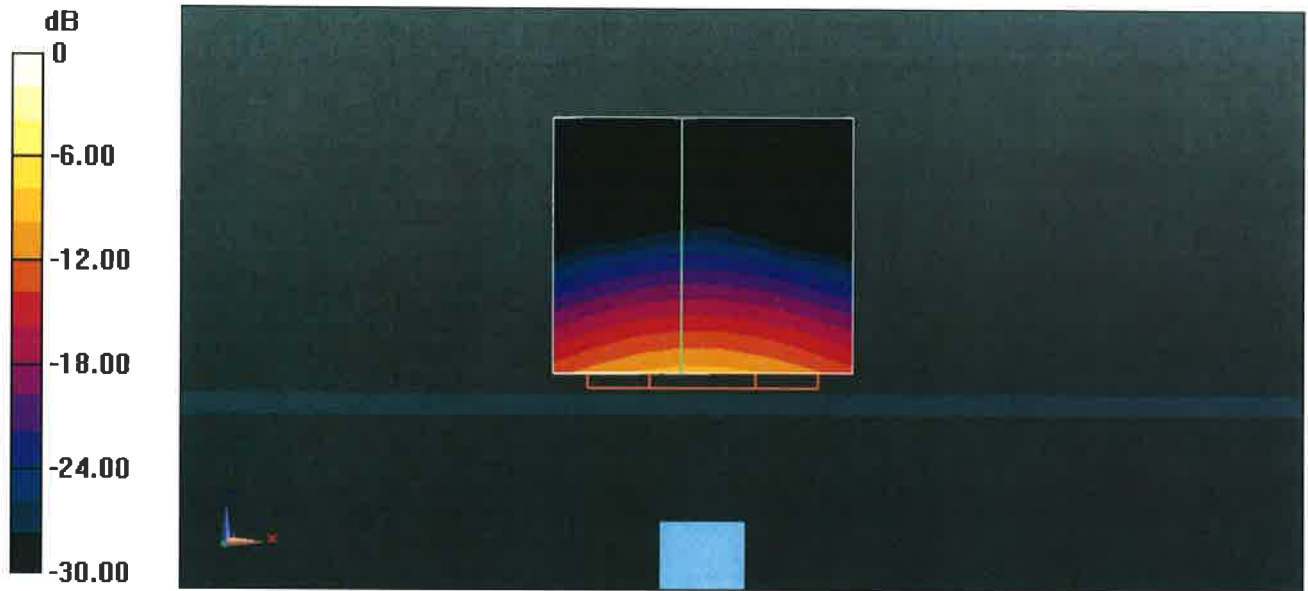

0 dB = 18.3 W/kg = 12.62 dBW/kg

Impedance Measurement Plot for Body TSL

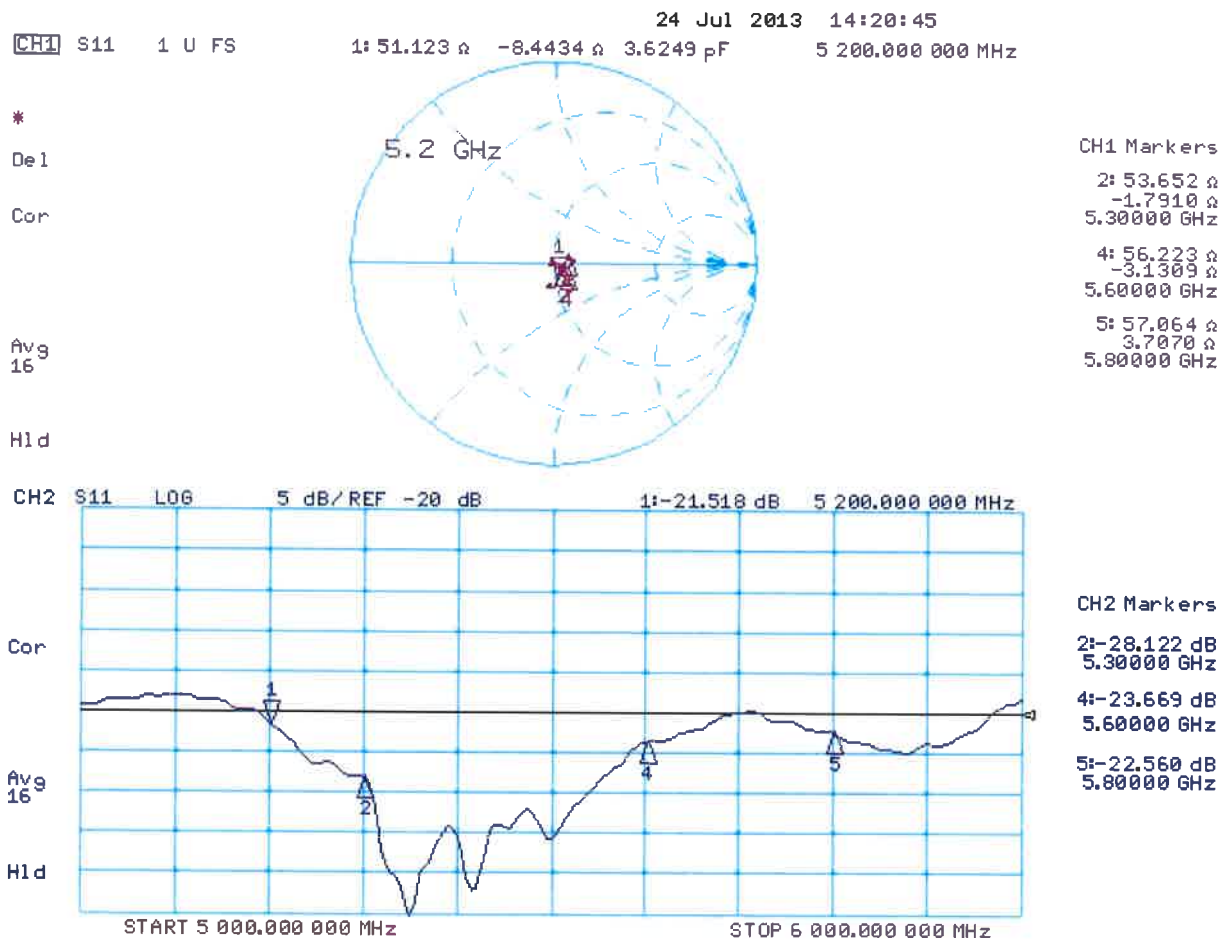



Accredited by the Swiss Accreditation Service (SAS)

Accreditation No.: **SCS 108**

The Swiss Accreditation Service is one of the signatories to the EA
Multilateral Agreement for the recognition of calibration certificates

Client **B.V.ADT (Auden)**

Certificate No: **EX3-3590_Mar14**

CALIBRATION CERTIFICATE

Object **EX3DV4 - SN:3590**

Calibration procedure(s) **QA CAL-01.v9, QA CAL-14.v4, QA CAL-23.v5, QA CAL-25.v6
Calibration procedure for dosimetric E-field probes**



Calibration date: **March 4, 2014**

This calibration certificate documents the traceability to national standards, which realize the physical units of measurements (SI).
The measurements and the uncertainties with confidence probability are given on the following pages and are part of the certificate.

All calibrations have been conducted in the closed laboratory facility: environment temperature (22 ± 3)°C and humidity < 70%.

Calibration Equipment used (M&TE critical for calibration)

Primary Standards	ID	Cal Date (Certificate No.)	Scheduled Calibration
Power meter E4419B	GB41293874	04-Apr-13 (No. 217-01733)	Apr-14
Power sensor E4412A	MY41498087	04-Apr-13 (No. 217-01733)	Apr-14
Reference 3 dB Attenuator	SN: S5054 (3c)	04-Apr-13 (No. 217-01737)	Apr-14
Reference 20 dB Attenuator	SN: S5277 (20x)	04-Apr-13 (No. 217-01735)	Apr-14
Reference 30 dB Attenuator	SN: S5129 (30b)	04-Apr-13 (No. 217-01738)	Apr-14
Reference Probe ES3DV2	SN: 3013	30-Dec-13 (No. ES3-3013_Dec13)	Dec-14
DAE4	SN: 660	13-Dec-13 (No. DAE4-660_Dec13)	Dec-14
Secondary Standards	ID	Check Date (in house)	Scheduled Check
RF generator HP 8648C	US3642U01700	4-Aug-99 (in house check Apr-13)	In house check: Apr-16
Network Analyzer HP 8753E	US37390585	18-Oct-01 (in house check Oct-13)	In house check: Oct-14

Calibrated by:	Name Jeton Kastrati	Function Laboratory Technician	Signature 
Approved by:	Name Katja Pokovic	Function Technical Manager	
			Issued: March 4, 2014
This calibration certificate shall not be reproduced except in full without written approval of the laboratory.			



Accredited by the Swiss Accreditation Service (SAS)

Accreditation No.: **SCS 108**

The Swiss Accreditation Service is one of the signatories to the EA Multilateral Agreement for the recognition of calibration certificates

Glossary:

TSL	tissue simulating liquid
NORM _{x,y,z}	sensitivity in free space
ConvF	sensitivity in TSL / NORM _{x,y,z}
DCP	diode compression point
CF	crest factor (1/duty_cycle) of the RF signal
A, B, C, D	modulation dependent linearization parameters
Polarization φ	φ rotation around probe axis
Polarization ϑ	ϑ rotation around an axis that is in the plane normal to probe axis (at measurement center), i.e., $\vartheta = 0$ is normal to probe axis
Connector Angle	information used in DASY system to align probe sensor X to the robot coordinate system

Calibration is Performed According to the Following Standards:

- IEEE Std 1528-2013, "IEEE Recommended Practice for Determining the Peak Spatial-Averaged Specific Absorption Rate (SAR) in the Human Head from Wireless Communications Devices: Measurement Techniques", June 2013
- IEC 62209-1, "Procedure to measure the Specific Absorption Rate (SAR) for hand-held devices used in close proximity to the ear (frequency range of 300 MHz to 3 GHz)", February 2005

Methods Applied and Interpretation of Parameters:

- NORM_{x,y,z}**: Assessed for E-field polarization $\vartheta = 0$ ($f \leq 900$ MHz in TEM-cell; $f > 1800$ MHz: R22 waveguide). NORM_{x,y,z} are only intermediate values, i.e., the uncertainties of NORM_{x,y,z} does not affect the E²-field uncertainty inside TSL (see below *ConvF*).
- NORM(f)_{x,y,z} = NORM_{x,y,z} * frequency_response** (see Frequency Response Chart). This linearization is implemented in DASY4 software versions later than 4.2. The uncertainty of the frequency response is included in the stated uncertainty of *ConvF*.
- DCP_{x,y,z}**: DCP are numerical linearization parameters assessed based on the data of power sweep with CW signal (no uncertainty required). DCP does not depend on frequency nor media.
- PAR**: PAR is the Peak to Average Ratio that is not calibrated but determined based on the signal characteristics
- A_{x,y,z}; B_{x,y,z}; C_{x,y,z}; D_{x,y,z}; VR_{x,y,z}; A, B, C, D** are numerical linearization parameters assessed based on the data of power sweep for specific modulation signal. The parameters do not depend on frequency nor media. VR is the maximum calibration range expressed in RMS voltage across the diode.
- ConvF and Boundary Effect Parameters**: Assessed in flat phantom using E-field (or Temperature Transfer Standard for $f \leq 800$ MHz) and inside waveguide using analytical field distributions based on power measurements for $f > 800$ MHz. The same setups are used for assessment of the parameters applied for boundary compensation (alpha, depth) of which typical uncertainty values are given. These parameters are used in DASY4 software to improve probe accuracy close to the boundary. The sensitivity in TSL corresponds to NORM_{x,y,z} * ConvF whereby the uncertainty corresponds to that given for ConvF. A frequency dependent ConvF is used in DASY version 4.4 and higher which allows extending the validity from ± 50 MHz to ± 100 MHz.
- Spherical isotropy (3D deviation from isotropy)**: in a field of low gradients realized using a flat phantom exposed by a patch antenna.
- Sensor Offset**: The sensor offset corresponds to the offset of virtual measurement center from the probe tip (on probe axis). No tolerance required.
- Connector Angle**: The angle is assessed using the information gained by determining the NORM_x (no uncertainty required).

Probe EX3DV4

SN:3590

Manufactured: March 23, 2009
Calibrated: March 4, 2014

Calibrated for DASY/EASY Systems
(Note: non-compatible with DASY2 system!)

DASY/EASY - Parameters of Probe: EX3DV4 - SN:3590

Basic Calibration Parameters

	Sensor X	Sensor Y	Sensor Z	Unc (k=2)
Norm ($\mu\text{V}/(\text{V}/\text{m})^2$) ^A	0.50	0.47	0.50	± 10.1 %
DCP (mV) ^B	94.6	96.4	95.9	

Modulation Calibration Parameters

UID	Communication System Name		A dB	B dB $\sqrt{\mu\text{V}}$	C	D dB	VR mV	Unc ^E (k=2)
0	CW	X	0.0	0.0	1.0	0.00	146.4	±3.5 %
		Y	0.0	0.0	1.0		168.7	
		Z	0.0	0.0	1.0		160.8	

The reported uncertainty of measurement is stated as the standard uncertainty of measurement multiplied by the coverage factor $k=2$, which for a normal distribution corresponds to a coverage probability of approximately 95%.

^A The uncertainties of NormX,Y,Z do not affect the E^2 -field uncertainty inside TSL (see Pages 5 and 6).

^B Numerical linearization parameter: uncertainty not required.

^E Uncertainty is determined using the max. deviation from linear response applying rectangular distribution and is expressed for the square of the field value.

DASY/EASY - Parameters of Probe: EX3DV4 - SN:3590

Calibration Parameter Determined in Head Tissue Simulating Media

f (MHz) ^C	Relative Permittivity ^F	Conductivity (S/m) ^F	ConvF X	ConvF Y	ConvF Z	Alpha ^G	Depth ^G (mm)	Unct. (k=2)
750	41.9	0.89	10.89	10.89	10.89	0.25	1.15	± 12.0 %
835	41.5	0.90	10.52	10.52	10.52	0.62	0.67	± 12.0 %
900	41.5	0.97	10.53	10.53	10.53	0.61	0.63	± 12.0 %
1450	40.5	1.20	9.12	9.12	9.12	0.80	0.50	± 12.0 %
1640	40.3	1.29	8.96	8.96	8.96	0.76	0.55	± 12.0 %
1750	40.1	1.37	8.92	8.92	8.92	0.80	0.56	± 12.0 %
1900	40.0	1.40	8.70	8.70	8.70	0.43	0.74	± 12.0 %
2000	40.0	1.40	8.61	8.61	8.61	0.39	0.79	± 12.0 %
2300	39.5	1.67	8.30	8.30	8.30	0.35	0.82	± 12.0 %
2450	39.2	1.80	7.95	7.95	7.95	0.53	0.68	± 12.0 %
2600	39.0	1.96	7.76	7.76	7.76	0.49	0.73	± 12.0 %
3500	37.9	2.91	7.88	7.88	7.88	0.88	0.57	± 13.1 %
5200	36.0	4.66	5.57	5.57	5.57	0.35	1.80	± 13.1 %
5300	35.9	4.76	5.33	5.33	5.33	0.35	1.80	± 13.1 %
5500	35.6	4.96	5.06	5.06	5.06	0.40	1.80	± 13.1 %
5600	35.5	5.07	4.94	4.94	4.94	0.35	1.80	± 13.1 %
5800	35.3	5.27	4.89	4.89	4.89	0.40	1.80	± 13.1 %

^C Frequency validity of ± 100 MHz only applies for DASY v4.4 and higher (see Page 2), else it is restricted to ± 50 MHz. The uncertainty is the RSS of the ConvF uncertainty at calibration frequency and the uncertainty for the indicated frequency band.

^F At frequencies below 3 GHz, the validity of tissue parameters (ϵ and σ) can be relaxed to ± 10% if liquid compensation formula is applied to measured SAR values. At frequencies above 3 GHz, the validity of tissue parameters (ϵ and σ) is restricted to ± 5%. The uncertainty is the RSS of the ConvF uncertainty for indicated target tissue parameters.

^G Alpha/Depth are determined during calibration. SPEAG warrants that the remaining deviation due to the boundary effect after compensation is always less than ± 1% for frequencies below 3 GHz and below ± 2% for frequencies between 3-6 GHz at any distance larger than half the probe tip diameter from the boundary.

DASY/EASY - Parameters of Probe: EX3DV4 - SN:3590

Calibration Parameter Determined in Body Tissue Simulating Media

f (MHz) ^C	Relative Permittivity ^F	Conductivity (S/m) ^F	ConvF X	ConvF Y	ConvF Z	Alpha ^G	Depth ^G (mm)	Unct. (k=2)
750	55.5	0.96	10.39	10.39	10.39	0.43	0.81	± 12.0 %
835	55.2	0.97	10.31	10.31	10.31	0.77	0.60	± 12.0 %
900	55.0	1.05	10.13	10.13	10.13	0.77	0.60	± 12.0 %
1450	54.0	1.30	8.83	8.83	8.83	0.34	0.94	± 12.0 %
1640	53.8	1.40	9.04	9.04	9.04	0.40	0.88	± 12.0 %
1750	53.4	1.49	8.35	8.35	8.35	0.52	0.76	± 12.0 %
1900	53.3	1.52	8.11	8.11	8.11	0.37	0.86	± 12.0 %
2000	53.3	1.52	8.24	8.24	8.24	0.36	0.85	± 12.0 %
2300	52.9	1.81	7.96	7.96	7.96	0.59	0.65	± 12.0 %
2450	52.7	1.95	7.72	7.72	7.72	0.80	0.50	± 12.0 %
2600	52.5	2.16	7.49	7.49	7.49	0.80	0.50	± 12.0 %
3500	51.3	3.31	7.51	7.51	7.51	0.68	0.74	± 13.1 %
5200	49.0	5.30	5.16	5.16	5.16	0.40	1.90	± 13.1 %
5300	48.9	5.42	4.92	4.92	4.92	0.40	1.90	± 13.1 %
5500	48.6	5.65	4.64	4.64	4.64	0.40	1.90	± 13.1 %
5600	48.5	5.77	4.62	4.62	4.62	0.35	1.90	± 13.1 %
5800	48.2	6.00	4.74	4.74	4.74	0.45	1.90	± 13.1 %

^C Frequency validity of ± 100 MHz only applies for DASY v4.4 and higher (see Page 2), else it is restricted to ± 50 MHz. The uncertainty is the RSS of the ConvF uncertainty at calibration frequency and the uncertainty for the indicated frequency band.

^F At frequencies below 3 GHz, the validity of tissue parameters (ϵ and σ) can be relaxed to ± 10% if liquid compensation formula is applied to measured SAR values. At frequencies above 3 GHz, the validity of tissue parameters (ϵ and σ) is restricted to ± 5%. The uncertainty is the RSS of the ConvF uncertainty for indicated target tissue parameters.

^G Alpha/Depth are determined during calibration. SPEAG warrants that the remaining deviation due to the boundary effect after compensation is always less than ± 1% for frequencies below 3 GHz and below ± 2% for frequencies between 3-6 GHz at any distance larger than half the probe tip diameter from the boundary.

Frequency Response of E-Field (TEM-Cell:ifi110 EXX, Waveguide: R22)

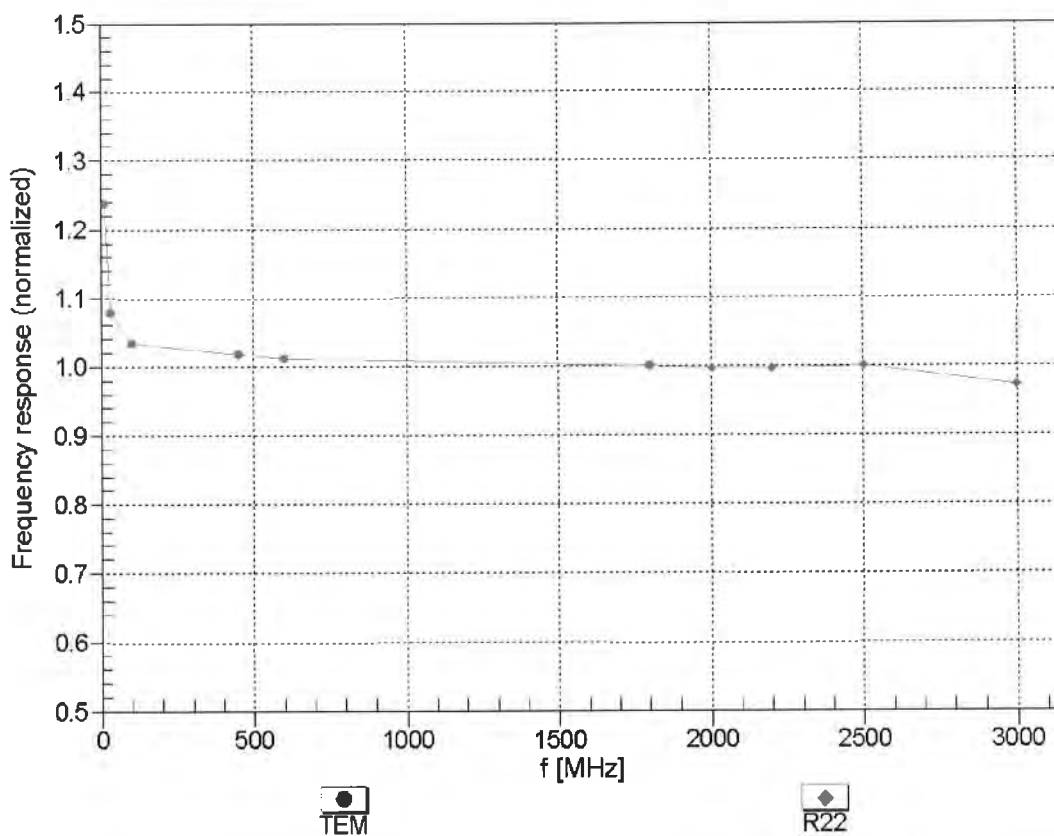

Uncertainty of Frequency Response of E-field: $\pm 6.3\%$ (k=2)

Receiving Pattern (ϕ), $\theta = 0^\circ$

f=600 MHz,TEM

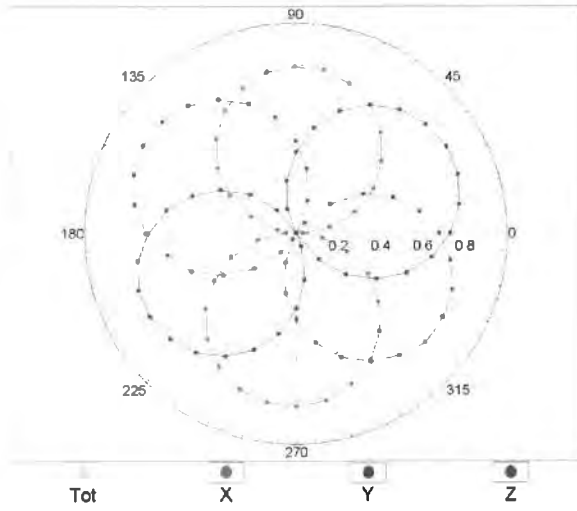

f=1800 MHz,R22

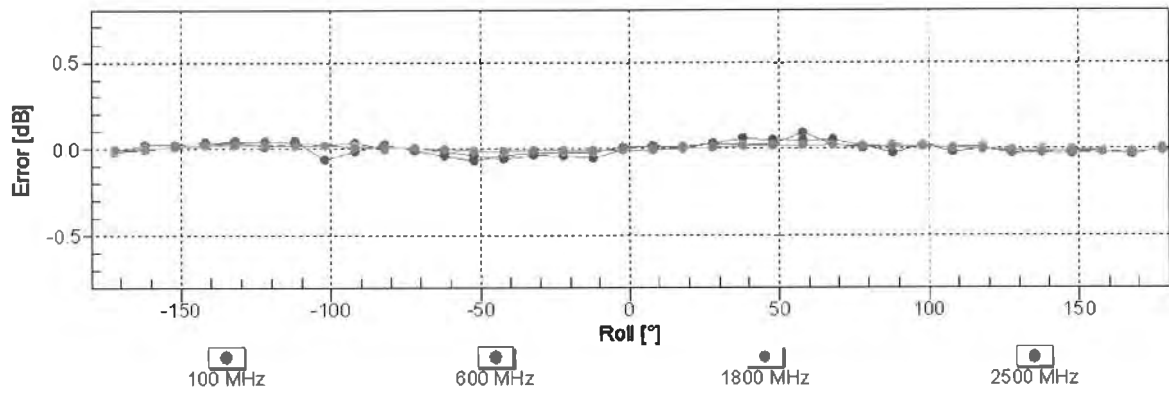
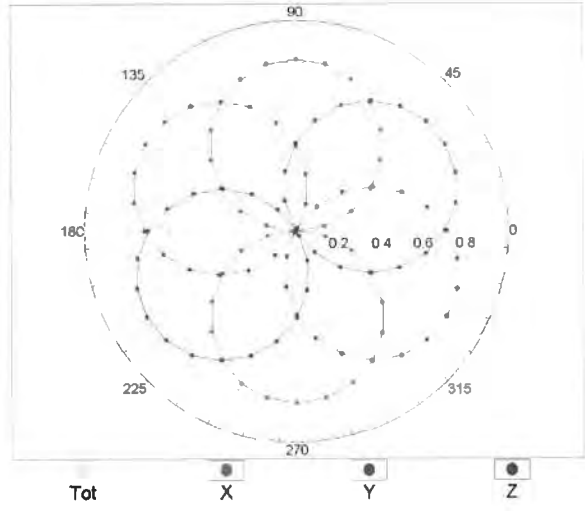

Uncertainty of Axial Isotropy Assessment: $\pm 0.5\%$ (k=2)

Dynamic Range $f(SAR_{head})$ (TEM cell , $f_{eval}= 1900$ MHz)

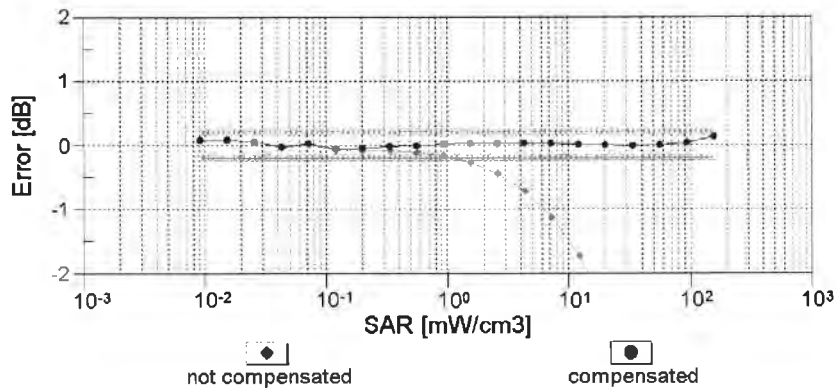
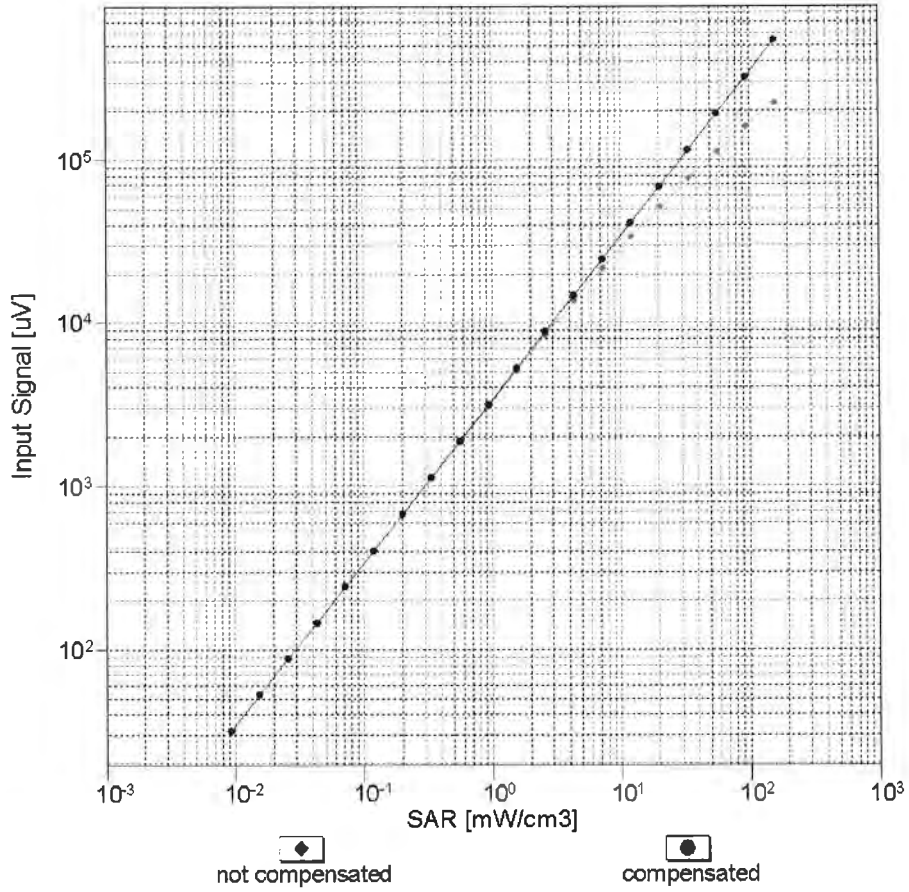

Uncertainty of Linearity Assessment: $\pm 0.6\%$ (k=2)

Conversion Factor Assessment

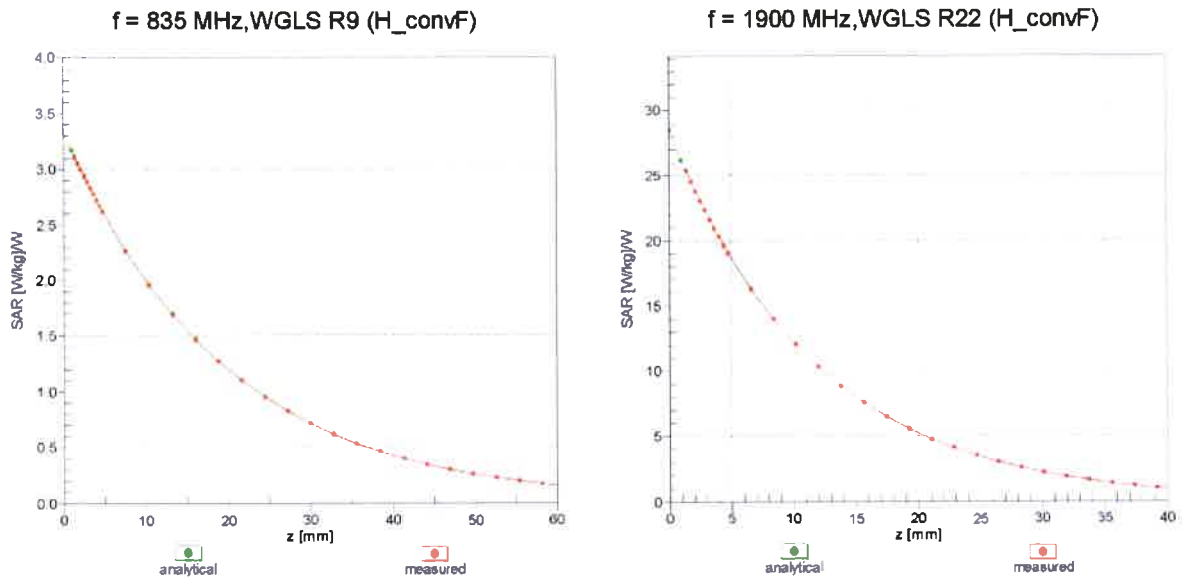

Deviation from Isotropy in Liquid Error (ϕ, θ), f = 900 MHz

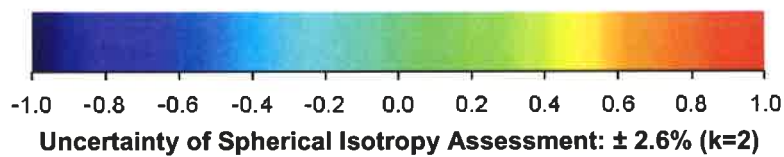
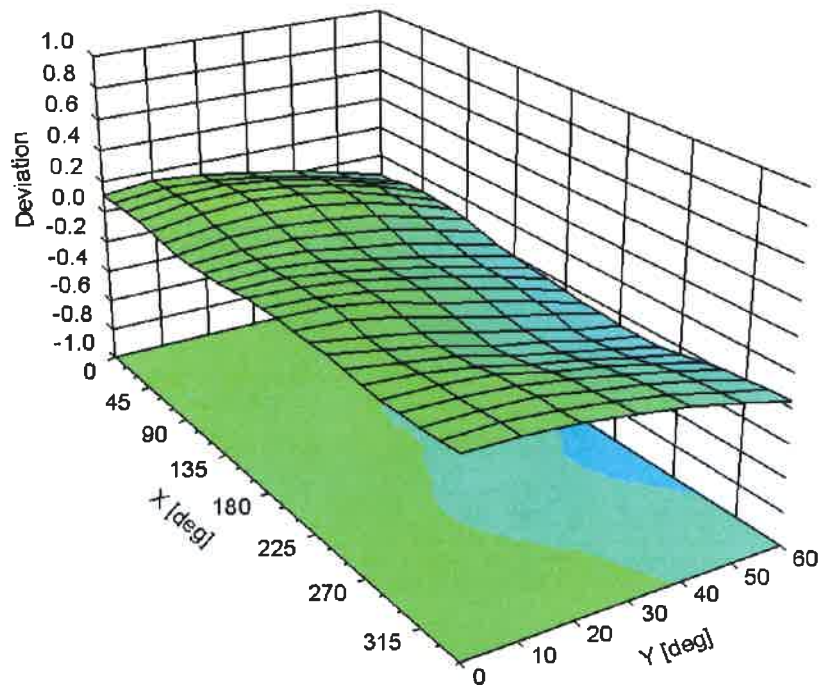

DASY/EASY - Parameters of Probe: EX3DV4 - SN:3590

Other Probe Parameters

Sensor Arrangement	Triangular
Connector Angle (°)	-142.1
Mechanical Surface Detection Mode	enabled
Optical Surface Detection Mode	disabled
Probe Overall Length	337 mm
Probe Body Diameter	10 mm
Tip Length	9 mm
Tip Diameter	2.5 mm
Probe Tip to Sensor X Calibration Point	1 mm
Probe Tip to Sensor Y Calibration Point	1 mm
Probe Tip to Sensor Z Calibration Point	1 mm
Recommended Measurement Distance from Surface	2 mm



Accredited by the Swiss Accreditation Service (SAS)
The Swiss Accreditation Service is one of the signatories to the EA
Multilateral Agreement for the recognition of calibration certificates

Accreditation No.: **SCS 108**

Client **Auden**

Certificate No: **EX3-3820_May14**

CALIBRATION CERTIFICATE

Object **EX3DV4 - SN:3820**

Calibration procedure(s) **QA CAL-01.v9, QA CAL-14.v4, QA CAL-23.v5, QA CAL-25.v6
Calibration procedure for dosimetric E-field probes**

Calibration date: **May 15, 2014**

This calibration certificate documents the traceability to national standards, which realize the physical units of measurements (SI).
The measurements and the uncertainties with confidence probability are given on the following pages and are part of the certificate.

All calibrations have been conducted in the closed laboratory facility: environment temperature (22 ± 3)°C and humidity < 70%.

Calibration Equipment used (M&TE critical for calibration)

Primary Standards	ID	Cal Date (Certificate No.)	Scheduled Calibration
Power meter E4419B	GB41293874	03-Apr-14 (No. 217-01911)	Apr-15
Power sensor E4412A	MY41498087	03-Apr-14 (No. 217-01911)	Apr-15
Reference 3 dB Attenuator	SN: S5054 (3c)	03-Apr-14 (No. 217-01915)	Apr-15
Reference 20 dB Attenuator	SN: S5277 (20x)	03-Apr-14 (No. 217-01919)	Apr-15
Reference 30 dB Attenuator	SN: S5129 (30b)	03-Apr-14 (No. 217-01920)	Apr-15
Reference Probe ES3DV2	SN: 3013	30-Dec-13 (No. ES3-3013_Dec13)	Dec-14
DAE4	SN: 660	13-Dec-13 (No. DAE4-660_Dec13)	Dec-14
Secondary Standards	ID	Check Date (in house)	Scheduled Check
RF generator HP 8648C	US3642U01700	4-Aug-99 (in house check Apr-13)	In house check: Apr-16
Network Analyzer HP 8753E	US37390585	18-Oct-01 (in house check Oct-13)	In house check: Oct-14

Calibrated by:	Name Claudio Leubler	Function Laboratory Technician	Signature
Approved by:	Katja Pokovic	Technical Manager	
			Issued: May 17, 2014
This calibration certificate shall not be reproduced except in full without written approval of the laboratory.			



Accredited by the Swiss Accreditation Service (SAS)

Accreditation No.: **SCS 108**

The Swiss Accreditation Service is one of the signatories to the EA
Multilateral Agreement for the recognition of calibration certificates

Glossary:

TSL	tissue simulating liquid
NORM _{x,y,z}	sensitivity in free space
ConvF	sensitivity in TSL / NORM _{x,y,z}
DCP	diode compression point
CF	crest factor (1/duty_cycle) of the RF signal
A, B, C, D	modulation dependent linearization parameters
Polarization φ	φ rotation around probe axis
Polarization ϑ	ϑ rotation around an axis that is in the plane normal to probe axis (at measurement center), i.e., $\vartheta = 0$ is normal to probe axis
Connector Angle	information used in DASY system to align probe sensor X to the robot coordinate system

Calibration is Performed According to the Following Standards:

- IEEE Std 1528-2013, "IEEE Recommended Practice for Determining the Peak Spatial-Averaged Specific Absorption Rate (SAR) in the Human Head from Wireless Communications Devices: Measurement Techniques", June 2013
- IEC 62209-1, "Procedure to measure the Specific Absorption Rate (SAR) for hand-held devices used in close proximity to the ear (frequency range of 300 MHz to 3 GHz)", February 2005

Methods Applied and Interpretation of Parameters:

- NORM_{x,y,z}**: Assessed for E-field polarization $\vartheta = 0$ ($f \leq 900$ MHz in TEM-cell; $f > 1800$ MHz: R22 waveguide). NORM_{x,y,z} are only intermediate values, i.e., the uncertainties of NORM_{x,y,z} does not affect the E²-field uncertainty inside TSL (see below ConvF).
- NORM(f)_{x,y,z}** = NORM_{x,y,z} * frequency_response (see Frequency Response Chart). This linearization is implemented in DASY4 software versions later than 4.2. The uncertainty of the frequency response is included in the stated uncertainty of ConvF.
- DCP_{x,y,z}**: DCP are numerical linearization parameters assessed based on the data of power sweep with CW signal (no uncertainty required). DCP does not depend on frequency nor media.
- PAR**: PAR is the Peak to Average Ratio that is not calibrated but determined based on the signal characteristics
- A_{x,y,z}; B_{x,y,z}; C_{x,y,z}; D_{x,y,z}; VR_{x,y,z}**: A, B, C, D are numerical linearization parameters assessed based on the data of power sweep for specific modulation signal. The parameters do not depend on frequency nor media. VR is the maximum calibration range expressed in RMS voltage across the diode.
- ConvF and Boundary Effect Parameters**: Assessed in flat phantom using E-field (or Temperature Transfer Standard for $f \leq 800$ MHz) and inside waveguide using analytical field distributions based on power measurements for $f > 800$ MHz. The same setups are used for assessment of the parameters applied for boundary compensation (alpha, depth) of which typical uncertainty values are given. These parameters are used in DASY4 software to improve probe accuracy close to the boundary. The sensitivity in TSL corresponds to NORM_{x,y,z} * ConvF whereby the uncertainty corresponds to that given for ConvF. A frequency dependent ConvF is used in DASY version 4.4 and higher which allows extending the validity from ± 50 MHz to ± 100 MHz.
- Spherical isotropy (3D deviation from isotropy)**: in a field of low gradients realized using a flat phantom exposed by a patch antenna.
- Sensor Offset**: The sensor offset corresponds to the offset of virtual measurement center from the probe tip (on probe axis). No tolerance required.
- Connector Angle**: The angle is assessed using the information gained by determining the NORM_x (no uncertainty required).

Probe EX3DV4

SN:3820

Manufactured:	September 2, 2011
Repaired:	April 28, 2014
Calibrated:	May 15, 2014

Calibrated for DASY/EASY Systems
(Note: non-compatible with DASY2 system!)

DASY/EASY - Parameters of Probe: EX3DV4 - SN:3820

Basic Calibration Parameters

	Sensor X	Sensor Y	Sensor Z	Unc (k=2)
Norm ($\mu\text{V}/(\text{V}/\text{m})^2$) ^A	0.41	0.48	0.51	± 10.1 %
DCP (mV) ^B	101.9	94.0	97.6	

Modulation Calibration Parameters

UID	Communication System Name		A dB	B dB/ $\sqrt{\mu\text{V}}$	C	D dB	VR mV	Unc ^E (k=2)
0	CW	X	0.0	0.0	1.0	0.00	144.8	±3.5 %
		Y	0.0	0.0	1.0		131.9	
		Z	0.0	0.0	1.0		142.9	

The reported uncertainty of measurement is stated as the standard uncertainty of measurement multiplied by the coverage factor k=2, which for a normal distribution corresponds to a coverage probability of approximately 95%.

^A The uncertainties of NormX,Y,Z do not affect the E²-field uncertainty inside TSL (see Pages 5 and 6).

^B Numerical linearization parameter: uncertainty not required.

^E Uncertainty is determined using the max. deviation from linear response applying rectangular distribution and is expressed for the square of the field value.

DASY/EASY - Parameters of Probe: EX3DV4 - SN:3820

Calibration Parameter Determined in Head Tissue Simulating Media

f (MHz) ^C	Relative Permittivity ^F	Conductivity (S/m) ^F	ConvF X	ConvF Y	ConvF Z	Alpha ^G	Depth ^G (mm)	Unct. (k=2)
750	41.9	0.89	9.55	9.55	9.55	0.41	0.88	± 12.0 %
835	41.5	0.90	9.22	9.22	9.22	0.30	1.08	± 12.0 %
900	41.5	0.97	9.23	9.23	9.23	0.47	0.78	± 12.0 %
1450	40.5	1.20	8.49	8.49	8.49	0.27	1.21	± 12.0 %
1750	40.1	1.37	8.26	8.26	8.26	0.80	0.59	± 12.0 %
1900	40.0	1.40	7.73	7.73	7.73	0.58	0.68	± 12.0 %
2100	39.8	1.49	7.71	7.71	7.71	0.75	0.58	± 12.0 %
2450	39.2	1.80	6.85	6.85	6.85	0.41	0.85	± 12.0 %
2600	39.0	1.96	6.73	6.73	6.73	0.40	0.85	± 12.0 %
5200	36.0	4.66	4.94	4.94	4.94	0.35	1.80	± 13.1 %
5300	35.9	4.76	4.66	4.66	4.66	0.35	1.80	± 13.1 %
5500	35.6	4.96	4.70	4.70	4.70	0.35	1.80	± 13.1 %
5600	35.5	5.07	4.47	4.47	4.47	0.35	1.80	± 13.1 %
5800	35.3	5.27	4.29	4.29	4.29	0.40	1.80	± 13.1 %

^C Frequency validity of ± 100 MHz only applies for DASY v4.4 and higher (see Page 2), else it is restricted to ± 50 MHz. Above 5 GHz frequency validity can be extended to ± 110 MHz. The uncertainty is the RSS of the ConvF uncertainty at calibration frequency and the uncertainty for the indicated frequency band.

^F At frequencies below 3 GHz, the validity of tissue parameters (ϵ and σ) can be relaxed to ± 10% if liquid compensation formula is applied to measured SAR values. At frequencies above 3 GHz, the validity of tissue parameters (ϵ and σ) is restricted to ± 5%. The uncertainty is the RSS of the ConvF uncertainty for indicated target tissue parameters.

^G Alpha/Depth are determined during calibration. SPEAG warrants that the remaining deviation due to the boundary effect after compensation is always less than ± 1% for frequencies below 3 GHz and below ± 2% for frequencies between 3-6 GHz at any distance larger than half the probe tip diameter from the boundary.

DASY/EASY - Parameters of Probe: EX3DV4 - SN:3820

Calibration Parameter Determined in Body Tissue Simulating Media

f (MHz) ^C	Relative Permittivity ^F	Conductivity (S/m) ^F	ConvF X	ConvF Y	ConvF Z	Alpha ^G	Depth ^G (mm)	Unct. (k=2)
750	55.5	0.96	9.12	9.12	9.12	0.42	0.92	± 12.0 %
835	55.2	0.97	9.01	9.01	9.01	0.37	0.97	± 12.0 %
900	55.0	1.05	8.83	8.83	8.83	0.59	0.73	± 12.0 %
1450	54.0	1.30	7.88	7.88	7.88	0.58	0.73	± 12.0 %
1750	53.4	1.49	7.48	7.48	7.48	0.80	0.61	± 12.0 %
1900	53.3	1.52	7.23	7.23	7.23	0.63	0.70	± 12.0 %
2100	53.2	1.62	7.54	7.54	7.54	0.53	0.75	± 12.0 %
2450	52.7	1.95	6.87	6.87	6.87	0.80	0.58	± 12.0 %
2600	52.5	2.16	6.63	6.63	6.63	0.80	0.50	± 12.0 %
5200	49.0	5.30	4.44	4.44	4.44	0.40	1.90	± 13.1 %
5300	48.9	5.42	4.25	4.25	4.25	0.40	1.90	± 13.1 %
5500	48.6	5.65	3.99	3.99	3.99	0.45	1.90	± 13.1 %
5600	48.5	5.77	3.83	3.83	3.83	0.45	1.90	± 13.1 %
5800	48.2	6.00	4.00	4.00	4.00	0.50	1.90	± 13.1 %

^C Frequency validity of ± 100 MHz only applies for DASY v4.4 and higher (see Page 2), else it is restricted to ± 50 MHz. Above 5 GHz frequency validity can be extended to ± 110 MHz. The uncertainty is the RSS of the ConvF uncertainty at calibration frequency and the uncertainty for the indicated frequency band.

^F At frequencies below 3 GHz, the validity of tissue parameters (ϵ and σ) can be relaxed to ± 10% if liquid compensation formula is applied to measured SAR values. At frequencies above 3 GHz, the validity of tissue parameters (ϵ and σ) is restricted to ± 5%. The uncertainty is the RSS of the ConvF uncertainty for indicated target tissue parameters.

^G Alpha/Depth are determined during calibration. SPEAG warrants that the remaining deviation due to the boundary effect after compensation is always less than ± 1% for frequencies below 3 GHz and below ± 2% for frequencies between 3-6 GHz at any distance larger than half the probe tip diameter from the boundary.

Frequency Response of E-Field (TEM-Cell:ifi110 EXX, Waveguide: R22)

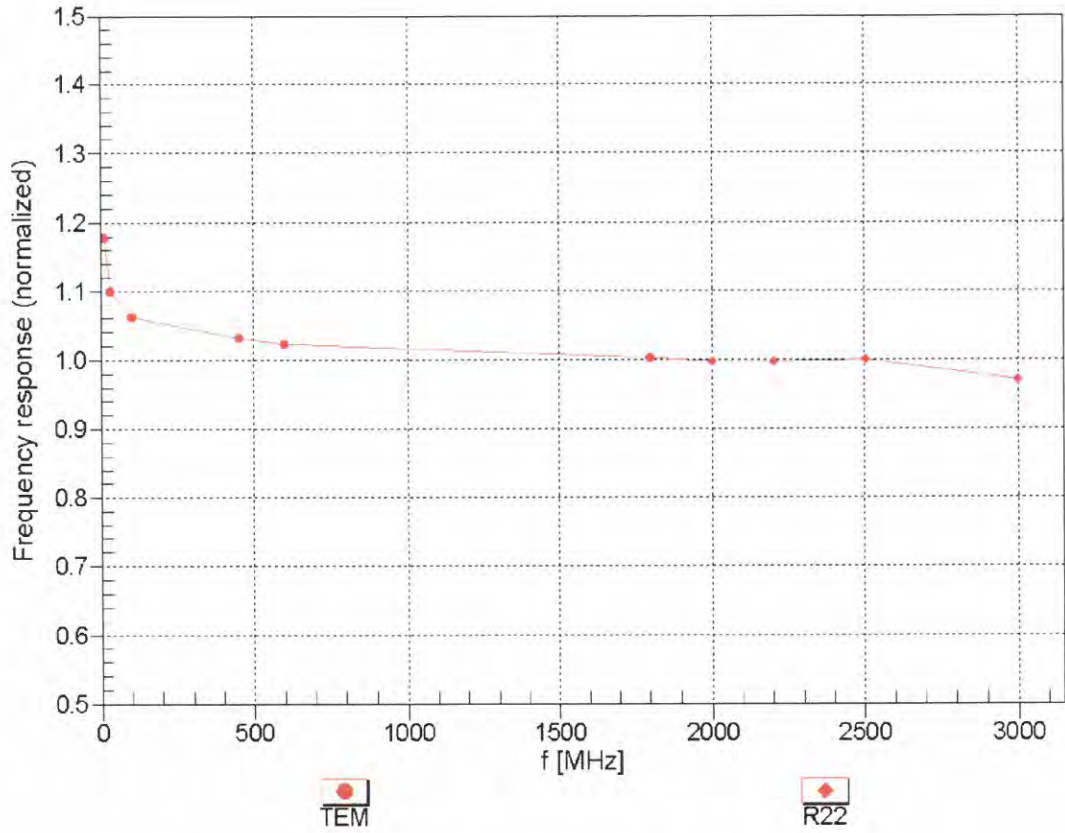

Uncertainty of Frequency Response of E-field: $\pm 6.3\%$ (k=2)

Receiving Pattern (ϕ), $\theta = 0^\circ$

f=600 MHz,TEM

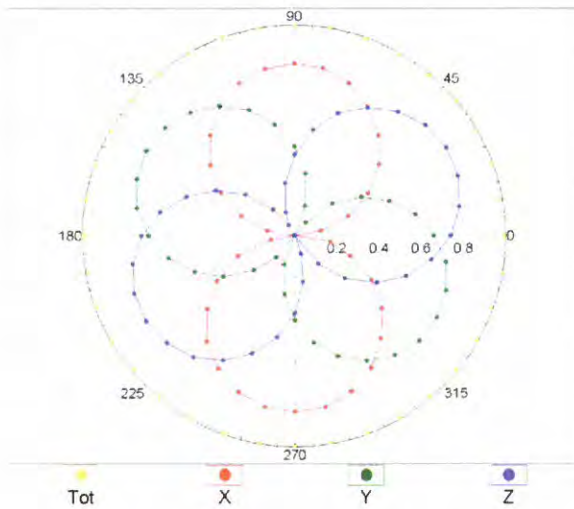

f=1800 MHz,R22

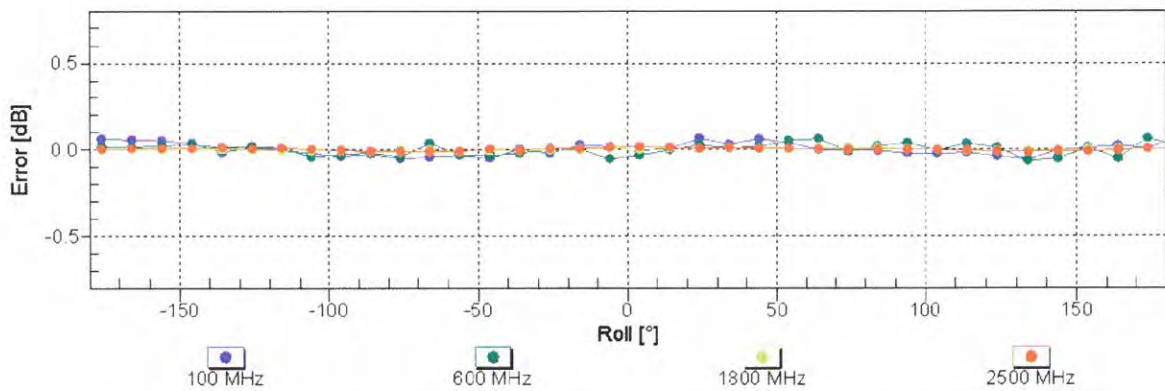
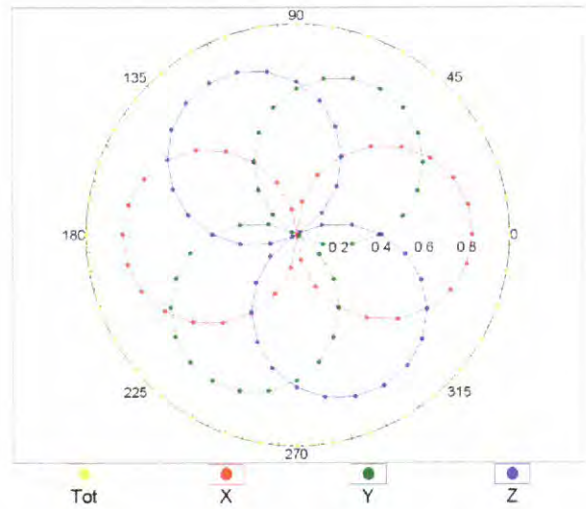

Uncertainty of Axial Isotropy Assessment: $\pm 0.5\%$ (k=2)

Dynamic Range f(SAR_{head}) (TEM cell , f_{eval}= 1900 MHz)

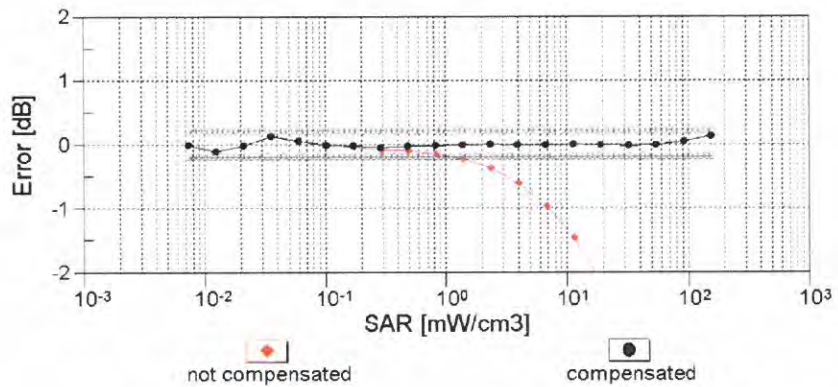
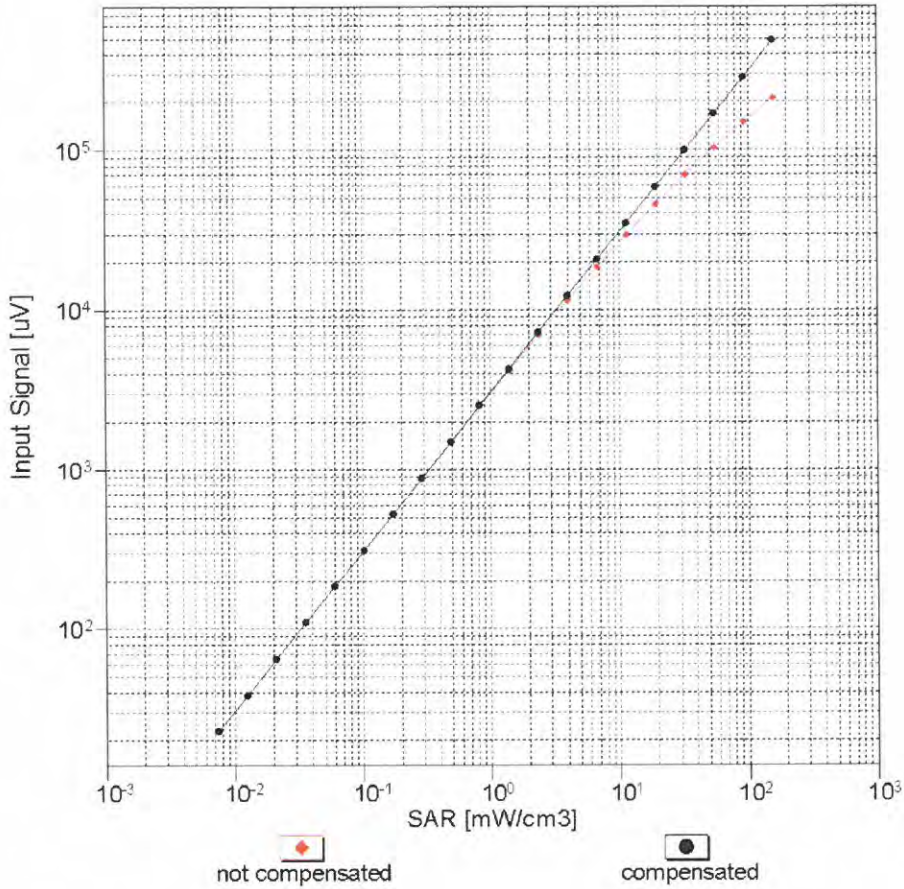

Uncertainty of Linearity Assessment: ± 0.6% (k=2)

Conversion Factor Assessment

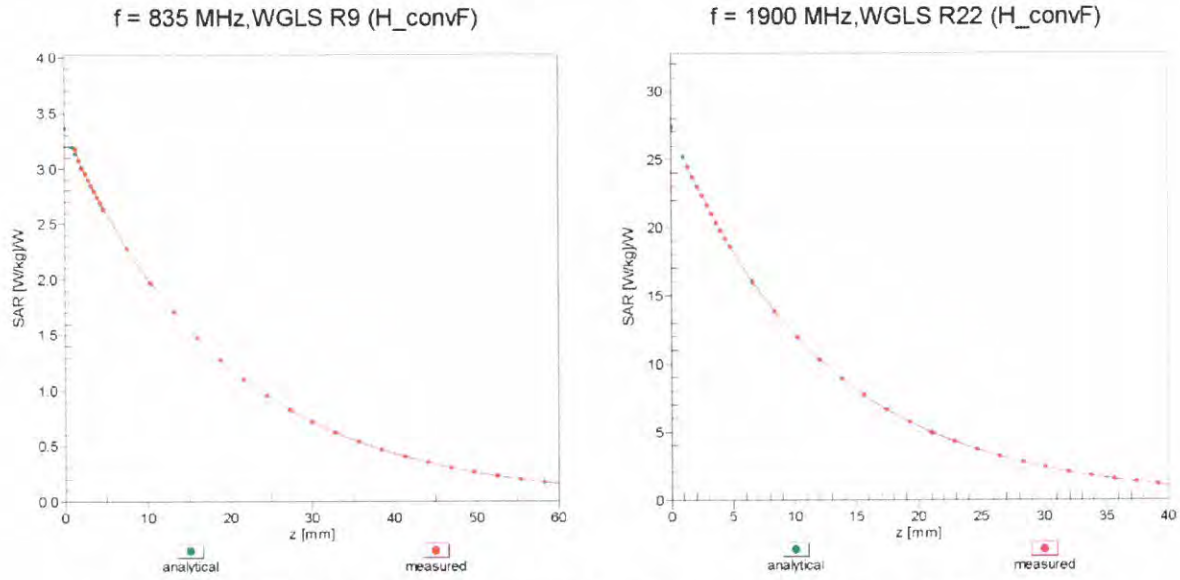

Deviation from Isotropy in Liquid Error (ϕ, θ), f = 900 MHz

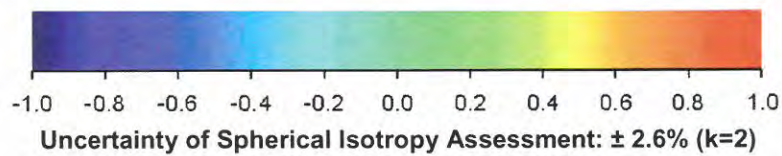
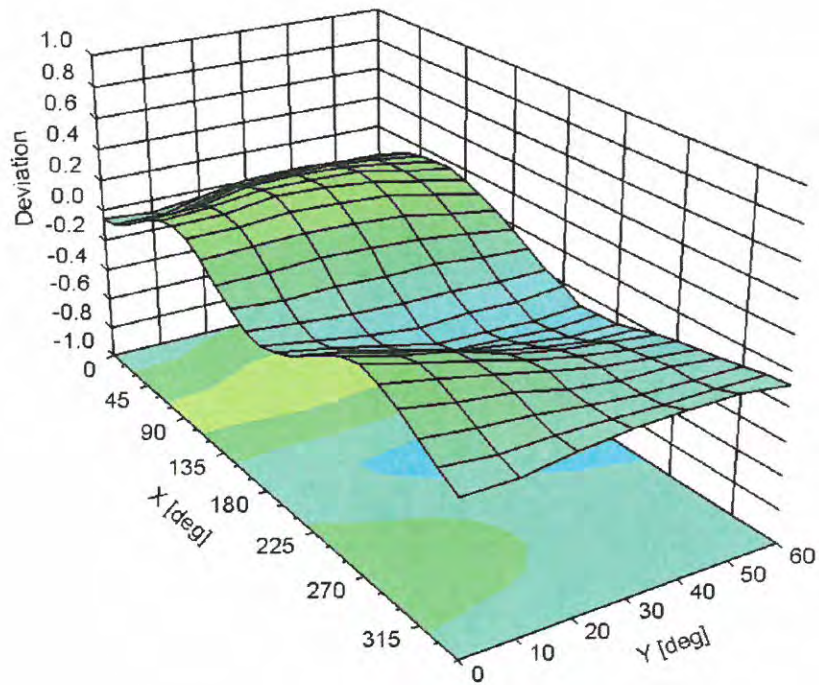

DASY/EASY - Parameters of Probe: EX3DV4 - SN:3820

Other Probe Parameters

Sensor Arrangement	Triangular
Connector Angle (°)	-56
Mechanical Surface Detection Mode	enabled
Optical Surface Detection Mode	disabled
Probe Overall Length	337 mm
Probe Body Diameter	10 mm
Tip Length	9 mm
Tip Diameter	2.5 mm
Probe Tip to Sensor X Calibration Point	1 mm
Probe Tip to Sensor Y Calibration Point	1 mm
Probe Tip to Sensor Z Calibration Point	1 mm
Recommended Measurement Distance from Surface	2 mm



Accredited by the Swiss Accreditation Service (SAS)
The Swiss Accreditation Service is one of the signatories to the EA
Multilateral Agreement for the recognition of calibration certificates

Accreditation No.: **SCS 108**

Client **B.V. ADT (Auden)**

Certificate No: **EX3-3971_Mar14**

CALIBRATION CERTIFICATE

Object **EX3DV4 - SN:3971**

Calibration procedure(s) **QA CAL-01.v9, QA CAL-14.v4, QA CAL-23.v5, QA CAL-25.v6
Calibration procedure for dosimetric E-field probes**

Calibration date: **March 31, 2014**

This calibration certificate documents the traceability to national standards, which realize the physical units of measurements (SI).
The measurements and the uncertainties with confidence probability are given on the following pages and are part of the certificate.

All calibrations have been conducted in the closed laboratory facility: environment temperature (22 ± 3)°C and humidity < 70%.

Calibration Equipment used (M&TE critical for calibration)

Primary Standards	ID	Cal Date (Certificate No.)	Scheduled Calibration
Power meter E4419B	GB41293874	04-Apr-13 (No. 217-01733)	Apr-14
Power sensor E4412A	MY41498087	04-Apr-13 (No. 217-01733)	Apr-14
Reference 3 dB Attenuator	SN: S5054 (3c)	04-Apr-13 (No. 217-01737)	Apr-14
Reference 20 dB Attenuator	SN: S5277 (20x)	04-Apr-13 (No. 217-01735)	Apr-14
Reference 30 dB Attenuator	SN: S5129 (30b)	04-Apr-13 (No. 217-01738)	Apr-14
Reference Probe ES3DV2	SN: 3013	30-Dec-13 (No. ES3-3013_Dec13)	Dec-14
DAE4	SN: 660	13-Dec-13 (No. DAE4-660_Dec13)	Dec-14
Secondary Standards	ID	Check Date (in house)	Scheduled Check
RF generator HP 8648C	US3642U01700	4-Aug-99 (in house check Apr-13)	In house check: Apr-16
Network Analyzer HP 8753E	US37390585	18-Oct-01 (in house check Oct-13)	In house check: Oct-14

	Name	Function	Signature
Calibrated by:	Jeton Kastrati	Laboratory Technician	
Approved by:	Katja Pokovic	Technical Manager	

Issued: April 1, 2014

This calibration certificate shall not be reproduced except in full without written approval of the laboratory.



Accredited by the Swiss Accreditation Service (SAS)

Accreditation No.: **SCS 108**

The Swiss Accreditation Service is one of the signatories to the EA
 Multilateral Agreement for the recognition of calibration certificates

Glossary:

TSL	tissue simulating liquid
NORM _{x,y,z}	sensitivity in free space
ConvF	sensitivity in TSL / NORM _{x,y,z}
DCP	diode compression point
CF	crest factor (1/duty_cycle) of the RF signal
A, B, C, D	modulation dependent linearization parameters
Polarization φ	φ rotation around probe axis
Polarization ϑ	ϑ rotation around an axis that is in the plane normal to probe axis (at measurement center), i.e., $\vartheta = 0$ is normal to probe axis
Connector Angle	information used in DASY system to align probe sensor X to the robot coordinate system

Calibration is Performed According to the Following Standards:

- a) IEEE Std 1528-2013, "IEEE Recommended Practice for Determining the Peak Spatial-Averaged Specific Absorption Rate (SAR) in the Human Head from Wireless Communications Devices: Measurement Techniques", June 2013
- b) IEC 62209-1, "Procedure to measure the Specific Absorption Rate (SAR) for hand-held devices used in close proximity to the ear (frequency range of 300 MHz to 3 GHz)", February 2005

Methods Applied and Interpretation of Parameters:

- **NORM_{x,y,z}**: Assessed for E-field polarization $\vartheta = 0$ ($f \leq 900$ MHz in TEM-cell; $f > 1800$ MHz: R22 waveguide). NORM_{x,y,z} are only intermediate values, i.e., the uncertainties of NORM_{x,y,z} does not affect the E²-field uncertainty inside TSL (see below *ConvF*).
- **NORM(f)_{x,y,z}** = NORM_{x,y,z} * *frequency_response* (see Frequency Response Chart). This linearization is implemented in DASY4 software versions later than 4.2. The uncertainty of the frequency response is included in the stated uncertainty of *ConvF*.
- **DCP_{x,y,z}**: DCP are numerical linearization parameters assessed based on the data of power sweep with CW signal (no uncertainty required). DCP does not depend on frequency nor media.
- **PAR**: PAR is the Peak to Average Ratio that is not calibrated but determined based on the signal characteristics
- **A_{x,y,z}; B_{x,y,z}; C_{x,y,z}; D_{x,y,z}; VR_{x,y,z}; A, B, C, D** are numerical linearization parameters assessed based on the data of power sweep for specific modulation signal. The parameters do not depend on frequency nor media. VR is the maximum calibration range expressed in RMS voltage across the diode.
- **ConvF and Boundary Effect Parameters**: Assessed in flat phantom using E-field (or Temperature Transfer Standard for $f \leq 800$ MHz) and inside waveguide using analytical field distributions based on power measurements for $f > 800$ MHz. The same setups are used for assessment of the parameters applied for boundary compensation (alpha, depth) of which typical uncertainty values are given. These parameters are used in DASY4 software to improve probe accuracy close to the boundary. The sensitivity in TSL corresponds to NORM_{x,y,z} * ConvF whereby the uncertainty corresponds to that given for ConvF. A frequency dependent ConvF is used in DASY version 4.4 and higher which allows extending the validity from ± 50 MHz to ± 100 MHz.
- **Spherical isotropy (3D deviation from isotropy)**: in a field of low gradients realized using a flat phantom exposed by a patch antenna.
- **Sensor Offset**: The sensor offset corresponds to the offset of virtual measurement center from the probe tip (on probe axis). No tolerance required.
- **Connector Angle**: The angle is assessed using the information gained by determining the NORM_x (no uncertainty required).

Probe EX3DV4

SN:3971

Manufactured: December 30, 2013
Calibrated: March 31, 2014

Calibrated for DASY/EASY Systems
(Note: non-compatible with DASY2 system!)

DASY/EASY - Parameters of Probe: EX3DV4 - SN:3971

Basic Calibration Parameters

	Sensor X	Sensor Y	Sensor Z	Unc (k=2)
Norm ($\mu\text{V}/(\text{V}/\text{m})^2$) ^A	0.41	0.53	0.50	$\pm 10.1 \%$
DCP (mV) ^B	99.1	98.1	98.6	

Modulation Calibration Parameters

UID	Communication System Name		A dB	B dB $\sqrt{\mu\text{V}}$	C	D dB	VR mV	Unc ^E (k=2)
0	CW	X	0.0	0.0	1.0	0.00	140.6	$\pm 3.3 \%$
		Y	0.0	0.0	1.0		143.4	
		Z	0.0	0.0	1.0		149.6	

The reported uncertainty of measurement is stated as the standard uncertainty of measurement multiplied by the coverage factor $k=2$, which for a normal distribution corresponds to a coverage probability of approximately 95%.

^A The uncertainties of NormX,Y,Z do not affect the E²-field uncertainty inside TSL (see Pages 5 and 6).

^B Numerical linearization parameter: uncertainty not required.

^E Uncertainty is determined using the max. deviation from linear response applying rectangular distribution and is expressed for the square of the field value.

DASY/EASY - Parameters of Probe: EX3DV4 - SN:3971

Calibration Parameter Determined in Head Tissue Simulating Media

f (MHz) ^C	Relative Permittivity ^F	Conductivity (S/m) ^F	ConvF X	ConvF Y	ConvF Z	Alpha ^G	Depth (mm) ^G	Unct. (k=2)
750	41.9	0.89	10.30	10.30	10.30	0.37	0.95	± 12.0 %
835	41.5	0.90	10.00	10.00	10.00	0.45	0.79	± 12.0 %
900	41.5	0.97	9.66	9.66	9.66	0.23	1.21	± 12.0 %
900	41.5	0.97	9.82	9.82	9.82	0.34	0.93	± 12.0 %
1450	40.5	1.20	8.84	8.84	8.84	0.27	1.12	± 12.0 %
1640	40.3	1.29	8.44	8.44	8.44	0.80	0.50	± 12.0 %
1750	40.1	1.37	8.40	8.40	8.40	0.32	0.91	± 12.0 %
1810	40.0	1.40	8.21	8.21	8.21	0.56	0.71	± 12.0 %
1900	40.0	1.40	8.19	8.19	8.19	0.31	0.91	± 12.0 %
2000	40.0	1.40	8.19	8.19	8.19	0.55	0.66	± 12.0 %
2300	39.5	1.67	7.77	7.77	7.77	0.61	0.64	± 12.0 %
2450	39.2	1.80	7.43	7.43	7.43	0.39	0.83	± 12.0 %
2600	39.0	1.96	7.15	7.15	7.15	0.37	0.87	± 12.0 %
3500	37.9	2.91	6.87	6.87	6.87	0.50	0.93	± 13.1 %
5200	36.0	4.66	5.22	5.22	5.22	0.30	1.80	± 13.1 %
5300	35.9	4.76	4.81	4.81	4.81	0.40	1.80	± 13.1 %
5500	35.6	4.96	4.93	4.93	4.93	0.40	1.80	± 13.1 %
5600	35.5	5.07	4.55	4.55	4.55	0.50	1.80	± 13.1 %
5800	35.3	5.27	4.53	4.53	4.53	0.50	1.80	± 13.1 %

^C Frequency validity of ± 100 MHz only applies for DASY v4.4 and higher (see Page 2), else it is restricted to ± 50 MHz. The uncertainty is the RSS of the ConvF uncertainty at calibration frequency and the uncertainty for the indicated frequency band.

^F At frequencies below 3 GHz, the validity of tissue parameters (ϵ and σ) can be relaxed to ± 10% if liquid compensation formula is applied to measured SAR values. At frequencies above 3 GHz, the validity of tissue parameters (ϵ and σ) is restricted to ± 5%. The uncertainty is the RSS of the ConvF uncertainty for indicated target tissue parameters.

^G Alpha/Depth are determined during calibration. SPEAG warrants that the remaining deviation due to the boundary effect after compensation is always less than ± 1% for frequencies below 3 GHz and below ± 2% for frequencies between 3-6 GHz at any distance larger than half the probe tip diameter from the boundary.

DASY/EASY - Parameters of Probe: EX3DV4 - SN:3971

Calibration Parameter Determined in Body Tissue Simulating Media

f (MHz) ^C	Relative Permittivity ^F	Conductivity (S/m) ^F	ConvF X	ConvF Y	ConvF Z	Alpha ^G	Depth (mm) ^G	Unct. (k=2)
750	55.5	0.96	9.91	9.91	9.91	0.49	0.81	± 12.0 %
835	55.2	0.97	9.74	9.74	9.74	0.56	0.73	± 12.0 %
900	55.0	1.05	9.53	9.53	9.53	0.67	0.67	± 12.0 %
1450	54.0	1.30	8.25	8.25	8.25	0.26	1.20	± 12.0 %
1640	53.8	1.40	8.36	8.36	8.36	0.30	1.01	± 12.0 %
1750	53.4	1.49	7.93	7.93	7.93	0.45	0.80	± 12.0 %
1900	53.3	1.52	7.68	7.68	7.68	0.37	0.90	± 12.0 %
2000	53.3	1.52	7.80	7.80	7.80	0.37	0.89	± 12.0 %
2300	52.9	1.81	7.51	7.51	7.51	0.68	0.65	± 12.0 %
2450	52.7	1.95	7.29	7.29	7.29	0.80	0.50	± 12.0 %
2600	52.5	2.16	6.99	6.99	6.99	0.80	0.50	± 12.0 %
3500	51.3	3.31	6.66	6.66	6.66	0.27	1.34	± 13.1 %
5200	49.0	5.30	4.59	4.59	4.59	0.40	1.90	± 13.1 %
5300	48.9	5.42	4.19	4.19	4.19	0.50	1.90	± 13.1 %
5500	48.6	5.65	4.14	4.14	4.14	0.45	1.90	± 13.1 %
5600	48.5	5.77	3.87	3.87	3.87	0.50	1.90	± 13.1 %
5800	48.2	6.00	4.12	4.12	4.12	0.50	1.90	± 13.1 %

^C Frequency validity of ± 100 MHz only applies for DASY v4.4 and higher (see Page 2), else it is restricted to ± 50 MHz. The uncertainty is the RSS of the ConvF uncertainty at calibration frequency and the uncertainty for the indicated frequency band.

^F At frequencies below 3 GHz, the validity of tissue parameters (ϵ and σ) can be relaxed to ± 10% if liquid compensation formula is applied to measured SAR values. At frequencies above 3 GHz, the validity of tissue parameters (ϵ and σ) is restricted to ± 5%. The uncertainty is the RSS of the ConvF uncertainty for indicated target tissue parameters.

^G Alpha/Depth are determined during calibration. SPEAG warrants that the remaining deviation due to the boundary effect after compensation is always less than ± 1% for frequencies below 3 GHz and below ± 2% for frequencies between 3-6 GHz at any distance larger than half the probe tip diameter from the boundary.

Frequency Response of E-Field (TEM-Cell:ifi110 EXX, Waveguide: R22)

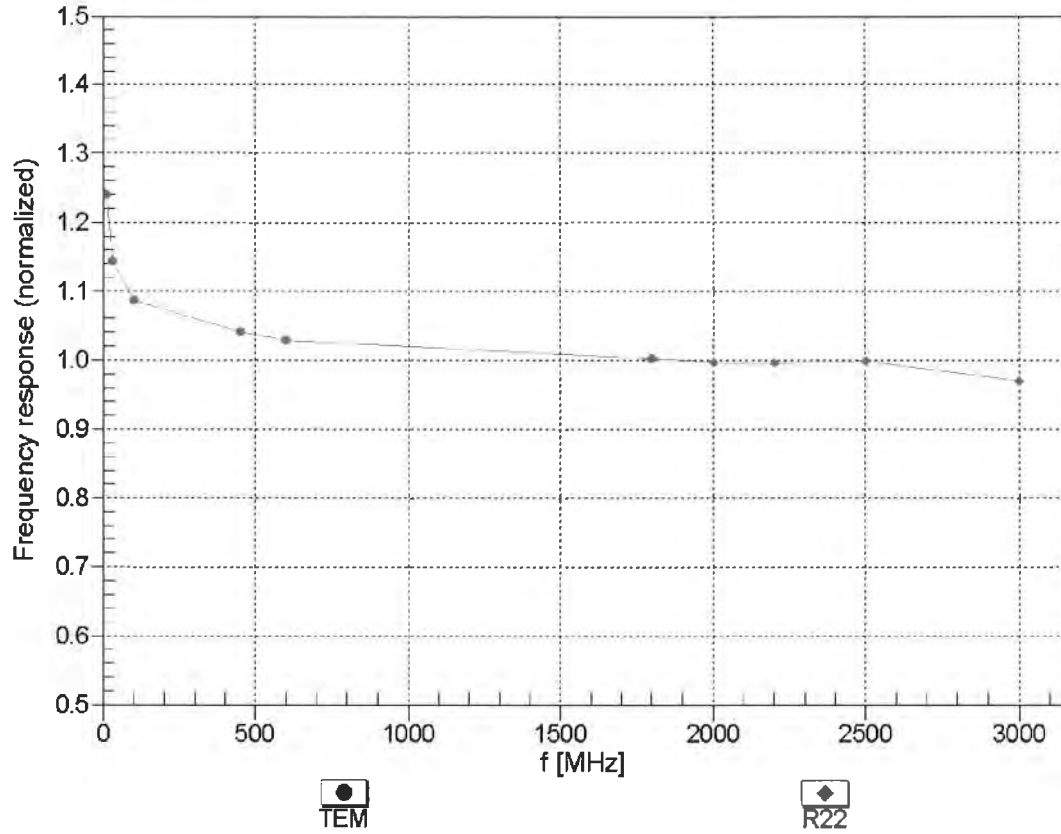

Uncertainty of Frequency Response of E-field: $\pm 6.3\%$ (k=2)

Receiving Pattern (ϕ), $\vartheta = 0^\circ$

f=600 MHz,TEM

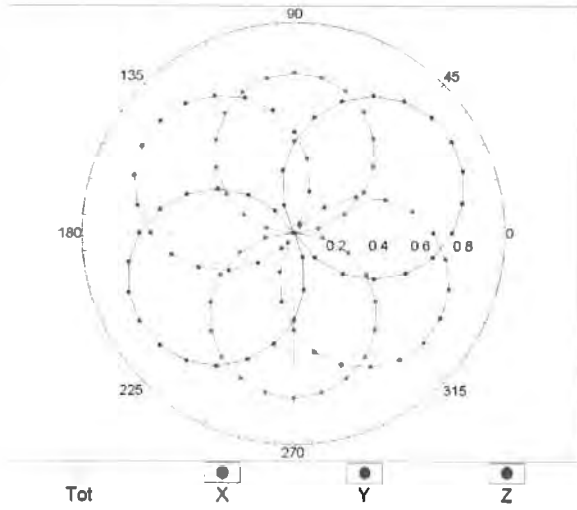

f=1800 MHz,R22

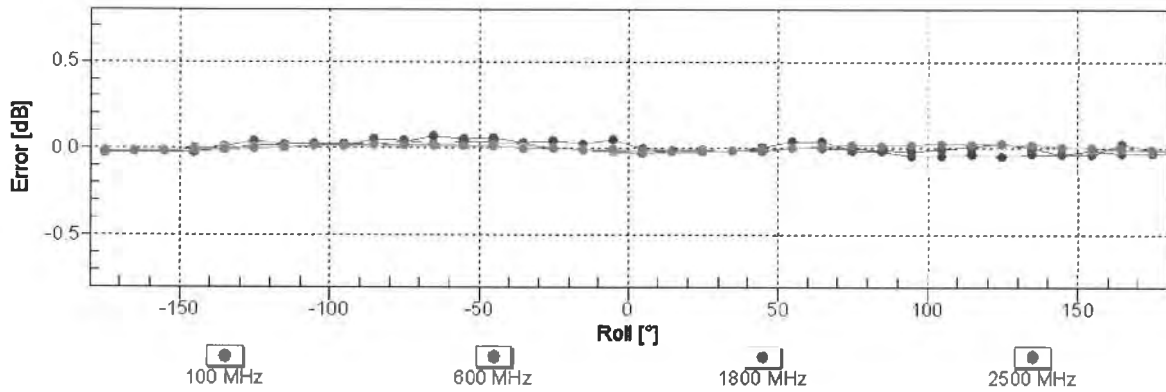
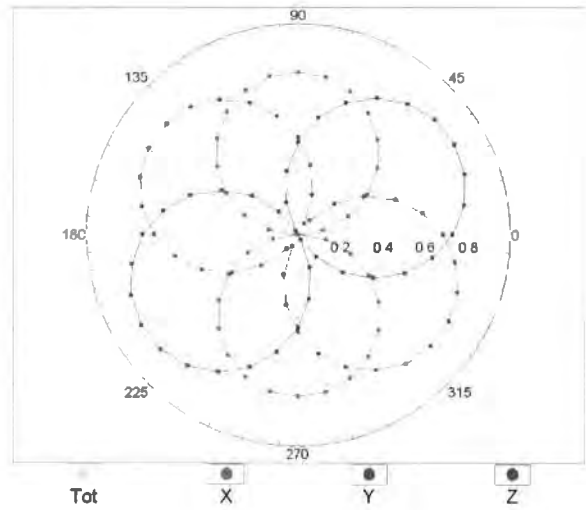

Uncertainty of Axial Isotropy Assessment: $\pm 0.5\%$ (k=2)

Dynamic Range $f(SAR_{head})$ (TEM cell , $f_{eval}= 1900$ MHz)

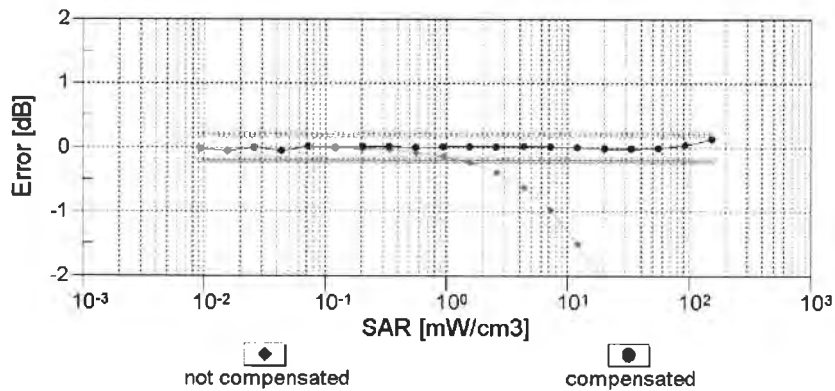
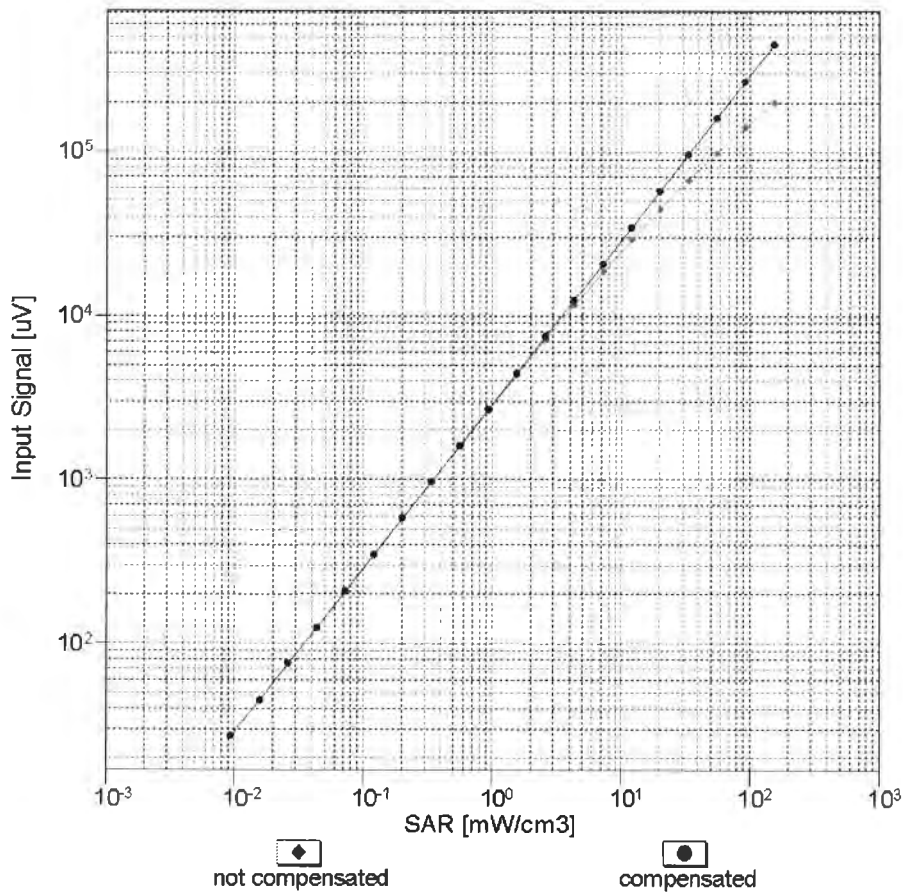

Uncertainty of Linearity Assessment: ± 0.6% (k=2)

Conversion Factor Assessment

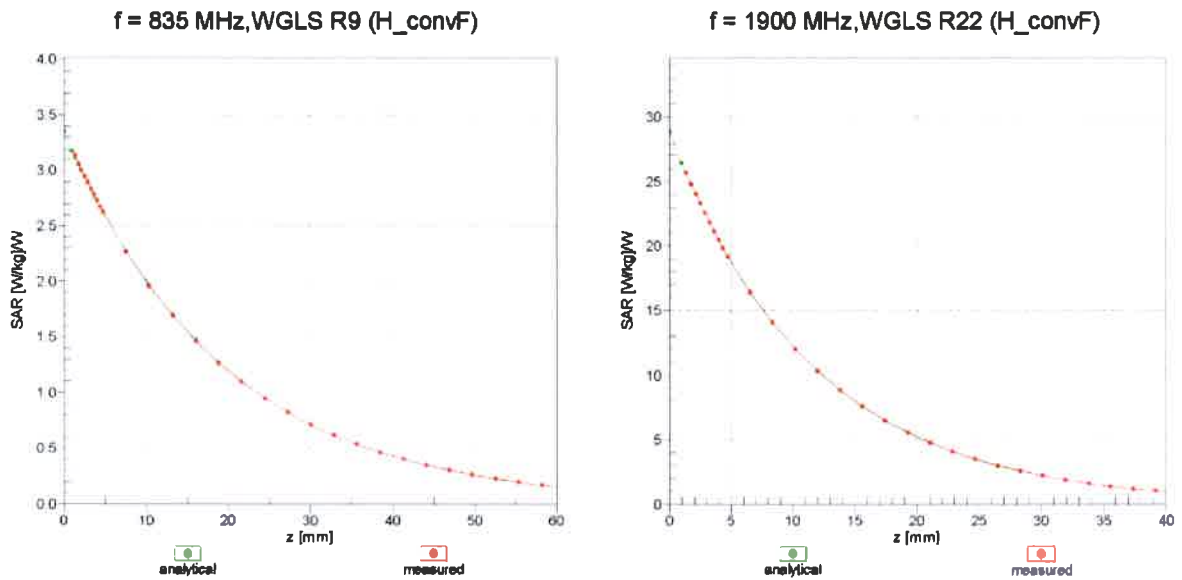

Deviation from Isotropy in Liquid Error (ϕ, θ), f = 900 MHz

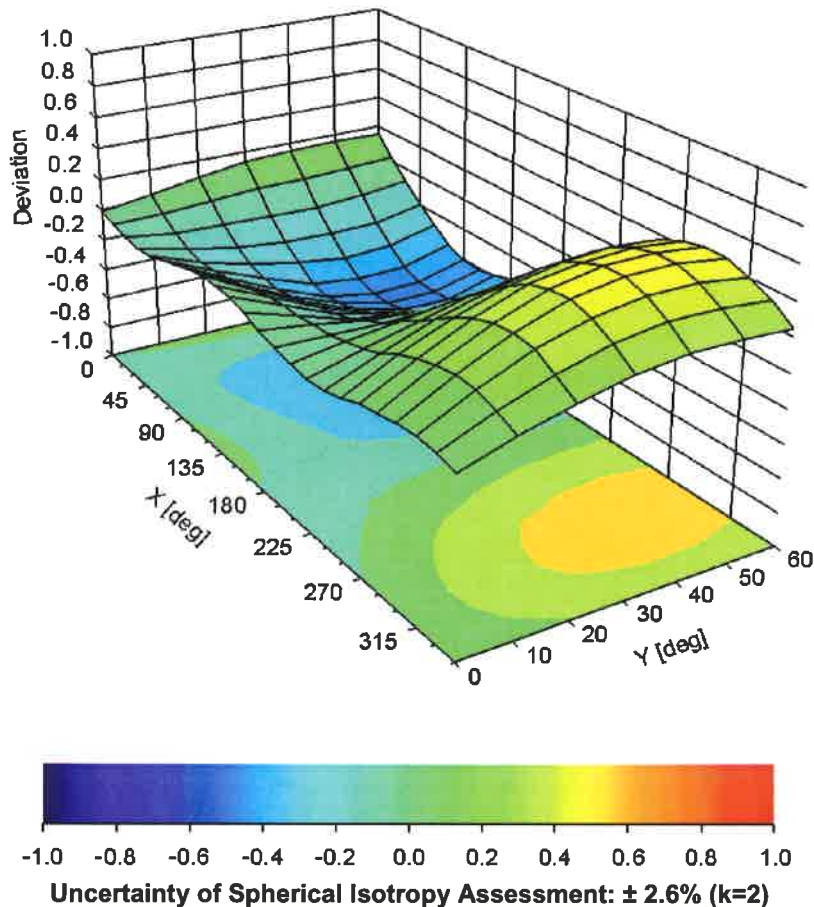

DASY/EASY - Parameters of Probe: EX3DV4 - SN:3971

Other Probe Parameters

Sensor Arrangement	Triangular
Connector Angle (°)	-105.3
Mechanical Surface Detection Mode	enabled
Optical Surface Detection Mode	disabled
Probe Overall Length	337 mm
Probe Body Diameter	10 mm
Tip Length	9 mm
Tip Diameter	2.5 mm
Probe Tip to Sensor X Calibration Point	1 mm
Probe Tip to Sensor Y Calibration Point	1 mm
Probe Tip to Sensor Z Calibration Point	1 mm
Recommended Measurement Distance from Surface	2 mm



Appendix D. Photographs of EUT and Setup