



FCC TEST REPORT (BLUETOOTH/DTS)

REPORT NO.: RF140609E04-2 R1

MODEL NO.: MC18N0

FCC ID: H9PMC18N0

RECEIVED: June 09, 2014

TESTED: June 10 to July 01, 2014

ISSUED: Aug. 07, 2014

APPLICANT: Symbol Technologies, Inc.

ADDRESS: One Motorola Plaza, Holtsville, NY 11742-1300, USA

ISSUED BY: Bureau Veritas Consumer Products Services (H.K.)
Ltd., Taoyuan Branch Hsin Chu Laboratory

LAB ADDRESS: No. 81-1, Lu Liao Keng, 9th Ling, Wu Lung Tsuen,
Chiung Lin Hsiang, Hsin Chu Hsien 307, Taiwan,
R.O.C.

TEST LOCATION (1): No. 81-1, Lu Liao Keng, 9th Ling, Wu Lung Tsuen,
Chiung Lin Hsiang, Hsin Chu Hsien 307, Taiwan,
Taiwan, R.O.C.

TEST LOCATION (2): No.49, Ln. 206, Wende Rd., Shangshan Tsuen,
Chiung Lin Hsiang, Hsin Chu Hsien 307, Taiwan,
Taiwan, R.O.C.

This report should not be used by the client to claim product certification, approval, or endorsement by TAF or any government agencies.



This report is for your exclusive use. Any copying or replication of this report to or for any other person or entity, or use of our name or trademark, is permitted only with our prior written permission. This report sets forth our findings solely with respect to the test samples identified herein. The results set forth in this report are not indicative or representative of the quality or characteristics of the lot from which a test sample was taken or any similar or identical product unless specifically and expressly noted. Our report includes all of the tests requested by you and the results thereof based upon the information that you provided to us. You have 60 days from date of issuance of this report to notify us of any material error or omission caused by our negligence, provided, however, that such notice shall be in writing and shall specifically address the issue you wish to raise. A failure to raise such issue within the prescribed time shall constitute your unqualified acceptance of the completeness of this report, the tests conducted and the correctness of the report contents. Unless specific mention, the uncertainty of measurement has been explicitly taken into account to declare the compliance or non-compliance to the specification



TABLE OF CONTENTS

RELEASE CONTROL RECORD	5
1 CERTIFICATION	6
2 SUMMARY OF TEST RESULTS	7
2.1 MEASUREMENT UNCERTAINTY	9
3 GENERAL INFORMATION	10
3.1 GENERAL DESCRIPTION OF EUT (BLUETOOTH/DTS).....	10
3.2 DESCRIPTION OF TEST MODES	13
3.3 TEST MODE APPLICABILITY AND TESTED CHANNEL DETAIL:	14
3.4 GENERAL DESCRIPTION OF APPLIED STANDARDS	18
3.5 DUTY CYCLE OF TEST SIGNAL	19
3.6 DESCRIPTION OF SUPPORT UNITS	20
3.7 CONFIGURATION OF SYSTEM UNDER TEST	21
4 TEST PROCEDURES AND RESULTS (BT-EDR)	22
4.1 CONDUCTED EMISSION MEASUREMENT	22
4.1.1 LIMITS OF CONDUCTED EMISSION MEASUREMENT	22
4.1.2 TEST INSTRUMENTS	22
4.1.3 TEST PROCEDURES.....	23
4.1.4 DEVIATION FROM TEST STANDARD	23
4.1.5 TEST SETUP	23
4.1.6 EUT OPERATING CONDITIONS.....	24
4.1.7 TEST RESULTS	25
4.2 RADIATED EMISSION AND BANDEDGE MEASUREMENT	27
4.2.1 LIMITS OF RADIATED EMISSION AND BANDEDGE MEASUREMENT	27
4.2.2 TEST INSTRUMENTS	28
4.2.3 TEST PROCEDURES.....	30
4.2.4 DEVIATION FROM TEST STANDARD	30
4.2.5 TEST SETUP	31
4.2.6 EUT OPERATING CONDITIONS.....	31
4.2.7 TEST RESULTS	32
4.3 NUMBER OF HOPPING FREQUENCY USED	44
4.3.1 LIMIT OF HOPPING FREQUENCY USED	44
4.3.2 TEST INSTRUMENTS	44
4.3.3 TEST PROCEDURES.....	44
4.3.4 DEVIATION FROM TEST STANDARD	44
4.3.5 TEST SETUP	45
4.3.6 TEST RESULTS	45
4.4 DWELL TIME ON EACH CHANNEL	46
4.4.1 LIMIT OF DWELL TIME USED	46
4.4.2 TEST INSTRUMENTS	46
4.4.3 TEST PROCEDURES.....	46
4.4.4 DEVIATION FROM TEST STANDARD	47
4.4.5 TEST SETUP	47
4.4.6 TEST RESULTS	48



4.5	CHANNEL BANDWIDTH	52
4.5.1	LIMITS OF CHANNEL BANDWIDTH.....	52
4.5.2	TEST INSTRUMENTS	52
4.5.3	TEST PROCEDURE	52
4.5.4	DEVIATION FROM TEST STANDARD.....	52
4.5.5	TEST SETUP	53
4.5.6	EUT OPERATING CONDITION.....	53
4.5.7	TEST RESULTS.....	54
4.6	HOPPING CHANNEL SEPARATION.....	55
4.6.1	LIMIT OF HOPPING CHANNEL SEPARATION.....	55
4.6.2	TEST INSTRUMENTS	55
4.6.3	TEST PROCEDURES.....	55
4.6.4	DEVIATION FROM TEST STANDARD.....	55
4.6.5	TEST SETUP	55
4.6.6	TEST RESULTS.....	56
4.7	MAXIMUM PEAK OUTPUT POWER.....	57
4.7.1	LIMITS OF MAXIMUM PEAK OUTPUT POWER MEASUREMENT.....	57
4.7.2	INSTRUMENTS	57
4.7.3	TEST PROCEDURES.....	57
4.7.4	DEVIATION FROM TEST STANDARD.....	57
4.7.5	TEST SETUP	58
4.7.6	EUT OPERATING CONDITION.....	58
4.7.7	TEST RESULTS.....	59
4.8	CONDUCTED OUT-BAND EMISSION MEASUREMENT.....	60
4.8.1	LIMITS OF CONDUCTED OUT-BAND EMISSION MEASUREMENT.....	60
4.8.2	TEST INSTRUMENTS	60
4.8.3	TEST PROCEDURE	60
4.8.4	DEVIATION FROM TEST STANDARD.....	60
4.8.5	TEST SETUP	60
4.8.6	EUT OPERATING CONDITION.....	60
4.8.7	TEST RESULTS.....	61
5	TEST TYPES AND RESULTS (BT-LE).....	64
5.1	CONDUCTED EMISSION MEASUREMENT	64
5.1.1	LIMITS OF CONDUCTED EMISSION MEASUREMENT.....	64
5.1.2	TEST INSTRUMENTS	64
5.1.3	TEST PROCEDURES.....	65
5.1.4	DEVIATION FROM TEST STANDARD.....	65
5.1.5	TEST SETUP	65
5.1.6	EUT OPERATING CONDITIONS.....	65
5.1.7	TEST RESULTS.....	66
5.2	RADIATED EMISSION AND BANDEDGE MEASUREMENT.....	68
5.2.1	LIMITS OF RADIATED EMISSION AND BANDEDGE MEASUREMENT.....	68
5.2.2	TEST INSTRUMENTS	69
5.2.3	TEST PROCEDURES.....	71
5.2.4	DEVIATION FROM TEST STANDARD.....	72
5.2.5	TEST SETUP	72
5.2.6	EUT OPERATING CONDITIONS.....	72
5.2.7	TEST RESULTS.....	73



5.3	6DB BANDWIDTH MEASUREMENT	79
5.3.1	LIMITS OF 6DB BANDWIDTH MEASUREMENT	79
5.3.2	TEST INSTRUMENTS	79
5.3.3	TEST PROCEDURE	79
5.3.4	DEVIATION FROM TEST STANDARD	79
5.3.5	TEST SETUP	79
5.3.6	EUT OPERATING CONDITIONS.....	79
5.3.7	TEST RESULTS	80
5.4	CONDUCTED OUTPUT POWER MEASUREMENT	81
5.4.1	LIMITS OF CONDUCTED OUTPUT POWER MEASUREMENT	81
5.4.2	TEST INSTRUMENTS	81
5.4.3	TEST PROCEDURES	81
5.4.4	DEVIATION FROM TEST STANDARD	82
5.4.5	TEST SETUP	82
5.4.6	EUT OPERATING CONDITIONS.....	82
5.4.7	TEST RESULTS	83
5.5	POWER SPECTRAL DENSITY MEASUREMENT	84
5.5.1	LIMITS OF POWER SPECTRAL DENSITY MEASUREMENT	84
5.5.2	TEST INSTRUMENTS	84
5.5.3	TEST PROCEDURE	84
5.5.4	DEVIATION FROM TEST STANDARD	84
5.5.5	TEST SETUP	84
5.5.6	EUT OPERATING CONDITION	84
5.5.7	TEST RESULTS	85
5.6	CONDUCTED OUT-BAND EMISSION MEASUREMENT	86
5.6.1	LIMITS OF CONDUCTED OUT-BAND EMISSION MEASUREMENT	86
5.6.2	TEST INSTRUMENTS	86
5.6.3	TEST PROCEDURE	86
5.6.4	DEVIATION FROM TEST STANDARD	87
5.6.5	TEST SETUP	87
5.6.6	EUT OPERATING CONDITION	87
5.6.7	TEST RESULTS	87
6	PHOTOGRAPHS OF THE TEST CONFIGURATION	89
7	INFORMATION ON THE TESTING LABORATORIES	90
8	APPENDIX A - MODIFICATIONS RECORDERS FOR ENGINEERING CHANGES TO THE EUT BY THE LAB.....	91



A D T

RELEASE CONTROL RECORD

ISSUE NO.	REASON FOR CHANGE	DATE ISSUED
RF140609E04-2	Original release	July 29, 2014
RF140609E04-2 R1	Revised the 8DPSK (channel 39) test data of hopping channel separation test item	Aug. 07, 2014



A D T

1 CERTIFICATION

PRODUCT : MC18 Personal Shopper - Barcode Scanner
BRAND NAME : Symbol
MODEL NO. : MC18N0
TEST SAMPLE : MASS-PRODUCTION
APPLICANT : Symbol Technologies, Inc.
TESTED DATE : May 27 to June 11, 2014
STANDARDS : **FCC Part 15, Subpart C (Section 15.247)**
ANSI C63.10-2009

The above equipment (Model: MC18N0) has been tested by **Bureau Veritas Consumer Products Services (H.K.) Ltd., Taoyuan Branch**, and found compliance with the requirement of the above standards. The test record, data evaluation & Equipment Under Test (EUT) configurations represented herein are true and accurate accounts of the measurements of the sample's EMC characteristics under the conditions specified in this report.

PREPARED BY : Phoenix Huang , **DATE:** Aug. 07, 2014
(Phoenix Huang, Specialist)

APPROVED BY : May Chen , **DATE:** Aug. 07, 2014
(May Chen, Manager)



A D T

2 SUMMARY OF TEST RESULTS

The EUT has been tested according to the following specifications:

For BT-EDR mode:

APPLIED STANDARD: FCC Part 15, Subpart C			
STANDARD SECTION	TEST TYPE AND LIMIT	RESULT	REMARK
15.207	AC Power Conducted Emission	PASS	Meet the requirement of limit. Minimum passing margin is -18.43dB at 0.59531MHz.
15.247(a)(1) (iii)	Number of Hopping Frequency Used	PASS	Meet the requirement of limit.
15.247(a)(1) (iii)	Dwell Time on Each Channel	PASS	Meet the requirement of limit.
15.247(a)(1)	1. Hopping Channel Separation 2. Spectrum Bandwidth of a Frequency Hopping Sequence Spread Spectrum System	PASS	Meet the requirement of limit.
15.247(b)	Maximum Peak Output Power	PASS	Meet the requirement of limit.
15.247(d)	Transmitter Radiated Emissions	PASS	Meet the requirement of limit. Minimum passing margin is -14.8dB at 692.02MHz.
15.247(d)	Band Edge Measurement	PASS	Meet the requirement of limit.
15.203	Antenna Requirement	PASS	No antenna connector is used.



A D T

For BT-LE mode:

APPLIED STANDARD: FCC PART 15, SUBPART C (SECTION 15.247)			
STANDARD SECTION	TEST TYPE AND LIMIT	RESULT	REMARK
15.207	AC Power Conducted Emission	PASS	Meet the requirement of limit. Minimum passing margin is -17.07dB at 0.59531MHz
15.247(d) 15.209	Radiated Emissions & Band Edge Measurement	PASS	Meet the requirement of limit. Minimum passing margin is -14.4dB at 7440.00MHz
15.247(a)(2)	6dB bandwidth	PASS	Meet the requirement of limit.
15.247(b)	Conducted Output power	PASS	Meet the requirement of limit.
15.247(e)	Power Spectral Density	PASS	Meet the requirement of limit.
15.203	Antenna Requirement	PASS	No antenna connector is used.

NOTE: Frequency Hopping System operating in 2400-2483.5MHz band and the output power less than 125mW. The hopping channel carrier frequencies separated by a minimum of 25kHz or two-thirds of the 20dB bandwidth of hopping channel whichever is greater.

2.1 MEASUREMENT UNCERTAINTY

Where relevant, the following measurement uncertainty levels have been estimated for tests performed on the EUT as specified in CISPR 16-4-2:

This uncertainty represents an expanded uncertainty expressed at approximately the 95% confidence level using a coverage factor of $k=2$.

Measurement	Value
Conducted emissions	2.86 dB
Radiated emissions (30MHz-1GHz)	5.37 dB
Radiated emissions (1GHz -6GHz)	3.72 dB
Radiated emissions (6GHz -18GHz)	4.00 dB
Radiated emissions (18GHz -40GHz)	4.11 dB



3 GENERAL INFORMATION

3.1 GENERAL DESCRIPTION OF EUT (BLUETOOTH/DTS)

PRODUCT	MC18 Personal Shopper - Barcode Scanner
MODEL NO.	MC18N0
POWER SUPPLY	DC 3.7V from battery
MODULATION TYPE	GFSK, $\pi/4$ -DQPSK, 8DPSK for FHSS GFSK for DTS
MODULATION TECHNOLOGY	FHSS, DTS
DATE RATE	Up to 3Mbps
FREQUENCY RANGE	2402MHz ~ 2480MHz
NUMBER OF CHANNEL	BT-EDR mode: 79 BT-LE mode: 40
MAX. OUTPUT POWER	BT-EDR mode: 3.451 mW BT-LE mode: 1.084 mW
ANTENNA TYPE	Please see NOTE
DATA CABLE	NA
I/O PORTS	Refer to user's manual
ASSOCIATED DEVICES	NA

NOTE:

1. There are Bluetooth 4.0 technology and WLAN 802.11 a/b/g/n technology.
2. For WLAN: 2.4GHz and 5GHz technology cannot transmit at same time.
3. 2.4GHz/5GHz WLAN + BT will timely shared at same antenna port
4. The antennas provided to the EUT, please refer to the following table:

Antenna Type	Antenna Gain(dBi)	Frequency range(MHz to MHz)	Connector Type	Cable Length
PIFA	2.7	2412~2483.5	NA	NA
	3	5150~5850		



A D T

5. The Version of EUT information are as below:

HW	Terminal	MC18 MB V2.1
SW	System	WinCE
	OS Name	Symbol MC18
	OS version	07.00.2824
	OEM version	99.45.10
Wireless (Fusion)	Part Number	31-FUSION-X2.01
	Fusion version	X_2.01.0.0.074R
	WLAN Firmware	X_2.01.0.0.180
XW2DMT (WLAN RF)	Version	X_2.01.0.0.3
	Symbol version	X_2.01.0.0.171
	WLAN Firmware	X_2.01.0.0.180
BTRegTest (WLAN BT)	Version	4.1

6. The associated devices of EUT information are as below:

Product	P/N
Y Power Cable	P/N : CBL-MC18-Y2MET-01
DC Power Cable	P/N : 25-66420-01R
Interconnect Cable	P/N : 25-66431-01R
Programming Cable	P/N : CBL-MC18-USB1-01
Cold Boot Key	P/N : KT-MC18-RBOOT-05



7. The EUT could be supplied with the a power adapter and/or Li-ion battery as below:

Cradle 1 (1 slot)	
Brand:	Symbol
Model No.:	CRD-MC18-1SL
Part No.:	CRD-MC18-1SL
Input power :	+12V ----- 9A
Associated Devices:	Adapter x 1 (Adapter 1: Part No.: 50-14000-241R)
Cradle 2 (3 slot)	
Brand:	Symbol
Model No.:	CRD-MC18-3SL
Part No.:	CRD-MC18-3SL
Input power :	+12V ----- 9.0A
Associated Devices:	Adapter x 1 (Adapter 1: Part No.: 50-14000-241R)
Power Adapter (for Cradle 1 (1 slot) & Cradle 2 (3 slot), and not for sale together) Brand: Motorola / Symbol Model No.: 50-14000-241R Part No.: PWRS-14000-241R Input power : 100-240V, 50-60Hz, 3.0A Output power : +12V ----- 9.0A Output cable with two type: 1. DC power cable unshielded, 0.5m with two core and Part No. is 25-66420-01R 2. Y power cable : unshielded, 2m with four core and Part No. is CBL-MC18-Y2MET-01	
Li-ion Battery	
Brand:	Symbol
Part No.:	BT000018A01
Rating:	3.7V, 2725mAh, 10.08Wh

From the above cradles, for conducted emission the Cradle 2 (3 slot) was selected as representative cradle for the test and its data was recorded in this report.

8. For a more detailed features description, please refer to the manufacturer's specifications or the User's Manual.



3.2 DESCRIPTION OF TEST MODES

79 channels are provided for BT-EDR mode

Channel	Freq. (MHz)	Channel	Freq. (MHz)	Channel	Freq. (MHz)	Channel	Freq. (MHz)
0	2402	20	2422	40	2442	60	2462
1	2403	21	2423	41	2443	61	2463
2	2404	22	2424	42	2444	62	2464
3	2405	23	2425	43	2445	63	2465
4	2406	24	2426	44	2446	64	2466
5	2407	25	2427	45	2447	65	2467
6	2408	26	2428	46	2448	66	2468
7	2409	27	2429	47	2449	67	2469
8	2410	28	2430	48	2450	68	2470
9	2411	29	2431	49	2451	69	2471
10	2412	30	2432	50	2452	70	2472
11	2413	31	2433	51	2453	71	2473
12	2414	32	2434	52	2454	72	2474
13	2415	33	2435	53	2455	73	2475
14	2416	34	2436	54	2456	74	2476
15	2417	35	2437	55	2457	75	2477
16	2418	36	2438	56	2458	76	2478
17	2419	37	2439	57	2459	77	2479
18	2420	38	2440	58	2460	78	2480
19	2421	39	2441	59	2461		

40 channels are provided for BT-LE mode:

CHANNEL	FREQ. (MHZ)	CHANNEL	FREQ. (MHZ)	CHANNEL	FREQ. (MHZ)	CHANNEL	FREQ. (MHZ)
0	2402	10	2422	20	2442	30	2462
1	2404	11	2424	21	2444	31	2464
2	2406	12	2426	22	2446	32	2466
3	2408	13	2428	23	2448	33	2468
4	2410	14	2430	24	2450	34	2470
5	2412	15	2432	25	2452	35	2472
6	2414	16	2434	26	2454	36	2474
7	2416	17	2436	27	2456	37	2476
8	2418	18	2438	28	2458	38	2478
9	2420	19	2440	29	2460	39	2480



3.3 TEST MODE APPLICABILITY AND TESTED CHANNEL DETAIL:

For BT-EDR mode:

EUT CONFIGURE MODE	APPLICABLE TO					DESCRIPTION
	PLC	RE < 1G	RE ≥ 1G	APCM	OB	
-	√	√	√	√	√	-

Where **PLC**: Power Line Conducted Emission **RE < 1G**: Radiated Emission below 1GHz
RE ≥ 1G: Radiated Emission above 1GHz **APCM**: Antenna Port Conducted Measurement
OB: Conducted Out-Band Emission Measurement

NOTE: 1. The EUT had been pre-tested on the positioned of each 3 axis. The worst case was found when positioned on **Z-plane**.

POWER LINE CONDUCTED EMISSION:

- Pre-Scan has been conducted to determine the worst-case mode from all possible combinations between available modulations, data rates and antenna ports (if EUT with antenna diversity architecture).
- Following channel(s) was (were) selected for the final test as listed below.

Available Channel	Tested Channel	Modulation Technology	Modulation Type	Packet Type
0 to 78	78	FHSS	8DPSK	3DH5

RADIATED EMISSION TEST (BELOW 1 GHz):

- Pre-Scan has been conducted to determine the worst-case mode from all possible combinations between available modulations, data rates and antenna ports (if EUT with antenna diversity architecture).
- Following channel(s) was (were) selected for the final test as listed below.

Available Channel	Tested Channel	Modulation Technology	Modulation Type	Packet Type
0 to 78	0, 39, 78	FHSS	GFSK	DH5
0 to 78	0, 39, 78	FHSS	8DPSK	3DH5

RADIATED EMISSION TEST (ABOVE 1 GHz):

- Pre-Scan has been conducted to determine the worst-case mode from all possible combinations between available modulations, data rates and antenna ports (if EUT with antenna diversity architecture).
- Following channel(s) was (were) selected for the final test as listed below.

Available Channel	Tested Channel	Modulation Technology	Modulation Type	Packet Type
0 to 78	0, 39, 78	FHSS	GFSK	DH5
0 to 78	0, 39, 78	FHSS	8DPSK	3DH5



ANTENNA PORT CONDUCTED MEASUREMENT:

- Pre-Scan has been conducted to determine the worst-case mode from all possible combinations between available modulations, data rates and antenna ports (if EUT with antenna diversity architecture).
- Following channel(s) was (were) selected for the final test as listed below.

Available Channel	Tested Channel	Modulation Technology	Modulation Type	Packet Type
0 to 78	0, 39, 78	FHSS	GFSK	DH5
0 to 78	0, 39, 78	FHSS	8DPSK	3DH5

CONDUCTED OUT-BAND EMISSION MEASUREMENT:

- Pre-Scan has been conducted to determine the worst-case mode from all possible combinations between available modulations, data rates and antenna ports (if EUT with antenna diversity architecture).
- Following channel(s) was (were) selected for the final test as listed below.

Available Channel	Tested Channel	Modulation Technology	Modulation Type	Packet Type
0 to 78	0, 78	FHSS	GFSK	DH5
0 to 78	0, 78	FHSS	8DPSK	3DH5

TEST CONDITION:

APPLICABLE TO	ENVIRONMENTAL CONDITIONS	INPUT POWER	TESTED BY
PLC	25deg. C, 64%RH	120Vac, 60Hz (SYSTEM)	Ping Liu
RE<1G	25deg. C, 65%RH	DC: 3.7V	Nelson Teng
RE≥1G	23deg. C, 69%RH	DC: 3.7V	Tim Ho
APCM	25deg. C, 60%RH	DC: 3.7V	Chilin Lee
OB	25deg. C, 60%RH	DC: 3.7V	Chilin Lee



For BT-LE mode:

EUT CONFIGURE MODE	APPLICABLE TO					DESCRIPTION
	PLC	RE < 1G	RE ≥ 1G	APCM	OB	
-	√	√	√	√	√	-

Where **PLC:** Power Line Conducted Emission **RE < 1G:** Radiated Emission below 1GHz
RE ≥ 1G: Radiated Emission above 1GHz **APCM:** Antenna Port Conducted Measurement
OB: Conducted Out-Band Emission Measurement

NOTE: 1. The EUT had been pre-tested on the positioned of each 3 axis. The worst case was found when positioned on **Z-plane**.

POWER LINE CONDUCTED EMISSION TEST:

- Pre-Scan has been conducted to determine the worst-case mode from all possible combinations between available modulations, data rates and antenna ports (if EUT with antenna diversity architecture).
- Following channel(s) was (were) selected for the final test as listed below.

MODE	AVAILABLE CHANNEL	TESTED CHANNEL	MODULATION TECHNOLOGY	MODULATION TYPE	DATA RATE (Mbps)
BT-LE	0 to 39	39	DTS	GFSK	1

RADIATED EMISSION TEST (BELOW 1 GHz):

- Pre-Scan has been conducted to determine the worst-case mode from all possible combinations between available modulations, data rates and antenna ports (if EUT with antenna diversity architecture).
- Following channel(s) was (were) selected for the final test as listed below.

MODE	AVAILABLE CHANNEL	TESTED CHANNEL	MODULATION TECHNOLOGY	MODULATION TYPE	DATA RATE (Mbps)
BT-LE	0 to 39	0, 19, 39	DTS	GFSK	1

RADIATED EMISSION TEST (ABOVE 1 GHz):

- Pre-Scan has been conducted to determine the worst-case mode from all possible combinations between available modulations, data rates and antenna ports (if EUT with antenna diversity architecture).
- Following channel(s) was (were) selected for the final test as listed below.

MODE	AVAILABLE CHANNEL	TESTED CHANNEL	MODULATION TECHNOLOGY	MODULATION TYPE	DATA RATE (Mbps)
BT-LE	0 to 39	0, 19, 39	DTS	GFSK	1



ANTENNA PORT CONDUCTED MEASUREMENT:

- Pre-Scan has been conducted to determine the worst-case mode from all possible combinations between available modulations, data rates and antenna ports (if EUT with antenna diversity architecture).
- Following channel(s) was (were) selected for the final test as listed below.

MODE	AVAILABLE CHANNEL	TESTED CHANNEL	MODULATION TECHNOLOGY	MODULATION TYPE	DATA RATE (Mbps)
BT-LE	0 to 39	0, 19, 39	DTS	GFSK	1

CONDUCTED OUT-BAND EMISSION MEASUREMENT:

- Pre-Scan has been conducted to determine the worst-case mode from all possible combinations between available modulations, data rates and antenna ports (if EUT with antenna diversity architecture).
- Following channel(s) was (were) selected for the final test as listed below.

MODE	AVAILABLE CHANNEL	TESTED CHANNEL	MODULATION TECHNOLOGY	MODULATION TYPE	DATA RATE (Mbps)
BT-LE	0 to 39	0, 19, 39	DTS	GFSK	1

TEST CONDITION:

APPLICABLE TO	ENVIRONMENTAL CONDITIONS	INPUT POWER	TESTED BY
PLC	25deg. C, 64%RH	120Vac, 60Hz (SYSTEM)	Ping Liu
RE<1G	25deg. C, 65%RH	DC: 3.7V	Nelson Teng
RE≥1G	23deg. C, 69%RH	DC: 3.7V	Tim Ho
APCM	25deg. C, 60%RH	DC: 3.7V	Chilin Lee
OB	25deg. C, 60%RH	DC: 3.7V	Chilin Lee



3.4 GENERAL DESCRIPTION OF APPLIED STANDARDS

The EUT is a RF product. According to the specifications of the manufacturer, it must comply with the requirements of the following standards:

FCC Part 15, Subpart C (15.247)

558074 D01 DTS Meas Guidance v03r02

ANSI C63.10-2009

All test items have been performed and recorded as per the above standards.

Note: The EUT has been verified to comply with the requirements of FCC Part 15, Subpart B, Class B (DoC). The test report has been issued separately.



A D T

3.5 DUTY CYCLE OF TEST SIGNAL

Duty cycle of test signal is < 98 %, duty factor shall be considered.

For BT_LE-GFSK:

Duty cycle = $0.3925 \text{ ms} / 0.62125 \text{ ms} = 0.632$, Duty factor = $10 * \log(1/0.632) = 2$

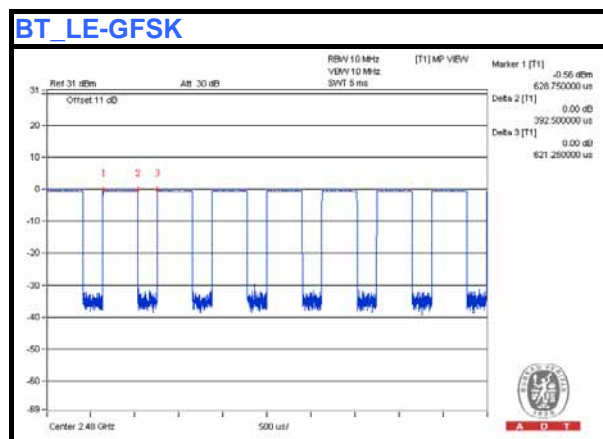



A D T

3.6 DESCRIPTION OF SUPPORT UNITS

The EUT has been tested as an independent unit together with other necessary accessories or support units. The following support units or accessories were used to form a representative test configuration during the tests.

No.	Product	Brand	Model No.	Serial No.	FCC ID	Remark
A	Cradle (3-slot)	Symbol	CRD-MC18-3 SL	NA	NA	Supplied by client
B	ADAPTER	Motorola / Symbol	50-14000-241 R	NA	NA	Supplied by client

NOTE:

1. All power cords of the above support units are non-shielded (1.8 m).

No.	Cable	Qty.	Length (m)	Shielded (Yes/ No)	Cores (Number)	Remark
1	DC	1	0.3	No	0	Supplied by client
2	AC	1	2	No	0	Supplied by client

3.7 CONFIGURATION OF SYSTEM UNDER TEST

For Conducted Emission Test:

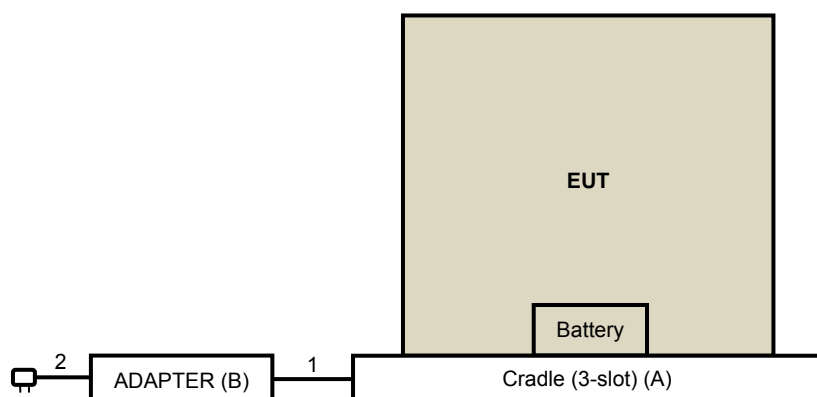

For other test items:

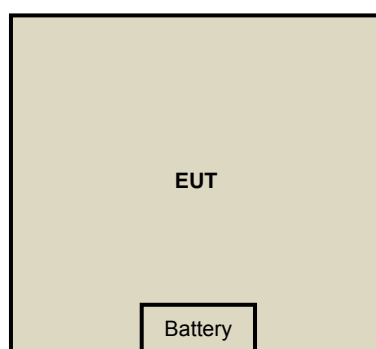



4 TEST PROCEDURES AND RESULTS (BT-EDR)

4.1 CONDUCTED EMISSION MEASUREMENT

4.1.1 LIMITS OF CONDUCTED EMISSION MEASUREMENT

FREQUENCY OF EMISSION (MHz)	CONDUCTED LIMIT (dB μ V)	
	Quasi-peak	Average
0.15-0.5	66 to 56	56 to 46
0.5-5	56	46
5-30	60	50

- NOTE:**
1. The lower limit shall apply at the transition frequencies.
 2. The limit decreases in line with the logarithm of the frequency in the range of 0.15 to 0.50 MHz.

4.1.2 TEST INSTRUMENTS

DESCRIPTION & MANUFACTURER	MODEL NO.	SERIAL NO.	CALIBRATED DATE	CALIBRATED UNTIL
Test Receiver ROHDE & SCHWARZ	ESCS 30	100375	Apr. 29, 2014	Apr. 28, 2015
Line-Impedance Stabilization Network (for EUT) SCHWARZBECK	NSLK8127	8127-522	Sep. 12, 2013	Sep. 11, 2014
Line-Impedance Stabilization Network (for Peripheral)	ENV216	100071	Nov. 13, 2013	Nov. 12, 2014
RF Cable (JYEBAO)	5DFB	COCCAB-001	Mar. 10, 2014	Mar. 09, 2015
50 ohms Terminator	N/A	EMC-03	Sep. 24, 2013	Sep. 23, 2014
50 ohms Terminator	N/A	EMC-02	Oct. 01, 2013	Sep. 30, 2014
Software ADT	BV ADT_Cond_V7.3.7. 3	NA	NA	NA

Note:

1. The calibration interval of the above test instruments is 12 months and the calibrations are traceable to NML/ROC and NIST/USA.
2. The test was performed in Shielded Room No. C.
3. The VCCI Con C Registration No. is C-3611.
4. Tested Date: June 26, 2014

4.1.3 TEST PROCEDURES

- a. The EUT was placed 0.4 meters from the conducting wall of the shielded room with EUT being connected to the power mains through a line impedance stabilization network (LISN). Other support units were connected to the power mains through another LISN.
- b. The two LISNs provide 50 ohm/ 50uH of coupling impedance for the measuring instrument.
- c. Both lines of the power mains connected to the EUT were checked for maximum conducted interference.
- d. The frequency range from 150kHz to 30MHz was searched. Emission levels under (Limit – 20dB) were not recorded.

NOTE: The resolution bandwidth of test receiver is 9kHz for Quasi-peak detection (QP) & Average detection (AV).

4.1.4 DEVIATION FROM TEST STANDARD

No deviation

4.1.5 TEST SETUP

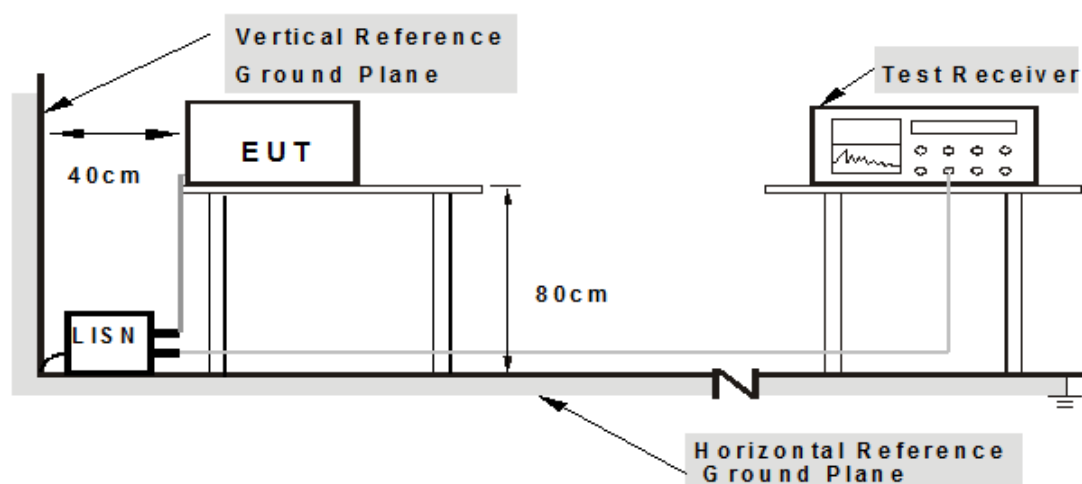

Note: 1. Support units were connected to second LISN.

For the actual test configuration, please refer to the related item – Photographs of the Test Configuration.

4.1.6 EUT OPERATING CONDITIONS

1. The EUT runs test program “BTRegTest[4.1]” to enable EUT under transmission/receiving condition continuously at specific channel frequency.



A D T

4.1.7 TEST RESULTS

PHASE	Line (L)	DETECTOR FUNCTION	Quasi-Peak (QP) / Average (AV)
-------	----------	-------------------	--------------------------------

No	Freq.	Corr.	Reading Value		Emission Level		Limit		Margin	
	[MHz]	Factor (dB)	[dB (uV)]		[dB (uV)]		[dB (uV)]		(dB)	
			Q.P.	AV.	Q.P.	AV.	Q.P.	AV.	Q.P.	AV.
1	0.15000	0.07	29.15	25.90	29.22	25.97	66.00	56.00	-36.78	-30.03
2	0.16953	0.07	23.85	20.26	23.92	20.33	64.98	54.98	-41.07	-34.66
3	0.19297	0.07	17.95	13.47	18.02	13.54	63.91	53.91	-45.89	-40.37
4	0.59531	0.10	27.51	26.92	27.61	27.02	56.00	46.00	-28.39	-18.98
5	21.94922	0.76	27.25	22.13	28.01	22.89	60.00	50.00	-31.99	-27.11
6	25.59375	0.87	18.50	12.76	19.37	13.63	60.00	50.00	-40.63	-36.37

REMARKS:

1. Q.P. and AV. are abbreviations of quasi-peak and average individually.
2. The emission levels of other frequencies were very low against the limit.
3. Margin value = Emission Level – Limit value
4. Correction Factor = Insertion loss + Cable loss
5. Emission Level = Correction Factor + Reading Value

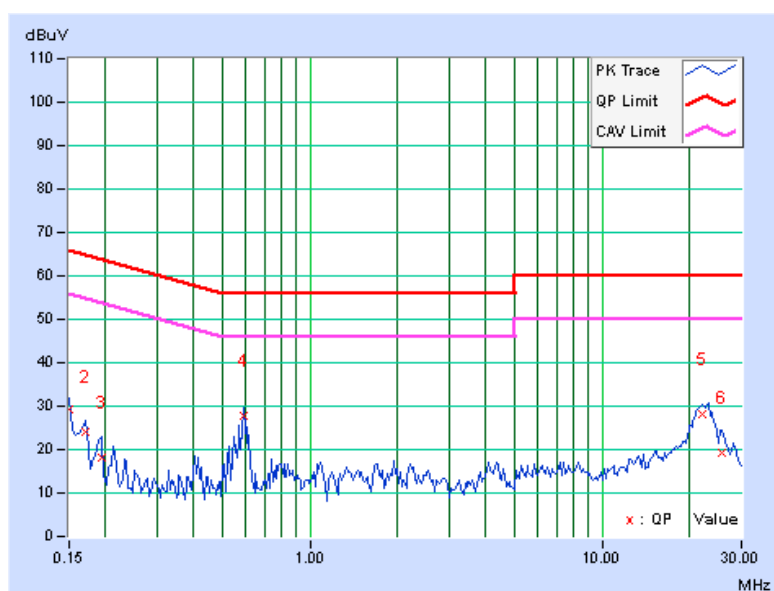



A D T

PHASE	Neutral (N)	DETECTOR FUNCTION	Quasi-Peak (QP) / Average (AV)
--------------	-------------	--------------------------	--------------------------------

No	Freq.	Corr.	Reading Value		Emission Level		Limit		Margin	
	[MHz]	Factor	[dB (uV)]		[dB (uV)]		[dB (uV)]		(dB)	
		(dB)	Q.P.	AV.	Q.P.	AV.	Q.P.	AV.	Q.P.	AV.
1	0.16562	0.07	30.18	30.00	30.25	30.07	65.18	55.18	-34.92	-25.10
2	0.18516	0.07	26.72	25.74	26.79	25.81	64.25	54.25	-37.46	-28.44
3	0.59531	0.10	28.28	27.47	28.38	27.57	56.00	46.00	-27.62	-18.43
4	0.80625	0.12	13.18	8.09	13.30	8.21	56.00	46.00	-42.70	-37.79
5	3.87891	0.26	14.73	11.34	14.99	11.60	56.00	46.00	-41.01	-34.40
6	22.17188	0.76	28.35	24.95	29.11	25.71	60.00	50.00	-30.89	-24.29

REMARKS:

1. Q.P. and AV. are abbreviations of quasi-peak and average individually.
2. The emission levels of other frequencies were very low against the limit.
3. Margin value = Emission Level – Limit value
4. Correction Factor = Insertion loss + Cable loss
5. Emission Level = Correction Factor + Reading Value

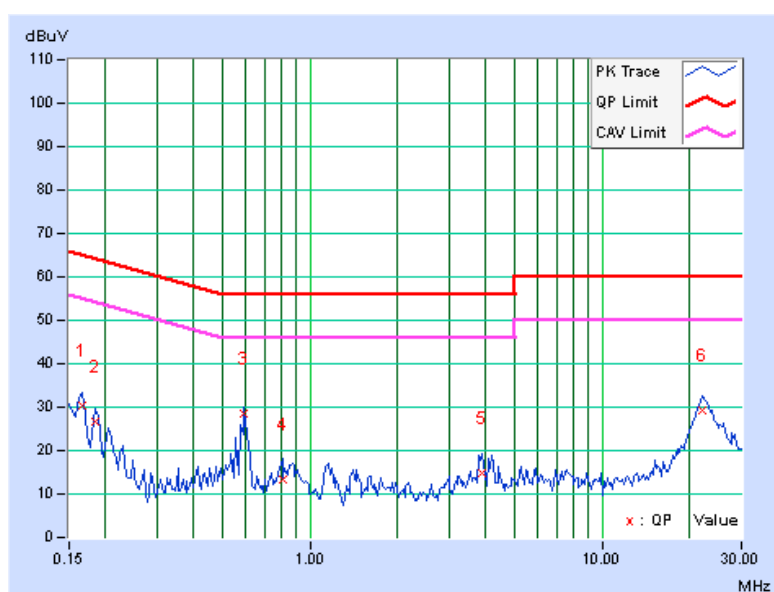

4.2 RADIATED EMISSION AND BANDEDGE MEASUREMENT

4.2.1 LIMITS OF RADIATED EMISSION AND BANDEDGE MEASUREMENT

Radiated emissions which fall in the restricted bands must comply with the radiated emission limits specified as below table. Other emissions shall be at least 20dB below the highest level of the desired power:

FREQUENCIES (MHz)	FIELD STRENGTH (microvolts/meter)	MEASUREMENT DISTANCE (meters)
0.009 ~ 0.490	2400/F(kHz)	300
0.490 ~ 1.705	24000/F(kHz)	30
1.705 ~ 30.0	30	30
30 ~ 88	100	3
88 ~ 216	150	3
216 ~ 960	200	3
Above 960	500	3

NOTE:

1. The lower limit shall apply at the transition frequencies.
2. Emission level (dBuV/m) = 20 log Emission level (uV/m).
3. For frequencies above 1000MHz, the field strength limits are based on average detector, however, the peak field strength of any emission shall not exceed the maximum permitted average limits, specified above by more than 20dB under any condition of modulation.



A D T

4.2.2 TEST INSTRUMENTS

For Below 1GHz:

DESCRIPTION & MANUFACTURER	MODEL NO.	SERIAL NO.	CALIBRATED DATE	CALIBRATED UNTIL
MXE EMI Receiver Agilent	N9038A	MY51210105	Jan. 21,2014	Jan. 20,2015
Pre-Amplifier Mini-Circuits	ZFL-1000VH2 B	AMP-ZFL-03	Nov. 13, 2013	Nov. 12, 2014
Trilog Broadband Antenna SCHWARZBECK	VULB 9168	9168-360	Feb. 26, 2014	Feb. 25, 2015
RF Cable	NA	CHGCAB_001	Oct. 05, 2013	Oct. 04, 2014
Spectrum Analyzer R&S	FSV40	100964	July 15, 2013	July 14, 2014
Horn_Antenna AISI	AIH.8018	0000320091110	Nov. 18, 2013	Nov. 17, 2014
Pre-Amplifier Agilent	8449B	3008A02578	June 24, 2014	June 23, 2015
RF Cable	NA	RF104-201 RF104-203 RF104-204	Dec. 12, 2013	Dec. 11, 2014
Spectrum Analyzer Agilent	E4446A	MY48250253	Aug. 28, 2013	Aug. 27, 2014
Pre-Amplifier SPACEK LABS	SLKKa-48-6	9K16	Nov. 13, 2013	Nov. 12, 2014
Horn_Antenna SCHWARZBECK	BBHA 9170	9170-424	Oct. 08, 2013	Oct. 07, 2014
Software	ADT_Radiated _V8.7.07	NA	NA	NA
Antenna Tower & Turn Table CT	NA	NA	NA	NA

Note:

1. The calibration interval of the above test instruments is 12 months and the calibrations are traceable to NML/ROC and NIST/USA.
2. The horn antenna, preamplifier (model: 8449B) are used only for the measurement of emission frequency above 1GHz if tested.
- 3 The test was performed in 966 Chamber No. G.
4. The FCC Site Registration No. is 966073.
- 5 The VCCI Site Registration No. is G-137.
- 6 The CANADA Site Registration No. is IC 7450H-2.
- 7 Tested Date: July 01, 2014



A D T

For Above 1GHz:

DESCRIPTION & MANUFACTURER	MODEL NO.	SERIAL NO.	CALIBRATED DATE	CALIBRATED UNTIL
MXE EMI Receiver Agilent	N9038A	MY50010156	Jan. 15, 2014	Jan. 14, 2015
Pre-Amplifier Mini-Circuits	ZFL-1000VH2 B	AMP-ZFL-04	Nov. 13, 2013	Nov. 12, 2014
Trilog Broadband Antenna SCHWARZBECK	VULB 9168	9168-361	Feb. 27, 2014	Feb. 26, 2015
RF Cable	NA	CHHCAB_001	Oct. 06, 2013	Oct. 05, 2014
Spectrum Analyzer R&S	FSV40	100964	July 15, 2013	July 14, 2014
Horn_Antenna AISI	AIH.8018	0000220091110	Dec. 06, 2013	Dec. 05, 2014
Pre-Amplifier Agilent	8449B	3008A01923	Oct. 29, 2013	Oct. 28, 2014
RF Cable	NA	RF104-205 RF104-207 RF104-202	Dec. 12, 2013	Dec. 11, 2014
Spectrum Analyzer Agilent	E4446A	MY48250253	Aug. 28, 2013	Aug. 27, 2014
Pre-Amplifier SPACEK LABS	SLKKa-48-6	9K16	Nov. 13, 2013	Nov. 12, 2014
Horn_Antenna SCHWARZBECK	BBHA 9170	9170-424	Oct. 08, 2013	Oct. 07, 2014
Software	ADT_Radiated _V8.7.07	NA	NA	NA
Antenna Tower & Turn Table CT	NA	NA	NA	NA

Note:

1. The calibration interval of the above test instruments is 12 months and the calibrations are traceable to NML/ROC and NIST/USA.
2. The horn antenna, preamplifier (model: 8449B) are used only for the measurement of emission frequency above 1GHz if tested.
3. The test was performed in 966 Chamber No. H.
4. The FCC Site Registration No. is 797305.
5. The CANADA Site Registration No. is IC 7450H-3.
6. Tested Date: June 10, 2014

4.2.3 TEST PROCEDURES

- a. The EUT was placed on the top of a rotating table 0.8 meters above the ground at a 3 meters chamber room. The table was rotated 360 degrees to determine the position of the highest radiation.
- b. The EUT was set 3 meters away from the interference-receiving antenna, which was mounted on the top of a variable-height antenna tower.
- c. The height of antenna is varied from one meter to four meters above the ground to determine the maximum value of the field strength. Both horizontal and vertical polarizations of the antenna are set to make the measurement.
- d. For each suspected emission, the EUT was arranged to its worst case and then the antenna was tuned to heights from 1 meter to 4 meters and the rotatable table was turned from 0 degrees to 360 degrees to find the maximum reading.
- e. The test-receiver system was set to quasi-peak detect function and specified bandwidth with maximum hold mode when the test frequency is below 1 GHz.
- f. The test-receiver system was set to peak detect function and specified bandwidth with maximum hold mode when the test frequency is above 1 GHz.

NOTE:

1. The resolution bandwidth and video bandwidth of test receiver/spectrum analyzer is 120kHz for Quasi-peak detection (QP) at frequency below 1GHz.
2. The resolution bandwidth of test receiver/spectrum analyzer is 1MHz and video bandwidth is 1MHz for Peak detection at frequency above 1GHz.
3. All modes of operation were investigated and the worst-case emissions are reported.

4.2.4 DEVIATION FROM TEST STANDARD

No deviation

4.2.5 TEST SETUP

<Frequency Range below 1GHz>

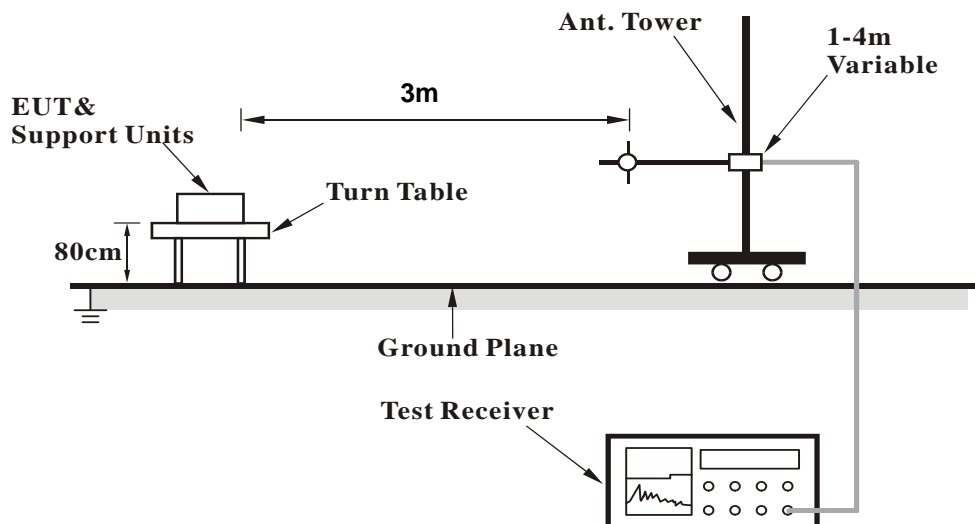

<Frequency Range above 1GHz>

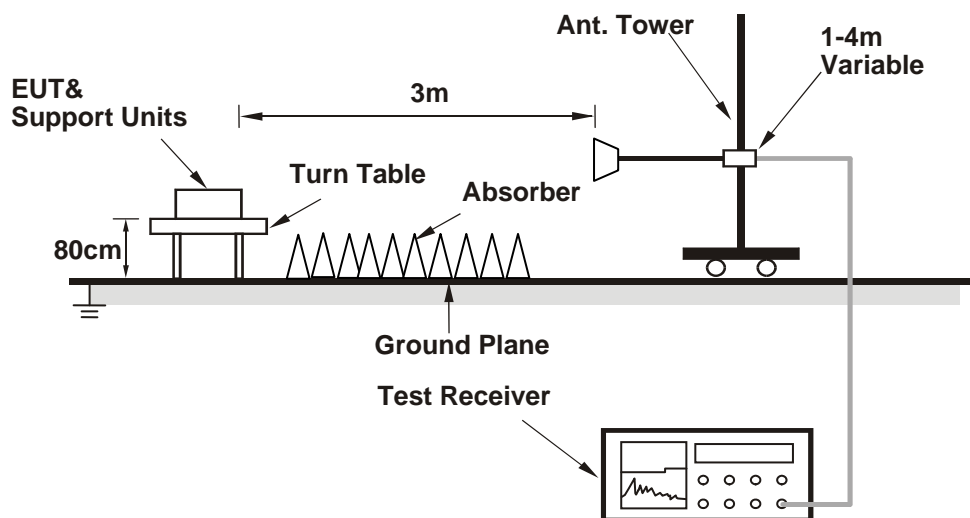

For the actual test configuration, please refer to the related item – Photographs of the Test Configuration.

4.2.6 EUT OPERATING CONDITIONS

Same as 4.1.6

4.2.7 TEST RESULTS

BELOW 1GHz WORST-CASE DATA

BT_GFSK

CHANNEL	TX Channel 0	DETECTOR FUNCTION	Quasi-Peak (QP)
FREQUENCY RANGE	30MHz ~ 1GHz		

ANTENNA POLARITY & TEST DISTANCE: HORIZONTAL AT 3 M								
NO.	FREQ. (MHz)	EMISSION LEVEL (dBuV/m)	LIMIT (dBuV/m)	MARGIN (dB)	ANTENNA HEIGHT (m)	TABLE ANGLE (Degree)	RAW VALUE (dBuV)	CORRECTION FACTOR (dB/m)
1	435.73	29.4 QP	46.0	-16.6	1.74 H	209	37.88	-8.51
2	486.34	27.9 QP	46.0	-18.2	1.55 H	165	35.48	-7.63
3	588.41	29.9 QP	46.0	-16.1	1.45 H	333	35.20	-5.32
4	612.78	29.1 QP	46.0	-16.9	1.52 H	87	33.60	-4.46
5	691.20	30.1 QP	46.0	-15.9	1.25 H	210	33.76	-3.64
6	716.52	27.9 QP	46.0	-18.2	1.18 H	145	31.16	-3.31
ANTENNA POLARITY & TEST DISTANCE: VERTICAL AT 3 M								
NO.	FREQ. (MHz)	EMISSION LEVEL (dBuV/m)	LIMIT (dBuV/m)	MARGIN (dB)	ANTENNA HEIGHT (m)	TABLE ANGLE (Degree)	RAW VALUE (dBuV)	CORRECTION FACTOR (dB/m)
1	434.09	26.5 QP	46.0	-19.5	1.50 V	158	35.01	-8.55
2	485.92	28.4 QP	46.0	-17.6	1.35 V	215	36.03	-7.64
3	588.39	28.4 QP	46.0	-17.6	1.05 V	190	33.71	-5.32
4	615.01	28.8 QP	46.0	-17.2	1.75 V	169	33.26	-4.44
5	691.11	28.1 QP	46.0	-17.9	1.46 V	246	31.75	-3.64
6	940.75	29.4 QP	46.0	-16.6	1.45 V	117	28.51	0.86

REMARKS:

1. Emission Level(dBuV/m) = Raw Value(dBuV) + Correction Factor(dB/m)
2. Correction Factor(dB/m) = Antenna Factor(dB/m) + Cable Factor(dB) – Pre-Amplifier Factor(dB)
3. The other emission levels were very low against the limit.
4. Margin value = Emission Level – Limit value



A D T

CHANNEL	TX Channel 39	DETECTOR FUNCTION	Quasi-Peak (QP)
FREQUENCY RANGE	30MHz ~ 1GHz		

ANTENNA POLARITY & TEST DISTANCE: HORIZONTAL AT 3 M

NO.	FREQ. (MHz)	EMISSION LEVEL (dBuV/m)	LIMIT (dBuV/m)	MARGIN (dB)	ANTENNA HEIGHT (m)	TABLE ANGLE (Degree)	RAW VALUE (dBuV)	CORRECTION FACTOR (dB/m)
1	435.64	29.0 QP	46.0	-17.0	1.71 H	215	37.47	-8.51
2	486.37	27.7 QP	46.0	-18.3	1.43 H	159	35.34	-7.63
3	588.11	30.4 QP	46.0	-15.6	1.49 H	334	35.72	-5.33
4	612.73	28.9 QP	46.0	-17.1	1.54 H	66	33.33	-4.46
5	691.47	30.1 QP	46.0	-15.9	1.14 H	203	33.75	-3.64
6	716.66	28.1 QP	46.0	-17.9	1.21 H	125	31.37	-3.31

ANTENNA POLARITY & TEST DISTANCE: VERTICAL AT 3 M

NO.	FREQ. (MHz)	EMISSION LEVEL (dBuV/m)	LIMIT (dBuV/m)	MARGIN (dB)	ANTENNA HEIGHT (m)	TABLE ANGLE (Degree)	RAW VALUE (dBuV)	CORRECTION FACTOR (dB/m)
1	434.80	27.4 QP	46.0	-18.6	1.50 V	170	35.95	-8.53
2	485.61	28.4 QP	46.0	-17.6	1.37 V	201	36.08	-7.64
3	587.94	27.7 QP	46.0	-18.3	1.00 V	197	33.02	-5.33
4	614.17	27.8 QP	46.0	-18.2	1.68 V	171	32.25	-4.46
5	690.45	26.5 QP	46.0	-19.5	1.48 V	234	30.10	-3.63
6	940.57	28.1 QP	46.0	-17.9	1.42 V	109	27.28	0.85

REMARKS:

1. Emission Level(dBuV/m) = Raw Value(dBuV) + Correction Factor(dB/m)
2. Correction Factor(dB/m) = Antenna Factor(dB/m) + Cable Factor(dB) – Pre-Amplifier Factor(dB)
3. The other emission levels were very low against the limit.
4. Margin value = Emission Level – Limit value



A D T

CHANNEL	TX Channel 78	DETECTOR FUNCTION	Quasi-Peak (QP)
FREQUENCY RANGE	30MHz ~ 1GHz		

ANTENNA POLARITY & TEST DISTANCE: HORIZONTAL AT 3 M								
NO.	FREQ. (MHz)	EMISSION LEVEL (dBuV/m)	LIMIT (dBuV/m)	MARGIN (dB)	ANTENNA HEIGHT (m)	TABLE ANGLE (Degree)	RAW VALUE (dBuV)	CORRECTION FACTOR (dB/m)
1	435.58	29.3 QP	46.0	-16.7	1.75 H	222	37.82	-8.51
2	485.46	27.0 QP	46.0	-19.0	1.58 H	161	34.67	-7.64
3	587.85	29.8 QP	46.0	-16.2	1.42 H	330	35.10	-5.33
4	612.74	28.6 QP	46.0	-17.4	1.47 H	96	33.03	-4.46
5	691.72	31.1 QP	46.0	-14.9	1.26 H	210	34.68	-3.62
6	717.26	28.5 QP	46.0	-17.5	1.24 H	130	31.77	-3.31

ANTENNA POLARITY & TEST DISTANCE: VERTICAL AT 3 M								
NO.	FREQ. (MHz)	EMISSION LEVEL (dBuV/m)	LIMIT (dBuV/m)	MARGIN (dB)	ANTENNA HEIGHT (m)	TABLE ANGLE (Degree)	RAW VALUE (dBuV)	CORRECTION FACTOR (dB/m)
1	434.64	26.9 QP	46.0	-19.1	1.46 V	161	35.41	-8.53
2	486.71	28.5 QP	46.0	-17.5	1.31 V	220	36.10	-7.62
3	589.49	28.6 QP	46.0	-17.4	1.05 V	194	33.85	-5.29
4	614.31	28.9 QP	46.0	-17.1	1.71 V	166	33.34	-4.46
5	691.05	27.4 QP	46.0	-18.6	1.41 V	254	31.07	-3.64
6	940.59	29.1 QP	46.0	-16.9	1.49 V	129	28.21	0.85

REMARKS:

1. Emission Level(dBuV/m) = Raw Value(dBuV) + Correction Factor(dB/m)
2. Correction Factor(dB/m) = Antenna Factor(dB/m) + Cable Factor(dB) – Pre-Amplifier Factor(dB)
3. The other emission levels were very low against the limit.
4. Margin value = Emission Level – Limit value



A D T

BT_8DPSK

CHANNEL	TX Channel 0	DETECTOR FUNCTION	Quasi-Peak (QP)
FREQUENCY RANGE	30MHz ~ 1GHz		

ANTENNA POLARITY & TEST DISTANCE: HORIZONTAL AT 3 M

NO.	FREQ. (MHz)	EMISSION LEVEL (dBuV/m)	LIMIT (dBuV/m)	MARGIN (dB)	ANTENNA HEIGHT (m)	TABLE ANGLE (Degree)	RAW VALUE (dBuV)	CORRECTION FACTOR (dB/m)
1	434.99	28.8 QP	46.0	-17.3	1.79 H	197	37.27	-8.52
2	485.31	27.1 QP	46.0	-18.9	1.54 H	165	34.73	-7.64
3	588.58	30.3 QP	46.0	-15.7	1.50 H	342	35.63	-5.31
4	613.42	29.0 QP	46.0	-17.0	1.52 H	68	33.42	-4.46
5	691.85	30.7 QP	46.0	-15.3	1.22 H	208	34.32	-3.62
6	716.36	28.2 QP	46.0	-17.8	1.14 H	129	31.49	-3.31

ANTENNA POLARITY & TEST DISTANCE: VERTICAL AT 3 M

NO.	FREQ. (MHz)	EMISSION LEVEL (dBuV/m)	LIMIT (dBuV/m)	MARGIN (dB)	ANTENNA HEIGHT (m)	TABLE ANGLE (Degree)	RAW VALUE (dBuV)	CORRECTION FACTOR (dB/m)
1	435.23	27.0 QP	46.0	-19.0	1.47 V	120	35.48	-8.52
2	486.56	28.5 QP	46.0	-17.5	1.32 V	208	36.13	-7.62
3	588.64	28.7 QP	46.0	-17.3	1.03 V	178	34.04	-5.31
4	613.77	27.6 QP	46.0	-18.4	1.81 V	155	32.06	-4.46
5	691.85	28.3 QP	46.0	-17.7	1.38 V	243	31.92	-3.62
6	941.22	29.3 QP	46.0	-16.7	1.38 V	97	28.44	0.88

REMARKS:

1. Emission Level(dBuV/m) = Raw Value(dBuV) + Correction Factor(dB/m)
2. Correction Factor(dB/m) = Antenna Factor(dB/m) + Cable Factor(dB) – Pre-Amplifier Factor(dB)
3. The other emission levels were very low against the limit.
4. Margin value = Emission Level – Limit value



A D T

CHANNEL	TX Channel 39	DETECTOR FUNCTION	Quasi-Peak (QP)
FREQUENCY RANGE	30MHz ~ 1GHz		

ANTENNA POLARITY & TEST DISTANCE: HORIZONTAL AT 3 M								
NO.	FREQ. (MHz)	EMISSION LEVEL (dBuV/m)	LIMIT (dBuV/m)	MARGIN (dB)	ANTENNA HEIGHT (m)	TABLE ANGLE (Degree)	RAW VALUE (dBuV)	CORRECTION FACTOR (dB/m)
1	435.36	29.6 QP	46.0	-16.4	1.71 H	189	38.13	-8.52
2	486.01	27.2 QP	46.0	-18.8	1.53 H	165	34.82	-7.64
3	588.47	29.9 QP	46.0	-16.1	1.43 H	347	35.25	-5.32
4	613.23	28.9 QP	46.0	-17.1	1.51 H	60	33.40	-4.46
5	692.02	31.2 QP	46.0	-14.8	1.25 H	211	34.81	-3.62
6	716.34	28.0 QP	46.0	-18.0	1.19 H	142	31.29	-3.31

ANTENNA POLARITY & TEST DISTANCE: VERTICAL AT 3 M								
NO.	FREQ. (MHz)	EMISSION LEVEL (dBuV/m)	LIMIT (dBuV/m)	MARGIN (dB)	ANTENNA HEIGHT (m)	TABLE ANGLE (Degree)	RAW VALUE (dBuV)	CORRECTION FACTOR (dB/m)
1	435.68	27.5 QP	46.0	-18.5	1.42 V	148	36.00	-8.51
2	486.40	28.9 QP	46.0	-17.1	1.37 V	200	36.52	-7.63
3	588.75	27.7 QP	46.0	-18.3	1.00 V	187	33.04	-5.31
4	614.23	27.6 QP	46.0	-18.4	1.71 V	169	32.03	-4.46
5	691.27	27.6 QP	46.0	-18.4	1.44 V	256	31.21	-3.64
6	940.32	28.8 QP	46.0	-17.2	1.43 V	105	27.94	0.85

REMARKS:

1. Emission Level(dBuV/m) = Raw Value(dBuV) + Correction Factor(dB/m)
2. Correction Factor(dB/m) = Antenna Factor(dB/m) + Cable Factor(dB) – Pre-Amplifier Factor(dB)
3. The other emission levels were very low against the limit.
4. Margin value = Emission Level – Limit value



A D T

CHANNEL	TX Channel 78	DETECTOR FUNCTION	Quasi-Peak (QP)
FREQUENCY RANGE	30MHz ~ 1GHz		

ANTENNA POLARITY & TEST DISTANCE: HORIZONTAL AT 3 M

NO.	FREQ. (MHz)	EMISSION LEVEL (dBuV/m)	LIMIT (dBuV/m)	MARGIN (dB)	ANTENNA HEIGHT (m)	TABLE ANGLE (Degree)	RAW VALUE (dBuV)	CORRECTION FACTOR (dB/m)
1	435.57	29.5 QP	46.0	-16.5	1.69 H	199	38.05	-8.51
2	485.89	27.4 QP	46.0	-18.6	1.59 H	172	35.03	-7.64
3	588.28	29.9 QP	46.0	-16.1	1.41 H	319	35.21	-5.32
4	613.38	29.5 QP	46.0	-16.5	1.54 H	97	33.96	-4.46
5	691.48	30.5 QP	46.0	-15.5	1.24 H	206	34.12	-3.64
6	716.34	27.7 QP	46.0	-18.3	1.21 H	144	31.01	-3.31

ANTENNA POLARITY & TEST DISTANCE: VERTICAL AT 3 M

NO.	FREQ. (MHz)	EMISSION LEVEL (dBuV/m)	LIMIT (dBuV/m)	MARGIN (dB)	ANTENNA HEIGHT (m)	TABLE ANGLE (Degree)	RAW VALUE (dBuV)	CORRECTION FACTOR (dB/m)
1	435.17	27.3 QP	46.0	-18.7	1.52 V	145	35.81	-8.52
2	486.40	28.8 QP	46.0	-17.2	1.41 V	217	36.39	-7.63
3	589.34	29.1 QP	46.0	-16.9	1.09 V	177	34.39	-5.29
4	614.02	27.8 QP	46.0	-18.2	1.64 V	159	32.23	-4.46
5	691.72	27.9 QP	46.0	-18.1	1.50 V	242	31.48	-3.62
6	940.44	28.8 QP	46.0	-17.3	1.32 V	102	27.90	0.85

REMARKS:

1. Emission Level(dBuV/m) = Raw Value(dBuV) + Correction Factor(dB/m)
2. Correction Factor(dB/m) = Antenna Factor(dB/m) + Cable Factor(dB) – Pre-Amplifier Factor(dB)
3. The other emission levels were very low against the limit.
4. Margin value = Emission Level – Limit value



A D T

ABOVE 1GHz WORST-CASE DATA

BT_GFSK

CHANNEL	TX Channel 0	DETECTOR FUNCTION	Peak (PK)
FREQUENCY RANGE	1GHz ~ 25GHz		

ANTENNA POLARITY & TEST DISTANCE: HORIZONTAL AT 3 M

NO.	FREQ. (MHz)	EMISSION LEVEL (dBuV/m)	LIMIT (dBuV/m)	MARGIN (dB)	ANTENNA HEIGHT (m)	TABLE ANGLE (Degree)	RAW VALUE (dBuV)	CORRECTION FACTOR (dB/m)
1	2390.00	52.7 PK	74.0	-21.3	1.43 H	138	58.30	-5.60
2	2390.00	22.6 AV	54.0	-31.4	1.43 H	138	28.20	-5.60
3	*2402.00	100.7 PK			1.43 H	138	106.29	-5.59
4	*2402.00	70.6 AV			1.43 H	138	76.19	-5.59
5	4804.00	45.6 PK	74.0	-28.4	1.38 H	326	41.71	3.89
6	4804.00	15.5 AV	54.0	-38.5	1.38 H	326	11.61	3.89

ANTENNA POLARITY & TEST DISTANCE: VERTICAL AT 3 M

NO.	FREQ. (MHz)	EMISSION LEVEL (dBuV/m)	LIMIT (dBuV/m)	MARGIN (dB)	ANTENNA HEIGHT (m)	TABLE ANGLE (Degree)	RAW VALUE (dBuV)	CORRECTION FACTOR (dB/m)
1	2390.00	53.2 PK	74.0	-20.8	1.06 V	188	58.80	-5.60
2	2390.00	23.1 AV	54.0	-30.9	1.06 V	188	28.70	-5.60
3	*2402.00	101.3 PK			1.06 V	188	106.89	-5.59
4	*2402.00	71.2 AV			1.06 V	188	76.79	-5.59
5	4804.00	47.3 PK	74.0	-26.7	1.18 V	150	43.41	3.89
6	4804.00	17.2 AV	54.0	-36.8	1.18 V	150	13.31	3.89

REMARKS:

1. Emission Level(dBuV/m) = Raw Value(dBuV) + Correction Factor(dB/m)
2. Correction Factor(dB/m) = Antenna Factor(dB/m) + Cable Factor(dB) – Pre-Amplifier Factor(dB)
3. The other emission levels were very low against the limit.
4. Margin value = Emission Level – Limit value
5. " * ": Fundamental frequency.
6. The DH5 packet was the worse case duty cycle for a transmit dwell time on a channel, based upon bluetooth theory the transmitter is on 0.625 * 5 per 296.25 ms per channel. Therefore, the duty cycle correlation factor be equal to: $20\log(3.125 / 100) = -30.1$ dB
7. Average value = peak reading + $20\log(\text{duty cycle})$.



A D T

CHANNEL	TX Channel 39	DETECTOR FUNCTION	Peak (PK)
FREQUENCY RANGE	1GHz ~ 25GHz		

ANTENNA POLARITY & TEST DISTANCE: HORIZONTAL AT 3 M

NO.	FREQ. (MHz)	EMISSION LEVEL (dBuV/m)	LIMIT (dBuV/m)	MARGIN (dB)	ANTENNA HEIGHT (m)	TABLE ANGLE (Degree)	RAW VALUE (dBuV)	CORRECTION FACTOR (dB/m)
1	*2441.00	100.4 PK			1.47 H	135	105.80	-5.40
2	*2441.00	70.3 AV			1.47 H	135	75.70	-5.40
3	4882.00	46.4 PK	74.0	-27.6	1.43 H	303	42.60	3.80
4	4882.00	16.3 AV	54.0	-37.7	1.43 H	303	12.50	3.80
5	7323.00	52.1 PK	74.0	-21.9	1.13 H	151	43.82	8.28
6	7323.00	22.0 AV	54.0	-32.0	1.13 H	151	13.72	8.28

ANTENNA POLARITY & TEST DISTANCE: VERTICAL AT 3 M

NO.	FREQ. (MHz)	EMISSION LEVEL (dBuV/m)	LIMIT (dBuV/m)	MARGIN (dB)	ANTENNA HEIGHT (m)	TABLE ANGLE (Degree)	RAW VALUE (dBuV)	CORRECTION FACTOR (dB/m)
1	*2441.00	101.0 PK			1.11 V	166	106.40	-5.40
2	*2441.00	70.9 AV			1.11 V	166	76.30	-5.40
3	4882.00	47.3 PK	74.0	-26.7	1.19 V	159	43.50	3.80
4	4882.00	17.2 AV	54.0	-36.8	1.19 V	159	13.40	3.80
5	7323.00	52.6 PK	74.0	-21.4	1.40 V	327	44.32	8.28
6	7323.00	22.5 AV	54.0	-31.5	1.40 V	327	14.22	8.28

REMARKS:

1. Emission Level(dBuV/m) = Raw Value(dBuV) + Correction Factor(dB/m)
2. Correction Factor(dB/m) = Antenna Factor(dB/m) + Cable Factor(dB) – Pre-Amplifier Factor(dB)
3. The other emission levels were very low against the limit.
4. Margin value = Emission Level – Limit value
5. " * ": Fundamental frequency.
6. The DH5 packet was the worse case duty cycle for a transmit dwell time on a channel, based upon bluetooth theory the transmitter is on 0.625 * 5 per 296.25 ms per channel. Therefore, the duty cycle correlation factor be equal to: $20\log(3.125 / 100) = -30.1$ dB
7. Average value = peak reading + $20\log(\text{duty cycle})$.



A D T

CHANNEL	TX Channel 78	DETECTOR FUNCTION	Peak (PK)
FREQUENCY RANGE	1GHz ~ 25GHz		

ANTENNA POLARITY & TEST DISTANCE: HORIZONTAL AT 3 M

NO.	FREQ. (MHz)	EMISSION LEVEL (dBuV/m)	LIMIT (dBuV/m)	MARGIN (dB)	ANTENNA HEIGHT (m)	TABLE ANGLE (Degree)	RAW VALUE (dBuV)	CORRECTION FACTOR (dB/m)
1	*2480.00	99.6 PK			1.28 H	167	104.83	-5.23
2	*2480.00	69.5 AV			1.28 H	167	74.73	-5.23
3	2483.50	49.2 PK	74.0	-24.8	1.28 H	167	54.40	-5.20
4	2483.50	19.1 AV	54.0	-34.9	1.28 H	167	24.30	-5.20
5	4960.00	46.3 PK	74.0	-27.7	1.38 H	320	42.47	3.83
6	4960.00	16.2 AV	54.0	-37.8	1.38 H	320	12.37	3.83
7	7440.00	52.0 PK	74.0	-22.0	1.10 H	148	43.32	8.68
8	7440.00	21.9 AV	54.0	-32.1	1.10 H	148	13.22	8.68

ANTENNA POLARITY & TEST DISTANCE: VERTICAL AT 3 M

NO.	FREQ. (MHz)	EMISSION LEVEL (dBuV/m)	LIMIT (dBuV/m)	MARGIN (dB)	ANTENNA HEIGHT (m)	TABLE ANGLE (Degree)	RAW VALUE (dBuV)	CORRECTION FACTOR (dB/m)
1	*2480.00	100.6 PK			1.34 V	125	105.83	-5.23
2	*2480.00	70.5 AV			1.34 V	125	75.73	-5.23
3	2483.50	58.7 PK	74.0	-15.3	1.34 V	125	63.90	-5.20
4	2483.50	28.6 AV	54.0	-25.4	1.34 V	125	33.80	-5.20
5	4960.00	47.3 PK	74.0	-26.7	1.22 V	156	43.47	3.83
6	4960.00	17.2 AV	54.0	-36.8	1.22 V	156	13.37	3.83
7	7440.00	52.2 PK	74.0	-21.8	1.43 V	325	43.52	8.68
8	7440.00	22.1 AV	54.0	-31.9	1.43 V	325	13.42	8.68

REMARKS:

- Emission Level(dBuV/m) = Raw Value(dBuV) + Correction Factor(dB/m)
- Correction Factor(dB/m) = Antenna Factor(dB/m) + Cable Factor(dB) – Pre-Amplifier Factor(dB)
- The other emission levels were very low against the limit.
- Margin value = Emission Level – Limit value
- " * ": Fundamental frequency.
- The DH5 packet was the worse case duty cycle for a transmit dwell time on a channel, based upon bluetooth theory the transmitter is on 0.625 * 5 per 296.25 ms per channel. Therefore, the duty cycle correlation factor be equal to: $20\log(3.125 / 100) = -30.1$ dB
- Average value = peak reading + $20\log(\text{duty cycle})$.



A D T

BT_8DPSK

CHANNEL	TX Channel 0	DETECTOR FUNCTION	Peak (PK)
FREQUENCY RANGE	1GHz ~ 25GHz		

ANTENNA POLARITY & TEST DISTANCE: HORIZONTAL AT 3 M

NO.	FREQ. (MHz)	EMISSION LEVEL (dBuV/m)	LIMIT (dBuV/m)	MARGIN (dB)	ANTENNA HEIGHT (m)	TABLE ANGLE (Degree)	RAW VALUE (dBuV)	CORRECTION FACTOR (dB/m)
1	2390.00	53.3 PK	74.0	-20.7	1.34 H	115	58.90	-5.60
2	2390.00	23.2 AV	54.0	-30.8	1.34 H	115	28.80	-5.60
3	*2402.00	100.9 PK			1.34 H	115	106.49	-5.59
4	*2402.00	70.8 AV			1.34 H	115	76.39	-5.59
5	4804.00	45.9 PK	74.0	-28.1	1.37 H	307	42.01	3.89
6	4804.00	15.8 AV	54.0	-38.2	1.37 H	307	11.91	3.89

ANTENNA POLARITY & TEST DISTANCE: VERTICAL AT 3 M

NO.	FREQ. (MHz)	EMISSION LEVEL (dBuV/m)	LIMIT (dBuV/m)	MARGIN (dB)	ANTENNA HEIGHT (m)	TABLE ANGLE (Degree)	RAW VALUE (dBuV)	CORRECTION FACTOR (dB/m)
1	2390.00	53.2 PK	74.0	-20.8	1.02 V	265	58.80	-5.60
2	2390.00	23.1 AV	54.0	-30.9	1.02 V	265	28.70	-5.60
3	*2402.00	101.6 PK			1.02 V	265	107.19	-5.59
4	*2402.00	71.5 AV			1.02 V	265	77.09	-5.59
5	4804.00	47.6 PK	74.0	-26.4	1.16 V	153	43.71	3.89
6	4804.00	17.5 AV	54.0	-36.5	1.16 V	153	13.61	3.89

REMARKS:

1. Emission Level(dBuV/m) = Raw Value(dBuV) + Correction Factor(dB/m)
2. Correction Factor(dB/m) = Antenna Factor(dB/m) + Cable Factor(dB) – Pre-Amplifier Factor(dB)
3. The other emission levels were very low against the limit.
4. Margin value = Emission Level – Limit value
5. " * " : Fundamental frequency.
6. The DH5 packet was the worse case duty cycle for a transmit dwell time on a channel, based upon bluetooth theory the transmitter is on 0.625 * 5 per 296.25 ms per channel. Therefore, the duty cycle correlation factor be equal to: $20\log(3.125 / 100) = -30.1$ dB
7. Average value = peak reading + $20\log(\text{duty cycle})$.



A D T

CHANNEL	TX Channel 39	DETECTOR FUNCTION	Peak (PK)
FREQUENCY RANGE	1GHz ~ 25GHz		

ANTENNA POLARITY & TEST DISTANCE: HORIZONTAL AT 3 M								
NO.	FREQ. (MHz)	EMISSION LEVEL (dBuV/m)	LIMIT (dBuV/m)	MARGIN (dB)	ANTENNA HEIGHT (m)	TABLE ANGLE (Degree)	RAW VALUE (dBuV)	CORRECTION FACTOR (dB/m)
1	*2441.00	100.6 PK			1.31 H	130	106.00	-5.40
2	*2441.00	70.5 AV			1.31 H	130	75.90	-5.40
3	4882.00	46.2 PK	74.0	-27.8	1.43 H	331	42.40	3.80
4	4882.00	16.1 AV	54.0	-37.9	1.43 H	331	12.30	3.80
5	7323.00	51.4 PK	74.0	-22.6	1.09 H	131	43.12	8.28
6	7323.00	21.3 AV	54.0	-32.7	1.09 H	131	13.02	8.28

ANTENNA POLARITY & TEST DISTANCE: VERTICAL AT 3 M								
NO.	FREQ. (MHz)	EMISSION LEVEL (dBuV/m)	LIMIT (dBuV/m)	MARGIN (dB)	ANTENNA HEIGHT (m)	TABLE ANGLE (Degree)	RAW VALUE (dBuV)	CORRECTION FACTOR (dB/m)
1	*2441.00	101.9 PK			1.01 V	254	107.30	-5.40
2	*2441.00	71.8 AV			1.01 V	254	77.20	-5.40
3	4882.00	46.6 PK	74.0	-27.4	1.24 V	144	42.80	3.80
4	4882.00	16.5 AV	54.0	-37.5	1.24 V	144	12.70	3.80
5	7323.00	52.1 PK	74.0	-21.9	1.43 V	308	43.82	8.28
6	7323.00	22.0 AV	54.0	-32.0	1.43 V	308	13.72	8.28

REMARKS:

1. Emission Level(dBuV/m) = Raw Value(dBuV) + Correction Factor(dB/m)
2. Correction Factor(dB/m) = Antenna Factor(dB/m) + Cable Factor(dB) – Pre-Amplifier Factor(dB)
3. The other emission levels were very low against the limit.
4. Margin value = Emission Level – Limit value
5. " * ": Fundamental frequency.
6. The DH5 packet was the worse case duty cycle for a transmit dwell time on a channel, based upon bluetooth theory the transmitter is on 0.625 * 5 per 296.25 ms per channel. Therefore, the duty cycle correlation factor be equal to: $20\log(3.125 / 100) = -30.1$ dB
7. Average value = peak reading + $20\log(\text{duty cycle})$.



A D T

CHANNEL	TX Channel 78	DETECTOR FUNCTION	Peak (PK)
FREQUENCY RANGE	1GHz ~ 25GHz		

ANTENNA POLARITY & TEST DISTANCE: HORIZONTAL AT 3 M

NO.	FREQ. (MHz)	EMISSION LEVEL (dBuV/m)	LIMIT (dBuV/m)	MARGIN (dB)	ANTENNA HEIGHT (m)	TABLE ANGLE (Degree)	RAW VALUE (dBuV)	CORRECTION FACTOR (dB/m)
1	*2480.00	101.1 PK			1.34 H	129	106.33	-5.23
2	*2480.00	71.0 AV			1.34 H	129	76.23	-5.23
3	2483.50	51.6 PK	74.0	-22.4	1.34 H	129	56.80	-5.20
4	2483.50	21.5 AV	54.0	-32.5	1.34 H	129	26.70	-5.20
5	4960.00	46.0 PK	74.0	-28.0	1.33 H	310	42.17	3.83
6	4960.00	15.9 AV	54.0	-38.1	1.33 H	310	12.07	3.83
7	7440.00	52.0 PK	74.0	-22.0	1.11 H	142	43.32	8.68
8	7440.00	21.9 AV	54.0	-32.1	1.11 H	142	13.22	8.68

ANTENNA POLARITY & TEST DISTANCE: VERTICAL AT 3 M

NO.	FREQ. (MHz)	EMISSION LEVEL (dBuV/m)	LIMIT (dBuV/m)	MARGIN (dB)	ANTENNA HEIGHT (m)	TABLE ANGLE (Degree)	RAW VALUE (dBuV)	CORRECTION FACTOR (dB/m)
1	*2480.00	101.6 PK			1.00 V	264	106.83	-5.23
2	*2480.00	71.5 AV			1.00 V	264	76.73	-5.23
3	2483.50	54.6 PK	74.0	-19.4	1.00 V	264	59.80	-5.20
4	2483.50	24.5 AV	54.0	-29.5	1.00 V	264	29.70	-5.20
5	4960.00	48.0 PK	74.0	-26.0	1.19 V	141	44.17	3.83
6	4960.00	17.9 AV	54.0	-36.1	1.19 V	141	14.07	3.83
7	7440.00	51.5 PK	74.0	-22.5	1.39 V	316	42.82	8.68
8	7440.00	21.4 AV	54.0	-32.6	1.39 V	316	12.72	8.68

REMARKS:

- Emission Level(dBuV/m) = Raw Value(dBuV) + Correction Factor(dB/m)
- Correction Factor(dB/m) = Antenna Factor(dB/m) + Cable Factor(dB) – Pre-Amplifier Factor(dB)
- The other emission levels were very low against the limit.
- Margin value = Emission Level – Limit value
- " * ": Fundamental frequency.
- The DH5 packet was the worse case duty cycle for a transmit dwell time on a channel, based upon bluetooth theory the transmitter is on 0.625 * 5 per 296.25 ms per channel. Therefore, the duty cycle correlation factor be equal to: $20\log(3.125 / 100) = -30.1$ dB
- Average value = peak reading + $20\log(\text{duty cycle})$.

4.3 NUMBER OF HOPPING FREQUENCY USED

4.3.1 LIMIT OF HOPPING FREQUENCY USED

At least 15 hopping frequencies, and should be equally spaced.

4.3.2 TEST INSTRUMENTS

DESCRIPTION & MANUFACTURER	MODEL NO.	SERIAL NO.	CALIBRATED DATE	CALIBRATED UNTIL
SPECTRUM ANALYZER R&S	FSV 40	100964	July 15, 2013	July 14, 2014

Note:

1. The calibration interval of the above test instruments is 12 months and the calibrations are traceable to NML/ROC and NIST/USA.
2. Tested date : June 30, 2014

4.3.3 TEST PROCEDURES

- a. Check the calibration of the measuring instrument (SA) using either an internal calibrator or a known signal from an external generator.
- b. Turn on the EUT and connect its antenna terminal to measurement via a low loss cable. Then set it to any one measured frequency within its operating range and make sure the instrument is operated in its linear range.
- c. Set the SA on MaxHold Mode, and then keep the EUT in hopping mode. Record all the signals from each channel until each one has been recorded.
- d. Set the SA on View mode and then plot the result on SA screen.
- e. Repeat above procedures until all frequencies measured were complete.

4.3.4 DEVIATION FROM TEST STANDARD

No deviation

4.3.5 TEST SETUP

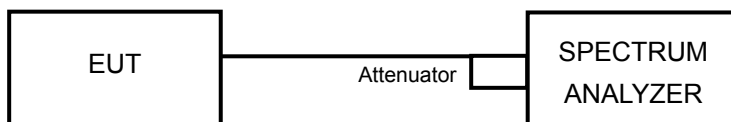

4.3.6 TEST RESULTS

There are 79 hopping frequencies in the hopping mode. Please refer the test result. On the plots, it shows that the hopping frequencies are equally spaced.

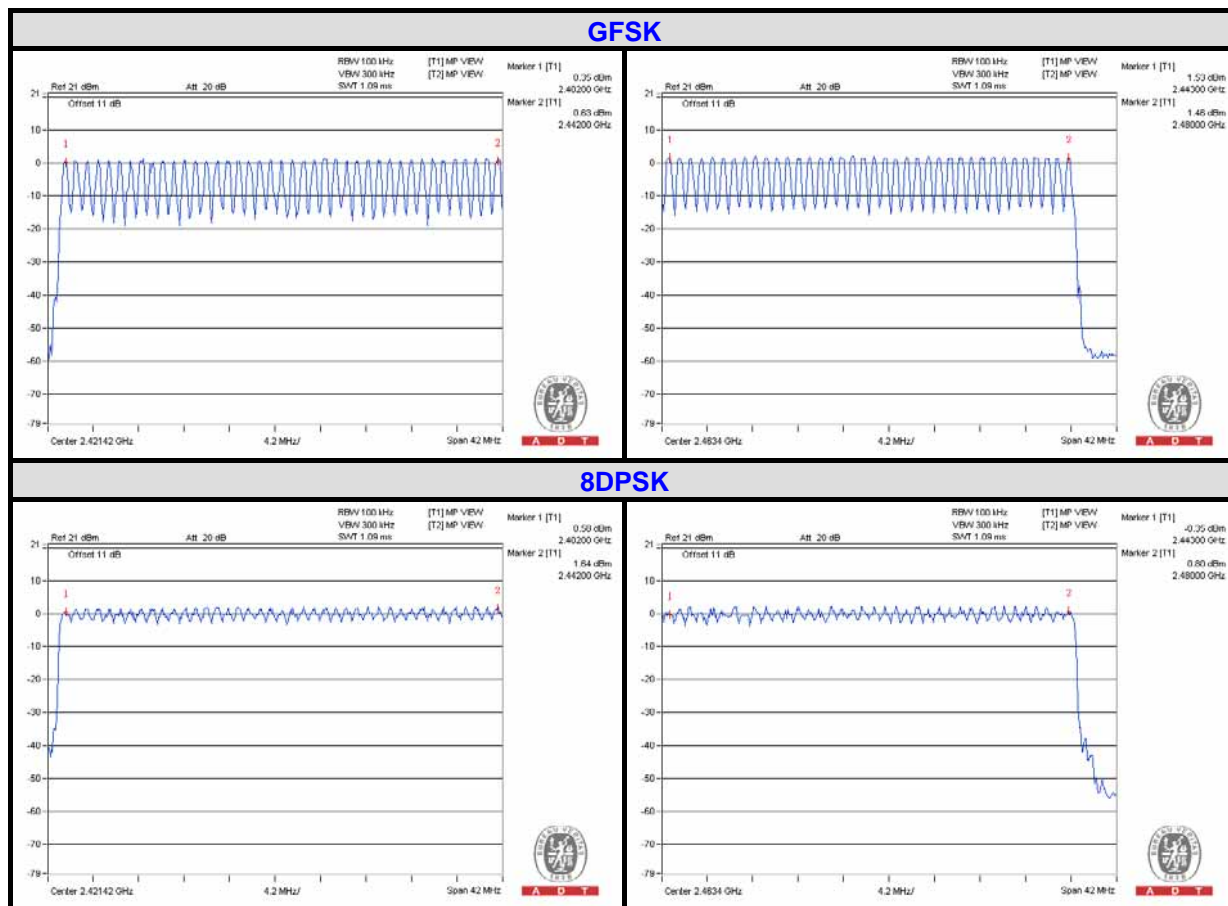

4.4 DWELL TIME ON EACH CHANNEL

4.4.1 LIMIT OF DWELL TIME USED

The average time of occupancy on any channel shall not be greater than 0.4 seconds within a period of 0.4 seconds multiplied by the number of hopping channels employed.

4.4.2 TEST INSTRUMENTS

DESCRIPTION & MANUFACTURER	MODEL NO.	SERIAL NO.	CALIBRATED DATE	CALIBRATED UNTIL
SPECTRUM ANALYZER R&S	FSV 40	100964	July 15, 2013	July 14, 2014

Note:

1. The calibration interval of the above test instruments is 12 months and the calibrations are traceable to NML/ROC and NIST/USA.
2. Tested date : June 30, 2014

4.4.3 TEST PROCEDURES

- a. Check the calibration of the measuring instrument (SA) using either an internal calibrator or a known signal from an external generator.
- b. Turn on the EUT and connect its antenna terminal to measurement via a low loss cable. Then set it to any one measured frequency within its operating range and make sure the instrument is operated in its linear range.
- c. Adjust the center frequency of SA on any frequency be measured and set SA to zero span mode. And then, set RBW and VBW of spectrum analyzer to proper value.
- d. Measure the time duration of one transmission on the measured frequency. And then plot the result with time difference of this time duration.
- e. Repeat above procedures until all different time-slot modes have been completed.



A D T

4.4.4 DEVIATION FROM TEST STANDARD

No deviation

4.4.5 TEST SETUP

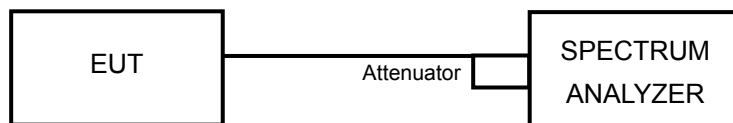

4.4.6 TEST RESULTS

For GFSK:

Mode	Number of transmission in a 31.6 (79Hopping*0.4)	Length of transmission time (msec)	Result (msec)	Limit (msec)
DH1	51 (times / 5 sec) *6.32=322.32 times	0.426	137.31	400
DH3	25 (times / 5 sec) *6.32=158 times	1.689	266.86	400
DH5	18 (times / 5 sec) *6.32=113.76 times	3.037	345.49	400

NOTE: Test plots of the transmitting time slot are shown on next page.



A D T

DH1

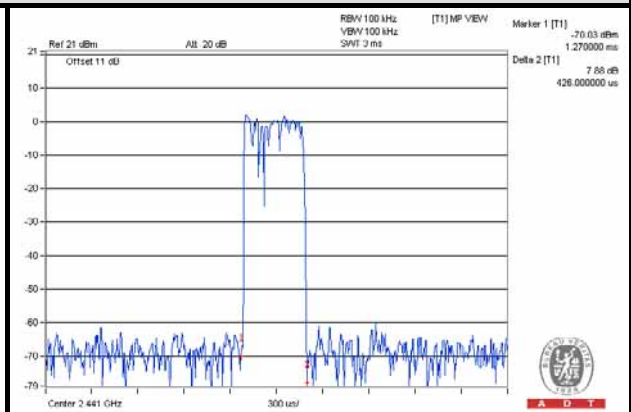
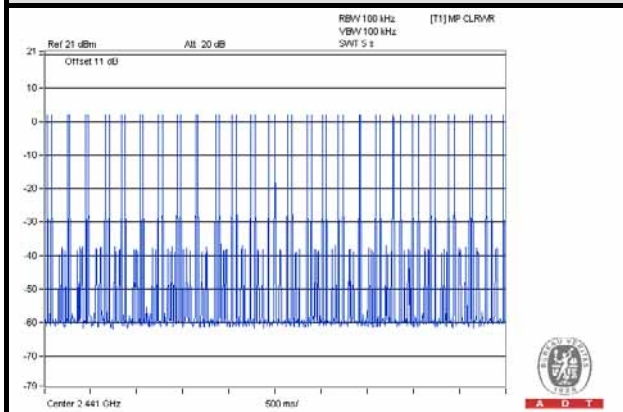

DH3

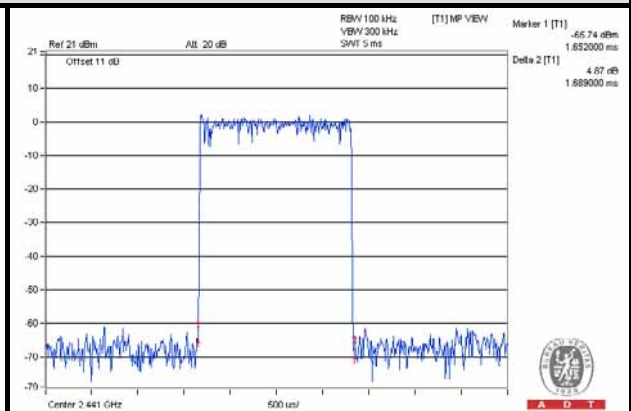
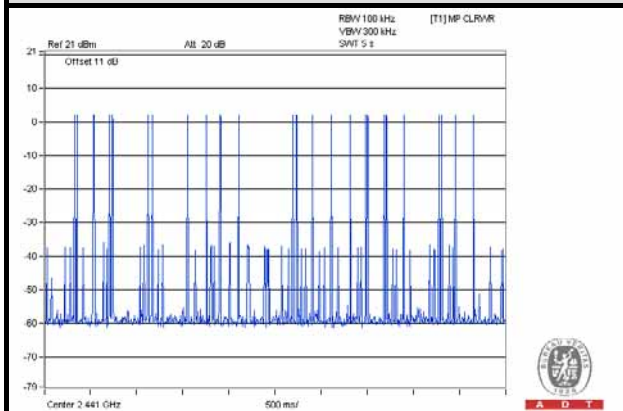

DH5

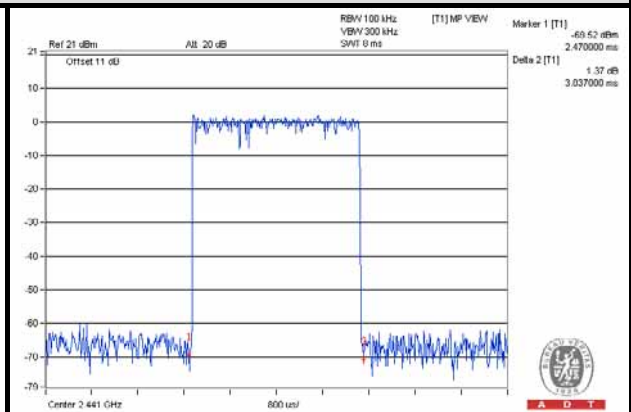
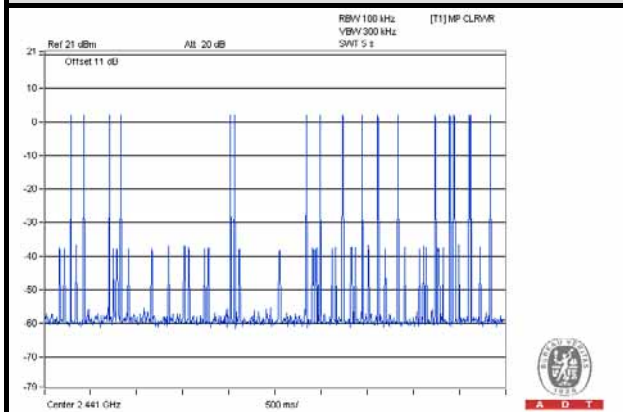



A D T

For 8DPSK:

Mode	Number of transmission in a 31.6 (79Hopping*0.4)	Length of transmission time (msec)	Result (msec)	Limit (msec)
DH1	50 (times / 5 sec) *6.32=316 times	0.27	85.32	400
DH3	27 (times / 5 sec) *6.32=170.64 times	1.689	288.21	400
DH5	17 (times / 5 sec) *6.32=107.44 times	2.921	313.83	400

NOTE: Test plots of the transmitting time slot are shown on next page.



A D T

3DH1

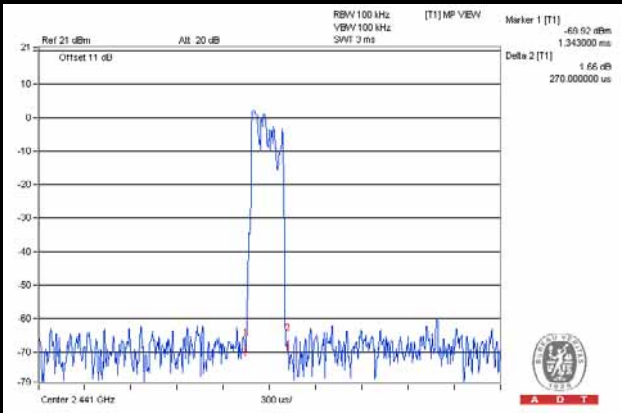
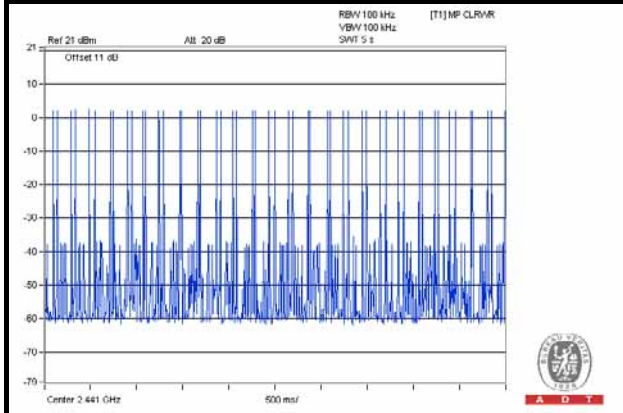

3DH3

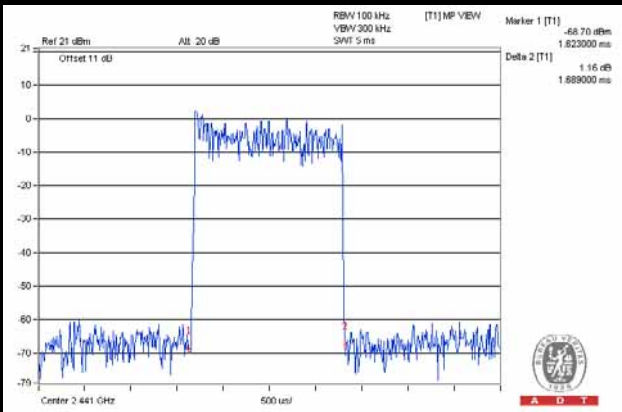
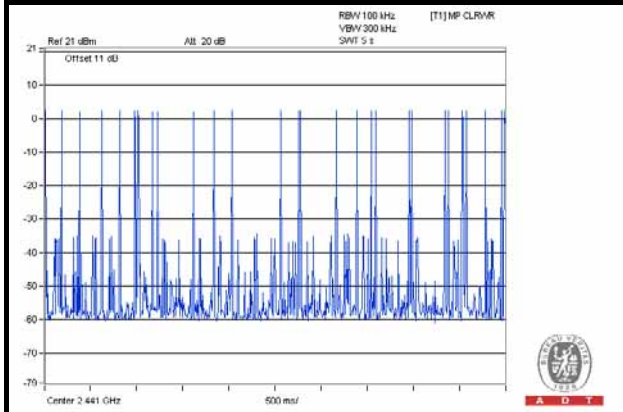

3DH5

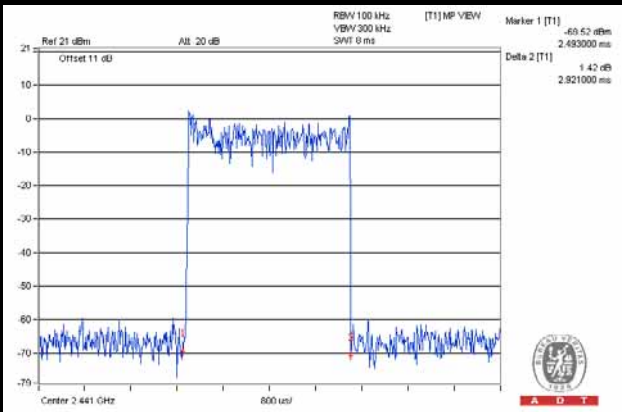
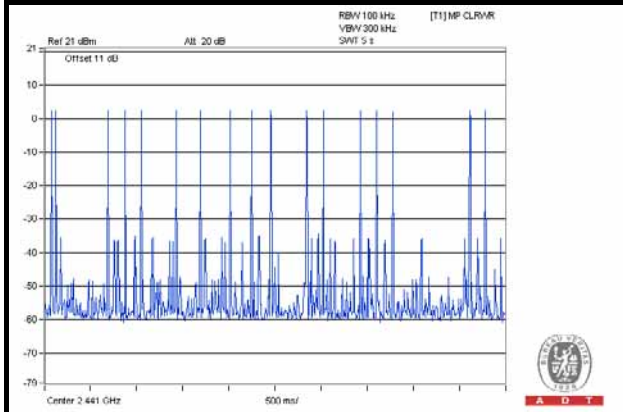

4.5 CHANNEL BANDWIDTH

4.5.1 LIMITS OF CHANNEL BANDWIDTH

For frequency hopping system operating in the 2400-2483.5MHz, If the 20dB bandwidth of hopping channel is greater than 25kHz, two-thirds 20dB bandwidth of hopping channel shall be a minimum limit for the hopping channel separation.

4.5.2 TEST INSTRUMENTS

DESCRIPTION & MANUFACTURER	MODEL NO.	SERIAL NO.	CALIBRATED DATE	CALIBRATED UNTIL
SPECTRUM ANALYZER R&S	FSV 40	100964	July 15, 2013	July 14, 2014

Note:

1. The calibration interval of the above test instruments is 12 months and the calibrations are traceable to NML/ROC and NIST/USA.
2. Tested date : June 30, 2014

4.5.3 TEST PROCEDURE

- a. Check the calibration of the measuring instrument using either an internal calibrator or a known signal from an external generator.
- b. Turn on the EUT and connect it to measurement instrument. Then set it to any one convenient frequency within its operating range. Set a reference level on the measuring instrument equal to the highest peak value.
- c. Measure the frequency difference of two frequencies that were attenuated 20dB from the reference level. Record the frequency difference as the emission bandwidth.
- d. Repeat above procedures until all frequencies measured were complete.

4.5.4 DEVIATION FROM TEST STANDARD

No deviation

4.5.5 TEST SETUP

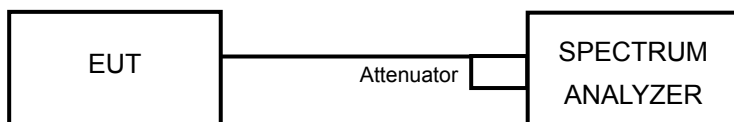

4.5.6 EUT OPERATING CONDITION

The software provided by client enabled the EUT to transmit and receive data at lowest, middle and highest channel frequencies individually.



A D T

4.5.7 TEST RESULTS

CHANNEL	FREQUENCY (MHz)	20dB BANDWIDTH (MHz)	
		GFSK	8DPSK
0	2402	1.01	1.33
39	2441	1.01	1.33
78	2480	1.03	1.34

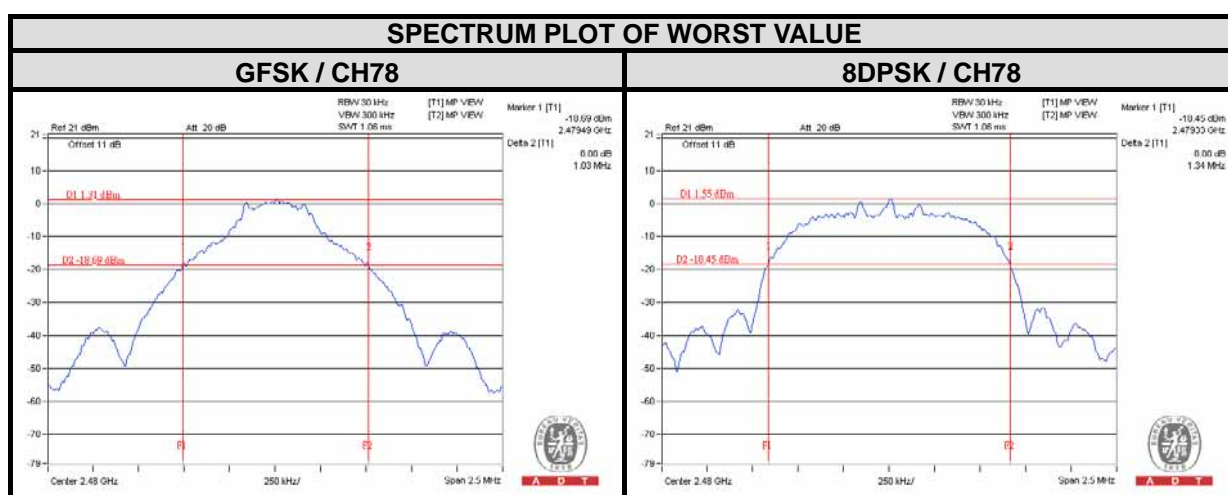

4.6 HOPPING CHANNEL SEPARATION

4.6.1 LIMIT OF HOPPING CHANNEL SEPARATION

At least 25 kHz or two-thirds of 20dB hopping channel bandwidth (whichever is greater).

4.6.2 TEST INSTRUMENTS

DESCRIPTION & MANUFACTURER	MODEL NO.	SERIAL NO.	CALIBRATED DATE	CALIBRATED UNTIL
SPECTRUM ANALYZER R&S	FSV 40	100964	July 15, 2013	July 14, 2014

Note:

1. The calibration interval of the above test instruments is 12 months and the calibrations are traceable to NML/ROC and NIST/USA.
2. Tested date : June 30, 2014

4.6.3 TEST PROCEDURES

- a. Check the calibration of the measuring instrument using either an internal calibrator or a known signal from an external generator.
- b. Turn on the EUT and connect it to measurement instrument. Then set it to any one convenient frequency within its operating range.
- c. By using the MaxHold function record the separation of two adjacent channels.
- d. Measure the frequency difference of these two adjacent channels by SA MARK function. And then plot the result on SA screen.
- e. Repeat above procedures until all frequencies measured were complete.

4.6.4 DEVIATION FROM TEST STANDARD

No deviation

4.6.5 TEST SETUP

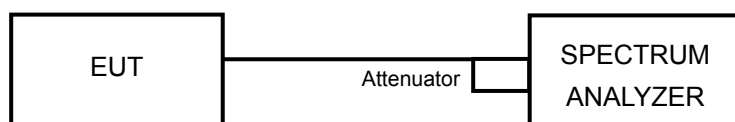

4.6.6 TEST RESULTS

CHANNEL	FREQUENCY (MHz)	ADJACENT CHANNEL SEPARATION (MHz)		20dB BANDWIDTH (MHz)		MINIMUM LIMIT (MHz)		PASS / FAIL
		GFSK	8DPSK	GFSK	8DPSK	GFSK	8DPSK	
0	2402	1.00	1.01	1.01	1.33	0.68	0.89	PASS
39	2441	1.01	1.01	1.01	1.33	0.68	0.89	PASS
78	2480	1.00	1.01	1.03	1.34	0.69	0.90	PASS

NOTE: The minimum limit is two-third 20dB bandwidth.

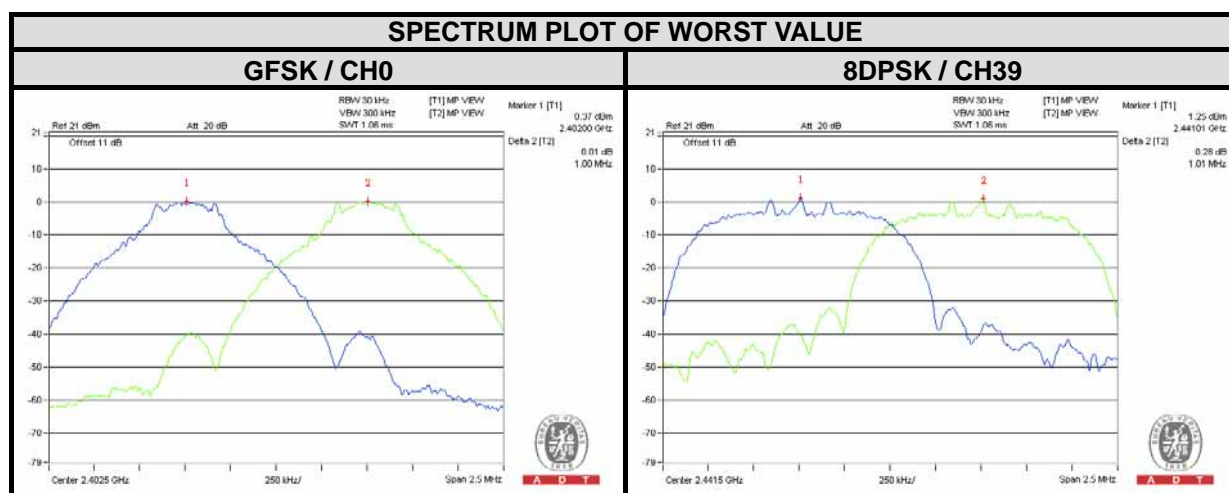

4.7 MAXIMUM PEAK OUTPUT POWER

4.7.1 LIMITS OF MAXIMUM PEAK OUTPUT POWER MEASUREMENT

The Maximum Peak Output Power Limit is 125mW.

4.7.2 INSTRUMENTS

DESCRIPTION & MANUFACTURER	MODEL NO.	SERIAL NO.	CALIBRATED DATE	CALIBRATED UNTIL
SPECTRUM ANALYZER R&S	FSV 40	100964	July 15, 2013	July 14, 2014

Note:

1. The calibration interval of the above test instruments is 12 months and the calibrations are traceable to NML/ROC and NIST/USA.
2. Tested date : June 30, 2014

4.7.3 TEST PROCEDURES

- a. Check the calibration of the measuring instrument using either an internal calibrator or a known signal from an external generator.
- b. Turn on the EUT and connect it to measurement instrument. Then set it to any one convenient frequency within its operating range. Set a reference level on the measuring instrument equal to the highest peak value.
- c. The center frequency of the spectrum analyzer is set to the fundamental frequency and using 3MHz RBW and 10 MHz VBW.
- d. Measure the captured power within the band and recording the plot.
- e. Repeat above procedures until all frequencies required were complete.

4.7.4 DEVIATION FROM TEST STANDARD

No deviation

4.7.5 TEST SETUP

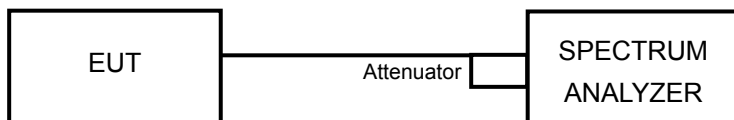

For the actual test configuration, please refer to the related Item – Photographs of the Test Configuration.

4.7.6 EUT OPERATING CONDITION

The software provided by client enabled the EUT to transmit and receive data at lowest, middle and highest channel frequencies individually.



A D T

4.7.7 TEST RESULTS

CHANNEL	FREQUENCY (MHz)	OUTPUT POWER (mW)		OUTPUT POWER (dBm)		POWER LIMIT (mW)	PASS / FAIL
		GFSK	8DPSK	GFSK	8DPSK		
0	2402	1.371	2.793	1.37	4.46	125	PASS
39	2441	1.538	3.206	1.87	5.06	125	PASS
78	2480	1.694	3.451	2.29	5.38	125	PASS

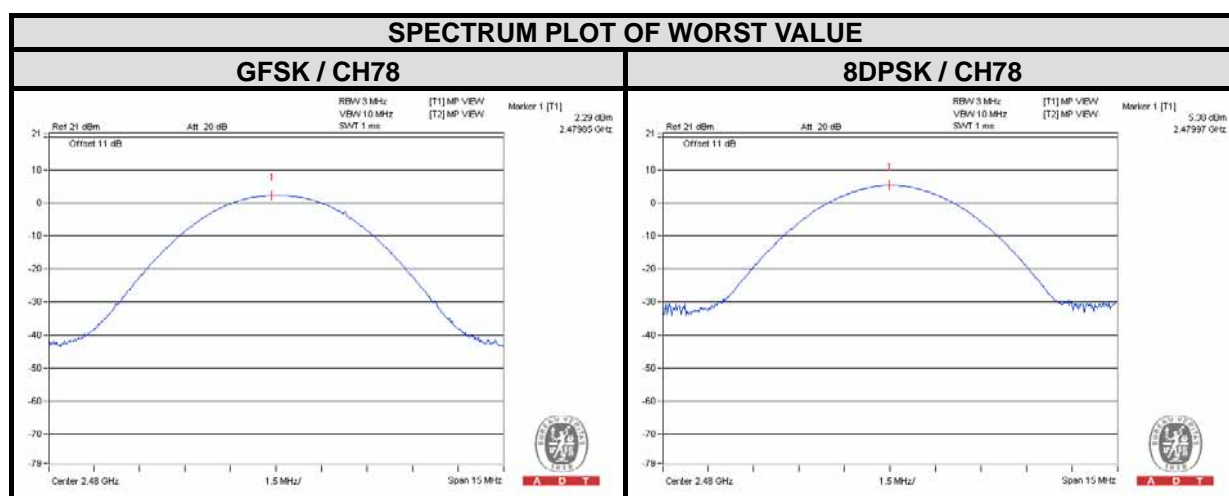

4.8 CONDUCTED OUT-BAND EMISSION MEASUREMENT

4.8.1 LIMITS OF CONDUCTED OUT-BAND EMISSION MEASUREMENT

Below 20dB of the highest emission level of operating band (in 100kHz Resolution Bandwidth).

4.8.2 TEST INSTRUMENTS

DESCRIPTION & MANUFACTURER	MODEL NO.	SERIAL NO.	CALIBRATED DATE	CALIBRATED UNTIL
SPECTRUM ANALYZER R&S	FSV 40	100964	July 15, 2013	July 14, 2014

Note:

1. The calibration interval of the above test instruments is 12 months and the calibrations are traceable to NML/ROC and NIST/USA.
2. Tested date : June 30, 2014

4.8.3 TEST PROCEDURE

The transmitter output was connected to the spectrum analyzer via a low lose cable. Set RBW a of spectrum analyzer to 100 kHz and VBW of spectrum analyzer to 300 kHz with suitable frequency span including 100 MHz bandwidth from band edge. The band edges was measured and recorded.

4.8.4 DEVIATION FROM TEST STANDARD

No deviation

4.8.5 TEST SETUP

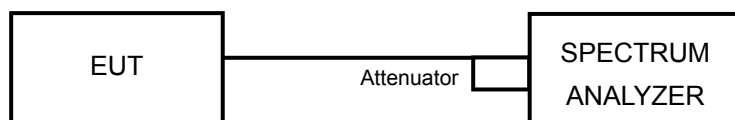

4.8.6 EUT OPERATING CONDITION

The software provided by client enabled the EUT to transmit and receive data at lowest, middle and highest channel frequencies individually.



4.8.7 TEST RESULTS

The spectrum plots are attached on the following images. D1 line indicates the highest level, and D2 line indicates the 20dB offset below D1. It shows compliance with the requirement.



A D T

GFSK

Hopping disabled_Low Channel

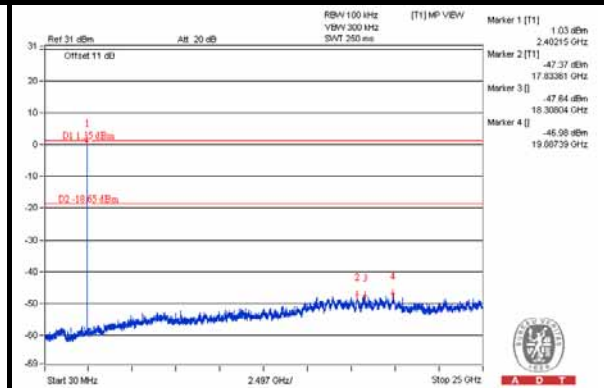
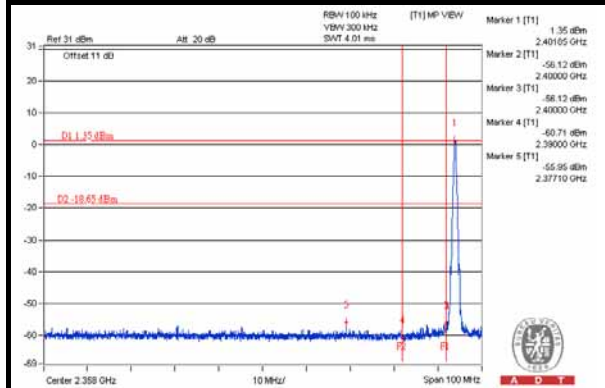

Hopping disabled_High Channel

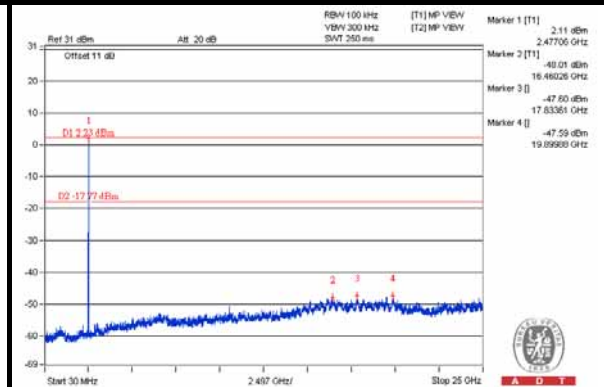
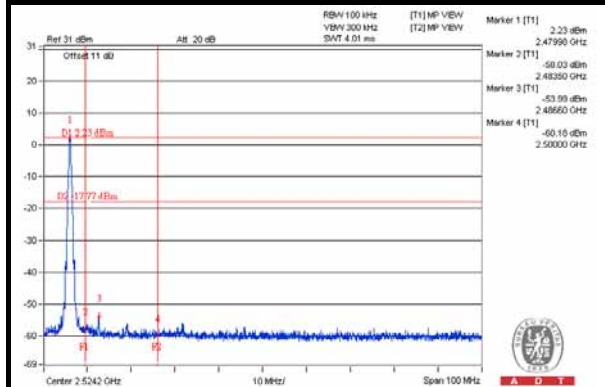

Hopping enabled_Low Channel

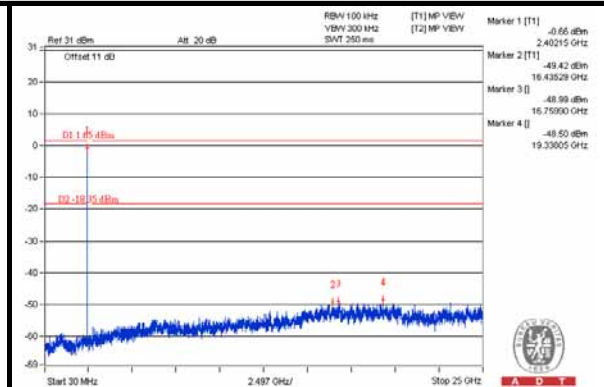
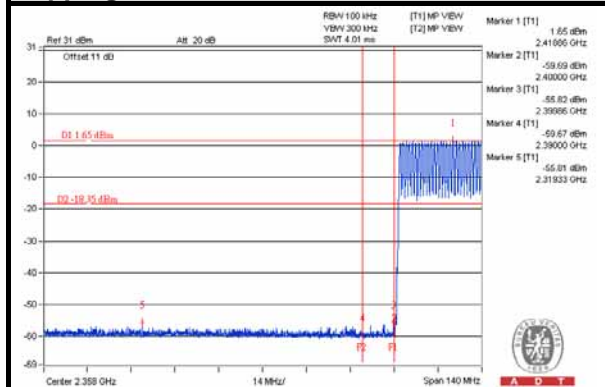

Hopping enabled_High Channel

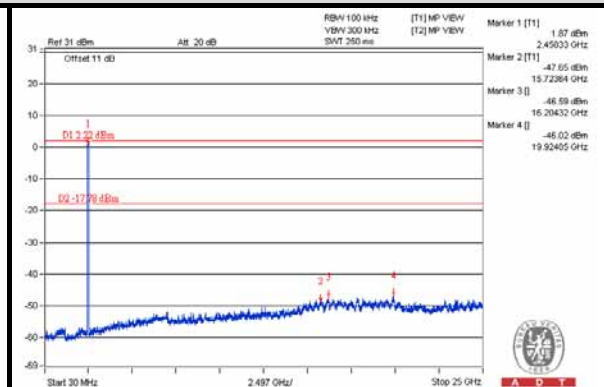
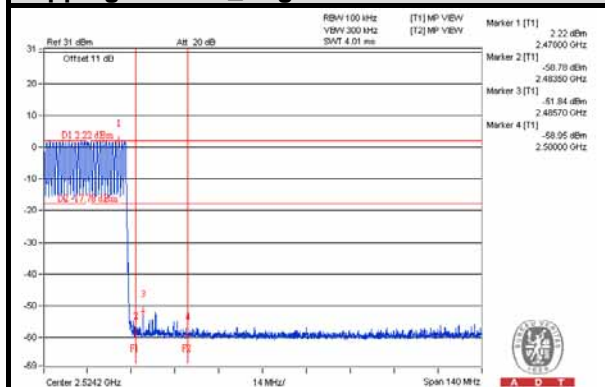



A D T

8DPSK

Hopping disabled_Low Channel

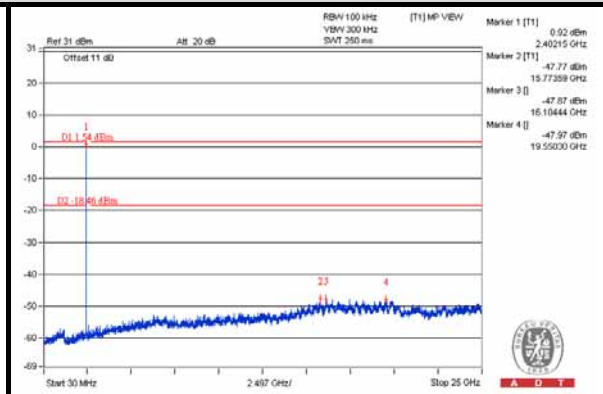
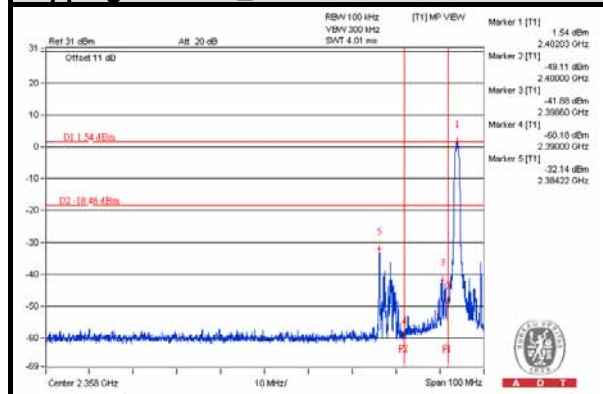

Hopping disabled_High Channel

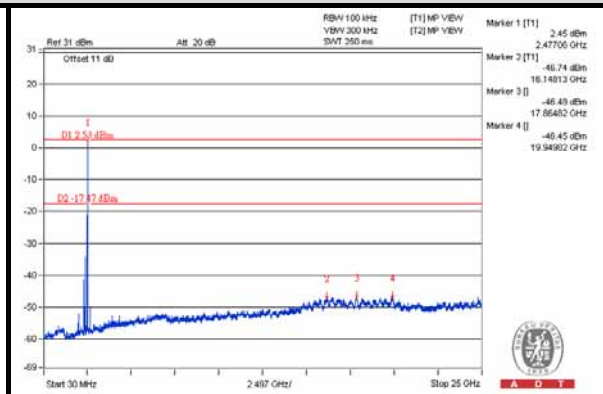
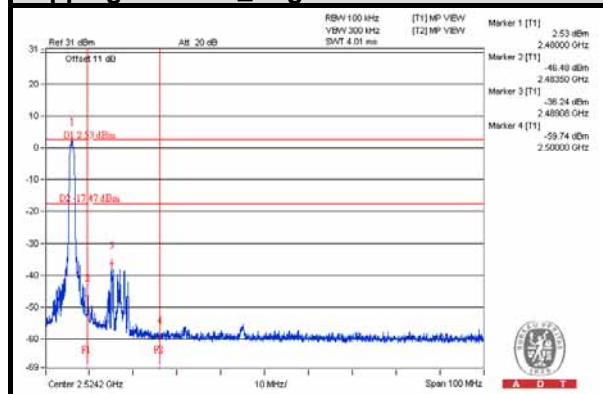

Hopping enabled_Low Channel

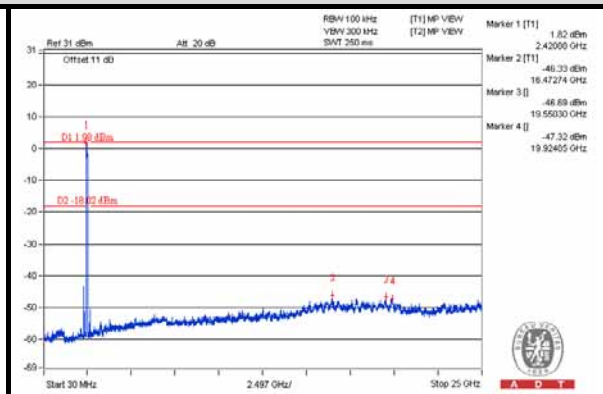
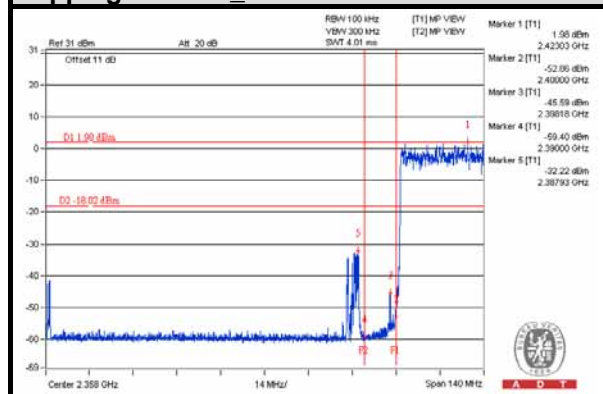

Hopping enabled_High Channel

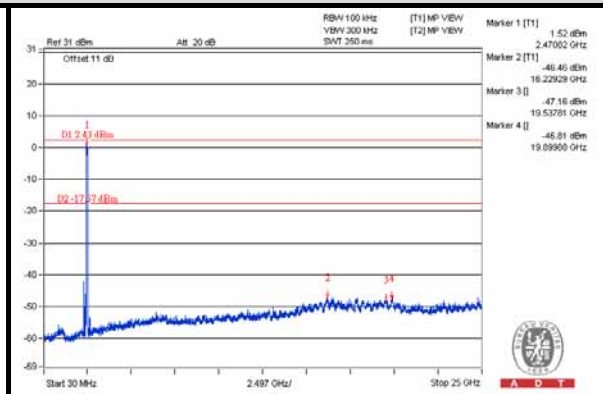
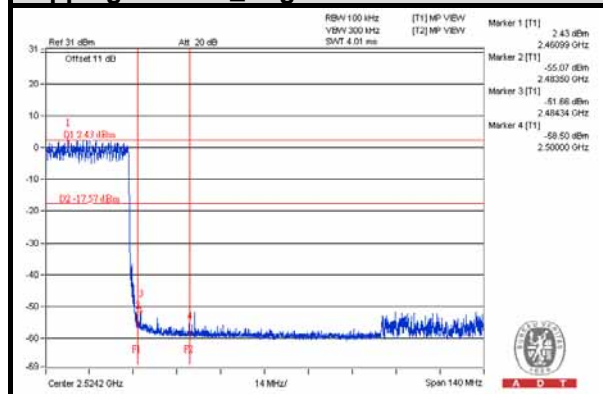

5 TEST TYPES AND RESULTS (BT-LE)

5.1 CONDUCTED EMISSION MEASUREMENT

5.1.1 LIMITS OF CONDUCTED EMISSION MEASUREMENT

FREQUENCY OF EMISSION (MHz)	CONDUCTED LIMIT (dB μ V)	
	Quasi-peak	Average
0.15-0.5	66 to 56	56 to 46
0.5-5	56	46
5-30	60	50

- NOTE:**
1. The lower limit shall apply at the transition frequencies.
 2. The limit decreases in line with the logarithm of the frequency in the range of 0.15 to 0.50 MHz.

5.1.2 TEST INSTRUMENTS

DESCRIPTION & MANUFACTURER	MODEL NO.	SERIAL NO.	CALIBRATED DATE	CALIBRATED UNTIL
Test Receiver ROHDE & SCHWARZ	ESCS 30	100375	Apr. 29, 2014	Apr. 28, 2015
Line-Impedance Stabilization Network (for EUT) SCHWARZBECK	NSLK8127	8127-522	Sep. 12, 2013	Sep. 11, 2014
Line-Impedance Stabilization Network (for Peripheral)	ENV216	100071	Nov. 13, 2013	Nov. 12, 2014
RF Cable (JYEBAO)	5DFB	COCCAB-001	Mar. 10, 2014	Mar. 09, 2015
50 ohms Terminator	N/A	EMC-03	Sep. 24, 2013	Sep. 23, 2014
50 ohms Terminator	N/A	EMC-02	Oct. 01, 2013	Sep. 30, 2014
Software ADT	BV ADT_Cond_V7.3.7. 3	NA	NA	NA

Note:

1. The calibration interval of the above test instruments is 12 months and the calibrations are traceable to NML/ROC and NIST/USA.
2. The test was performed in Shielded Room No. C.
3. The VCCI Con C Registration No. is C-3611.
4. Tested Date: June 26, 2014

5.1.3 TEST PROCEDURES

- a. The EUT was placed 0.4 meters from the conducting wall of the shielded room with EUT being connected to the power mains through a line impedance stabilization network (LISN). Other support units were connected to the power mains through another LISN.
- b. The two LISNs provide 50 ohm/ 50uH of coupling impedance for the measuring instrument.
- c. Both lines of the power mains connected to the EUT were checked for maximum conducted interference.
- d. The frequency range from 150kHz to 30MHz was searched. Emission levels under (Limit - 20dB) were not recorded.

NOTE:

1. The resolution bandwidth of test receiver is 9kHz for Quasi-peak detection (QP) & Average detection (AV).

5.1.4 DEVIATION FROM TEST STANDARD

No deviation

5.1.5 TEST SETUP

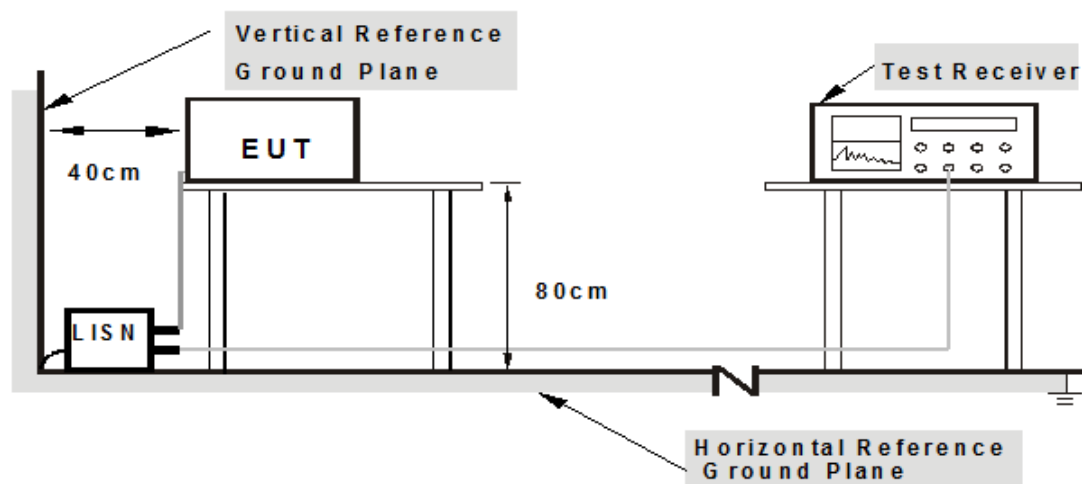

Note: 1. Support units were connected to second LISN.

For the actual test configuration, please refer to the related item – Photographs of the Test Configuration.

5.1.6 EUT OPERATING CONDITIONS

Same as 4.1.6



A D T

5.1.7 TEST RESULTS

PHASE	Line (L)	DETECTOR FUNCTION	Quasi-Peak (QP) / Average (AV)
-------	----------	-------------------	--------------------------------

No	Freq.	Corr.	Reading Value		Emission Level		Limit		Margin	
	[MHz]	Factor (dB)	[dB (uV)] Q.P.	[dB (uV)] AV.	[dB (uV)] Q.P.	[dB (uV)] AV.	[dB (uV)] Q.P.	[dB (uV)] AV.	(dB) Q.P.	(dB) AV.
1	0.15000	0.07	29.11	26.02	29.18	26.09	66.00	56.00	-36.82	-29.91
2	0.16953	0.07	23.68	19.80	23.75	19.87	64.98	54.98	-41.24	-35.12
3	0.19297	0.07	19.08	14.00	19.15	14.07	63.91	53.91	-44.76	-39.84
4	0.59531	0.10	29.26	28.83	29.36	28.93	56.00	46.00	-26.64	-17.07
5	2.23438	0.18	10.69	2.87	10.87	3.05	56.00	46.00	-45.13	-42.95
6	22.12500	0.77	25.98	21.27	26.75	22.04	60.00	50.00	-33.25	-27.96

REMARKS:

1. Q.P. and AV. are abbreviations of quasi-peak and average individually.
2. The emission levels of other frequencies were very low against the limit.
3. Margin value = Emission Level – Limit value
4. Correction Factor = Insertion loss + Cable loss
5. Emission Level = Correction Factor + Reading Value

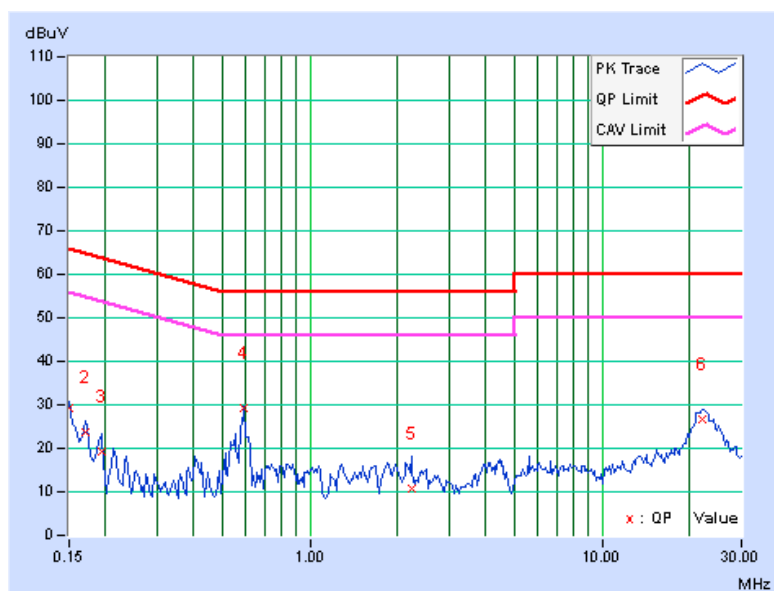



A D T

PHASE	Neutral (N)	DETECTOR FUNCTION	Quasi-Peak (QP) / Average (AV)
--------------	-------------	--------------------------	--------------------------------

No	Freq. [MHz]	Corr. Factor (dB)	Reading Value [dB (uV)]		Emission Level [dB (uV)]		Limit [dB (uV)]		Margin (dB)	
			Q.P.	AV.	Q.P.	AV.	Q.P.	AV.	Q.P.	AV.
1	0.15000	0.08	28.32	26.10	28.40	26.18	66.00	56.00	-37.60	-29.82
2	0.16562	0.07	30.00	29.90	30.07	29.97	65.18	55.18	-35.10	-25.20
3	0.18516	0.07	26.48	25.56	26.55	25.63	64.25	54.25	-37.70	-28.62
4	0.59922	0.10	29.24	28.75	29.34	28.85	56.00	46.00	-26.66	-17.15
5	3.81250	0.25	11.05	2.91	11.30	3.16	56.00	46.00	-44.70	-42.84
6	22.48828	0.77	27.52	23.43	28.29	24.20	60.00	50.00	-31.71	-25.80

REMARKS:

1. Q.P. and AV. are abbreviations of quasi-peak and average individually.
2. The emission levels of other frequencies were very low against the limit.
3. Margin value = Emission Level – Limit value
4. Correction Factor = Insertion loss + Cable loss
5. Emission Level = Correction Factor + Reading Value

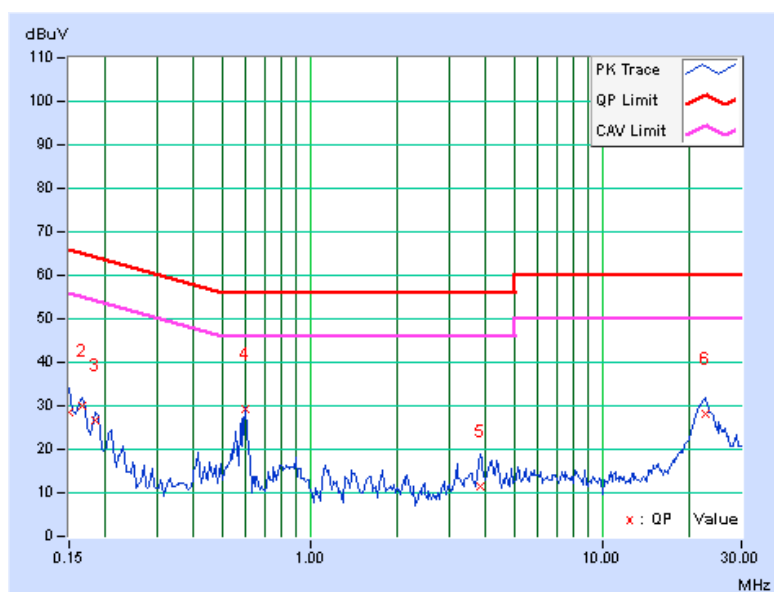

5.2 RADIATED EMISSION AND BANDEDGE MEASUREMENT

5.2.1 LIMITS OF RADIATED EMISSION AND BANDEDGE MEASUREMENT

Radiated emissions which fall in the restricted bands must comply with the radiated emission limits specified as below table. Other emissions shall be at least 20dB below the highest level of the desired power:

Frequencies (MHz)	Field strength (microvolts/meter)	Measurement distance (meters)
0.009-0.490	2400/F(kHz)	300
0.490-1.705	24000/F(kHz)	30
1.705-30.0	30	30
30-88	100	3
88-216	150	3
216-960	200	3
Above 960	500	3

NOTE:

1. The lower limit shall apply at the transition frequencies.
2. Emission level (dBuV/m) = 20 log Emission level (uV/m).
3. For frequencies above 1000MHz, the field strength limits are based on average detector, however, the peak field strength of any emission shall not exceed the maximum permitted average limits, specified above by more than 20dB under any condition of modulation.



A D T

5.2.2 TEST INSTRUMENTS

For Below 1GHz:

DESCRIPTION & MANUFACTURER	MODEL NO.	SERIAL NO.	CALIBRATED DATE	CALIBRATED UNTIL
MXE EMI Receiver Agilent	N9038A	MY51210105	Jan. 21,2014	Jan. 20,2015
Pre-Amplifier Mini-Circuits	ZFL-1000VH2 B	AMP-ZFL-03	Nov. 13, 2013	Nov. 12, 2014
Trilog Broadband Antenna SCHWARZBECK	VULB 9168	9168-360	Feb. 26, 2014	Feb. 25, 2015
RF Cable	NA	CHGCAB_001	Oct. 05, 2013	Oct. 04, 2014
Spectrum Analyzer R&S	FSV40	100964	July 15, 2013	July 14, 2014
Horn_Antenna AISI	AIH.8018	0000320091110	Nov. 18, 2013	Nov. 17, 2014
Pre-Amplifier Agilent	8449B	3008A02578	June 24, 2014	June 23, 2015
RF Cable	NA	RF104-201 RF104-203 RF104-204	Dec. 12, 2013	Dec. 11, 2014
Spectrum Analyzer Agilent	E4446A	MY48250253	Aug. 28, 2013	Aug. 27, 2014
Pre-Amplifier SPACEK LABS	SLKKa-48-6	9K16	Nov. 13, 2013	Nov. 12, 2014
Horn_Antenna SCHWARZBECK	BBHA 9170	9170-424	Oct. 08, 2013	Oct. 07, 2014
Software	ADT_Radiated _V8.7.07	NA	NA	NA
Antenna Tower & Turn Table CT	NA	NA	NA	NA

Note:

1. The calibration interval of the above test instruments is 12 months and the calibrations are traceable to NML/ROC and NIST/USA.
2. The horn antenna, preamplifier (model: 8449B) are used only for the measurement of emission frequency above 1GHz if tested.
- 3 The test was performed in 966 Chamber No. G.
4. The FCC Site Registration No. is 966073.
- 5 The VCCI Site Registration No. is G-137.
- 6 The CANADA Site Registration No. is IC 7450H-2.
- 7 Tested Date: July 01, 2014



A D T

For Above 1GHz:

DESCRIPTION & MANUFACTURER	MODEL NO.	SERIAL NO.	CALIBRATED DATE	CALIBRATED UNTIL
MXE EMI Receiver Agilent	N9038A	MY50010156	Jan. 15, 2014	Jan. 14, 2015
Pre-Amplifier Mini-Circuits	ZFL-1000VH2 B	AMP-ZFL-04	Nov. 13, 2013	Nov. 12, 2014
Trilog Broadband Antenna SCHWARZBECK	VULB 9168	9168-361	Feb. 27, 2014	Feb. 26, 2015
RF Cable	NA	CHHCAB_001	Oct. 06, 2013	Oct. 05, 2014
Spectrum Analyzer R&S	FSV40	100964	July 15, 2013	July 14, 2014
Horn_Antenna AISl	AIH.8018	0000220091110	Dec. 06, 2013	Dec. 05, 2014
Pre-Amplifier Agilent	8449B	3008A01923	Oct. 29, 2013	Oct. 28, 2014
RF Cable	NA	RF104-205 RF104-207 RF104-202	Dec. 12, 2013	Dec. 11, 2014
Spectrum Analyzer Agilent	E4446A	MY48250253	Aug. 28, 2013	Aug. 27, 2014
Pre-Amplifier SPACEK LABS	SLKKa-48-6	9K16	Nov. 13, 2013	Nov. 12, 2014
Horn_Antenna SCHWARZBECK	BBHA 9170	9170-424	Oct. 08, 2013	Oct. 07, 2014
Software	ADT_Radiated _V8.7.07	NA	NA	NA
Antenna Tower & Turn Table CT	NA	NA	NA	NA

Note:

1. The calibration interval of the above test instruments is 12 months and the calibrations are traceable to NML/ROC and NIST/USA.
2. The horn antenna, preamplifier (model: 8449B) are used only for the measurement of emission frequency above 1GHz if tested.
3. The test was performed in 966 Chamber No. H.
4. The FCC Site Registration No. is 797305.
5. The CANADA Site Registration No. is IC 7450H-3.
6. Tested Date: June 10, 2014

5.2.3 TEST PROCEDURES

- a. The EUT was placed on the top of a rotating table 0.8 meters above the ground at 3 meter chamber room for test. The table was rotated 360 degrees to determine the position of the highest radiation.
- b. The EUT was set 3 meters away from the interference-receiving antenna, which was mounted on the top of a variable-height antenna tower.
- c. The height of antenna is varied from one meter to four meters above the ground to determine the maximum value of the field strength. Both horizontal and vertical polarizations of the antenna are set to make the measurement.
- d. For each suspected emission, the EUT was arranged to its worst case and then the antenna was tuned to heights from 1 meter to 4 meters and the rotatable table was turned from 0 degrees to 360 degrees to find the maximum reading.
- e. The test-receiver system was set to quasi-peak detect function and specified bandwidth with maximum hold mode when the test frequency is below 1 GHz.
- f. The test-receiver system was set to peak and average detect function and specified bandwidth with maximum hold mode when the test frequency is above 1 GHz. If the peak reading value also meets average limit, measurement with the average detector is unnecessary.

Note:

1. The resolution bandwidth and video bandwidth of test receiver/spectrum analyzer is 120kHz for Quasi-peak detection (QP) at frequency below 1GHz.
2. The resolution bandwidth of test receiver/spectrum analyzer is 1 MHz and the video bandwidth is 3 MHz for Peak detection (PK) at frequency above 1GHz.
3. The resolution bandwidth of test receiver/spectrum analyzer is 1MHz and the video bandwidth is $\geq 1/T$ (Duty cycle < 98%) or 10Hz (Duty cycle $\geq 98\%$) for Average detection (AV) at frequency above 1GHz.
4. All modes of operation were investigated and the worst-case emissions are reported.

5.2.4 DEVIATION FROM TEST STANDARD

No deviation

5.2.5 TEST SETUP

<Frequency Range below 1GHz>

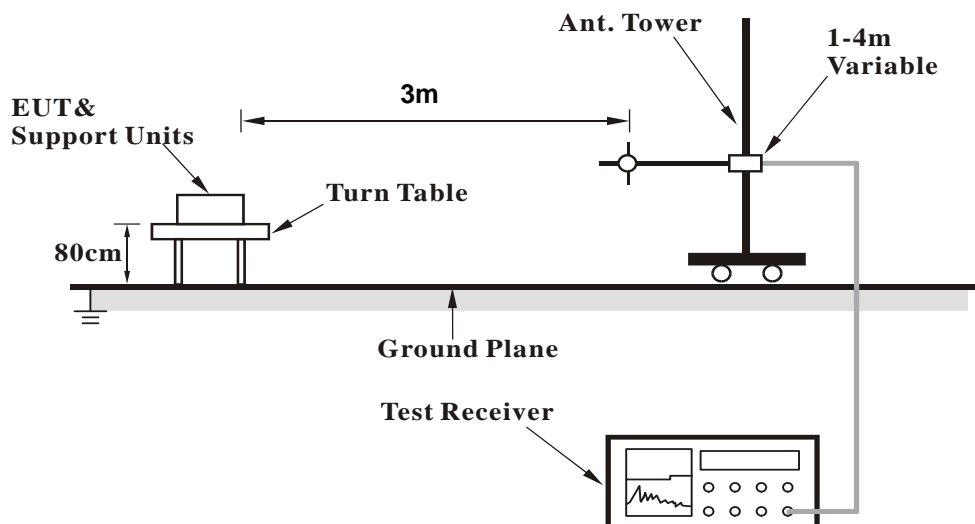

<Frequency Range above 1GHz>

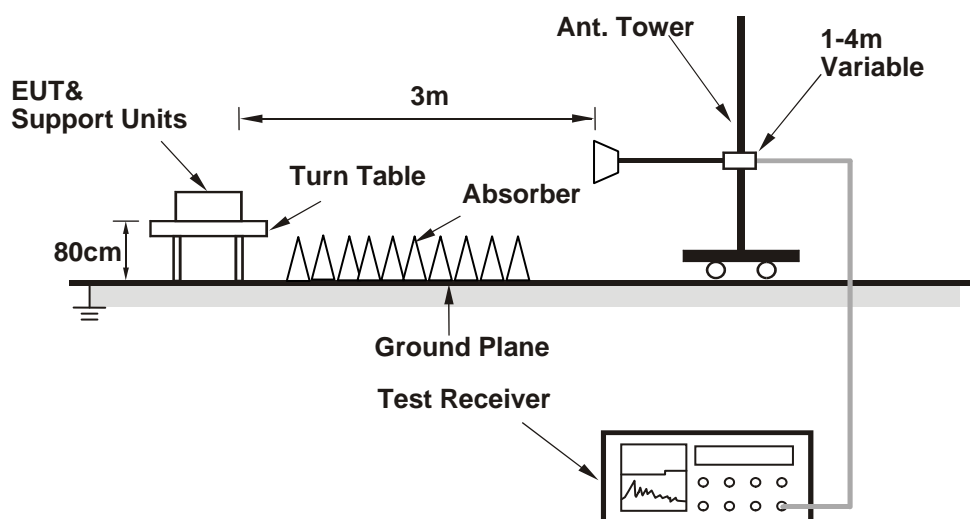

For the actual test configuration, please refer to the related item – Photographs of the Test Configuration.

5.2.6 EUT OPERATING CONDITIONS

Same as 4.1.6

5.2.7 TEST RESULTS

BELOW 1GHz WORST-CASE DATA

BT_LE-GFSK

CHANNEL	TX Channel 0	DETECTOR FUNCTION	Quasi-Peak (QP)
FREQUENCY RANGE	30MHz ~ 1GHz		

ANTENNA POLARITY & TEST DISTANCE: HORIZONTAL AT 3 M								
NO.	FREQ. (MHz)	EMISSION LEVEL (dBuV/m)	LIMIT (dBuV/m)	MARGIN (dB)	ANTENNA HEIGHT (m)	TABLE ANGLE (Degree)	RAW VALUE (dBuV)	CORRECTION FACTOR (dB/m)
1	435.67	29.3 QP	46.0	-16.7	1.72 H	195	37.78	-8.51
2	485.40	27.1 QP	46.0	-18.9	1.52 H	171	34.70	-7.64
3	588.09	29.5 QP	46.0	-16.5	1.43 H	339	34.83	-5.33
4	613.81	29.6 QP	46.0	-16.5	1.53 H	82	34.01	-4.46
5	691.33	30.5 QP	46.0	-15.5	1.29 H	206	34.10	-3.64
6	716.67	28.1 QP	46.0	-17.9	1.18 H	158	31.40	-3.31
ANTENNA POLARITY & TEST DISTANCE: VERTICAL AT 3 M								
NO.	FREQ. (MHz)	EMISSION LEVEL (dBuV/m)	LIMIT (dBuV/m)	MARGIN (dB)	ANTENNA HEIGHT (m)	TABLE ANGLE (Degree)	RAW VALUE (dBuV)	CORRECTION FACTOR (dB/m)
1	435.07	26.9 QP	46.0	-19.1	1.50 V	154	35.39	-8.53
2	486.20	28.9 QP	46.0	-17.1	1.29 V	209	36.50	-7.63
3	589.58	28.8 QP	46.0	-17.2	1.01 V	198	34.12	-5.28
4	613.45	27.8 QP	46.0	-18.2	1.73 V	165	32.28	-4.46
5	690.88	27.2 QP	46.0	-18.8	1.41 V	234	30.85	-3.63
6	940.41	28.3 QP	46.0	-17.7	1.47 V	112	27.44	0.85

REMARKS:

1. Emission Level(dBuV/m) = Raw Value(dBuV) + Correction Factor(dB/m)
2. Correction Factor(dB/m) = Antenna Factor(dB/m) + Cable Factor(dB) – Pre-Amplifier Factor(dB)
3. The other emission levels were very low against the limit.
4. Margin value = Emission Level – Limit value



A D T

CHANNEL	TX Channel 19	DETECTOR FUNCTION	Quasi-Peak (QP)
FREQUENCY RANGE	30MHz ~ 1GHz		

ANTENNA POLARITY & TEST DISTANCE: HORIZONTAL AT 3 M								
NO.	FREQ. (MHz)	EMISSION LEVEL (dBuV/m)	LIMIT (dBuV/m)	MARGIN (dB)	ANTENNA HEIGHT (m)	TABLE ANGLE (Degree)	RAW VALUE (dBuV)	CORRECTION FACTOR (dB/m)
1	434.86	28.6 QP	46.0	-17.4	1.70 H	201	37.14	-8.52
2	486.03	27.6 QP	46.0	-18.4	1.50 H	152	35.21	-7.64
3	587.13	29.2 QP	46.0	-16.8	1.43 H	319	34.54	-5.37
4	613.15	29.2 QP	46.0	-16.8	1.47 H	88	33.65	-4.46
5	692.14	31.3 QP	46.0	-14.7	1.25 H	208	34.94	-3.62
6	715.53	27.1 QP	46.0	-18.9	1.19 H	138	30.44	-3.33

ANTENNA POLARITY & TEST DISTANCE: VERTICAL AT 3 M								
NO.	FREQ. (MHz)	EMISSION LEVEL (dBuV/m)	LIMIT (dBuV/m)	MARGIN (dB)	ANTENNA HEIGHT (m)	TABLE ANGLE (Degree)	RAW VALUE (dBuV)	CORRECTION FACTOR (dB/m)
1	434.90	27.8 QP	46.0	-18.2	1.48 V	150	36.29	-8.52
2	486.43	29.2 QP	46.0	-16.8	1.30 V	204	36.79	-7.62
3	588.12	27.7 QP	46.0	-18.3	1.10 V	186	33.03	-5.33
4	614.89	28.7 QP	46.0	-17.3	1.67 V	159	33.15	-4.45
5	690.74	27.4 QP	46.0	-18.6	1.47 V	234	30.99	-3.63
6	939.84	28.4 QP	46.0	-17.6	1.48 V	111	27.53	0.84

REMARKS:

1. Emission Level(dBuV/m) = Raw Value(dBuV) + Correction Factor(dB/m)
2. Correction Factor(dB/m) = Antenna Factor(dB/m) + Cable Factor(dB) – Pre-Amplifier Factor(dB)
3. The other emission levels were very low against the limit.
4. Margin value = Emission Level – Limit value



A D T

CHANNEL	TX Channel 39	DETECTOR FUNCTION	Quasi-Peak (QP)
FREQUENCY RANGE	30MHz ~ 1GHz		

ANTENNA POLARITY & TEST DISTANCE: HORIZONTAL AT 3 M								
NO.	FREQ. (MHz)	EMISSION LEVEL (dBuV/m)	LIMIT (dBuV/m)	MARGIN (dB)	ANTENNA HEIGHT (m)	TABLE ANGLE (Degree)	RAW VALUE (dBuV)	CORRECTION FACTOR (dB/m)
1	434.65	28.9 QP	46.0	-17.1	1.69 H	196	37.46	-8.53
2	485.56	27.3 QP	46.0	-18.7	1.46 H	171	34.97	-7.64
3	588.06	29.8 QP	46.0	-16.2	1.41 H	334	35.14	-5.33
4	611.93	27.6 QP	46.0	-18.4	1.49 H	68	32.03	-4.47
5	690.66	30.0 QP	46.0	-16.0	1.26 H	203	33.65	-3.63
6	716.20	27.3 QP	46.0	-18.7	1.13 H	109	30.65	-3.31

ANTENNA POLARITY & TEST DISTANCE: VERTICAL AT 3 M								
NO.	FREQ. (MHz)	EMISSION LEVEL (dBuV/m)	LIMIT (dBuV/m)	MARGIN (dB)	ANTENNA HEIGHT (m)	TABLE ANGLE (Degree)	RAW VALUE (dBuV)	CORRECTION FACTOR (dB/m)
1	434.64	27.2 QP	46.0	-18.9	1.47 V	174	35.68	-8.53
2	485.70	28.3 QP	46.0	-17.7	1.29 V	209	35.93	-7.64
3	588.64	28.3 QP	46.0	-17.7	1.04 V	195	33.57	-5.31
4	614.71	28.9 QP	46.0	-17.1	1.68 V	157	33.31	-4.45
5	690.71	27.0 QP	46.0	-19.0	1.43 V	223	30.67	-3.63
6	940.28	28.2 QP	46.0	-17.8	1.48 V	126	27.37	0.85

REMARKS:

1. Emission Level(dBuV/m) = Raw Value(dBuV) + Correction Factor(dB/m)
2. Correction Factor(dB/m) = Antenna Factor(dB/m) + Cable Factor(dB) – Pre-Amplifier Factor(dB)
3. The other emission levels were very low against the limit.
4. Margin value = Emission Level – Limit value



A D T

ABOVE 1GHz WORST-CASE DATA

BT_LE-GFSK

CHANNEL	TX Channel 0	DETECTOR FUNCTION	Peak (PK)
FREQUENCY RANGE	1GHz ~ 25GHz		Average (AV)

ANTENNA POLARITY & TEST DISTANCE: HORIZONTAL AT 3 M

NO.	FREQ. (MHz)	EMISSION LEVEL (dBuV/m)	LIMIT (dBuV/m)	MARGIN (dB)	ANTENNA HEIGHT (m)	TABLE ANGLE (Degree)	RAW VALUE (dBuV)	CORRECTION FACTOR (dB/m)
1	2390.00	50.7 PK	74.0	-23.3	1.40 H	139	56.30	-5.60
2	2390.00	36.5 AV	54.0	-17.5	1.40 H	139	42.10	-5.60
3	*2402.00	98.7 PK			1.40 H	139	104.29	-5.59
4	*2402.00	97.2 AV			1.40 H	139	102.79	-5.59
5	4804.00	45.0 PK	74.0	-29.0	1.44 H	333	41.11	3.89
6	4804.00	34.2 AV	54.0	-19.8	1.44 H	333	30.31	3.89

ANTENNA POLARITY & TEST DISTANCE: VERTICAL AT 3 M

NO.	FREQ. (MHz)	EMISSION LEVEL (dBuV/m)	LIMIT (dBuV/m)	MARGIN (dB)	ANTENNA HEIGHT (m)	TABLE ANGLE (Degree)	RAW VALUE (dBuV)	CORRECTION FACTOR (dB/m)
1	2390.00	52.0 PK	74.0	-22.0	1.30 V	188	57.60	-5.60
2	2390.00	36.9 AV	54.0	-17.1	1.30 V	188	42.50	-5.60
3	*2402.00	98.4 PK			1.30 V	188	103.99	-5.59
4	*2402.00	97.4 AV			1.30 V	188	102.99	-5.59
5	4804.00	44.9 PK	74.0	-29.1	1.31 V	182	41.01	3.89
6	4804.00	33.9 AV	54.0	-20.1	1.31 V	182	30.01	3.89

REMARKS:

1. Emission Level(dBuV/m) = Raw Value(dBuV) + Correction Factor(dB/m)
2. Correction Factor(dB/m) = Antenna Factor(dB/m) + Cable Factor(dB) – Pre-Amplifier Factor(dB)
3. The other emission levels were very low against the limit.
4. Margin value = Emission Level – Limit value
5. " * ": Fundamental frequency.



A D T

CHANNEL	TX Channel 19	DETECTOR FUNCTION	Peak (PK)
FREQUENCY RANGE	1GHz ~ 25GHz		Average (AV)

ANTENNA POLARITY & TEST DISTANCE: HORIZONTAL AT 3 M								
NO.	FREQ. (MHz)	EMISSION LEVEL (dBuV/m)	LIMIT (dBuV/m)	MARGIN (dB)	ANTENNA HEIGHT (m)	TABLE ANGLE (Degree)	RAW VALUE (dBuV)	CORRECTION FACTOR (dB/m)
1	*2440.00	98.5 PK			1.34 H	146	103.91	-5.41
2	*2440.00	96.9 AV			1.34 H	146	102.31	-5.41
3	4880.00	45.4 PK	74.0	-28.6	1.41 H	324	41.60	3.80
4	4880.00	34.6 AV	54.0	-19.4	1.41 H	324	30.80	3.80
5	7320.00	51.6 PK	74.0	-22.4	1.08 H	163	43.33	8.27
6	7320.00	39.3 AV	54.0	-14.7	1.08 H	163	31.03	8.27

ANTENNA POLARITY & TEST DISTANCE: VERTICAL AT 3 M								
NO.	FREQ. (MHz)	EMISSION LEVEL (dBuV/m)	LIMIT (dBuV/m)	MARGIN (dB)	ANTENNA HEIGHT (m)	TABLE ANGLE (Degree)	RAW VALUE (dBuV)	CORRECTION FACTOR (dB/m)
1	*2440.00	99.1 PK			1.29 V	187	104.51	-5.41
2	*2440.00	97.9 AV			1.29 V	187	103.31	-5.41
3	4880.00	45.0 PK	74.0	-29.0	1.25 V	168	41.20	3.80
4	4880.00	34.1 AV	54.0	-19.9	1.25 V	168	30.30	3.80
5	7320.00	51.4 PK	74.0	-22.6	1.41 V	321	43.13	8.27
6	7320.00	38.9 AV	54.0	-15.1	1.41 V	321	30.63	8.27

REMARKS:

1. Emission Level(dBuV/m) = Raw Value(dBuV) + Correction Factor(dB/m)
2. Correction Factor(dB/m) = Antenna Factor(dB/m) + Cable Factor(dB) – Pre-Amplifier Factor(dB)
3. The other emission levels were very low against the limit.
4. Margin value = Emission Level – Limit value
5. " * ": Fundamental frequency.



A D T

CHANNEL	TX Channel 39	DETECTOR FUNCTION	Peak (PK)
FREQUENCY RANGE	1GHz ~ 25GHz		Average (AV)

ANTENNA POLARITY & TEST DISTANCE: HORIZONTAL AT 3 M

NO.	FREQ. (MHz)	EMISSION LEVEL (dBuV/m)	LIMIT (dBuV/m)	MARGIN (dB)	ANTENNA HEIGHT (m)	TABLE ANGLE (Degree)	RAW VALUE (dBuV)	CORRECTION FACTOR (dB/m)
1	*2480.00	98.2 PK			1.34 H	148	103.43	-5.23
2	*2480.00	96.8 AV			1.34 H	148	102.03	-5.23
3	2483.50	53.3 PK	74.0	-20.7	1.34 H	148	58.50	-5.20
4	2483.50	37.5 AV	54.0	-16.5	1.34 H	148	42.70	-5.20
5	4960.00	44.9 PK	74.0	-29.1	1.40 H	325	41.07	3.83
6	4960.00	34.4 AV	54.0	-19.6	1.40 H	325	30.57	3.83
7	7440.00	51.7 PK	74.0	-22.3	1.03 H	166	43.02	8.68
8	7440.00	39.6 AV	54.0	-14.4	1.03 H	166	30.92	8.68

ANTENNA POLARITY & TEST DISTANCE: VERTICAL AT 3 M

NO.	FREQ. (MHz)	EMISSION LEVEL (dBuV/m)	LIMIT (dBuV/m)	MARGIN (dB)	ANTENNA HEIGHT (m)	TABLE ANGLE (Degree)	RAW VALUE (dBuV)	CORRECTION FACTOR (dB/m)
1	*2480.00	98.7 PK			1.32 V	183	103.93	-5.23
2	*2480.00	97.5 AV			1.32 V	183	102.73	-5.23
3	2483.50	53.1 PK	74.0	-20.9	1.32 V	183	58.30	-5.20
4	2483.50	37.1 AV	54.0	-16.9	1.32 V	183	42.30	-5.20
5	4960.00	45.1 PK	74.0	-28.9	1.31 V	156	41.27	3.83
6	4960.00	34.0 AV	54.0	-20.0	1.31 V	156	30.17	3.83
7	7440.00	51.2 PK	74.0	-22.8	1.44 V	306	42.52	8.68
8	7440.00	38.5 AV	54.0	-15.5	1.44 V	306	29.82	8.68

REMARKS:

1. Emission Level(dBuV/m) = Raw Value(dBuV) + Correction Factor(dB/m)
2. Correction Factor(dB/m) = Antenna Factor(dB/m) + Cable Factor(dB) – Pre-Amplifier Factor(dB)
3. The other emission levels were very low against the limit.
4. Margin value = Emission Level – Limit value
5. " * ": Fundamental frequency.

5.3 6dB BANDWIDTH MEASUREMENT

5.3.1 LIMITS OF 6dB BANDWIDTH MEASUREMENT

The minimum of 6dB Bandwidth Measurement is 0.5 MHz.

5.3.2 TEST INSTRUMENTS

DESCRIPTION & MANUFACTURER	MODEL NO.	SERIAL NO.	CALIBRATED DATE	CALIBRATED UNTIL
SPECTRUM ANALYZER R&S	FSV 40	100964	July 15, 2013	July 14, 2014

Note:

1. The calibration interval of the above test instruments is 12 months and the calibrations are traceable to NML/ROC and NIST/USA.
2. Tested date : June 30, 2014

5.3.3 TEST PROCEDURE

1. Set resolution bandwidth (RBW) = 100kHz.
2. Set the video bandwidth (VBW) $\geq 3 \times$ RBW, Detector = Peak.
3. Trace mode = max hold.
4. Sweep = auto couple.
5. Measure the maximum width of the emission that is constrained by the frequencies associated with the two amplitude points (upper and lower) that are attenuated by 6 dB relative to the maximum level measured in the fundamental emission

5.3.4 DEVIATION FROM TEST STANDARD

No deviation

5.3.5 TEST SETUP

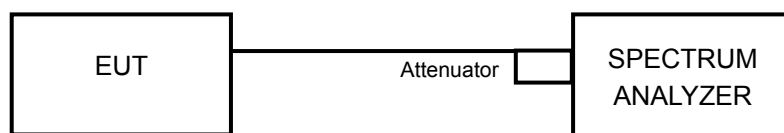

5.3.6 EUT OPERATING CONDITIONS

The software provided by client to enable the EUT under transmission condition continuously at lowest, middle and highest channel frequencies individually.



A D T

5.3.7 TEST RESULTS

CHANNEL	FREQUENCY (MHz)	6dB BANDWIDTH (MHz)	MINIMUM LIMIT (MHz)	PASS / FAIL
0	2402	0.67	0.5	PASS
19	2440	0.67	0.5	PASS
39	2480	0.67	0.5	PASS

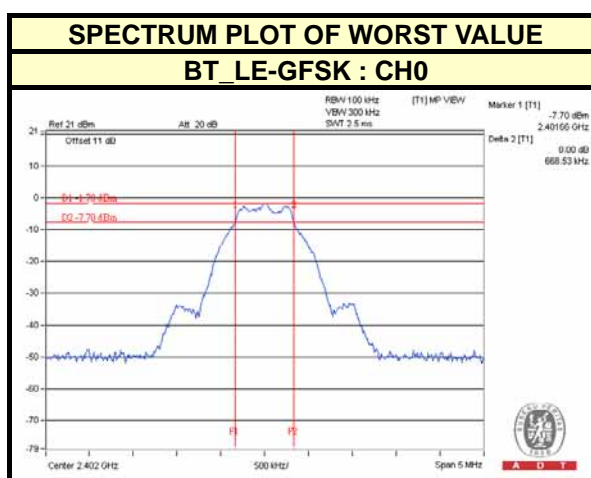

5.4 CONDUCTED OUTPUT POWER MEASUREMENT

5.4.1 LIMITS OF CONDUCTED OUTPUT POWER MEASUREMENT

For systems using digital modulation in the 2400–2483.5 MHz bands: 1 Watt (30dBm)

5.4.2 TEST INSTRUMENTS

DESCRIPTION & MANUFACTURER	MODEL NO.	SERIAL NO.	CALIBRATED DATE	CALIBRATED UNTIL
Power meter Anritsu	ML2495A	1014008	Apr. 30, 2014	Apr. 29, 2015
Power sensor Anritsu	MA2411B	0917122	Apr. 30, 2014	Apr. 29, 2015

Note:

1. The calibration interval of the above test instruments is 12 months and the calibrations are traceable to NML/ROC and NIST/USA.
2. Tested date : June 30, 2014

5.4.3 TEST PROCEDURES

The peak / average power sensor was used on the output port of the EUT. A power meter was used to read the response of the peak / average power sensor. Record the peak power level.

5.4.4 DEVIATION FROM TEST STANDARD

No deviation.

5.4.5 TEST SETUP

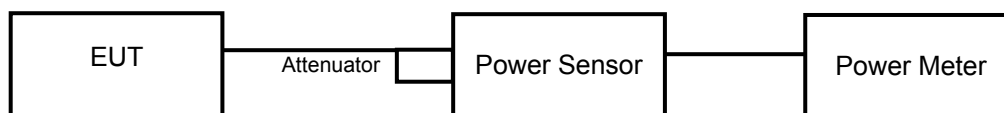

5.4.6 EUT OPERATING CONDITIONS

Same as Item 4.3.6



A D T

5.4.7 TEST RESULTS

FOR PEAK POWER

BT_LE-GFSK

CHANNEL	FREQUENCY (MHz)	PEAK POWER (mW)	PEAK POWER (dBm)	LIMIT (dBm)	PASS/FAIL
0	2402	0.9183	-0.37	30	PASS
19	2440	1.052	0.22	30	PASS
39	2480	1.084	0.35	30	PASS

FOR AVERAGE POWER

BT_LE-GFSK

CHANNEL	FREQUENCY (MHz)	AVERAGE POWER (mW)	AVERAGE POWER (dBm)
0	2402	0.635	-1.97
19	2440	0.719	-1.43
39	2480	0.755	-1.22

5.5 POWER SPECTRAL DENSITY MEASUREMENT

5.5.1 LIMITS OF POWER SPECTRAL DENSITY MEASUREMENT

The Maximum of Power Spectral Density Measurement is 8dBm.

5.5.2 TEST INSTRUMENTS

DESCRIPTION & MANUFACTURER	MODEL NO.	SERIAL NO.	CALIBRATED DATE	CALIBRATED UNTIL
SPECTRUM ANALYZER R&S	FSV 40	100964	July 15, 2013	July 14, 2014

Note:

1. The calibration interval of the above test instruments is 12 months and the calibrations are traceable to NML/ROC and NIST/USA.
2. Tested date : June 30, 2014

5.5.3 TEST PROCEDURE

1. Set the RBW = 3 kHz, VBW =10 kHz, Detector = peak.
2. Sweep time = auto couple, Trace mode = max hold, allow trace to fully stabilize.
3. Use the peak marker function to determine the maximum amplitude level.

5.5.4 DEVIATION FROM TEST STANDARD

No deviation

5.5.5 TEST SETUP

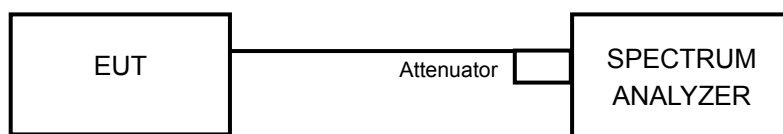

5.5.6 EUT OPERATING CONDITION

Same as Item 4.3.6



A D T

5.5.7 TEST RESULTS

BT_LE-GFSK

Channel	FREQUENCY (MHz)	PSD (dBm)	LIMIT (dBm)	PASS /FAIL
0	2402	-17.02	8	PASS
19	2440	-16.69	8	PASS
39	2480	-16.21	8	PASS

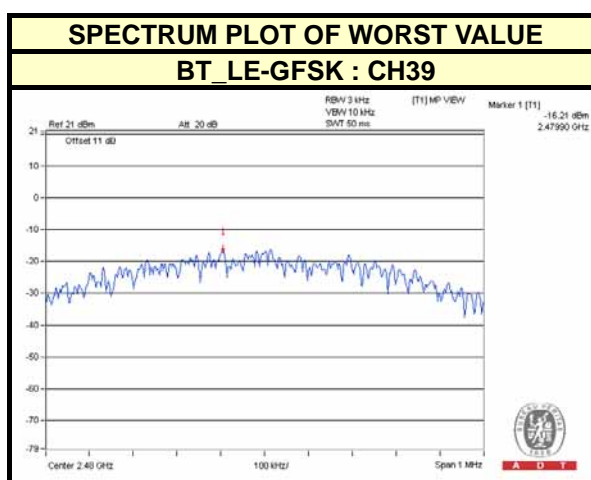



5.6 CONDUCTED OUT-BAND EMISSION MEASUREMENT

5.6.1 LIMITS OF CONDUCTED OUT-BAND EMISSION MEASUREMENT

Below 20dB of the highest emission level of operating band (in 100kHz Resolution Bandwidth).

5.6.2 TEST INSTRUMENTS

DESCRIPTION & MANUFACTURER	MODEL NO.	SERIAL NO.	CALIBRATED DATE	CALIBRATED UNTIL
SPECTRUM ANALYZER R&S	FSV 40	100964	July 15, 2013	July 14, 2014

Note:

1. The calibration interval of the above test instruments is 12 months and the calibrations are traceable to NML/ROC and NIST/USA.
2. Tested date : June 30, 2014

5.6.3 TEST PROCEDURE

Measurement Procedure - Reference Level

1. Set the RBW = 100 kHz.
2. Set the VBW \geq 300 kHz.
3. Detector = peak.
4. Sweep time = auto couple.
5. Trace mode = max hold.
6. Allow trace to fully stabilize.
7. Use the peak marker function to determine the maximum power level in any 100 kHz band segment within the fundamental EBW.

Measurement Procedure –Unwanted Emission Level

1. Set RBW = 100 kHz.
2. Set VBW \geq 300 kHz.
3. Detector = peak.
4. Sweep = auto couple.
5. Trace Mode = max hold.
6. Allow trace to fully stabilize.
7. Use the peak marker function to determine the maximum amplitude level.

5.6.4 DEVIATION FROM TEST STANDARD

No deviation

5.6.5 TEST SETUP

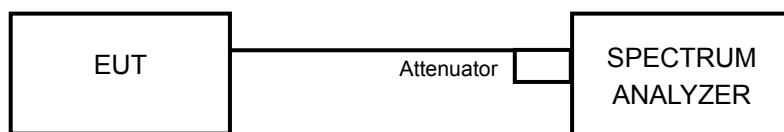

5.6.6 EUT OPERATING CONDITION

Same as Item 4.3.6

5.6.7 TEST RESULTS

The spectrum plots are attached on the following pages. D1 line indicates the highest level, and D2 line indicates the 20dB offset below D1. It shows compliance with the requirement.



A D T

BT LE-GFSK

CH 0

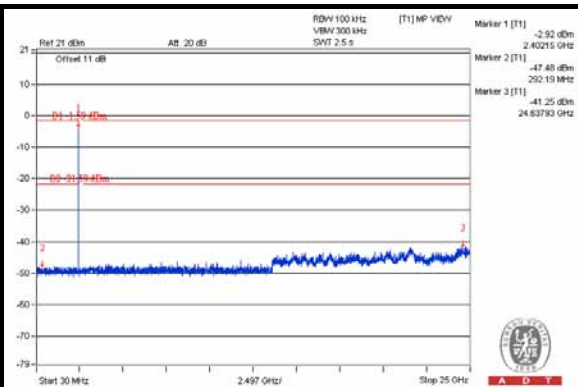
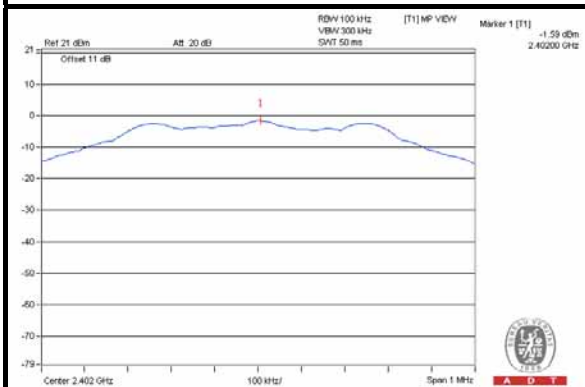

CH 19

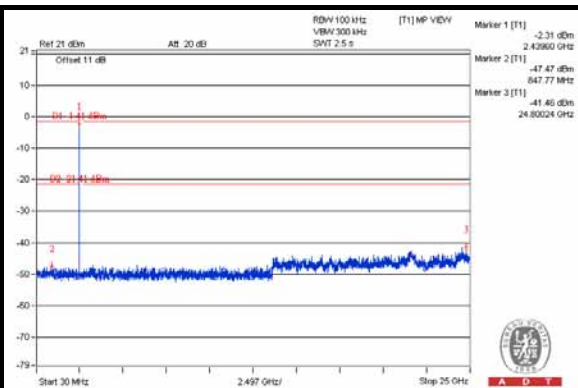
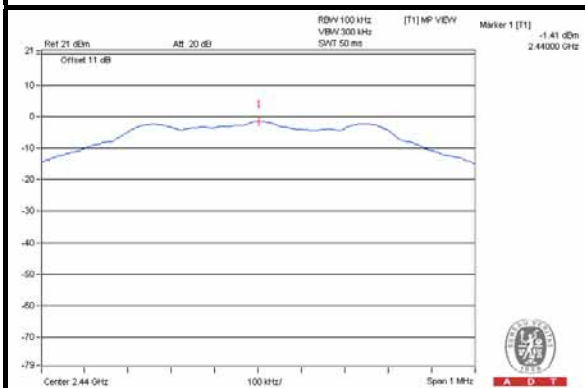

CH 39

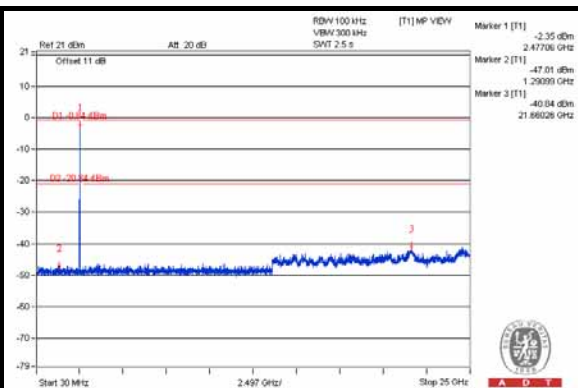
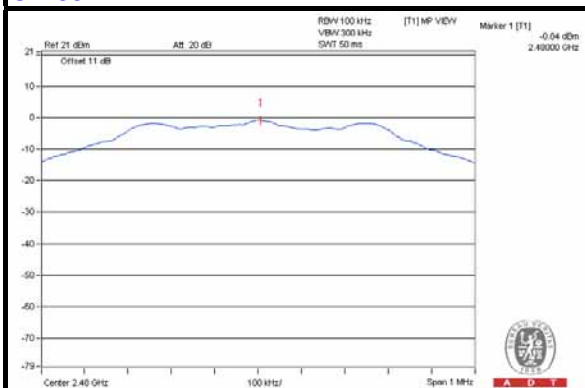

CH 0 Band edge

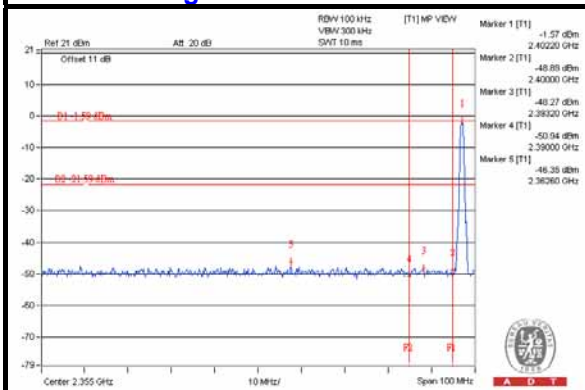

CH 39 Band edge

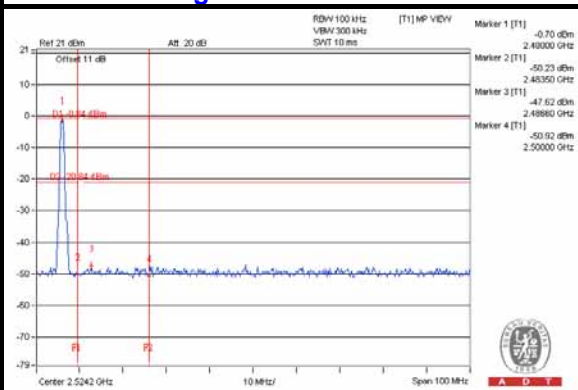



A D T

6 PHOTOGRAPHS OF THE TEST CONFIGURATION

Please refer to the attached file (Test Setup Photo).



7 INFORMATION ON THE TESTING LABORATORIES

We, Bureau Veritas Consumer Products Services (H.K.) Ltd., Taoyuan Branch, were founded in 1988 to provide our best service in EMC, Radio, Telecom and Safety consultation. Our laboratories are accredited and approved according to ISO/IEC 17025.

If you have any comments, please feel free to contact us at the following:

Linko EMC/RF Lab:

Tel: 886-2-26052180

Fax: 886-2-26052943

Hsin Chu EMC/RF Lab:

Tel: 886-3-5935343

Fax: 886-3-5935342

Hwa Ya EMC/RF/Safety/Telecom Lab:

Tel: 886-3-3183232

Fax: 886-3-3270892

Email: service.adt@tw.bureauveritas.com

Web Site: www.bureauveritas-adt.com

The address and road map of all our labs can be found in our web site also.



8 APPENDIX A - MODIFICATIONS RECORDERS FOR ENGINEERING CHANGES TO THE EUT BY THE LAB

No modifications were made to the EUT by the lab during the test.

--- END ---