



FCC TEST REPORT (15.407)

REPORT NO.: RF960622H02F-1

MODEL NO.: LA-5137C2

FCC ID: H9PLA5137C2

RECEIVED: June 01, 2010

TESTED: July 24 to 26, 2010

ISSUED: Sep. 15, 2010

APPLICANT: Symbol Technologies Inc.

ADDRESS: One Symbol Plaza, Holtsville, NY 11742-1300 U.S.A.

ISSUED BY : Bureau Veritas Consumer Products Services (H.K.) Ltd., Taoyuan Branch Hsin Chu Laboratory

LAB ADDRESS : No. 81-1, Lu Liao Keng, 9th Ling, Wu Lung Tsuen, Chiung Lin Hsiang, Hsin Chu Hsien 307, Taiwan

This test report consists of 38 pages in total. It may be duplicated completely for legal use with the approval of the applicant. It should not be reproduced except in full, without the written approval of our laboratory. The client should not use it to claim product endorsement by TAF or any government agencies. The test results in the report only apply to the tested sample.





A D T

Table of Contents

1.	CERTIFICATION	3
2.	SUMMARY OF TEST RESULTS	4
2.1	MEASUREMENT UNCERTAINTY.....	5
3.	GENERAL INFORMATION.....	6
3.1	GENERAL DESCRIPTION OF EUT	6
3.2	DESCRIPTION OF TEST MODES	8
3.2.1	TEST MODE APPLICABILITY AND TESTED CHANNEL DETAIL:	9
3.3	GENERAL DESCRIPTION OF APPLIED STANDARDS	11
3.4	DESCRIPTION OF SUPPORT UNITS.....	12
3.5	CONFIGURATION OF SYSTEM UNDER TEST	12
4.	TEST TYPES AND RESULTS	13
4.1	RADIATED EMISSION MEASUREMENT	13
4.1.1	LIMITS OF RADIATED EMISSION MEASUREMENT.....	13
4.1.2	LIMITS OF UNWANTED EMISSION OUT OF THE RESTRICTED BANDS.....	14
4.1.3	TEST INSTRUMENTS	15
4.1.4	TEST PROCEDURES.....	16
4.1.5	DEVIATION FROM TEST STANDARD	16
4.1.6	TEST SETUP	17
4.1.7	EUT OPERATING CONDITION.....	17
4.1.8	TEST RESULTS	18
4.2	PEAK TRANSMIT POWER MEASUREMENT.....	32
4.2.1	LIMITS OF PEAK TRANSMIT POWER MEASUREMENT	32
4.2.2	TEST INSTRUMENTS	32
4.2.3	TEST PROCEDURE.....	33
4.2.4	DEVIATION FROM TEST STANDARD	33
4.2.5	TEST SETUP	33
4.2.6	EUT OPERATING CONDITIONS	33
4.2.7	TEST RESULTS	34
5.	INFORMATION ON THE TESTING LABORATORIES	37
6.	APPENDIX-A- MODIFICATIONS RECORDERS FOR ENGINEERING CHANGES TO THE EUT BY THE LAB	38



1. CERTIFICATION

PRODUCT: 802.11a/b/g Compact Flash Radio Card
BRAND NAME: SYMBOL TECHNOLOGIES INC.
MODEL NO.: LA-5137C2
TEST SAMPLE: R&D SAMPLE
TESTED: July 24 to 26, 2010
APPLICANT: Symbol Technologies Inc.
STANDARDS: FCC Part 15, Subpart E (Section 15.407)
ANSI C63.4-2003

The above equipment (Model: LA-5137C2) has been tested by **Bureau Veritas Consumer Products Services (H.K.) Ltd., Taoyuan Branch**, and found compliance with the requirement of the above standards. The test record, data evaluation & Equipment Under Test (EUT) configurations represented herein are true and accurate accounts of the measurements of the sample's EMC characteristics under the conditions specified in this report.

PREPARED BY : Carol Liao , **DATE:** Sep. 15, 2010
(Carol Liao, Specialist)

TECHNICAL ACCEPTANCE : Hank Chung , **DATE:** Sep. 15, 2010
(Hank Chung, Deputy Manager)

APPROVED BY : May Chen , **DATE:** Sep. 15, 2010
(May Chen, Deputy Manager)



A D T

2. SUMMARY OF TEST RESULTS

The EUT has been tested according to the following specifications:

For 802.11a, 5150~5350MHz and 5470~5725MHz Band

APPLIED STANDARD: FCC Part 15, Subpart E (Section 15.407)			
Standard Section	Test Type	Result	Remark
15.407(b/1/2/3) (b)(5)	Electric Field Strength Spurious Emissions, 30MHz ~ 40000MHz	PASS	Meet the requirement of limit. Minimum passing margin is -0.7dB at 5150.0MHz
15.407(a/1/2/3)	Peak Transmit Power	PASS	Meet the requirement of limit.

NOTE:

1. The EUT was operating in 2400 ~ 2483.5MHz, 5.15~5.35GHz, 5.47~5.725GHz and 5.725~5.850GHz frequencies band. This report was recorded the RF parameters including 5.15~5.35GHz and 5.47~5.725GHz. For the 2400 ~ 2483.5MHz and 5.725~5.850GHz RF parameters was recorded in another test report.
2. This report is prepared for FCC class II permissive change. Only radiated emission and maximum peak output power were presented in this test report.

2.1 MEASUREMENT UNCERTAINTY

Where relevant, the following measurement uncertainty levels have been estimated for tests performed on the EUT as specified in CISPR 16-4-2:

This uncertainty represents an expanded uncertainty expressed at approximately the 95% confidence level using a coverage factor of $k=2$.

Measurement	Value
Radiated emissions (30MHz-1GHz)	3.94 dB
Radiated emissions (1GHz -18GHz)	2.49 dB
Radiated emissions (18GHz -40GHz)	2.70 dB



A D T

3. GENERAL INFORMATION

3.1 GENERAL DESCRIPTION OF EUT

PRODUCT	802.11a/b/g Compact Flash Radio Card
MODEL NO.	LA-5137C2
FCC ID	H9PLA5137C2
POWER SUPPLY	DC 3.3 V +/-5% from host equipment
MODULATION TYPE	CCK, DQPSK, DBPSK for DSSS 64QAM, 16QAM, QPSK, BPSK for OFDM
MODULATION TECHNOLOGY	DSSS, OFDM
TRANSFER RATE	802.11b:11/5.5/2/1Mbps 802.11g: 54/48/36/24/18/12/9/6Mbps 802.11a: 54/48/36/24/18/12/9/6Mbps
FREQUENCY RANGE	For 15.407 802.11a: 5.18 ~ 5.32GHz, 5.50 ~ 5.70GHz For 15.247 802.11b & 802.11g: 2412 ~ 2462MHz 802.11a: 5.745 ~ 5.825GHz
NUMBER OF CHANNEL	For 15.407 19 for 802.11a For 15.247(2.4GHz) 11 for 802.11b, 802.11g For 15.247(5GHz) 5 for 802.11a
MAXIMUM OUTPUT POWER	For 15.407 802.11a: 34.4mW For 15.247(2.4GHz) 802.11b: 72.4mW 802.11g: 95.5mW For 15.247(5GHz) 802.11a: 60.3mW
ANTENNA TYPE	Please see note 3 (on next page)
DATA CABLE	NA
I/O PORTS	NA
ASSOCIATED DEVICES	NA

NOTE:

1. This report is prepared for FCC class II permissive change. The difference compared with the Report No.: RF960622H02 design is as the following:
 - u RF shielding cover was modified.
2. The EUT operates in both the 5GHz and 2.4GHz Bands and compatibility with 802.11a and 802.11b, 802.11g technology.
3. There is one antenna provided to this EUT, please refer to the following table:

Model No.	Frequency	Gain (dBi)	Antenna Type	Antenna Connector	Cable loss	Net gain (dBi)
ML-2452-APA2-01	2.4GHz	3	Dipole	R-SMA	0.9dB	2.1
	5GHz	4			1.5dB	2.5

4. The above EUT information was declared by manufacturer and for more detailed features description, please refer to the manufacturer's specifications or user's manual.



A D T

3.2 DESCRIPTION OF TEST MODES

Operated in 5150MHz ~ 5350MHz bands:

Eight channels are provided for 802.11a:

CHANNEL	FREQUENCY
36	5180 MHz
40	5200 MHz
44	5220 MHz
48	5240 MHz
52	5260 MHz
56	5280 MHz
60	5300 MHz
64	5320 MHz

Operated in 5470MHz ~ 5725MHz bands:

Eleven channels are provided for 802.11a:

CHANNEL	FREQUENCY
100	5500 MHz
104	5520 MHz
108	5540 MHz
112	5560 MHz
116	5580 MHz
120	5600 MHz
124	5620 MHz
128	5640 MHz
132	5660 MHz
136	5680 MHz
140	5700 MHz



A D T

3.2.1 TEST MODE APPLICABILITY AND TESTED CHANNEL DETAIL:

EUT CONFIGURE MODE	APPLICABLE TO			DESCRIPTION
	RE < 1G	RE ≥ 1G	APCM	
-	√	√	√	-

Where **PLC**: Power Line Conducted Emission **RE < 1G**: Radiated Emission below 1GHz
RE ≥ 1G: Radiated Emission above 1GHz **APCM**: Antenna Port Conducted Measurement

RADIATED EMISSION TEST (BELOW 1 GHz):

- Pre-Scan has been conducted to determine the worst-case mode from all possible combinations between available modulations, data rates and antenna ports (if EUT with antenna diversity architecture).
- Following channel(s) was (were) selected for the final test as listed below.

MODE	AVAILABLE CHANNEL	TESTED CHANNEL	MODULATION TECHNOLOGY	MODULATION TYPE	DATA RATE (Mbps)
802.11a	36 to 140	36	OFDM	BPSK	6

RADIATED EMISSION TEST (ABOVE 1 GHz):

- Pre-Scan has been conducted to determine the worst-case mode from all possible combinations between available modulations, data rates and antenna ports (if EUT with antenna diversity architecture).
- Following channel(s) was (were) selected for the final test as listed below.

MODE	AVAILABLE CHANNEL	TESTED CHANNEL	MODULATION TECHNOLOGY	MODULATION TYPE	DATA RATE (Mbps)
802.11a	36 to 140	36, 48, 52, 64, 100, 120, 140	OFDM	BPSK	6

ANTENNA PORT CONDUCTED MEASUREMENT:

- This item includes all test value of each mode, but only includes spectrum plot of worst value of each mode.
- Pre-Scan has been conducted to determine the worst-case mode from all possible combinations between available modulations, data rates and antenna ports (if EUT with antenna diversity architecture).
- Following channel(s) was (were) selected for the final test as listed below.

MODE	AVAILABLE CHANNEL	TESTED CHANNEL	MODULATION TECHNOLOGY	MODULATION TYPE	DATA RATE (Mbps)
802.11a	36 to 140	36, 48, 52, 64, 100, 120, 140	OFDM	BPSK	6

TEST CONDITION:

APPLICABLE TO	ENVIRONMENTAL CONDITIONS	INPUT POWER (SYSTEM)	TESTED BY
RE ³ 1G	25deg. C, 66%RH, 1011 hPa	120Vac, 60Hz	Frank Liu
RE<1G	25deg. C, 66%RH, 1011 hPa	120Vac, 60Hz	Frank Liu
APCM	25deg. C, 60%RH, 1011 hPa	120Vac, 60Hz	Phoenix Huang

3.3 GENERAL DESCRIPTION OF APPLIED STANDARDS

The EUT is a RF product. According to the specifications of the manufacturer, it must comply with the requirements of the following standards:

FCC Part 15, Subpart E (15.407)

ANSI C63.4-2003

All test items have been performed and recorded as per the above standards.

NOTE: The EUT has been verified to comply with the requirements of FCC Part 15, Subpart B, Class B (DoC). The test report has been issued separately.

3.4 DESCRIPTION OF SUPPORT UNITS

The EUT has been tested as an independent unit together with other necessary accessories or support units. The following support units or accessories were used to form a representative test configuration during the tests.

NO.	PRODUCT	BRAND	MODEL NO.	SERIAL NO.	FCC ID
1	NOTEBOOK COMPUTER	IBM	2372	9949APL	FCC DoC
2	PCMCIA Ext Card	USI	NA	NA	NA
3	CF to PCMCIA Card	USI	NA	NA	NA

NO.	SIGNAL CABLE DESCRIPTION OF THE ABOVE SUPPORT UNITS
1	NA
2	NA
3	NA

NOTE: 1. All power cords of the above support units are non shielded (1.8m).

3.5 CONFIGURATION OF SYSTEM UNDER TEST

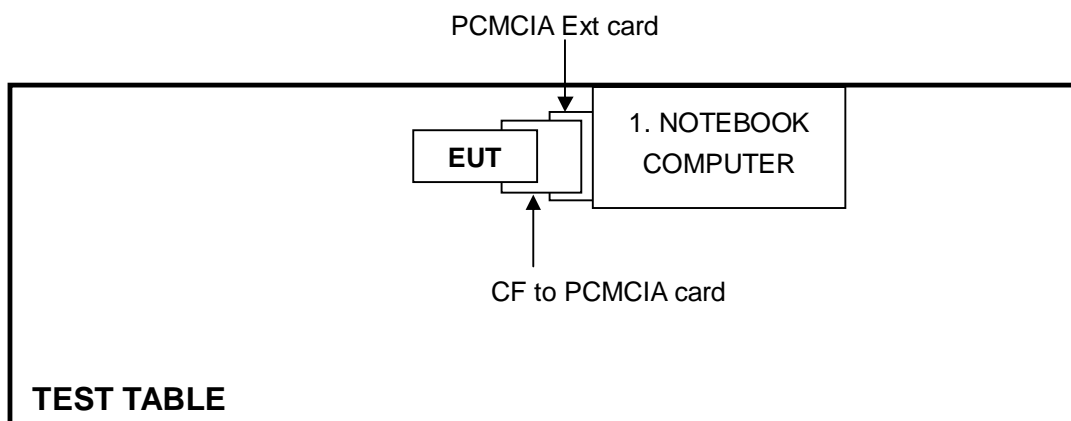

4. TEST TYPES AND RESULTS

4.1 RADIATED EMISSION MEASUREMENT

4.1.1 LIMITS OF RADIATED EMISSION MEASUREMENT

Emissions radiated outside of the specified bands, shall be according to the general radiated limits in 15.209 as following:

Frequencies (MHz)	Field strength (microvolts/meter)	Measurement distance (meters)
0.009-0.490	2400/F(kHz)	300
0.490-1.705	24000/F(kHz)	30
1.705-30.0	30	30
30-88	100	3
88-216	150	3
216-960	200	3
Above 960	500	3

NOTE:

1. The lower limit shall apply at the transition frequencies.
2. Emission level (dBuV/m) = 20 log Emission level (uV/m).
3. As shown in 15.35(b), for frequencies above 1000MHz, the field strength limits are based on average detector, however, the peak field strength of any emission shall not exceed the maximum permitted average limits, specified above by more than 20dB under any condition of modulation.

4.1.2 LIMITS OF UNWANTED EMISSION OUT OF THE RESTRICTED BANDS

Frequencies (MHz)	EIRP Limit (dBm)	Equivalent Field Strength at 3m (dBμV/m) *note 3
5150~5250	-27	68.3
5250~5350	-27	68.3
5470~5725	-27	68.3
5725~5825	-27 *note 1	68.3
	-17 *note 2	78.3

NOTE:

1. For frequencies 10MHz or greater above or below the band edge.
2. All emissions within the frequency range from the band edge to 10MHz above or below the band edge.
3. The following formula is used to convert the equipment isotropic radiated power (eirp) to field strength

$$E = \frac{1000000\sqrt{30P}}{3} \mu\text{V/m, where P is the eirp (Watts)}$$



A D T

4.1.3 TEST INSTRUMENTS

DESCRIPTION & MANUFACTURER	MODEL NO.	SERIAL NO.	CALIBRATED DATE	CALIBRATED UNTIL
ROHDE & SCHWARZ Spectrum Analyzer	FSP40	100036	Dec. 18, 2009	Dec. 17, 2010
Agilent PSA Spectrum Analyzer	E4446A	MY46180622	May 12 , 2010	May 11 , 2011
HP Pre_Amplifier	8449B	300801923	Nov. 02, 2009	Nov. 01, 2010
ROHDE & SCHWARZ Test Receiver	ESCS30	847124/029	Aug. 28, 2009	Aug. 27, 2010
SCHWARZBECK TRILOG Broadband Antenna	VULB 9168	138	Apr. 28, 2010	Apr. 27, 2011
Schwarzbeck Horn_Antenna	BBHA9120	D124	Dec. 18, 2009	Dec. 17, 2010
Schwarzbeck Horn_Antenna	BBHA 9170	BBHA9170153	Jan. 22, 2010	Jan. 21, 2011
RF Switches	EMH-011	1001	NA	NA
RF CABLE (Chaintek)	Sucoflex 106	28077	Aug. 14, 2009	Aug. 13, 2010
RF Cable	8DFB	STCCAB-30M-1GHz	NA	NA
Software	ADT_Radiated_V7.6.15.9.2	NA	NA	NA
CT Antenna Tower & Turn Table	NA	NA	NA	NA

- Note: 1. The calibration interval of the above test instruments is 12 months and the calibrations are traceable to NML/ROC and NIST/USA.
2. The horn antenna, preamplifier (model: 8449B) and Spectrum Analyzer (model: FSP40) are used only for the measurement of emission frequency above 1GHz if tested.
3. The test was performed in Open Site No. C.
4. The FCC Site Registration No. is 656396.
5. The VCCI Site Registration No. is R-1626.
6. The CANADA Site Registration No. is IC 7450G-3.

4.1.4 TEST PROCEDURES

- a. The EUT was placed on the top of a rotating table 0.8 meters above the ground at a 10 meter open area test site. The table was rotated 360 degrees to determine the position of the highest radiation.
- b. The EUT was set 3 meters away from the interference-receiving antenna, which was mounted on the top of a variable-height antenna tower.
- c. The antenna is a broadband antenna, and its height is varied from one meter to four meters above the ground to determine the maximum value of the field strength. Both horizontal and vertical polarizations of the antenna are set to make the measurement.
- d. For each suspected emission, the EUT was arranged to its worst case and then the antenna was tuned to heights from 1 meter to 4 meters and the rotatable table was turned from 0 degrees to 360 degrees to find the maximum reading.
- e. The test-receiver system was set to Peak Detect Function and Specified Bandwidth with Maximum Hold Mode.
- f. If the emission level of the EUT in peak mode was 10dB lower than the limit specified, then testing could be stopped and the peak values of the EUT would be reported. Otherwise the emissions that did not have 10dB margin would be re-tested one by one using peak, quasi-peak or average method as specified and then reported in a data sheet.

NOTE:

1. The resolution bandwidth and video bandwidth of test receiver/spectrum analyzer is 120kHz for Peak detection (PK) and Quasi-peak detection (QP) at frequency below 1GHz.
2. The resolution bandwidth of test receiver/spectrum analyzer is 1 MHz and the video bandwidth is 3 MHz for Peak detection (PK) at frequency above 1GHz.
3. The resolution bandwidth of test receiver/spectrum analyzer is 1 MHz and the video bandwidth is 10 Hz for Average detection (AV) at frequency above 1GHz.

4.1.5 DEVIATION FROM TEST STANDARD

No deviation

4.1.6 TEST SETUP

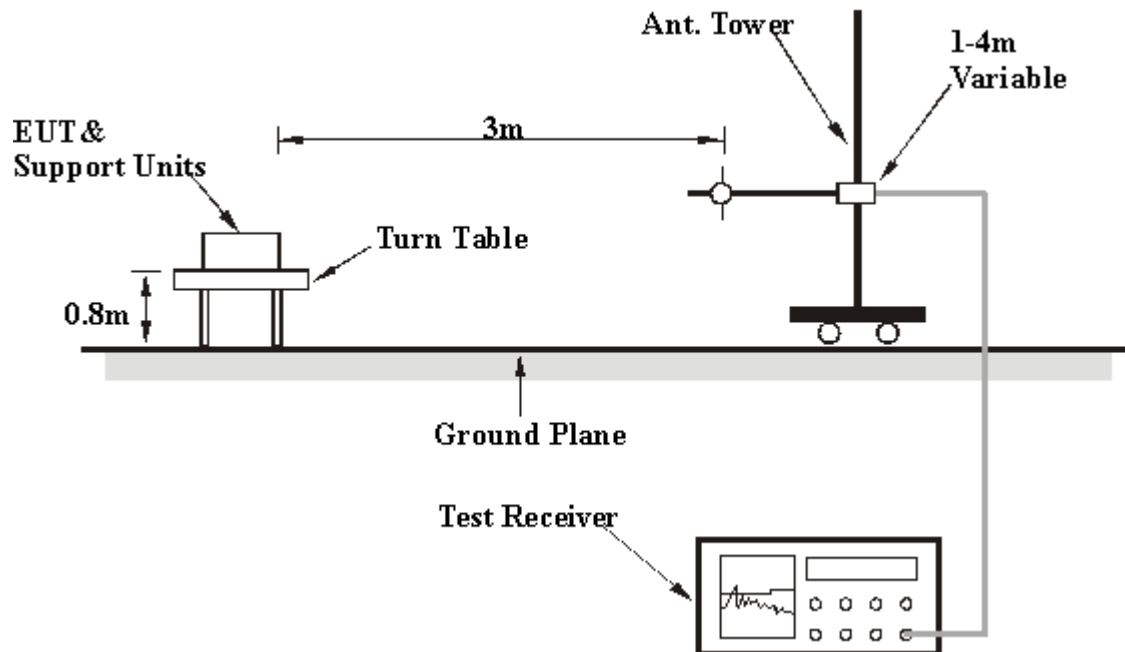

For the actual test configuration, please refer to the related item – Photographs of the Test Configuration.

4.1.7 EUT OPERATING CONDITION

- a. Connected the EUT with the support unit 1 (Notebook computer) and placed it on the testing table.
- b. The support unit 1 (Notebook computer) ran a test program “cTxRx 3.0.1.1” to enable EUT under transmission condition continuously.



A D T

4.1.8 TEST RESULTS

BELOW 1GHz WORST-CASE DATA : 802.11a OFDM MODULATION

EUT TEST CONDITION		MEASUREMENT DETAIL	
CHANNEL	Channel 36	FREQUENCY RANGE	Below 1000MHz
INPUT POWER (SYSTEM)	120Vac, 60 Hz	DETECTOR FUNCTION	Quasi-Peak
ENVIRONMENTAL CONDITIONS	25deg. C, 66%RH 1011 hPa	TESTED BY	Frank Liu

ANTENNA POLARITY & TEST DISTANCE: HORIZONTAL AT 3 M								
NO.	FREQ. (MHz)	EMISSION LEVEL (dBuV/m)	LIMIT (dBuV/m)	MARGIN (dB)	ANTENNA HEIGHT (m)	TABLE ANGLE (Degree)	RAW VALUE (dBuV)	CORRECTION FACTOR (dB/m)
1	132.90	31.6 QP	43.5	-11.9	1.29 H	123	17.73	13.91
2	199.25	40.8 QP	43.5	-2.7	1.04 H	23	29.86	10.98
3	325.07	29.0 QP	46.0	-17.0	1.00 H	26	12.69	16.29
4	398.50	38.5 QP	46.0	-7.5	1.08 H	244	20.32	18.14
5	479.99	32.9 QP	46.0	-13.1	1.07 H	69	12.63	20.23
6	779.17	34.7 QP	46.0	-11.3	1.04 H	64	9.31	25.38
ANTENNA POLARITY & TEST DISTANCE: VERTICAL AT 3 M								
NO.	FREQ. (MHz)	EMISSION LEVEL (dBuV/m)	LIMIT (dBuV/m)	MARGIN (dB)	ANTENNA HEIGHT (m)	TABLE ANGLE (Degree)	RAW VALUE (dBuV)	CORRECTION FACTOR (dB/m)
1	60.00	29.8 QP	40.0	-10.2	1.23 V	211	16.29	13.55
2	327.06	37.3 QP	46.0	-8.7	1.02 V	155	20.95	16.34
3	444.91	30.5 QP	46.0	-15.5	1.04 V	152	11.23	19.31
4	480.00	36.2 QP	46.0	-9.8	1.30 V	167	16.00	20.23
5	764.30	33.8 QP	46.0	-12.2	1.04 V	131	8.58	25.21
6	930.00	35.1 QP	46.0	-10.9	1.00 V	29	7.45	27.69

- REMARKS:**
1. Emission level (dBuV/m) = Raw Value (dBuV) + Correction Factor (dB/m).
 2. Correction Factor (dB/m) = Antenna Factor (dB/m) + Cable Factor (dB).
 3. The other emission levels were very low against the limit.
 4. Margin value = Emission level – Limit value.



A D T

ABOVE 1GHz WORST-CASE DATA

802.11a OFDM MODULATION

EUT TEST CONDITION		MEASUREMENT DETAIL	
CHANNEL	Channel 36	FREQUENCY RANGE	1 ~ 40GHz
INPUT POWER (SYSTEM)	120Vac, 60 Hz	DETECTOR FUNCTION	Peak (PK) Average (AV)
ENVIRONMENTAL CONDITIONS	25deg. C, 66%RH 1011 hPa	TESTED BY	Frank Liu

ANTENNA POLARITY & TEST DISTANCE: HORIZONTAL AT 3 M

NO.	FREQ. (MHz)	EMISSION LEVEL (dBuV/m)	LIMIT (dBuV/m)	MARGIN (dB)	ANTENNA HEIGHT (m)	TABLE ANGLE (Degree)	RAW VALUE (dBuV)	CORRECTION FACTOR (dB/m)
1	5150.00	53.1 PK	74.0	-20.9	1.55 H	137	17.14	36.00
2	5150.00	41.4 AV	54.0	-12.6	1.55 H	137	5.44	36.00
3	*5180.00	93.5 PK			1.55 H	137	57.45	36.05
4	*5180.00	85.1 AV			1.55 H	137	49.05	36.05
5	#10360.00	60.8 PK	88.3	-27.5	1.70 H	55	14.65	46.15
6	#10360.00	48.8 AV	68.3	-19.5	1.70 H	55	2.65	46.15
7	15540.00	55.1 PK	74.0	-18.9	1.23 H	231	6.99	48.11
8	15540.00	43.4 AV	54.0	-10.6	1.23 H	231	-4.71	48.11

ANTENNA POLARITY & TEST DISTANCE: VERTICAL AT 3 M

NO.	FREQ. (MHz)	EMISSION LEVEL (dBuV/m)	LIMIT (dBuV/m)	MARGIN (dB)	ANTENNA HEIGHT (m)	TABLE ANGLE (Degree)	RAW VALUE (dBuV)	CORRECTION FACTOR (dB/m)
1	5150.00	62.5 PK	74.0	-11.5	1.01 V	143	26.50	36.00
2	5150.00	53.3 AV	54.0	-0.7	1.01 V	143	17.30	36.00
3	*5180.00	110.7 PK			1.01 V	143	74.65	36.05
4	*5180.00	102.3 AV			1.01 V	143	66.25	36.05
5	#10360.00	59.2 PK	88.3	-29.1	1.53 V	192	13.05	46.15
6	#10360.00	47.0 AV	68.3	-21.3	1.53 V	192	0.85	46.15
7	15540.00	56.8 PK	74.0	-17.2	1.27 V	191	8.65	48.11
8	15540.00	44.4 AV	54.0	-9.6	1.27 V	191	-3.75	48.11

- REMARKS:**
1. Emission level (dBuV/m) = Raw Value (dBuV) + Correction Factor (dB/m).
 2. Correction Factor (dB/m) = Antenna Factor (dB/m) + Cable Factor (dB).
 3. The other emission levels were very low against the limit.
 4. Margin value = Emission level – Limit value.
 5. “ * “: Fundamental frequency.
 6. "#":The radiated frequency is out the restricted band.



A D T

EUT TEST CONDITION		MEASUREMENT DETAIL	
CHANNEL	Channel 48	FREQUENCY RANGE	1 ~ 40GHz
INPUT POWER (SYSTEM)	120Vac, 60 Hz	DETECTOR FUNCTION	Peak (PK) Average (AV)
ENVIRONMENTAL CONDITIONS	25deg. C, 66%RH 1011 hPa	TESTED BY	Frank Liu

ANTENNA POLARITY & TEST DISTANCE: HORIZONTAL AT 3 M								
NO.	FREQ. (MHz)	EMISSION LEVEL (dBuV/m)	LIMIT (dBuV/m)	MARGIN (dB)	ANTENNA HEIGHT (m)	TABLE ANGLE (Degree)	RAW VALUE (dBuV)	CORRECTION FACTOR (dB/m)
1	*5240.00	92.6 PK			1.54 H	132	56.46	36.14
2	*5240.00	84.3 AV			1.54 H	132	48.16	36.14
3	#10480.00	59.8 PK	88.3	-28.5	1.70 H	81	13.48	46.32
4	#10480.00	47.7 AV	68.3	-20.6	1.70 H	81	1.38	46.32
5	15720.00	55.4 PK	74.0	-18.6	1.24 H	235	7.81	47.59
6	15720.00	43.8 AV	54.0	-10.2	1.24 H	235	-3.79	47.59
ANTENNA POLARITY & TEST DISTANCE: VERTICAL AT 3 M								
NO.	FREQ. (MHz)	EMISSION LEVEL (dBuV/m)	LIMIT (dBuV/m)	MARGIN (dB)	ANTENNA HEIGHT (m)	TABLE ANGLE (Degree)	RAW VALUE (dBuV)	CORRECTION FACTOR (dB/m)
1	*5240.00	110.3 PK			1.01 V	127	74.16	36.14
2	*5240.00	101.9 AV			1.01 V	127	65.76	36.14
3	#10480.00	61.2 PK	88.3	-27.1	1.53 V	187	14.88	46.32
4	#10480.00	49.5 AV	68.3	-8.8	1.53 V	187	3.18	46.32
5	15720.00	55.6 PK	74.0	-18.4	1.31 V	132	8.01	47.59
6	15720.00	44.3 AV	54.0	-9.7	1.31 V	132	-3.29	47.59

- REMARKS:**
1. Emission level (dBuV/m) = Raw Value (dBuV) + Correction Factor (dB/m).
 2. Correction Factor (dB/m) = Antenna Factor (dB/m) + Cable Factor (dB).
 3. The other emission levels were very low against the limit.
 4. Margin value = Emission level – Limit value.
 5. “ * “: Fundamental frequency.
 6. "#":The radiated frequency is out the restricted band.



A D T

EUT TEST CONDITION		MEASUREMENT DETAIL	
CHANNEL	Channel 52	FREQUENCY RANGE	1 ~ 40GHz
INPUT POWER (SYSTEM)	120Vac, 60 Hz	DETECTOR FUNCTION	Peak (PK) Average (AV)
ENVIRONMENTAL CONDITIONS	25deg. C, 66%RH 1011 hPa	TESTED BY	Frank Liu

ANTENNA POLARITY & TEST DISTANCE: HORIZONTAL AT 3 M								
NO.	FREQ. (MHz)	EMISSION LEVEL (dBuV/m)	LIMIT (dBuV/m)	MARGIN (dB)	ANTENNA HEIGHT (m)	TABLE ANGLE (Degree)	RAW VALUE (dBuV)	CORRECTION FACTOR (dB/m)
1	*5260.00	92.7 PK			1.59 H	67	56.52	36.18
2	*5260.00	84.5 AV			1.59 H	67	48.32	36.18
3	#10520.00	60.4 PK	88.3	-27.9	1.70 H	56	14.01	46.39
4	#10520.00	49.5 AV	68.3	-18.8	1.70 H	56	3.11	46.39
5	15780.00	55.0 PK	74.0	-19.0	1.03 H	231	7.58	47.42
6	15780.00	44.1 AV	54.0	-9.9	1.03 H	231	-3.32	47.42
ANTENNA POLARITY & TEST DISTANCE: VERTICAL AT 3 M								
NO.	FREQ. (MHz)	EMISSION LEVEL (dBuV/m)	LIMIT (dBuV/m)	MARGIN (dB)	ANTENNA HEIGHT (m)	TABLE ANGLE (Degree)	RAW VALUE (dBuV)	CORRECTION FACTOR (dB/m)
1	*5260.00	110.8 PK			1.00 V	141	74.62	36.18
2	*5260.00	102.4 AV			1.00 V	141	66.22	36.18
3	#10520.00	63.2 PK	88.3	-25.1	1.59 V	32	16.81	46.39
4	#10520.00	53.0 AV	68.3	-15.3	4.00 V	32	6.61	46.39
5	15780.00	54.3 PK	74.0	-19.7	1.04 V	224	6.88	47.42
6	15780.00	44.6 AV	54.0	-9.4	1.04 V	224	-2.82	47.42

- REMARKS:**
1. Emission level (dBuV/m) = Raw Value (dBuV) + Correction Factor (dB/m).
 2. Correction Factor (dB/m) = Antenna Factor (dB/m) + Cable Factor (dB).
 3. The other emission levels were very low against the limit.
 4. Margin value = Emission level – Limit value.
 5. “ * “: Fundamental frequency.
 6. "#":The radiated frequency is out the restricted band.



A D T

EUT TEST CONDITION		MEASUREMENT DETAIL	
CHANNEL	Channel 64	FREQUENCY RANGE	1 ~ 40GHz
INPUT POWER (SYSTEM)	120Vac, 60 Hz	DETECTOR FUNCTION	Peak (PK) Average (AV)
ENVIRONMENTAL CONDITIONS	25deg. C, 66%RH 1011 hPa	TESTED BY	Frank Liu

ANTENNA POLARITY & TEST DISTANCE: HORIZONTAL AT 3 M								
NO.	FREQ. (MHz)	EMISSION LEVEL (dBuV/m)	LIMIT (dBuV/m)	MARGIN (dB)	ANTENNA HEIGHT (m)	TABLE ANGLE (Degree)	RAW VALUE (dBuV)	CORRECTION FACTOR (dB/m)
1	*5320.00	92.9 PK			1.54 H	57	56.63	36.27
2	*5320.00	84.7 AV			1.54 H	57	48.43	36.27
3	5350.00	52.7 PK	74.0	-21.3	1.55 H	137	16.36	36.32
4	5350.00	41.6 AV	54.0	-12.4	1.55 H	137	5.25	36.32
5	10640.00	62.2 PK	74.0	-11.8	1.80 H	80	15.57	46.63
6	10640.00	50.4 AV	54.0	-3.6	1.80 H	80	3.77	46.63
7	15780.00	55.3 PK	74.0	-18.7	1.04 H	237	7.88	47.42
8	15780.00	44.5 AV	54.0	-9.5	1.04 H	237	-2.92	47.42
ANTENNA POLARITY & TEST DISTANCE: VERTICAL AT 3 M								
NO.	FREQ. (MHz)	EMISSION LEVEL (dBuV/m)	LIMIT (dBuV/m)	MARGIN (dB)	ANTENNA HEIGHT (m)	TABLE ANGLE (Degree)	RAW VALUE (dBuV)	CORRECTION FACTOR (dB/m)
1	*5320.00	109.4 PK			1.08 V	134	73.13	36.27
2	*5320.00	101.1 AV			1.08 V	134	64.83	36.27
3	5350.00	66.8 PK	74.0	-7.2	1.08 V	136	30.49	36.32
4	5350.00	53.2 AV	54.0	-0.8	1.08 V	136	16.92	36.32
5	10640.00	55.7 PK	74.0	-18.3	1.06 V	109	9.07	46.63
6	10640.00	45.3 AV	54.0	-8.7	1.06 V	109	-1.33	46.63
7	15780.00	53.4 PK	74.0	-20.6	1.00 V	33	5.98	47.42
8	15780.00	43.4 AV	54.0	-10.6	1.00 V	33	-4.02	47.42

- REMARKS:**
1. Emission level (dBuV/m) = Raw Value (dBuV) + Correction Factor (dB/m).
 2. Correction Factor (dB/m) = Antenna Factor (dB/m) + Cable Factor (dB).
 3. The other emission levels were very low against the limit.
 4. Margin value = Emission level – Limit value.
 5. “ * “: Fundamental frequency.



A D T

EUT TEST CONDITION		MEASUREMENT DETAIL	
CHANNEL	Channel 100	FREQUENCY RANGE	1 ~ 40GHz
INPUT POWER (SYSTEM)	120Vac, 60 Hz	DETECTOR FUNCTION	Peak (PK) Average (AV)
ENVIRONMENTAL CONDITIONS	25deg. C, 66%RH 1011 hPa	TESTED BY	Frank Liu

ANTENNA POLARITY & TEST DISTANCE: HORIZONTAL AT 3 M								
NO.	FREQ. (MHz)	EMISSION LEVEL (dBuV/m)	LIMIT (dBuV/m)	MARGIN (dB)	ANTENNA HEIGHT (m)	TABLE ANGLE (Degree)	RAW VALUE (dBuV)	CORRECTION FACTOR (dB/m)
1	5460.00	56.2 PK	74.0	-17.8	1.03 H	128	19.70	36.50
2	5460.00	43.1 AV	54.0	-10.9	1.03 H	128	6.60	36.50
3	#5470.00	58.2 PK	88.3	-30.1	1.03 H	128	21.69	36.51
4	#5470.00	45.9 AV	68.3	-22.4	1.03 H	128	9.39	36.51
5	*5500.00	92.1 PK			1.59 H	62	55.54	36.56
6	*5500.00	83.4 AV			1.59 H	62	46.84	36.56
7	11000.00	59.8 PK	74.0	-14.2	1.41 H	246	12.45	47.35
8	11000.00	49.6 AV	54.0	-4.4	1.41 H	246	2.25	47.35
9	#16500.00	56.6 PK	88.3	-31.7	1.22 H	261	9.13	47.47
10	#16500.00	46.3 AV	68.3	-22.0	1.22 H	261	-1.17	47.47
ANTENNA POLARITY & TEST DISTANCE: VERTICAL AT 3 M								
NO.	FREQ. (MHz)	EMISSION LEVEL (dBuV/m)	LIMIT (dBuV/m)	MARGIN (dB)	ANTENNA HEIGHT (m)	TABLE ANGLE (Degree)	RAW VALUE (dBuV)	CORRECTION FACTOR (dB/m)
1	5460.00	62.4 PK	74.0	-11.6	1.13 V	128	25.90	36.50
2	5460.00	47.8 AV	54.0	-6.2	1.13 V	128	11.30	36.50
3	#5470.00	68.8 PK	88.3	-19.5	1.13 V	128	32.29	36.51
4	#5470.00	53.2 AV	68.3	-15.1	1.13 V	128	16.69	36.51
5	*5500.00	110.9 PK			1.03 V	84	74.34	36.56
6	*5500.00	101.4 AV			1.03 V	84	64.84	36.56
7	11000.00	59.2 PK	74.0	-14.8	1.65 V	170	11.85	47.35
8	11000.00	47.4 AV	54.0	-6.6	1.65 V	170	0.05	47.35
9	#16500.00	56.3 PK	88.3	-32.0	1.00 V	48	8.83	47.47
10	#16500.00	45.1 AV	68.3	-23.2	1.00 V	48	-2.37	47.47

- REMARKS:**
1. Emission level (dBuV/m) = Raw Value (dBuV) + Correction Factor (dB/m).
 2. Correction Factor (dB/m) = Antenna Factor (dB/m) + Cable Factor (dB).
 3. The other emission levels were very low against the limit.
 4. Margin value = Emission level – Limit value.
 5. “ * “: Fundamental frequency.
 6. "#":The radiated frequency is out the restricted band.



A D T

EUT TEST CONDITION		MEASUREMENT DETAIL	
CHANNEL	Channel 120	FREQUENCY RANGE	1 ~ 40GHz
INPUT POWER (SYSTEM)	120Vac, 60 Hz	DETECTOR FUNCTION	Peak (PK) Average (AV)
ENVIRONMENTAL CONDITIONS	25deg. C, 66%RH 1011 hPa	TESTED BY	Frank Liu

ANTENNA POLARITY & TEST DISTANCE: HORIZONTAL AT 3 M								
NO.	FREQ. (MHz)	EMISSION LEVEL (dBuV/m)	LIMIT (dBuV/m)	MARGIN (dB)	ANTENNA HEIGHT (m)	TABLE ANGLE (Degree)	RAW VALUE (dBuV)	CORRECTION FACTOR (dB/m)
1	*5600.00	93.1 PK			1.54 H	73	56.28	36.82
2	*5600.00	85.1 AV			1.54 H	73	48.28	36.82
3	11200.00	58.9 PK	74.0	-15.1	1.37 H	34	11.64	47.26
4	11200.00	47.5 AV	54.0	-6.5	1.37 H	34	0.24	47.26
5	#16800.00	57.7 PK	88.3	-30.6	1.44 H	20	9.37	48.33
6	#16800.00	45.6 AV	68.3	-22.7	1.44 H	20	-2.73	48.33
ANTENNA POLARITY & TEST DISTANCE: VERTICAL AT 3 M								
NO.	FREQ. (MHz)	EMISSION LEVEL (dBuV/m)	LIMIT (dBuV/m)	MARGIN (dB)	ANTENNA HEIGHT (m)	TABLE ANGLE (Degree)	RAW VALUE (dBuV)	CORRECTION FACTOR (dB/m)
1	*5600.00	112.8 PK			1.11 V	81	75.98	36.82
2	*5600.00	102.9 AV			1.11 V	81	66.08	36.82
3	11200.00	58.6 PK	74.0	-15.4	1.74 V	63	11.34	47.26
4	11200.00	45.8 AV	54.0	-8.2	1.74 V	63	-1.46	47.26
5	#16800.00	58.1 PK	88.3	-30.2	1.73 V	17	9.78	48.33
6	#16800.00	45.6 AV	68.3	-22.7	1.73 V	17	-2.73	48.33

- REMARKS:**
1. Emission level (dBuV/m) = Raw Value (dBuV) + Correction Factor (dB/m).
 2. Correction Factor (dB/m) = Antenna Factor (dB/m) + Cable Factor (dB).
 3. The other emission levels were very low against the limit.
 4. Margin value = Emission level – Limit value.
 5. “ * “: Fundamental frequency.
 6. "#":The radiated frequency is out the restricted band.



A D T

EUT TEST CONDITION		MEASUREMENT DETAIL	
CHANNEL	Channel 140	FREQUENCY RANGE	1 ~ 40GHz
INPUT POWER (SYSTEM)	120Vac, 60 Hz	DETECTOR FUNCTION	Peak (PK) Average (AV)
ENVIRONMENTAL CONDITIONS	25deg. C, 66%RH 1011 hPa	TESTED BY	Frank Liu

ANTENNA POLARITY & TEST DISTANCE: HORIZONTAL AT 3 M								
NO.	FREQ. (MHz)	EMISSION LEVEL (dBuV/m)	LIMIT (dBuV/m)	MARGIN (dB)	ANTENNA HEIGHT (m)	TABLE ANGLE (Degree)	RAW VALUE (dBuV)	CORRECTION FACTOR (dB/m)
1	*5700.00	93.0 PK			1.47 H	69	55.91	37.09
2	*5700.00	85.2 AV			1.47 H	69	48.11	37.09
3	#5725.00	60.7 PK	88.3	-27.6	1.06 H	130	23.55	37.15
4	#5725.00	45.6 AV	68.3	-22.7	1.06 H	130	8.45	37.15
5	11400.00	58.1 PK	74.0	-15.9	1.55 H	201	10.93	47.17
6	11400.00	45.9 AV	54.0	-8.1	1.55 H	201	-1.27	47.17
7	#17100.00	59.1 PK	88.3	-29.2	1.15 H	190	9.72	49.38
8	#17100.00	46.2 AV	68.3	-22.1	1.15 H	190	-3.18	49.38
ANTENNA POLARITY & TEST DISTANCE: VERTICAL AT 3 M								
NO.	FREQ. (MHz)	EMISSION LEVEL (dBuV/m)	LIMIT (dBuV/m)	MARGIN (dB)	ANTENNA HEIGHT (m)	TABLE ANGLE (Degree)	RAW VALUE (dBuV)	CORRECTION FACTOR (dB/m)
1	*5700.00	111.2 PK			1.09 V	106	74.11	37.09
2	*5700.00	101.5 AV			1.09 V	106	64.41	37.09
3	#5725.00	71.2 PK	88.3	-17.1	1.04 V	235	34.05	37.15
4	#5725.00	54.7 AV	68.3	-13.6	1.04 V	235	17.55	37.15
5	11400.00	57.9 PK	74.0	-16.1	1.32 V	151	10.73	47.17
6	11400.00	45.1 AV	54.0	-8.9	1.32 V	151	-2.07	47.17
7	#17100.00	58.6 PK	88.3	-29.7	1.15 V	7	9.22	49.38
8	#17100.00	45.3 AV	68.3	-23.0	1.15 V	7	-4.08	49.38

- REMARKS:**
1. Emission level (dBuV/m) = Raw Value (dBuV) + Correction Factor (dB/m).
 2. Correction Factor (dB/m) = Antenna Factor (dB/m) + Cable Factor (dB).
 3. The other emission levels were very low against the limit.
 4. Margin value = Emission level – Limit value.
 5. “ * “: Fundamental frequency.
 6. “#”:The radiated frequency is out the restricted band.



A D T

RESTRICTED BANDEDGE (802.11a MODE, CH36, HORIZONTAL)

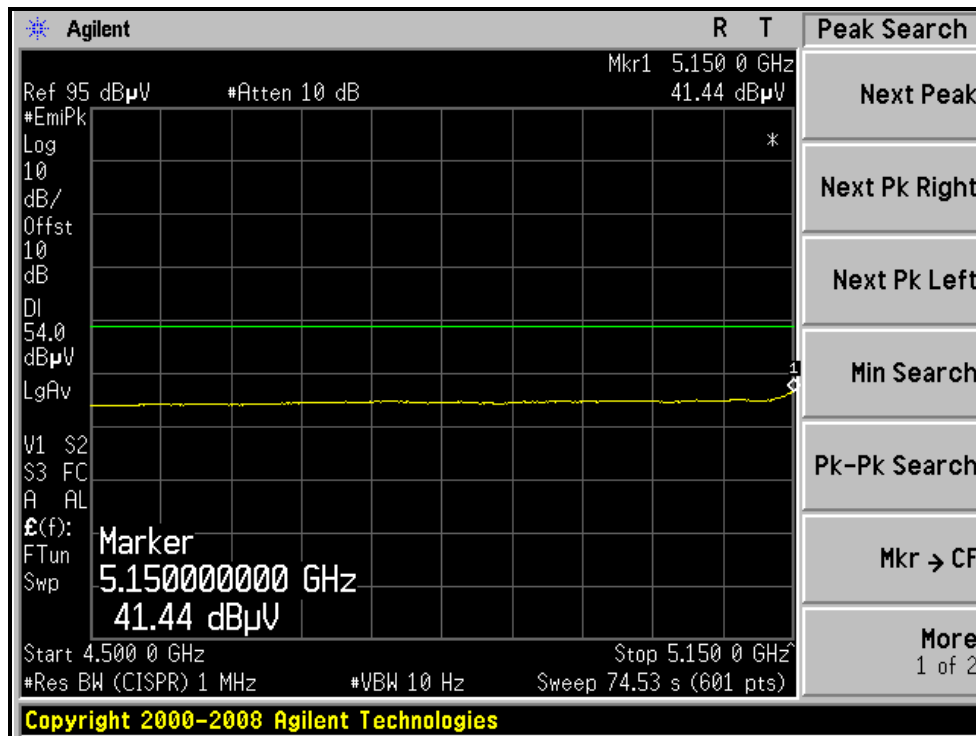
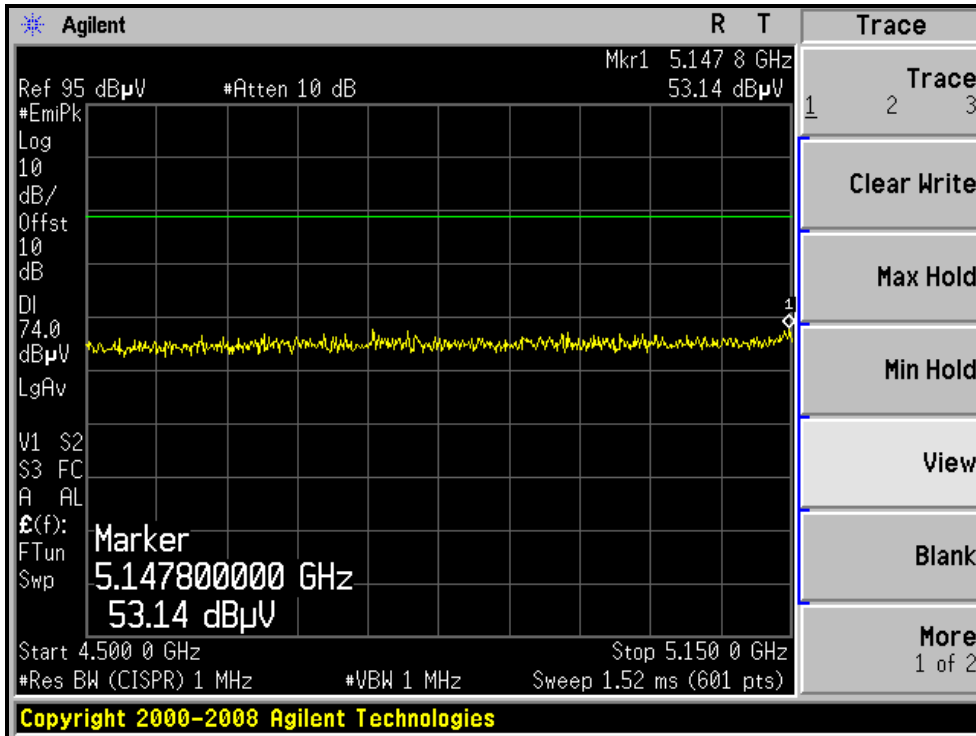



A D T

RESTRICTED BANDEDGE (802.11a MODE, CH36, VERTICAL)

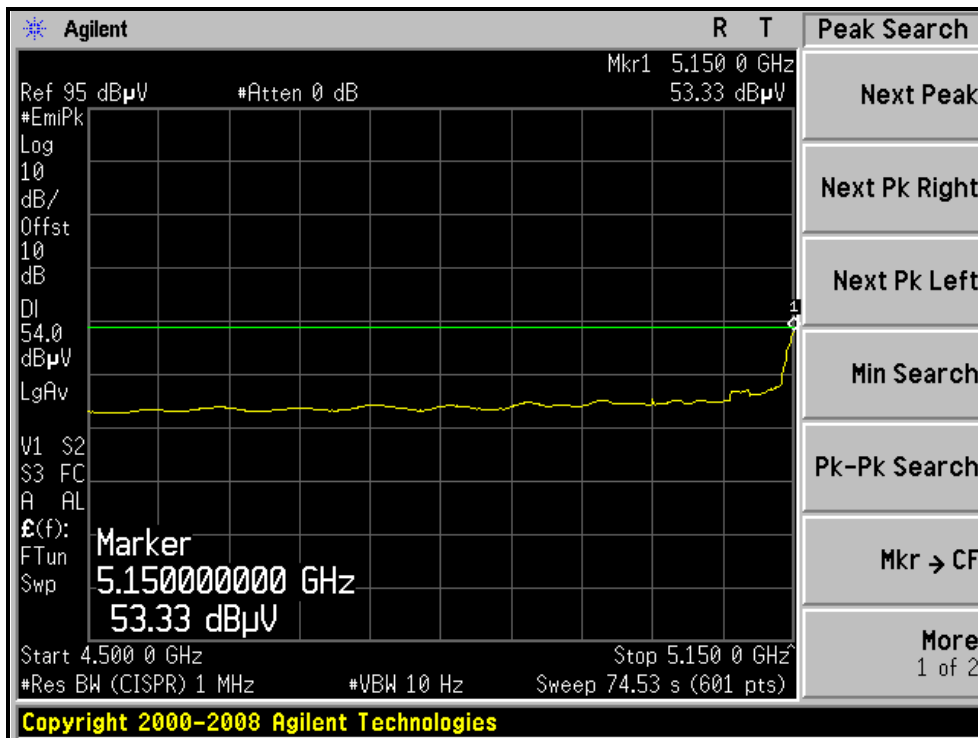
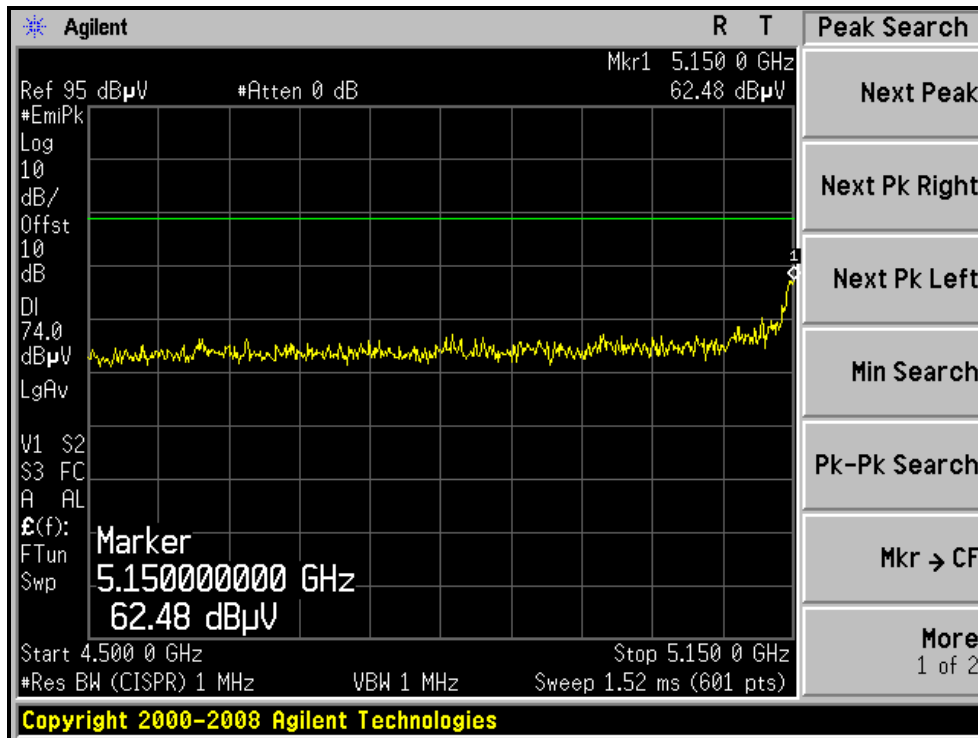



A D T

RESTRICTED BANDEDGE (802.11a MODE, CH64, HORIZONTAL)

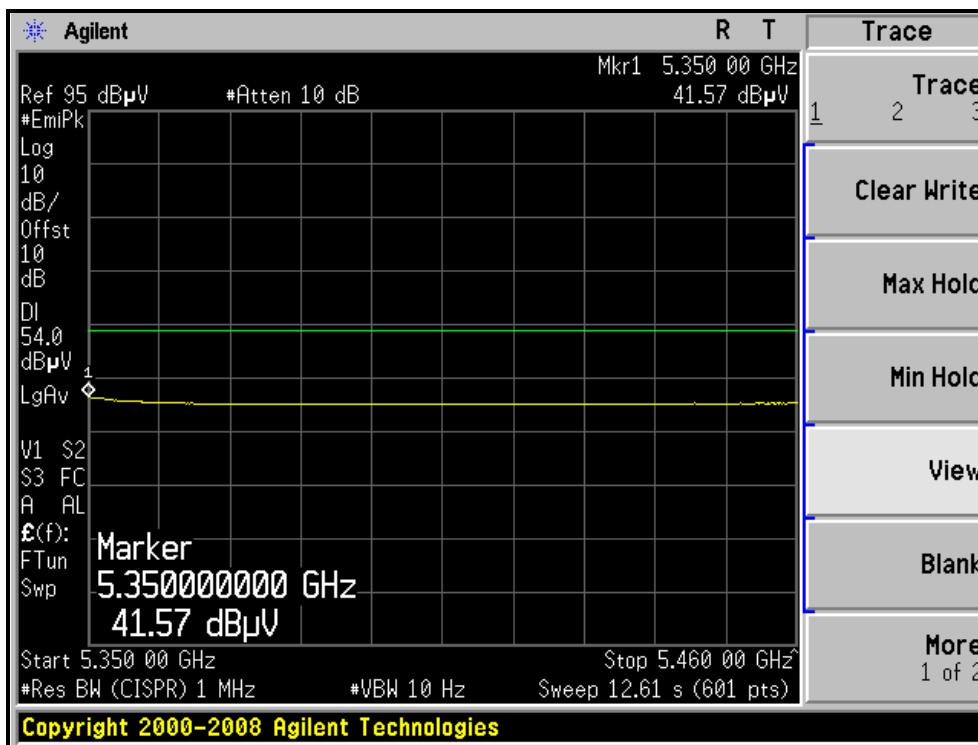
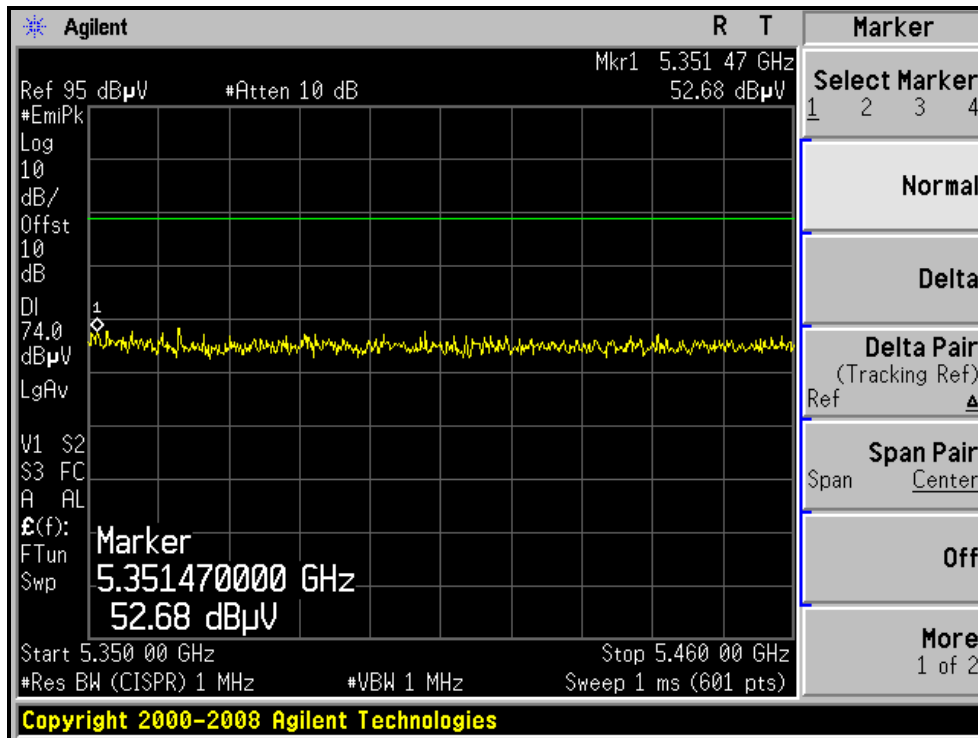



A D T

RESTRICTED BANDEDGE (802.11a MODE, CH64, VERTICAL)

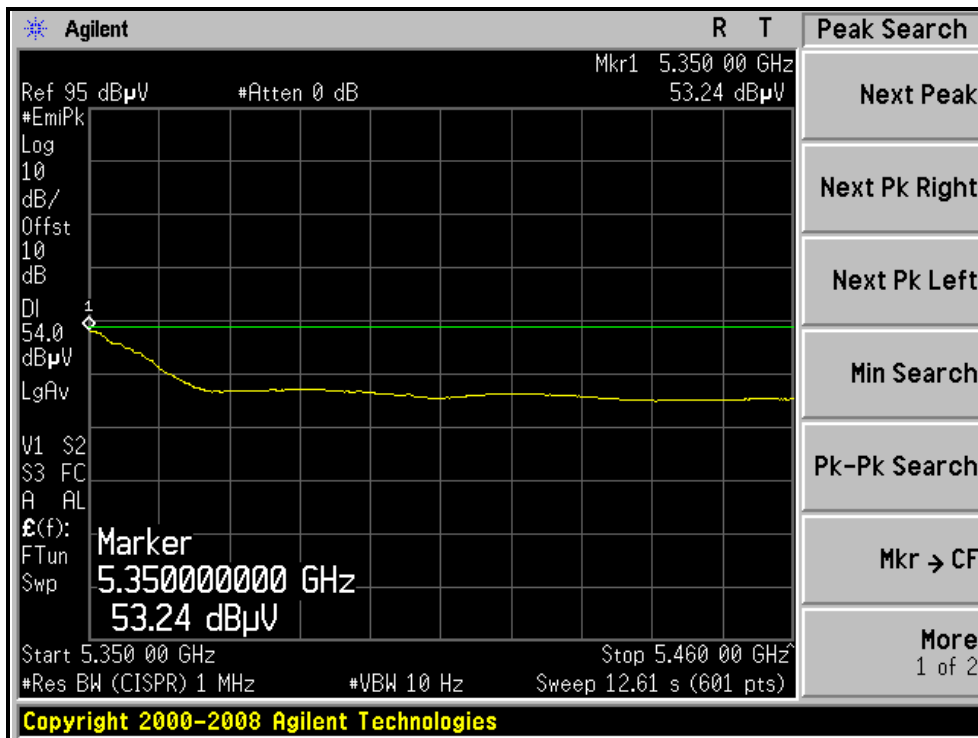
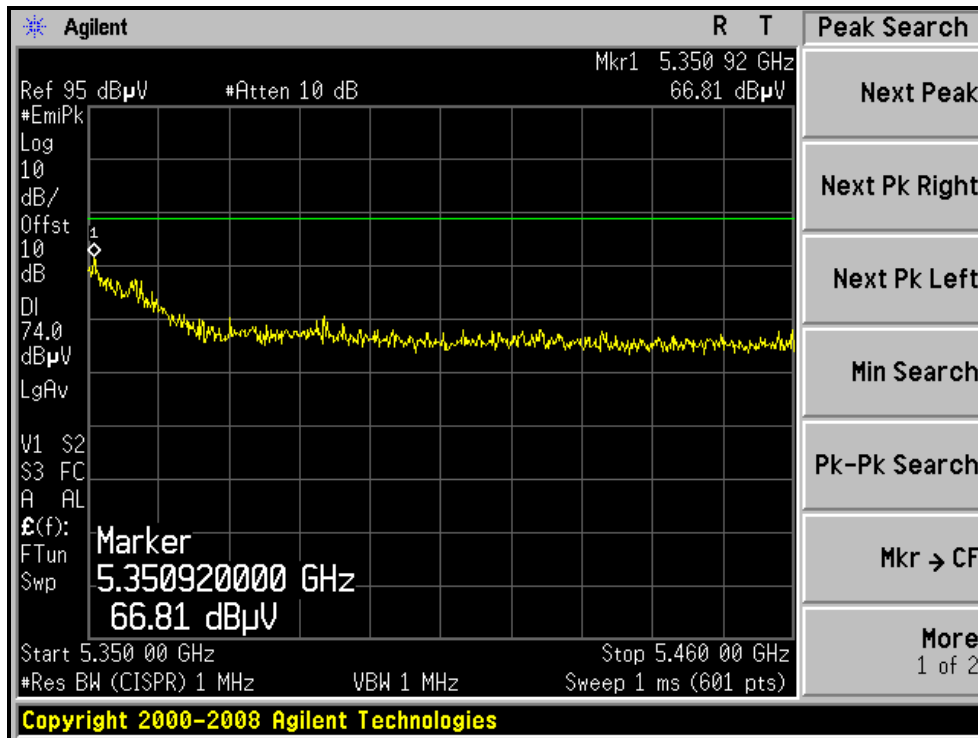



A D T

RESTRICTED BANDEDGE (802.11a MODE, CH100, HORIZONTAL)

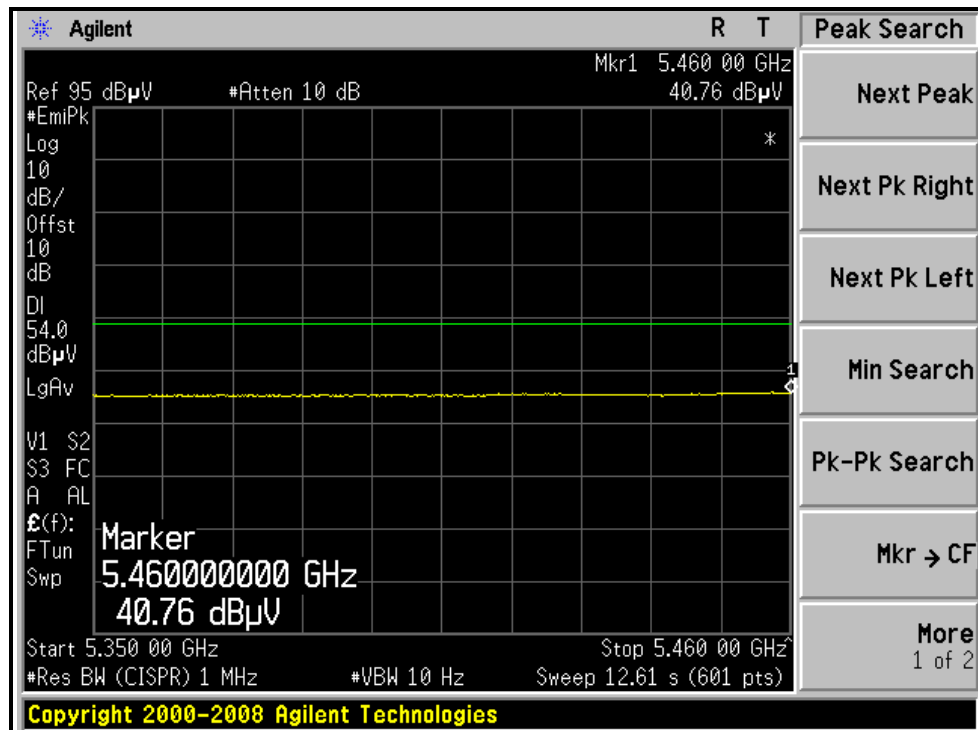
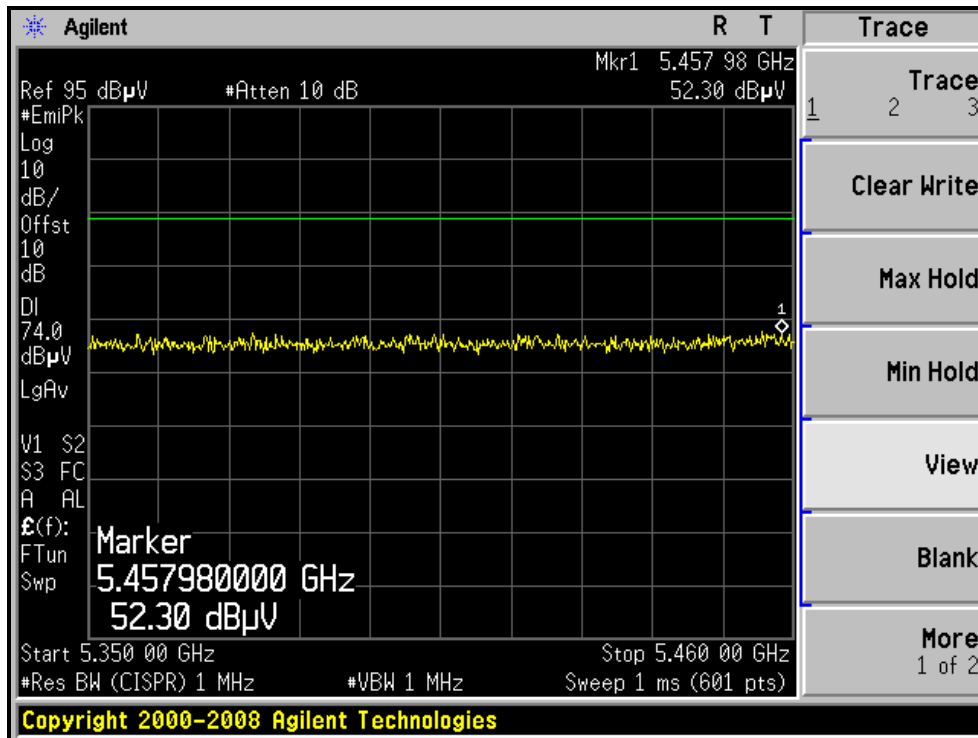



A D T

RESTRICTED BANDEDGE (802.11a MODE, CH100, VERTICAL)

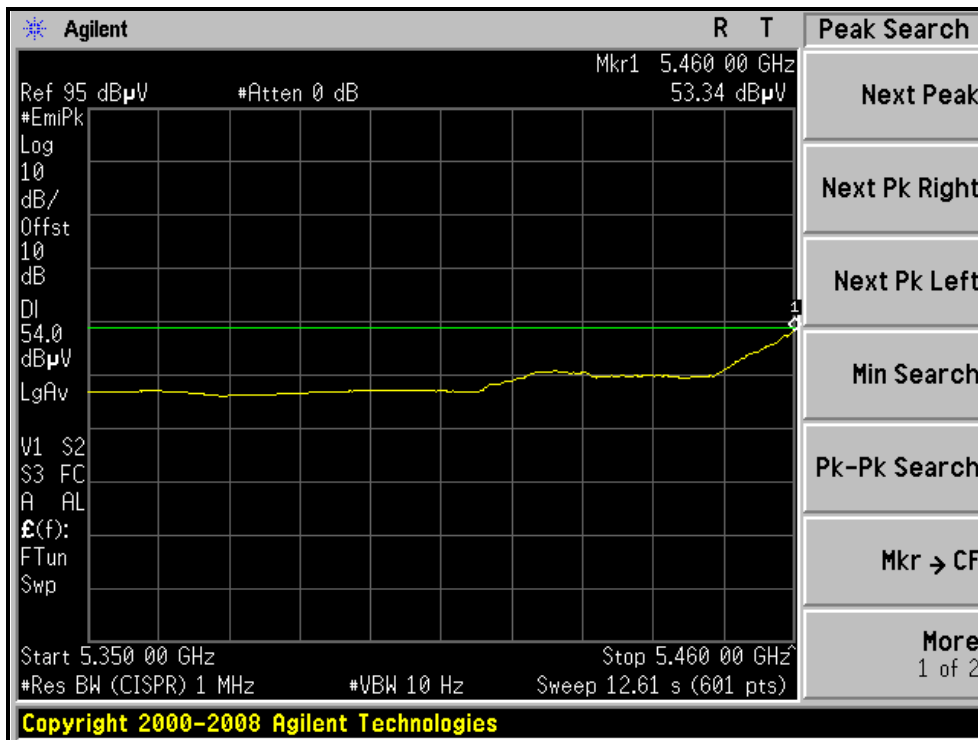
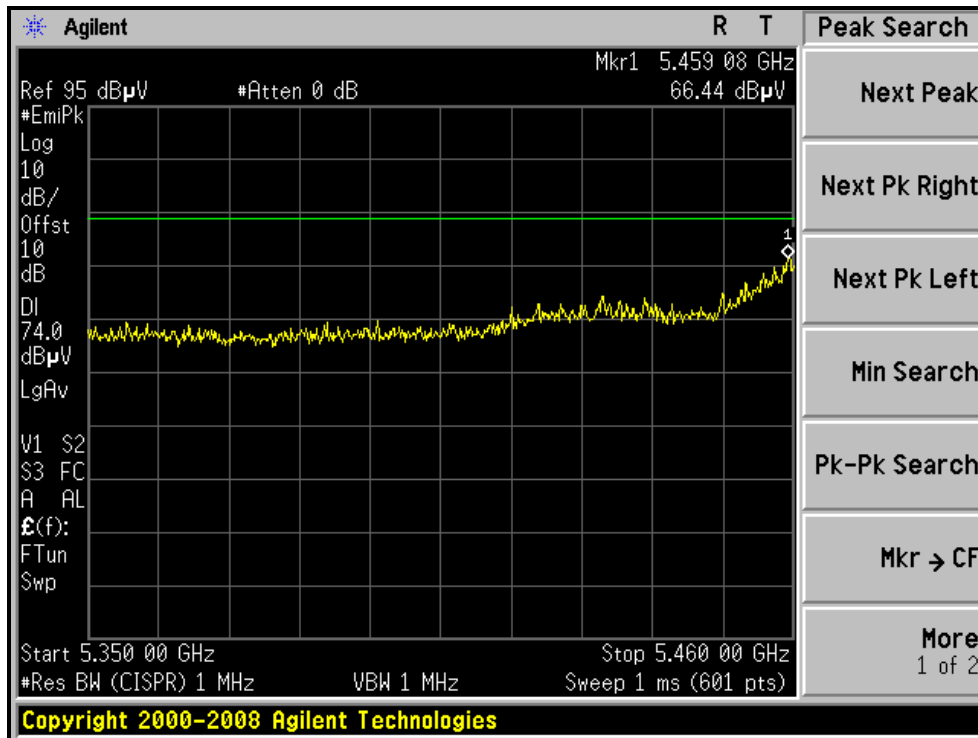

4.2 PEAK TRANSMIT POWER MEASUREMENT

4.2.1 LIMITS OF PEAK TRANSMIT POWER MEASUREMENT

Frequency Band	Limit
5.15 – 5.25GHz	The lesser of 50mW (17dBm) or 4dBm + 10logB
5.25 – 5.35GHz	The lesser of 250mW (24dBm) or 11dBm + 10logB
5.47 – 5.725GHz	The lesser of 250mW (24dBm) or 11dBm + 10logB
5.725 – 5.825GHz	The lesser of 1W (30dBm) or 17dBm + 10logB

NOTE: Where B is the 26dB emission bandwidth in MHz.

4.2.2 TEST INSTRUMENTS

DESCRIPTION & MANUFACTURER	MODEL NO.	SERIAL NO.	CALIBRATED DATE	CALIBRATED UNTIL
ADVANTEST SPECTRUM ANALYZER	U3772	160100280	Sep. 21, 2009	Sep. 20, 2010

NOTE:

1. The calibration interval of the above test instruments is 12 months and the calibrations are traceable to NML/ROC and NIST/USA.

4.2.3 TEST PROCEDURE

1. The transmitter output was connected to the spectrum analyzer.
2. Set span to encompass the entire emission bandwidth of the signal.
3. Set RBW to 1MHz, VBW to 300kHz.
4. Using the spectrum analyzer's channel power measurement function to measure the output power.

NOTE:

The test is performed in accordance with FCC Public Notice: APPENDIX A Guidelines for Assessing Unlicensed National Information Infrastructure (U-NII) Devices – Part 15, Subpart E, August 2002.

The transmitter output operates continuously therefore Method # 1 is used.

4.2.4 DEVIATION FROM TEST STANDARD

No deviation

4.2.5 TEST SETUP

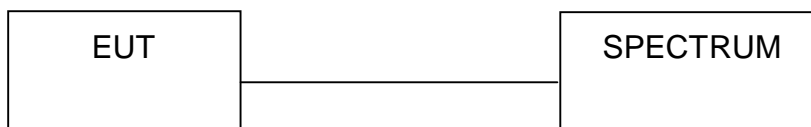

4.2.6 EUT OPERATING CONDITIONS

The software provided by client to enable the EUT under transmission condition continuously at specific channel frequencies individually.



A D T

4.2.7 TEST RESULTS

802.11a OFDM MODULATION:

CHANNEL	CHANNEL FREQUENCY (MHz)	PEAK POWER OUTPUT (dBm)	PEAK POWER OUTPUT (mW)	PEAK POWER LIMIT (dBm)	PASS/FAIL
36	5180	13.12	20.5	17	PASS
48	5240	13.27	21.2	17	PASS
52	5260	13.94	24.8	24	PASS
64	5320	13.38	21.8	24	PASS
100	5500	15.36	34.4	24	PASS
120	5600	15.15	32.7	24	PASS
140	5700	15.14	32.7	24	PASS



A D T

Peak Power Output: CH48

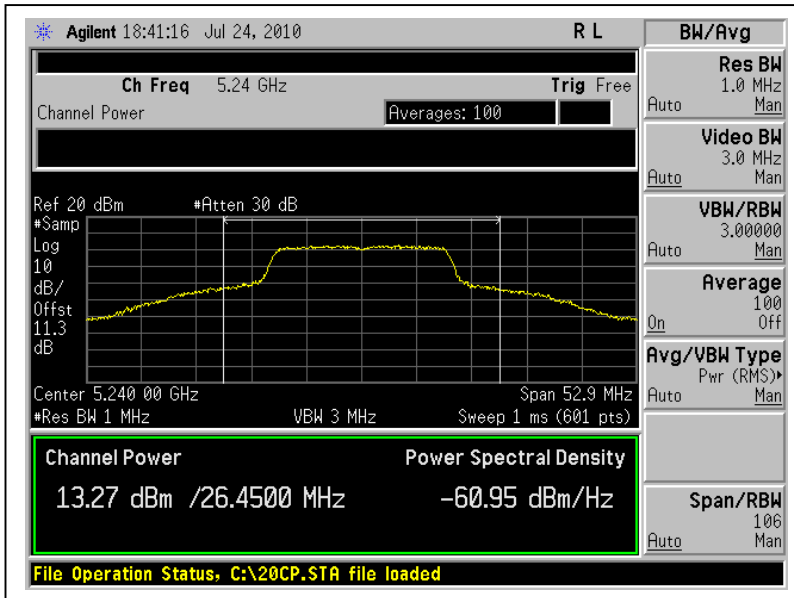

CH52

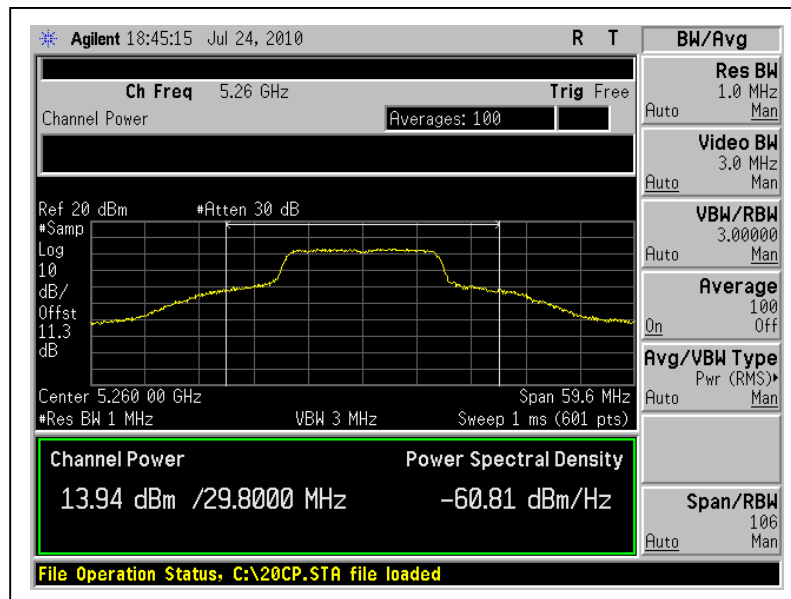



A D T

CH100

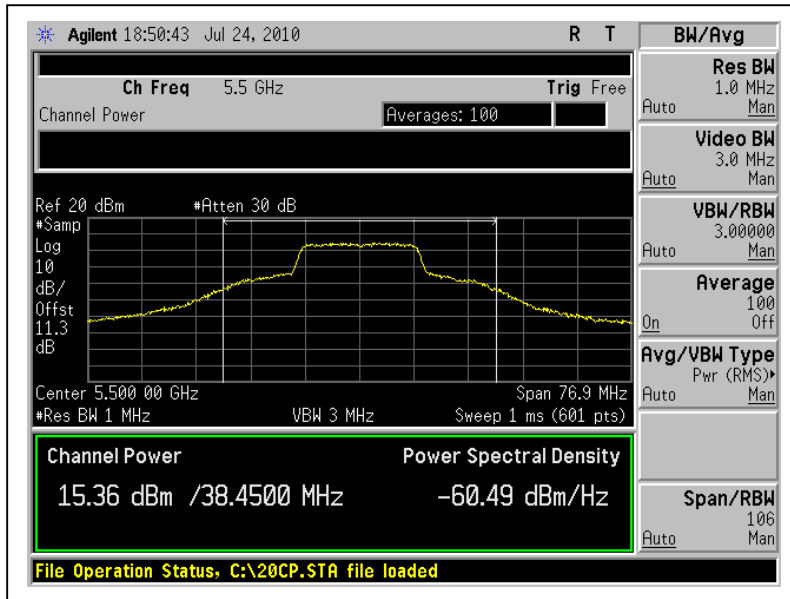



5. INFORMATION ON THE TESTING LABORATORIES

We, Bureau Veritas Consumer Products Services (H.K.) Ltd., Taoyuan Branch, were founded in 1988 to provide our best service in EMC, Radio, Telecom and Safety consultation. Our laboratories are accredited and approved according to ISO/IEC 17025:

Copies of accreditation certificates of our laboratories obtained from approval agencies can be downloaded from our web site: www.adt.com.tw/index.5/phtml. If you have any comments, please feel free to contact us at the following:

Linko EMC/RF Lab:

Tel: 886-2-26052180

Fax: 886-2-26052943

Hsin Chu EMC/RF Lab:

Tel: 886-3-5935343

Fax: 886-3-5935342

Hwa Ya EMC/RF/Safety Telecom Lab:

Tel: 886-3-3183232

Fax: 886-3-3185050

Web Site: www.adt.com.tw

The address and road map of all our labs can be found in our web site also



A D T

6.APPENDIX-A- MODIFICATIONS RECORDERS FOR ENGINEERING CHANGES TO THE EUT BY THE LAB

No any modifications are made to the EUT by the lab during the test.

---END---