



FCC TEST REPORT (15.407)

REPORT NO.: RF960622H01

MODEL NO.: LA-5137A2

RECEIVED: July 02, 2007

TESTED: July 05 to 10, 2007

ISSUED: July 12, 2007

APPLICANT: Symbol Technologies Inc.

ADDRESS: One Symbol Plaza, Holtsville, NY 11742- 1300
U.S.A.

ISSUED BY: Advance Data Technology Corporation

TEST LOCATION: No. 81-1, Lu Liao Keng, 9 Ling, Wu Lung
Tsuen, Chiung Lin Hsiang, Hsin Chu Hsien,
Taiwan, R.O.C.

This test report consists of 75 pages in total. It may be duplicated completely for legal use with the approval of the applicant. It should not be reproduced except in full, without the written approval of our laboratory. The client should not use it to claim product endorsement by TAF, A2LA or any government agencies. The test results in the report only apply to the tested sample.



No. 2177-01

Table of Contents

| | | |
|-------|---|----|
| 1. | CERTIFICATION | 4 |
| 2. | SUMMARY OF TEST RESULTS | 5 |
| 2.1 | MEASUREMENT UNCERTAINTY | 6 |
| 3. | GENERAL INFORMATION | 7 |
| 3.1 | GENERAL DESCRIPTION OF EUT | 7 |
| 3.2 | DESCRIPTION OF TEST MODES | 9 |
| 3.2.1 | TEST MODE APPLICABILITY AND TESTED CHANNEL DETAIL: | 10 |
| 3.3 | GENERAL DESCRIPTION OF APPLIED STANDARDS | 12 |
| 3.4 | DESCRIPTION OF SUPPORT UNITS | 13 |
| 3.5 | CONFIGURATION OF SYSTEM UNDER TEST | 13 |
| 4. | TEST TYPES AND RESULTS | 14 |
| 4.1 | CONDUCTED EMISSION MEASUREMENT | 14 |
| 4.1.1 | LIMITS OF CONDUCTED EMISSION MEASUREMENT | 14 |
| 4.1.2 | TEST INSTRUMENTS | 14 |
| 4.1.3 | TEST PROCEDURES | 15 |
| 4.1.4 | DEVIATION FROM TEST STANDARD | 15 |
| 4.1.5 | TEST SETUP | 16 |
| 4.1.6 | EUT OPERATING CONDITIONS | 16 |
| 4.1.7 | TEST RESULTS | 17 |
| 4.2 | RADIATED EMISSION MEASUREMENT | 19 |
| 4.2.1 | LIMITS OF RADIATED EMISSION MEASUREMENT | 19 |
| 4.2.2 | LIMITS OF UNWANTED EMISSION OUT OF THE RESTRICTED BANDS | 20 |
| 4.2.3 | TEST INSTRUMENTS | 21 |
| 4.2.4 | TEST PROCEDURES | 22 |
| 4.2.5 | DEVIATION FROM TEST STANDARD | 22 |
| 4.2.6 | TEST SETUP | 23 |
| 4.2.7 | EUT OPERATING CONDITION | 23 |
| 4.2.8 | TEST RESULTS | 24 |
| 4.3 | PEAK TRANSMIT POWER MEASUREMENT | 38 |
| 4.3.1 | LIMITS OF PEAK TRANSMIT POWER MEASUREMENT | 38 |
| 4.3.2 | TEST INSTRUMENTS | 38 |
| 4.3.3 | TEST PROCEDURE | 39 |
| 4.3.4 | DEVIATION FROM TEST STANDARD | 39 |
| 4.3.5 | TEST SETUP | 39 |
| 4.3.6 | EUT OPERATING CONDITIONS | 39 |
| 4.3.7 | TEST RESULTS | 40 |
| 4.4 | PEAK POWER EXCURSION MEASUREMENT | 49 |



| | | |
|-------|---|----|
| 4.4.1 | LIMITS OF PEAK POWER EXCURSION MEASUREMENT | 49 |
| 4.4.2 | TEST INSTRUMENTS | 49 |
| 4.4.3 | TEST PROCEDURE | 50 |
| 4.4.4 | DEVIATION FROM TEST STANDARD | 50 |
| 4.4.5 | TEST SETUP | 50 |
| 4.4.6 | EUT OPERATING CONDITIONS | 50 |
| 4.4.7 | TEST RESULTS | 51 |
| 4.5 | PEAK POWER SPECTRAL DENSITY MEASUREMENT | 55 |
| 4.5.1 | LIMITS OF PEAK POWER SPECTRAL DENSITY MEASUREMENT | 55 |
| 4.5.2 | TEST INSTRUMENTS | 55 |
| 4.5.3 | TEST PROCEDURES | 56 |
| 4.5.4 | DEVIATION FROM TEST STANDARD | 56 |
| 4.5.5 | TEST SETUP | 56 |
| 4.5.6 | EUT OPERATING CONDITIONS | 56 |
| 4.5.7 | TEST RESULTS | 57 |
| 4.6 | FREQUENCY STABILITY | 61 |
| 4.6.1 | LIMITS OF FREQUENCY STABILITY MEASUREMENT | 61 |
| 4.6.2 | TEST INSTRUMENTS | 61 |
| 4.6.3 | TEST PROCEDURE | 61 |
| 4.6.4 | DEVIATION FROM TEST STANDARD | 62 |
| 4.6.5 | TEST SETUP | 62 |
| 4.6.6 | EUT OPERATING CONDITION | 62 |
| 4.6.7 | TEST RESULTS | 63 |
| 4.7 | BAND EDGES MEASUREMENT | 64 |
| 4.7.1 | TEST INSTRUMENTS | 64 |
| 4.7.2 | TEST PROCEDURE | 64 |
| 4.7.3 | EUT OPERATING CONDITION | 64 |
| 4.7.4 | TEST RESULTS | 65 |
| 4.8 | ANTENNA REQUIREMENT | 73 |
| 4.8.1 | STANDARD APPLICABLE | 73 |
| 4.8.2 | ANTENNA CONNECTED CONSTRUCTION | 73 |
| 5. | INFORMATION ON THE TESTING LABORATORIES | 74 |
| 6. | APPENDIX-A MODIFICATIONS RECORDERS FOR ENGINEERING CHANGES TO THE EUT BY THE LAB | 75 |



1. CERTIFICATION

PRODUCT: 802.11a/b/g Compact Flash Radio Card
BRAND NAME: Symbol Technologies Inc.
MODEL NO.: LA-5137A2
TEST SAMPLE: ENGINEERING SAMPLE
TESTED: July 05 to 10, 2007
APPLICANT: Symbol Technologies Inc.
STANDARDS: FCC Part 15, Subpart E (Section 15.407)
ANSI C63.4-2003

The above equipment (Model: LA-5137A2) has been tested by **Advance Data Technology Corporation**, and found compliance with the requirement of the above standards. The test record, data evaluation & Equipment Under Test (EUT) configurations represented herein are true and accurate accounts of the measurements of the sample's EMC characteristics under the conditions specified in this report.

PREPARED BY : Claire Kuan , **DATE:** July 12, 2007
(Claire Kuan, Specialist)

TECHNICAL ACCEPTANCE : Hank Chung , **DATE:** July 12, 2007
Responsible for RF (Hank Chung, Deputy Manager)

APPROVED BY : May Chen , **DATE:** July 12, 2007
(May Chen, Deputy Manager)

2. SUMMARY OF TEST RESULTS

The EUT has been tested according to the following specifications:

| APPLIED STANDARD: FCC Part 15, Subpart E (Section 15.407) | | | |
|--|--|---------------|--|
| Standard Section | Test Type | Result | Remark |
| 15.407(b)(5) | AC Power Conducted Emission | PASS | Meet the requirement of limit. Minimum passing margin is -19.66dB at 0.162MHz |
| 15.407(b/1/2/3) (b)(5) | Electric Field Strength Spurious Emissions, 30MHz ~ 40000MHz | PASS | Meet the requirement of limit. Minimum passing margin is -2.00dB at 11200.00MHz |
| 15.407(a/1/2/3) | Peak Transmit Power | PASS | Meet the requirement of limit. |
| 15.407(a)(6) | Peak Power Excursion | PASS | Meet the requirement of limit. |
| 15.407(a/1/2/3) | Peak Power Spectral Density | PASS | Meet the requirement of limit. |
| 15.407(g) | Frequency Stability | PASS | Meet the requirement of limit. |

NOTE:

1. The EUT was operating in 2.412 ~ 2.462GHz, 5.15~5.35GHz, 5.47~5.725GHz and 5.725~5.850GHz frequencies band. This report was recorded the RF parameters including 5.15~5.35GHz and 5.47~5.725GHz. For the 2.412 ~ 2.462GHz and 5.725 ~ 5.850GHz RF parameters was recorded in another test report.

2.1 MEASUREMENT UNCERTAINTY

Where relevant, the following measurement uncertainty levels have been estimated for tests performed on the EUT as specified in CISPR 16-4:

This uncertainty represents an expanded uncertainty expressed at approximately the 95% confidence level using a coverage factor of k=2.

| Measurement | Value |
|-----------------------------------|--------------|
| Conducted emissions | 2.41 dB |
| Radiated emissions (30MHz-1GHz) | 3.89 dB |
| Radiated emissions (1GHz -18GHz) | 2.21 dB |
| Radiated emissions (18GHz -40GHz) | 1.88 dB |

3. GENERAL INFORMATION

3.1 GENERAL DESCRIPTION OF EUT

| | |
|------------------------------|---|
| EUT | 802.11a/b/g Compact Flash Radio Card |
| MODEL NO. | LA-5137A2 |
| FCC ID | H9PLA5137A2 |
| POWER SUPPLY | DC 3.3 V +/-5% from host equipment |
| MODULATION TYPE | CCK, DQPSK, DBPSK for DSSS 64QAM, 16QAM, QPSK, BPSK for OFDM |
| MODULATION TECHNOLOGY | DSSS, OFDM |
| TRANSFER RATE | 802.11b: 11/5.5/2/1Mbps 802.11g: 54/48/36/24/18/12/9/6Mbps 802.11a: 54/48/36/24/18/12/9/6Mbps |
| FREQUENCY RANGE | For 15.407 802.11a: 5.18 ~ 5.32GHz and 5.50 ~ 5.70GHz |
| | For 15.247 802.11b & 802.11g: 2412 ~ 2462MHz 802.11a: 5.745 ~ 5.825GHz |
| NUMBER OF CHANNEL | For 15.407 802.11a (5.15 ~ 5.35GHz): 8 802.11a (5.47 ~ 5.725GHz): 11 |
| | For 15.247 802.11b & 802.11g: 11 802.11a (5.725 ~ 5.850GHz): 5 |
| CHANNEL SPACING | 802.11b & 802.11g: 5MHz 802.11a: 20MHz |
| OUTPUT POWER | For 802.11b: 87.096mW For 802.11g: 100.000mW For 802.11a (FCC15.247): 66.069mW For 802.11a (FCC15.407): 37.931mW |
| DATA CABLE | NA |
| ANTENNA TYPE | Please see note 2 (on next page) |
| ASSOCIATED DEVICES | NA |

NOTE:

1. The EUT operates in both the 5GHz and 2.4GHz Bands and compatibility with 802.11a and 802.11b, 802.11g technology.
2. There is one antenna provided to this EUT, please refer to the following table:

| Brand Name | Model No. | Gain (dBi) | Antenna Type | Connector |
|------------|-----------|----------------------------|-----------------|-----------|
| Tyco | 1513671-1 | 2.4GHz: 1.58 5GHz: 2.78 | Printed Antenna | NA |

3. The above EUT information was declared by the manufacturer and for more detailed features description, please refer to the manufacturer's specifications or User's Manual.

3.2 DESCRIPTION OF TEST MODES

Operated in 5150MHz ~ 5350MHz bands:

Eight channels are provided to this EUT.

| Channel | Frequency |
|---------|-----------|
| 1 | 5180 MHz |
| 2 | 5200 MHz |
| 3 | 5220 MHz |
| 4 | 5240 MHz |
| 5 | 5260 MHz |
| 6 | 5280 MHz |
| 7 | 5300 MHz |
| 8 | 5320 MHz |

Operated in 5470MHz ~ 5725MHz bands:

Eleven channels are provided to this EUT.

| Channel | Frequency |
|---------|-----------|
| 9 | 5500 MHz |
| 10 | 5520 MHz |
| 11 | 5540 MHz |
| 12 | 5560 MHz |
| 13 | 5580 MHz |
| 14 | 5600 MHz |
| 15 | 5620 MHz |
| 16 | 5640 MHz |
| 17 | 5660 MHz |
| 18 | 5680 MHz |
| 19 | 5700 MHz |

3.2.1 TEST MODE APPLICABILITY AND TESTED CHANNEL DETAIL:

| EUT configure mode | Applicable to | | | | Description |
|--------------------|---------------|-------|-------|------|-------------|
| | PLC | RE<1G | RE≥1G | APCM | |
| - | √ | √ | √ | √ | NA |

Where PLC: Power Line Conducted Emission RE<1G RE: Radiated Emission below 1GHz
 RE≥1G: Radiated Emission above 1GHz APCM: Antenna Port Conducted Measurement

Power Line Conducted Emission Test:

- Pre-Scan has been conducted to determine the worst-case mode from all possible combinations between available modulations, data rates and antenna ports (if EUT with antenna diversity architecture).
- Following channel(s) was (were) selected for the final test as listed below.

| Mode | Available Channel | Tested Channel | Modulation Technology | Modulation Type | Data Rate (Mbps) |
|---------|-------------------|----------------|-----------------------|-----------------|------------------|
| 802.11a | 1 to 19 | 1 | OFDM | BPSK | 6 |

Radiated Emission Test (Below 1 GHz):

- Pre-Scan has been conducted to determine the worst-case mode from all possible combinations between available modulations, data rates and antenna ports (if EUT with antenna diversity architecture).
- Following channel(s) was (were) selected for the final test as listed below.

| Mode | Available Channel | Tested Channel | Modulation Technology | Modulation Type | Data Rate (Mbps) |
|---------|-------------------|----------------|-----------------------|-----------------|------------------|
| 802.11a | 1 to 19 | 1 | OFDM | BPSK | 6 |

Radiated Emission Test (Above 1 GHz):

- Pre-Scan has been conducted to determine the worst-case mode from all possible combinations between available modulations, data rates and antenna ports (if EUT with antenna diversity architecture).
- Following channel(s) was (were) selected for the final test as listed below.

| Mode | Available Channel | Tested Channel | Modulation Technology | Modulation Type | Data Rate (Mbps) |
|---------|-------------------|-----------------------|-----------------------|-----------------|------------------|
| 802.11a | 1 to 19 | 1, 4, 5, 8, 9, 14, 19 | OFDM | BPSK | 6 |

Bandedge Measurement:

- Pre-Scan has been conducted to determine the worst-case mode from all possible combinations between available modulations, data rates and antenna ports (if EUT with antenna diversity architecture).
- Following channel(s) was (were) selected for the final test as listed below.

| Mode | Available Channel | Tested Channel | Modulation Technology | Modulation Type | Data Rate (Mbps) |
|---------|-------------------|----------------|-----------------------|-----------------|------------------|
| 802.11a | 1 to 19 | 1, 8, 9, 19 | OFDM | BPSK | 6 |

Antenna Port Conducted Measurement:

- Pre-Scan has been conducted to determine the worst-case mode from all possible combinations between available modulations, data rates and antenna ports (if EUT with antenna diversity architecture).
- Following channel(s) was (were) selected for the final test as listed below.

| Mode | Available Channel | Tested Channel | Modulation Technology | Modulation Type | Data Rate (Mbps) |
|---------|-------------------|-----------------------|-----------------------|-----------------|------------------|
| 802.11a | 1 to 19 | 1, 4, 5, 8, 9, 14, 19 | OFDM | BPSK | 6 |



3.3 GENERAL DESCRIPTION OF APPLIED STANDARDS

The EUT is an 802.11a/b/g Compact Flash Radio Card and 802.11a/b/g Compact Flash Radio Card. According to the specifications of the manufacturer, it must comply with the requirements of the following standards:

FCC Part 15, Subpart E (15.407)

ANSI C63.4-2003

All test items have been performed and recorded as per the above standards.

3.4 DESCRIPTION OF SUPPORT UNITS

The EUT has been tested as an independent unit together with other necessary accessories or support units. The following support units or accessories were used to form a representative test configuration during the tests.

| No. | Product | Brand | Model No. | Serial No. | FCC ID |
|-----|-------------------|-------|-----------|------------|---------|
| 1 | NOTEBOOK COMPUTER | ASUS | A2400H | 49NG038481 | FCC DoC |
| 2 | PCMCIA Ext Card | USI | NA | NA | NA |
| 3 | CF to PCMCIA Card | USI | NA | NA | NA |

| No. | Signal cable description |
|-----|--------------------------|
| 1 | NA |
| 2 | NA |
| 3 | NA |

NOTE: All power cords of the above support units are non shielded (1.8m).

3.5 CONFIGURATION OF SYSTEM UNDER TEST

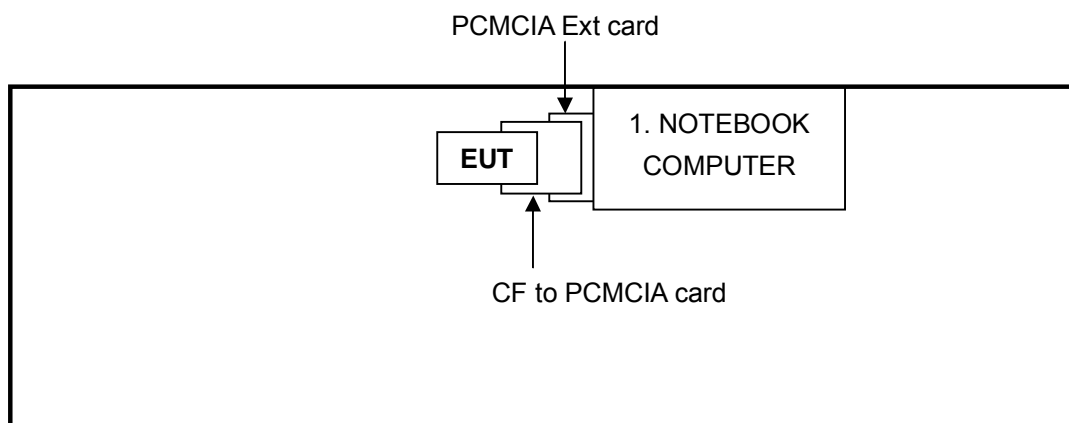

4. TEST TYPES AND RESULTS

4.1 CONDUCTED EMISSION MEASUREMENT

4.1.1 LIMITS OF CONDUCTED EMISSION MEASUREMENT

| FREQUENCY OF EMISSION (MHz) | CONDUCTED LIMIT (dB μ V) | |
|-----------------------------|------------------------------|----------|
| | Quasi-peak | Average |
| 0.15-0.5 | 66 to 56 | 56 to 46 |
| 0.5-5 | 56 | 46 |
| 5-30 | 60 | 50 |

- NOTE:**
1. The lower limit shall apply at the transition frequencies.
 2. The limit decreases in line with the logarithm of the frequency in the range of 0.15 to 0.50 MHz.
 3. All emanations from a class A/B digital device or system, including any network of conductors and apparatus connected thereto, shall not exceed the level of field strengths specified above.

4.1.2 TEST INSTRUMENTS

| DESCRIPTION & MANUFACTURER | MODEL NO. | SERIAL NO. | CALIBRATED UNTIL |
|--|-----------------|-------------|------------------|
| Test Receiver | ESCS 30 | 847124/029 | Mar. 01, 2008 |
| Line-Impedance Stabilization Network(for EUT) | ENV-216 | 100071 | Nov. 26, 2007 |
| Line-Impedance Stabilization Network(for Peripheral) | ESH3-Z5 | 848773/004 | Oct. 26, 2007 |
| RF Cable (JETBAO) | RG233/U | Cable_CB_01 | Dec. 09, 2007 |
| Terminator | 50 | 2 | Oct. 30, 2007 |
| Software | ADT_Cond_V7.3.2 | NA | NA |

- NOTE:**
1. The calibration interval of the above test instruments is 12 months and the calibrations are traceable to NML/ROC and NIST/USA.
 2. The test was performed in ADT Shielded Room No. B.
 3. The VCCI Con B Registration No. is C-2193.

4.1.3 TEST PROCEDURES

- a. The EUT was placed 0.4 meters from the conducting wall of the shielded room with EUT being connected to the power mains through a line impedance stabilization network (LISN). Other support units were connected to the power mains through another LISN. The two LISNs
- b. provide 50 ohm/ 50uH of coupling impedance for the measuring instrument.
- c. Both lines of the power mains connected to the EUT were checked for maximum conducted interference.
- d. The frequency range from 150kHz to 30MHz was searched. Emission level under (Limit – 20dB) was not recorded.

4.1.4 DEVIATION FROM TEST STANDARD

No deviation

4.1.5 TEST SETUP

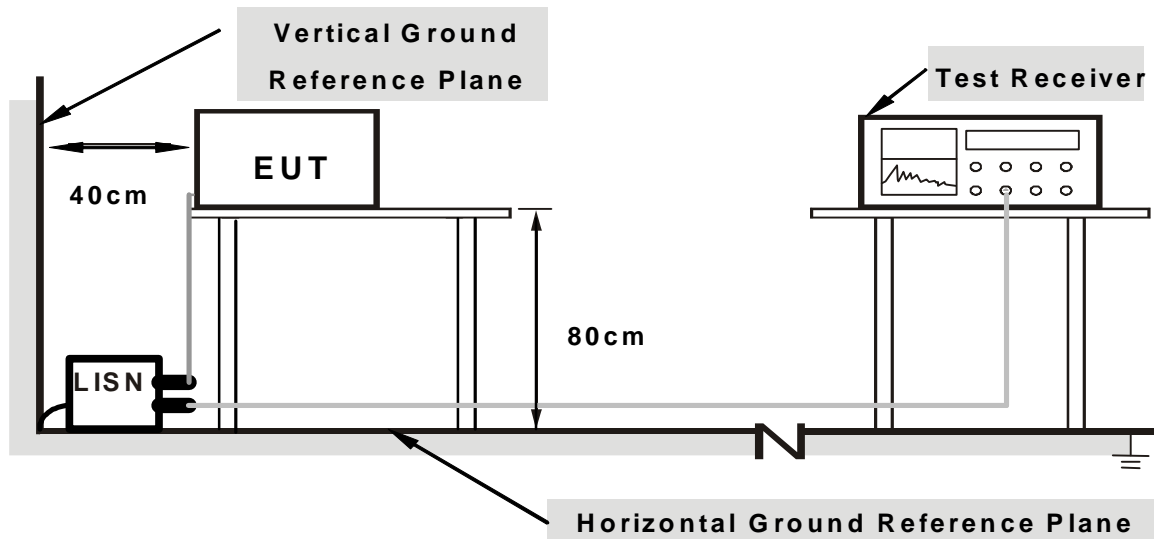

Note: 1. Support units were connected to second LISN.

2. Both of LISNs (AMN) are 80 cm from EUT and at least 80 from other units and other metal planes

For the actual test configuration, please refer to the related item – Photographs of the Test Configuration.

4.1.6 EUT OPERATING CONDITIONS

1. Connect the EUT with the support unit 1 (Notebook computer) and placed it on the testing table.
2. The support unit 1 (Notebook computer) ran a test program “cTxRx 3.0.1.1” to enable EUT under transmission condition continuously.

4.1.7 TEST RESULTS

Conducted Worst-Case Data

| | | | |
|---------------------------------|-------------------------|----------------------|----------|
| MODULATION TYPE | BPSK | 6dB BANDWIDTH | 9 kHz |
| INPUT POWER (SYSTEM) | 120Vac, 60 Hz | TRANSFER RATE | 6Mbps |
| ENVIRONMENTAL CONDITIONS | 26deg. C, 58%RH, 960hPa | PHASE | Line (L) |
| TESTED BY | Wen Yeh | | |

| No | Freq. [MHz] | Corr. Factor (dB) | Reading Value [dB (uV)] | | Emission Level [dB (uV)] | | Limit [dB (uV)] | | Margin (dB) | |
|----|----------------|-------------------------|----------------------------|-------|-----------------------------|-------|--------------------|-------|----------------|--------|
| | | | Q.P. | AV. | Q.P. | AV. | Q.P. | AV. | Q.P. | AV. |
| | 1 | 0.162 | 0.40 | 41.89 | - | 42.29 | - | 65.38 | 55.38 | -23.09 |
| 2 | 0.189 | 0.40 | 38.24 | - | 38.64 | - | 64.08 | 54.08 | -25.44 | - |
| 3 | 0.281 | 0.40 | 31.41 | - | 31.81 | - | 60.79 | 50.79 | -28.98 | - |
| 4 | 0.880 | 0.40 | 29.76 | - | 30.16 | - | 56.00 | 46.00 | -25.84 | - |
| 5 | 1.271 | 0.43 | 31.62 | - | 32.05 | - | 56.00 | 46.00 | -23.95 | - |
| 6 | 2.345 | 0.52 | 27.78 | - | 28.30 | - | 56.00 | 46.00 | -27.70 | - |

- REMARKS:**
1. Q.P. and AV. are abbreviations of quasi-peak and average individually.
 2. "-": The Quasi-peak reading value also meets average limit and measurement with the average detector is unnecessary.
 3. The emission levels of other frequencies were very low against the limit.
 4. Margin value = Emission level - Limit value
 5. Correction factor = Insertion loss + Cable loss
 6. Emission Level = Correction Factor + Reading Value.

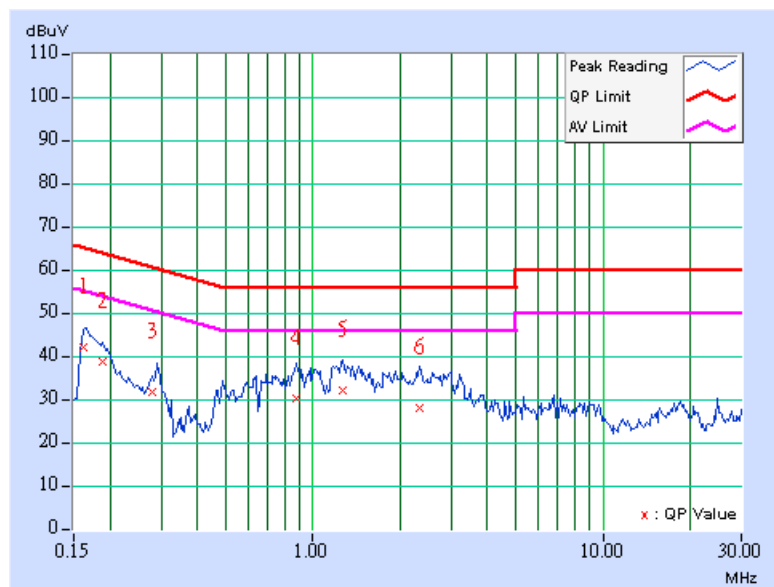

| | | | |
|---------------------------------|-------------------------|----------------------|-------------|
| MODULATION TYPE | BPSK | 6dB BANDWIDTH | 9 kHz |
| INPUT POWER (SYSTEM) | 120Vac, 60 Hz | TRANSFER RATE | 6Mbps |
| ENVIRONMENTAL CONDITIONS | 26deg. C, 58%RH, 960hPa | PHASE | Neutral (N) |
| TESTED BY | Wen Yeh | | |

| No | Freq. [MHz] | Corr. Factor (dB) | Reading Value [dB (uV)] | | Emission Level [dB (uV)] | | Limit [dB (uV)] | | Margin (dB) | |
|----|----------------|-------------------------|----------------------------|-------|-----------------------------|-------|--------------------|-------|----------------|-------|
| | | | Q.P. | AV. | Q.P. | AV. | Q.P. | AV. | Q.P. | AV. |
| | | | 1 | 0.162 | 0.20 | 45.52 | - | 45.72 | - | 65.38 |
| 2 | 0.189 | 0.20 | 39.98 | - | 40.18 | - | 64.08 | 54.08 | -23.90 | - |
| 3 | 0.295 | 0.20 | 34.95 | - | 35.15 | - | 60.40 | 50.40 | -25.25 | - |
| 4 | 1.740 | 0.37 | 27.03 | - | 27.40 | - | 56.00 | 46.00 | -28.60 | - |
| 5 | 2.619 | 0.43 | 26.00 | - | 26.43 | - | 56.00 | 46.00 | -29.57 | - |
| 6 | 2.923 | 0.45 | 25.37 | - | 25.82 | - | 56.00 | 46.00 | -30.18 | - |

- REMARKS:**
1. Q.P. and AV. are abbreviations of quasi-peak and average individually.
 2. "-": The Quasi-peak reading value also meets average limit and measurement with the average detector is unnecessary.
 3. The emission levels of other frequencies were very low against the limit.
 4. Margin value = Emission level - Limit value
 5. Correction factor = Insertion loss + Cable loss
 6. Emission Level = Correction Factor + Reading Value.

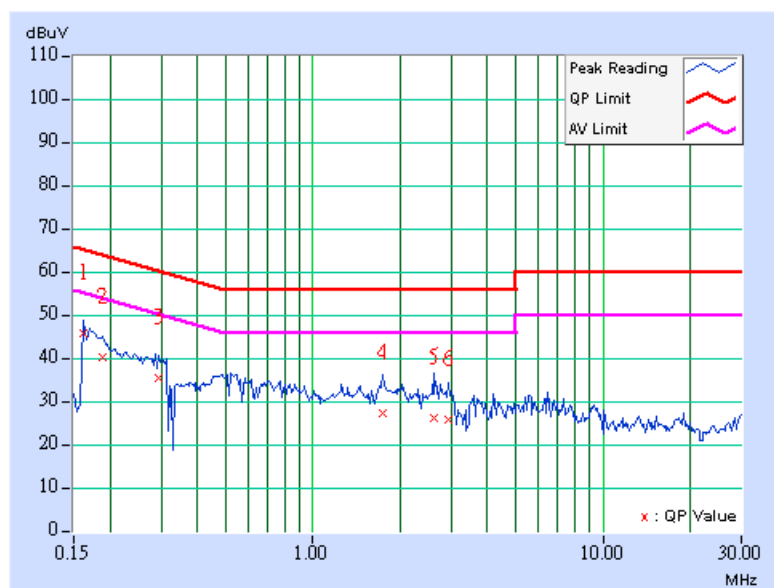

4.2 RADIATED EMISSION MEASUREMENT

4.2.1 LIMITS OF RADIATED EMISSION MEASUREMENT

Emissions radiated outside of the specified bands, shall be according to the general radiated limits in 15.209 as following:

| Frequencies (MHz) | Field strength (microvolts/meter) | Measurement distance (meters) |
|-------------------|-----------------------------------|-------------------------------|
| 0.009-0.490 | 2400/F(kHz) | 300 |
| 0.490-1.705 | 24000/F(kHz) | 30 |
| 1.705-30.0 | 30 | 30 |
| 30-88 | 100 | 3 |
| 88-216 | 150 | 3 |
| 216-960 | 200 | 3 |
| Above 960 | 500 | 3 |

NOTE:

1. The lower limit shall apply at the transition frequencies.
2. Emission level (dBuV/m) = 20 log Emission level (uV/m).
3. As shown in 15.35(b), for frequencies above 1000MHz, the field strength limits are based on average detector, however, the peak field strength of any emission shall not exceed the maximum permitted average limits, specified above by more than 20dB under any condition of modulation.

4.2.2 LIMITS OF UNWANTED EMISSION OUT OF THE RESTRICTED BANDS

| Frequencies (MHz) | EIRP Limit (dBm) | Equivalent Field Strength at 3m (dBμV/m) *note 3 |
|-------------------|------------------|--|
| 5150~5250 | -27 | 68.3 |
| 5250~5350 | -27 | 68.3 |
| 5470~5725 | -27 | 68.3 |
| 5725~5825 | -27 *note 1 | 68.3 |
| | -17 *note 2 | 78.3 |

NOTE:

1. For frequencies 10MHz or greater above or below the band edge.
2. All emissions within the frequency range from the band edge to 10MHz above or below the band edge.
3. The following formula is used to convert the equipment isotropic radiated power (eirp) to field strength

$$E = \frac{1000000\sqrt{30P}}{3} \mu\text{V/m, where P is the eirp (Watts)}$$



4.2.3 TEST INSTRUMENTS

| DESCRIPTION & MANUFACTURER | MODEL NO. | SERIAL NO. | CALIBRATED UNTIL |
|----------------------------------|----------------------------|---------------------|------------------|
| ADVANTEST Spectrum Analyzer | R3271A | 85060311 | July 03, 2008 |
| HP Pre_Amplifier | 8449B | 3008A01922 | Sep. 18, 2007 |
| ROHDE & SCHWARZ Test Receiver | ESCS30 | 100375 | Sep. 20, 2007 |
| CHASE Broadband Antenna | VULB9168 | 138 | Dec. 10, 2007 |
| Schwarzbeck Horn_Antenna | BBHA9120 | D124 | Jan. 01, 2008 |
| Schwarzbeck Horn_Antenna | BBHA 9170 | BBHA9170153 | Jan. 04, 2008 |
| SCHWARZBECK Biconical Antenna | VHBA9123 | 459 | Jun. 08, 2009 |
| SCHWARZBECK Periodic Antenna | UPA6108 | 1148 | Jun. 08, 2009 |
| RF Switches (ARNITSU) | CS-201 | 1565157 | NA |
| RF CABLE (Chaintek) | SF102 | 22054-2 | Nov. 14. 2007 |
| RF Cable(RICHTEC) | 9913-30M N-N Cable | STCCAB-30M-1 GHz | Jul. 15, 2007 |
| Software | ADT_Radiated_V 7.6.15.7 | NA | NA |
| CHANCE MOST Antenna Tower | AT-100 | 0203 | NA |
| CHANCE MOST Turn Table | TT-100 | 0203 | NA |

- Note: 1. The calibration interval of the above test instruments is 12 months (36 months for Biconical and Periodic Antenna) and the calibrations are traceable to NML/ROC and NIST/USA.
2. The horn antenna, HP preamplifier (model: 8449B) and Spectrum Analyzer (model: R3271A) are used only for the measurement of emission frequency above 1GHz if tested.
3. The test was performed in ADT Open Site No. C.
4. The FCC Site Registration No. is 656396.
5. The VCCI Site Registration No. is R-1626.
6. The CANADA Site Registration No. is IC 4824A-3.

4.2.4 TEST PROCEDURES

- a. The EUT was placed on the top of a rotating table 0.8 meters above the ground at a 3 meter semi-anechoic chamber. The table was rotated 360 degrees to determine the position of the highest radiation.
- b. The EUT was set 3 meters away from the interference-receiving antenna, which was mounted on the top of a variable-height antenna tower.
- c. The antenna is a broadband antenna, and its height is varied from one meter to four meters above the ground to determine the maximum value of the field strength. Both horizontal and vertical polarizations of the antenna are set to make the measurement.
- d. For each suspected emission, the EUT was arranged to its worst case and then the antenna was tuned to heights from 1 meter to 4 meters and the rotatable table was turned from 0 degrees to 360 degrees to find the maximum reading.
- e. The test-receiver system was set to Peak Detect Function and Specified Bandwidth with Maximum Hold Mode.
- f. If the emission level of the EUT in peak mode was 10dB lower than the limit specified, then testing could be stopped and the peak values of the EUT would be reported. Otherwise the emissions that did not have 10dB margin would be re-tested one by one using peak, quasi-peak or average method as specified and then reported in a data sheet.

NOTE:

1. The resolution bandwidth and video bandwidth of test receiver/spectrum analyzer is 120kHz for Peak detection (PK) and Quasi-peak detection (QP) at frequency below 1GHz.
2. The resolution bandwidth of test receiver/spectrum analyzer is 1 MHz and the video bandwidth is 3 MHz for Peak detection (PK) at frequency above 1GHz.
3. The resolution bandwidth of test receiver/spectrum analyzer is 1 MHz and the video bandwidth is 10 Hz for Average detection (AV) at frequency above 1GHz.

4.2.5 DEVIATION FROM TEST STANDARD

No deviation

4.2.6 TEST SETUP

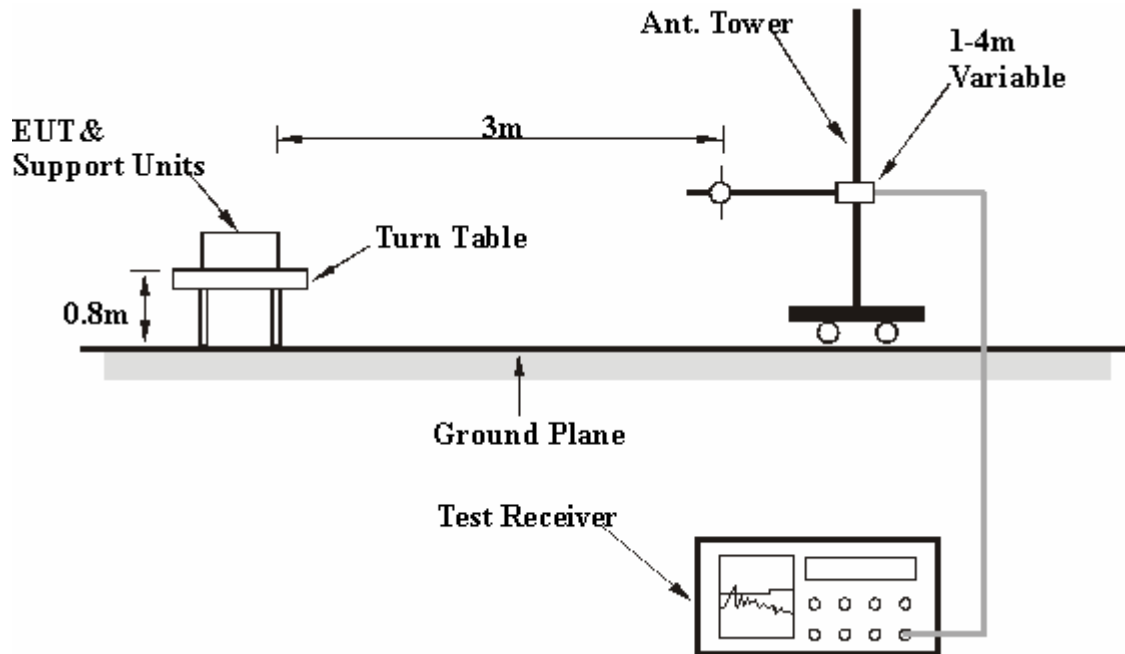

For the actual test configuration, please refer to the related item – Photographs of the Test Configuration.

4.2.7 EUT OPERATING CONDITION

Same as 4.1.6

4.2.8 TEST RESULTS

Below 1GHz Worst-Case Data

| | | | |
|---------------------------------|-------------------------|--------------------------|---------------|
| MODE | Channel 1 | FREQUENCY RANGE | Below 1000MHz |
| MODULATION TYPE | BPSK | TRANSFER RATE | 6Mbps |
| INPUT POWER (SYSTEM) | 120Vac, 60 Hz | DETECTOR FUNCTION | Quasi-Peak |
| ENVIRONMENTAL CONDITIONS | 21deg. C, 66%RH, 960hPa | TESTED BY | Phoenix Huang |

ANTENNA POLARITY & TEST DISTANCE: HORIZONTAL AT 3 M

| No. | Freq. (MHz) | Emission Level (dBuV/m) | Limit (dBuV/m) | Margin (dB) | Antenna Height (m) | Table Angle (Degree) | Raw Value (dBuV) | Correction Factor (dB/m) |
|-----|-------------|-------------------------|----------------|-------------|--------------------|----------------------|------------------|--------------------------|
| 1 | 67.45 | 32.52 QP | 40.00 | -7.48 | 1.12 H | 227 | 19.66 | 12.86 |
| 2 | 200.42 | 36.52 QP | 43.50 | -6.98 | 1.06 H | 325 | 24.90 | 11.62 |
| 3 | 279.95 | 38.54 QP | 46.00 | -7.46 | 1.04 H | 165 | 22.69 | 15.85 |
| 4 | 367.12 | 36.35 QP | 46.00 | -9.65 | 1.24 H | 249 | 18.41 | 17.94 |
| 5 | 499.98 | 34.15 QP | 46.00 | -11.85 | 1.41 H | 36 | 12.39 | 21.76 |
| 6 | 799.89 | 35.74 QP | 46.00 | -10.26 | 1.27 H | 145 | 8.18 | 27.56 |
| 7 | 880.04 | 40.32 QP | 46.00 | -5.68 | 1.05 H | 135 | 11.65 | 28.67 |
| 8 | 960.00 | 36.25 QP | 46.00 | -9.75 | 1.00 H | 360 | 6.36 | 29.89 |

ANTENNA POLARITY & TEST DISTANCE: VERTICAL AT 3 M

| No. | Freq. (MHz) | Emission Level (dBuV/m) | Limit (dBuV/m) | Margin (dB) | Antenna Height (m) | Table Angle (Degree) | Raw Value (dBuV) | Correction Factor (dB/m) |
|-----|-------------|-------------------------|----------------|-------------|--------------------|----------------------|------------------|--------------------------|
| 1 | 80.05 | 34.87 QP | 40.00 | -5.13 | 1.00 V | 175 | 24.74 | 10.13 |
| 2 | 200.27 | 31.56 QP | 43.50 | -11.94 | 1.00 V | 48 | 19.95 | 11.61 |
| 3 | 400.16 | 33.41 QP | 46.00 | -12.59 | 1.08 V | 248 | 14.39 | 19.02 |
| 4 | 500.07 | 33.52 QP | 46.00 | -12.48 | 1.00 V | 196 | 11.76 | 21.76 |
| 5 | 666.75 | 32.14 QP | 46.00 | -13.86 | 1.35 V | 42 | 6.85 | 25.29 |
| 6 | 766.85 | 35.62 QP | 46.00 | -10.38 | 1.25 V | 68 | 8.20 | 27.42 |
| 7 | 959.89 | 35.41 QP | 46.00 | -10.59 | 1.42 V | 168 | 5.52 | 29.89 |

- REMARKS:**
1. Emission level(dBuV/m)=Raw Value(dBuV) + Correction Factor(dB/m)
 2. Correction Factor(dB/m) = Antenna Factor (dB/m) + Cable Factor (dB)
 3. The other emission levels were very low against the limit.
 4. Margin value = Emission level – Limit value

802.11a OFDM modulation

| | | | |
|---------------------------------|----------------------------|--------------------------|--------------------------|
| MODE | Channel 1 | FREQUENCY RANGE | 1 ~ 40 GHz |
| MODULATION TYPE | BPSK | TRANSFER RATE | 6Mbps |
| INPUT POWER (SYSTEM) | 120Vac, 60 Hz | DETECTOR FUNCTION | Peak(PK) Average (AV) |
| ENVIRONMENTAL CONDITIONS | 26deg. C, 69%RH, 960hPa | TESTED BY | Sky Liao |

ANTENNA POLARITY & TEST DISTANCE: HORIZONTAL AT 3 M

| No. | Freq. (MHz) | Emission Level (dBuV/m) | Limit (dBuV/m) | Margin (dB) | Antenna Height (m) | Table Angle (Degree) | Raw Value (dBuV) | Correction Factor (dB/m) |
|-----|-------------|-------------------------|----------------|-------------|--------------------|----------------------|------------------|--------------------------|
| 1 | #5150.00 | 60.52 PK | 74.00 | -13.48 | 1.57 H | 116 | 24.28 | 36.24 |
| 2 | #5150.00 | 45.47 AV | 54.00 | -8.53 | 1.57 H | 116 | 9.23 | 36.24 |
| 3 | *5180.00 | 107.80 PK | | | 1.58 H | 122 | 71.52 | 36.28 |
| 4 | *5180.00 | 96.70 AV | | | 1.58 H | 122 | 60.42 | 36.28 |
| 5 | 10360.00 | 59.50 PK | 88.30 | -28.80 | 1.53 H | 236 | 13.60 | 45.90 |
| 6 | 10360.00 | 45.60 AV | 68.30 | -22.70 | 1.53 H | 236 | -0.30 | 45.90 |
| 7 | #15540.00 | 61.50 PK | 74.00 | -12.50 | 1.30 H | 110 | 13.52 | 47.98 |
| 8 | #15540.00 | 47.10 AV | 54.00 | -6.90 | 1.30 H | 110 | -0.88 | 47.98 |

ANTENNA POLARITY & TEST DISTANCE: VERTICAL AT 3 M

| No. | Freq. (MHz) | Emission Level (dBuV/m) | Limit (dBuV/m) | Margin (dB) | Antenna Height (m) | Table Angle (Degree) | Raw Value (dBuV) | Correction Factor (dB/m) |
|-----|-------------|-------------------------|----------------|-------------|--------------------|----------------------|------------------|--------------------------|
| 1 | #5150.00 | 60.23 PK | 74.00 | -13.77 | 1.40 V | 288 | 23.99 | 36.24 |
| 2 | #5150.00 | 45.30 AV | 54.00 | -8.70 | 1.40 V | 288 | 9.06 | 36.24 |
| 3 | *5180.00 | 107.60 PK | | | 1.27 V | 190 | 71.32 | 36.28 |
| 4 | *5180.00 | 96.60 AV | | | 1.27 V | 190 | 60.32 | 36.28 |
| 5 | 10360.00 | 64.10 PK | 88.30 | -24.20 | 1.58 V | 278 | 18.20 | 45.90 |
| 6 | 10360.00 | 50.90 AV | 68.30 | -17.40 | 1.58 V | 278 | 5.00 | 45.90 |
| 7 | #15540.00 | 61.90 PK | 74.00 | -12.10 | 1.75 V | 330 | 13.92 | 47.98 |
| 8 | #15540.00 | 47.80 AV | 54.00 | -6.20 | 1.75 V | 330 | -0.18 | 47.98 |

- NOTE:**
1. Emission level(dBuV/m)=Raw Value(dBuV) + Correction Factor(dB/m)
 2. Correction Factor(dB/m) = Antenna Factor (dB/m) + Cable Factor (dB)
 3. The other emission levels were very low against the limit.
 4. Margin value = Emission level – Limit value
 5. "*" : Fundamental frequency
 6. "#"The radiated frequency falling in the restricted band.

| | | | |
|---------------------------------|----------------------------|--------------------------|--------------------------|
| MODE | Channel 4 | FREQUENCY RANGE | 1 ~ 40 GHz |
| MODULATION TYPE | BPSK | TRANSFER RATE | 6Mbps |
| INPUT POWER (SYSTEM) | 120Vac, 60 Hz | DETECTOR FUNCTION | Peak(PK) Average (AV) |
| ENVIRONMENTAL CONDITIONS | 26deg. C, 69%RH, 960hPa | TESTED BY | Sky Liao |

ANTENNA POLARITY & TEST DISTANCE: HORIZONTAL AT 3 M

| No. | Freq. (MHz) | Emission Level (dBuV/m) | Limit (dBuV/m) | Margin (dB) | Antenna Height (m) | Table Angle (Degree) | Raw Value (dBuV) | Correction Factor (dB/m) |
|-----|-------------|-------------------------|----------------|-------------|--------------------|----------------------|------------------|--------------------------|
| 1 | *5240.00 | 108.10 PK | | | 1.90 H | 70 | 71.75 | 36.35 |
| 2 | *5240.00 | 97.10 AV | | | 1.90 H | 70 | 60.75 | 36.35 |
| 3 | 10480.00 | 58.70 PK | 88.30 | -29.60 | 1.76 H | 222 | 12.59 | 46.11 |
| 4 | 10480.00 | 45.70 AV | 68.30 | -22.60 | 1.76 H | 222 | -0.41 | 46.11 |
| 5 | #15720.00 | 61.10 PK | 74.00 | -12.90 | 1.60 H | 165 | 13.36 | 47.74 |
| 6 | #15720.00 | 47.80 AV | 54.00 | -6.20 | 1.60 H | 165 | 0.06 | 47.74 |

ANTENNA POLARITY & TEST DISTANCE: VERTICAL AT 3 M

| No. | Freq. (MHz) | Emission Level (dBuV/m) | Limit (dBuV/m) | Margin (dB) | Antenna Height (m) | Table Angle (Degree) | Raw Value (dBuV) | Correction Factor (dB/m) |
|-----|-------------|-------------------------|----------------|-------------|--------------------|----------------------|------------------|--------------------------|
| 1 | *5240.00 | 106.40 PK | | | 1.44 V | 170 | 70.05 | 36.35 |
| 2 | *5240.00 | 95.40 AV | | | 1.44 V | 170 | 59.05 | 36.35 |
| 3 | 10480.00 | 64.70 PK | 88.30 | -23.60 | 1.58 V | 290 | 18.59 | 46.11 |
| 4 | 10480.00 | 50.80 AV | 68.30 | -17.50 | 1.58 V | 290 | 4.69 | 46.11 |
| 5 | #15720.00 | 61.55 PK | 74.00 | -12.45 | 1.55 V | 155 | 13.81 | 47.74 |
| 6 | #15720.00 | 48.00 AV | 54.00 | -6.00 | 1.55 V | 155 | 0.26 | 47.74 |

- NOTE:**
1. Emission level(dBuV/m)=Raw Value(dBuV) + Correction Factor(dB/m)
 2. Correction Factor(dB/m) = Antenna Factor (dB/m) + Cable Factor (dB)
 3. The other emission levels were very low against the limit.
 4. Margin value = Emission level – Limit value
 5. "*" : Fundamental frequency
 6. "#"The radiated frequency falling in the restricted band.

| | | | |
|---------------------------------|----------------------------|--------------------------|--------------------------|
| MODE | Channel 5 | FREQUENCY RANGE | 1 ~ 40 GHz |
| MODULATION TYPE | BPSK | TRANSFER RATE | 6Mbps |
| INPUT POWER (SYSTEM) | 120Vac, 60 Hz | DETECTOR FUNCTION | Peak(PK) Average (AV) |
| ENVIRONMENTAL CONDITIONS | 26deg. C, 69%RH, 960hPa | TESTED BY | Sky Liao |

ANTENNA POLARITY & TEST DISTANCE: HORIZONTAL AT 3 M

| No. | Freq. (MHz) | Emission Level (dBuV/m) | Limit (dBuV/m) | Margin (dB) | Antenna Height (m) | Table Angle (Degree) | Raw Value (dBuV) | Correction Factor (dB/m) |
|-----|-------------|-------------------------|----------------|-------------|--------------------|----------------------|------------------|--------------------------|
| 1 | *5260.00 | 107.60 PK | | | 1.52 H | 116 | 71.23 | 36.37 |
| 2 | *5260.00 | 96.80 AV | | | 1.52 H | 116 | 60.43 | 36.37 |
| 3 | 10520.00 | 59.20 PK | 88.30 | -29.10 | 1.80 H | 225 | 13.03 | 46.17 |
| 4 | 10520.00 | 45.80 AV | 68.30 | -22.50 | 1.80 H | 225 | -0.37 | 46.17 |
| 5 | #15780.00 | 61.40 PK | 74.00 | -12.60 | 1.55 H | 25 | 13.73 | 47.67 |
| 6 | #15780.00 | 47.60 AV | 54.00 | -6.40 | 1.55 H | 25 | -0.07 | 47.67 |

ANTENNA POLARITY & TEST DISTANCE: VERTICAL AT 3 M

| No. | Freq. (MHz) | Emission Level (dBuV/m) | Limit (dBuV/m) | Margin (dB) | Antenna Height (m) | Table Angle (Degree) | Raw Value (dBuV) | Correction Factor (dB/m) |
|-----|-------------|-------------------------|----------------|-------------|--------------------|----------------------|------------------|--------------------------|
| 1 | *5260.00 | 107.20 PK | | | 1.25 V | 182 | 70.83 | 36.37 |
| 2 | *5260.00 | 96.20 AV | | | 1.25 V | 182 | 59.83 | 36.37 |
| 3 | 10520.00 | 62.70 PK | 88.30 | -25.60 | 1.78 V | 288 | 16.53 | 46.17 |
| 4 | 10520.00 | 50.30 AV | 68.30 | -18.00 | 1.78 V | 288 | 4.13 | 46.17 |
| 5 | #15780.00 | 63.00 PK | 74.00 | -11.00 | 1.30 V | 348 | 15.33 | 47.67 |
| 6 | #15780.00 | 48.80 AV | 54.00 | -5.20 | 1.30 V | 348 | 1.13 | 47.67 |

- NOTE:**
1. Emission level(dBuV/m)=Raw Value(dBuV) + Correction Factor(dB/m)
 2. Correction Factor(dB/m) = Antenna Factor (dB/m) + Cable Factor (dB)
 3. The other emission levels were very low against the limit.
 4. Margin value = Emission level – Limit value
 5. "*" : Fundamental frequency
 6. "#": The radiated frequency falling in the restricted band.

| | | | |
|---------------------------------|----------------------------|--------------------------|--------------------------|
| MODE | Channel 8 | FREQUENCY RANGE | 1 ~ 40 GHz |
| MODULATION TYPE | BPSK | TRANSFER RATE | 6Mbps |
| INPUT POWER (SYSTEM) | 120Vac, 60 Hz | DETECTOR FUNCTION | Peak(PK) Average (AV) |
| ENVIRONMENTAL CONDITIONS | 26deg. C, 69%RH, 960hPa | TESTED BY | Sky Liao |

| ANTENNA POLARITY & TEST DISTANCE: HORIZONTAL AT 3 M | | | | | | | | |
|--|-------------|-------------------------|----------------|-------------|--------------------|----------------------|------------------|--------------------------|
| No. | Freq. (MHz) | Emission Level (dBuV/m) | Limit (dBuV/m) | Margin (dB) | Antenna Height (m) | Table Angle (Degree) | Raw Value (dBuV) | Correction Factor (dB/m) |
| 1 | *5320.00 | 107.80 PK | | | 1.52 H | 68 | 71.36 | 36.44 |
| 2 | *5320.00 | 96.80 AV | | | 1.52 H | 68 | 60.36 | 36.44 |
| 3 | #5350.00 | 64.32 PK | 74.00 | -9.68 | 1.52 H | 68 | 27.84 | 36.48 |
| 4 | #5350.00 | 45.38 AV | 54.00 | -8.62 | 1.52 H | 68 | 8.90 | 36.48 |
| 5 | #10640.00 | 58.40 PK | 74.00 | -15.60 | 1.75 H | 60 | 12.11 | 46.29 |
| 6 | #10640.00 | 44.60 AV | 54.00 | -9.40 | 1.75 H | 60 | -1.69 | 46.29 |
| 7 | #15960.00 | 62.00 PK | 74.00 | -12.00 | 1.62 H | 7 | 14.57 | 47.43 |
| 8 | #15960.00 | 47.10 AV | 54.00 | -6.90 | 1.62 H | 7 | -0.33 | 47.43 |

| ANTENNA POLARITY & TEST DISTANCE: VERTICAL AT 3 M | | | | | | | | |
|--|-------------|-------------------------|----------------|-------------|--------------------|----------------------|------------------|--------------------------|
| No. | Freq. (MHz) | Emission Level (dBuV/m) | Limit (dBuV/m) | Margin (dB) | Antenna Height (m) | Table Angle (Degree) | Raw Value (dBuV) | Correction Factor (dB/m) |
| 1 | *5320.00 | 106.00 PK | | | 1.40 V | 190 | 69.56 | 36.44 |
| 2 | *5320.00 | 95.20 AV | | | 1.40 V | 190 | 58.76 | 36.44 |
| 3 | #5350.00 | 65.63 PK | 74.00 | -8.37 | 1.40 V | 190 | 29.15 | 36.48 |
| 4 | #5350.00 | 46.37 AV | 54.00 | -7.63 | 1.40 V | 190 | 9.89 | 36.48 |
| 5 | #10640.00 | 64.10 PK | 74.00 | -9.90 | 1.60 V | 277 | 17.81 | 46.29 |
| 6 | #10640.00 | 50.40 AV | 54.00 | -3.60 | 1.60 V | 277 | 4.11 | 46.29 |
| 7 | #15960.00 | 61.90 PK | 74.00 | -12.10 | 1.15 V | 336 | 14.47 | 47.43 |
| 8 | #15960.00 | 48.00 AV | 54.00 | -6.00 | 1.15 V | 336 | 0.57 | 47.43 |

- NOTE:**
1. Emission level(dBuV/m)=Raw Value(dBuV) + Correction Factor(dB/m)
 2. Correction Factor(dB/m) = Antenna Factor (dB/m) + Cable Factor (dB)
 3. The other emission levels were very low against the limit.
 4. Margin value = Emission level – Limit value
 5. "*" : Fundamental frequency
 6. "#"The radiated frequency falling in the restricted band.

| | | | |
|---------------------------------|----------------------------|--------------------------|--------------------------|
| MODE | Channel 9 | FREQUENCY RANGE | 1 ~ 40 GHz |
| MODULATION TYPE | BPSK | TRANSFER RATE | 6Mbps |
| INPUT POWER (SYSTEM) | 120Vac, 60 Hz | DETECTOR FUNCTION | Peak(PK) Average (AV) |
| ENVIRONMENTAL CONDITIONS | 26deg. C, 69%RH, 960hPa | TESTED BY | Sky Liao |

| ANTENNA POLARITY & TEST DISTANCE: HORIZONTAL AT 3 M | | | | | | | | |
|--|-------------|-------------------------|----------------|-------------|--------------------|----------------------|------------------|--------------------------|
| No. | Freq. (MHz) | Emission Level (dBuV/m) | Limit (dBuV/m) | Margin (dB) | Antenna Height (m) | Table Angle (Degree) | Raw Value (dBuV) | Correction Factor (dB/m) |
| 1 | #5460.00 | 60.90 PK | 74.00 | -13.10 | 1.33 H | 106 | 24.29 | 36.61 |
| 2 | #5460.00 | 45.50 AV | 54.00 | -8.50 | 1.33 H | 106 | 8.89 | 36.61 |
| 3 | 5470.00 | 67.10 PK | 88.30 | -21.20 | 1.60 H | 113 | 30.48 | 36.62 |
| 4 | 5470.00 | 51.70 AV | 68.30 | -16.60 | 1.60 H | 113 | 15.08 | 36.62 |
| 5 | *5500.00 | 110.90 PK | | | 1.55 H | 120 | 74.24 | 36.66 |
| 6 | *5500.00 | 99.50 AV | | | 1.55 H | 120 | 62.84 | 36.66 |
| 7 | #11000.00 | 60.90 PK | 74.00 | -13.10 | 1.80 H | 136 | 14.25 | 46.65 |
| 8 | #11000.00 | 46.40 AV | 54.00 | -7.60 | 1.80 H | 136 | -0.25 | 46.65 |
| 9 | 16500.00 | 63.20 PK | 88.30 | -25.10 | 1.80 H | 170 | 14.93 | 48.27 |
| 10 | 16500.00 | 49.20 AV | 68.30 | -19.10 | 1.80 H | 170 | 0.93 | 48.27 |

| ANTENNA POLARITY & TEST DISTANCE: VERTICAL AT 3 M | | | | | | | | |
|--|-------------|-------------------------|----------------|-------------|--------------------|----------------------|------------------|--------------------------|
| No. | Freq. (MHz) | Emission Level (dBuV/m) | Limit (dBuV/m) | Margin (dB) | Antenna Height (m) | Table Angle (Degree) | Raw Value (dBuV) | Correction Factor (dB/m) |
| 1 | #5460.00 | 61.20 PK | 74.00 | -12.80 | 1.32 V | 282 | 24.59 | 36.61 |
| 2 | #5460.00 | 45.40 AV | 54.00 | -8.60 | 1.32 V | 282 | 8.79 | 36.61 |
| 3 | 5470.00 | 66.65 PK | 88.30 | -21.65 | 1.30 V | 284 | 30.03 | 36.62 |
| 4 | 5470.00 | 51.02 AV | 68.30 | -17.28 | 1.30 V | 284 | 14.40 | 36.62 |
| 5 | *5500.00 | 110.20 PK | | | 1.30 V | 282 | 73.54 | 36.66 |
| 6 | *5500.00 | 98.80 AV | | | 1.30 V | 282 | 62.14 | 36.66 |
| 7 | #11000.00 | 64.00 PK | 74.00 | -10.00 | 1.70 V | 290 | 17.35 | 46.65 |
| 8 | #11000.00 | 51.00 AV | 54.00 | -3.00 | 1.70 V | 290 | 4.35 | 46.65 |
| 9 | 16500.00 | 68.15 PK | 88.30 | -20.15 | 1.15 V | 350 | 19.88 | 48.27 |
| 10 | 16500.00 | 53.82 AV | 68.30 | -14.48 | 1.15 V | 350 | 5.55 | 48.27 |

- NOTE:**
1. Emission level(dBuV/m)=Raw Value(dBuV) + Correction Factor(dB/m)
 2. Correction Factor(dB/m) = Antenna Factor (dB/m) + Cable Factor (dB)
 3. The other emission levels were very low against the limit.
 4. Margin value = Emission level – Limit value
 5. "*" : Fundamental frequency
 6. "#"The radiated frequency falling in the restricted band.

| | | | |
|---------------------------------|----------------------------|--------------------------|--------------------------|
| MODE | Channel 14 | FREQUENCY RANGE | 1 ~ 40 GHz |
| MODULATION TYPE | BPSK | TRANSFER RATE | 6Mbps |
| INPUT POWER (SYSTEM) | 120Vac, 60 Hz | DETECTOR FUNCTION | Peak(PK) Average (AV) |
| ENVIRONMENTAL CONDITIONS | 26deg. C, 69%RH, 960hPa | TESTED BY | Sky Liao |

ANTENNA POLARITY & TEST DISTANCE: HORIZONTAL AT 3 M

| No. | Freq. (MHz) | Emission Level (dBuV/m) | Limit (dBuV/m) | Margin (dB) | Antenna Height (m) | Table Angle (Degree) | Raw Value (dBuV) | Correction Factor (dB/m) |
|-----|-------------|-------------------------|----------------|-------------|--------------------|----------------------|------------------|--------------------------|
| 1 | *5600.00 | 111.00 PK | | | 1.52 H | 125 | 74.10 | 36.90 |
| 2 | *5600.00 | 99.50 AV | | | 1.52 H | 125 | 62.60 | 36.90 |
| 3 | #11200.00 | 62.30 PK | 74.00 | -11.70 | 2.00 H | 345 | 15.50 | 46.80 |
| 4 | #11200.00 | 48.00 AV | 54.00 | -6.00 | 2.00 H | 345 | 1.20 | 46.80 |
| 5 | 16800.00 | 67.70 PK | 88.30 | -20.60 | 1.75 H | 6 | 18.21 | 49.49 |
| 6 | 16800.00 | 53.60 AV | 68.30 | -14.70 | 1.75 H | 6 | 4.11 | 49.49 |

ANTENNA POLARITY & TEST DISTANCE: VERTICAL AT 3 M

| No. | Freq. (MHz) | Emission Level (dBuV/m) | Limit (dBuV/m) | Margin (dB) | Antenna Height (m) | Table Angle (Degree) | Raw Value (dBuV) | Correction Factor (dB/m) |
|-----|-------------|-------------------------|----------------|--------------|--------------------|----------------------|------------------|--------------------------|
| 1 | *5600.00 | 110.00 PK | | | 1.30 V | 280 | 73.10 | 36.90 |
| 2 | *5600.00 | 98.70 AV | | | 1.30 V | 280 | 61.80 | 36.90 |
| 3 | #11200.00 | 66.50 PK | 74.00 | -7.50 | 1.55 V | 10 | 19.70 | 46.80 |
| 4 | #11200.00 | 52.00 AV | 54.00 | -2.00 | 1.55 V | 10 | 5.20 | 46.80 |
| 5 | 16800.00 | 69.00 PK | 88.30 | -19.30 | 1.13 V | 353 | 19.51 | 49.49 |
| 6 | 16800.00 | 54.40 AV | 68.30 | -13.90 | 1.13 V | 353 | 4.91 | 49.49 |

- NOTE:**
1. Emission level(dBuV/m)=Raw Value(dBuV) + Correction Factor(dB/m)
 2. Correction Factor(dB/m) = Antenna Factor (dB/m) + Cable Factor (dB)
 3. The other emission levels were very low against the limit.
 4. Margin value = Emission level – Limit value
 5. "*" : Fundamental frequency
 6. "#" The radiated frequency falling in the restricted band.



| | | | |
|---------------------------------|----------------------------|--------------------------|--------------------------|
| MODE | Channel 19 | FREQUENCY RANGE | 1 ~ 40 GHz |
| MODULATION TYPE | BPSK | TRANSFER RATE | 6Mbps |
| INPUT POWER (SYSTEM) | 120Vac, 60 Hz | DETECTOR FUNCTION | Peak(PK) Average (AV) |
| ENVIRONMENTAL CONDITIONS | 26deg. C, 69%RH, 960hPa | TESTED BY | Sky Liao |

ANTENNA POLARITY & TEST DISTANCE: HORIZONTAL AT 3 M

| No. | Freq. (MHz) | Emission Level (dBuV/m) | Limit (dBuV/m) | Margin (dB) | Antenna Height (m) | Table Angle (Degree) | Raw Value (dBuV) | Correction Factor (dB/m) |
|-----|-------------|-------------------------|----------------|-------------|--------------------|----------------------|------------------|--------------------------|
| 1 | *5700.00 | 109.50 PK | | | 1.66 H | 125 | 72.35 | 37.15 |
| 2 | *5700.00 | 98.70 AV | | | 1.66 H | 125 | 61.55 | 37.15 |
| 3 | 5725.00 | 72.20 PK | 88.30 | -16.10 | 1.66 H | 125 | 34.99 | 37.21 |
| 4 | 5725.00 | 58.00 AV | 68.30 | -10.30 | 1.66 H | 125 | 20.79 | 37.21 |
| 5 | #11400.00 | 63.55 PK | 74.00 | -10.45 | 1.88 H | 138 | 16.60 | 46.95 |
| 6 | #11400.00 | 49.38 AV | 54.00 | -4.62 | 1.88 H | 138 | 2.43 | 46.95 |
| 7 | 17100.00 | 64.30 PK | 88.30 | -24.00 | 2.17 H | 0 | 13.66 | 50.64 |
| 8 | 17100.00 | 50.46 AV | 68.30 | -17.84 | 2.17 H | 0 | -0.18 | 50.64 |

ANTENNA POLARITY & TEST DISTANCE: VERTICAL AT 3 M

| No. | Freq. (MHz) | Emission Level (dBuV/m) | Limit (dBuV/m) | Margin (dB) | Antenna Height (m) | Table Angle (Degree) | Raw Value (dBuV) | Correction Factor (dB/m) |
|-----|-------------|-------------------------|----------------|-------------|--------------------|----------------------|------------------|--------------------------|
| 1 | *5700.00 | 109.10 PK | | | 1.36 V | 280 | 71.95 | 37.15 |
| 2 | *5700.00 | 97.20 AV | | | 1.36 V | 280 | 60.05 | 37.15 |
| 3 | 5725.00 | 69.90 PK | 88.30 | -18.40 | 1.36 V | 280 | 32.69 | 37.21 |
| 4 | 5725.00 | 57.10 AV | 68.30 | -11.20 | 1.36 V | 280 | 19.89 | 37.21 |
| 5 | #11400.00 | 65.50 PK | 74.00 | -8.50 | 2.00 V | 10 | 18.55 | 46.95 |
| 6 | #11400.00 | 51.00 AV | 54.00 | -3.00 | 2.00 V | 10 | 4.05 | 46.95 |
| 7 | 17100.00 | 65.60 PK | 88.30 | -22.70 | 1.10 V | 7 | 14.96 | 50.64 |
| 8 | 17100.00 | 51.40 AV | 68.30 | -16.90 | 1.10 V | 7 | 0.76 | 50.64 |

- NOTE:**
1. Emission level(dBuV/m)=Raw Value(dBuV) + Correction Factor(dB/m)
 2. Correction Factor(dB/m) = Antenna Factor (dB/m) + Cable Factor (dB)
 3. The other emission levels were very low against the limit.
 4. Margin value = Emission level – Limit value
 5. "*" : Fundamental frequency
 6. "#" The radiated frequency falling in the restricted band.

RESTRICTED BANDEDGE (802.11a MODE, CH1, VERTICAL)

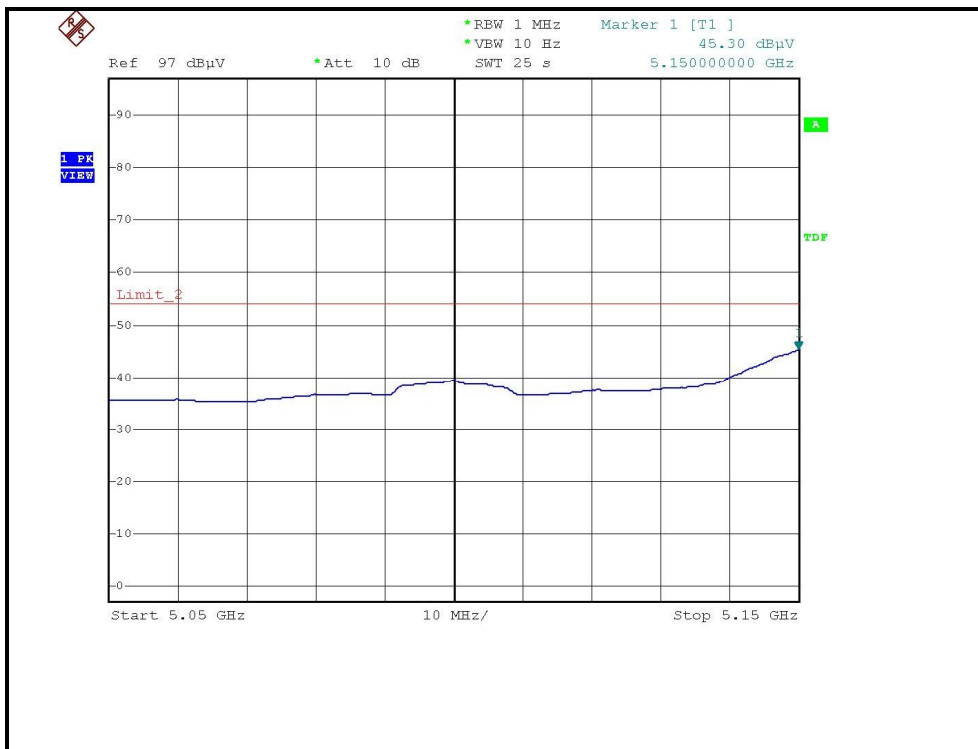
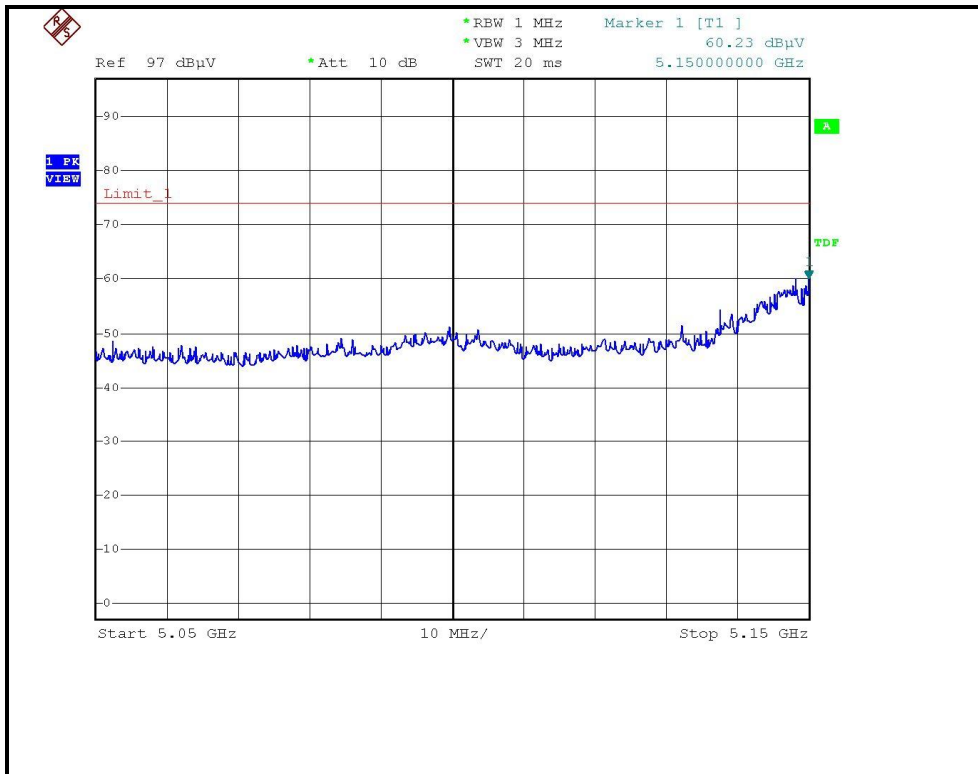

RESTRICTED BANDEDGE (802.11a MODE, CH8, VERTICAL)

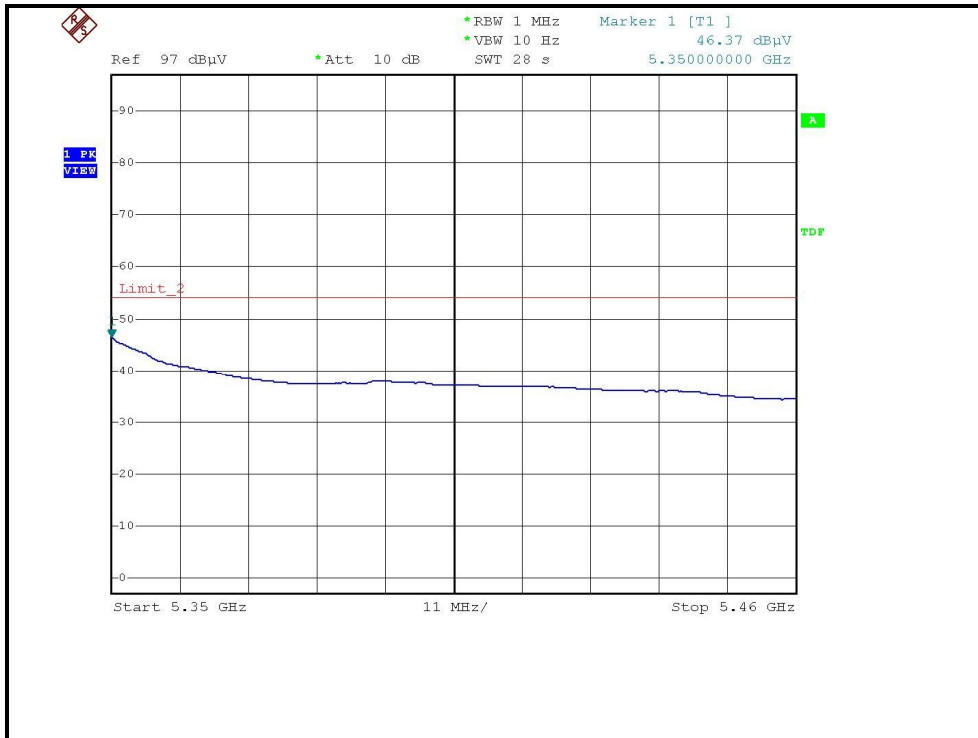
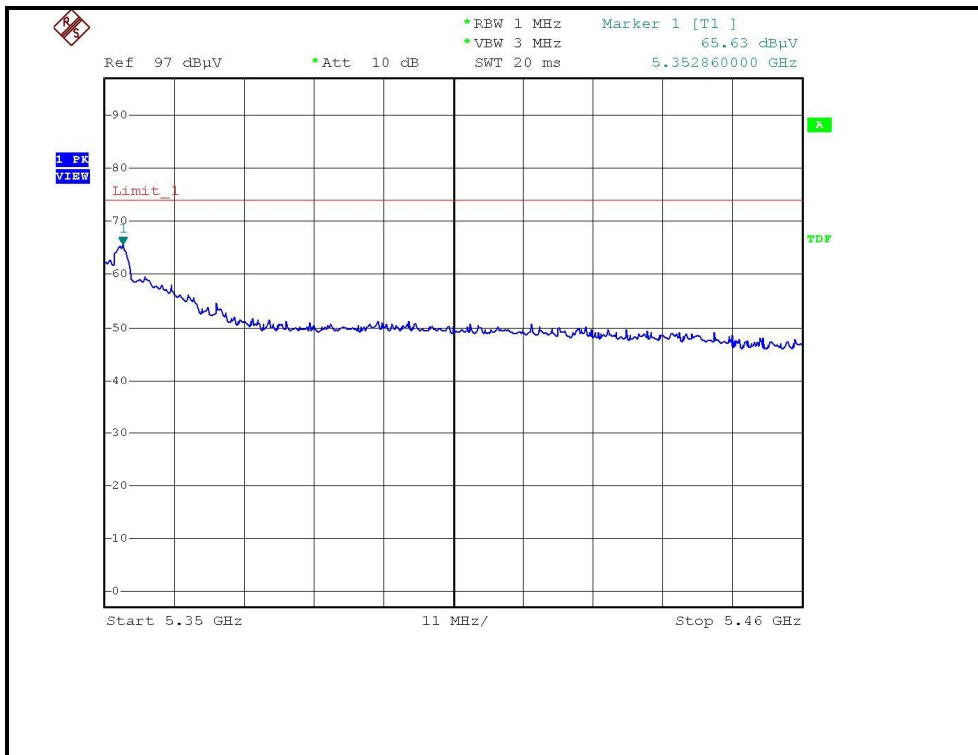

4.3 PEAK TRANSMIT POWER MEASUREMENT

4.3.1 LIMITS OF PEAK TRANSMIT POWER MEASUREMENT

| Frequency Band | Limit |
|------------------|---|
| 5.15 – 5.25GHz | The lesser of 50mW (17dBm) or 4dBm + 10logB |
| 5.25 – 5.35GHz | The lesser of 250mW (24dBm) or 11dBm + 10logB |
| 5.47 – 5.725GHz | The lesser of 250mW (24dBm) or 11dBm + 10logB |
| 5.725 – 5.825GHz | The lesser of 1W (30dBm) or 17dBm + 10logB |

NOTE: Where B is the 26dB emission bandwidth in MHz.

4.3.2 TEST INSTRUMENTS

| Description & Manufacturer | Model No. | Serial No. | Calibrated Until |
|-----------------------------|-----------|------------|------------------|
| ADVANTEST SPECTRUM ANALYZER | U3772 | 160100280 | April. 10.2008 |

NOTE:

- 1.The measurement uncertainty is less than +/- 2.6dB, which is calculated as per the NAMAS document NIS81.
- 2.The calibration interval of the above test instruments is 12 months and the calibrations are traceable to NML/ROC and NIST/USA.

4.3.3 TEST PROCEDURE

1. The transmitter output was connected to the spectrum analyzer.
2. Set span to encompass the entire emission bandwidth of the signal.
3. Set RBW to 1MHz, VBW to 300kHz.
4. Using the spectrum analyzer's channel power measurement function to measure the output power.

NOTE:

The test is performed in accordance with FCC Public Notice: APPENDIX A Guidelines for Assessing Unlicensed National Information Infrastructure (U-NII) Devices – Part 15, Subpart E, August 2002.

The transmitter output operates continuously therefore Method # 1 is used.

4.3.4 DEVIATION FROM TEST STANDARD

No deviation

4.3.5 TEST SETUP

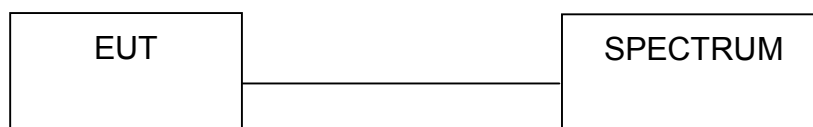

4.3.6 EUT OPERATING CONDITIONS

The software provided by client to enable the EUT under transmission condition continuously at specific channel frequencies individually.



4.3.7 TEST RESULTS

802.11a OFDM modulation

| | | | |
|-----------------------------|---------------|---------------------------------|------------------------|
| MODULATION TYPE | BPSK | TRANSFER RATE | 6Mbps |
| INPUT POWER (SYSTEM) | 120Vac, 60 Hz | ENVIRONMENTAL CONDITIONS | 27deg.C, 53%RH, 960hPa |
| TESTED BY | Rex Huang | | |

| CHANNEL | CHANNEL FREQUENCY (MHz) | PEAK POWER OUTPUT (dBm) | PEAK POWER OUTPUT (mW) | PEAK POWER LIMIT (dBm) | 26dBc Occupied Bandwidth (MHz) | PASS/FAIL |
|---------|-------------------------|-------------------------|------------------------|------------------------|--------------------------------|-----------|
| 1 | 5180 | 14.24 | 26.546 | 17 | 33.80 | PASS |
| 4 | 5240 | 14.04 | 25.351 | 17 | 25.85 | PASS |
| 5 | 5260 | 14.42 | 27.669 | 24 | 25.75 | PASS |
| 8 | 5320 | 13.7 | 23.442 | 24 | 24.70 | PASS |
| 9 | 5500 | 15.79 | 37.931 | 24 | 38.25 | PASS |
| 14 | 5600 | 15.6 | 36.308 | 24 | 38.55 | PASS |
| 19 | 5700 | 15.41 | 34.754 | 24 | 35.00 | PASS |

NOTE: The 26dBc Occupied Bandwidth plot, please refer to the following pages.

Peak Power Output:
CH1

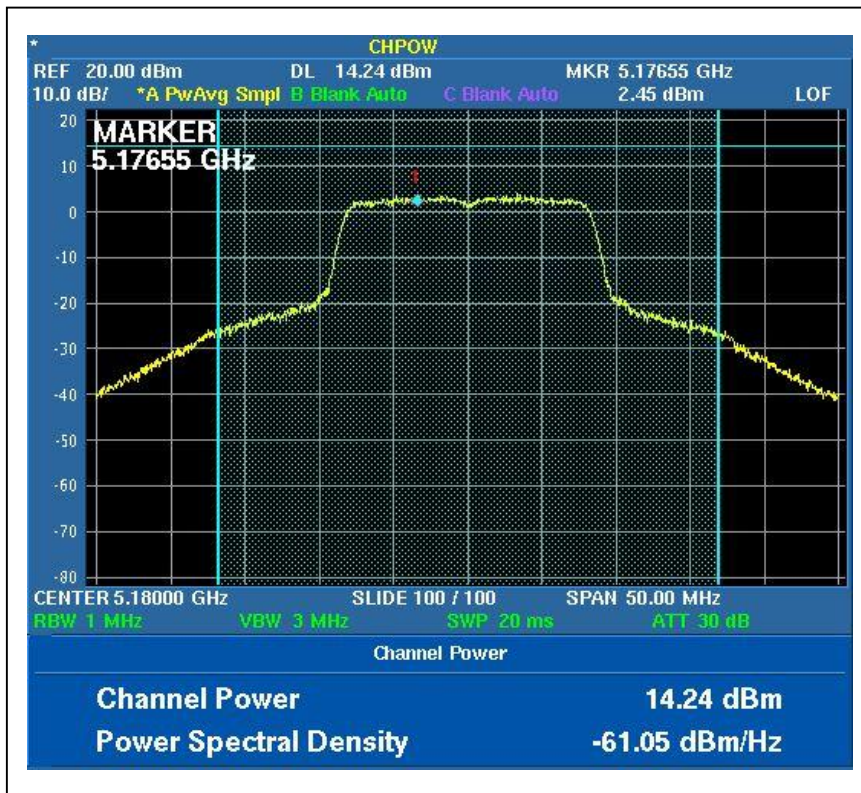

CH4

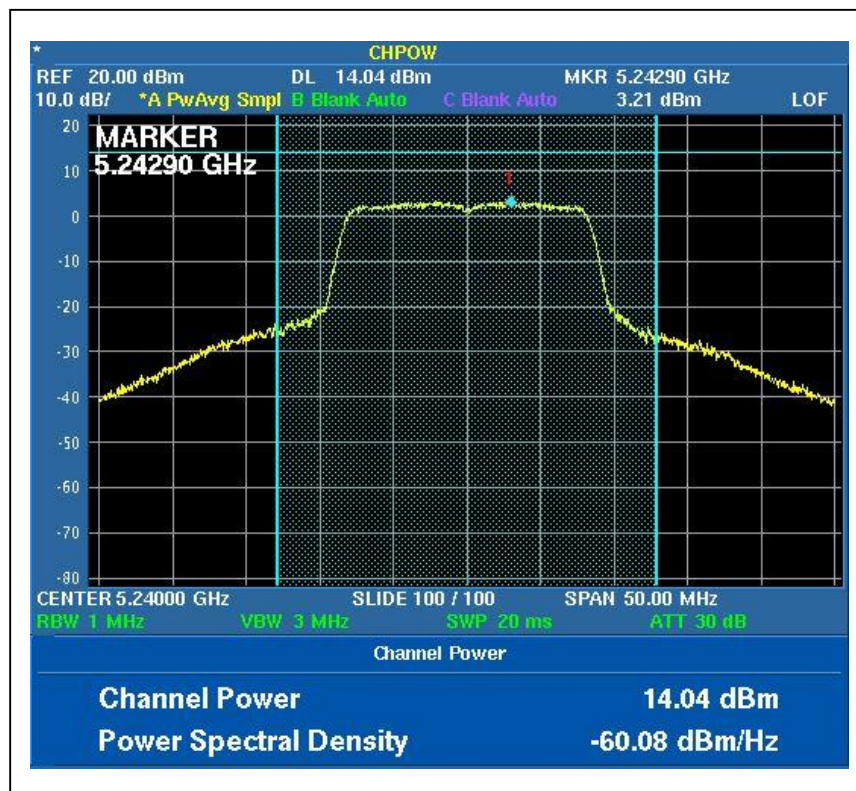

CH5



CH8

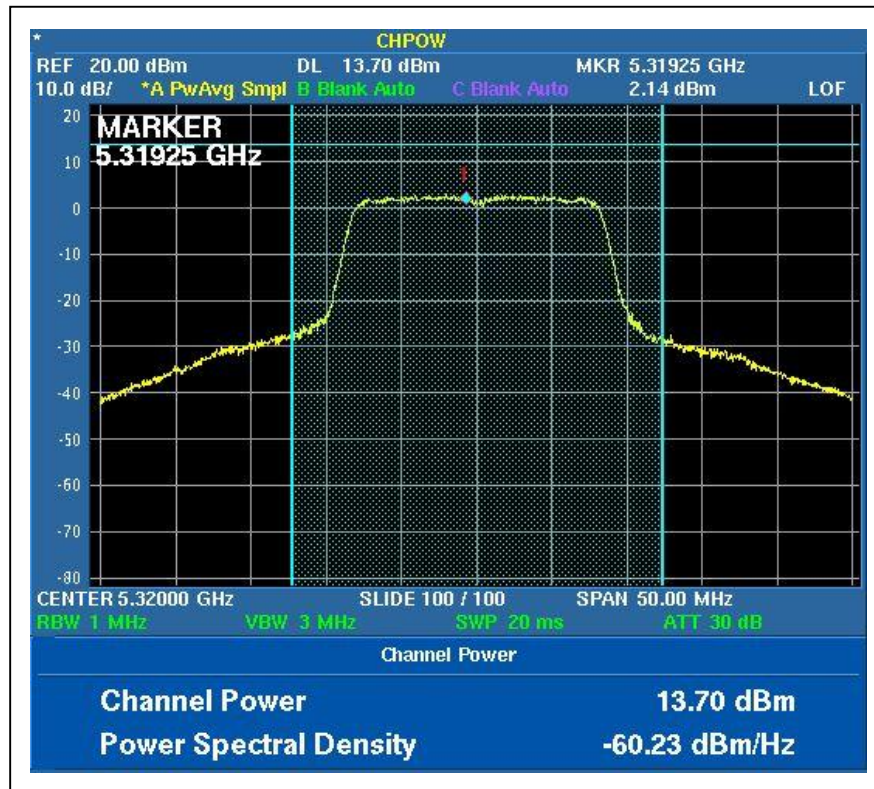

CH9

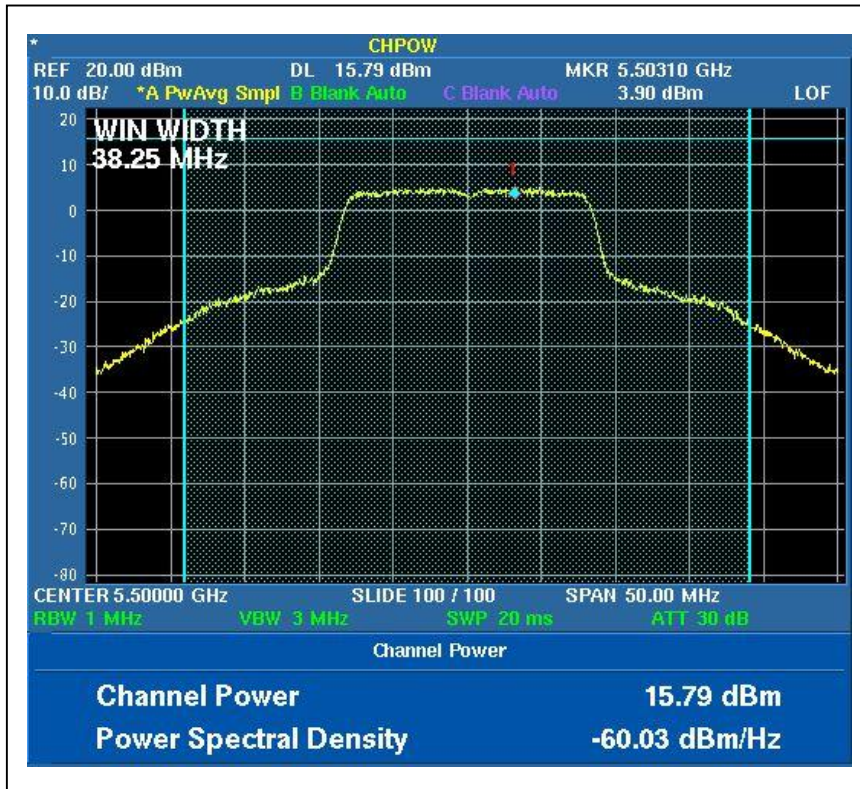

CH14

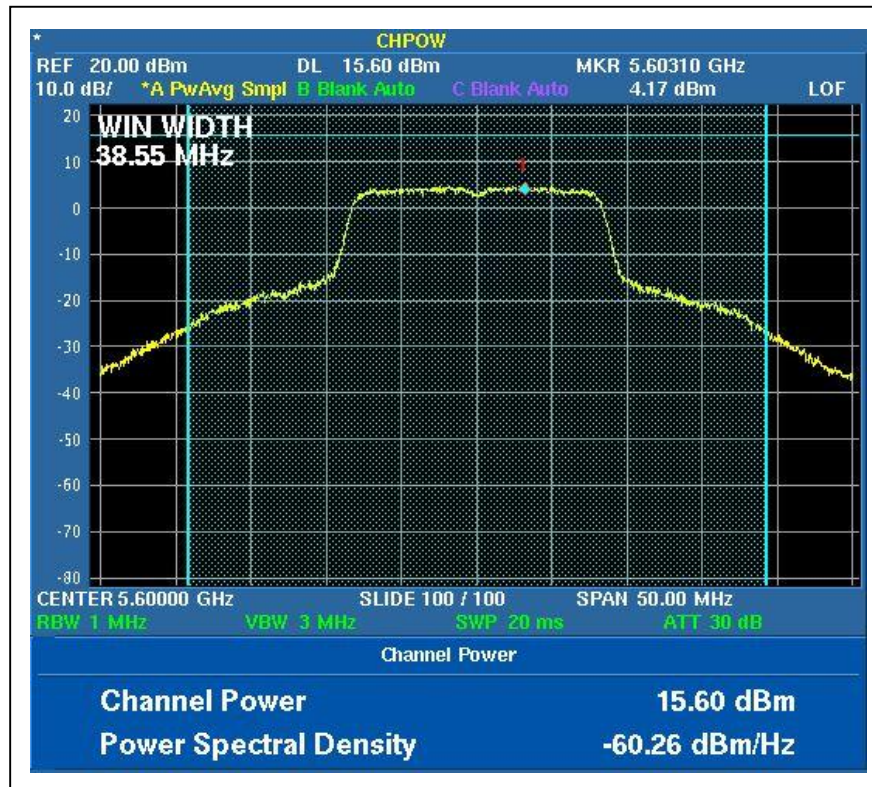

CH19

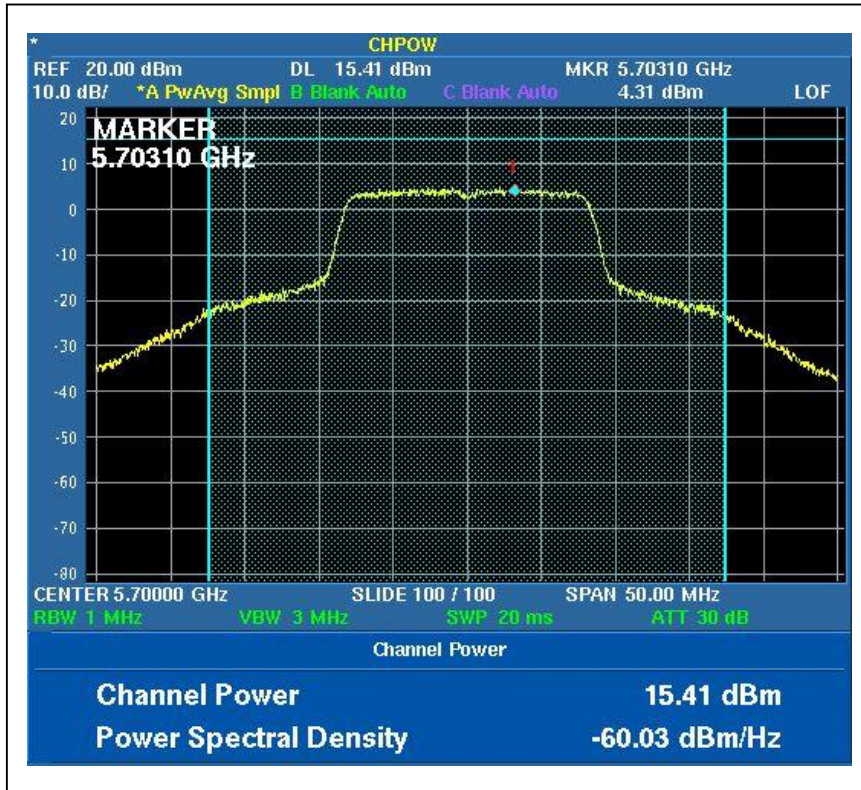

26dB Occupied Bandwidth:
CH1

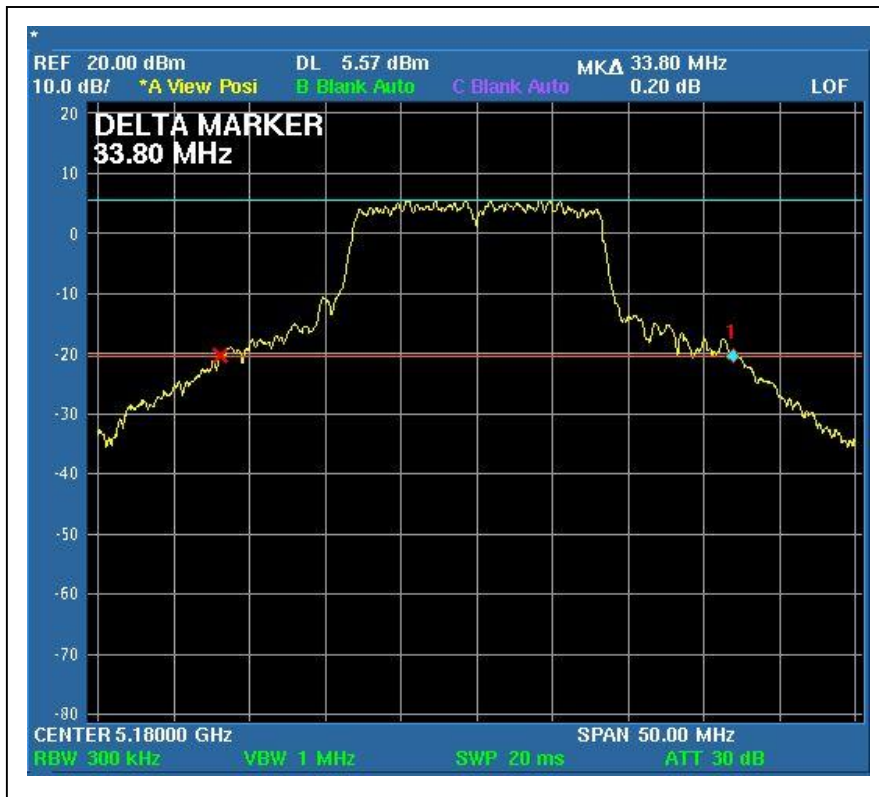

CH4

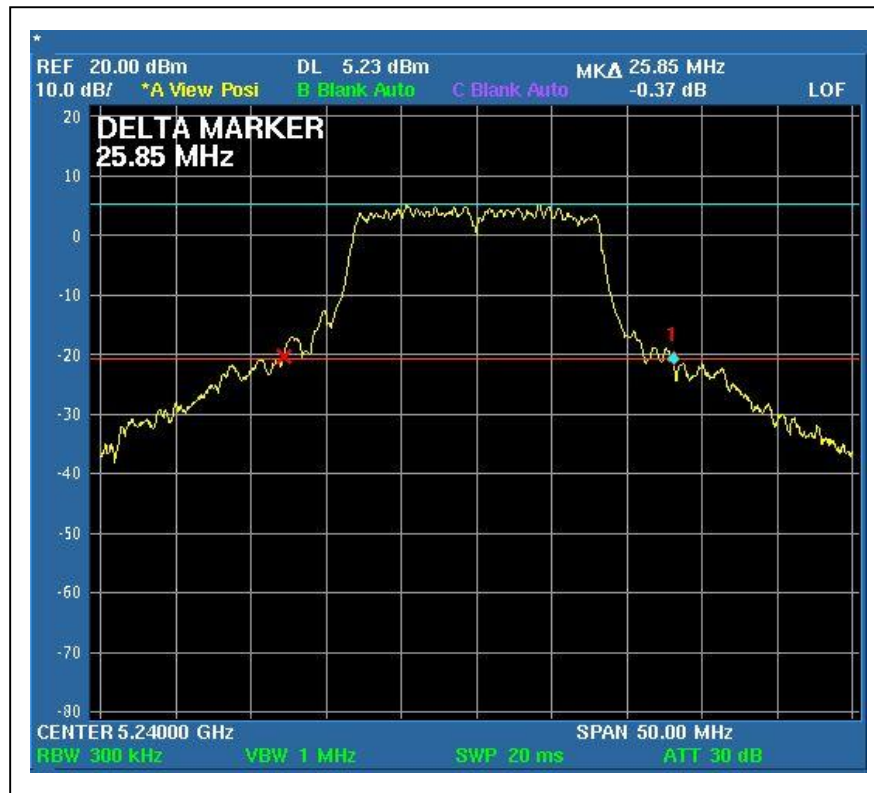

CH5

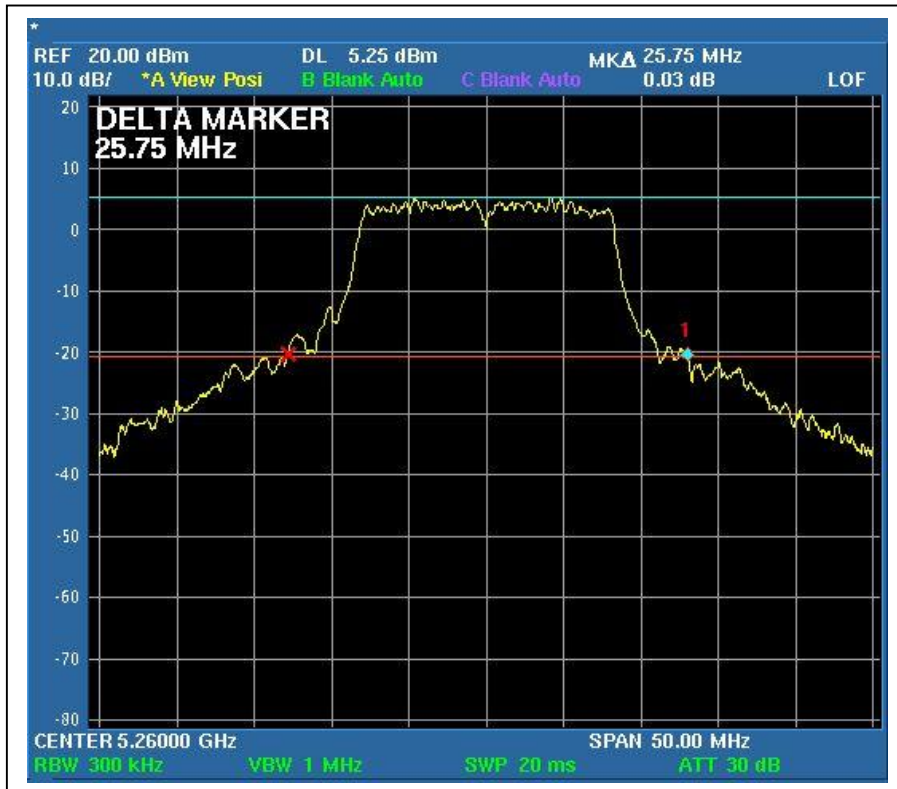

CH8

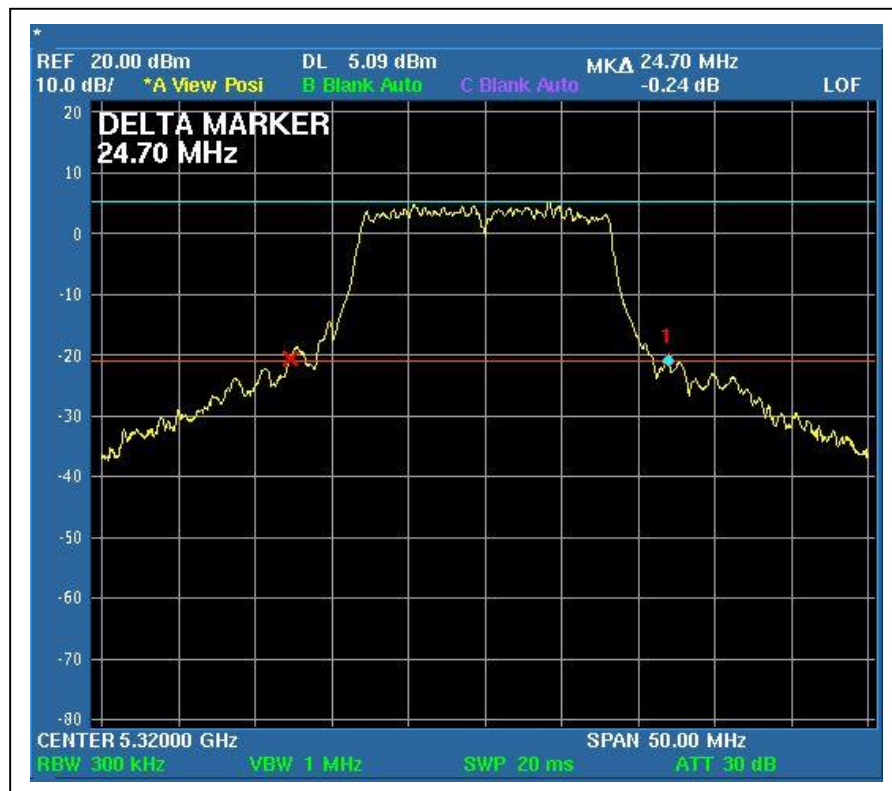

CH9

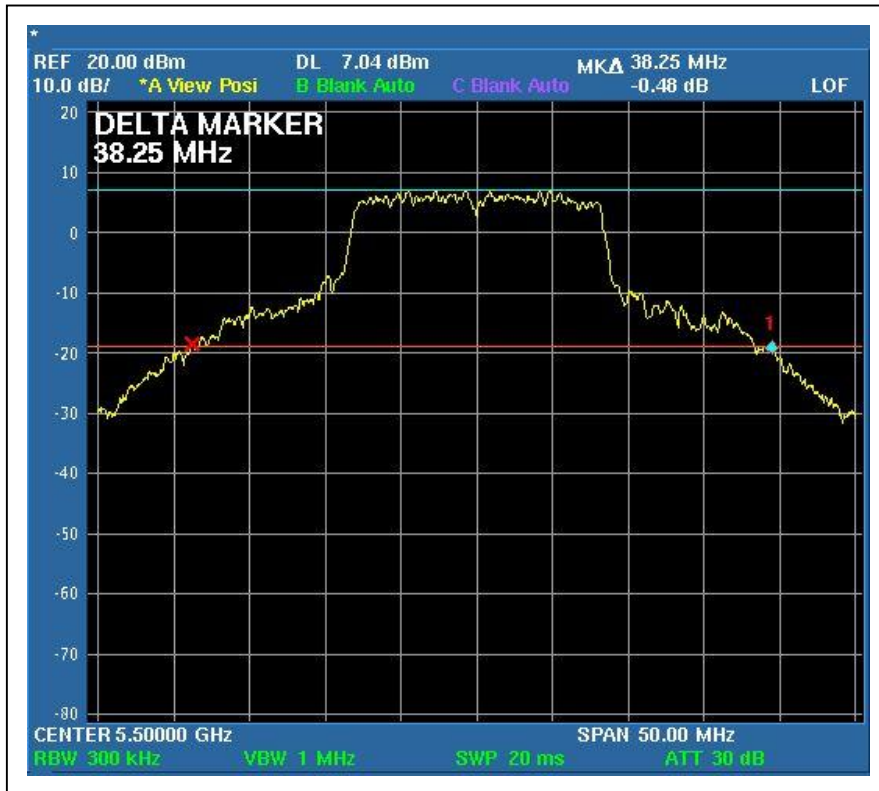

CH14

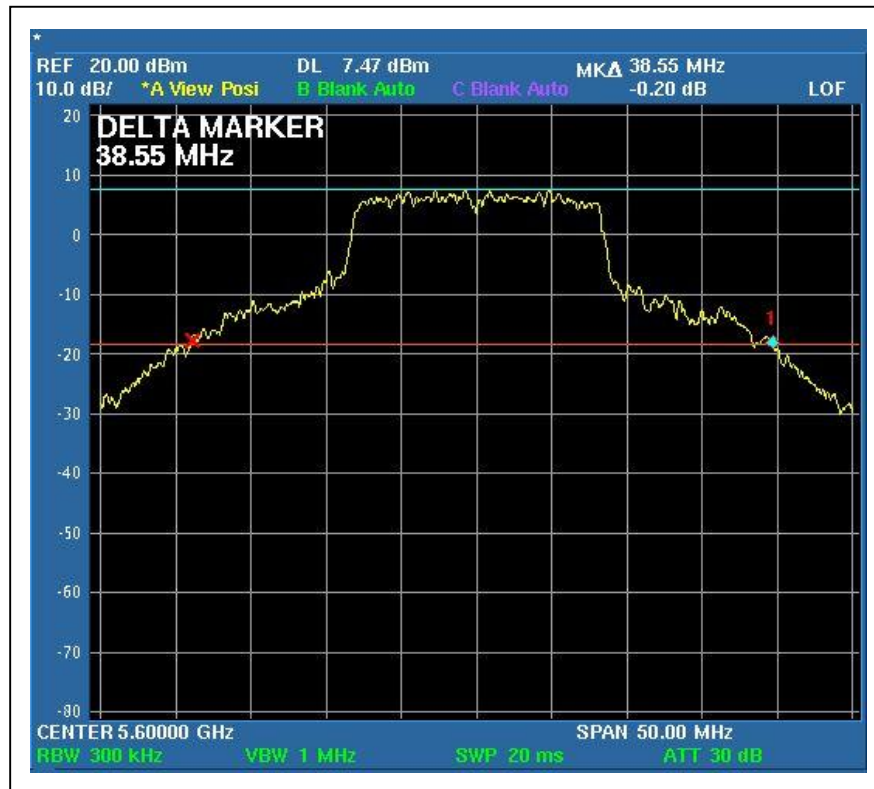

CH19

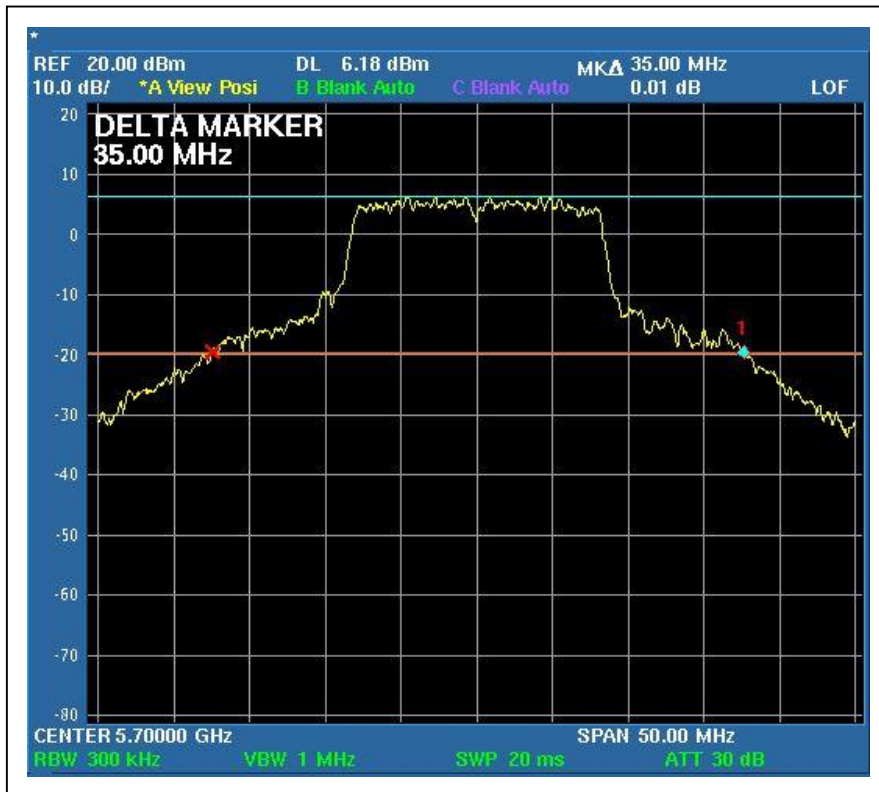

4.4 PEAK POWER EXCURSION MEASUREMENT

4.4.1 LIMITS OF PEAK POWER EXCURSION MEASUREMENT

| Frequency Band | Limit |
|-------------------|-------|
| 5.15 – 5.25 GHz | 13dB |
| 5.25 – 5.35 GHz | 13dB |
| 5.47 – 5.725GHz | 13dB |
| 5.725 – 5.825 GHz | 13dB |

4.4.2 TEST INSTRUMENTS

| Description & Manufacturer | Model No. | Serial No. | Calibrated Until |
|-----------------------------|-----------|------------|------------------|
| ADVANTEST SPECTRUM ANALYZER | U3772 | 160100280 | April. 10.2008 |

NOTE:

- 1.The measurement uncertainty is less than +/- 2.6dB, which is calculated as per the NAMAS document NIS81.
- 2.The calibration interval of the above test instruments is 12 months and the calibrations are traceable to NML/ROC and NIST/USA.

4.4.3 TEST PROCEDURE

1. The transmitter output was connected to the spectrum analyzer.
2. Set the spectrum bandwidth span to view the entire spectrum.
3. Using peak detector and Max-hold function for Trace 1 (RB=1MHz, VB=3MHz) and 2 (RB=1MHz, VB=300KHz).
4. The largest difference between Trace 1 and Trace 2 in any 1MHz band on any frequency was recorded.

4.4.4 DEVIATION FROM TEST STANDARD

No deviation

4.4.5 TEST SETUP



4.4.6 EUT OPERATING CONDITIONS

The software provided by client to enable the EUT under transmission condition continuously at specific channel frequencies individually.



4.4.7 TEST RESULTS

802.11a OFDM modulation

| | | | |
|-----------------------------|---------------|---------------------------------|------------------------|
| MODULATION TYPE | BPSK | TRANSFER RATE | 6Mbps |
| INPUT POWER (SYSTEM) | 120Vac, 60 Hz | ENVIRONMENTAL CONDITIONS | 27deg.C, 53%RH, 960hPa |
| TESTED BY | Rex Huang | | |

| CHANNEL | CHANNEL FREQUENCY (MHz) | PEAK POWER EXCURSION (dB) | PEAK to AVERAGE EXCURSION LIMIT (dB) | PASS/FAIL |
|---------|-------------------------|---------------------------|--------------------------------------|-----------|
| 1 | 5180 | 7.75 | 13 | PASS |
| 4 | 5240 | 7.6 | 13 | PASS |
| 5 | 5260 | 8.11 | 13 | PASS |
| 8 | 5320 | 8.57 | 13 | PASS |
| 9 | 5500 | 8.55 | 13 | PASS |
| 14 | 5600 | 9.07 | 13 | PASS |
| 19 | 5700 | 8.58 | 13 | PASS |

CH1

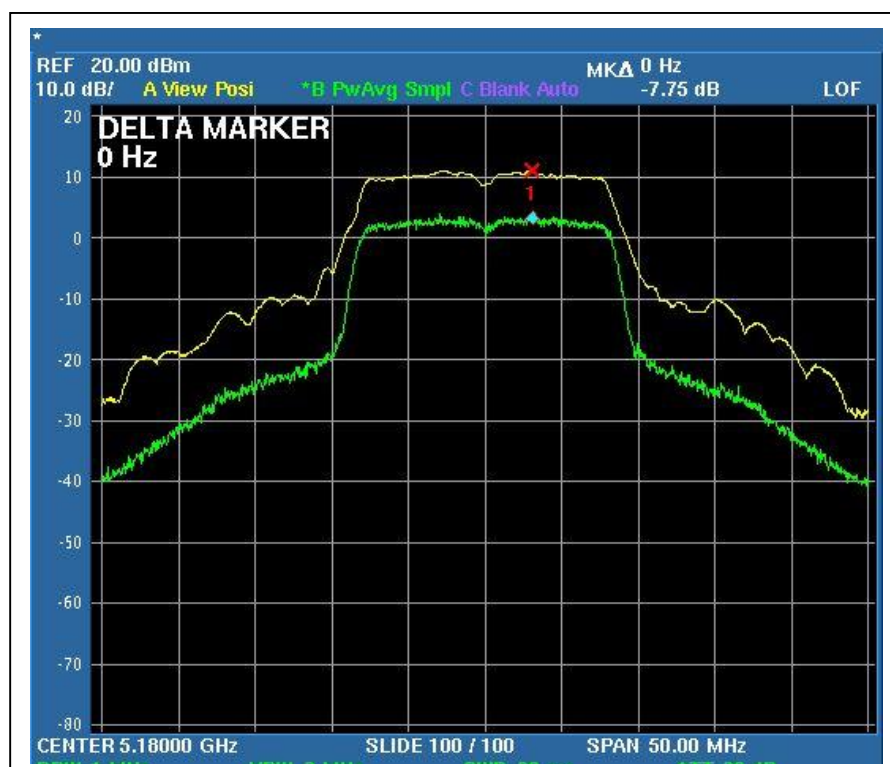

CH4

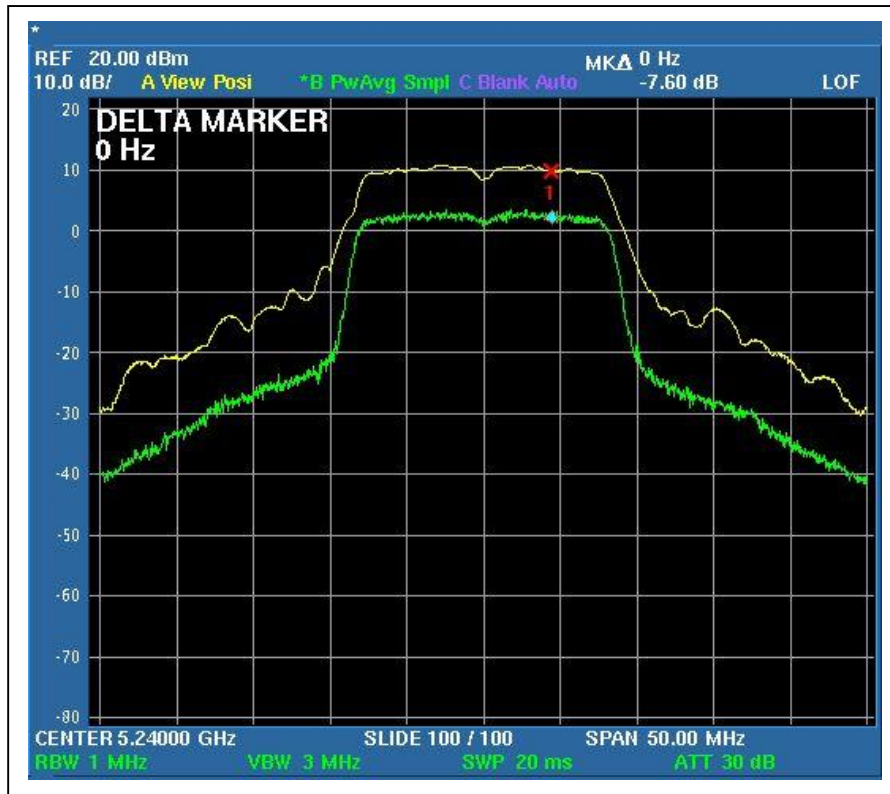

CH5

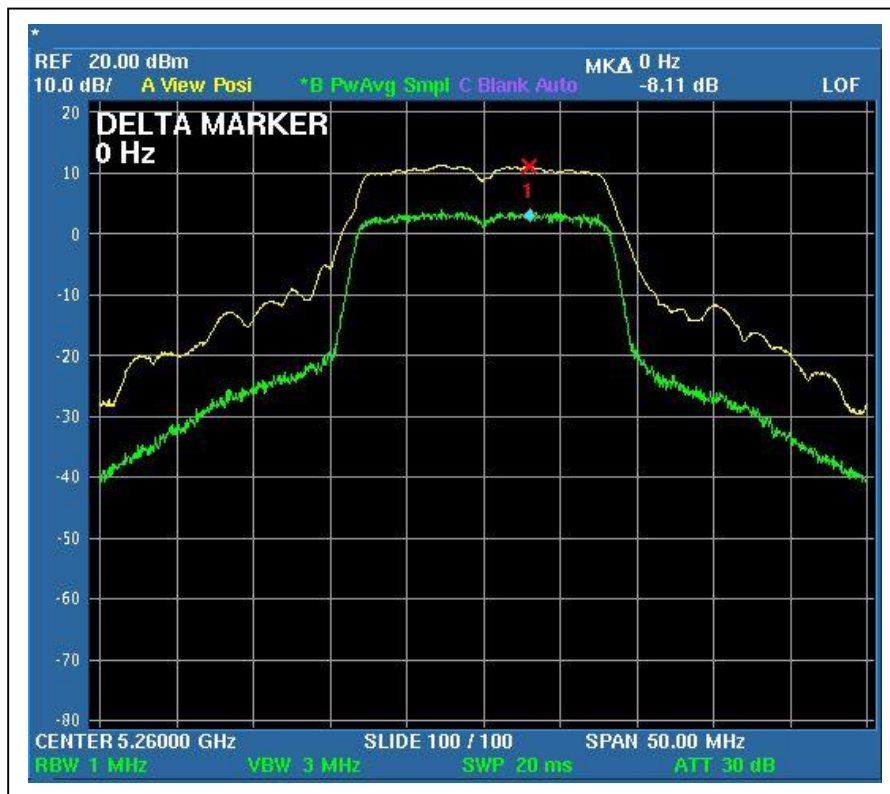

CH8

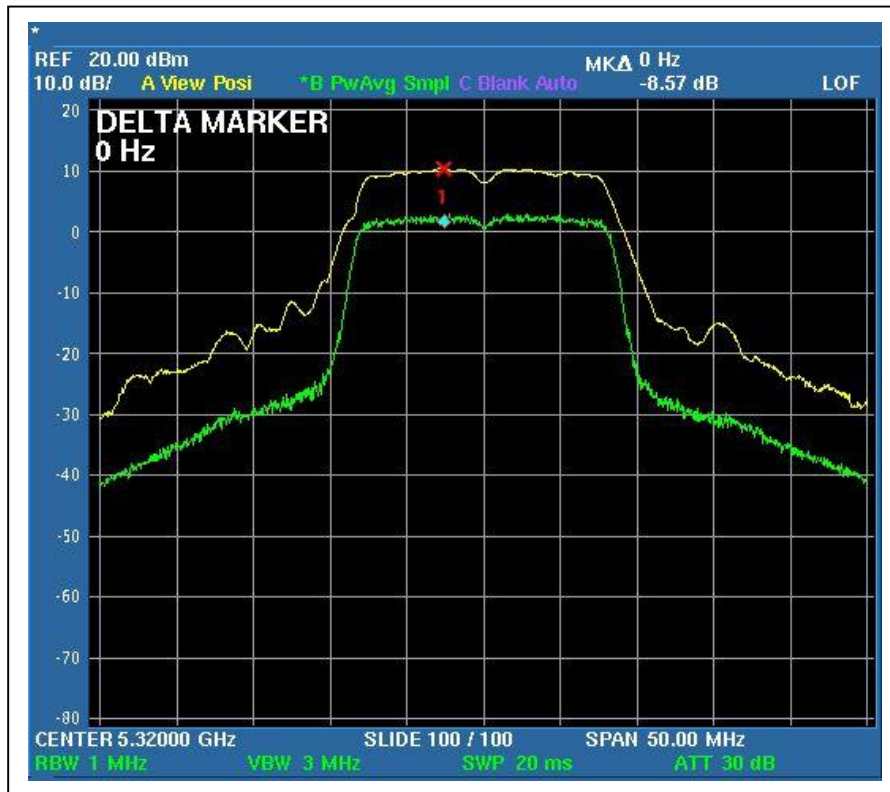

CH9

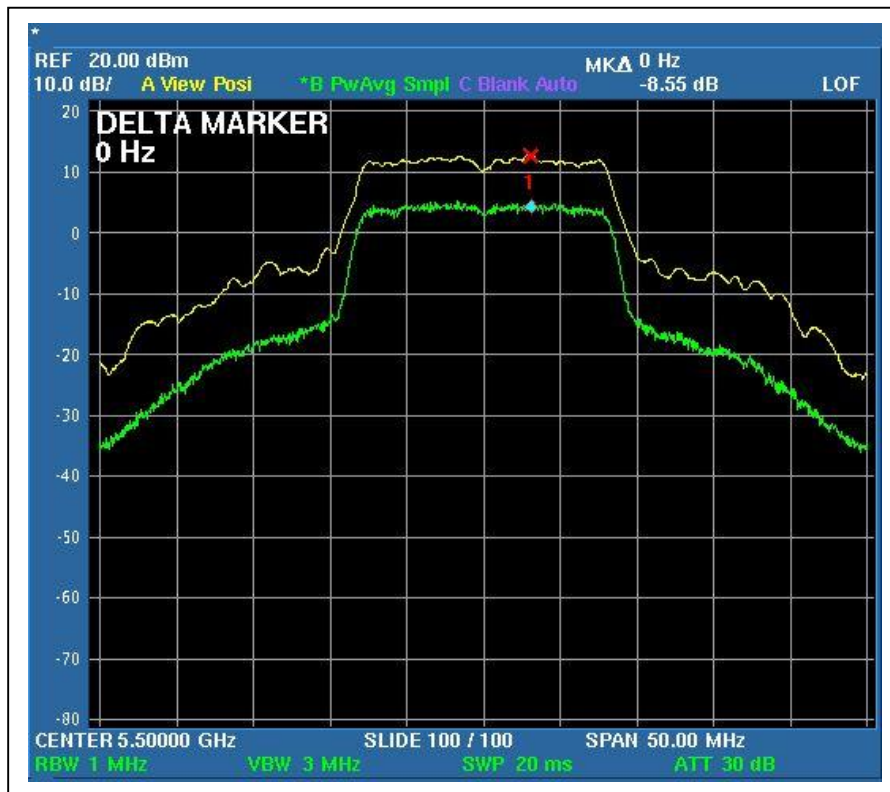

CH14

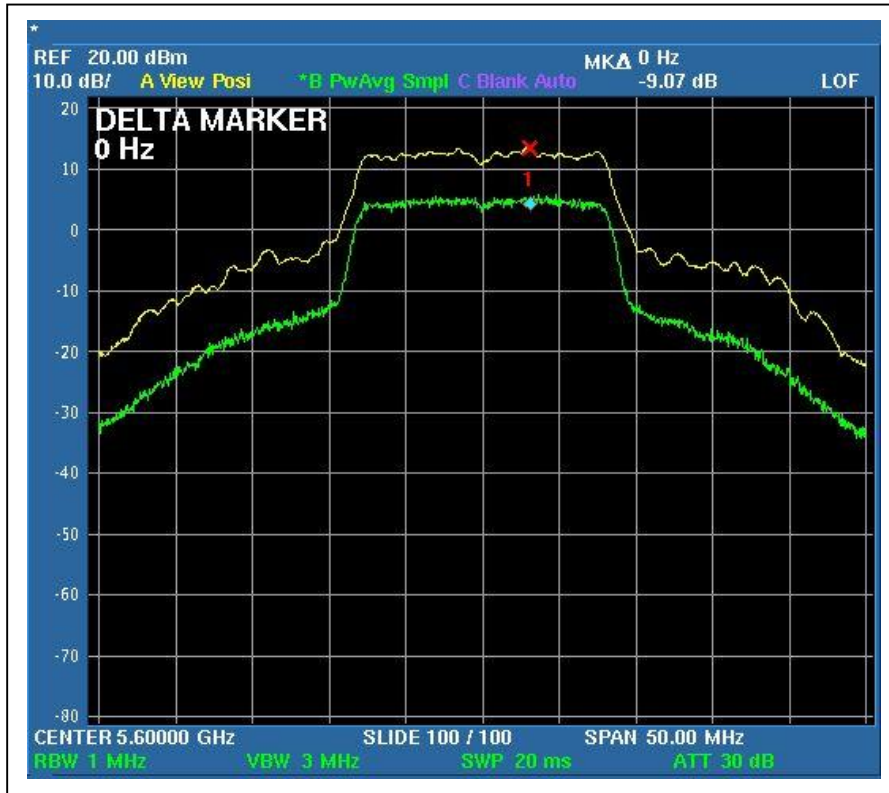

CH19

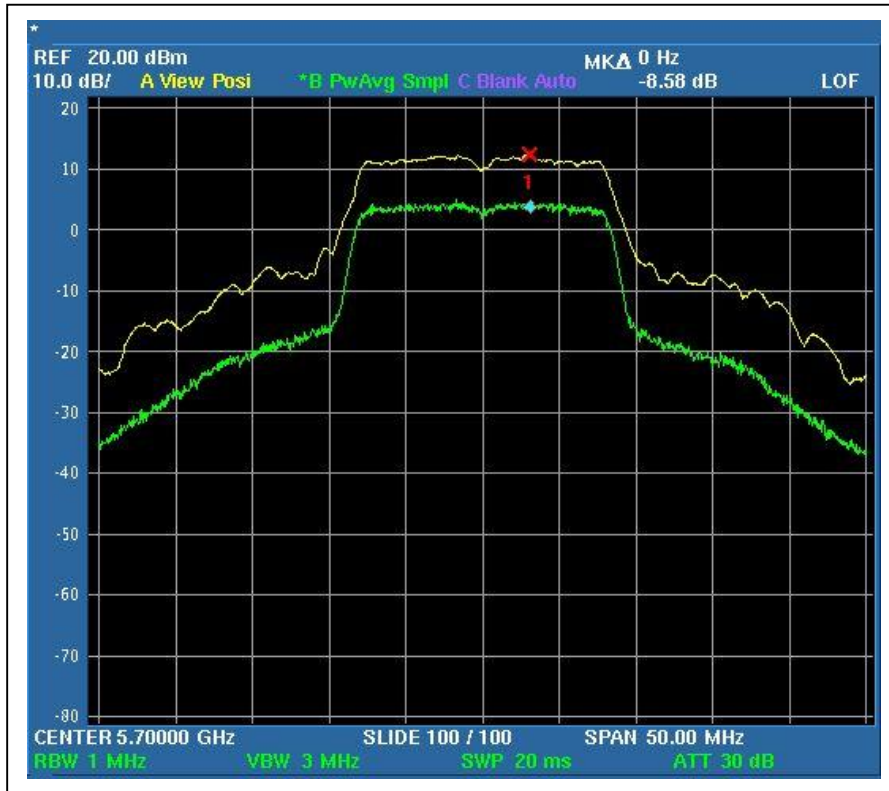

4.5 PEAK POWER SPECTRAL DENSITY MEASUREMENT

4.5.1 LIMITS OF PEAK POWER SPECTRAL DENSITY MEASUREMENT

| Frequency Band | Limit |
|------------------|-------|
| 5.15 ~ 5.25GHz | 4dBm |
| 5.25 ~ 5.35GHz | 11dBm |
| 5.47 – 5.725GHz | 11dBm |
| 5.725 ~ 5.825GHz | 17dBm |

4.5.2 TEST INSTRUMENTS

| Description & Manufacturer | Model No. | Serial No. | Calibrated Until |
|-----------------------------|-----------|------------|------------------|
| ADVANTEST SPECTRUM ANALYZER | U3772 | 160100280 | April. 10.2008 |

NOTE:

- 1.The measurement uncertainty is less than +/- 2.6dB, which is calculated as per the NAMAS document NIS81.
- 2.The calibration interval of the above test instruments is 12 months and the calibrations are traceable to NML/ROC and NIST/USA.