



FCC TEST REPORT

REPORT NO.: RF960112H11

MODEL NO.: LA-5127C1

RECEIVED: Jan. 15, 2007

TESTED: Jan. 16 to 29, 2007

ISSUED: Jan. 30, 2007

APPLICANT: Symbol Technologies Inc.

ADDRESS: One Symbol Plaza, Holtsville, NY 11742- 1300
U.S.A.

ISSUED BY: Advance Data Technology Corporation

LAB LOCATION: No. 81-1, Lu Liao Keng, 9 Ling, Wu Lung Tsuen,
Chiung Lin Hsiang, Hsin Chu Hsien,
Taiwan, R.O.C.

This test report consists of 105 pages in total. It may be duplicated completely for legal use with the approval of the applicant. It should not be reproduced except in full, without the written approval of our laboratory. The client should not use it to claim product endorsement by CNLA, A2LA or any government agencies. The test results in the report only apply to the tested sample.





Table of Contents

1	CERTIFICATION	4
2	SUMMARY OF TEST RESULTS	5
2.1	MEASUREMENT UNCERTAINTY	6
3	GENERAL INFORMATION	7
3.1	GENERAL DESCRIPTION OF EUT	7
3.2	DESCRIPTION OF TEST MODES	9
3.3	TEST MODE APPLICABILITY AND TESTED CHANNEL DETAIL:	10
3.4	GENERAL DESCRIPTION OF APPLIED STANDARDS	12
3.5	DESCRIPTION OF SUPPORT UNITS	13
3.6	CONFIGURATION OF SYSTEM UNDER TEST	13
4	TEST TYPES AND RESULTS	14
4.1	CONDUCTED EMISSION MEASUREMENT	14
4.1.1	LIMITS OF CONDUCTED EMISSION MEASUREMENT	14
4.1.2	TEST INSTRUMENTS	14
4.1.3	TEST PROCEDURES	15
4.1.4	TEST SETUP	15
4.1.5	EUT OPERATING CONDITIONS	16
4.1.6	TEST RESULTS	17
4.2	RADIATED EMISSION MEASUREMENT	19
4.2.1	LIMITS OF RADIATED EMISSION MEASUREMENT	19
4.2.2	TEST INSTRUMENTS	20
4.2.3	TEST PROCEDURES	21
4.2.4	TEST SETUP	22
4.2.5	EUT OPERATING CONDITIONS	22
4.2.6	TEST RESULTS – ANTENNA 1	23
4.2.7	TEST RESULTS – ANTENNA 2	50
4.3	6dB BANDWIDTH MEASUREMENT	77
4.3.1	LIMITS OF 6dB BANDWIDTH MEASUREMENT	77
4.3.2	TEST INSTRUMENTS	77
4.3.3	TEST PROCEDURE	78
4.3.4	TEST SETUP	78
4.3.5	EUT OPERATING CONDITIONS	78
4.3.6	TEST RESULTS	79
4.4	MAXIMUM PEAK OUTPUT POWER	85
4.4.1	LIMITS OF MAXIMUM PEAK OUTPUT POWER MEASUREMENT	85



4.4.2	TEST INSTRUMENTS	85
4.4.3	TEST PROCEDURES	86
4.4.4	TEST SETUP	86
4.4.5	EUT OPERATING CONDITIONS	86
4.4.6	TEST RESULTS.....	87
4.5	POWER SPECTRAL DENSITY MEASUREMENT	89
4.5.1	LIMITS OF POWER SPECTRAL DENSITY MEASUREMENT	89
4.5.2	TEST INSTRUMENTS	89
4.5.3	TEST PROCEDURE	90
4.5.4	TEST SETUP	90
4.5.5	EUT OPERATING CONDITIONS	90
4.5.6	TEST RESULTS.....	91
4.6	BAND EDGES MEASUREMENT	97
4.6.1	LIMITS OF BAND EDGES MEASUREMENT	97
4.6.2	TEST INSTRUMENTS	97
4.6.3	TEST PROCEDURE	97
4.6.4	EUT OPERATING CONDITION	97
4.6.5	TEST RESULTS.....	98
4.7	ANTENNA REQUIREMENT	103
4.7.1	STANDARD APPLICABLE	103
4.7.2	ANTENNA CONNECTED CONSTRUCTION	103
5	INFORMATION ON THE TESTING LABORATORIES.....	104
	APPENDIX-A.....	A-1



1 CERTIFICATION

PRODUCT : 802.11b/g Compact Flash Radio Card
BRAND NAME : Symbol Technologies Inc.
MODEL NO. : LA-5127C1
TESTED: Jan. 16 to 29, 2007
APPLICANT : Symbol Technologies Inc.
TEST ITEM: ENGINEERING SAMPLE
STANDARDS : 47 CFR Part 15, Subpart C (Section 15.247),
ANSI C63.4-2003

The above equipment (Model: LA-5127C1) has been tested by **Advance Data Technology Corporation**, and found compliance with the requirement of the above standards. The test record, data evaluation & Equipment Under Test (EUT) configurations represented herein are true and accurate accounts of the measurements of the sample's EMC characteristics under the conditions specified in this report.

PREPARED BY : Carol Liao , **DATE:** Jan. 30, 2007
(Carol Liao)

TECHNICAL ACCEPTANCE : Hank Chung , **DATE:** Jan. 30, 2007
Responsible for RF (Hank Chung)

APPROVED BY : May Chen , **DATE:** Jan. 30, 2007
(May Chen, Deputy Manager)



2 SUMMARY OF TEST RESULTS

The EUT has been tested according to the following specifications:

APPLIED STANDARD: 47 CFR Part 15, Subpart C			
Standard Section	Test Type and Limit	Result	REMARK
15.207	AC Power Conducted Emission	PASS	Meet the requirement of limit Minimum passing margin is -23.84 dB at 0.330 MHz
15.247(a)(2)	Spectrum Bandwidth of a Direct Sequence Spread Spectrum System Limit: min. 500kHz	PASS	Meet the requirement of limit
15.247(b)	Maximum Peak Output Power Limit: max. 30dBm	PASS	Meet the requirement of limit
15.247(c)	Transmitter Radiated Emissions Limit: Table 15.209	PASS	Meet the requirement of limit Minimum passing margin is -0.40 dB at 2390.0 MHz
15.247(d)	Power Spectral Density Limit: max. 8dBm	PASS	Meet the requirement of limit
15.247(c)	Band Edge Measurement Limit: 20 dB less than the peak value of fundamental frequency	PASS	Meet the requirement of limit

2.1 MEASUREMENT UNCERTAINTY

Where relevant, the following measurement uncertainty levels have been estimated for tests performed on the EUT as specified in CISPR 16-4:

This uncertainty represents an expanded uncertainty expressed at approximately the 95% confidence level using a coverage factor of $k=2$.

Measurement	Value
Conducted emissions	2.26 dB
Radiated emissions (30MHz-1GHz)	2.98 dB
Radiated emissions (1GHz ~18GHz)	2.21 dB
Radiated emissions (18GHz ~40GHz)	1.88 dB



3 GENERAL INFORMATION

3.1 GENERAL DESCRIPTION OF EUT

PRODUCT	802.11b/g Compact Flash Radio Card
MODEL NO.	LA-5127C1
FCC ID	H9PLA5127C1
POWER SUPPLY	DC 3.3 V +/-5% from host equipment
MODULATION TYPE	CCK, DQPSK, DBPSK for DSSS 64QAM, 16QAM, QPSK, BPSK for OFDM
RADIO TECHNOLOGY	DSSS, OFDM
TRANSFER RATE	802.11b: 11/5.5/2/1Mbps 802.11g: 54/48/36/24/18/12/9/6Mbps
FREQUENCY RANGE	2412MHz ~ 2462MHz
NUMBER OF CHANNEL	11
CHANNEL SPACING	5MHz
OUTPUT POWER	802.11b: 58.884mW 802.11g: 57.544mW
ANTENNA TYPE	Please see note 1
DATA CABLE	NA
I/O PORTS	NA
ASSOCIATED DEVICES	NA

NOTE:

1. There are two antennas provided to this EUT, please refer to the following table:

No.	Model No.	Gain (dBi)	Antenna Type	Antenna Connector	Condition (*)	Net gain (dBi)
1	Printronic-HG2403RD-RSF	3	Dipole	R-SMA	Condition 1: 1dB Condition 2: 0.9dB	Condition 1: 2 Condition 2: 2.1
*There will have two conditions for this antenna: Condition 1: RF Cable(10cm)+PCB trace(1cm)/Cable loss:HG2403RD-RSF Short cable(Include PCB Trace):1dB Condition 2: RF Cable(23cm)/ cable loss:HG2403RD- RSF Long cable: 0.9dB						
No.	Model No.	Gain (dBi)	Antenna Type	Antenna Connector	Cable loss	Net gain (dBi)
2	ML-2452-APA2-01	3	Dipole	R-SMA	0.9dB	2.1

2. For Antenna 1, the EUT was pre-tested in chamber with the following test modes:

Test Mode	Description
Mode 1	RF Cable(10cm)+PCB trace(1cm)/Cable loss:HG2403RD-RSF Short cable(Include PCB Trace):1dB
Mode 2	RF Cable(23cm)/Cable loss:HG2403RD-RSF Long cable:0.9dB

Mode 2, the worse case one, was chosen for final test.

3. The EUT, operates in the 2.4GHz frequency range, lets you connect IEEE 802.11g or IEEE 802.11b devices to the network. With its high-speed data transmissions of up to 54Mbps.

4. The above EUT information was declared by the manufacturer and for more detailed features description, please refer to the manufacturer's specifications or User's Manual.

3.2 DESCRIPTION OF TEST MODES

Operated in 2400 ~ 2483.5MHz band:

For 802.11b/g normal mode: Eleven channels are provided to this EUT.

Channel	Frequency	Channel	Frequency
1	2412 MHz	7	2442 MHz
2	2417 MHz	8	2447 MHz
3	2422 MHz	9	2452 MHz
4	2427 MHz	10	2457 MHz
5	2432 MHz	11	2462 MHz
6	2437 MHz		

3.3 TEST MODE APPLICABILITY AND TESTED CHANNEL DETAIL:

EUT configure mode	Applicable to				Description
	PLC	RE<1G	RE≥1G	APCM	
-	√	√	√	√	NA

Where PLC: Power Line Conducted Emission RE<1G RE: Radiated Emission below 1GHz
 RE≥1G: Radiated Emission above 1GHz APCM: Antenna Port Conducted Measurement

Power Line Conducted Emission Test:

- Pre-Scan has been conducted to determine the worst-case mode from all possible combinations between available modulations, data rates and antenna ports (if EUT with antenna diversity architecture).
- Following channel(s) was (were) selected for the final test as listed below.

Mode	Available Channel	Tested Channel	Modulation Technology	Modulation Type	Data Rate (Mbps)
802.11b	1 to 11	1	DSSS	CCK	1

Radiated Emission Test (Below 1 GHz):

- Pre-Scan has been conducted to determine the worst-case mode from all possible combinations between available modulations, data rates and antenna ports (if EUT with antenna diversity architecture).
- Following channel(s) was (were) selected for the final test as listed below.

Mode	Available Channel	Tested Channel	Modulation Technology	Modulation Type	Data Rate (Mbps)
802.11g	1 to 11	1	OFDM	BPSK	6

- The EUT was tested with the following modes:

Test Mode	Description
Mode 1	With Antenna 1
Mode 2	With Antenna 2

Radiated Emission Test (Above 1 GHz):

- Pre-Scan has been conducted to determine the worst-case mode from all possible combinations between available modulations, data rates and antenna ports (if EUT with antenna diversity architecture).
- Following channel(s) was (were) selected for the final test as listed below.

Mode	Available Channel	Tested Channel	Modulation Technology	Modulation Type	Data Rate (Mbps)
802.11b	1 to 11	1, 6, 11	DSSS	CCK	1
802.11g	1 to 11	1, 2, 6, 10, 11	OFDM	BPSK	6

- The EUT was tested with the following modes:

Test Mode	Description
Mode 1	With Antenna 1
Mode 2	With Antenna 2



Bandedge Measurement:

Pre-Scan has been conducted to determine the worst-case mode from all possible combinations between available modulations, data rates and antenna ports (if EUT with antenna diversity architecture).

Following channel(s) was (were) selected for the final test as listed below.

Mode	Available Channel	Tested Channel	Modulation Technology	Modulation Type	Data Rate (Mbps)
802.11b	1 to 11	1, 11	DSSS	CCK	1
802.11g	1 to 11	1, 11	OFDM	BPSK	6

Antenna Port Conducted Measurement:

Pre-Scan has been conducted to determine the worst-case mode from all possible combinations between available modulations, data rates and antenna ports (if EUT with antenna diversity architecture).

Following channel(s) was (were) selected for the final test as listed below.

Mode	Available Channel	Tested Channel	Modulation Technology	Modulation Type	Data Rate (Mbps)
802.11b	1 to 11	1, 6, 11	DSSS	CCK	1
802.11g	1 to 11	1, 2, 6, 10, 11	OFDM	BPSK	6



3.4 GENERAL DESCRIPTION OF APPLIED STANDARDS

The EUT is an 802.11b/g Compact Flash Radio Card. According to the specifications of the manufacturer, it must comply with the requirements of the following standards:

47 CFR Part 15, Subpart C. (15.247)
ANSI C63.4 : 2003

All tests have been performed and recorded as per the above standards.

NOTE: The EUT is also considered as a kind of computer peripheral, because the connection to computer is necessary for typical use. It has been verified to comply with the requirements of 47 CFR Part 15, Subpart B, Class B (DoC). The test report has been issued separately.

3.5 DESCRIPTION OF SUPPORT UNITS

The EUT has been tested as an independent unit together with other necessary accessories or support units. The following support units or accessories were used to form a representative test configuration during the tests.

No.	Product	Brand	Model No.	Serial No.	FCC ID
1	NOTEBOOK COMPUTER	IBM	2672	9949APL	DoC

No.	Signal cable description
1	NA

Note: 1. All power cords of the above support units are unshielded (1.8m).

3.6 CONFIGURATION OF SYSTEM UNDER TEST

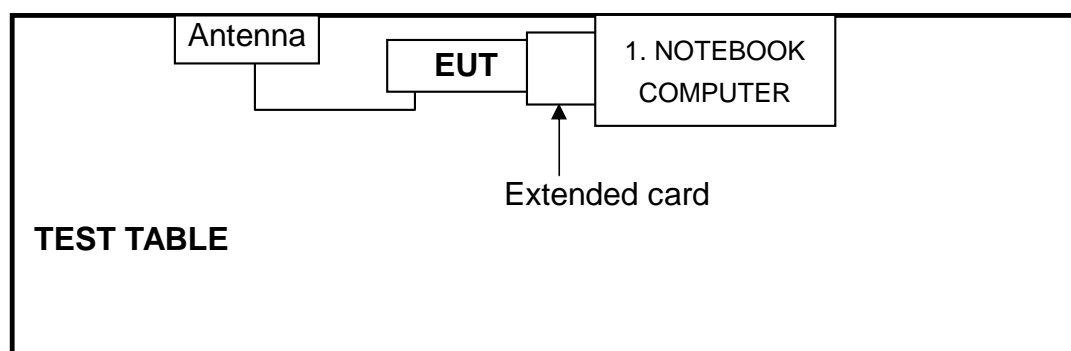

NOTE: 1. Please refer to the photos of test configuration.



4 TEST TYPES AND RESULTS

4.1 CONDUCTED EMISSION MEASUREMENT

4.1.1 LIMITS OF CONDUCTED EMISSION MEASUREMENT

FREQUENCY OF EMISSION (MHz)	CONDUCTED LIMIT (dB μ V)	
	Quasi-peak	Average
0.15-0.5	66 to 56	56 to 46
0.5-5	56	46
5-30	60	50

NOTE:

1. The lower limit shall apply at the transition frequencies.
2. All emanations from a class B digital device or system, including any network of conductors and apparatus connected thereto, shall not exceed the level of field strengths specified above.

4.1.2 TEST INSTRUMENTS

DESCRIPTION & MANUFACTURER	MODEL NO.	SERIAL NO.	CALIBRATED UNTIL
Test Receiver	ESCS 30	847124/029	Dec. 14, 2007
Line-Impedance Stabilization Network(for EUT)	ENV-216	100071	Nov. 26, 2007
Line-Impedance Stabilization Network(for Peripheral)	KNW-407	8/1395/12	Aug. 15, 2007
RF Cable (JETBAO)	RG233/U	Cable_CB_01	Dec. 09, 2007
Terminator	50	2	Oct. 30, 2007
Software	ADT_Cond_V7.3.2	NA	NA

- NOTE: 1. The calibration interval of the above test instruments is 12 months and the calibrations are traceable to NML/ROC and NIST/USA.
 2. The test was performed in ADT Shielded Room No. B.
 3. The VCCI Con B Registration No. is C-2193.

4.1.3 TEST PROCEDURES

- a. The EUT/HOST was placed 0.4 meters from the conducting wall of the shielded room with EUT/HOST being connected to the power mains through a line impedance stabilization network (LISN). Other support units were connected to the power mains through another LISN. The two LISNs provide 50 ohm/ 50uH of coupling impedance for the measuring instrument.
- b. Both lines of the power mains connected to the EUT/HOST were checked for maximum conducted interference.
- c. The frequency range from 150 kHz to 30 MHz was searched. Emission levels over 10dB under the prescribed limits could not be reported

4.1.4 TEST SETUP

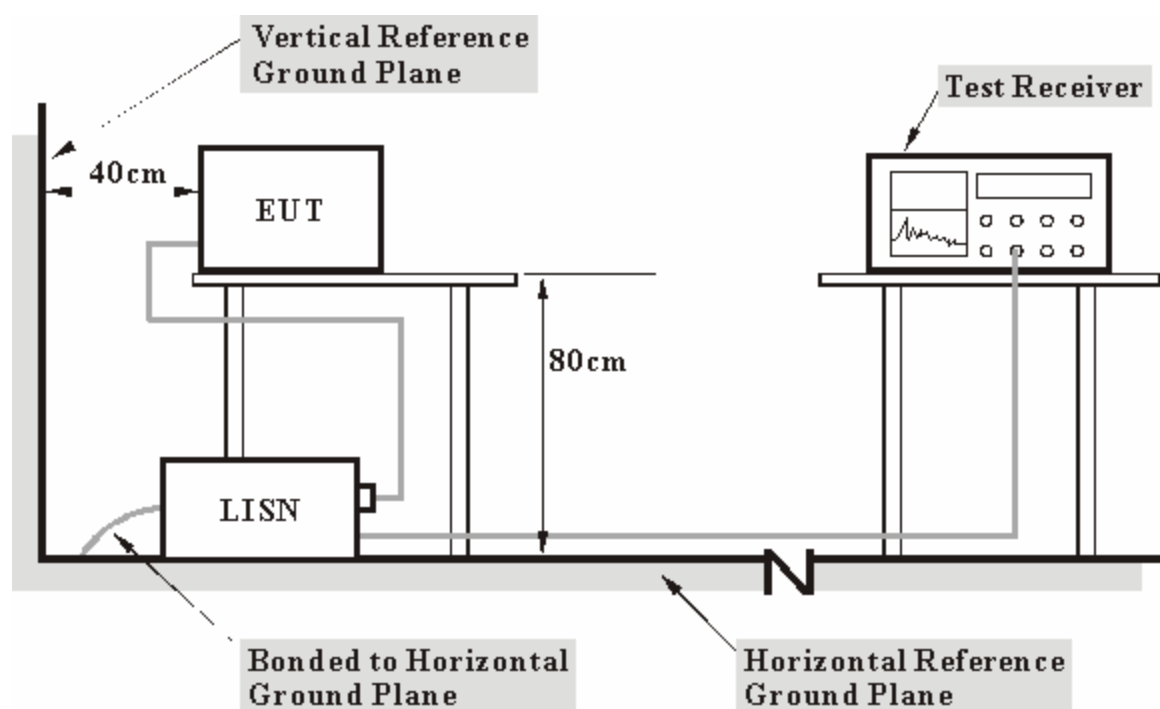

- Note:**
1. Support units were connected to second LISN.
 2. Both of LISNs (AMN) 80 cm from EUT and at the least 80 cm from other units and other metal planes support units.

For the actual test configuration, please refer to the related item – Photographs of the Test Configuration.

4.1.5 EUT OPERATING CONDITIONS

- a. Connect the EUT with the support unit 1 (Notebook computer) via one Express card and placed it on the testing table.
- b. The support unit 1 (Notebook computer) ran a test program “cTxRx 3.0.1.1” to enable EUT under transmission condition continuously at specific channel frequency.

4.1.6 TEST RESULTS

MODULATION TYPE	CCK	CHANNEL	Channel 1
INPUT POWER (SYSTEM)	120Vac, 60 Hz	6dB BANDWIDTH	9 kHz
ENVIRONMENTAL CONDITIONS	20deg. C, 63%RH, 980hPa	TRANSFER RATE	1Mbps
TESTED BY	Tony Chen	PHASE	Line (L)

No	Freq. [MHz]	Corr. Factor (dB)	Reading Value		Emission Level		Limit		Margin	
			[dB (uV)]		[dB (uV)]		[dB (uV)]		(dB)	
			Q.P.	AV.	Q.P.	AV.	Q.P.	AV.	Q.P.	AV.
1	0.173	9.60	10.78	-	20.38	-	64.79	54.79	-44.41	-
2	0.330	9.60	26.02	-	35.62	-	59.46	49.46	-23.84	-
3	0.685	9.60	18.75	-	28.35	-	56.00	46.00	-27.65	-
4	1.484	9.65	20.25	-	29.90	-	56.00	46.00	-26.10	-
5	3.855	9.70	15.99	-	25.69	-	56.00	46.00	-30.31	-
6	6.105	9.77	15.72	-	25.49	-	60.00	50.00	-34.51	-

- REMARKS:**
1. Q.P. and AV. are abbreviations of quasi-peak and average individually.
 2. "-": The Quasi-peak reading value also meets average limit and measurement with the average detector is unnecessary.
 3. The emission levels of other frequencies were very low against the limit.
 4. Margin value = Emission level - Limit value
 5. Correction factor = Insertion loss + Cable loss
 6. Emission Level = Correction Factor + Reading Value.

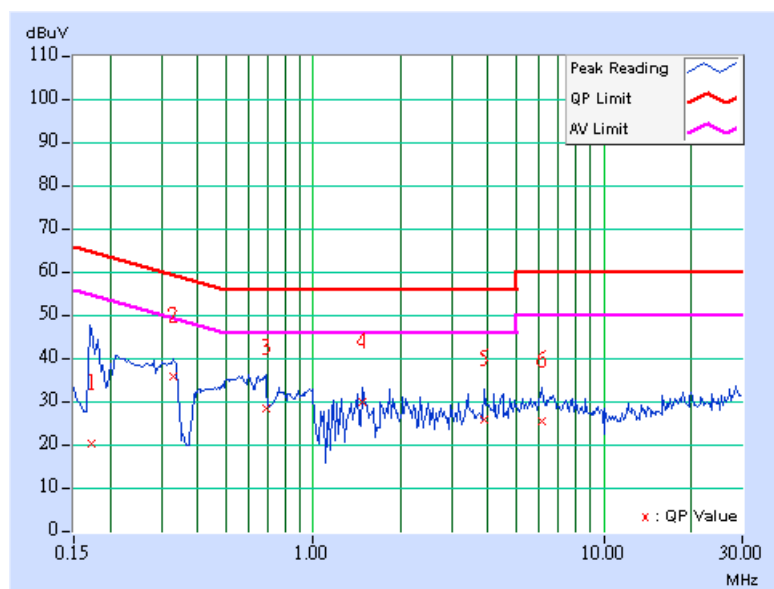

MODULATION TYPE	CCK	CHANNEL	Channel 1
INPUT POWER (SYSTEM)	120Vac, 60 Hz	6dB BANDWIDTH	9 kHz
ENVIRONMENTAL CONDITIONS	20deg. C, 63%RH, 980hPa	TRANSFER RATE	1Mbps
TESTED BY	Tony Chen	PHASE	Neutral (N)

No	Freq. [MHz]	Corr. Factor (dB)	Reading Value		Emission Level		Limit		Margin	
			[dB (uV)]		[dB (uV)]		[dB (uV)]		(dB)	
			Q.P.	AV.	Q.P.	AV.	Q.P.	AV.	Q.P.	AV.
1	0.170	9.60	11.40	-	21.00	-	64.98	54.98	-43.98	-
2	0.330	9.60	18.41	-	28.01	-	59.46	49.46	-31.45	-
3	0.685	9.60	17.86	-	27.46	-	56.00	46.00	-28.54	-
4	1.422	9.64	21.53	-	31.17	-	56.00	46.00	-24.83	-
5	3.855	9.70	16.89	-	26.59	-	56.00	46.00	-29.41	-
6	6.105	9.77	13.14	-	22.91	-	60.00	50.00	-37.09	-

- REMARKS:**
1. Q.P. and AV. are abbreviations of quasi-peak and average individually.
 2. "-": The Quasi-peak reading value also meets average limit and measurement with the average detector is unnecessary.
 3. The emission levels of other frequencies were very low against the limit.
 4. Margin value = Emission level - Limit value
 5. Correction factor = Insertion loss + Cable loss
 6. Emission Level = Correction Factor + Reading Value.

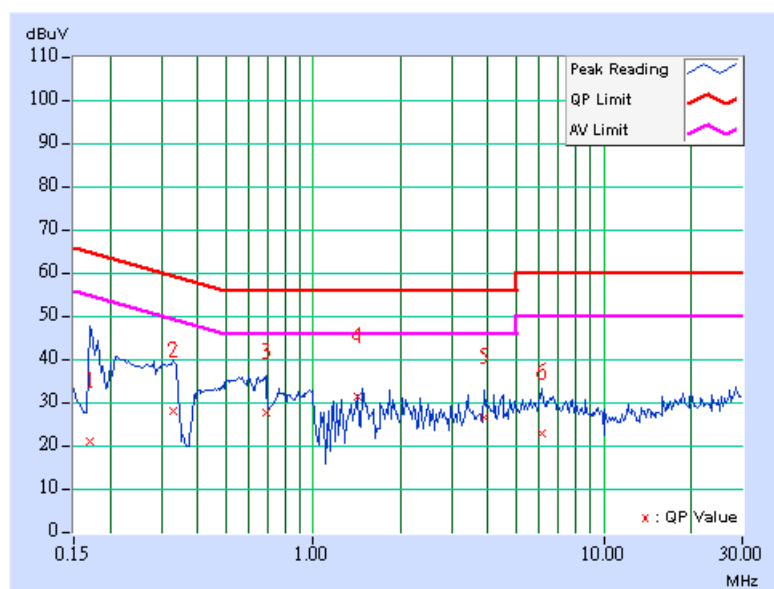

4.2 RADIATED EMISSION MEASUREMENT

4.2.1 LIMITS OF RADIATED EMISSION MEASUREMENT

Emissions radiated outside of the specified bands, shall be according to the general radiated limits in 15.209 as following:

Frequencies (MHz)	Field strength (microvolts/meter)	Measurement distance (meters)
0.009-0.490	2400/F(kHz)	300
0.490-1.705	24000/F(kHz)	30
1.705-30.0	30	30
30-88	100	3
88-216	150	3
216-960	200	3
Above 960	500	3

NOTE:

1. The lower limit shall apply at the transition frequencies.
2. Emission level (dBuV/m) = 20 log Emission level (uV/m).
3. As shown in 15.35(b), for frequencies above 1000MHz, the field strength limits are based on average detector, however, the peak field strength of any emission shall not exceed the maximum permitted average limits, specified above by more than 20dB under any condition of modulation.



4.2.2 TEST INSTRUMENTS

DESCRIPTION & MANUFACTURER	MODEL NO.	SERIAL NO.	CALIBRATED UNTIL
ADVANTEST Spectrum Analyzer	R3271A	85060311	July 03, 2007
HP Pre_Amplifier	8449B	3008A01922	Sep. 18, 2007
ROHDE & SCHWARZ Test Receiver	ESCS30	100375	Sep. 20, 2007
CHASE Broadband Antenna	VULB 9168	138	Dec. 10, 2007
Schwarzbeck Horn_Antenna	BBHA9120	D124	Jan. 01, 2008
Schwarzbeck Horn_Antenna	BBHA 9170	BBHA9170153	Jan. 04, 2008
SCHWARZBECK Biconical Antenna	VHBA9123	459	Jun. 08, 2009
SCHWARZBECK Periodic Antenna	UPA6108	1148	Jun. 08, 2009
R&S Loop Antenna	HFH2-Z2	881058/15	Nov. 29, 2007
RF Switches (ARNITSU)	CS-201	1565157	NA
RF CABLE (Chaintek)	SF102	22054-2	Nov. 14, 2007
RF Cable(RICHTEC)	9913-30M N-N Cable	STCCAB-30M-1 GHz	Jul. 15, 2007
Software	ADT_Radiated_V 5.14	NA	NA
CHANCE MOST Antenna Tower	AT-100	0203	NA
CHANCE MOST Turn Table	TT-100	0203	NA

- Note: 1. The calibration interval of the above test instruments is 12 months (36 months for Biconical and Periodic Antenna) and the calibrations are traceable to NML/ROC and NIST/USA.
2. The horn antenna, HP preamplifier (model: 8449B) and Spectrum Analyzer (model: R3271A) are used only for the measurement of emission frequency above 1GHz if tested.
3. The test was performed in ADT Open Site No. C.
4. The FCC Site Registration No. is 656396.
5. The VCCI Site Registration No. is R-1626.
6. The CANADA Site Registration No. is IC 4824A-3.
7. Loop antenna was used for all emissions below 30 MHz.

4.2.3 TEST PROCEDURES

- a. The EUT was placed on the top of a rotating table 0.8 meters above the ground at a 10 meter open area test site. The table was rotated 360 degrees to determine the position of the highest radiation.
- b. The EUT was set 3 meters away from the interference-receiving antenna, which was mounted on the top of a variable-height antenna tower.
- c. The antenna is a broadband antenna, and its height is varied from one meter to four meters above the ground to determine the maximum value of the field strength. Both horizontal and vertical polarizations of the antenna are set to make the measurement.
- d. For each suspected emission, the EUT was arranged to its worst case and then the antenna was tuned to heights from 1 meter to 4 meters and the rotatable table was turned from 0 degrees to 360 degrees to find the maximum reading.
- e. The test-receiver system was set to Peak Detect Function and Specified Bandwidth with Maximum Hold Mode.
- f. If the emission level of the EUT in peak mode was 10 dB lower than the limit specified, then testing could be stopped and the peak values of the EUT would be reported. Otherwise the emissions that did not have 10 dB margin would be re-tested one by one using peak, quasi-peak or average method as specified and then reported in a data sheet.

NOTE:

1. The resolution bandwidth and video bandwidth of test receiver/spectrum analyzer is 120kHz for Peak detection (PK) and Quasi-peak detection (QP) at frequency below 1GHz.
2. The resolution bandwidth is 1MHz and video bandwidth of test receiver/spectrum analyzer is 3MHz for Peak detection at frequency above 1GHz.
3. The resolution bandwidth of test receiver/spectrum analyzer is 1 MHz and the video bandwidth is 10 Hz for Average detection (AV) at frequency above 1GHz.

4.2.4 TEST SETUP

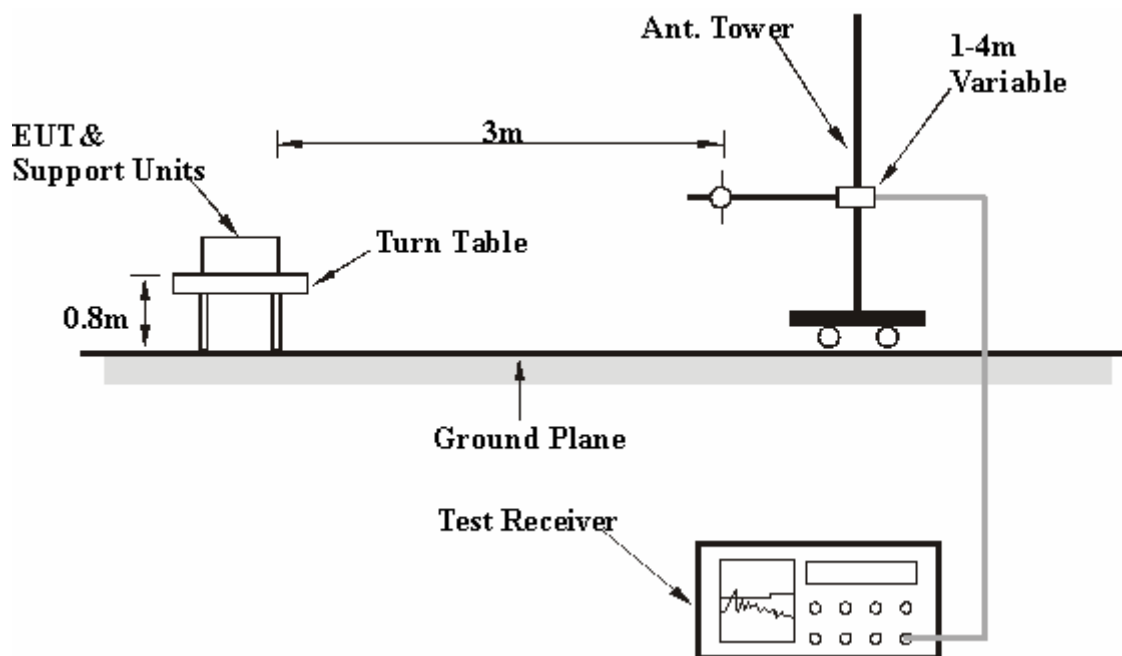

For the actual test configuration, please refer to the related item – Photographs of the Test Configuration.

4.2.5 EUT OPERATING CONDITIONS

Same as 4.1.5



4.2.6 TEST RESULTS – Antenna 1

Below 1GHz Worst-Case Data

MODULATION TYPE	CCK	CHANNEL	Channel 1
INPUT POWER (SYSTEM)	120Vac, 60 Hz	FREQUENCY RANGE	30-1000 MHz
ENVIRONMENTAL CONDITIONS	22deg. C, 64%RH, 980hPa	TRANSFER RATE	1Mbps
TESTED BY	Sky Liao	DETECTOR FUNCTION	Quasi-Peak, 120kHz

ANTENNA POLARITY & TEST DISTANCE: HORIZONTAL AT 3 M

No.	Freq. (MHz)	Emission Level (dBuV/m)	Limit (dBuV/m)	Margin (dB)	Antenna Height (m)	Table Angle (Degree)	Raw Value (dBuV)	Correction Factor (dB/m)
1	133.21	26.80 QP	43.50	-16.70	1.40 H	127	14.00	12.90
2	149.05	22.40 QP	43.50	-21.10	1.86 H	344	8.60	13.80
3	166.54	32.00 QP	43.50	-11.50	1.67 H	1	18.30	13.80
4	233.20	27.30 QP	46.00	-18.70	1.34 H	39	14.30	13.00
5	399.71	31.60 QP	46.00	-14.40	1.77 H	42	12.60	19.00
6	499.70	28.40 QP	46.00	-17.60	1.35 H	212	6.70	21.80
7	666.38	31.40 QP	46.00	-14.60	1.50 H	274	6.10	25.30
8	932.69	34.30 QP	46.00	-11.70	1.67 H	155	4.80	29.50

ANTENNA POLARITY & TEST DISTANCE: VERTICAL AT 3 M

No.	Freq. (MHz)	Emission Level (dBuV/m)	Limit (dBuV/m)	Margin (dB)	Antenna Height (m)	Table Angle (Degree)	Raw Value (dBuV)	Correction Factor (dB/m)
1	133.12	30.60 QP	43.50	-12.90	1.00 V	210	17.70	12.90
2	146.80	28.30 QP	43.50	-15.20	1.00 V	1	14.60	13.70
3	166.45	28.40 QP	43.50	-15.10	1.00 V	34	14.60	13.80
4	233.17	27.40 QP	46.00	-18.60	1.00 V	341	14.30	13.00
5	399.77	32.50 QP	46.00	-13.50	1.28 V	135	13.50	19.00
6	500.08	26.00 QP	46.00	-20.00	1.00 V	318	4.30	21.80
7	666.73	30.20 QP	46.00	-15.80	1.00 V	60	4.90	25.30
8	933.25	33.70 QP	46.00	-12.30	1.00 V	286	4.20	29.50

- REMARKS:**
1. Emission level(dBuV/m)=Raw Value(dBuV) + Correction Factor(dB/m)
 2. Correction Factor(dB/m) = Antenna Factor (dB/m) + Cable Factor (dB)
 3. The other emission levels were very low against the limit.
 4. Margin value = Emission level – Limit value.



802.11b DSSS modulation

MODE	Channel 1	FREQUENCY RANGE	1000~25000MHz
INPUT POWER (SYSTEM)	120Vac, 60 Hz	DETECTOR FUNCTION & BANDWIDTH	Peak (PK) Average (AV) 1 MHz
ENVIRONMENTAL CONDITIONS	18 deg. C, 56%RH, 980hPa	TESTED BY	Rex Huang

ANTENNA POLARITY & TEST DISTANCE: HORIZONTAL AT 3 M

No.	Freq. (MHz)	Emission Level (dBuV/m)	Limit (dBuV/m)	Margin (dB)	Antenna Height (m)	Table Angle (Degree)	Raw Value (dBuV)	Correction Factor (dB/m)
1	2386.16	57.30 PK	74.00	-16.70	1.22 H	77	25.38	31.92
1	2386.16	46.80 AV	54.00	-7.20	1.22 H	77	14.88	31.92
2	*2412.00	101.40 PK			1.23 H	99	69.38	32.02
2	*2412.00	96.20 AV			1.23 H	99	64.18	32.02
3	4824.00	44.80 PK	74.00	-29.20	1.00 H	243	8.83	35.97
3	4824.00	36.80 AV	54.00	-17.20	1.00 H	243	0.83	35.97
4	7236.00	56.38 PK	74.00	-17.62	1.00 H	116	14.14	42.24
4	7236.00	44.08 AV	54.00	-9.92	1.00 H	116	1.84	42.24

ANTENNA POLARITY & TEST DISTANCE: VERTICAL AT 3 M

No.	Freq. (MHz)	Emission Level (dBuV/m)	Limit (dBuV/m)	Margin (dB)	Antenna Height (m)	Table Angle (Degree)	Raw Value (dBuV)	Correction Factor (dB/m)
1	2386.00	62.00 PK	74.00	-12.00	1.15 V	282	30.08	31.92
1	2386.00	52.50 AV	54.00	-1.50	1.15 V	282	20.58	31.92
2	*2412.00	107.70 PK			1.15 V	282	75.68	32.02
2	*2412.00	103.00 AV			1.15 V	282	70.98	32.02
3	4824.00	47.10 PK	74.00	-26.90	1.04 V	331	11.13	35.97
3	4824.00	36.80 AV	54.00	-17.20	1.04 V	331	0.83	35.97
4	7236.00	57.28 PK	74.00	-16.72	1.06 V	116	15.04	42.24
4	7236.00	43.08 AV	54.00	-10.92	1.06 V	116	0.84	42.24

- REMARKS:**
1. Emission level(dBuV/m)=Raw Value(dBuV) + Correction Factor(dB/m)
 2. Correction Factor(dB/m) = Antenna Factor (dB/m) + Cable Factor (dB)
 3. The other emission levels were very low against the limit.
 4. Margin value = Emission level – Limit value.
 5. The limit value is defined as per 15.247
 6. " * " : Fundamental frequency



MODE	Channel 2	FREQUENCY RANGE	1000~25000MHz
INPUT POWER (SYSTEM)	120Vac, 60 Hz	DETECTOR FUNCTION & BANDWIDTH	Peak (PK) Average (AV) 1 MHz
ENVIRONMENTAL CONDITIONS	18 deg. C, 56%RH, 980hPa	TESTED BY	Rex Huang

ANTENNA POLARITY & TEST DISTANCE: HORIZONTAL AT 3 M

No.	Freq. (MHz)	Emission Level (dBuV/m)	Limit (dBuV/m)	Margin (dB)	Antenna Height (m)	Table Angle (Degree)	Raw Value (dBuV)	Correction Factor (dB/m)
1	2386.00	57.60 PK	74.00	-16.40	1.40 H	256	25.70	31.90
1	2386.00	45.60 AV	54.00	-8.40	1.40 H	256	13.70	31.90
2	*2417.00	102.10 PK			1.20 H	100	70.10	32.00
2	*2417.00	96.80 AV			1.20 H	100	64.80	32.00

ANTENNA POLARITY & TEST DISTANCE: VERTICAL AT 3 M

No.	Freq. (MHz)	Emission Level (dBuV/m)	Limit (dBuV/m)	Margin (dB)	Antenna Height (m)	Table Angle (Degree)	Raw Value (dBuV)	Correction Factor (dB/m)
1	2390.00	69.00 PK	74.00	-5.00	1.34 V	245	37.10	31.90
1	2390.00	52.20 AV	54.00	-1.80	1.34 V	245	20.30	31.90
2	*2417.00	107.90 PK			1.20 V	300	75.90	32.00
2	*2417.00	103.20 AV			1.20 V	300	71.20	32.00

- REMARKS:**
1. Emission level(dBuV/m)=Raw Value(dBuV) + Correction Factor(dB/m)
 2. Correction Factor(dB/m) = Antenna Factor (dB/m) + Cable Factor (dB)
 3. The other emission levels were very low against the limit.
 4. Margin value = Emission level – Limit value.
 5. The limit value is defined as per 15.247
 6. “ * “ : Fundamental frequency

MODE	Channel 6	FREQUENCY RANGE	1000~25000MHz
INPUT POWER (SYSTEM)	120Vac, 60 Hz	DETECTOR FUNCTION & BANDWIDTH	Peak (PK) Average (AV) 1 MHz
ENVIRONMENTAL CONDITIONS	18 deg. C, 56%RH, 980hPa	TESTED BY	Rex Huang

ANTENNA POLARITY & TEST DISTANCE: HORIZONTAL AT 3 M								
No.	Freq. (MHz)	Emission Level (dBuV/m)	Limit (dBuV/m)	Margin (dB)	Antenna Height (m)	Table Angle (Degree)	Raw Value (dBuV)	Correction Factor (dB/m)
1	*2437.00	105.30 PK			1.21 H	77	73.19	32.11
1	*2437.00	100.10 AV			1.21 H	77	67.99	32.11
2	4874.00	45.31 PK	74.00	-28.69	1.14 H	61	9.23	36.08
2	4874.00	36.11 AV	54.00	-17.89	1.14 H	61	0.03	36.08
3	7311.00	58.27 PK	74.00	-15.73	1.27 H	245	15.75	42.52
3	7311.00	46.27 AV	54.00	-7.73	1.27 H	245	3.75	42.52

ANTENNA POLARITY & TEST DISTANCE: VERTICAL AT 3 M								
No.	Freq. (MHz)	Emission Level (dBuV/m)	Limit (dBuV/m)	Margin (dB)	Antenna Height (m)	Table Angle (Degree)	Raw Value (dBuV)	Correction Factor (dB/m)
1	*2437.00	109.40 PK			1.12 V	282	77.29	32.11
1	*2437.00	104.80 AV			1.12 V	282	72.69	32.11
2	4874.00	48.61 PK	74.00	-25.39	1.26 V	318	12.53	36.08
2	4874.00	39.61 AV	54.00	-14.39	1.26 V	318	3.53	36.08
3	7311.00	59.27 PK	74.00	-14.73	1.05 V	55	16.75	42.52
3	7311.00	46.07 AV	54.00	-7.93	1.05 V	55	3.55	42.52

- REMARKS:**
1. Emission level(dBuV/m)=Raw Value(dBuV) + Correction Factor(dB/m)
 2. Correction Factor(dB/m) = Antenna Factor (dB/m) + Cable Factor (dB)
 3. The other emission levels were very low against the limit.
 4. Margin value = Emission level – Limit value.
 5. The limit value is defined as per 15.247
 6. “ * “ : Fundamental frequency



MODE	Channel 10	FREQUENCY RANGE	1000~25000MHz
INPUT POWER (SYSTEM)	120Vac, 60 Hz	DETECTOR FUNCTION & BANDWIDTH	Peak (PK) Average (AV) 1 MHz
ENVIRONMENTAL CONDITIONS	18 deg. C, 56%RH, 980hPa	TESTED BY	Rex Huang

ANTENNA POLARITY & TEST DISTANCE: HORIZONTAL AT 3 M

No.	Freq. (MHz)	Emission Level (dBuV/m)	Limit (dBuV/m)	Margin (dB)	Antenna Height (m)	Table Angle (Degree)	Raw Value (dBuV)	Correction Factor (dB/m)
1	*2457.00	101.30 PK			1.19 H	120	69.10	32.20
1	*2457.00	95.70 AV			1.19 H	120	63.50	32.20
2	2487.00	59.00 PK	74.00	-15.00	1.54 H	241	26.70	32.30
2	2487.00	46.70 AV	54.00	-7.30	1.54 H	241	14.40	32.30

ANTENNA POLARITY & TEST DISTANCE: VERTICAL AT 3 M

No.	Freq. (MHz)	Emission Level (dBuV/m)	Limit (dBuV/m)	Margin (dB)	Antenna Height (m)	Table Angle (Degree)	Raw Value (dBuV)	Correction Factor (dB/m)
1	*2457.00	110.10 PK			1.20 V	280	77.90	32.20
1	*2457.00	106.30 AV			1.20 V	280	74.10	32.20
2	2483.50	59.70 PK	74.00	-14.30	1.23 V	250	27.40	32.30
2	2483.50	47.40 AV	54.00	-6.60	1.23 V	250	15.10	32.30

- REMARKS:**
1. Emission level(dBuV/m)=Raw Value(dBuV) + Correction Factor(dB/m)
 2. Correction Factor(dB/m) = Antenna Factor (dB/m) + Cable Factor (dB)
 3. The other emission levels were very low against the limit.
 4. Margin value = Emission level – Limit value.
 5. The limit value is defined as per 15.247
 6. “ * “ : Fundamental frequency



MODE	Channel 11	FREQUENCY RANGE	1000~25000MHz
INPUT POWER (SYSTEM)	120Vac, 60 Hz	DETECTOR FUNCTION & BANDWIDTH	Peak (PK) Average (AV) 1 MHz
ENVIRONMENTAL CONDITIONS	18 deg. C, 56%RH, 980hPa	TESTED BY	Rex Huang

ANTENNA POLARITY & TEST DISTANCE: HORIZONTAL AT 3 M

No.	Freq. (MHz)	Emission Level (dBuV/m)	Limit (dBuV/m)	Margin (dB)	Antenna Height (m)	Table Angle (Degree)	Raw Value (dBuV)	Correction Factor (dB/m)
1	*2462.00	100.20 PK			1.17 H	99	67.99	32.21
1	*2462.00	94.70 AV			1.17 H	99	62.49	32.21
2	2487.79	58.20 PK	74.00	-15.80	1.18 H	99	25.90	32.30
2	2487.79	46.30 AV	54.00	-7.70	1.18 H	99	14.00	32.30
3	4924.00	48.12 PK	74.00	-25.88	1.40 H	227	11.93	36.19
3	4924.00	41.22 AV	54.00	-12.78	1.40 H	227	5.03	36.19
4	7386.00	56.95 PK	74.00	-17.05	1.14 H	117	14.15	42.80
4	7386.00	45.35 AV	54.00	-8.65	1.14 H	117	2.55	42.80

ANTENNA POLARITY & TEST DISTANCE: VERTICAL AT 3 M

No.	Freq. (MHz)	Emission Level (dBuV/m)	Limit (dBuV/m)	Margin (dB)	Antenna Height (m)	Table Angle (Degree)	Raw Value (dBuV)	Correction Factor (dB/m)
1	*2462.00	109.50 PK			1.12 V	282	77.29	32.21
1	*2462.00	105.00 AV			1.12 V	282	72.79	32.21
2	2488.00	62.80 PK	74.00	-11.20	1.12 V	282	30.50	32.30
2	2488.00	51.60 AV	54.00	-2.40	1.12 V	282	19.30	32.30
3	4924.00	47.22 PK	74.00	-26.78	1.00 V	309	11.03	36.19
3	4924.00	37.42 AV	54.00	-16.58	1.00 V	309	1.23	36.19
4	7386.00	57.45 PK	74.00	-16.55	1.13 V	90	14.65	42.80
4	7386.00	43.65 AV	54.00	-10.35	1.13 V	90	0.85	42.80

- REMARKS:**
1. Emission level(dBuV/m)=Raw Value(dBuV) + Correction Factor(dB/m)
 2. Correction Factor(dB/m) = Antenna Factor (dB/m) + Cable Factor (dB)
 3. The other emission levels were very low against the limit.
 4. Margin value = Emission level – Limit value.
 5. The limit value is defined as per 15.247
 6. “ * “ : Fundamental frequency

RESTRICTED BANDEDGE (802.11b MODE,CH1, HORIZONTAL)

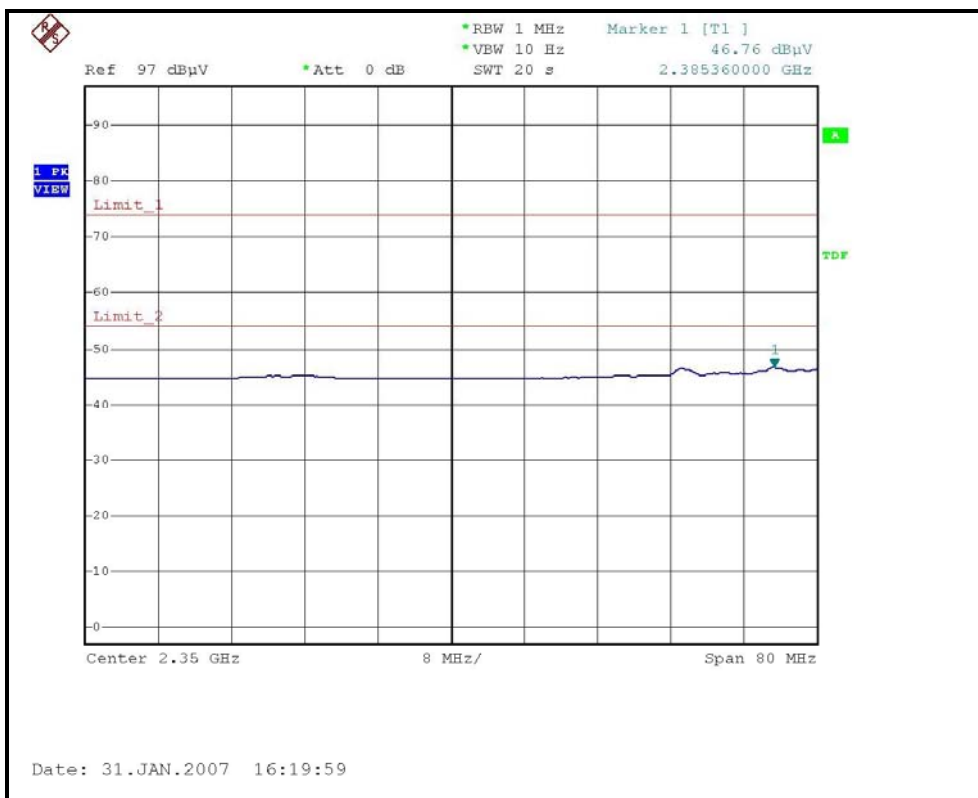
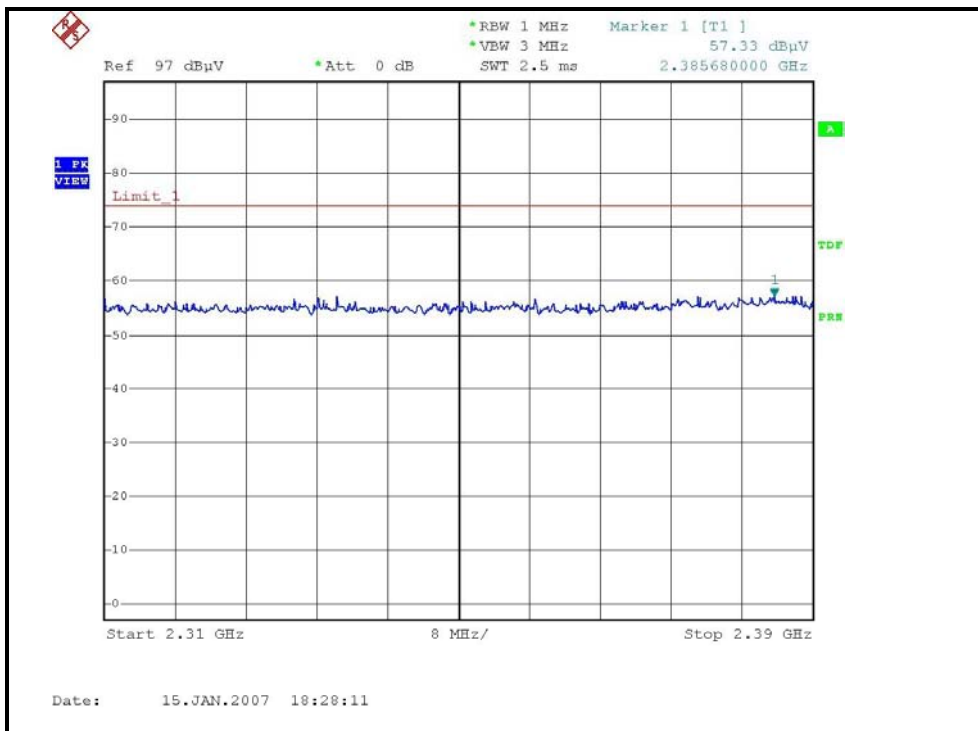

RESTRICTED BANDEDGE (802.11b MODE,CH1, VERTICAL)

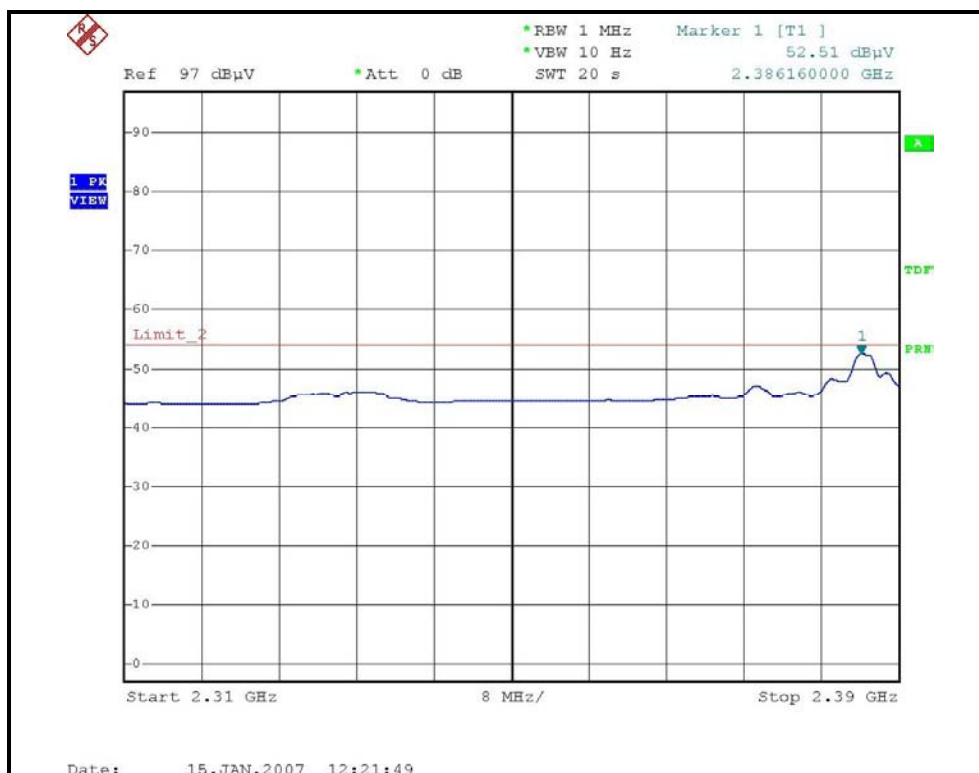
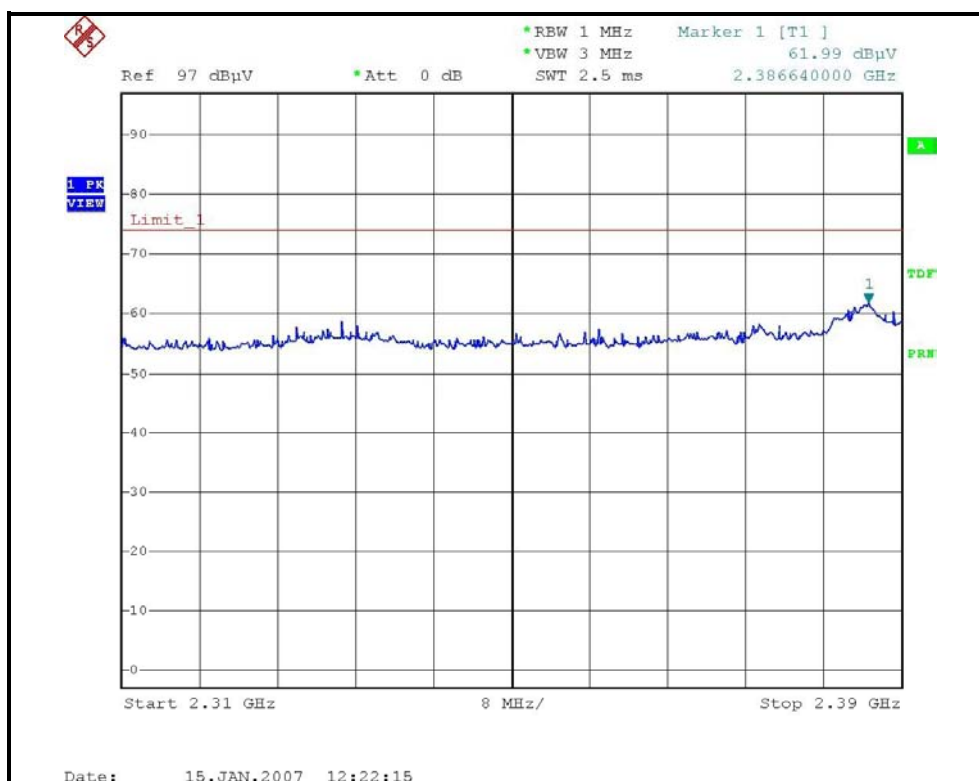



RESTRICTED BANDEDGE (802.11b MODE,CH2, HORIZONTAL)

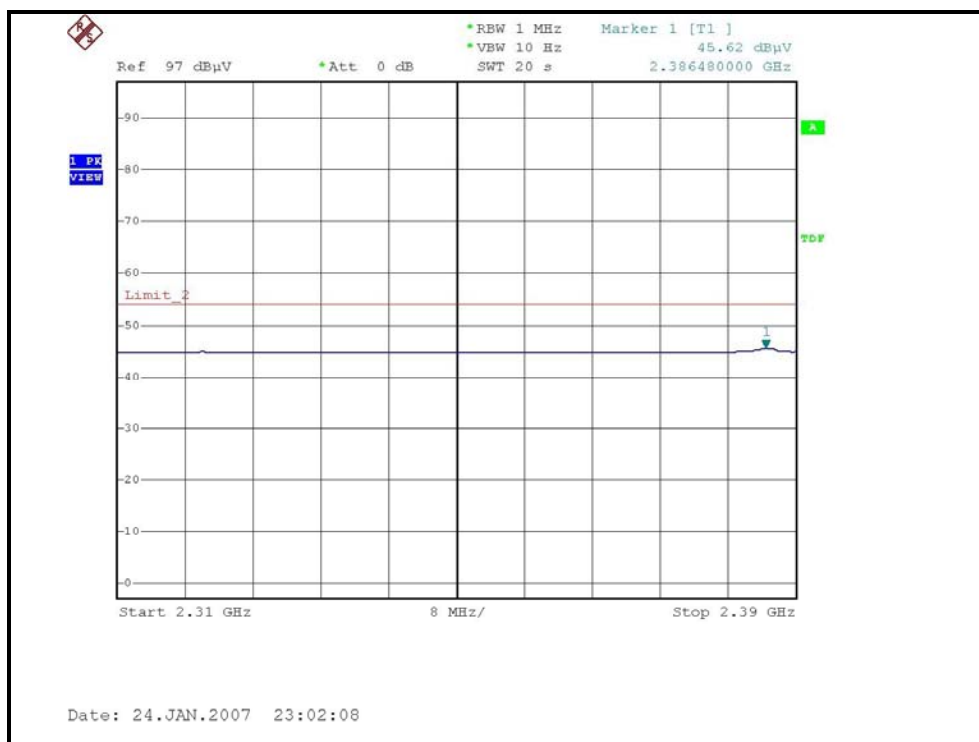
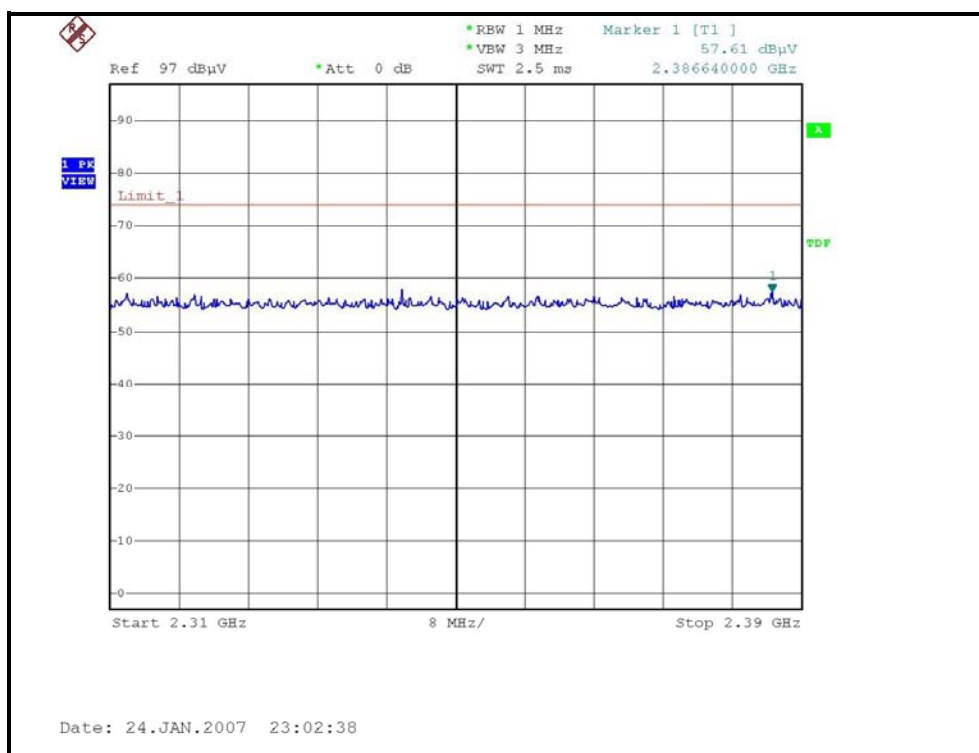

RESTRICTED BANDEDGE (802.11b MODE,CH2, VERTICAL)

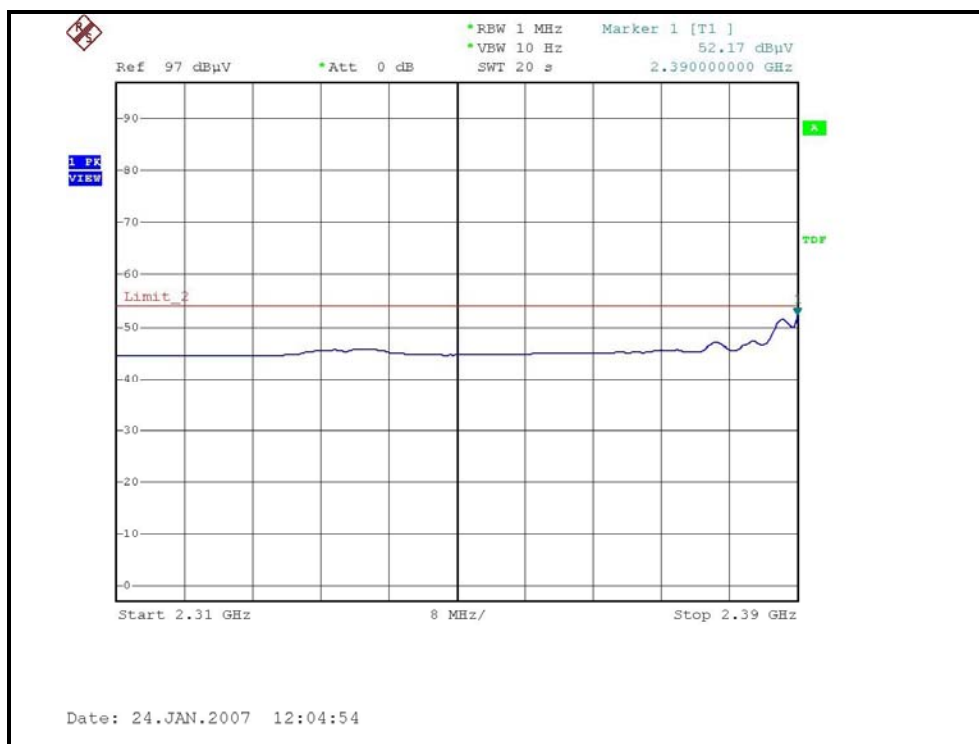
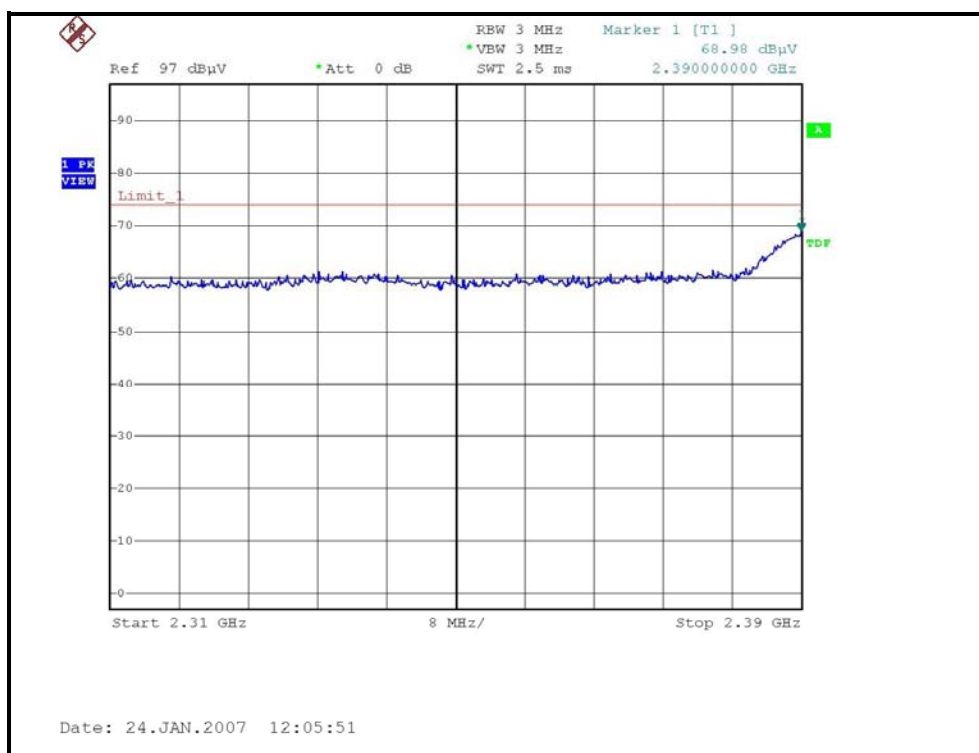

RESTRICTED BANDEDGE (802.11b MODE,CH10, HORIZONTAL)

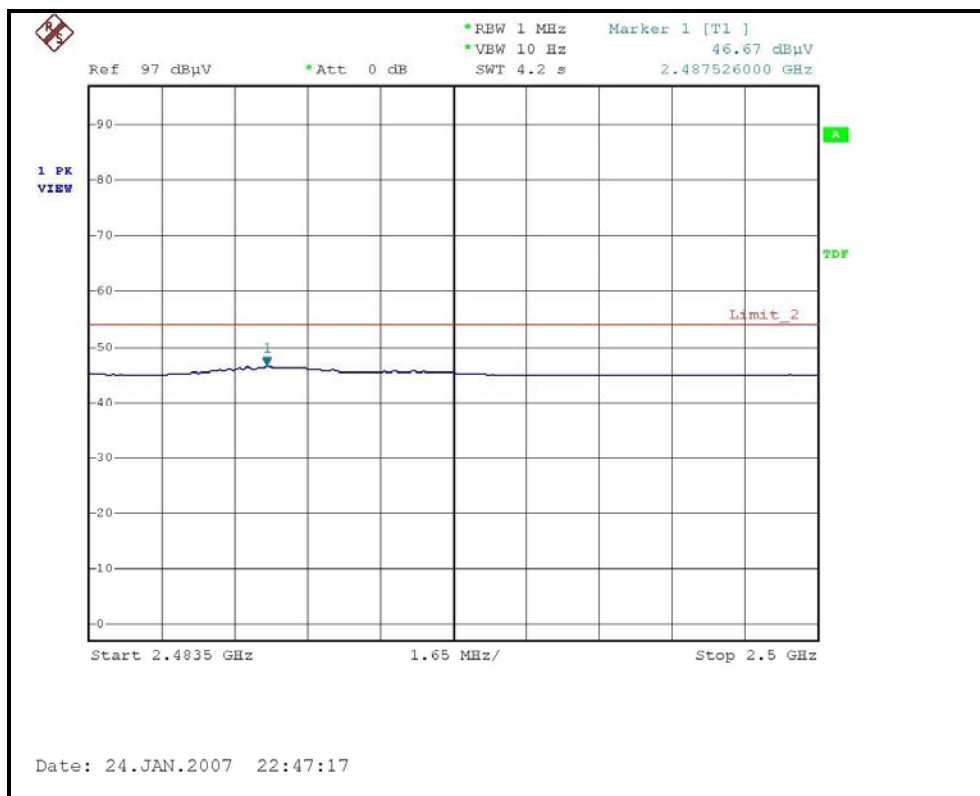
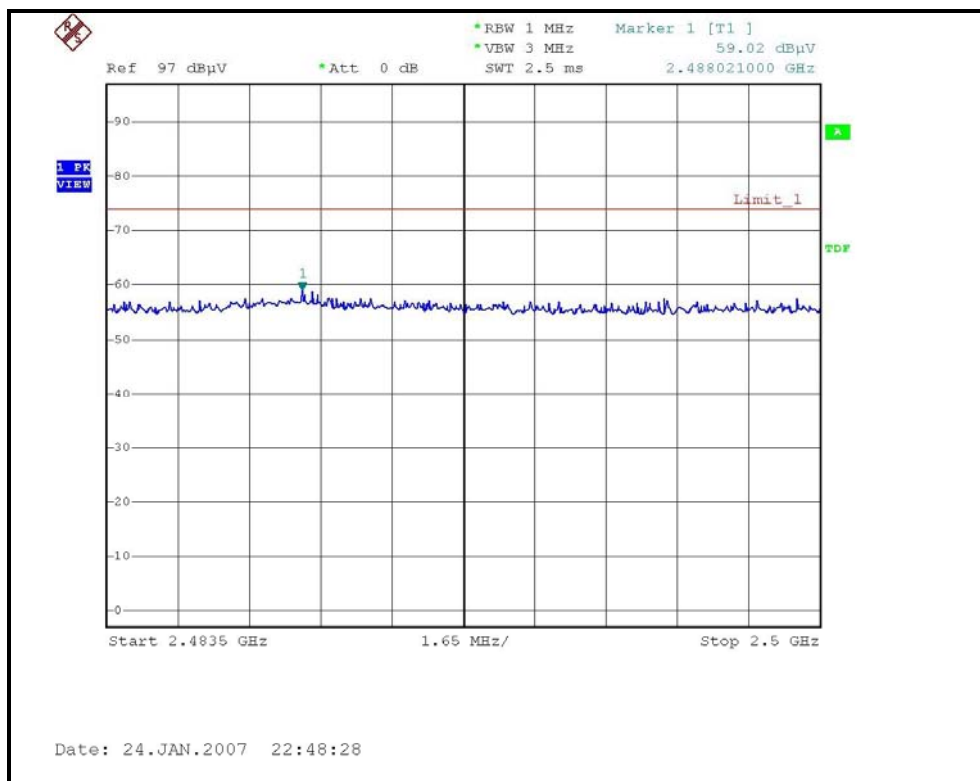



RESTRICTED BANDEDGE (802.11b MODE,CH10, VERTICAL)

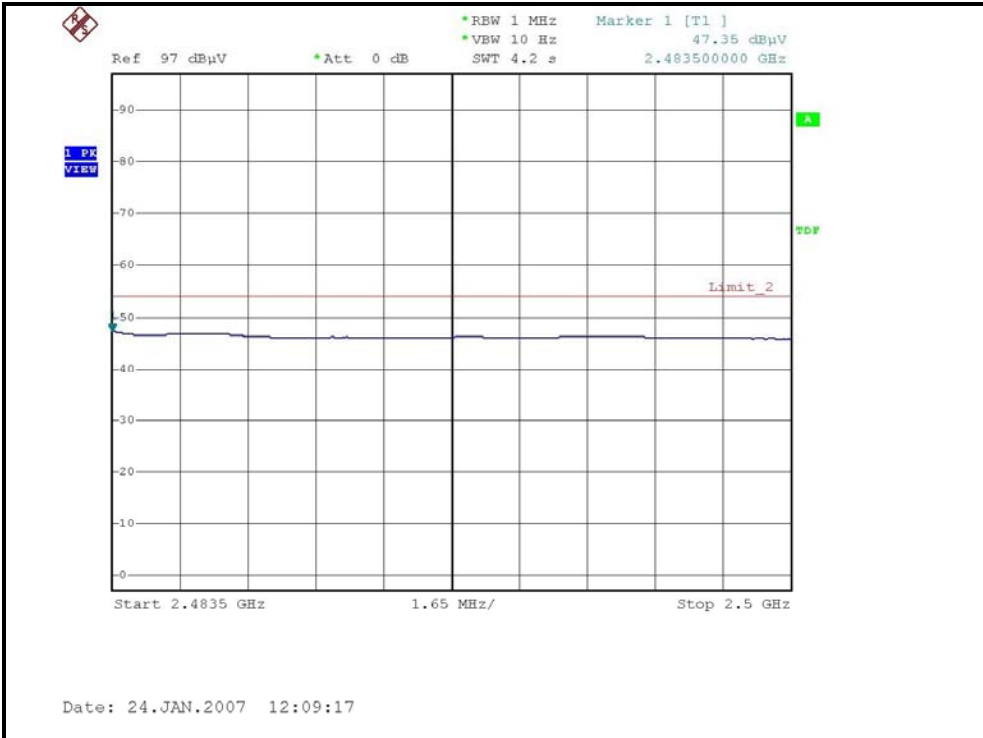
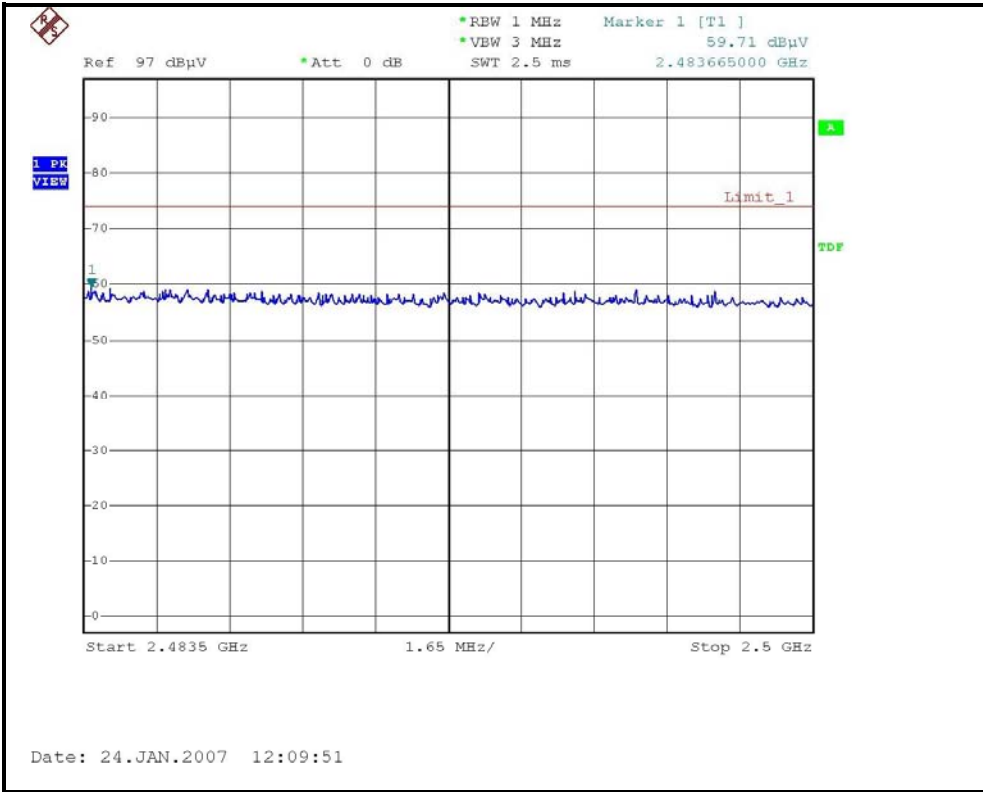

RESTRICTED BANDEDGE (802.11b MODE, CH11, HORIZONTAL)

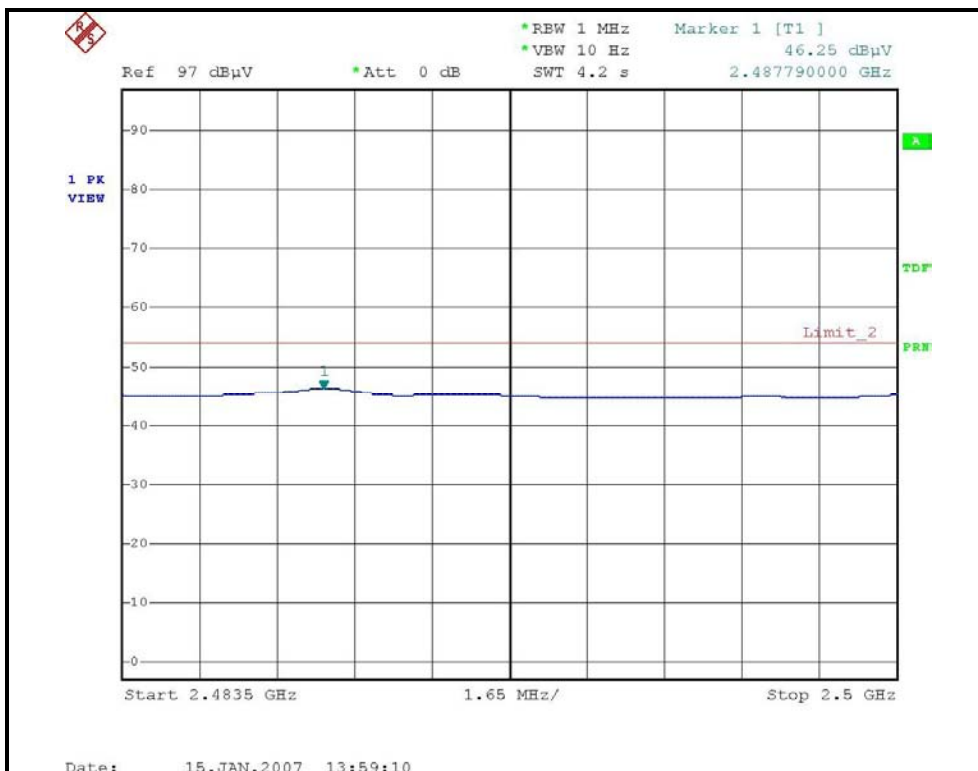
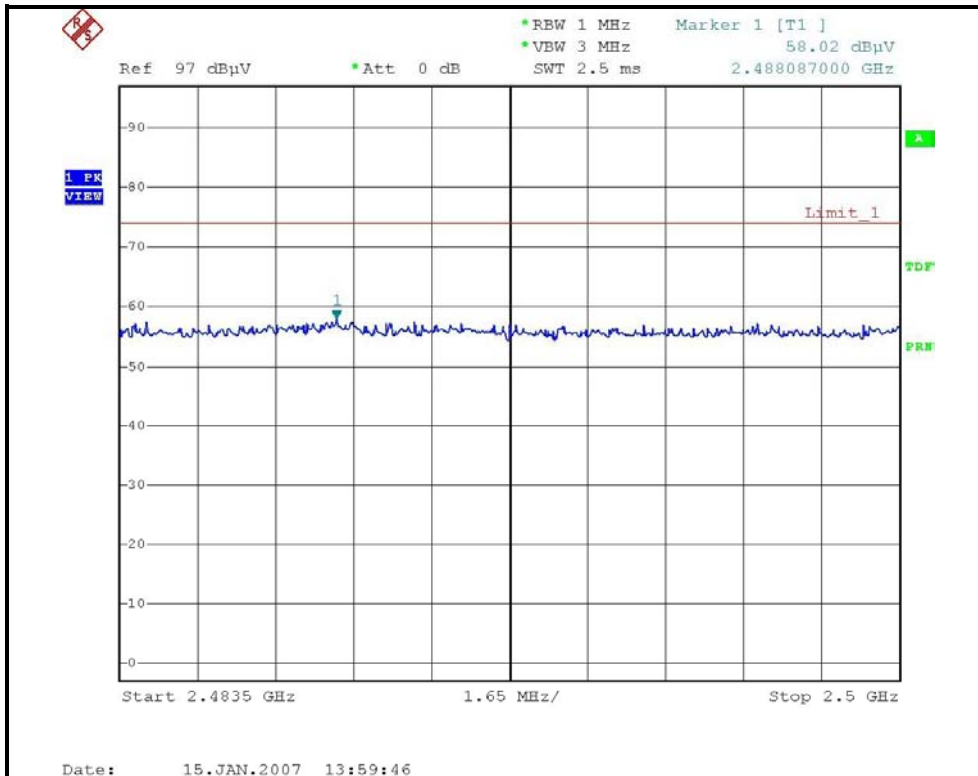

RESTRICTED BANDEDGE (802.11b MODE,CH11, VERTICAL)

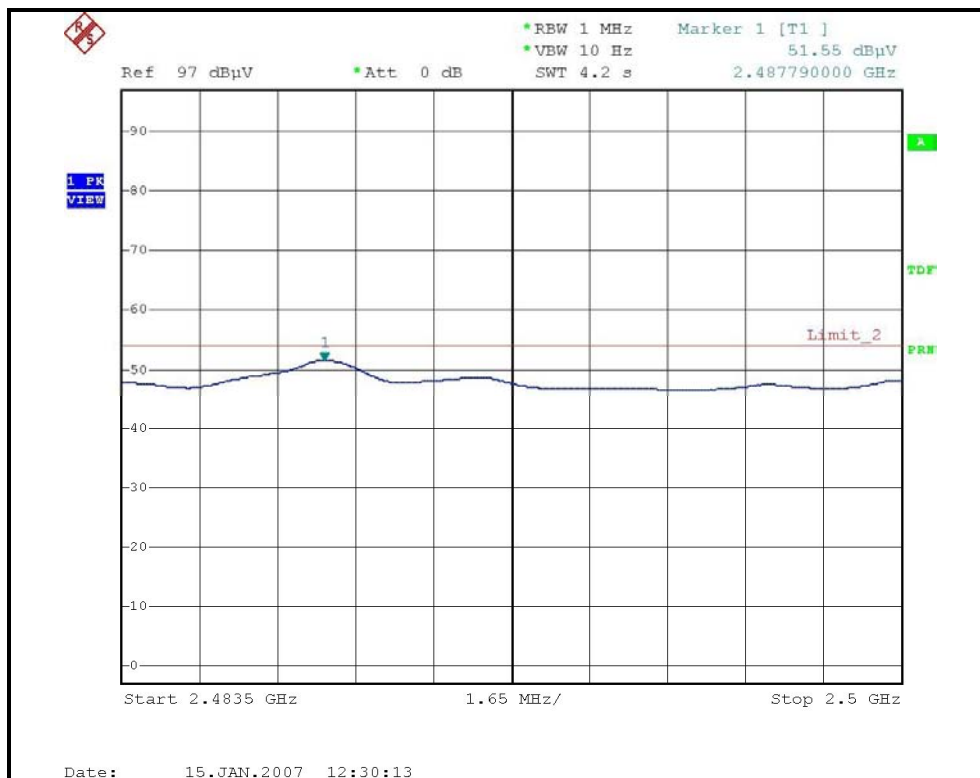
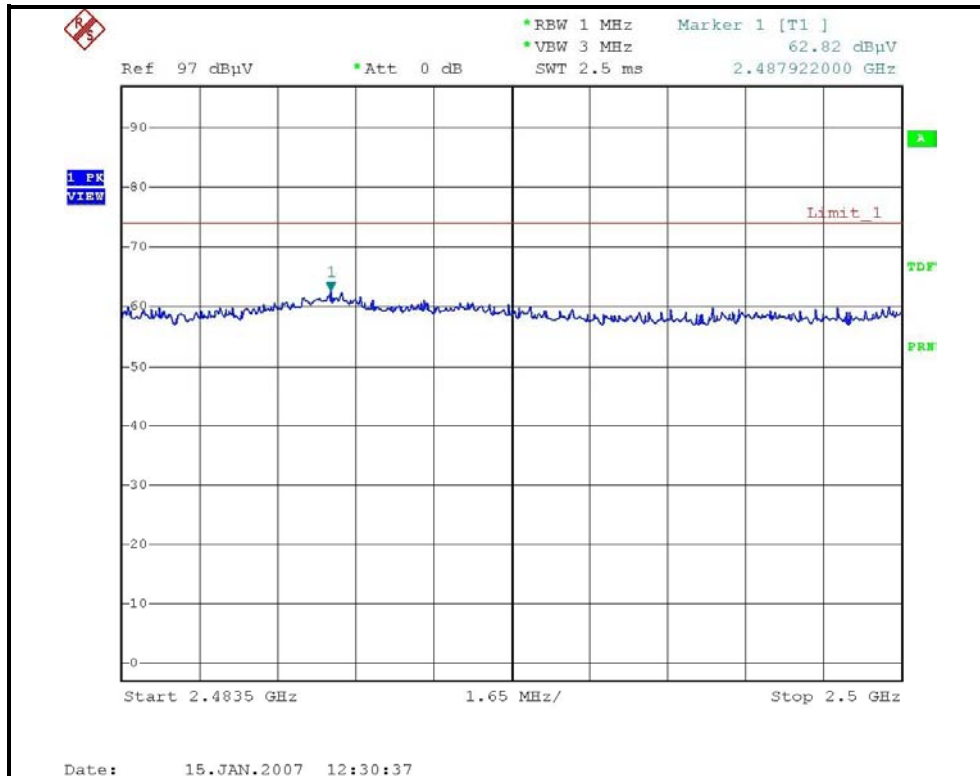



802.11g OFDM modulation

MODE	Channel 1	FREQUENCY RANGE	1000~25000MHz
INPUT POWER (SYSTEM)	120Vac, 60 Hz	DETECTOR FUNCTION & BANDWIDTH	Peak (PK) Average (AV) 1 MHz
ENVIRONMENTAL CONDITIONS	18 deg. C, 56%RH, 980hPa	TESTED BY	Rex Huang

ANTENNA POLARITY & TEST DISTANCE: HORIZONTAL AT 3 M

No.	Freq. (MHz)	Emission Level (dBuV/m)	Limit (dBuV/m)	Margin (dB)	Antenna Height (m)	Table Angle (Degree)	Raw Value (dBuV)	Correction Factor (dB/m)
1	2390.00	64.90 PK	74.00	-9.10	1.27 H	98	32.97	31.93
1	2390.00	48.00 AV	54.00	-6.00	1.27 H	98	16.07	31.93
2	*2412.00	100.90 PK			1.21 H	99	68.88	32.02
2	*2412.00	89.90 AV			1.21 H	99	57.88	32.02
3	4824.00	43.30 PK	74.00	-30.70	1.40 H	214	7.33	35.97
3	4824.00	33.30 AV	54.00	-20.70	1.40 H	214	-2.67	35.97
4	7236.00	56.38 PK	74.00	-17.62	1.27 H	124	14.14	42.24
4	7236.00	44.18 AV	54.00	-9.82	1.27 H	124	1.94	42.24

ANTENNA POLARITY & TEST DISTANCE: VERTICAL AT 3 M

No.	Freq. (MHz)	Emission Level (dBuV/m)	Limit (dBuV/m)	Margin (dB)	Antenna Height (m)	Table Angle (Degree)	Raw Value (dBuV)	Correction Factor (dB/m)
1	2390.00	72.30 PK	74.00	-1.70	1.14 V	282	40.37	31.93
1	2390.00	52.90 AV	54.00	-1.10	1.14 V	282	20.97	31.93
2	*2412.00	108.50 PK			1.14 V	282	76.48	32.02
2	*2412.00	98.10 AV			1.14 V	282	66.08	32.02
3	4824.00	44.90 PK	74.00	-29.10	1.04 V	333	8.93	35.97
3	4824.00	31.30 AV	54.00	-22.70	1.04 V	333	-4.67	35.97
4	7236.00	56.58 PK	74.00	-17.42	1.08 V	84	14.34	42.24
4	7236.00	42.78 AV	54.00	-11.22	1.08 V	84	0.54	42.24

REMARKS:

1. Emission level(dBuV/m)=Raw Value(dBuV) + Correction Factor(dB/m)
2. Correction Factor(dB/m) = Antenna Factor (dB/m) + Cable Factor (dB)
3. The other emission levels were very low against the limit.
4. Margin value = Emission level – Limit value.
5. The limit value is defined as per 15.247
6. “ * ” : Fundamental frequency



MODE	Channel 2	FREQUENCY RANGE	1000~25000MHz
INPUT POWER (SYSTEM)	120Vac, 60 Hz	DETECTOR FUNCTION & BANDWIDTH	Peak (PK) Average (AV) 1 MHz
ENVIRONMENTAL CONDITIONS	18 deg. C, 56%RH, 980hPa	TESTED BY	Rex Huang

ANTENNA POLARITY & TEST DISTANCE: HORIZONTAL AT 3 M

No.	Freq. (MHz)	Emission Level (dBuV/m)	Limit (dBuV/m)	Margin (dB)	Antenna Height (m)	Table Angle (Degree)	Raw Value (dBuV)	Correction Factor (dB/m)
1	2390.00	64.40 PK	74.00	-9.60	1.26 H	97	32.47	31.93
1	2390.00	47.90 AV	54.00	-6.10	1.26 H	97	15.97	31.93
2	*2417.00	102.70 PK			1.24 H	99	70.67	32.03
2	*2417.00	91.50 AV			1.24 H	99	59.47	32.03
3	4834.00	43.22 PK	74.00	-30.78	1.22 H	98	7.23	35.99
3	4834.00	33.32 AV	54.00	-20.68	1.22 H	98	-2.67	35.99
4	7251.00	56.54 PK	74.00	-17.46	1.22 H	123	14.24	42.29
4	7251.00	44.14 AV	54.00	-9.86	1.22 H	123	1.84	42.29

ANTENNA POLARITY & TEST DISTANCE: VERTICAL AT 3 M

No.	Freq. (MHz)	Emission Level (dBuV/m)	Limit (dBuV/m)	Margin (dB)	Antenna Height (m)	Table Angle (Degree)	Raw Value (dBuV)	Correction Factor (dB/m)
1	2390.00	69.80 PK	74.00	-4.20	1.14 V	283	37.87	31.93
1	2390.00	52.50 AV	54.00	-1.50	1.14 V	283	20.57	31.93
2	*2417.00	110.10 PK			1.14 V	283	78.07	32.03
2	*2417.00	99.60 AV			1.14 V	283	67.57	32.03
3	4834.00	45.10 PK	74.00	-28.90	1.03 V	326	9.11	35.99
3	4834.00	31.20 AV	54.00	-22.80	1.03 V	326	-4.79	35.99
4	7251.00	56.94 PK	74.00	-17.06	1.10 V	87	14.64	42.29
4	7251.00	43.14 AV	54.00	-10.86	1.10 V	87	0.84	42.29

- REMARKS:**
1. Emission level(dBuV/m)=Raw Value(dBuV) + Correction Factor(dB/m)
 2. Correction Factor(dB/m) = Antenna Factor (dB/m) + Cable Factor (dB)
 3. The other emission levels were very low against the limit.
 4. Margin value = Emission level – Limit value.
 5. The limit value is defined as per 15.247
 6. “ * “ : Fundamental frequency



MODE	Channel 6	FREQUENCY RANGE	1000~25000MHz
INPUT POWER (SYSTEM)	120Vac, 60 Hz	DETECTOR FUNCTION & BANDWIDTH	Peak (PK) Average (AV) 1 MHz
ENVIRONMENTAL CONDITIONS	18 deg. C, 56%RH, 980hPa	TESTED BY	Rex Huang

ANTENNA POLARITY & TEST DISTANCE: HORIZONTAL AT 3 M								
No.	Freq. (MHz)	Emission Level (dBuV/m)	Limit (dBuV/m)	Margin (dB)	Antenna Height (m)	Table Angle (Degree)	Raw Value (dBuV)	Correction Factor (dB/m)
1	*2437.00	104.30 PK			1.41 H	72	72.19	32.11
1	*2437.00	93.60 AV			1.41 H	72	61.49	32.11
2	4874.00	45.41 PK	74.00	-28.59	1.35 H	331	9.33	36.08
2	4874.00	31.21 AV	54.00	-22.79	1.35 H	331	-4.87	36.08
3	7311.00	56.57 PK	74.00	-17.43	1.24 H	113	14.05	42.52
3	7311.00	44.77 AV	54.00	-9.23	1.24 H	113	2.25	42.52

ANTENNA POLARITY & TEST DISTANCE: VERTICAL AT 3 M								
No.	Freq. (MHz)	Emission Level (dBuV/m)	Limit (dBuV/m)	Margin (dB)	Antenna Height (m)	Table Angle (Degree)	Raw Value (dBuV)	Correction Factor (dB/m)
1	*2437.00	111.10 PK			1.12 V	282	78.99	32.11
1	*2437.00	101.20 AV			1.12 V	282	69.09	32.11
2	4874.00	47.21 PK	74.00	-26.79	1.04 V	321	11.13	36.08
2	4874.00	32.91 AV	54.00	-21.09	1.04 V	321	-3.17	36.08
3	7311.00	57.37 PK	74.00	-16.63	1.18 V	65	14.85	42.52
3	7311.00	43.57 AV	54.00	-10.43	1.18 V	65	1.05	42.52

- REMARKS:**
1. Emission level(dBuV/m)=Raw Value(dBuV) + Correction Factor(dB/m)
 2. Correction Factor(dB/m) = Antenna Factor (dB/m) + Cable Factor (dB)
 3. The other emission levels were very low against the limit.
 4. Margin value = Emission level – Limit value.
 5. The limit value is defined as per 15.247
 6. “ * “ : Fundamental frequency



MODE	Channel 10	FREQUENCY RANGE	1000~25000MHz
INPUT POWER (SYSTEM)	120Vac, 60 Hz	DETECTOR FUNCTION & BANDWIDTH	Peak (PK) Average (AV) 1 MHz
ENVIRONMENTAL CONDITIONS	18 deg. C, 56%RH, 980hPa	TESTED BY	Rex Huang

ANTENNA POLARITY & TEST DISTANCE: HORIZONTAL AT 3 M

No.	Freq. (MHz)	Emission Level (dBuV/m)	Limit (dBuV/m)	Margin (dB)	Antenna Height (m)	Table Angle (Degree)	Raw Value (dBuV)	Correction Factor (dB/m)
1	*2457.00	101.60 PK			1.16 H	100	69.41	32.19
1	*2457.00	90.63 AV			1.16 H	100	58.44	32.19
2	2483.50	64.80 PK	74.00	-9.20	1.17 H	100	32.51	32.29
2	2483.50	48.00 AV	54.00	-6.00	1.17 H	100	15.71	32.29
3	4914.00	45.60 PK	74.00	-28.40	1.33 H	333	9.43	36.17
3	4914.00	31.40 AV	54.00	-22.60	1.33 H	333	-4.77	36.17
4	7371.00	56.69 PK	74.00	-17.31	1.28 H	125	13.95	42.74
4	7371.00	44.59 AV	54.00	-9.41	1.28 H	125	1.85	42.74

ANTENNA POLARITY & TEST DISTANCE: VERTICAL AT 3 M

No.	Freq. (MHz)	Emission Level (dBuV/m)	Limit (dBuV/m)	Margin (dB)	Antenna Height (m)	Table Angle (Degree)	Raw Value (dBuV)	Correction Factor (dB/m)
1	*2457.00	111.00 PK			1.10 V	282	78.81	32.19
1	*2457.00	100.30 AV			1.10 V	282	68.11	32.19
2	2483.50	71.60 PK	74.00	-2.40	1.10 V	282	39.31	32.29
2	2483.50	52.80 AV	54.00	-1.20	1.10 V	282	20.51	32.29
3	4914.00	47.60 PK	74.00	-26.40	1.00 V	326	11.43	36.17
3	4914.00	33.40 AV	54.00	-20.60	1.00 V	326	-2.77	36.17
4	7371.00	57.69 PK	74.00	-16.31	1.17 V	69	14.95	42.74
4	7371.00	43.89 AV	54.00	-10.11	1.17 V	69	1.15	42.74

- REMARKS:**
1. Emission level(dBuV/m)=Raw Value(dBuV) + Correction Factor(dB/m)
 2. Correction Factor(dB/m) = Antenna Factor (dB/m) + Cable Factor (dB)
 3. The other emission levels were very low against the limit.
 4. Margin value = Emission level – Limit value.
 5. The limit value is defined as per 15.247
 6. “ * “ : Fundamental frequency



MODE	Channel 11	FREQUENCY RANGE	1000~25000MHz
INPUT POWER (SYSTEM)	120Vac, 60 Hz	DETECTOR FUNCTION & BANDWIDTH	Peak (PK) Average (AV) 1 MHz
ENVIRONMENTAL CONDITIONS	18 deg. C, 56%RH, 980hPa	TESTED BY	Rex Huang

ANTENNA POLARITY & TEST DISTANCE: HORIZONTAL AT 3 M

No.	Freq. (MHz)	Emission Level (dBuV/m)	Limit (dBuV/m)	Margin (dB)	Antenna Height (m)	Table Angle (Degree)	Raw Value (dBuV)	Correction Factor (dB/m)
1	*2462.00	100.00 PK			1.16 H	100	67.79	32.21
1	*2462.00	88.20 AV			1.16 H	100	55.99	32.21
2	2483.50	63.50 PK	74.00	-10.50	1.16 H	100	31.21	32.29
2	2483.50	47.20 AV	54.00	-6.80	1.16 H	100	14.91	32.29
3	4924.00	43.92 PK	74.00	-30.08	1.03 H	260	7.73	36.19
3	4924.00	32.12 AV	54.00	-21.88	1.03 H	260	-4.07	36.19
4	7386.00	57.35 PK	74.00	-16.65	1.18 H	216	14.55	42.80
4	7386.00	45.05 AV	54.00	-8.95	1.18 H	216	2.25	42.80

ANTENNA POLARITY & TEST DISTANCE: VERTICAL AT 3 M

No.	Freq. (MHz)	Emission Level (dBuV/m)	Limit (dBuV/m)	Margin (dB)	Antenna Height (m)	Table Angle (Degree)	Raw Value (dBuV)	Correction Factor (dB/m)
1	*2462.00	109.40 PK			1.11 V	282	77.19	32.21
1	*2462.00	98.70 AV			1.11 V	282	66.49	32.21
2	2483.50	70.30 PK	74.00	-3.70	1.11 V	282	38.01	32.29
2	2483.50	52.00 AV	54.00	-2.00	1.11 V	282	19.71	32.29
3	4924.00	45.82 PK	74.00	-28.18	1.00 V	308	9.63	36.19
3	4924.00	31.72 AV	54.00	-22.28	1.00 V	308	-4.47	36.19
4	7386.00	57.15 PK	74.00	-16.85	1.14 V	78	14.35	42.80
4	7386.00	43.45 AV	54.00	-10.55	1.14 V	78	0.65	42.80

- REMARKS:**
1. Emission level(dBuV/m)=Raw Value(dBuV) + Correction Factor(dB/m)
 2. Correction Factor(dB/m) = Antenna Factor (dB/m) + Cable Factor (dB)
 3. The other emission levels were very low against the limit.
 4. Margin value = Emission level – Limit value.
 5. The limit value is defined as per 15.247
 6. “ * “ : Fundamental frequency

RESTRICTED BANDEDGE (802.11g MODE, CH1, HORIZONTAL)

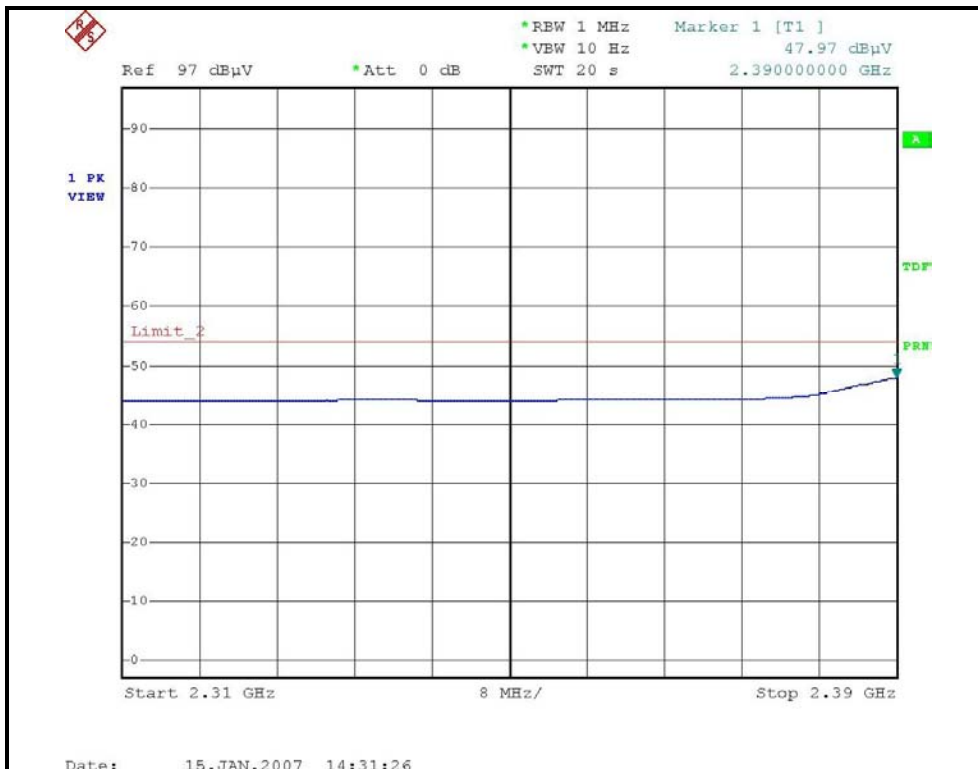
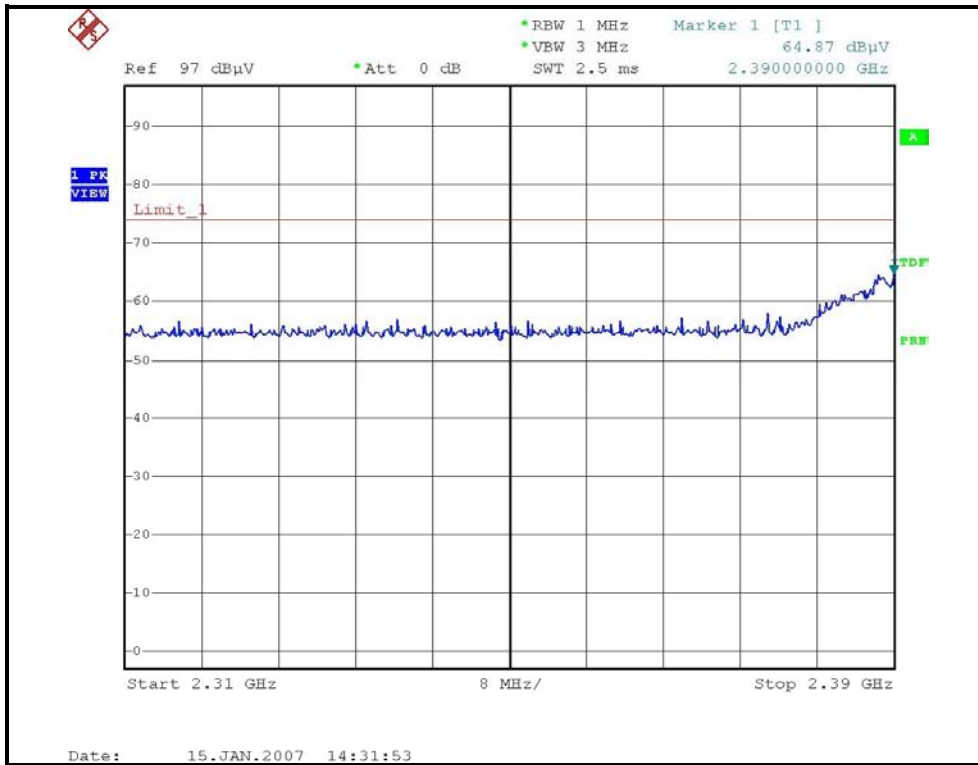

RESTRICTED BANDEDGE (802.11g MODE, CH1, VERTICAL)

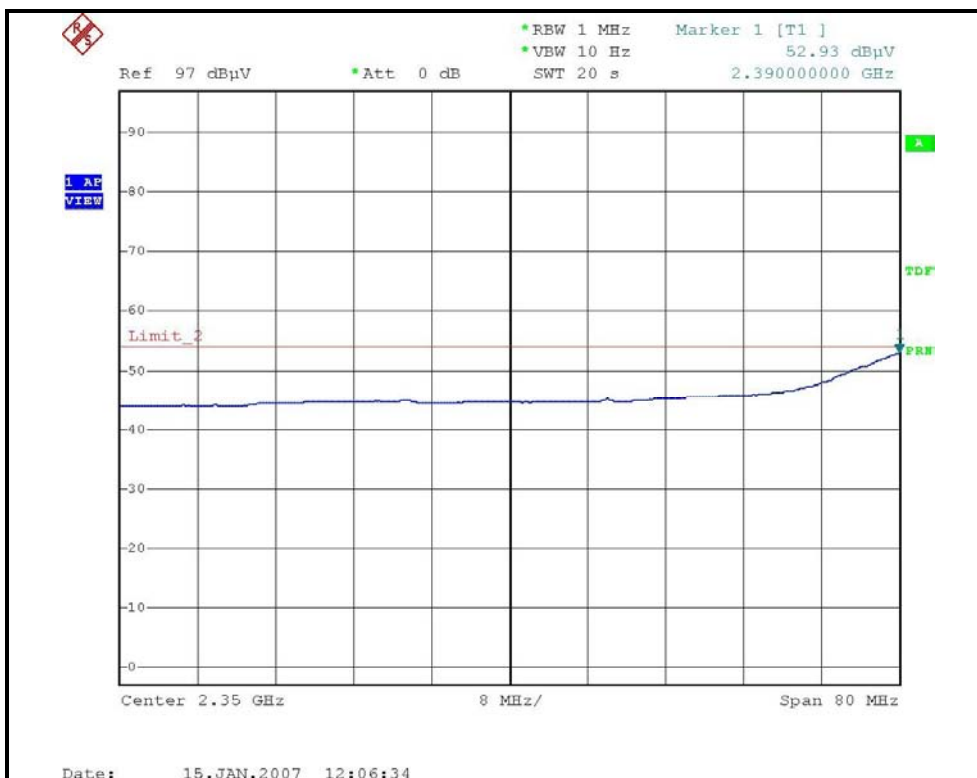
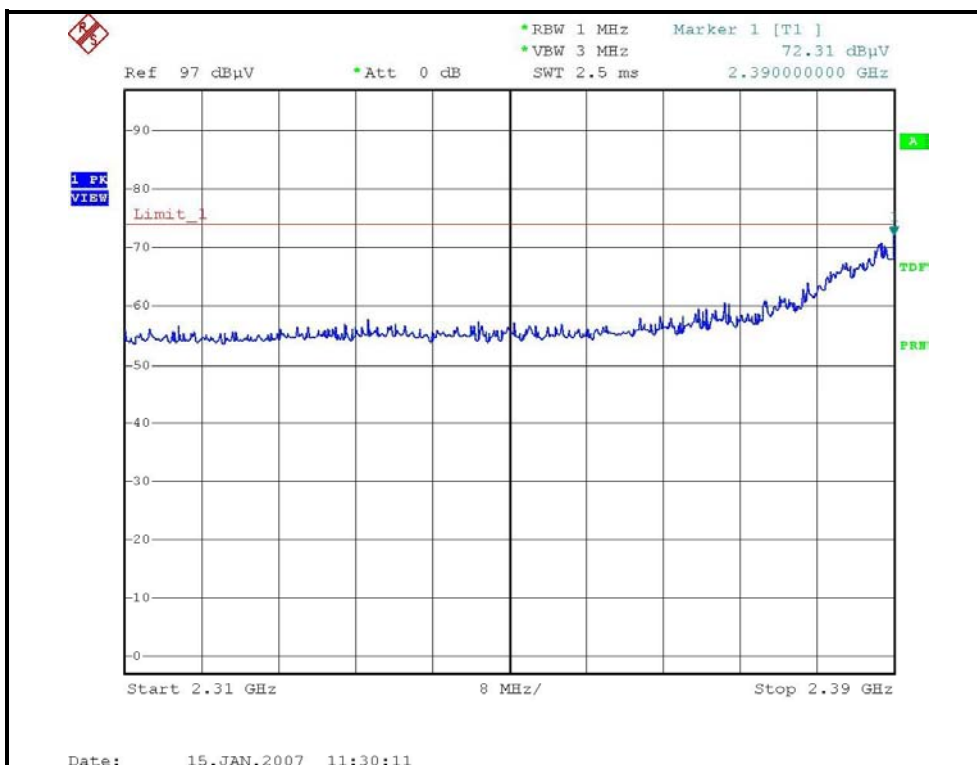

RESTRICTED BANDEDGE (802.11g MODE,CH2, HORIZONTAL)

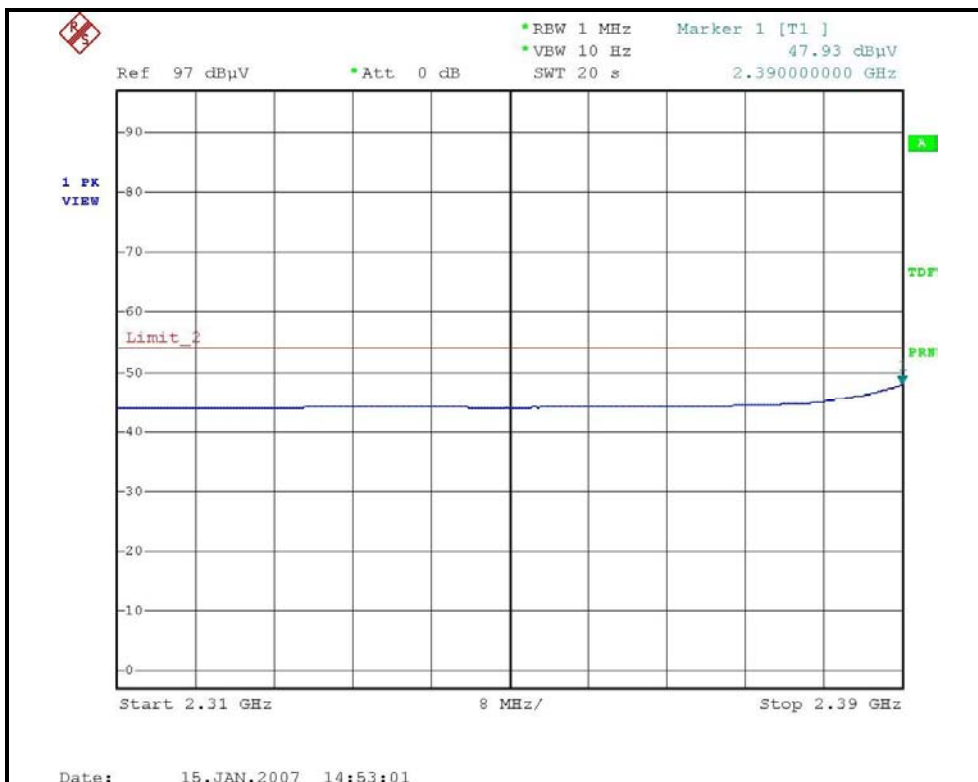
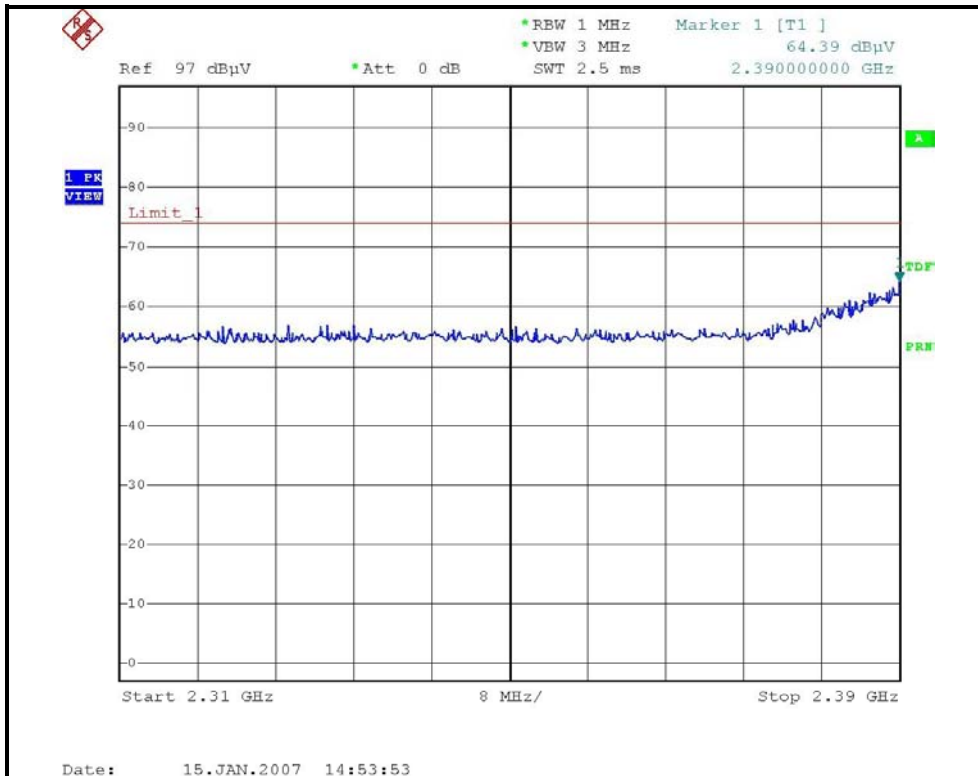

RESTRICTED BANDEDGE (802.11g MODE,CH2, VERTICAL)

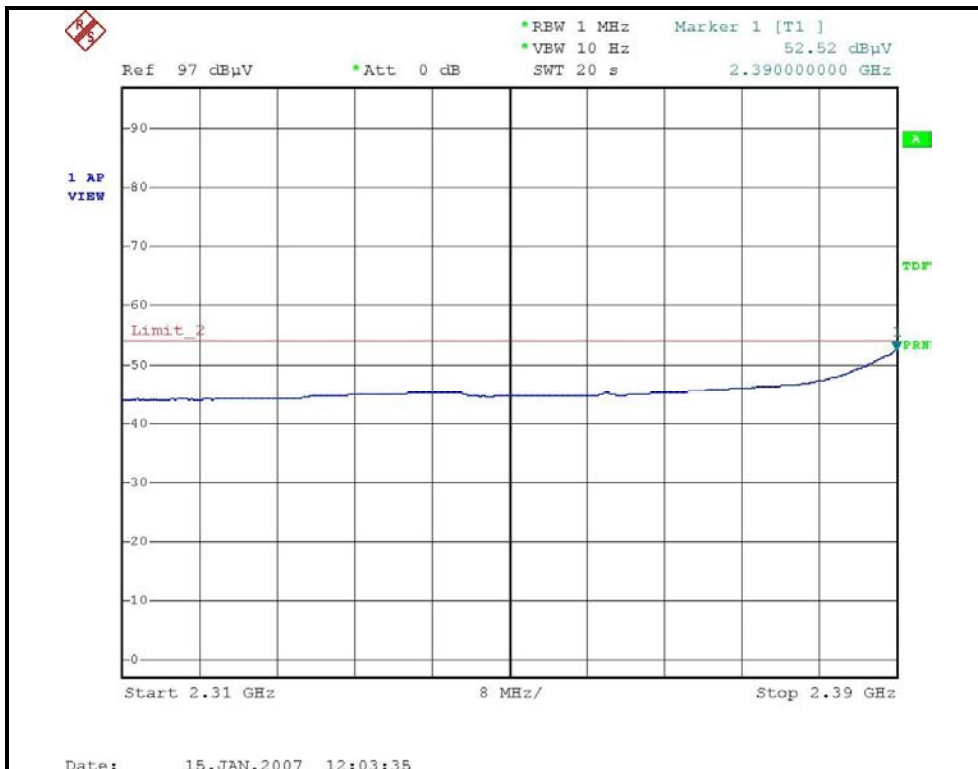
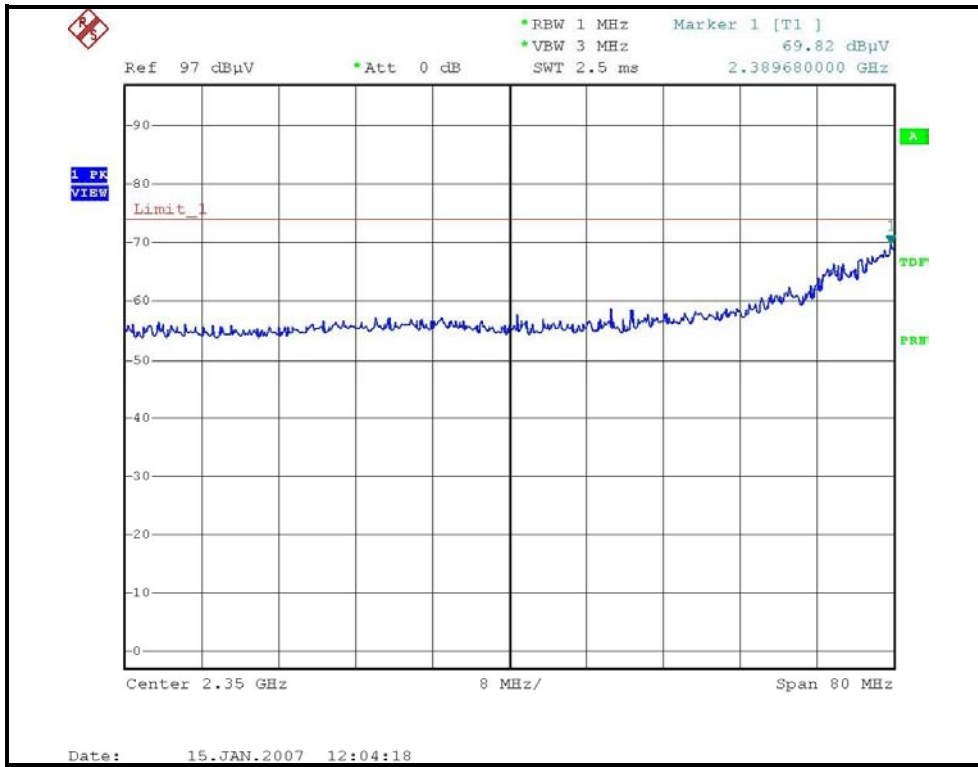

RESTRICTED BANDEDGE (802.11g MODE, CH10, HORIZONTAL)

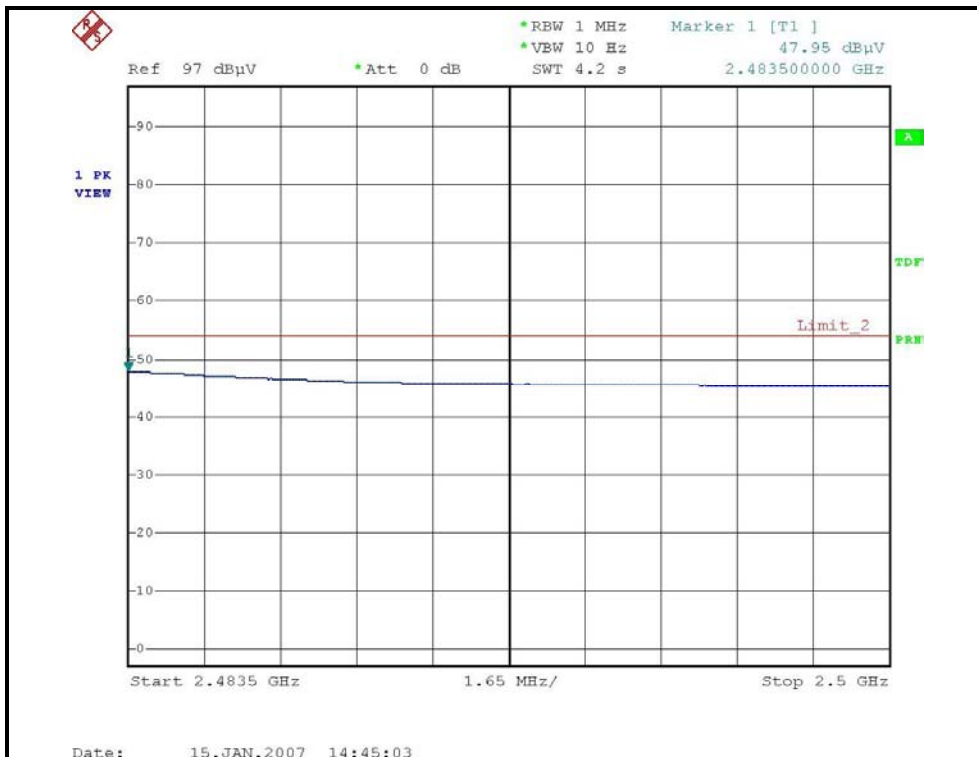
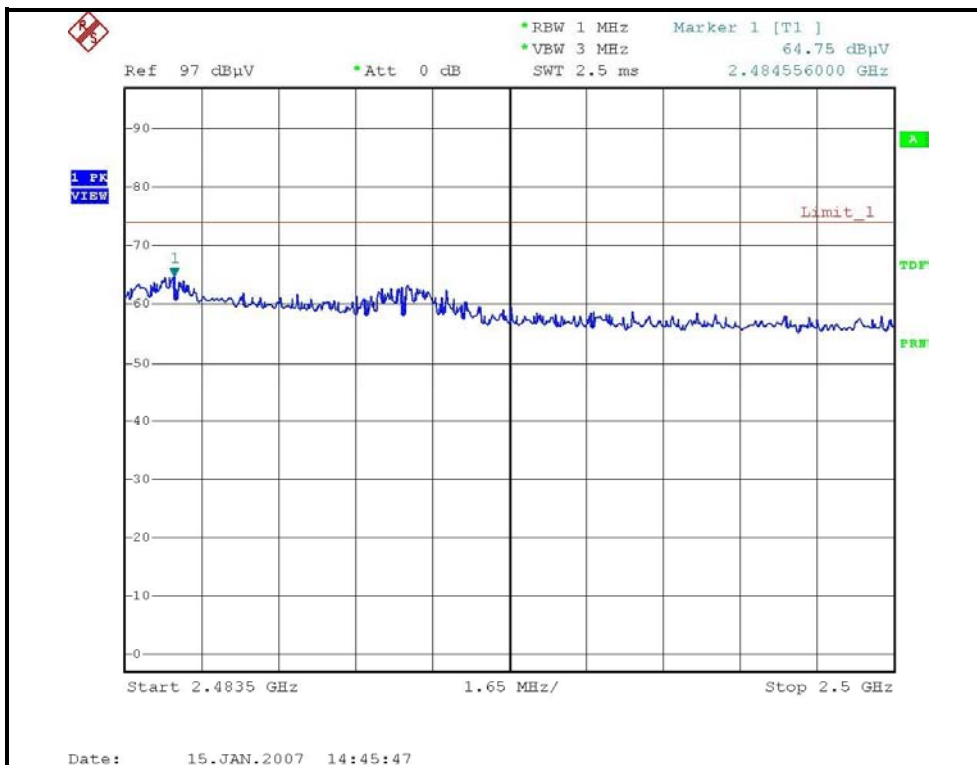

RESTRICTED BANDEDGE (802.11g MODE, CH10, VERTICAL)

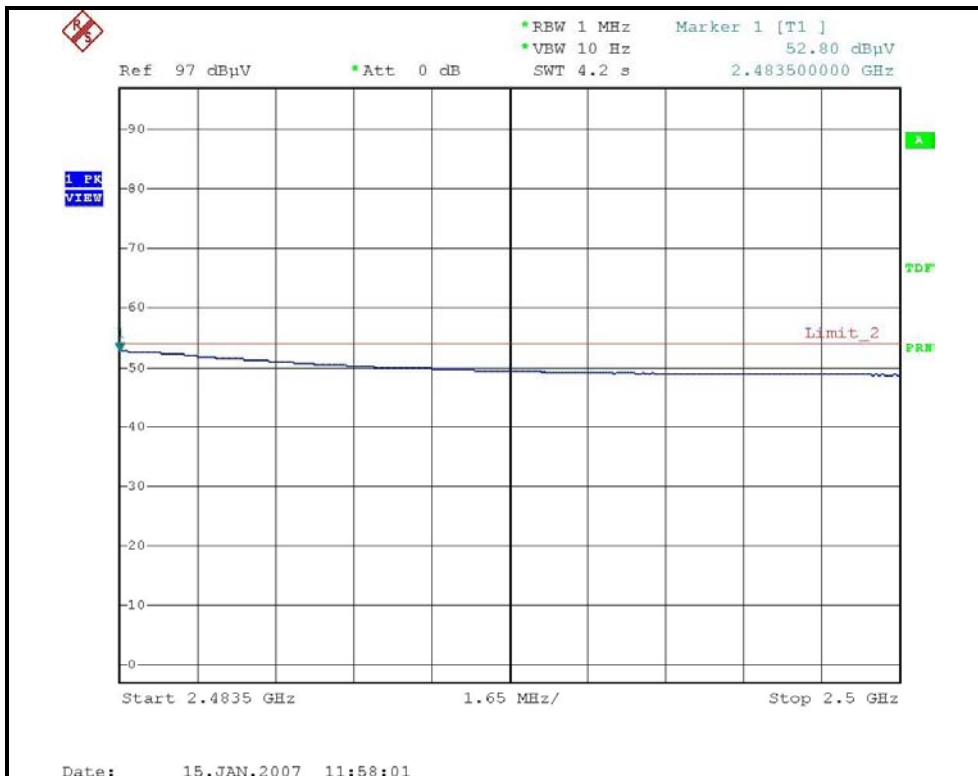
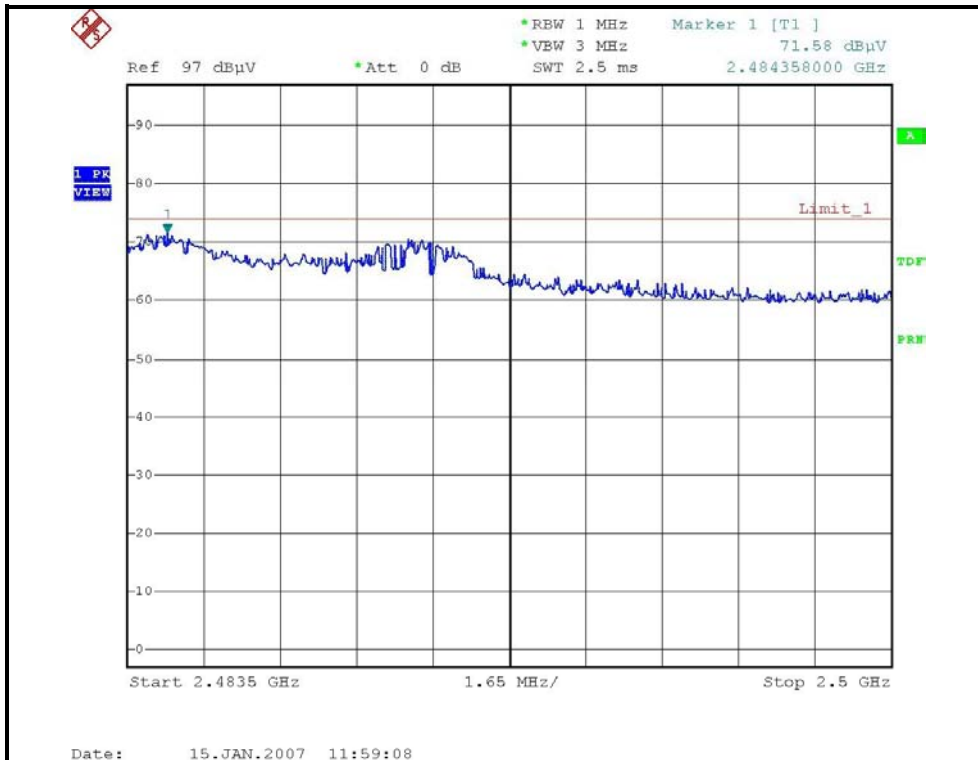

RESTRICTED BANDEDGE (802.11g MODE, CH11, HORIZONTAL)

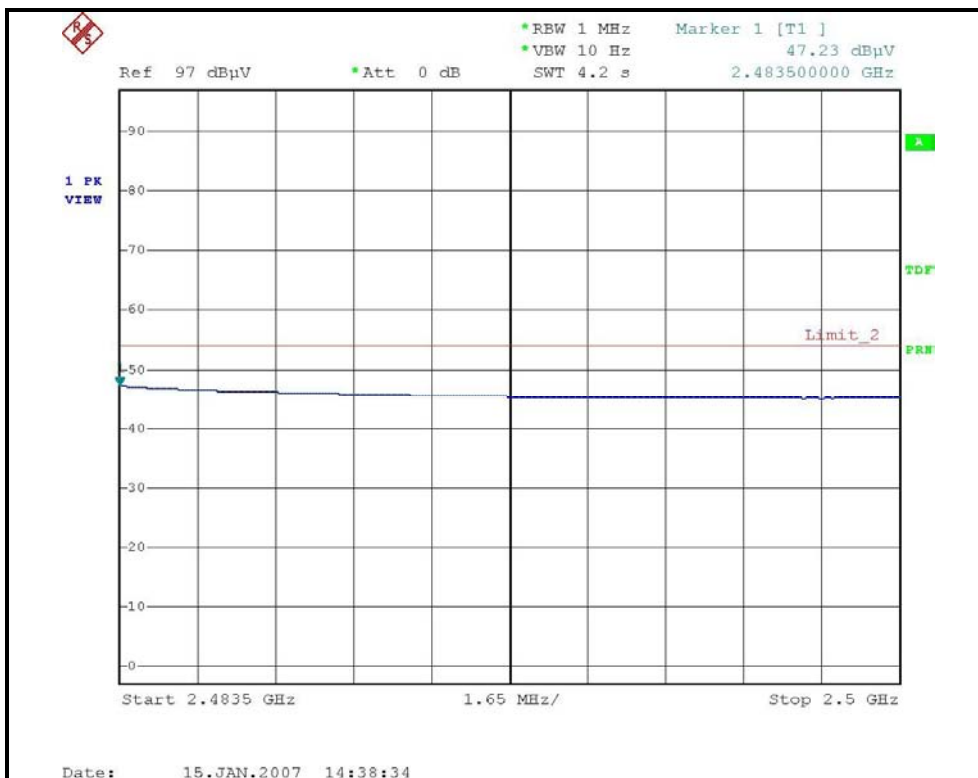
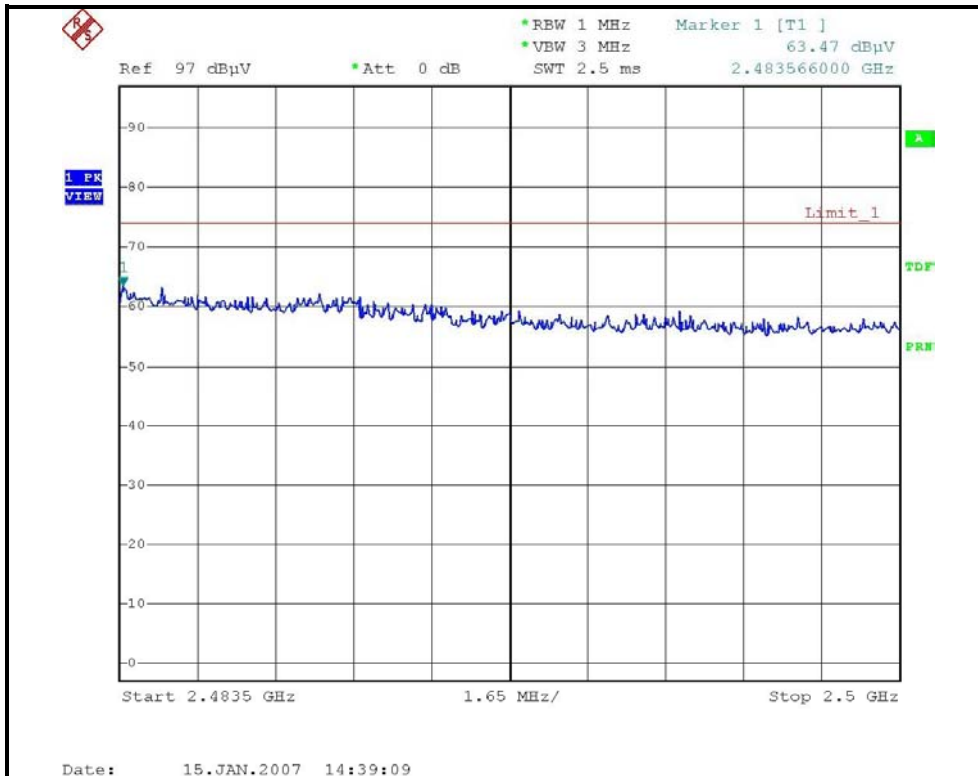

RESTRICTED BANDEDGE (802.11g MODE,CH11, VERTICAL)

