



FCC TEST REPORT

REPORT NO.: RF960622H01A

MODEL NO.: LA-5127A2

RECEIVED: July 02, 2007

TESTED: July 04 to 10, 2007

ISSUED: July 18, 2007

APPLICANT: Symbol Technologies Inc.

ADDRESS: One Symbol Plaza, Holtsville, NY 11742-1300 U.S.A.

ISSUED BY: Advance Data Technology Corporation

TEST LOCATION: No. 81-1, Lu Liao Keng, 9 Ling, Wu Lung Tsuen, Chiung Lin Hsiang, Hsin Chu Hsien, Taiwan, R.O.C.

This test report consists of 95 pages in total. It may be duplicated completely for legal use with the approval of the applicant. It should not be reproduced except in full, without the written approval of our laboratory. The client should not use it to claim product endorsement by TAF, A2LA or any government agencies. The test results in the report only apply to the tested sample.



No. 2177-01

Table of Contents

1.	CERTIFICATION	4
2.	SUMMARY OF TEST RESULTS	5
2.1	MEASUREMENT UNCERTAINTY	6
3.	GENERAL INFORMATION	7
3.1	GENERAL DESCRIPTION OF EUT	7
3.2	DESCRIPTION OF TEST MODES	8
3.2.1	TEST MODE APPLICABILITY AND TESTED CHANNEL DETAIL:	9
3.3	GENERAL DESCRIPTION OF APPLIED STANDARDS	11
3.4	DESCRIPTION OF SUPPORT UNITS.....	12
3.5	CONFIGURATION OF SYSTEM UNDER TEST	12
4.	TEST TYPES AND RESULTS	13
4.1	CONDUCTED EMISSION MEASUREMENT	13
4.1.1	LIMITS OF CONDUCTED EMISSION MEASUREMENT	13
4.1.2	TEST INSTRUMENTS.....	13
4.1.3	TEST PROCEDURES	14
4.1.4	DEVIATION FROM TEST STANDARD	14
4.1.5	TEST SETUP	15
4.1.6	EUT OPERATING CONDITIONS	15
4.1.7	TEST RESULTS	16
4.2	RADIATED EMISSION MEASUREMENT	18
4.2.1	LIMITS OF RADIATED EMISSION MEASUREMENT	18
4.2.2	TEST INSTRUMENTS.....	19
4.2.3	TEST PROCEDURES	20
4.2.4	DEVIATION FROM TEST STANDARD	20
4.2.5	TEST SETUP	21
4.2.6	EUT OPERATING CONDITIONS	21
4.2.7	TEST RESULTS	22
4.3	6DB BANDWIDTH MEASUREMENT	67
4.3.1	LIMITS OF 6DB BANDWIDTH MEASUREMENT	67
4.3.2	TEST INSTRUMENTS.....	67
4.3.3	TEST PROCEDURE.....	68
4.3.4	DEVIATION FROM TEST STANDARD	68
4.3.5	TEST SETUP	68
4.3.6	EUT OPERATING CONDITIONS	68
4.3.7	TEST RESULTS	69
4.4	MAXIMUM PEAK OUTPUT POWER.....	75
4.4.1	LIMITS OF MAXIMUM PEAK OUTPUT POWER MEASUREMENT	75
4.4.2	INSTRUMENTS.....	75



4.4.3	TEST PROCEDURES	76
4.4.4	DEVIATION FROM TEST STANDARD	76
4.4.5	TEST SETUP	76
4.4.6	EUT OPERATING CONDITIONS	76
4.4.7	TEST RESULTS	77
4.5	POWER SPECTRAL DENSITY MEASUREMENT	79
4.5.1	LIMITS OF POWER SPECTRAL DENSITY MEASUREMENT	79
4.5.2	TEST INSTRUMENTS.....	79
4.5.3	TEST PROCEDURE.....	80
4.5.4	DEVIATION FROM TEST STANDARD.....	80
4.5.5	TEST SETUP	80
4.5.6	EUT OPERATING CONDITION.....	80
4.5.7	TEST RESULTS	81
4.6	BAND EDGES MEASUREMENT.....	87
4.6.1	LIMITS OF BAND EDGES MEASUREMENT	87
4.6.2	TEST INSTRUMENTS.....	87
4.6.3	TEST PROCEDURE.....	87
4.6.4	EUT OPERATING CONDITION.....	87
4.6.5	TEST RESULTS	88
4.7	ANTENNA REQUIREMENT	93
4.7.1	STANDARD APPLICABLE.....	93
4.7.2	ANTENNA CONSNECTED CONSTRUCTION	93
5.	INFORMATION ON THE TESTING LABORATORIES	94
6.	APPENDIX-A MODIFICATIONS RECORDERS FOR ENGINEERING CHANGES TO THE EUT BY THE LAB.....	95



1. CERTIFICATION

PRODUCT: 802.11b/g Compact Flash Radio Card
BRAND NAME: Symbol Technologies Inc.
MODEL NO.: LA-5127A2
TEST SAMPLE: ENGINEERING SAMPLE
TESTED: July 04 to 10, 2007
APPLICANT: Symbol Technologies Inc.
STANDARDS: FCC Part 15, Subpart C (Section 15.247),
ANSI C63.4-2003

The above equipment (Model: LA-5127A2) has been tested by **Advance Data Technology Corporation**, and found compliance with the requirement of the above standards. The test record, data evaluation & Equipment Under Test (EUT) configurations represented herein are true and accurate accounts of the measurements of the sample's EMC characteristics under the conditions specified in this report.

PREPARED BY : Claire Kuan , **DATE:** July 18, 2007
(Claire Kuan, Specialist)

TECHNICAL ACCEPTANCE : Hank Chung , **DATE:** July 18, 2007
Responsible for RF (Hank Chung, Deputy Manager)

APPROVED BY : May Chen , **DATE:** July 18, 2007
(May Chen, Deputy Manager)

2. SUMMARY OF TEST RESULTS

The EUT has been tested according to the following specifications:

APPLIED STANDARD: FCC Part 15, Subpart C (Section 15.247)			
Standard Section	Test Type and Limit	Result	Remark
15.207	AC Power Conducted Emission	PASS	Meet the requirement of limit. Minimum passing margin is -21.42dB at 0.170MHz
15.247(a)(2)	Spectrum Bandwidth of a Direct Sequence Spread Spectrum System Limit: min. 500kHz	PASS	Meet the requirement of limit.
15.247(b)	Maximum Peak Output Power Limit: max. 30dBm	PASS	Meet the requirement of limit.
15.247(d)	Radiated Emissions Limit: Table 15.209	PASS	Meet the requirement of limit. Minimum passing margin is -1.00dB at 2390.00MHz
15.247(e)	Power Spectral Density Limit: max. 8dBm	PASS	Meet the requirement of limit.
15.247(d)	Band Edge Measurement Limit: 20dB less than the peak value of fundamental frequency	PASS	Meet the requirement of limit.

2.1 MEASUREMENT UNCERTAINTY

Where relevant, the following measurement uncertainty levels have been estimated for tests performed on the EUT as specified in CISPR 16-4:

This uncertainty represents an expanded uncertainty expressed at approximately the 95% confidence level using a coverage factor of $k=2$.

Measurement	Value
Conducted emissions	2.41 dB
Radiated emissions (30MHz-1GHz)	3.89 dB
Radiated emissions (1GHz -18GHz)	2.21 dB
Radiated emissions (18GHz -40GHz)	1.88 dB

3. GENERAL INFORMATION

3.1 GENERAL DESCRIPTION OF EUT

EUT	802.11b/g Compact Flash Radio Card
MODEL NO.	LA-5127A2
FCC ID	H9PLA5127A2
POWER SUPPLY	DC 3.3 V +/-5% from host equipment
MODULATION TYPE	CCK, DQPSK, DBPSK for DSSS 64QAM, 16QAM, QPSK, BPSK for OFDM
MODULATION TECHNOLOGY	DSSS, OFDM
TRANSFER RATE	802.11b: 11/5.5/2/1Mbps 802.11g: 54/48/36/24/18/12/9/6Mbps
FREQUENCY RANGE	802.11b & 802.11g: 2412 ~ 2462MHz
NUMBER OF CHANNEL	11
CHANNEL SPACING	5
OUTPUT POWER	For 802.11b: 87.096mW For 802.11g: 100.000mW
DATA CABLE	NA
ANTENNA TYPE	Please see note 2 (on next page)
ASSOCIATED DEVICES	NA

NOTE:

- The EUT operates in the 2.4GHz frequency spectrum with throughput of up to 54Mbps.
- There is one antenna provided to this EUT, please refer to the following table:

Brand Name	Model No.	Gain (dBi)	Antenna Type	Connector
Tyco	1513671-1	1.58	Printed Antenna	NA

- The above EUT information was declared by the manufacturer and for more detailed features description, please refer to the manufacturer's specifications or User's Manual.

3.2 DESCRIPTION OF TEST MODES

For 802.11b/g: Eleven channels are provided to this EUT.

Channel	Frequency	Channel	Frequency
1	2412 MHz	7	2442 MHz
2	2417 MHz	8	2447 MHz
3	2422 MHz	9	2452 MHz
4	2427 MHz	10	2457 MHz
5	2432 MHz	11	2462 MHz
6	2437 MHz		

3.2.1 TEST MODE APPLICABILITY AND TESTED CHANNEL DETAIL:

EUT configure mode	Applicable to				Description
	PLC	RE<1G	RE [≥] 1G	APCM	
-	√	√	√	√	NA

Where PLC: Power Line Conducted Emission RE<1G RE: Radiated Emission below 1GHz
 RE≥1G: Radiated Emission above 1GHz APCM: Antenna Port Conducted Measurement

Power Line Conducted Emission Test:

- Pre-Scan has been conducted to determine the worst-case mode from all possible combinations between available modulations, data rates and antenna ports (if EUT with antenna diversity architecture).
- Following channel(s) was (were) selected for the final test as listed below.

Mode	Available Channel	Tested Channel	Modulation Technology	Modulation Type	Data Rate (Mbps)
802.11b	1 to 11	1	DSSS	CCK	1

Radiated Emission Test (Below 1 GHz):

- Pre-Scan has been conducted to determine the worst-case mode from all possible combinations between available modulations, data rates and antenna ports (if EUT with antenna diversity architecture).
- Following channel(s) was (were) selected for the final test as listed below.

Mode	Available Channel	Tested Channel	Modulation Technology	Modulation Type	Data Rate (Mbps)
802.11b	1 to 11	1	DSSS	CCK	1

Radiated Emission Test (Above 1 GHz):

- Pre-Scan has been conducted to determine the worst-case mode from all possible combinations between available modulations, data rates and antenna ports (if EUT with antenna diversity architecture).
- Following channel(s) was (were) selected for the final test as listed below.

Mode	Available Channel	Tested Channel	Modulation Technology	Modulation Type	Data Rate (Mbps)
802.11b	1 to 11	1, 2, 3, 6, 9, 10, 11	DSSS	CCK	1
802.11g	1 to 11	1, 2, 3, 4, 6, 8, 9, 10, 11	OFDM	BPSK	6

Channel 2~4 and 8~10 are required by manufacture.



Bandedge Measurement:

- Pre-Scan has been conducted to determine the worst-case mode from all possible combinations between available modulations, data rates and antenna ports (if EUT with antenna diversity architecture).
- Following channel(s) was (were) selected for the final test as listed below.

Mode	Available Channel	Tested Channel	Modulation Technology	Modulation Type	Data Rate (Mbps)
802.11b	1 to 11	1, 11	DSSS	CCK	1
802.11g	1 to 11	1, 11	OFDM	BPSK	6

Antenna Port Conducted Measurement:

- Pre-Scan has been conducted to determine the worst-case mode from all possible combinations between available modulations, data rates and antenna ports (if EUT with antenna diversity architecture).
- Following channel(s) was (were) selected for the final test as listed below.

Mode	Available Channel	Tested Channel	Modulation Technology	Modulation Type	Data Rate (Mbps)
802.11b	1 to 11	1, 2, 3, 6, 9, 10, 11	DSSS	CCK	11
802.11g	1 to 11	1, 2, 3, 4, 6, 8, 9, 10, 11	OFDM	BPSK	6

Channel 2~4 and 8~10 are required by manufacture.



3.3 GENERAL DESCRIPTION OF APPLIED STANDARDS

The EUT is an 802.11b/g Compact Flash Radio Card. According to the specifications of the manufacturer, it must comply with the requirements of the following standards:

FCC Part 15, Subpart C. (15.247)

ANSI C63.4-2003

All test items have been performed and recorded as per the above standards.

NOTE: The EUT is also considered as a kind of computer peripheral, because the connection to computer is necessary for typical use. It has been verified to comply with the requirements of FCC Part 15, Subpart B, Class B (DoC). The test report has been issued separately.

3.4 DESCRIPTION OF SUPPORT UNITS

The EUT has been tested as an independent unit together with other necessary accessories or support units. The following support units or accessories were used to form a representative test configuration during the tests.

No.	Product	Brand	Model No.	Serial No.	FCC ID
1	NOTEBOOK COMPUTER	ASUS	A2400H	49NG038481	FCC DoC
2	PCMCIA Ext Card	USI	NA	NA	NA
3	CE to PCMCIA Card	USI	NA	NA	NA

No.	Signal cable description
1	NA
2	NA
3	NA

Note: 1. All power cords of the above support units are unshielded (1.8m).

3.5 CONFIGURATION OF SYSTEM UNDER TEST

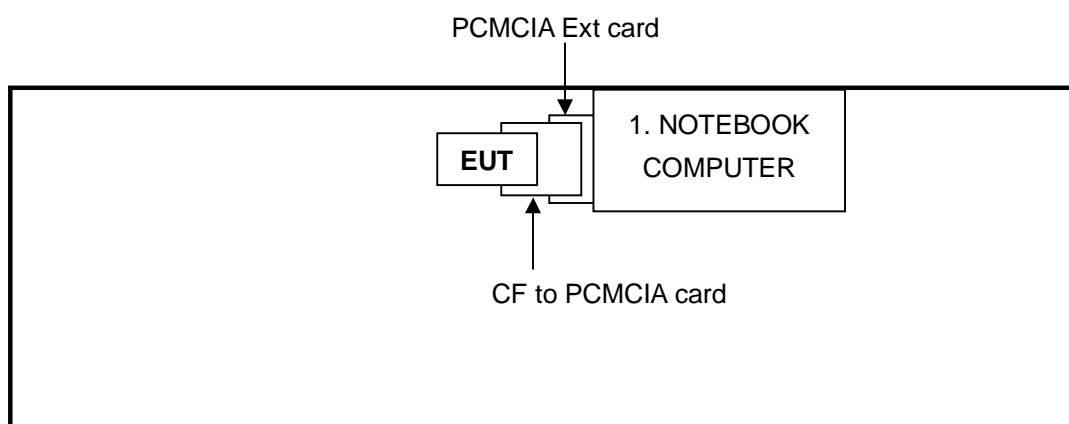

4. TEST TYPES AND RESULTS

4.1 CONDUCTED EMISSION MEASUREMENT

4.1.1 LIMITS OF CONDUCTED EMISSION MEASUREMENT

FREQUENCY OF EMISSION (MHz)	CONDUCTED LIMIT (dB μ V)	
	Quasi-peak	Average
0.15-0.5	66 to 56	56 to 46
0.5-5	56	46
5-30	60	50

- NOTE:**
1. The lower limit shall apply at the transition frequencies.
 2. The limit decreases in line with the logarithm of the frequency in the range of 0.15 to 0.50 MHz.
 3. All emanations from a class A/B digital device or system, including any network of conductors and apparatus connected thereto, shall not exceed the level of field strengths specified above.

4.1.2 TEST INSTRUMENTS

DESCRIPTION & MANUFACTURER	MODEL NO.	SERIAL NO.	CALIBRATED UNTIL
Test Receiver	ESCS 30	847124/029	Mar. 01, 2008
Line-Impedance Stabilization Network(for EUT)	ENV-216	100071	Nov. 26, 2007
Line-Impedance Stabilization Network(for Peripheral)	ESH3-Z5	848773/004	Oct. 26, 2007
RF Cable (JETBAO)	RG233/U	Cable_CB_01	Dec. 09, 2007
Terminator	50	2	Oct. 30, 2007
Software	ADT_Cond_V7.3.2	NA	NA

- NOTE:**
1. The calibration interval of the above test instruments is 12 months and the calibrations are traceable to NML/ROC and NIST/USA.
 2. The test was performed in ADT Shielded Room No. B.
 3. The VCCI Con B Registration No. is C-2193.

4.1.3 TEST PROCEDURES

- a. The EUT was placed 0.4 meters from the conducting wall of the shielded room with EUT being connected to the power mains through a line impedance stabilization network (LISN). Other support units were connected to the power mains through another LISN. The two LISNs provide 50 ohm/ 50uH of coupling impedance for the measuring instrument.
- b. Both lines of the power mains connected to the EUT were checked for maximum conducted interference.
- c. The frequency range from 150kHz to 30MHz was searched. Emission levels under (Limit - 20dB) were not recorded.

4.1.4 DEVIATION FROM TEST STANDARD

No deviation

4.1.5 TEST SETUP

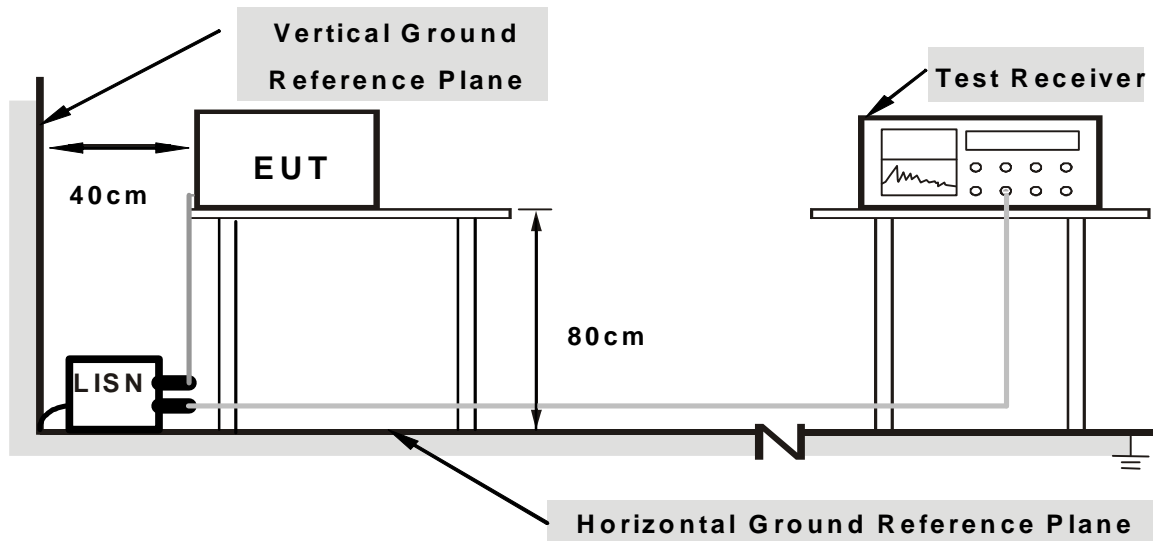

Note: 1. Support units were connected to second LISN.

2. Both of LISNs (AMN) are 80 cm from EUT and at least 80 from other units and other metal planes

For the actual test configuration, please refer to the related item – Photographs of the Test Configuration.

4.1.6 EUT OPERATING CONDITIONS

1. Connect the EUT with the support unit 1 (Notebook computer) and placed it on the testing table.
2. The support unit 1 (Notebook computer) ran a test program “cTxRx 3.0.1.1” to enable EUT under transmission condition continuously.

4.1.7 TEST RESULTS

Conducted Worst-Case Data

MODULATION TYPE	CCK	6dB BANDWIDTH	9 kHz
INPUT POWER (SYSTEM)	120Vac, 60 Hz	TRANSFER RATE	1Mbps
ENVIRONMENTAL CONDITIONS	26deg. C, 58%RH, 960hPa	PHASE	Line (L)
TESTED BY	Wen Yu		

No	Freq. [MHz]	Corr. Factor (dB)	Reading Value		Emission Level		Limit		Margin	
			[dB (uV)]		[dB (uV)]		[dB (uV)]		(dB)	
			Q.P.	AV.	Q.P.	AV.	Q.P.	AV.	Q.P.	AV.
1	0.173	0.40	41.84	-	42.24	-	64.79	54.79	-22.55	-
2	0.295	0.40	34.01	-	34.41	-	60.40	50.40	-25.99	-
3	0.892	0.40	27.39	-	27.79	-	56.00	46.00	-28.21	-
4	1.267	0.43	30.72	-	31.15	-	56.00	46.00	-24.85	-
5	2.064	0.50	28.44	-	28.94	-	56.00	46.00	-27.06	-
6	2.334	0.52	26.94	-	27.46	-	56.00	46.00	-28.54	-

- REMARKS:**
1. Q.P. and AV. are abbreviations of quasi-peak and average individually.
 2. "-": The Quasi-peak reading value also meets average limit and measurement with the average detector is unnecessary.
 3. The emission levels of other frequencies were very low against the limit.
 4. Margin value = Emission level - Limit value
 5. Correction factor = Insertion loss + Cable loss
 6. Emission Level = Correction Factor + Reading Value.

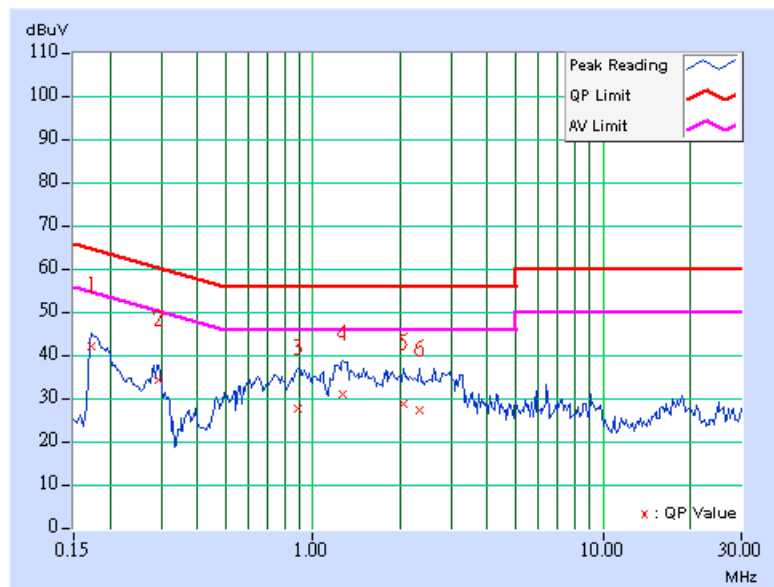

MODULATION TYPE	CCK	6dB BANDWIDTH	9 kHz
INPUT POWER (SYSTEM)	120Vac, 60 Hz	TRANSFER RATE	1Mbps
ENVIRONMENTAL CONDITIONS	26deg. C, 58%RH, 960hPa	PHASE	Neutral (N)
TESTED BY	Wen Yu		

No	Freq. [MHz]	Corr. Factor (dB)	Reading Value [dB (uV)]		Emission Level [dB (uV)]		Limit [dB (uV)]		Margin (dB)	
			Q.P.	AV.	Q.P.	AV.	Q.P.	AV.	Q.P.	AV.
	1	0.170	0.20	43.36	-	43.56	-	64.98	54.98	-21.42
2	0.181	0.20	41.30	-	41.50	-	64.43	54.43	-22.93	-
3	0.318	0.20	35.22	-	35.42	-	59.76	49.76	-24.34	-
4	0.591	0.23	30.16	-	30.39	-	56.00	46.00	-25.61	-
5	0.865	0.28	26.50	-	26.78	-	56.00	46.00	-29.22	-
6	2.974	0.45	24.06	-	24.51	-	56.00	46.00	-31.49	-

- REMARKS:**
1. Q.P. and AV. are abbreviations of quasi-peak and average individually.
 2. "-": The Quasi-peak reading value also meets average limit and measurement with the average detector is unnecessary.
 3. The emission levels of other frequencies were very low against the limit.
 4. Margin value = Emission level - Limit value
 5. Correction factor = Insertion loss + Cable loss
 6. Emission Level = Correction Factor + Reading Value.

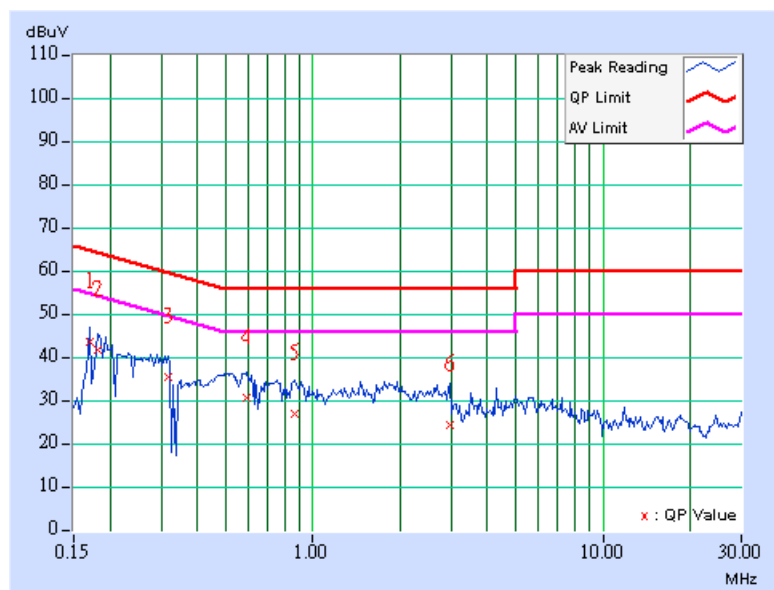

4.2 RADIATED EMISSION MEASUREMENT

4.2.1 LIMITS OF RADIATED EMISSION MEASUREMENT

Emissions radiated outside of the specified bands, shall be according to the general radiated limits in 15.209 as following:

Frequencies (MHz)	Field strength (microvolts/meter)	Measurement distance (meters)
0.009-0.490	2400/F(kHz)	300
0.490-1.705	24000/F(kHz)	30
1.705-30.0	30	30
30-88	100	3
88-216	150	3
216-960	200	3
Above 960	500	3

NOTE:

1. The lower limit shall apply at the transition frequencies.
2. Emission level (dBuV/m) = 20 log Emission level (uV/m).
3. As shown in 15.35(b), for frequencies above 1000MHz, the field strength limits are based on average detector, however, the peak field strength of any emission shall not exceed the maximum permitted average limits, specified above by more than 20dB under any condition of modulation.



4.2.2 TEST INSTRUMENTS

DESCRIPTION & MANUFACTURER	MODEL NO.	SERIAL NO.	CALIBRATED UNTIL
ADVANTEST Spectrum Analyzer	R3271A	85060311	July 03, 2008
HP Pre_Amplifier	8449B	3008A01922	Sep. 18, 2007
ROHDE & SCHWARZ Test Receiver	ESCS30	100375	Sep. 20, 2007
CHASE Broadband Antenna	VULB9168	138	Dec. 10, 2007
Schwarzbeck Horn_Antenna	BBHA9120	D124	Jan. 01, 2008
Schwarzbeck Horn_Antenna	BBHA 9170	BBHA9170153	Jan. 04, 2008
SCHWARZBECK Biconical Antenna	VHBA9123	459	Jun. 08, 2009
SCHWARZBECK Periodic Antenna	UPA6108	1148	Jun. 08, 2009
RF Switches (ARNITSU)	CS-201	1565157	NA
RF CABLE (Chaintek)	SF102	22054-2	Nov. 14, 2007
RF Cable(RICHTEC)	9913-30M N-N Cable	STCCAB-30M-1 GHz	July 15, 2007
Software	ADT_Radiated_V 7.6.15.7	NA	NA
CHANCE MOST Antenna Tower	AT-100	0203	NA
CHANCE MOST Turn Table	TT-100	0203	NA

- Note: 1. The calibration interval of the above test instruments is 12 months (36 months for Biconical and Periodic Antenna) and the calibrations are traceable to NML/ROC and NIST/USA.
2. The horn antenna, HP preamplifier (model: 8449B) and Spectrum Analyzer (model: R3271A) are used only for the measurement of emission frequency above 1GHz if tested.
3. The test was performed in ADT Open Site No. C.
4. The FCC Site Registration No. is 656396.
5. The VCCI Site Registration No. is R-1626.
6. The CANADA Site Registration No. is IC 4824A-3.

4.2.3 TEST PROCEDURES

- a. The EUT was placed on the top of a rotating table 0.8 meters above the ground at a 3 meter semi- anechoic. The table was rotated 360 degrees to determine the position of the highest radiation.
- b. The EUT was set 3 meters away from the interference-receiving antenna, which was mounted on the top of a variable-height antenna tower.
- c. The antenna is a broadband antenna, and its height is varied from one meter to four meters above the ground to determine the maximum value of the field strength. Both horizontal and vertical polarizations of the antenna are set to make the measurement.
- d. For each suspected emission, the EUT was arranged to its worst case and then the antenna was tuned to heights from 1 meter to 4 meters and the rotatable table was turned from 0 degrees to 360 degrees to find the maximum reading.
- e. The test-receiver system was set to Peak Detect Function and Specified Bandwidth with Maximum Hold Mode.
- f. If the emission level of the EUT in peak mode was 10 dB lower than the limit specified, then testing could be stopped and the peak values of the EUT would be reported. Otherwise the emissions that did not have 10 dB margin would be re-tested one by one using the quasi-peak method or average method as specified and then reported in Data sheet peak mode and QP mode.

NOTE:

1. The resolution bandwidth and video bandwidth of test receiver/spectrum analyzer is 120kHz for Peak detection (PK) and Quasi-peak detection (QP) at frequency below 1GHz.
2. The resolution bandwidth of test receiver/spectrum analyzer is 1 MHz and the video bandwidth is 3 MHz for Peak detection (PK) at frequency above 1GHz.
3. The resolution bandwidth of test receiver/spectrum analyzer is 1 MHz and the video bandwidth is 10 Hz for Average detection (AV) at frequency above 1GHz.

4.2.4 DEVIATION FROM TEST STANDARD

No deviation

4.2.5 TEST SETUP

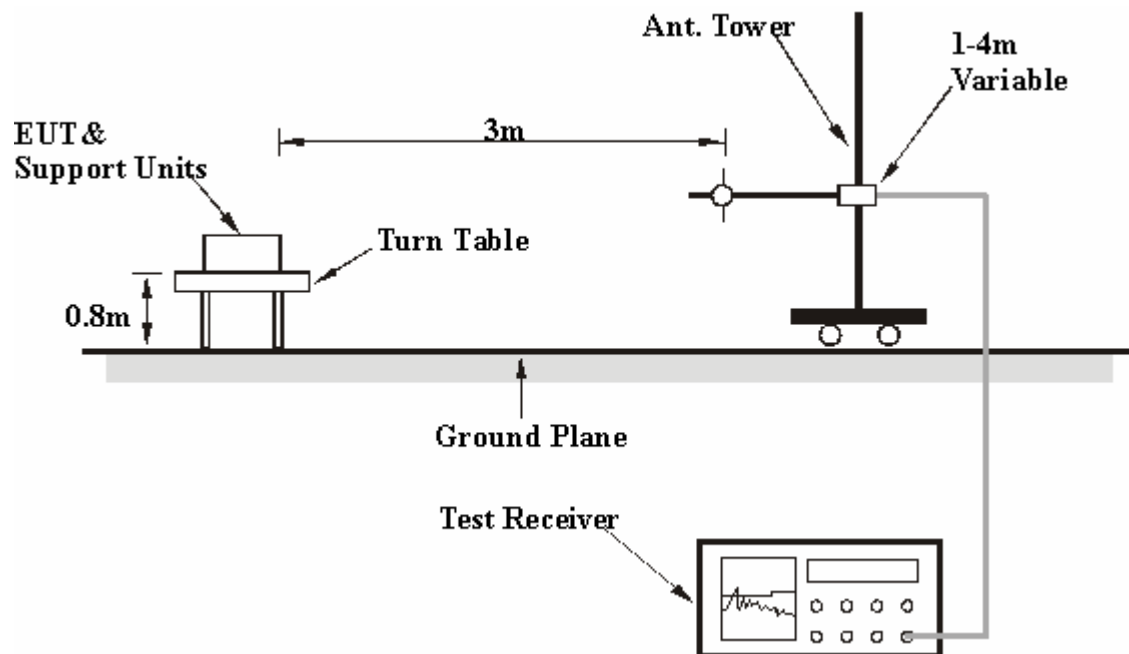

For the actual test configuration, please refer to the related item – Photographs of the Test Configuration.

4.2.6 EUT OPERATING CONDITIONS

Same as 4.1.6



4.2.7 TEST RESULTS

Below 1GHz Worst-Case Data

MODULATION TYPE	CCK	FREQUENCY RANGE	Below 1000MHz
INPUT POWER (SYSTEM)	120Vac, 60 Hz	TRANSFER RATE	1Mbps
ENVIRONMENTAL CONDITIONS	21deg. C, 66%RH, 960hPa	DETECTOR FUNCTION	Quasi-Peak
TESTED BY	Phoenix Huang		

ANTENNA POLARITY & TEST DISTANCE: HORIZONTAL AT 3 M								
No.	Freq. (MHz)	Emission Level (dBuV/m)	Limit (dBuV/m)	Margin (dB)	Antenna Height (m)	Table Angle (Degree)	Raw Value (dBuV)	Correction Factor (dB/m)
1	69.26	32.36 QP	40.00	-7.64	1.00 H	250	19.71	12.65
2	200.01	34.05 QP	43.50	-9.45	1.29 H	50	22.45	11.60
3	280.02	38.96 QP	46.00	-7.04	1.15 H	25	23.10	15.86
4	500.02	34.72 QP	46.00	-11.28	1.50 H	256	12.96	21.76
5	799.99	36.90 QP	46.00	-9.10	1.20 H	60	9.34	27.56
6	880.05	41.26 QP	46.00	-4.74	1.00 H	236	12.59	28.67

ANTENNA POLARITY & TEST DISTANCE: VERTICAL AT 3 M								
No.	Freq. (MHz)	Emission Level (dBuV/m)	Limit (dBuV/m)	Margin (dB)	Antenna Height (m)	Table Angle (Degree)	Raw Value (dBuV)	Correction Factor (dB/m)
1	77.60	35.21 QP	40.00	-4.79	1.00 V	220	24.49	10.72
2	200.03	30.22 QP	43.50	-13.28	1.00 V	60	18.62	11.60
3	500.14	34.29 QP	46.00	-11.71	1.09 V	25	12.53	21.76
4	666.36	30.11 QP	46.00	-15.89	1.42 V	225	4.83	25.28
5	766.89	35.12 QP	46.00	-10.88	1.51 V	257	7.70	27.42
6	959.99	32.14 QP	46.00	-13.86	1.50 V	22	2.25	29.89

- REMARKS:**
1. Emission level(dBuV/m)=Raw Value(dBuV) + Correction Factor(dB/m)
 2. Correction Factor(dB/m) = Antenna Factor (dB/m) + Cable Factor (dB)
 3. The other emission levels were very low against the limit.
 4. Margin value = Emission level – Limit value

802.11b DSSS modulation

CHANNEL	Channel 1	FREQUENCY RANGE	1 ~ 25GHz
MODULATION TYPE	CCK	TRANSFER RATE	1Mbps
INPUT POWER (SYSTEM)	120Vac, 60 Hz	DETECTOR FUNCTION	Peak(PK) Average (AV)
ENVIRONMENTAL CONDITIONS	26deg. C, 69%RH, 960hPa	TESTED BY	Sky Liao

ANTENNA POLARITY & TEST DISTANCE: HORIZONTAL AT 3 M

No.	Freq. (MHz)	Emission Level (dBuV/m)	Limit (dBuV/m)	Margin (dB)	Antenna Height (m)	Table Angle (Degree)	Raw Value (dBuV)	Correction Factor (dB/m)
1	2386.00	59.96 PK	74.00	-14.04	1.00 H	280	29.58	30.38
2	2386.00	49.02 AV	54.00	-4.98	1.00 H	280	18.64	30.38
3	*2412.00	105.90 PK			1.40 H	282	75.41	30.49
4	*2412.00	101.00 AV			1.40 H	282	70.51	30.49
5	4824.00	48.70 PK	74.00	-25.30	1.85 H	88	13.01	35.69
6	4824.00	40.00 AV	54.00	-14.00	1.85 H	88	4.31	35.69
7	7236.00	51.90 PK	74.00	-22.10	1.25 H	105	9.66	42.24
8	7236.00	41.20 AV	54.00	-12.80	1.25 H	105	-1.04	42.24

ANTENNA POLARITY & TEST DISTANCE: VERTICAL AT 3 M

No.	Freq. (MHz)	Emission Level (dBuV/m)	Limit (dBuV/m)	Margin (dB)	Antenna Height (m)	Table Angle (Degree)	Raw Value (dBuV)	Correction Factor (dB/m)
1	2386.00	60.66 PK	74.00	-13.34	1.20 V	253	30.28	30.38
2	2386.00	50.59 AV	54.00	-3.41	1.20 V	253	20.21	30.38
3	*2412.00	105.00 PK			1.12 V	252	74.51	30.49
4	*2412.00	99.80 AV			1.12 V	252	69.31	30.49
5	4824.00	48.10 PK	74.00	-25.90	1.35 V	280	12.41	35.69
6	4824.00	38.00 AV	54.00	-16.00	1.35 V	280	2.31	35.69
7	7236.00	52.30 PK	74.00	-21.70	1.34 V	256	10.06	42.24
8	7236.00	40.10 AV	54.00	-13.90	1.34 V	256	-2.14	42.24

- REMARKS:**
1. Emission level(dBuV/m)=Raw Value(dBuV) + Correction Factor(dB/m)
 2. Correction Factor(dB/m) = Antenna Factor (dB/m) + Cable Factor (dB)
 3. The other emission levels were very low against the limit.
 4. Margin value = Emission level – Limit value.
 5. The limit value is defined as per 15.247
 6. “ * “ : Fundamental frequency

CHANNEL	Channel 2	FREQUENCY RANGE	1 ~ 25GHz
MODULATION TYPE	CCK	TRANSFER RATE	1Mbps
INPUT POWER (SYSTEM)	120Vac, 60 Hz	DETECTOR FUNCTION	Peak(PK) Average (AV)
ENVIRONMENTAL CONDITIONS	26deg. C, 69%RH, 960hPa	TESTED BY	Sky Liao

ANTENNA POLARITY & TEST DISTANCE: HORIZONTAL AT 3 M

No.	Freq. (MHz)	Emission Level (dBuV/m)	Limit (dBuV/m)	Margin (dB)	Antenna Height (m)	Table Angle (Degree)	Raw Value (dBuV)	Correction Factor (dB/m)
1	2390.00	60.14 PK	74.00	-13.86	1.00 H	282	29.74	30.40
2	2390.00	47.93 AV	54.00	-6.07	1.00 H	282	17.53	30.40
3	*2417.00	106.00 PK			1.39 H	282	75.48	30.52
4	*2417.00	101.20 AV			1.39 H	282	70.68	30.52

ANTENNA POLARITY & TEST DISTANCE: VERTICAL AT 3 M

No.	Freq. (MHz)	Emission Level (dBuV/m)	Limit (dBuV/m)	Margin (dB)	Antenna Height (m)	Table Angle (Degree)	Raw Value (dBuV)	Correction Factor (dB/m)
1	2390.00	61.54 PK	74.00	-12.46	1.23 V	252	31.14	30.40
2	2390.00	49.39 AV	54.00	-4.61	1.23 V	252	18.99	30.40
3	*2417.00	105.50 PK			1.19 V	252	74.98	30.52
4	*2417.00	100.30 AV			1.19 V	252	69.78	30.52

- REMARKS:**
1. Emission level(dBuV/m)=Raw Value(dBuV) + Correction Factor(dB/m)
 2. Correction Factor(dB/m) = Antenna Factor (dB/m) + Cable Factor (dB)
 3. The other emission levels were very low against the limit.
 4. Margin value = Emission level – Limit value.
 5. The limit value is defined as per 15.247
 6. “ * “ : Fundamental frequency

CHANNEL	Channel 3	FREQUENCY RANGE	1 ~ 25GHz
MODULATION TYPE	CCK	TRANSFER RATE	1Mbps
INPUT POWER (SYSTEM)	120Vac, 60 Hz	DETECTOR FUNCTION	Peak(PK) Average (AV)
ENVIRONMENTAL CONDITIONS	26deg. C, 69%RH, 960hPa	TESTED BY	Sky Liao

ANTENNA POLARITY & TEST DISTANCE: HORIZONTAL AT 3 M

No.	Freq. (MHz)	Emission Level (dBuV/m)	Limit (dBuV/m)	Margin (dB)	Antenna Height (m)	Table Angle (Degree)	Raw Value (dBuV)	Correction Factor (dB/m)
1	2389.00	59.76 PK	74.00	-14.24	1.00 H	280	29.37	30.39
2	2389.00	48.74 AV	54.00	-5.26	1.00 H	280	18.35	30.39
3	*2422.00	107.60 PK			1.40 H	282	77.06	30.54
4	*2422.00	102.90 AV			1.40 H	282	72.36	30.54

ANTENNA POLARITY & TEST DISTANCE: VERTICAL AT 3 M

No.	Freq. (MHz)	Emission Level (dBuV/m)	Limit (dBuV/m)	Margin (dB)	Antenna Height (m)	Table Angle (Degree)	Raw Value (dBuV)	Correction Factor (dB/m)
1	2389.00	61.94 PK	74.00	-12.06	1.22 V	255	31.55	30.39
2	2389.00	50.33 AV	54.00	-3.67	1.22 V	255	19.94	30.39
3	*2422.00	106.77 PK			1.00 V	252	76.23	30.54
4	*2422.00	101.90 AV			1.00 V	252	71.36	30.54

- REMARKS:**
1. Emission level(dBuV/m)=Raw Value(dBuV) + Correction Factor(dB/m)
 2. Correction Factor(dB/m) = Antenna Factor (dB/m) + Cable Factor (dB)
 3. The other emission levels were very low against the limit.
 4. Margin value = Emission level – Limit value.
 5. The limit value is defined as per 15.247
 6. “ * “ : Fundamental frequency



CHANNEL	Channel 6	FREQUENCY RANGE	1 ~ 25GHz
MODULATION TYPE	CCK	TRANSFER RATE	1Mbps
INPUT POWER (SYSTEM)	120Vac, 60 Hz	DETECTOR FUNCTION	Peak(PK) Average (AV)
ENVIRONMENTAL CONDITIONS	26deg. C, 69%RH, 960hPa	TESTED BY	Sky Liao

ANTENNA POLARITY & TEST DISTANCE: HORIZONTAL AT 3 M

No.	Freq. (MHz)	Emission Level (dBuV/m)	Limit (dBuV/m)	Margin (dB)	Antenna Height (m)	Table Angle (Degree)	Raw Value (dBuV)	Correction Factor (dB/m)
1	*2437.00	107.00 PK			1.39 H	280	76.39	30.61
2	*2437.00	102.10 AV			1.39 H	280	71.49	30.61
3	4874.00	50.53 PK	74.00	-23.47	1.68 H	110	14.73	35.80
4	4874.00	44.37 AV	54.00	-9.63	1.68 H	110	8.57	35.80
5	7311.00	53.10 PK	74.00	-20.90	1.50 H	290	10.58	42.52
6	7311.00	41.10 AV	54.00	-12.90	1.50 H	290	-1.42	42.52

ANTENNA POLARITY & TEST DISTANCE: VERTICAL AT 3 M

No.	Freq. (MHz)	Emission Level (dBuV/m)	Limit (dBuV/m)	Margin (dB)	Antenna Height (m)	Table Angle (Degree)	Raw Value (dBuV)	Correction Factor (dB/m)
1	*2437.00	105.30 PK			1.14 V	252	74.69	30.61
2	*2437.00	100.30 AV			1.14 V	252	69.69	30.61
3	4874.00	49.00 PK	74.00	-25.00	1.38 V	285	13.20	35.80
4	4874.00	41.90 AV	54.00	-12.10	1.38 V	285	6.10	35.80
5	7311.00	52.80 PK	74.00	-21.20	1.18 V	321	10.28	42.52
6	7311.00	40.30 AV	54.00	-13.70	1.18 V	321	-2.22	42.52

- REMARKS:**
1. Emission level(dBuV/m)=Raw Value(dBuV) + Correction Factor(dB/m)
 2. Correction Factor(dB/m) = Antenna Factor (dB/m) + Cable Factor (dB)
 3. The other emission levels were very low against the limit.
 4. Margin value = Emission level – Limit value.
 5. The limit value is defined as per 15.247
 6. “ * “ : Fundamental frequency



CHANNEL	Channel 9	FREQUENCY RANGE	1 ~ 25GHz
MODULATION TYPE	CCK	TRANSFER RATE	1Mbps
INPUT POWER (SYSTEM)	120Vac, 60 Hz	DETECTOR FUNCTION	Peak(PK) Average (AV)
ENVIRONMENTAL CONDITIONS	26deg. C, 69%RH, 960hPa	TESTED BY	Sky Liao

ANTENNA POLARITY & TEST DISTANCE: HORIZONTAL AT 3 M

No.	Freq. (MHz)	Emission Level (dBuV/m)	Limit (dBuV/m)	Margin (dB)	Antenna Height (m)	Table Angle (Degree)	Raw Value (dBuV)	Correction Factor (dB/m)
1	*2452.00	105.90 PK			1.40 H	284	75.23	30.67
2	*2452.00	100.90 AV			1.40 H	284	70.23	30.67
3	2484.00	59.23 PK	74.00	-14.77	1.37 H	282	28.41	30.82
4	2484.00	47.04 AV	54.00	-6.96	1.37 H	282	16.22	30.82

ANTENNA POLARITY & TEST DISTANCE: VERTICAL AT 3 M

No.	Freq. (MHz)	Emission Level (dBuV/m)	Limit (dBuV/m)	Margin (dB)	Antenna Height (m)	Table Angle (Degree)	Raw Value (dBuV)	Correction Factor (dB/m)
1	*2452.00	104.30 PK			1.00 V	252	73.63	30.67
2	*2452.00	99.40 AV			1.00 V	252	68.73	30.67
3	2484.00	58.85 PK	74.00	-15.15	1.15 V	253	28.03	30.82
4	2484.00	47.17 AV	54.00	-6.83	1.15 V	253	16.35	30.82

- REMARKS:**
1. Emission level(dBuV/m)=Raw Value(dBuV) + Correction Factor(dB/m)
 2. Correction Factor(dB/m) = Antenna Factor (dB/m) + Cable Factor (dB)
 3. The other emission levels were very low against the limit.
 4. Margin value = Emission level – Limit value.
 5. The limit value is defined as per 15.247
 6. “ * “ : Fundamental frequency



CHANNEL	Channel 10	FREQUENCY RANGE	1 ~ 25GHz
MODULATION TYPE	CCK	TRANSFER RATE	1Mbps
INPUT POWER (SYSTEM)	120Vac, 60 Hz	DETECTOR FUNCTION	Peak(PK) Average (AV)
ENVIRONMENTAL CONDITIONS	26deg. C, 69%RH, 960hPa	TESTED BY	Sky Liao

ANTENNA POLARITY & TEST DISTANCE: HORIZONTAL AT 3 M

No.	Freq. (MHz)	Emission Level (dBuV/m)	Limit (dBuV/m)	Margin (dB)	Antenna Height (m)	Table Angle (Degree)	Raw Value (dBuV)	Correction Factor (dB/m)
1	*2457.00	104.10 PK			1.30 H	282	73.40	30.70
2	*2457.00	99.00 AV			1.30 H	282	68.30	30.70
3	2483.50	60.10 PK	74.00	-13.90	1.37 H	284	29.28	30.82
4	2483.50	49.00 AV	54.00	-5.00	1.37 H	284	18.18	30.82

ANTENNA POLARITY & TEST DISTANCE: VERTICAL AT 3 M

No.	Freq. (MHz)	Emission Level (dBuV/m)	Limit (dBuV/m)	Margin (dB)	Antenna Height (m)	Table Angle (Degree)	Raw Value (dBuV)	Correction Factor (dB/m)
1	*2457.00	102.60 PK			1.00 V	252	71.90	30.70
2	*2457.00	97.50 AV			1.00 V	252	66.80	30.70
3	2483.50	60.44 PK	74.00	-13.56	1.16 V	254	29.62	30.82
4	2483.50	49.04 AV	54.00	-4.96	1.16 V	254	18.22	30.82

- REMARKS:**
1. Emission level(dBuV/m)=Raw Value(dBuV) + Correction Factor(dB/m)
 2. Correction Factor(dB/m) = Antenna Factor (dB/m) + Cable Factor (dB)
 3. The other emission levels were very low against the limit.
 4. Margin value = Emission level – Limit value.
 5. The limit value is defined as per 15.247
 6. “ * “ : Fundamental frequency

CHANNEL	Channel 11	FREQUENCY RANGE	1 ~ 25GHz
MODULATION TYPE	CCK	TRANSFER RATE	1Mbps
INPUT POWER (SYSTEM)	120Vac, 60 Hz	DETECTOR FUNCTION	Peak(PK) Average (AV)
ENVIRONMENTAL CONDITIONS	26deg. C, 69%RH, 960hPa	TESTED BY	Sky Liao

ANTENNA POLARITY & TEST DISTANCE: HORIZONTAL AT 3 M

No.	Freq. (MHz)	Emission Level (dBuV/m)	Limit (dBuV/m)	Margin (dB)	Antenna Height (m)	Table Angle (Degree)	Raw Value (dBuV)	Correction Factor (dB/m)
1	*2462.00	103.40 PK			1.33 H	288	72.68	30.72
2	*2462.00	98.40 AV			1.33 H	288	67.68	30.72
3	2487.00	58.91 PK	74.00	-15.09	1.37 H	284	28.08	30.83
4	2487.00	47.71 AV	54.00	-6.29	1.37 H	284	16.88	30.83
5	4924.00	49.60 PK	74.00	-24.40	1.63 H	107	13.70	35.90
6	4924.00	42.40 AV	54.00	-11.60	1.63 H	107	6.50	35.90
7	7386.00	53.90 PK	74.00	-20.10	1.40 H	269	11.10	42.80
8	7386.00	40.20 AV	54.00	-13.80	1.40 H	269	-2.60	42.80

ANTENNA POLARITY & TEST DISTANCE: VERTICAL AT 3 M

No.	Freq. (MHz)	Emission Level (dBuV/m)	Limit (dBuV/m)	Margin (dB)	Antenna Height (m)	Table Angle (Degree)	Raw Value (dBuV)	Correction Factor (dB/m)
1	*2462.00	101.90 PK			1.20 V	250	71.18	30.72
2	*2462.00	96.60 AV			1.20 V	250	65.88	30.72
3	2487.00	59.68 PK	74.00	-14.32	1.15 V	253	28.85	30.83
4	2487.00	47.88 AV	54.00	-6.12	1.15 V	253	17.05	30.83
5	4924.00	49.80 PK	74.00	-24.20	1.50 V	290	13.90	35.90
6	4924.00	40.10 AV	54.00	-13.90	1.50 V	290	4.20	35.90
7	7386.00	53.00 PK	74.00	-21.00	1.26 V	139	10.20	42.80
8	7386.00	39.90 AV	54.00	-14.10	1.26 V	139	-2.90	42.80

- REMARKS:**
1. Emission level(dBuV/m)=Raw Value(dBuV) + Correction Factor(dB/m)
 2. Correction Factor(dB/m) = Antenna Factor (dB/m) + Cable Factor (dB)
 3. The other emission levels were very low against the limit.
 4. Margin value = Emission level – Limit value.
 5. The limit value is defined as per 15.247
 6. “ * “ : Fundamental frequency

RESTRICTED BANDEDGE (802.11b MODE, CH1, HORIZONTAL)

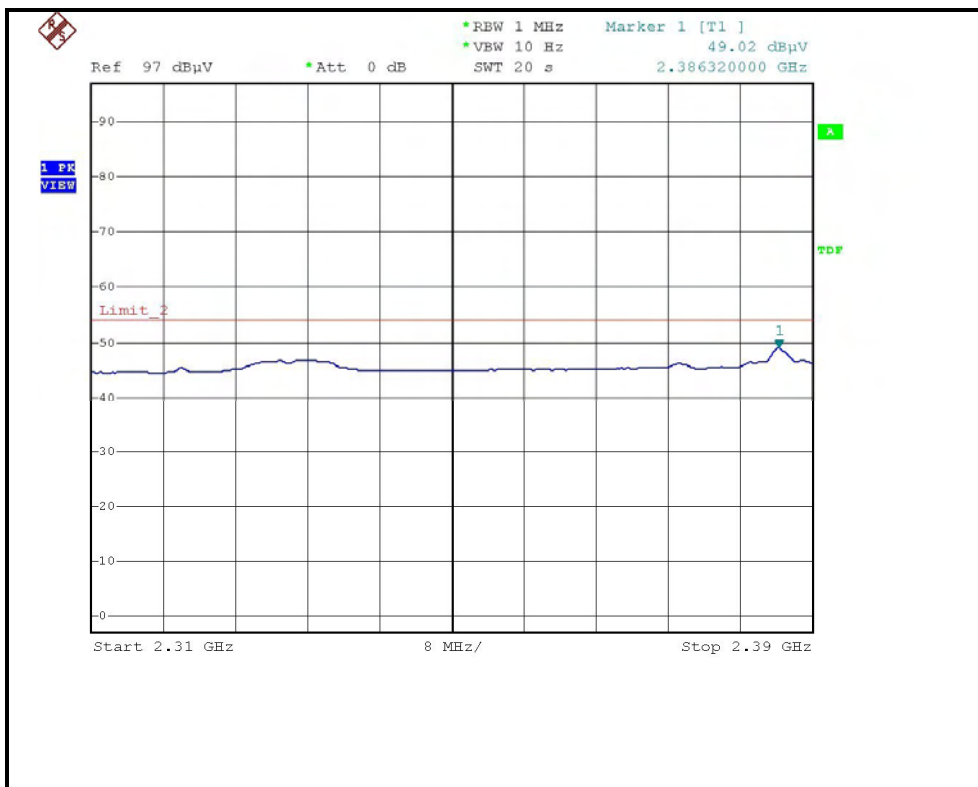
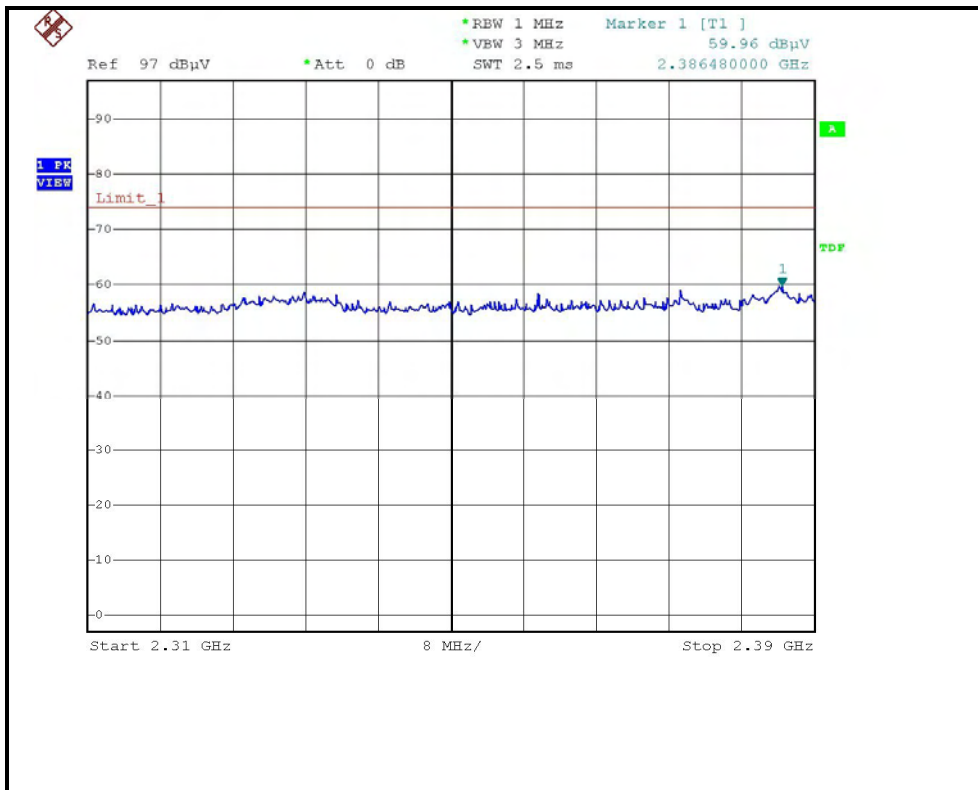

RESTRICTED BANDEDGE (802.11b MODE, CH2, HORIZONTAL)

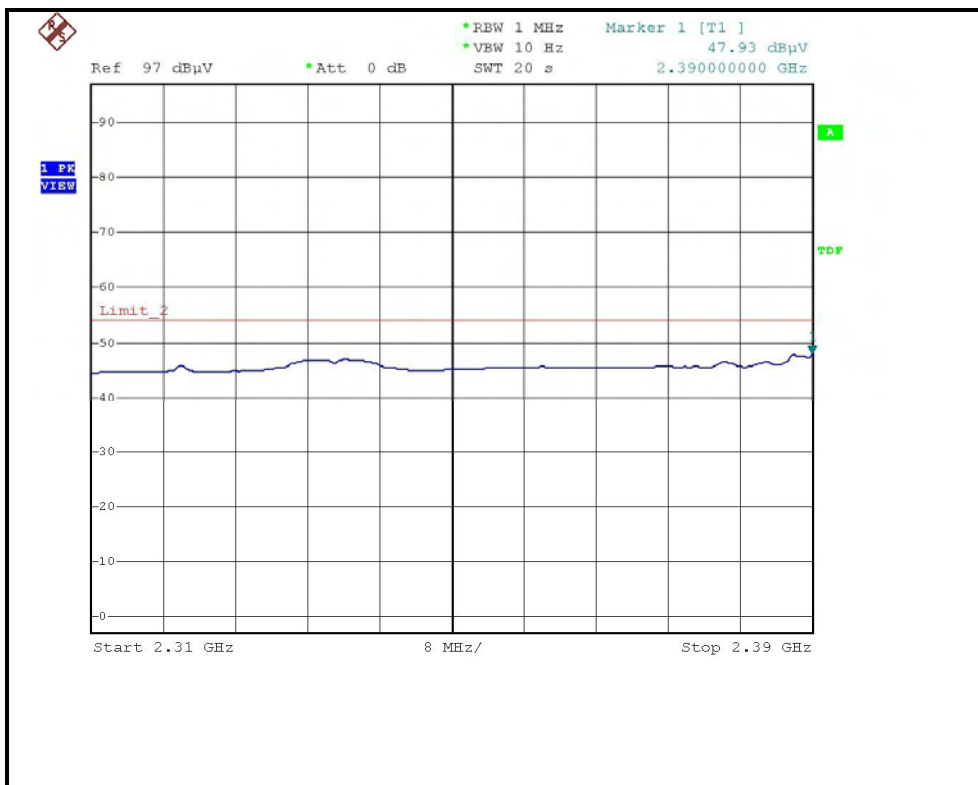
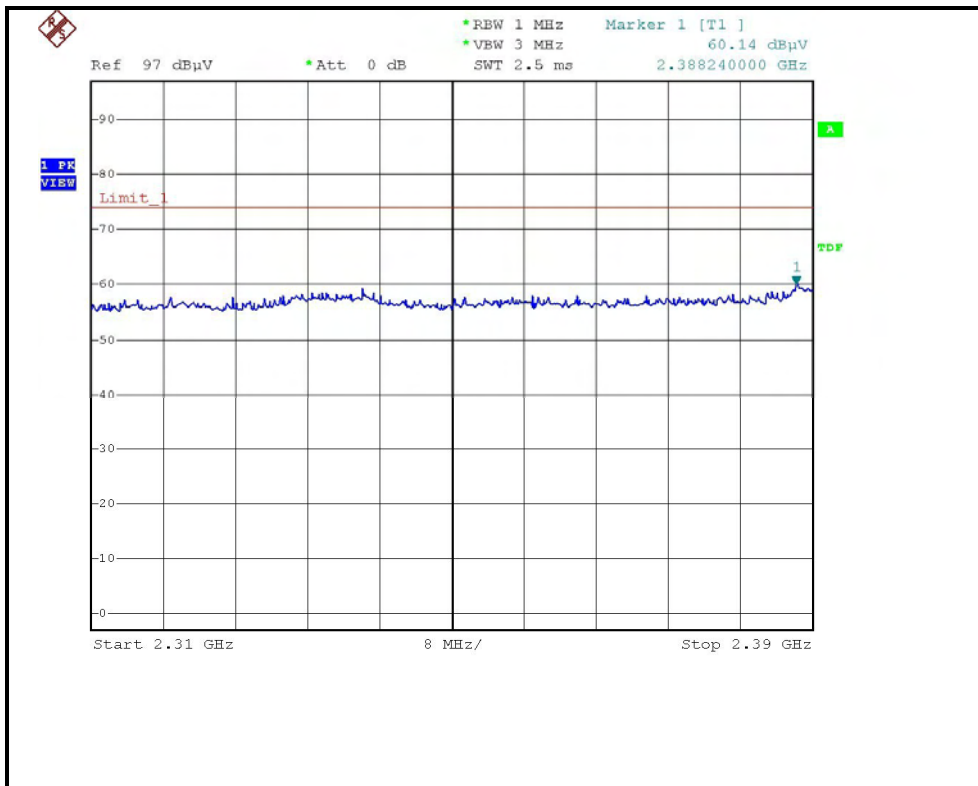

RESTRICTED BANDEDGE (802.11b MODE, CH2, VERTICAL)

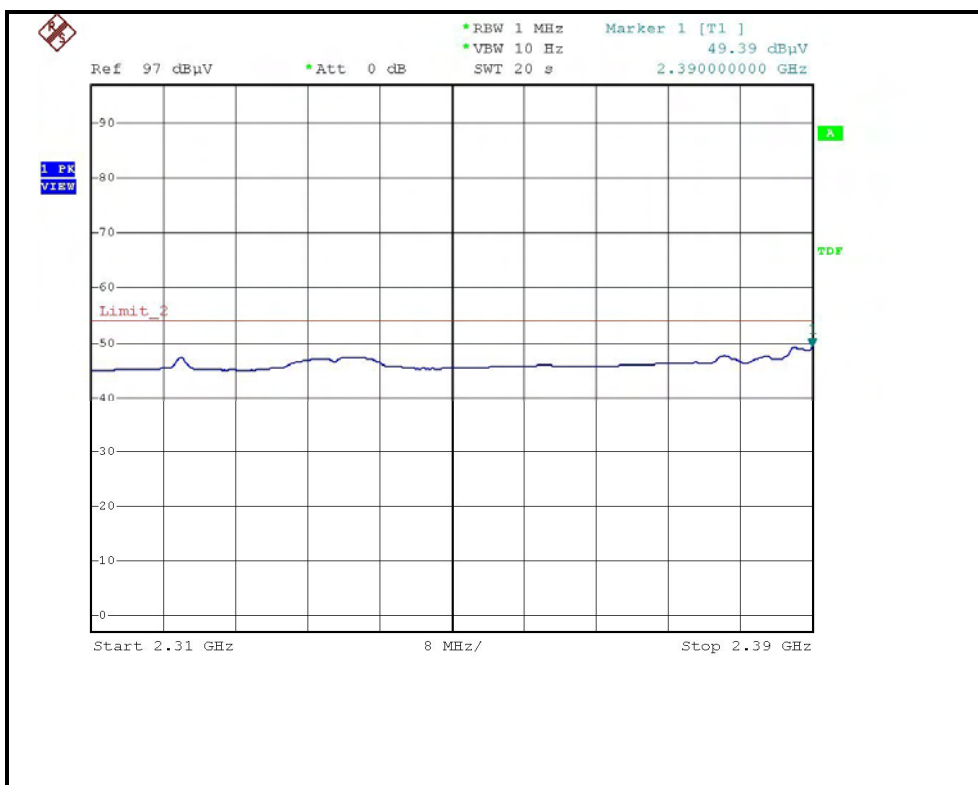
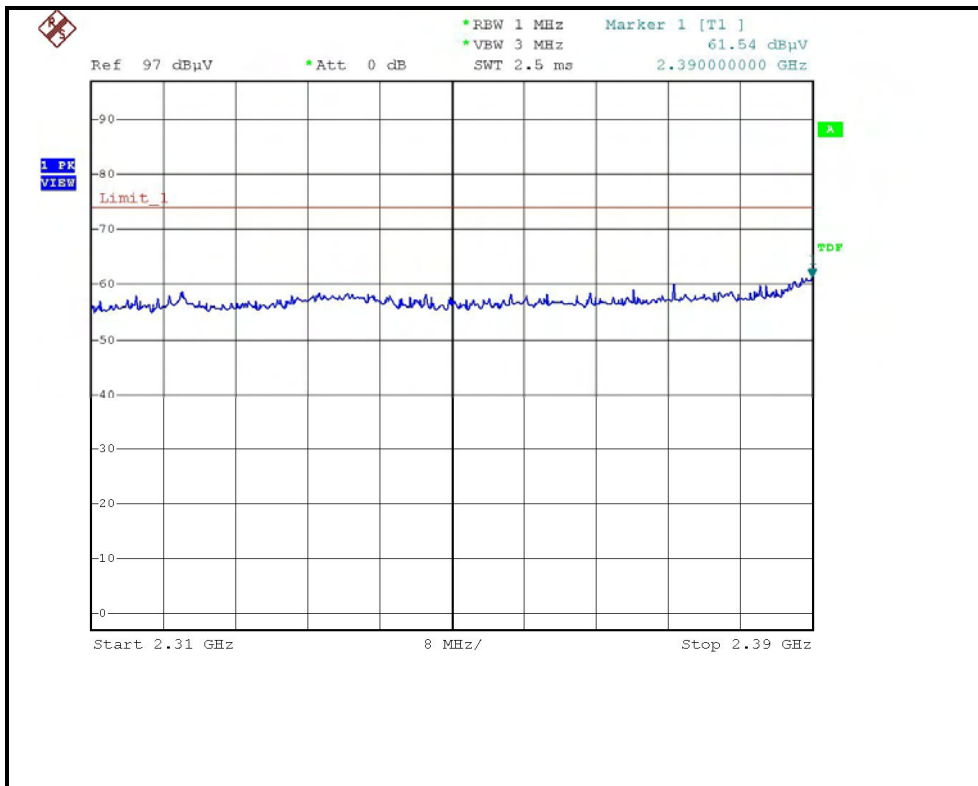

RESTRICTED BANDEDGE (802.11b MODE, CH10, VERTICAL)

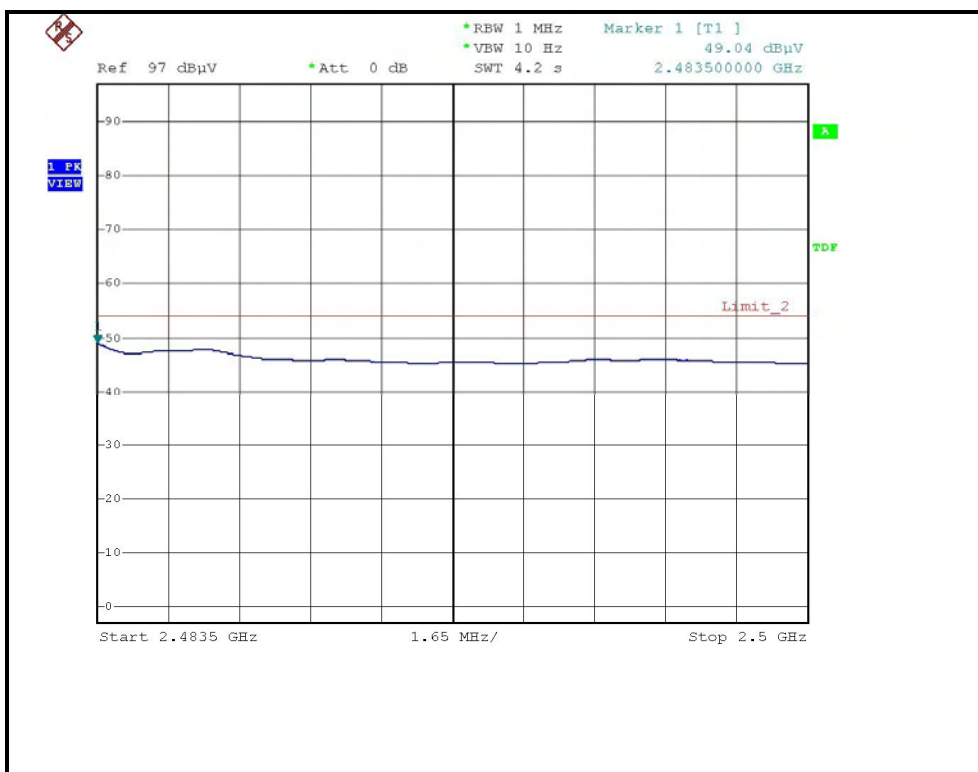
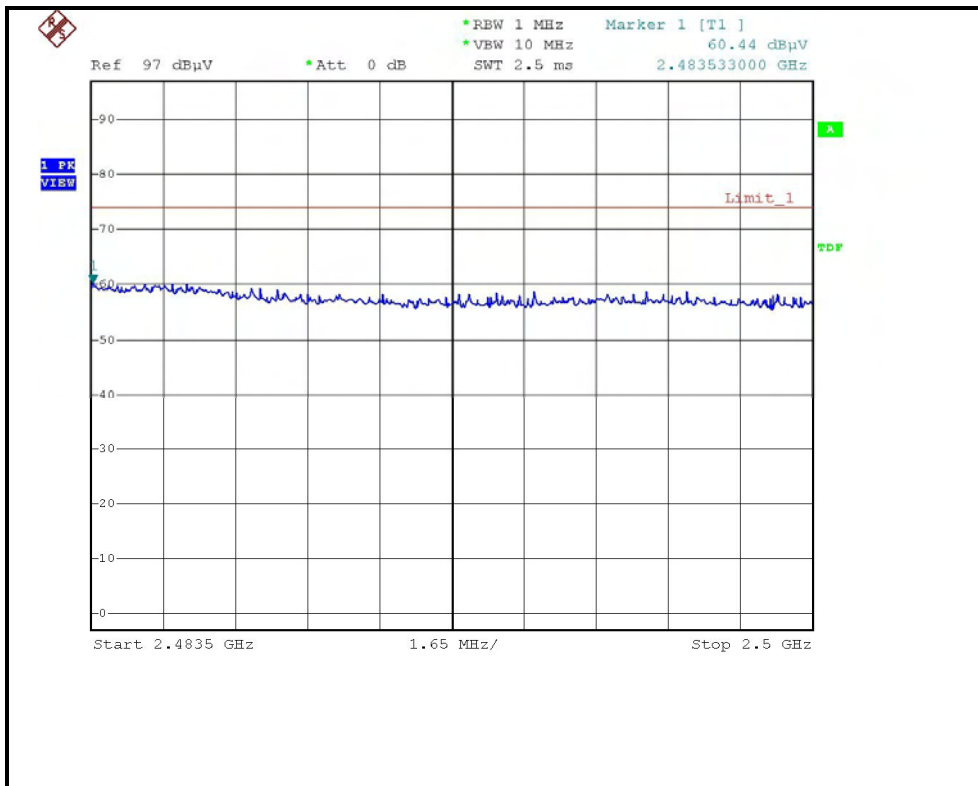

RESTRICTED BANDEDGE (802.11b MODE,CH11, HORIZONTAL)

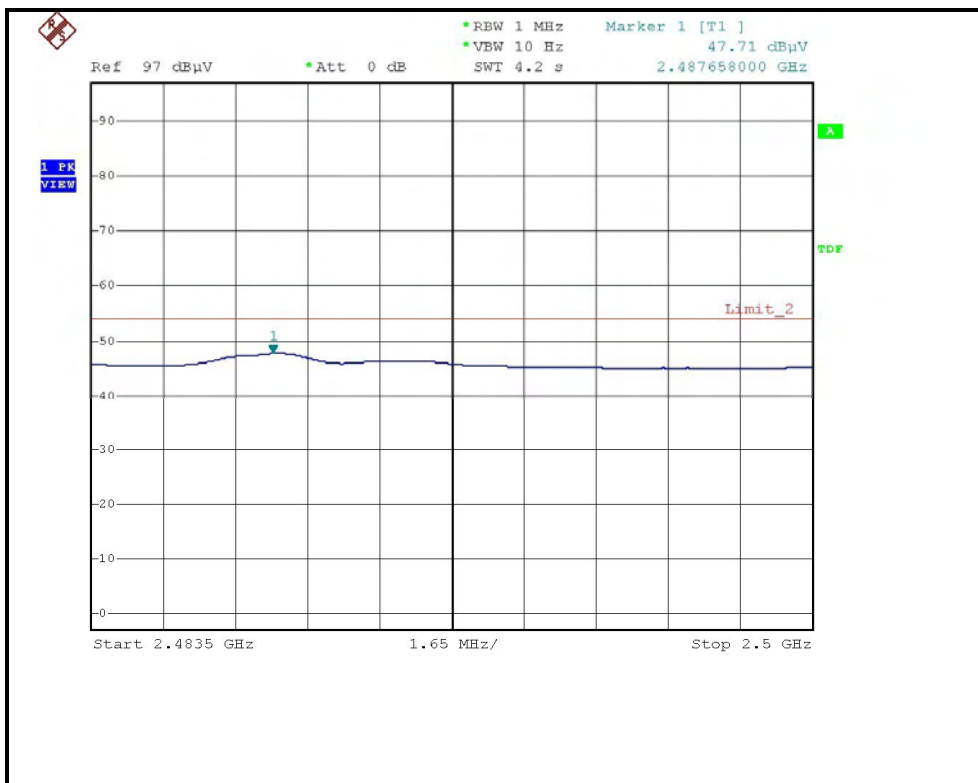
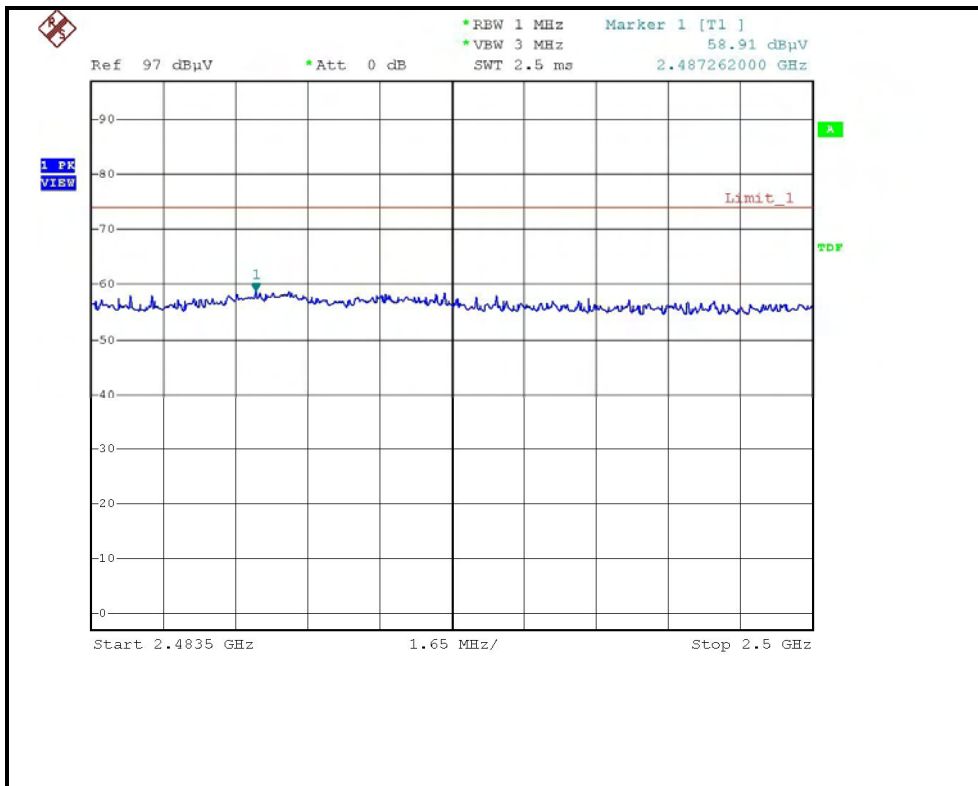

802.11g OFDM modulation

CHANNEL	Channel 1	FREQUENCY RANGE	1 ~ 25GHz
MODULATION TYPE	BPSK	TRANSFER RATE	6Mbps
INPUT POWER (SYSTEM)	120Vac, 60 Hz	DETECTOR FUNCTION	Peak(PK) Average (AV)
ENVIRONMENTAL CONDITIONS	26deg. C, 69%RH, 960hPa	TESTED BY	Sky Liao

ANTENNA POLARITY & TEST DISTANCE: HORIZONTAL AT 3 M

No.	Freq. (MHz)	Emission Level (dBuV/m)	Limit (dBuV/m)	Margin (dB)	Antenna Height (m)	Table Angle (Degree)	Raw Value (dBuV)	Correction Factor (dB/m)
1	2390.00	69.52 PK	74.00	-4.48	1.37 H	283	39.12	30.40
2	2390.00	51.55 AV	54.00	-2.45	1.37 H	283	21.15	30.40
3	*2412.00	105.40 PK			1.40 H	282	74.91	30.49
4	*2412.00	94.80 AV			1.40 H	282	64.31	30.49
5	4824.00	47.20 PK	74.00	-26.80	1.22 H	268	11.51	35.69
6	4824.00	36.20 AV	54.00	-17.80	1.22 H	268	0.51	35.69
7	7236.00	53.60 PK	74.00	-20.40	1.13 H	233	11.36	42.24
8	7236.00	41.20 AV	54.00	-12.80	1.13 H	233	-1.04	42.24

ANTENNA POLARITY & TEST DISTANCE: VERTICAL AT 3 M

No.	Freq. (MHz)	Emission Level (dBuV/m)	Limit (dBuV/m)	Margin (dB)	Antenna Height (m)	Table Angle (Degree)	Raw Value (dBuV)	Correction Factor (dB/m)
1	2390.00	71.51 PK	74.00	-2.49	1.20 V	253	41.12	30.40
2	2390.00	52.90 AV	54.00	-1.10	1.20 V	253	22.50	30.40
3	*2412.00	105.00 PK			1.13 V	252	74.51	30.49
4	*2412.00	94.40 AV			1.13 V	252	63.91	30.49
5	4824.00	46.20 PK	74.00	-27.80	1.32 V	272	10.51	35.69
6	4824.00	35.22 AV	54.00	-18.78	1.32 V	272	-0.47	35.69
7	7236.00	53.00 PK	74.00	-21.00	1.23 V	262	10.76	42.24
8	7236.00	40.70 AV	54.00	-13.30	1.23 V	262	-1.54	42.24

- REMARKS:**
1. Emission level(dBuV/m)=Raw Value(dBuV) + Correction Factor(dB/m)
 2. Correction Factor(dB/m) = Antenna Factor (dB/m) + Cable Factor (dB)
 3. The other emission levels were very low against the limit.
 4. Margin value = Emission level – Limit value.
 5. The limit value is defined as per 15.247
 6. “ * “ : Fundamental frequency



CHANNEL	Channel 2	FREQUENCY RANGE	1 ~ 25GHz
MODULATION TYPE	BPSK	TRANSFER RATE	6Mbps
INPUT POWER (SYSTEM)	120Vac, 60 Hz	DETECTOR FUNCTION	Peak(PK) Average (AV)
ENVIRONMENTAL CONDITIONS	26deg. C, 69%RH, 960hPa	TESTED BY	Sky Liao

ANTENNA POLARITY & TEST DISTANCE: HORIZONTAL AT 3 M

No.	Freq. (MHz)	Emission Level (dBuV/m)	Limit (dBuV/m)	Margin (dB)	Antenna Height (m)	Table Angle (Degree)	Raw Value (dBuV)	Correction Factor (dB/m)
1	2390.00	66.37 PK	74.00	-7.63	1.00 H	282	35.98	30.40
2	2390.00	51.06 AV	54.00	-2.94	1.00 H	282	20.66	30.40
3	*2417.00	107.20 PK			1.40 H	280	76.68	30.52
4	*2417.00	96.60 AV			1.40 H	280	66.08	30.52

ANTENNA POLARITY & TEST DISTANCE: VERTICAL AT 3 M

No.	Freq. (MHz)	Emission Level (dBuV/m)	Limit (dBuV/m)	Margin (dB)	Antenna Height (m)	Table Angle (Degree)	Raw Value (dBuV)	Correction Factor (dB/m)
1	2390.00	68.31 PK	74.00	-5.69	1.23 V	252	37.91	30.40
2	2390.00	53.00 AV	54.00	-1.00	1.23 V	252	22.60	30.40
3	*2417.00	106.00 PK			1.13 V	260	75.48	30.52
4	*2417.00	95.60 AV			1.13 V	260	65.08	30.52

- REMARKS:**
1. Emission level(dBuV/m)=Raw Value(dBuV) + Correction Factor(dB/m)
 2. Correction Factor(dB/m) = Antenna Factor (dB/m) + Cable Factor (dB)
 3. The other emission levels were very low against the limit.
 4. Margin value = Emission level – Limit value.
 5. The limit value is defined as per 15.247
 6. “ * “ : Fundamental frequency

CHANNEL	Channel 3	FREQUENCY RANGE	1 ~ 25GHz
MODULATION TYPE	BPSK	TRANSFER RATE	6Mbps
INPUT POWER (SYSTEM)	120Vac, 60 Hz	DETECTOR FUNCTION	Peak(PK) Average (AV)
ENVIRONMENTAL CONDITIONS	26deg. C, 69%RH, 960hPa	TESTED BY	Sky Liao

ANTENNA POLARITY & TEST DISTANCE: HORIZONTAL AT 3 M

No.	Freq. (MHz)	Emission Level (dBuV/m)	Limit (dBuV/m)	Margin (dB)	Antenna Height (m)	Table Angle (Degree)	Raw Value (dBuV)	Correction Factor (dB/m)
1	2390.00	67.28 PK	74.00	-6.72	1.00 H	282	36.88	30.40
2	2390.00	51.25 AV	54.00	-2.75	1.00 H	282	20.85	30.40
3	*2422.00	108.90 PK			1.39 H	282	78.36	30.54
4	*2422.00	98.22 AV			1.39 H	282	67.68	30.54

ANTENNA POLARITY & TEST DISTANCE: VERTICAL AT 3 M

No.	Freq. (MHz)	Emission Level (dBuV/m)	Limit (dBuV/m)	Margin (dB)	Antenna Height (m)	Table Angle (Degree)	Raw Value (dBuV)	Correction Factor (dB/m)
1	2390.00	70.11 PK	74.00	-3.89	1.21 V	253	39.71	30.40
2	2390.00	52.94 AV	54.00	-1.06	1.21 V	253	22.54	30.40
3	*2422.00	107.70 PK			1.14 V	260	77.16	30.54
4	*2422.00	97.10 AV			1.14 V	260	66.56	30.54

- REMARKS:**
1. Emission level(dBuV/m)=Raw Value(dBuV) + Correction Factor(dB/m)
 2. Correction Factor(dB/m) = Antenna Factor (dB/m) + Cable Factor (dB)
 3. The other emission levels were very low against the limit.
 4. Margin value = Emission level – Limit value.
 5. The limit value is defined as per 15.247
 6. “ * “ : Fundamental frequency



CHANNEL	Channel 4	FREQUENCY RANGE	1 ~ 25GHz
MODULATION TYPE	BPSK	TRANSFER RATE	6Mbps
INPUT POWER (SYSTEM)	120Vac, 60 Hz	DETECTOR FUNCTION	Peak(PK) Average (AV)
ENVIRONMENTAL CONDITIONS	26deg. C, 69%RH, 960hPa	TESTED BY	Sky Liao

ANTENNA POLARITY & TEST DISTANCE: HORIZONTAL AT 3 M

No.	Freq. (MHz)	Emission Level (dBuV/m)	Limit (dBuV/m)	Margin (dB)	Antenna Height (m)	Table Angle (Degree)	Raw Value (dBuV)	Correction Factor (dB/m)
1	2390.00	66.85 PK	74.00	-7.15	1.00 H	282	36.45	30.40
2	2390.00	51.00 AV	54.00	-3.00	1.00 H	282	20.60	30.40
3	*2427.00	109.30 PK			4.00 H	282	78.74	30.56
4	*2427.00	98.80 AV			4.00 H	282	68.24	30.56

ANTENNA POLARITY & TEST DISTANCE: VERTICAL AT 3 M

No.	Freq. (MHz)	Emission Level (dBuV/m)	Limit (dBuV/m)	Margin (dB)	Antenna Height (m)	Table Angle (Degree)	Raw Value (dBuV)	Correction Factor (dB/m)
1	2390.00	69.49 PK	74.00	-4.51	1.23 V	253	39.09	30.40
2	2390.00	52.73 AV	54.00	-1.27	1.23 V	253	22.33	30.40
3	*2427.00	108.40 PK			1.13 V	259	77.84	30.56
4	*2427.00	97.80 AV			1.13 V	259	67.24	30.56

- REMARKS:**
1. Emission level(dBuV/m)=Raw Value(dBuV) + Correction Factor(dB/m)
 2. Correction Factor(dB/m) = Antenna Factor (dB/m) + Cable Factor (dB)
 3. The other emission levels were very low against the limit.
 4. Margin value = Emission level – Limit value.
 5. The limit value is defined as per 15.247
 6. “ * “ : Fundamental frequency



CHANNEL	Channel 6	FREQUENCY RANGE	1 ~ 25GHz
MODULATION TYPE	BPSK	TRANSFER RATE	6Mbps
INPUT POWER (SYSTEM)	120Vac, 60 Hz	DETECTOR FUNCTION	Peak(PK) Average (AV)
ENVIRONMENTAL CONDITIONS	26deg. C, 69%RH, 960hPa	TESTED BY	Sky Liao

ANTENNA POLARITY & TEST DISTANCE: HORIZONTAL AT 3 M

No.	Freq. (MHz)	Emission Level (dBuV/m)	Limit (dBuV/m)	Margin (dB)	Antenna Height (m)	Table Angle (Degree)	Raw Value (dBuV)	Correction Factor (dB/m)
1	*2437.00	109.90 PK			1.38 H	283	79.29	30.61
2	*2437.00	99.40 AV			1.38 H	283	68.79	30.61
3	4874.00	49.74 PK	74.00	-24.26	1.35 H	110	13.94	35.80
4	4874.00	36.50 AV	54.00	-17.50	1.35 H	110	0.70	35.80
5	7311.00	52.60 PK	74.00	-21.40	1.19 H	162	10.08	42.52
6	7311.00	41.10 AV	54.00	-12.90	1.19 H	162	-1.42	42.52

ANTENNA POLARITY & TEST DISTANCE: VERTICAL AT 3 M

No.	Freq. (MHz)	Emission Level (dBuV/m)	Limit (dBuV/m)	Margin (dB)	Antenna Height (m)	Table Angle (Degree)	Raw Value (dBuV)	Correction Factor (dB/m)
1	*2437.00	108.50 PK			1.12 V	260	77.89	30.61
2	*2437.00	97.90 AV			1.12 V	260	67.29	30.61
3	4874.00	48.80 PK	74.00	-25.20	1.55 V	189	13.00	35.80
4	4874.00	36.20 AV	54.00	-17.80	1.55 V	189	0.40	35.80
5	7311.00	51.80 PK	74.00	-22.20	1.45 V	172	9.28	42.52
6	7311.00	40.20 AV	54.00	-13.80	1.45 V	172	-2.32	42.52

- REMARKS:**
1. Emission level(dBuV/m)=Raw Value(dBuV) + Correction Factor(dB/m)
 2. Correction Factor(dB/m) = Antenna Factor (dB/m) + Cable Factor (dB)
 3. The other emission levels were very low against the limit.
 4. Margin value = Emission level – Limit value.
 5. The limit value is defined as per 15.247
 6. “ * “ : Fundamental frequency

CHANNEL	Channel 8	FREQUENCY RANGE	1 ~ 25GHz
MODULATION TYPE	BPSK	TRANSFER RATE	6Mbps
INPUT POWER (SYSTEM)	120Vac, 60 Hz	DETECTOR FUNCTION	Peak(PK) Average (AV)
ENVIRONMENTAL CONDITIONS	26deg. C, 69%RH, 960hPa	TESTED BY	Sky Liao

ANTENNA POLARITY & TEST DISTANCE: HORIZONTAL AT 3 M

No.	Freq. (MHz)	Emission Level (dBuV/m)	Limit (dBuV/m)	Margin (dB)	Antenna Height (m)	Table Angle (Degree)	Raw Value (dBuV)	Correction Factor (dB/m)
1	*2447.00	108.90 PK			1.39 H	280	78.25	30.65
2	*2447.00	98.70 AV			1.39 H	280	68.05	30.65
3	2483.50	66.42 PK	74.00	-7.58	1.95 H	288	35.60	30.82
4	2483.50	49.29 AV	54.00	-4.71	1.95 H	288	18.47	30.82

ANTENNA POLARITY & TEST DISTANCE: VERTICAL AT 3 M

No.	Freq. (MHz)	Emission Level (dBuV/m)	Limit (dBuV/m)	Margin (dB)	Antenna Height (m)	Table Angle (Degree)	Raw Value (dBuV)	Correction Factor (dB/m)
1	*2447.00	107.90 PK			1.10 V	260	77.25	30.65
2	*2447.00	97.40 AV			1.10 V	260	66.75	30.65
3	2483.50	67.11 PK	74.00	-6.89	1.14 V	253	36.29	30.82
4	2483.50	50.04 AV	54.00	-3.96	1.14 V	253	19.22	30.82

- REMARKS:**
1. Emission level(dBuV/m)=Raw Value(dBuV) + Correction Factor(dB/m)
 2. Correction Factor(dB/m) = Antenna Factor (dB/m) + Cable Factor (dB)
 3. The other emission levels were very low against the limit.
 4. Margin value = Emission level – Limit value.
 5. The limit value is defined as per 15.247
 6. “ * “ : Fundamental frequency

CHANNEL	Channel 9	FREQUENCY RANGE	1 ~ 25GHz
MODULATION TYPE	BPSK	TRANSFER RATE	6Mbps
INPUT POWER (SYSTEM)	120Vac, 60 Hz	DETECTOR FUNCTION	Peak(PK) Average (AV)
ENVIRONMENTAL CONDITIONS	26deg. C, 69%RH, 960hPa	TESTED BY	Sky Liao

ANTENNA POLARITY & TEST DISTANCE: HORIZONTAL AT 3 M

No.	Freq. (MHz)	Emission Level (dBuV/m)	Limit (dBuV/m)	Margin (dB)	Antenna Height (m)	Table Angle (Degree)	Raw Value (dBuV)	Correction Factor (dB/m)
1	*2452.00	106.60 PK			1.39 H	283	75.93	30.67
2	*2452.00	96.40 AV			1.39 H	283	65.73	30.67
3	2483.50	67.60 PK	74.00	-6.40	1.37 H	284	36.78	30.82
4	2483.50	49.73 AV	54.00	-4.27	1.37 H	284	18.91	30.82

ANTENNA POLARITY & TEST DISTANCE: VERTICAL AT 3 M

No.	Freq. (MHz)	Emission Level (dBuV/m)	Limit (dBuV/m)	Margin (dB)	Antenna Height (m)	Table Angle (Degree)	Raw Value (dBuV)	Correction Factor (dB/m)
1	*2452.00	106.30 PK			1.09 V	259	75.63	30.67
2	*2452.00	95.80 AV			1.09 V	259	65.13	30.67
3	2483.50	68.09 PK	74.00	-5.91	1.16 V	254	37.27	30.82
4	2483.50	50.00 AV	54.00	-4.00	1.16 V	254	19.18	30.82

- REMARKS:**
1. Emission level(dBuV/m)=Raw Value(dBuV) + Correction Factor(dB/m)
 2. Correction Factor(dB/m) = Antenna Factor (dB/m) + Cable Factor (dB)
 3. The other emission levels were very low against the limit.
 4. Margin value = Emission level – Limit value.
 5. The limit value is defined as per 15.247
 6. “ * “ : Fundamental frequency

CHANNEL	Channel 10	FREQUENCY RANGE	1 ~ 25GHz
MODULATION TYPE	BPSK	TRANSFER RATE	6Mbps
INPUT POWER (SYSTEM)	120Vac, 60 Hz	DETECTOR FUNCTION	Peak(PK) Average (AV)
ENVIRONMENTAL CONDITIONS	26deg. C, 69%RH, 960hPa	TESTED BY	Sky Liao

ANTENNA POLARITY & TEST DISTANCE: HORIZONTAL AT 3 M

No.	Freq. (MHz)	Emission Level (dBuV/m)	Limit (dBuV/m)	Margin (dB)	Antenna Height (m)	Table Angle (Degree)	Raw Value (dBuV)	Correction Factor (dB/m)
1	*2457.00	104.70 PK			1.29 H	282	74.00	30.70
2	*2457.00	93.90 AV			1.29 H	282	63.20	30.70
3	2483.50	67.34 PK	74.00	-6.66	1.37 H	284	36.52	30.82
4	2483.50	49.52 AV	54.00	-4.48	1.37 H	284	18.70	30.82

ANTENNA POLARITY & TEST DISTANCE: VERTICAL AT 3 M

No.	Freq. (MHz)	Emission Level (dBuV/m)	Limit (dBuV/m)	Margin (dB)	Antenna Height (m)	Table Angle (Degree)	Raw Value (dBuV)	Correction Factor (dB/m)
1	*2457.00	104.60 PK			1.07 V	260	73.90	30.70
2	*2457.00	94.00 AV			1.07 V	260	63.30	30.70
3	2483.50	67.82 PK	74.00	-6.18	1.15 V	254	37.00	30.82
4	2483.50	49.79 AV	54.00	-4.21	1.15 V	254	18.97	30.82

- REMARKS:**
1. Emission level(dBuV/m)=Raw Value(dBuV) + Correction Factor(dB/m)
 2. Correction Factor(dB/m) = Antenna Factor (dB/m) + Cable Factor (dB)
 3. The other emission levels were very low against the limit.
 4. Margin value = Emission level – Limit value.
 5. The limit value is defined as per 15.247
 6. “ * “ : Fundamental frequency



CHANNEL	Channel 11	FREQUENCY RANGE	1 ~ 25GHz
MODULATION TYPE	BPSK	TRANSFER RATE	6Mbps
INPUT POWER (SYSTEM)	120Vac, 60 Hz	DETECTOR FUNCTION	Peak(PK) Average (AV)
ENVIRONMENTAL CONDITIONS	26deg. C, 69%RH, 960hPa	TESTED BY	Sky Liao

ANTENNA POLARITY & TEST DISTANCE: HORIZONTAL AT 3 M

No.	Freq. (MHz)	Emission Level (dBuV/m)	Limit (dBuV/m)	Margin (dB)	Antenna Height (m)	Table Angle (Degree)	Raw Value (dBuV)	Correction Factor (dB/m)
1	*2462.00	103.40 PK			1.30 H	283	72.68	30.72
2	*2462.00	92.70 AV			1.30 H	283	61.98	30.72
3	2483.50	67.14 PK	74.00	-6.86	1.38 H	285	36.32	30.82
4	2483.50	48.95 AV	54.00	-5.05	1.38 H	285	18.13	30.82
5	4924.00	46.90 PK	74.00	-27.10	1.29 H	111	11.00	35.90
6	4924.00	35.70 AV	54.00	-18.30	1.29 H	111	-0.20	35.90
7	7386.00	52.70 PK	74.00	-21.30	1.26 H	320	9.90	42.80
8	7386.00	40.90 AV	54.00	-13.10	1.26 H	320	-1.90	42.80

ANTENNA POLARITY & TEST DISTANCE: VERTICAL AT 3 M

No.	Freq. (MHz)	Emission Level (dBuV/m)	Limit (dBuV/m)	Margin (dB)	Antenna Height (m)	Table Angle (Degree)	Raw Value (dBuV)	Correction Factor (dB/m)
1	*2462.00	103.10 PK			1.06 V	260	72.38	30.72
2	*2462.00	92.10 AV			1.06 V	260	61.38	30.72
3	2483.50	67.25 PK	74.00	-6.75	1.17 V	254	36.43	30.82
4	2483.50	49.15 AV	54.00	-4.85	1.17 V	254	18.33	30.82
5	4924.00	45.20 PK	74.00	-28.80	1.40 V	156	9.30	35.90
6	4924.00	34.10 AV	54.00	-19.90	1.40 V	156	-1.80	35.90
7	7386.00	53.20 PK	74.00	-20.80	1.20 V	266	10.40	42.80
8	7386.00	39.20 AV	54.00	-14.80	1.20 V	266	-3.60	42.80

- REMARKS:**
1. Emission level(dBuV/m)=Raw Value(dBuV) + Correction Factor(dB/m)
 2. Correction Factor(dB/m) = Antenna Factor (dB/m) + Cable Factor (dB)
 3. The other emission levels were very low against the limit.
 4. Margin value = Emission level – Limit value.
 5. The limit value is defined as per 15.247
 6. “ * “ : Fundamental frequency