



# FCC TEST REPORT

**REPORT NO.:** RF960622H01G

**MODEL NO.:** LA-5127A2

**FCC ID:** H9PLA5127A2

**RECEIVED:** June 01, 2010

**TESTED:** July 24 to 26, 2010

**ISSUED:** Sep. 15, 2010

**APPLICANT:** Symbol Technologies Inc.

**ADDRESS:** One Symbol Plaza, Holtsville, NY 11742-1300 U.S.A.

**ISSUED BY :** Bureau Veritas Consumer Products Services (H.K.) Ltd., Taoyuan Branch Hsin Chu Laboratory

**LAB ADDRESS :** No. 81-1, Lu Liao Keng, 9th Ling, Wu Lung Tsuen, Chiung Lin Hsiang, Hsin Chu Hsien 307, Taiwan

This test report consists of 35 pages in total. It may be duplicated completely for legal use with the approval of the applicant. It should not be reproduced except in full, without the written approval of our laboratory. The client should not use it to claim product endorsement by TAF or any government agencies. The test results in the report only apply to the tested sample.





A D T

## Table of Contents

1.	CERTIFICATION .....	3
2.	SUMMARY OF TEST RESULTS .....	4
2.1	MEASUREMENT UNCERTAINTY .....	5
3.	GENERAL INFORMATION .....	6
3.1	GENERAL DESCRIPTION OF EUT .....	6
3.2	DESCRIPTION OF TEST MODES .....	7
3.2.1	TEST MODE APPLICABILITY AND TESTED CHANNEL DETAIL .....	8
3.3	GENERAL DESCRIPTION OF APPLIED STANDARDS .....	10
3.4	DESCRIPTION OF SUPPORT UNITS.....	11
3.5	CONFIGURATION OF SYSTEM UNDER TEST .....	11
4.	TEST TYPES AND RESULTS .....	12
4.1	RADIATED EMISSION MEASUREMENT .....	12
4.1.1	LIMITS OF RADIATED EMISSION MEASUREMENT .....	12
4.1.2	TEST INSTRUMENTS.....	13
4.1.3	TEST PROCEDURES .....	14
4.1.4	DEVIATION FROM TEST STANDARD .....	14
4.1.5	TEST SETUP .....	15
4.1.6	EUT OPERATING CONDITIONS .....	15
4.1.7	TEST RESULTS .....	16
4.2	MAXIMUM PEAK OUTPUT POWER.....	31
4.2.1	LIMITS OF MAXIMUM PEAK OUTPUT POWER MEASUREMENT .....	31
4.2.2	INSTRUMENTS.....	31
4.2.3	TEST PROCEDURES .....	31
4.2.4	DEVIATION FROM TEST STANDARD .....	31
4.2.5	TEST SETUP .....	32
4.2.6	EUT OPERATING CONDITIONS .....	32
4.2.7	TEST RESULTS .....	33
5.	INFORMATION ON THE TESTING LABORATORIES .....	34
6.	APPENDIX-A- MODIFICATIONS RECORDERS FOR ENGINEERING CHANGES TO THE EUT BY THE LAB.....	35



A D T

## 1. CERTIFICATION

**PRODUCT:** 802.11b/g Compact Flash Radio Card  
**BRAND NAME:** Symbol Technologies Inc.  
**MODEL NO.:** LA-5127A2  
**TEST SAMPLE:** R&D SAMPLE  
**TESTED:** July 24 to 26, 2010  
**APPLICANT:** Symbol Technologies Inc.  
**STANDARDS:** FCC Part 15, Subpart C (Section 15.247)  
ANSI C63.4-2003

The above equipment (Model: LA-5127A2) has been tested by **Bureau Veritas Consumer Products Services (H.K.) Ltd., Taoyuan Branch**, and found compliance with the requirement of the above standards. The test record, data evaluation & Equipment Under Test (EUT) configurations represented herein are true and accurate accounts of the measurements of the sample's EMC characteristics under the conditions specified in this report.

**PREPARED BY** :  , **DATE:** Sep. 15, 2010  
( Claire Kuan, Specialist )

**TECHNICAL ACCEPTANCE** :  , **DATE:** Sep. 15, 2010  
( Hank Chung, Deputy Manager )

**APPROVED BY** :  , **DATE:** Sep. 15, 2010  
( May Chen, Deputy Manager )



A D T

## 2. SUMMARY OF TEST RESULTS

The EUT has been tested according to the following specifications:

<b>APPLIED STANDARD: FCC Part 15, Subpart C (Section 15.247)</b>			
<b>Standard Section</b>	<b>Test Type and Limit</b>	<b>Result</b>	<b>Remark</b>
15.247(b)	Maximum Peak Output Power Limit: max. 30dBm	PASS	Meet the requirement of limit.
15.247(d)	Radiated Emissions Limit: Table 15.209	PASS	Meet the requirement of limit. Minimum passing margin is -1.3dB at 2390.0MHz

**NOTE:**

1. This report is prepared for FCC class II permissive change. Only radiated emission and maximum peak output power were presented in this test report.

## 2.1 MEASUREMENT UNCERTAINTY

Where relevant, the following measurement uncertainty levels have been estimated for tests performed on the EUT as specified in CISPR 16-4-2:

This uncertainty represents an expanded uncertainty expressed at approximately the 95% confidence level using a coverage factor of  $k=2$ .

Measurement	Value
Radiated emissions (30MHz-1GHz)	3.94 dB
Radiated emissions (1GHz -18GHz)	2.49 dB
Radiated emissions (18GHz -40GHz)	2.70 dB



A D T

### 3. GENERAL INFORMATION

#### 3.1 GENERAL DESCRIPTION OF EUT

<b>PRODUCT</b>	802.11b/g Compact Flash Radio Card
<b>MODEL NO.</b>	LA-5127A2
<b>FCC ID</b>	H9PLA5127A2
<b>POWER SUPPLY</b>	DC 3.3 V +/-5% from host equipment
<b>MODULATION TYPE</b>	CCK, DQPSK, DBPSK for DSSS 64QAM, 16QAM, QPSK, BPSK for OFDM
<b>MODULATION TECHNOLOGY</b>	DSSS, OFDM
<b>TRANSFER RATE</b>	802.11b:11/5.5/2/1Mbps 802.11g: 54/48/36/24/18/12/9/6Mbps
<b>FREQUENCY RANGE</b>	802.11b & 802.11g: 2412 ~ 2462MHz
<b>NUMBER OF CHANNEL</b>	11
<b>MAXIMUM OUTPUT POWER</b>	802.11b: 70.8mW 802.11g: 95.5mW
<b>ANTENNA TYPE</b>	Please see note 3 (on next page)
<b>DATA CABLE</b>	NA
<b>I/O PORTS</b>	NA
<b>ASSOCIATED DEVICES</b>	NA

#### NOTE:

1. This report is prepared for FCC class II permissive change. The difference compared with the Report No.: RF960622H01A design is as the following:

u RF shielding cover was modified.

2. The EUT operates in the 2.4GHz frequency spectrum with throughput of up to 54Mbps.

3. There is one antenna provided to this EUT, please refer to the following table:

Brand Name	Model No.	Gain (dBi)	Antenna Type	Connector
Tyco	1513671-1	1.58	Printed Antenna	NA

4. The above EUT information was declared by manufacturer and for more detailed features description, please refer to the manufacturer's specifications or user's manual.



A D T

### 3.2 DESCRIPTION OF TEST MODES

Eleven channels are provided for 802.11b, 802.11g:

CHANNEL	FREQUENCY	CHANNEL	FREQUENCY
1	2412MHz	7	2442MHz
2	2417MHz	8	2447MHz
3	2422MHz	9	2452MHz
4	2427MHz	10	2457MHz
5	2432MHz	11	2462MHz
6	2437MHz		

### 3.2.1 TEST MODE APPLICABILITY AND TESTED CHANNEL DETAIL

EUT CONFIGURE MODE	APPLICABLE TO			DESCRIPTION
	RE < 1G	RE ≥ 1G	APCM	
-	√	√	√	-

Where **RE ≥ 1G**: Radiated Emission above 1GHz      **RE < 1G**: Radiated Emission below 1GHz  
**APCM**: Antenna Port Conducted Measurement

#### **RADIATED EMISSION TEST (BELOW 1 GHz):**

- Pre-Scan has been conducted to determine the worst-case mode from all possible combinations between available modulations, data rates and antenna ports (if EUT with antenna diversity architecture).
- Following channel(s) was (were) selected for the final test as listed below.

MODE	AVAILABLE CHANNEL	TESTED CHANNEL	MODULATION TECHNOLOGY	MODULATION TYPE	DATA RATE (Mbps)
802.11b	1 to 11	11	DSSS	DBPSK	1

#### **RADIATED EMISSION TEST (ABOVE 1 GHz):**

- Pre-Scan has been conducted to determine the worst-case mode from all possible combinations between available modulations, data rates and antenna ports (if EUT with antenna diversity architecture).
- Following channel(s) was (were) selected for the final test as listed below.

MODE	AVAILABLE CHANNEL	TESTED CHANNEL	MODULATION TECHNOLOGY	MODULATION TYPE	DATA RATE (Mbps)
802.11b	1 to 11	1, 6, 11	DSSS	DBPSK	1
802.11g	1 to 11	1, 6, 11	OFDM	BPSK	6





A D T

**ANTENNA PORT CONDUCTED MEASUREMENT:**

- This item includes all test value of each mode, but only includes spectrum plot of worst value of each mode.
- Pre-Scan has been conducted to determine the worst-case mode from all possible combinations between available modulations, data rates and antenna ports (if EUT with antenna diversity architecture).
- Following channel(s) was (were) selected for the final test as listed below.

MODE	AVAILABLE CHANNEL	TESTED CHANNEL	MODULATION TECHNOLOGY	MODULATION TYPE	DATA RATE (Mbps)
802.11b	1 to 11	1, 6, 11	DSSS	DBPSK	1
802.11g	1 to 11	1, 6, 11	OFDM	BPSK	6

**TEST CONDITION:**

APPLICABLE TO	ENVIRONMENTAL CONDITIONS	INPUT POWER (SYSTEM)	TESTED BY
RE <sup>3</sup> 1G	25deg. C, 66%RH, 1013 hPa	120Vac, 60Hz	Frank Liu
RE<1G	25deg. C, 66%RH, 1013 hPa	120Vac, 60Hz	Frank Liu
APCM	25deg. C, 60%RH, 1013 hPa	120Vac, 60Hz	Phoenix Huang

### 3.3 GENERAL DESCRIPTION OF APPLIED STANDARDS

The EUT is a RF product. According to the specifications of the manufacturer, it must comply with the requirements of the following standards:

#### **FCC Part 15, Subpart C. (15.247)**

#### **ANSI C63.4-2003**

All test items have been performed and recorded as per the above standards.

**NOTE:** The EUT has been verified to comply with the requirements of FCC Part 15, Subpart B, Class B (DoC). The test report has been issued separately.

### 3.4 DESCRIPTION OF SUPPORT UNITS

The EUT has been tested as an independent unit together with other necessary accessories or support units. The following support units or accessories were used to form a representative test configuration during the tests.

NO.	PRODUCT	BRAND	MODEL NO.	SERIAL NO.	FCC ID
1	NOTEBOOK COMPUTER	IBM	2372	9949APL	FCC DoC
2	PCMCIA Ext Card	USI	NA	NA	NA
3	CF to PCMCIA Card	USI	NA	NA	NA

NO.	SIGNAL CABLE DESCRIPTION OF THE ABOVE SUPPORT UNITS
1	NA
2	NA
3	NA

**NOTE:** 1. All power cords of the above support units are non shielded (1.8m).

### 3.5 CONFIGURATION OF SYSTEM UNDER TEST

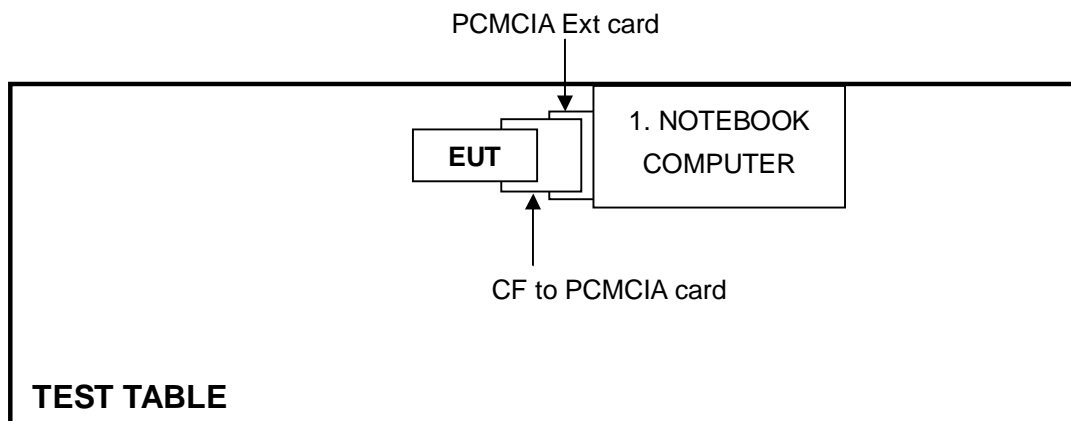

## 4. TEST TYPES AND RESULTS

### 4.1 RADIATED EMISSION MEASUREMENT

#### 4.1.1 LIMITS OF RADIATED EMISSION MEASUREMENT

Emissions radiated outside of the specified bands, shall be according to the general radiated limits in 15.209 as following:

Frequencies (MHz)	Field strength (microvolts/meter)	Measurement distance (meters)
0.009-0.490	2400/F(kHz)	300
0.490-1.705	24000/F(kHz)	30
1.705-30.0	30	30
30-88	100	3
88-216	150	3
216-960	200	3
Above 960	500	3

**NOTE:**

1. The lower limit shall apply at the transition frequencies.
2. Emission level (dBuV/m) = 20 log Emission level (uV/m).
3. As shown in 15.35(b), for frequencies above 1000MHz, the field strength limits are based on average detector, however, the peak field strength of any emission shall not exceed the maximum permitted average limits, specified above by more than 20dB under any condition of modulation.



A D T

#### 4.1.2 TEST INSTRUMENTS

DESCRIPTION & MANUFACTURER	MODEL NO.	SERIAL NO.	CALIBRATED DATE	CALIBRATED UNTIL
ROHDE & SCHWARZ Spectrum Analyzer	FSP40	100036	Dec. 18, 2009	Dec. 17, 2010
Agilent PSA Spectrum Analyzer	E4446A	MY46180622	May 12 , 2010	May 11 , 2011
HP Pre_Amplifier	8449B	300801923	Nov. 02, 2009	Nov. 01, 2010
ROHDE & SCHWARZ Test Receiver	ESCS30	847124/029	Aug. 28, 2009	Aug. 27, 2010
SCHWARZBECK TRILOG Broadband Antenna	VULB 9168	138	Apr. 28, 2010	Apr. 27, 2011
Schwarzbeck Horn_Antenna	BBHA9120	D124	Dec. 18, 2009	Dec. 17, 2010
Schwarzbeck Horn_Antenna	BBHA 9170	BBHA9170153	Jan. 22, 2010	Jan. 21, 2011
RF Switches	EMH-011	1001	NA	NA
RF CABLE (Chaintek)	Sucoflex 106	28077	Aug. 14, 2009	Aug. 13, 2010
RF Cable	8DFB	STCCAB-30M-1GHz	NA	NA
Software	ADT_Radiated_V7.6.15.9.2	NA	NA	NA
CT Antenna Tower & Turn Table	NA	NA	NA	NA

- Note: 1. The calibration interval of the above test instruments is 12 months and the calibrations are traceable to NML/ROC and NIST/USA.  
2. The horn antenna, preamplifier (model: 8449B) and Spectrum Analyzer (model: FSP40) are used only for the measurement of emission frequency above 1GHz if tested.  
3. The test was performed in Open Site No. C.  
4. The FCC Site Registration No. is 656396.  
5. The VCCI Site Registration No. is R-1626.  
6. The CANADA Site Registration No. is IC 7450G-3.



A D T

#### 4.1.3 TEST PROCEDURES

- a. The EUT was placed on the top of a rotating table 0.8 meters above the ground at a 10 meter open area test site. The table was rotated 360 degrees to determine the position of the highest radiation.
- b. The EUT was set 3 meters away from the interference-receiving antenna, which was mounted on the top of a variable-height antenna tower.
- c. The antenna is a broadband antenna, and its height is varied from one meter to four meters above the ground to determine the maximum value of the field strength. Both horizontal and vertical polarizations of the antenna are set to make the measurement.
- d. For each suspected emission, the EUT was arranged to its worst case and then the antenna was tuned to heights from 1 meter to 4 meters and the rotatable table was turned from 0 degrees to 360 degrees to find the maximum reading.
- e. The test-receiver system was set to Peak Detect Function and Specified Bandwidth with Maximum Hold Mode.
- f. If the emission level of the EUT in peak mode was 10dB lower than the limit specified, then testing could be stopped and the peak values of the EUT would be reported. Otherwise the emissions that did not have 10dB margin would be re-tested one by one using peak, quasi-peak or average method as specified and then reported in a data sheet.

**NOTE:**

1. The resolution bandwidth and video bandwidth of test receiver/spectrum analyzer is 120kHz for Peak detection (PK) and Quasi-peak detection (QP) at frequency below 1GHz.
2. The resolution bandwidth of test receiver/spectrum analyzer is 1 MHz and the video bandwidth is 3 MHz for Peak detection (PK) at frequency above 1GHz.
3. The resolution bandwidth of test receiver/spectrum analyzer is 1 MHz and the video bandwidth is 10 Hz for Average detection (AV) at frequency above 1GHz.

#### 4.1.4 DEVIATION FROM TEST STANDARD

No deviation

#### 4.1.5 TEST SETUP

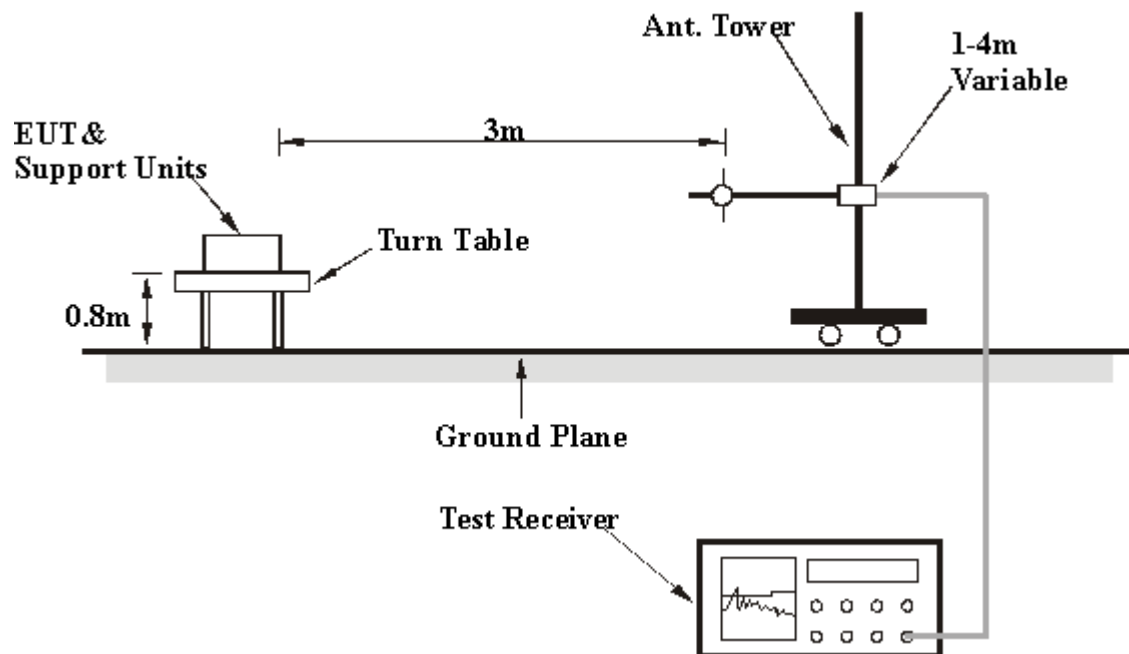

For the actual test configuration, please refer to the related item – Photographs of the Test Configuration.

#### 4.1.6 EUT OPERATING CONDITIONS

- a. Connected the EUT with the support unit 1 (Notebook computer) and placed it on the testing table.
- b. The support unit 1 (Notebook computer) ran a test program “CTxRx3.0.1.1” to enable EUT under transmission condition continuously.



#### 4.1.7 TEST RESULTS

#### BELOW 1GHz WORST-CASE DATA : 802.11b DSSS MODULATION

EUT TEST CONDITION		MEASUREMENT DETAIL	
CHANNEL	Channel 1	FREQUENCY RANGE	Below 1000MHz
INPUT POWER (SYSTEM)	120Vac, 60 Hz	DETECTOR FUNCTION	Quasi-Peak
ENVIRONMENTAL CONDITIONS	25deg. C, 66%RH 1013 hPa	TESTED BY	Frank Liu

ANTENNA POLARITY & TEST DISTANCE: HORIZONTAL AT 3 M								
NO.	FREQ. (MHz)	EMISSION LEVEL (dBuV/m)	LIMIT (dBuV/m)	MARGIN (dB)	ANTENNA HEIGHT (m)	TABLE ANGLE (Degree)	RAW VALUE (dBuV)	CORRECTION FACTOR (dB/m)
1	132.90	30.4 QP	43.50	-13.1	1.37 H	148	16.45	13.91
2	199.13	31.9 QP	43.50	-11.6	1.02 H	282	20.89	10.98
3	236.17	32.1 QP	46.00	-13.9	1.34 H	122	19.23	12.85
4	324.83	34.7 QP	46.00	-11.3	1.05 H	233	18.40	16.28
5	398.67	32.7 QP	46.00	-13.3	1.00 H	69	14.54	18.15
6	778.93	35.9 QP	46.00	-10.1	1.00 H	133	10.52	25.38

ANTENNA POLARITY & TEST DISTANCE: VERTICAL AT 3 M								
NO.	FREQ. (MHz)	EMISSION LEVEL (dBuV/m)	LIMIT (dBuV/m)	MARGIN (dB)	ANTENNA HEIGHT (m)	TABLE ANGLE (Degree)	RAW VALUE (dBuV)	CORRECTION FACTOR (dB/m)
1	60.00	29.2 QP	40.00	-10.8	1.00 V	342	15.63	13.55
2	132.90	25.7 QP	43.50	-17.8	1.00 V	249	11.76	13.91
3	222.33	28.5 QP	46.00	-17.5	1.00 V	143	16.42	12.12
4	278.17	25.6 QP	46.00	-20.4	1.00 V	359	10.87	14.75
5	333.75	36.3 QP	46.00	-9.7	1.00 V	211	19.83	16.50
6	445.17	30.4 QP	46.00	-15.6	1.00 V	89	11.11	19.31

- REMARKS:**
1. Emission level (dBuV/m) = Raw Value (dBuV) + Correction Factor (dB/m).
  2. Correction Factor (dB/m) = Antenna Factor (dB/m) + Cable Factor (dB).
  3. The other emission levels were very low against the limit.
  4. Margin value = Emission level – Limit value.





A D T

## ABOVE 1GHz WORST-CASE DATA

### 802.11b DSSS MODULATION

EUT TEST CONDITION		MEASUREMENT DETAIL	
CHANNEL	Channel 1	FREQUENCY RANGE	1 ~ 25GHz
INPUT POWER (SYSTEM)	120Vac, 60 Hz	DETECTOR FUNCTION	Peak (PK) Average (AV)
ENVIRONMENTAL CONDITIONS	25deg. C, 66%RH 1013 hPa	TESTED BY	Frank Liu

ANTENNA POLARITY & TEST DISTANCE: HORIZONTAL AT 3 M								
NO.	FREQ. (MHz)	EMISSION LEVEL (dBuV/m)	LIMIT (dBuV/m)	MARGIN (dB)	ANTENNA HEIGHT (m)	TABLE ANGLE (Degree)	RAW VALUE (dBuV)	CORRECTION FACTOR (dB/m)
1	2386.27	60.9 PK	74.00	-13.1	1.47 H	193	30.85	30.05
2	2386.27	51.5 AV	54.00	-2.5	1.47 H	193	21.45	30.05
3	*2412.00	102.4 PK			1.47 H	190	72.25	30.15
4	*2412.00	100.3 AV			1.47 H	190	70.15	30.15
5	4824.00	47.1 PK	74.00	-26.9	1.92 H	118	11.67	35.43
6	4824.00	41.0 AV	54.00	-13.0	1.92 H	118	5.57	35.43
ANTENNA POLARITY & TEST DISTANCE: VERTICAL AT 3 M								
NO.	FREQ. (MHz)	EMISSION LEVEL (dBuV/m)	LIMIT (dBuV/m)	MARGIN (dB)	ANTENNA HEIGHT (m)	TABLE ANGLE (Degree)	RAW VALUE (dBuV)	CORRECTION FACTOR (dB/m)
1	2386.13	59.8 PK	74.00	-14.2	1.45 V	174	29.75	30.05
2	2386.13	51.5 AV	54.00	-2.5	1.45 V	174	21.45	30.05
3	*2412.00	101.0 PK			1.46 V	173	70.85	30.15
4	*2412.00	99.2 AV			1.46 V	173	69.05	30.15
5	4824.00	46.7 PK	74.00	-27.3	1.36 V	173	11.27	35.43
6	4824.00	38.1 AV	54.00	-15.9	1.36 V	173	2.67	35.43

- REMARKS:**
1. Emission level (dBuV/m) = Raw Value (dBuV) + Correction Factor (dB/m).
  2. Correction Factor (dB/m) = Antenna Factor (dB/m) + Cable Factor (dB).
  3. The other emission levels were very low against the limit.
  4. Margin value = Emission level – Limit value.
  5. “ \* ”: Fundamental frequency.



A D T

EUT TEST CONDITION		MEASUREMENT DETAIL	
CHANNEL	Channel 6	FREQUENCY RANGE	1 ~ 25GHz
INPUT POWER (SYSTEM)	120Vac, 60 Hz	DETECTOR FUNCTION	Peak (PK) Average (AV)
ENVIRONMENTAL CONDITIONS	25deg. C, 66%RH 1013 hPa	TESTED BY	Frank Liu

ANTENNA POLARITY & TEST DISTANCE: HORIZONTAL AT 3 M								
NO.	FREQ. (MHz)	EMISSION LEVEL (dBuV/m)	LIMIT (dBuV/m)	MARGIN (dB)	ANTENNA HEIGHT (m)	TABLE ANGLE (Degree)	RAW VALUE (dBuV)	CORRECTION FACTOR (dB/m)
1	*2437.00	104.6 PK			1.46 H	191	74.36	30.24
2	*2437.00	102.4 AV			1.46 H	191	72.16	30.24
3	4874.00	46.4 PK	74.00	-27.6	1.84 H	118	10.88	35.52
4	4874.00	39.8 AV	54.00	-14.2	1.84 H	118	4.28	35.52
5	7311.00	49.3 PK	74.00	-24.7	1.18 H	24	7.34	41.96
6	7311.00	36.6 AV	54.00	-17.4	1.18 H	24	-5.36	41.96
ANTENNA POLARITY & TEST DISTANCE: VERTICAL AT 3 M								
NO.	FREQ. (MHz)	EMISSION LEVEL (dBuV/m)	LIMIT (dBuV/m)	MARGIN (dB)	ANTENNA HEIGHT (m)	TABLE ANGLE (Degree)	RAW VALUE (dBuV)	CORRECTION FACTOR (dB/m)
1	*2437.00	102.7 PK			1.42 V	165	72.46	30.24
2	*2437.00	100.5 AV			1.42 V	165	70.26	30.24
3	4874.00	45.6 PK	74.00	-28.4	1.37 V	188	10.08	35.52
4	4874.00	38.3 AV	54.00	-15.7	1.37 V	188	2.78	35.52
5	7311.00	49.5 PK	74.00	-24.5	1.21 V	0	7.54	41.96
6	7311.00	36.7 AV	54.00	-17.3	1.21 V	0	-5.26	41.96

- REMARKS:**
1. Emission level (dBuV/m) = Raw Value (dBuV) + Correction Factor (dB/m).
  2. Correction Factor (dB/m) = Antenna Factor (dB/m) + Cable Factor (dB).
  3. The other emission levels were very low against the limit.
  4. Margin value = Emission level – Limit value.
  5. “ \* “: Fundamental frequency.



A D T

EUT TEST CONDITION		MEASUREMENT DETAIL	
CHANNEL	Channel 11	FREQUENCY RANGE	1 ~ 25GHz
INPUT POWER (SYSTEM)	120Vac, 60 Hz	DETECTOR FUNCTION	Peak (PK) Average (AV)
ENVIRONMENTAL CONDITIONS	25deg. C, 66%RH 1013 hPa	TESTED BY	Frank Liu

ANTENNA POLARITY & TEST DISTANCE: HORIZONTAL AT 3 M								
NO.	FREQ. (MHz)	EMISSION LEVEL (dBuV/m)	LIMIT (dBuV/m)	MARGIN (dB)	ANTENNA HEIGHT (m)	TABLE ANGLE (Degree)	RAW VALUE (dBuV)	CORRECTION FACTOR (dB/m)
1	*2462.00	98.8 PK			1.31 H	105	67.52	31.28
2	*2462.00	96.7 AV			1.31 H	105	65.42	31.28
3	2487.73	57.6 PK	74.00	-16.4	1.32 H	106	26.21	31.39
4	2487.73	47.5 AV	54.00	-6.5	1.32 H	106	16.11	31.39
5	4924.00	45.5 PK	74.00	-28.5	1.94 H	118	9.88	35.62
6	4924.00	36.2 AV	54.00	-17.8	1.94 H	118	0.58	35.62
7	7386.00	49.8 PK	74.00	-24.2	1.34 H	26	7.70	42.10
8	7386.00	36.6 AV	54.00	-17.4	1.34 H	26	-5.50	42.10
ANTENNA POLARITY & TEST DISTANCE: VERTICAL AT 3 M								
NO.	FREQ. (MHz)	EMISSION LEVEL (dBuV/m)	LIMIT (dBuV/m)	MARGIN (dB)	ANTENNA HEIGHT (m)	TABLE ANGLE (Degree)	RAW VALUE (dBuV)	CORRECTION FACTOR (dB/m)
1	*2462.00	98.0 PK			1.00 V	112	66.72	31.28
2	*2462.00	95.0 AV			1.00 V	112	63.72	31.28
3	2487.84	56.5 PK	74.00	-17.5	1.00 V	112	25.11	31.39
4	2487.84	45.6 AV	54.00	-8.4	1.00 V	112	14.21	31.39
5	4924.00	44.7 PK	74.00	-29.3	1.33 V	200	9.08	35.62
6	4924.00	35.1 AV	54.00	-18.9	1.33 V	200	-0.52	35.62
7	7386.00	49.7 PK	74.00	-24.3	1.20 V	241	7.60	42.10
8	7386.00	36.5 AV	54.00	-17.5	1.20 V	241	-5.60	42.10

- REMARKS:**
1. Emission level (dBuV/m) = Raw Value (dBuV) + Correction Factor (dB/m).
  2. Correction Factor (dB/m) = Antenna Factor (dB/m) + Cable Factor (dB).
  3. The other emission levels were very low against the limit.
  4. Margin value = Emission level – Limit value.
  5. “ \* “: Fundamental frequency.



A D T

RESTRICTED BANDEDGE (802.11b MODE, CH1, HORIZONTAL )

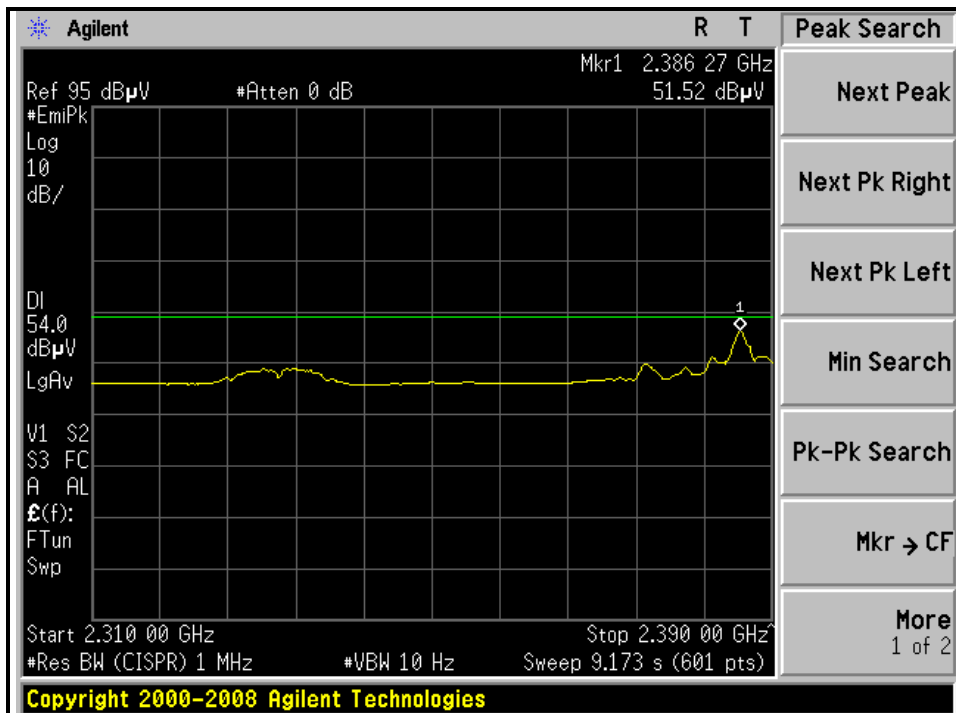
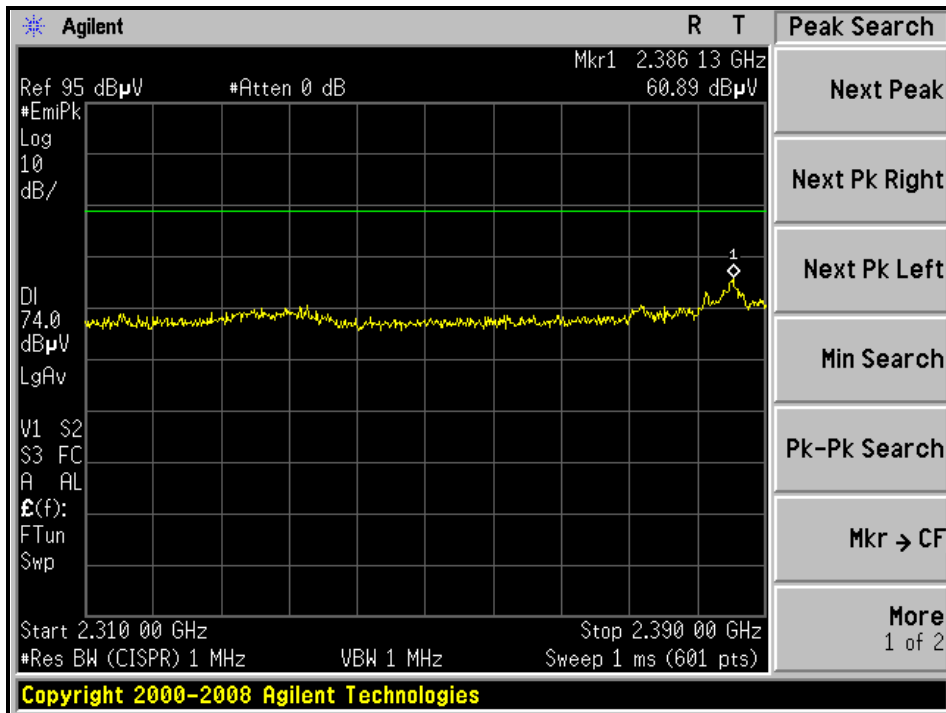



A D T

RESTRICTED BANDEDGE (802.11b MODE, CH1, VERTICAL )

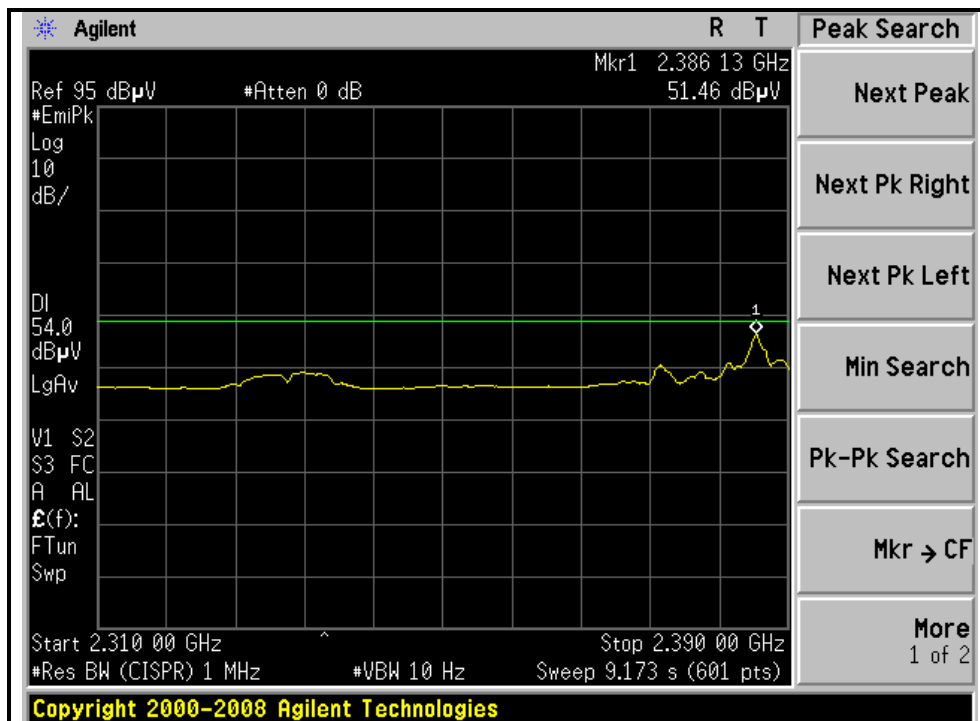
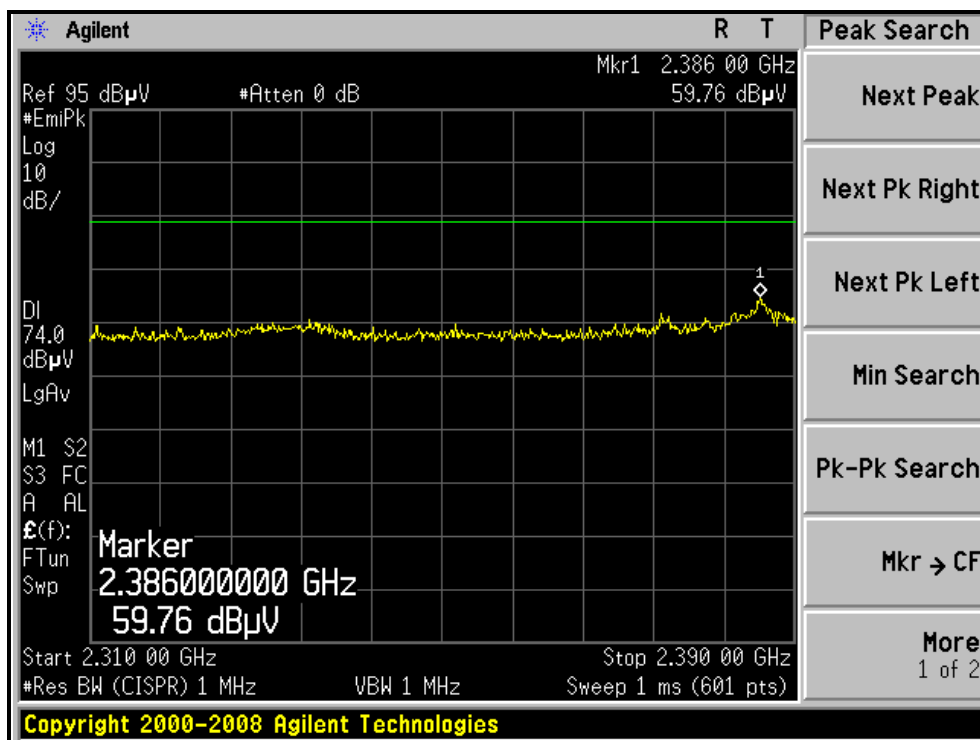



A D T

RESTRICTED BANDEDGE (802.11b MODE, CH11, HORIZONTAL )

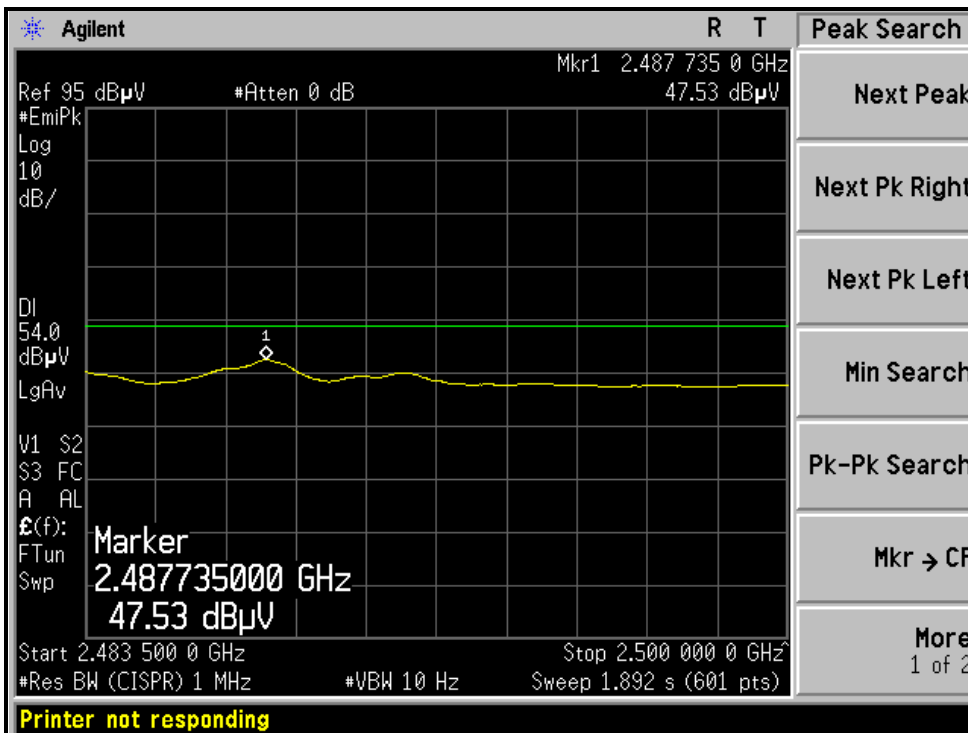
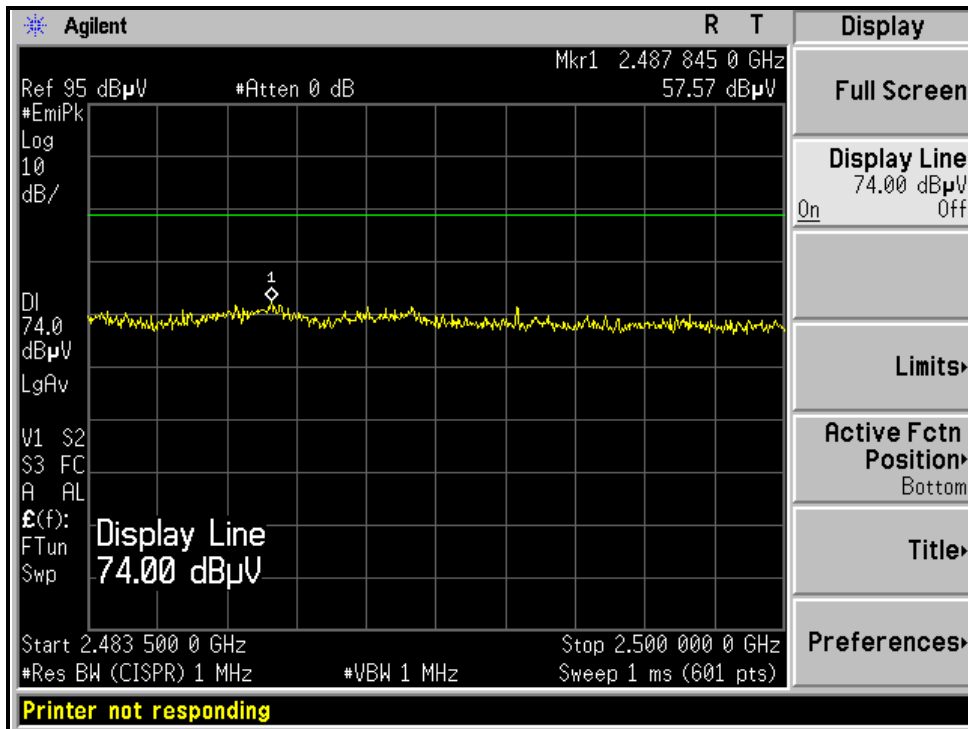



A D T

### RESTRICTED BANDEDGE (802.11b MODE, CH11, VERTICAL)

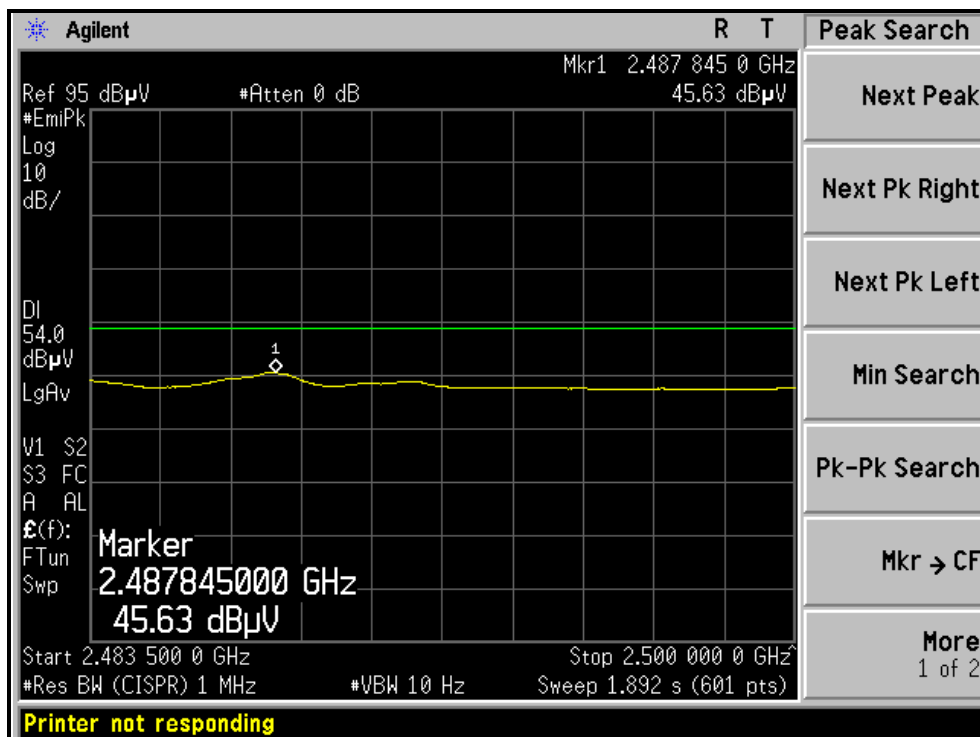
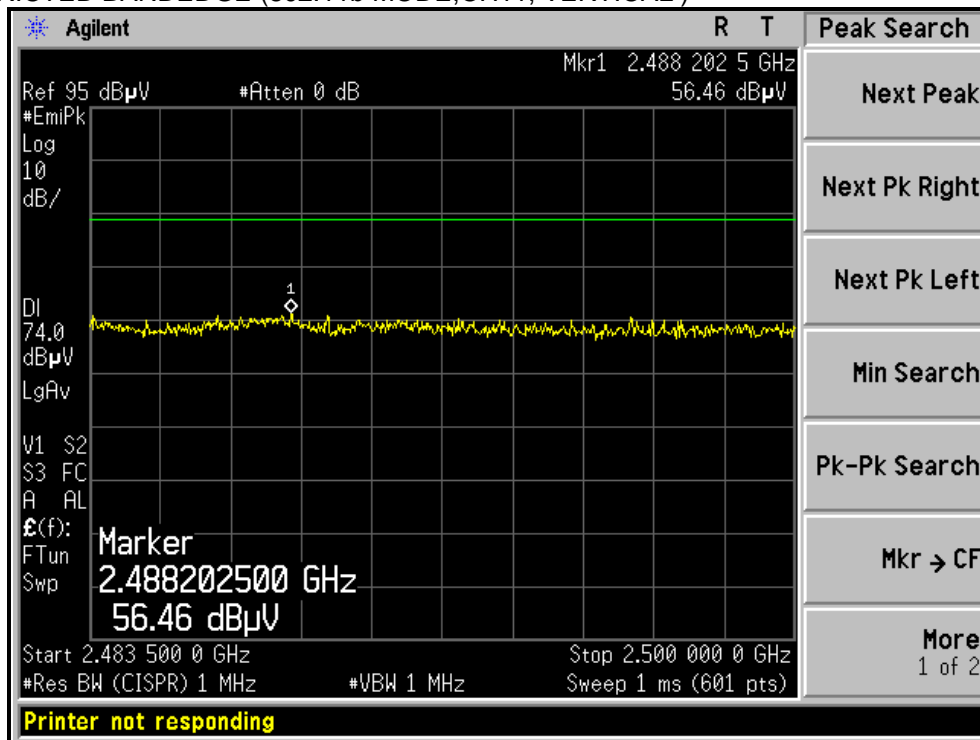



A D T

## 802.11g OFDM MODULATION

EUT TEST CONDITION		MEASUREMENT DETAIL	
CHANNEL	Channel 1	FREQUENCY RANGE	1 ~ 25GHz
INPUT POWER (SYSTEM)	120Vac, 60 Hz	DETECTOR FUNCTION	Peak (PK) Average (AV)
ENVIRONMENTAL CONDITIONS	25deg. C, 66%RH 1013 hPa	TESTED BY	Frank Liu

ANTENNA POLARITY & TEST DISTANCE: HORIZONTAL AT 3 M								
NO.	FREQ. (MHz)	EMISSION LEVEL (dBuV/m)	LIMIT (dBuV/m)	MARGIN (dB)	ANTENNA HEIGHT (m)	TABLE ANGLE (Degree)	RAW VALUE (dBuV)	CORRECTION FACTOR (dB/m)
1	2390.00	67.4 PK	74.00	-6.6	1.48 H	195	37.34	30.06
2	<b>2390.00</b>	<b>52.7 AV</b>	<b>54.00</b>	<b>-1.3</b>	<b>1.48 H</b>	<b>195</b>	<b>22.64</b>	<b>30.06</b>
3	*2412.00	104.1 PK			1.47 H	191	73.95	30.15
4	*2412.00	94.8 AV			1.47 H	191	64.65	30.15
5	4824.00	42.1 PK	74.00	-31.9	1.91 H	18	6.67	35.43
6	4824.00	30.1 AV	54.00	-23.9	1.91 H	18	-5.33	35.43
ANTENNA POLARITY & TEST DISTANCE: VERTICAL AT 3 M								
NO.	FREQ. (MHz)	EMISSION LEVEL (dBuV/m)	LIMIT (dBuV/m)	MARGIN (dB)	ANTENNA HEIGHT (m)	TABLE ANGLE (Degree)	RAW VALUE (dBuV)	CORRECTION FACTOR (dB/m)
1	2390.00	68.0 PK	74.00	-6.0	1.18 V	165	37.94	30.06
2	<b>2390.00</b>	<b>52.7 AV</b>	<b>54.00</b>	<b>-1.3</b>	<b>1.18 V</b>	<b>165</b>	<b>22.64</b>	<b>30.06</b>
3	*2412.00	103.0 PK			1.18 V	165	72.85	30.15
4	*2412.00	94.0 AV			1.18 V	165	63.85	30.15
5	4824.00	41.2 PK	74.00	-32.8	1.10 V	190	5.77	35.43
6	4824.00	29.6 AV	54.00	-24.4	1.10 V	190	-5.83	35.43

- REMARKS:**
1. Emission level (dBuV/m) = Raw Value (dBuV) + Correction Factor (dB/m).
  2. Correction Factor (dB/m) = Antenna Factor (dB/m) + Cable Factor (dB).
  3. The other emission levels were very low against the limit.
  4. Margin value = Emission level – Limit value.
  5. “ \* “: Fundamental frequency.





A D T

EUT TEST CONDITION		MEASUREMENT DETAIL	
CHANNEL	Channel 6	FREQUENCY RANGE	1 ~ 25GHz
INPUT POWER (SYSTEM)	120Vac, 60 Hz	DETECTOR FUNCTION	Peak (PK) Average (AV)
ENVIRONMENTAL CONDITIONS	25deg. C, 66%RH 1013 hPa	TESTED BY	Frank Liu

ANTENNA POLARITY & TEST DISTANCE: HORIZONTAL AT 3 M								
NO.	FREQ. (MHz)	EMISSION LEVEL (dBuV/m)	LIMIT (dBuV/m)	MARGIN (dB)	ANTENNA HEIGHT (m)	TABLE ANGLE (Degree)	RAW VALUE (dBuV)	CORRECTION FACTOR (dB/m)
1	*2437.00	107.4 PK			1.47 H	192	77.16	30.24
2	*2437.00	98.2 AV			1.47 H	192	67.96	30.24
3	4874.00	43.6 PK	74.00	-30.4	1.92 H	20	8.08	35.52
4	4874.00	31.4 AV	54.00	-22.6	1.92 H	20	-4.12	35.52
5	7311.00	49.2 PK	74.00	-24.8	1.00 H	20	7.24	41.96
6	7311.00	36.6 AV	54.00	-17.4	1.00 H	20	-5.36	41.96
ANTENNA POLARITY & TEST DISTANCE: VERTICAL AT 3 M								
NO.	FREQ. (MHz)	EMISSION LEVEL (dBuV/m)	LIMIT (dBuV/m)	MARGIN (dB)	ANTENNA HEIGHT (m)	TABLE ANGLE (Degree)	RAW VALUE (dBuV)	CORRECTION FACTOR (dB/m)
1	*2437.00	106.5 PK			1.12 V	166	76.26	30.24
2	*2437.00	97.2 AV			1.12 V	166	66.96	30.24
3	4874.00	42.1 PK	74.00	-31.9	1.10 V	195	6.58	35.52
4	4874.00	30.0 AV	54.00	-24.0	1.10 V	195	-5.52	35.52
5	7311.00	49.1 PK	74.00	-24.9	1.20 V	280	7.14	41.96
6	7311.00	36.5 AV	54.00	-17.5	1.20 V	280	-5.46	41.96

- REMARKS:**
1. Emission level (dBuV/m) = Raw Value (dBuV) + Correction Factor (dB/m).
  2. Correction Factor (dB/m) = Antenna Factor (dB/m) + Cable Factor (dB).
  3. The other emission levels were very low against the limit.
  4. Margin value = Emission level – Limit value.
  5. “ \* “: Fundamental frequency.



A D T

EUT TEST CONDITION		MEASUREMENT DETAIL	
CHANNEL	Channel 11	FREQUENCY RANGE	1 ~ 25GHz
INPUT POWER (SYSTEM)	120Vac, 60 Hz	DETECTOR FUNCTION	Peak (PK) Average (AV)
ENVIRONMENTAL CONDITIONS	25deg. C, 66%RH 1013 hPa	TESTED BY	Frank Liu

ANTENNA POLARITY & TEST DISTANCE: HORIZONTAL AT 3 M								
NO.	FREQ. (MHz)	EMISSION LEVEL (dBuV/m)	LIMIT (dBuV/m)	MARGIN (dB)	ANTENNA HEIGHT (m)	TABLE ANGLE (Degree)	RAW VALUE (dBuV)	CORRECTION FACTOR (dB/m)
1	*2462.00	98.9 PK			1.32 H	105	67.62	31.28
2	*2462.00	90.8 AV			1.32 H	105	59.52	31.28
3	2483.50	64.1 PK	74.00	-9.9	1.32 H	105	32.73	31.37
4	2483.50	49.8 AV	54.00	-4.2	1.32 H	105	18.43	31.37
5	4924.00	42.5 PK	74.00	-31.5	1.92 H	22	6.88	35.62
6	4924.00	30.2 AV	54.00	-23.8	1.92 H	22	-5.42	35.62
7	7386.00	49.6 PK	74.00	-24.4	1.00 H	21	7.50	42.10
8	7386.00	36.7 AV	54.00	-17.3	1.00 H	21	-5.40	42.10
ANTENNA POLARITY & TEST DISTANCE: VERTICAL AT 3 M								
NO.	FREQ. (MHz)	EMISSION LEVEL (dBuV/m)	LIMIT (dBuV/m)	MARGIN (dB)	ANTENNA HEIGHT (m)	TABLE ANGLE (Degree)	RAW VALUE (dBuV)	CORRECTION FACTOR (dB/m)
1	*2462.00	98.4 PK			1.02 V	112	67.12	31.28
2	*2462.00	90.0 AV			1.02 V	112	58.72	31.28
3	2483.50	61.3 PK	74.00	-12.7	1.02 V	112	29.93	31.37
4	2483.50	47.5 AV	54.00	-6.5	1.02 V	112	16.13	31.37
5	4924.00	41.3 PK	74.00	-32.7	1.11 V	193	5.68	35.62
6	4924.00	29.8 AV	54.00	-24.2	1.11 V	193	-5.82	35.62
7	7386.00	49.3 PK	74.00	-24.7	1.20 V	282	7.20	42.10
8	7386.00	36.6 AV	54.00	-17.4	1.20 V	282	-5.50	42.10

- REMARKS:**
1. Emission level (dBuV/m) = Raw Value (dBuV) + Correction Factor (dB/m).
  2. Correction Factor (dB/m) = Antenna Factor (dB/m) + Cable Factor (dB).
  3. The other emission levels were very low against the limit.
  4. Margin value = Emission level – Limit value.
  5. “ \* “: Fundamental frequency.



A D T

RESTRICTED BANDEDGE (802.11g MODE, CH1, HORIZONTAL )

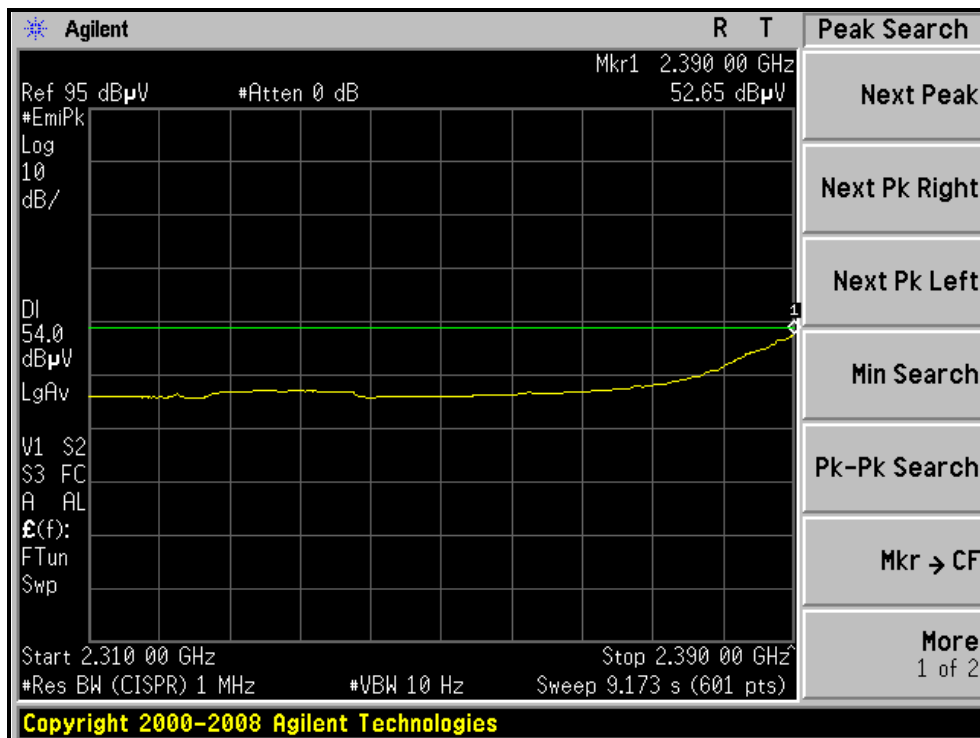
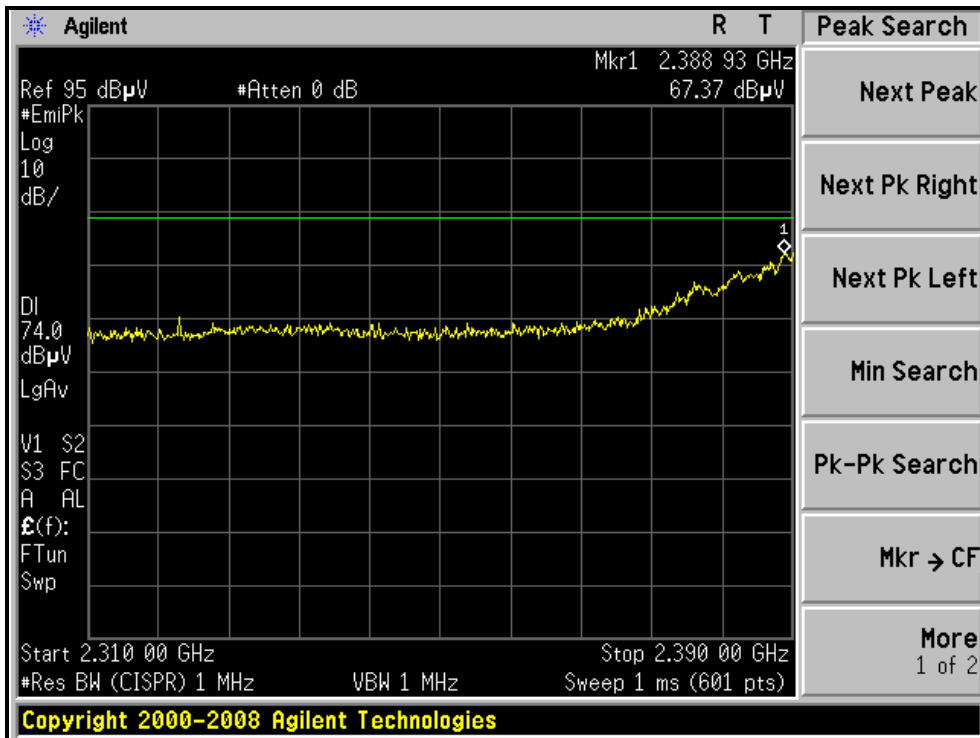



A D T

### RESTRICTED BANDEDGE (802.11g MODE, CH1, VERTICAL )

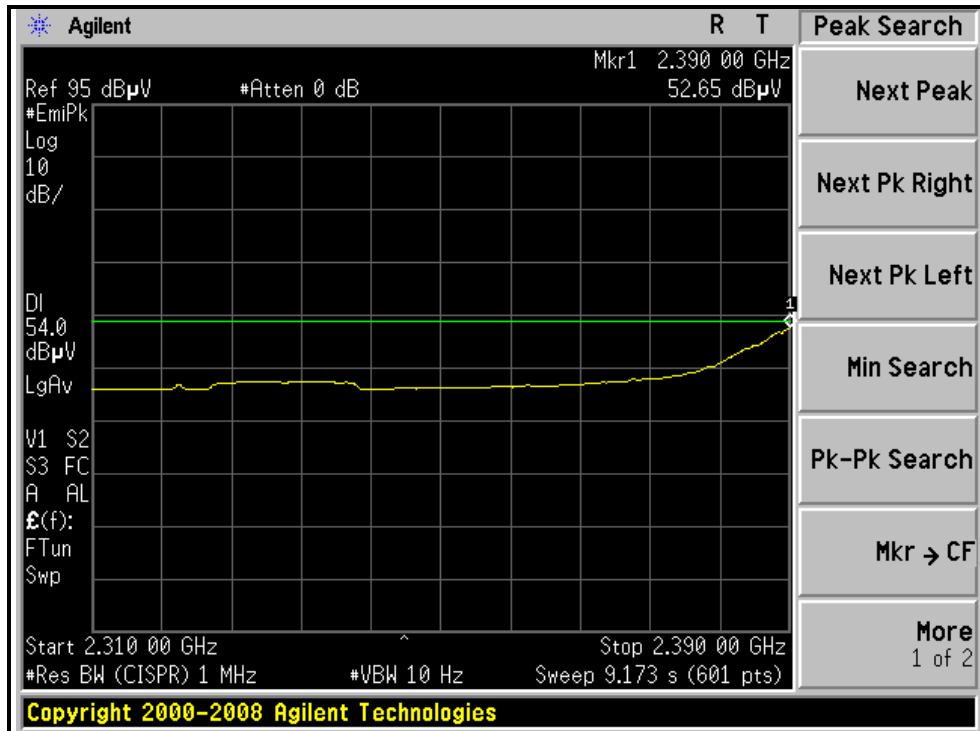
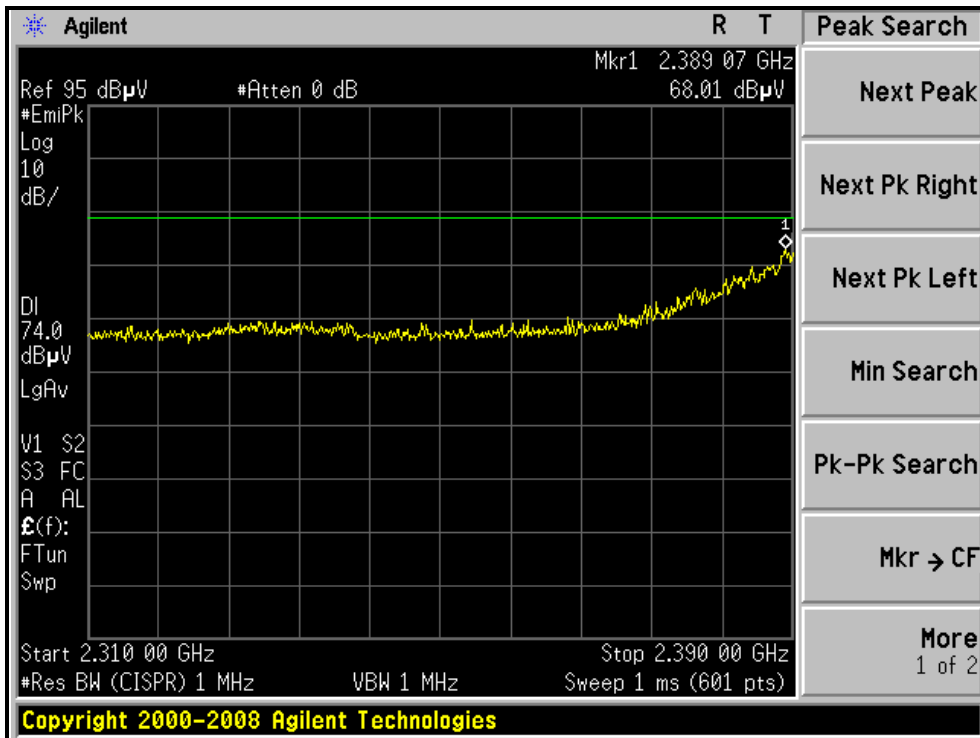



A D T

RESTRICTED BANDEDGE (802.11g MODE, CH11, HORIZONTAL )

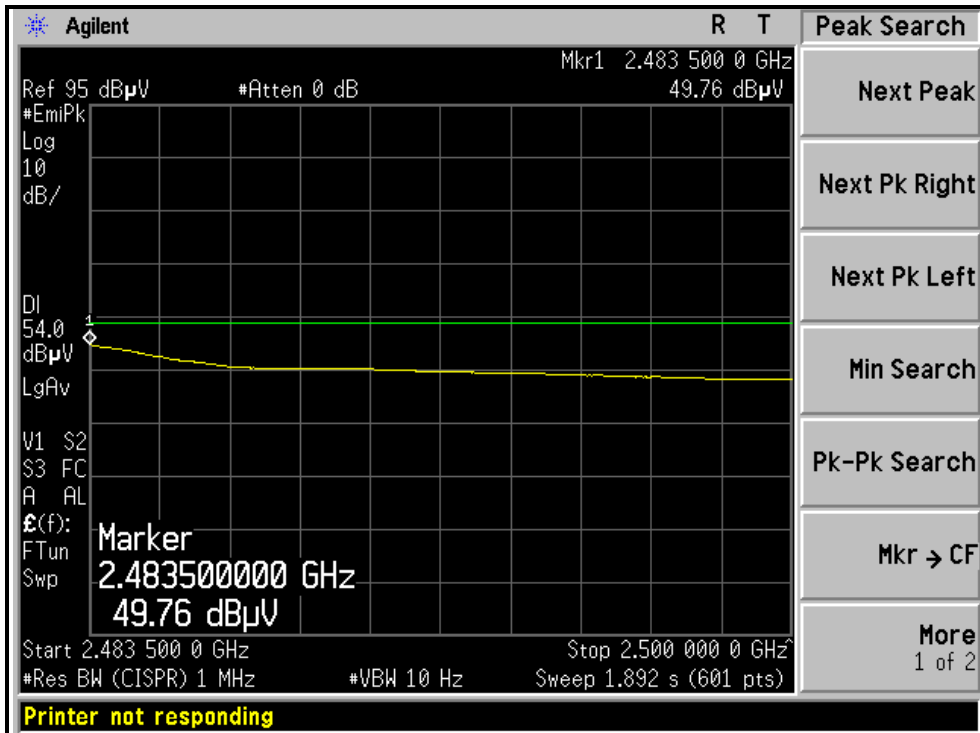
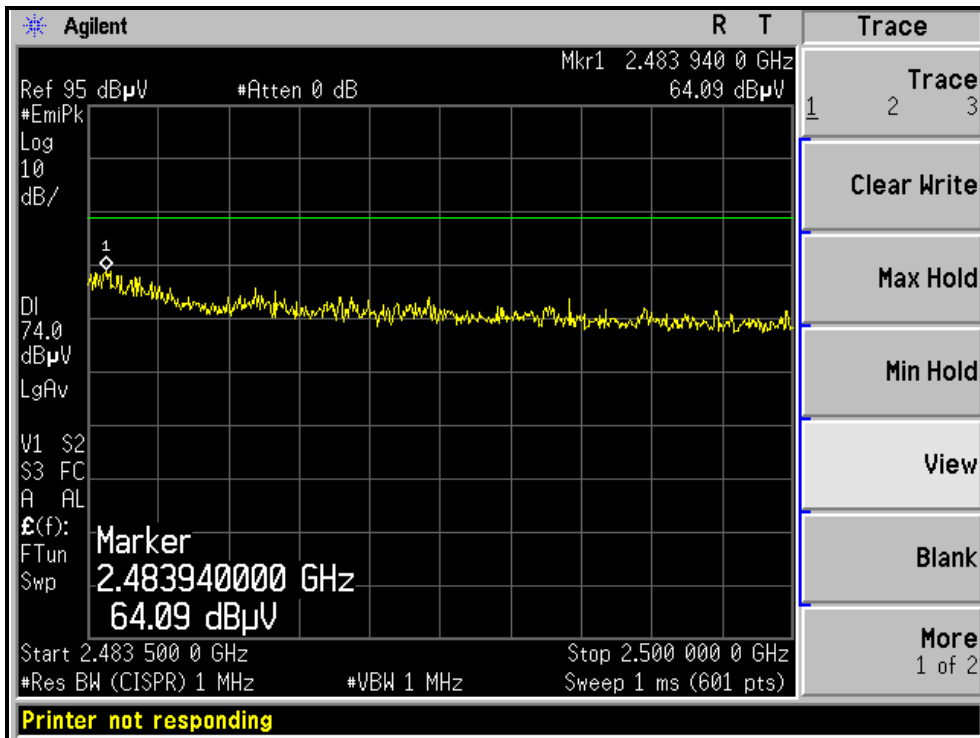



A D T

RESTRICTED BANDEDGE (802.11g MODE,CH11, VERTICAL )

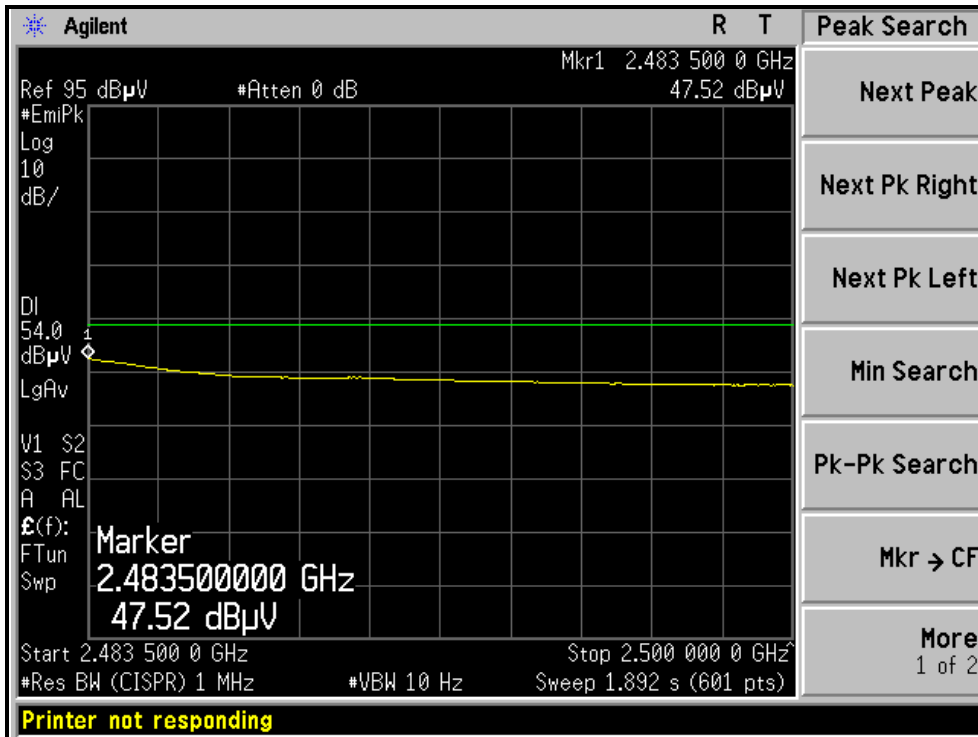
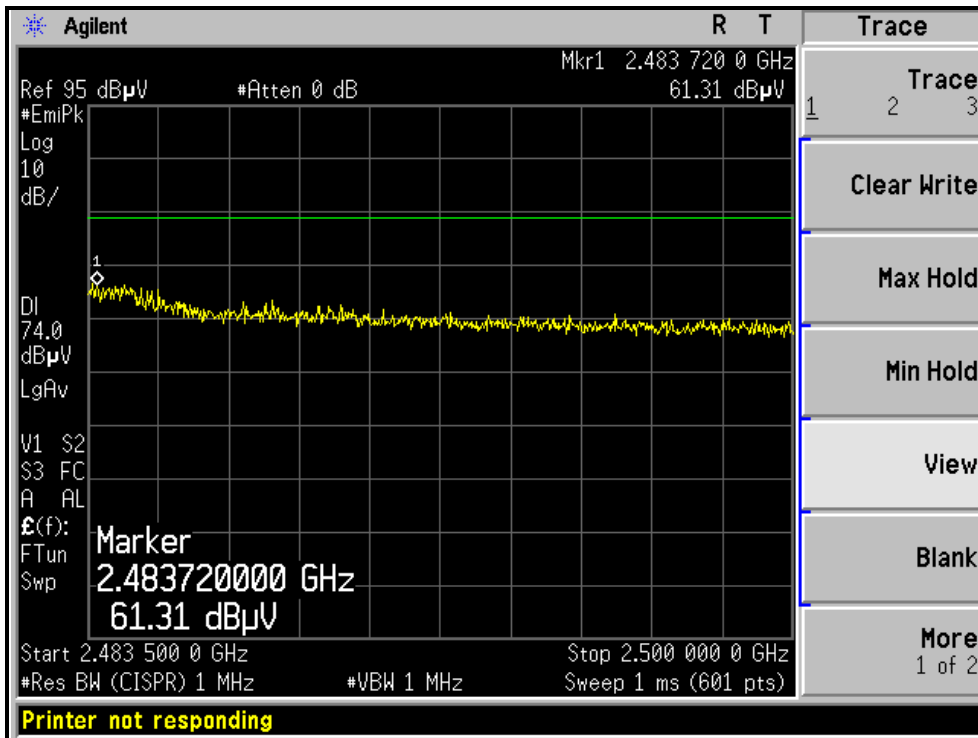



A D T

## 4.2 MAXIMUM PEAK OUTPUT POWER

### 4.2.1 LIMITS OF MAXIMUM PEAK OUTPUT POWER MEASUREMENT

The Maximum Peak Output Power Measurement is 30dBm.

### 4.2.2 INSTRUMENTS

DESCRIPTION & MANUFACTURER	MODEL NO.	SERIAL NO.	CALIBRATED DATE	CALIBRATED UNTIL
R&S SPECTRUM ANALYZER	FSP40	100036	Dec. 18, 2009	Dec. 17, 2010
ESG VECTOR SIGNAL GENERATOR	E4438C	MY4727133 0 506 602 UNJ	Mar. 22, 2010	Mar. 21, 2011
TEKTRONIX OSCILLOSCOPE	TDS380	B016335	July 14, 2010	July 13, 2011
NARDA DETECTOR	4503A	FSCM99899	NA	NA

**NOTE:**

The calibration interval of the above test instruments is 12 months and the calibrations are traceable to NML/ROC and NIST/USA.

### 4.2.3 TEST PROCEDURES

1. A detector was used on the output port of the EUT. An oscilloscope was used to read the response of the detector.
2. Replaced the EUT by the signal generator. The center frequency of the S.G was adjusted to the center frequency of the measured channel.
3. Adjusted the power to have the same reading on oscilloscope. Record the power level.

### 4.2.4 DEVIATION FROM TEST STANDARD

No deviation

#### 4.2.5 TEST SETUP



#### 4.2.6 EUT OPERATING CONDITIONS

The software provided by client to enable the EUT under transmission condition continuously at lowest, middle and highest channel frequencies individually.





A D T

#### 4.2.7 TEST RESULTS

##### 802.11b DSSS MODULATION:

CHANNEL	CHANNEL FREQUENCY (MHz)	PEAK POWER OUTPUT (dBm)	PEAK POWER OUTPUT (mW)	PEAK POWER LIMIT (dBm)	PASS / FAIL
1	2412	15.5	35.5	30	PASS
6	2437	18.5	70.8	30	PASS
11	2462	17.7	58.9	30	PASS

##### 802.11g OFDM MODULATION:

CHANNEL	CHANNEL FREQUENCY (MHz)	PEAK POWER OUTPUT (dBm)	PEAK POWER OUTPUT (mW)	PEAK POWER LIMIT (dBm)	PASS / FAIL
1	2412	16.3	42.7	30	PASS
6	2437	19.8	95.5	30	PASS
11	2462	15.9	38.9	30	PASS



## 5. INFORMATION ON THE TESTING LABORATORIES

We, Bureau Veritas Consumer Products Services (H.K.) Ltd., Taoyuan Branch, were founded in 1988 to provide our best service in EMC, Radio, Telecom and Safety consultation. Our laboratories are accredited and approved according to ISO/IEC 17025:

Copies of accreditation certificates of our laboratories obtained from approval agencies can be downloaded from our web site: [www.adt.com.tw/index.5/phtml](http://www.adt.com.tw/index.5/phtml). If you have any comments, please feel free to contact us at the following:

**Linko EMC/RF Lab:**  
Tel: 886-2-26052180  
Fax: 886-2-26052943

**Hsin Chu EMC/RF Lab:**  
Tel: 886-3-5935343  
Fax: 886-3-5935342

**Hwa Ya EMC/RF/Safety Telecom Lab:**  
Tel: 886-3-3183232  
Fax: 886-3-3185050

**Web Site:** [www.adt.com.tw](http://www.adt.com.tw)

The address and road map of all our labs can be found in our web site also



A D T

## **6.APPENDIX-A- MODIFICATIONS RECORDERS FOR ENGINEERING CHANGES TO THE EUT BY THE LAB**

No any modifications are made to the EUT by the lab during the test.

**---END---**