

ATTACHMENT K – PART 15.247 MEASUREMENT REPORT

**FCC Part 15.247
Direct Sequence Test Report**

for
Symbol Technologies
on the
WLAN Compact Flash Card
Model: LA-4137
FCC ID: H9PLA4137P

Test Report #: 2046983D1
Date of Report: May 30, 2001

Job #: J2046983D
Date of Test: April 1 to May 24, 2001

Total No of Pages Contained in this Report: 55 + Data Sheets

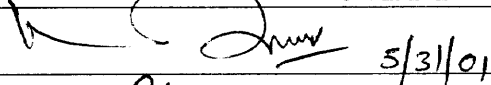
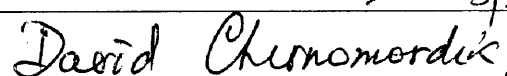

NVLAP Laboratory Code: 200201-0

 5/31/01	Suresh Kondapalli, Test Engineer
 Review Date: 5/31/01	David Chernomordik, Ph.D., EMC Site Manager

All services undertaken are subject to the following general policy: Reports are submitted for exclusive use of the client to whom they are addressed. Their significance is subject to the adequacy and representative character of the samples and to the comprehensiveness of the tests, examinations or surveys made. This report shall not be reproduced except in full, without written consent of Intertek Testing Services, NA Inc. This report must not be used to claim product endorsement by NVLAP, NIST nor any other agency of the U.S. Government.

FCC Part 15 DSSS Cert. Rev 01/01

Intertek Testing Services NA, Inc.
1365 Adams Court, Menlo Park, CA 94025

Telephone 650-463-2900 Fax 650-463-2910 Home Page www.etlsemko.com



Wansuck Horsey



emc



Table of Contents

1.0	Summary of Tests	3
2.0	General Description	4
2.1	Product Description	4
2.2	Related Submittal(s) Grants	4
2.4	Test Facility.....	5
3.0	System Test Configuration	6
3.1	Support Equipment and description	6
3.2	Block Diagram of Test Setup	6
3.3	Justification	7
3.4	Software Exercise Program.....	7
3.5	Mode of Operation During Test	7
3.6	Modifications Required for Compliance	7
4.0	Measurement Results	8
4.1	Conducted Output Power at Antenna Terminals.....	8
4.2	6 dB RF Bandwidth	9
4.3	Power Density	13
4.4	Out-of-Band Conducted Emissions	22
4.5	Out-of-Band Radiated Emissions	45
4.6	Transmitter Radiated Emissions in Restricted Bands	46
4.7	AC Line Conducted Emission.....	50
4.8	Radiated Emissions from Digital Section of Transceiver (Transmitter).....	52
4.9	Radiated Emissions from Receiver Section of Transceiver (L.O. Radiation).....	53
5.0	List of test Equipment	54
6.0	Document History	55

1.0 Summary of Tests

MODEL: Model: LA-4137

FCC ID: H9PLA4137P

TEST	REFERENCE	RESULTS
Output power	15.247(b)	Passed
6 dB Bandwidth	15.247(a)(2)	Passed
Power Density	15.247(d)	Passed
Out-of-band Antenna Conducted Emission	15.247(c)	Passed
Out-of-band Radiated Emission (except emissions in restricted bands)	15.247(c)	Not Applicable. The EUT passed out-of-band antenna conducted emission
Radiated Emission in Restricted Bands	15.35(b)(c)	Passed
AC Line-conducted Emission	15.207	Passed
Radiated Emission from Digital Part	15.109	Passed, see separate DoC report
Radiated Emission from Receiver L.O.	15.109	Not Applicable. The operating frequency is above 960 MHz
Processing Gain	15.247(c)	Passed, see exhibit "Processing Gain"
RF Exposure Requirement	2.1091	Passed, see exhibit "RF Exposure"
Antenna Requirement	15.203	Passed

Test Engineer: 
Suresh Kondapalli

Date: 5/31/01

EMC Site Manager:  Date: 5/31/01
David Chernomordik, Ph.D.
EMC Site Manager

Symbol Technologies, Model No. LA-4137
FCC ID: H9PLA4137P

Date of Test: April 1 to May 24, 2001

2.0 General Description

2.1 Product Description

The Symbol Technologies model LA-4137 is a 2.4 GHz Direct Sequence Spread Spectrum radio in the form of a PC Card that is used for wireless communication from a LAN to remote wireless devices.

This device is used in a portable configuration and can be located close to personnel. Antennas are mounted in pairs for diversity.

**Overview of WLAN Compact Flash Card
Model: LA-4137**

Applicant	Symbol Technologies
Trade Name & Model No.	Symbol Technologies, LA-4137
FCC Identifier	H9PLA4137P
Use of Product	Wireless LAN communications
Manufacturer & Model of Spread Spectrum Module	Symbol Technologies
Type of Transmission	Direct Sequence Spread Spectrum
Rated RF Output	89 mW, 19.5 dBm
Frequency Range	2412 - 2462
Number of Channel(s)	11
Antenna(s) & Gain,	PCB Chip, Model Trilogy CF, 2 dBi
Antenna Requirement	<input checked="" type="checkbox"/> The EUT uses a permanently connected antenna. <input type="checkbox"/> The antenna is affixed to the EUT using a unique connector which allows for replacement of a broken antenna, but DOES NOT use a standard antenna jack or electrical connector. <input type="checkbox"/> The EUT requires professional installation (attach supporting documentation if using this option).
Manufacturer name & address	Symbol Technologies 6480 Via Del Oro San Jose, CA 95119-1208

2.2 Related Submittal(s) Grants

None.

2.3 Test Methodology

Radiated emissions measurements were performed according to the procedures in ANSI C63.4 (1992). Radiated tests were performed at an antenna to LA-4137 distance of 3 meters, unless stated otherwise in the "**Data Sheet**" of this Application. All other measurements were made in accordance with the procedures in part 2 of CFR 47.

2.4 Test Facility

The open area test site and conducted measurement facility used to collect the radiated data is site 2 located in Menlo Park, California. This test facility and site measurement data have been fully placed on file with the FCC.

3.0 System Test Configuration

3.1 Support Equipment and description

Item #	Description	Model No.	Serial No.	FCC ID
1	Compaq Laptop Computer	Armada 500	1J0BFFH4Y30A	DoC

3.2 Block Diagram of Test Setup

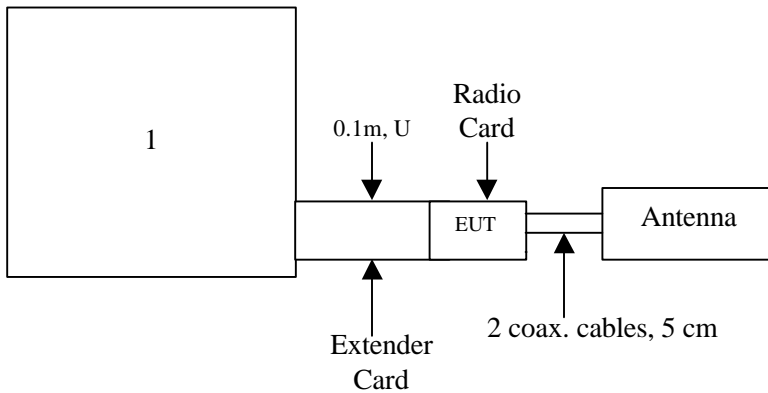

m: Length in meters
U: Unshielded
S: Shielded

3.3 Justification

For radiated emission measurements the LA-4137 is placed on the wooden turntable. The LA-4137 is attached to peripherals and they are connected and operational (as typical as possible). The LA-4137 is wired to transmit full power. During testing, all cables were manipulated to produce worst case emissions.

The signal is maximized through rotation and placement in the three orthogonal axes. The antenna height and polarization are varied during the search for maximum signal level. The antenna height is varied from 1 to 4 meters.

Radiated emissions are taken at three meters unless the signal level is too low for measurement at that distance. If necessary, a pre-amplifier is used and/or the test is conducted at a closer distance. All readings are extrapolated back to the equivalent three-meter reading using inverse scaling with distance.

3.4 Software Exercise Program

The LA-4137 exercise program used during radiated and conducted testing was designed to exercise the various system components in a manner similar to a typical use.

3.5 Mode of Operation During Test

For emissions testing, the units were setup to transmit continuously at the low, middle, and high frequencies.

3.6 Modifications Required for Compliance

No modifications were installed by Intertek Testing Services during compliance testing in order to bring the product into compliance (Please note that this does not include changes made specifically by Symbol Technologies prior to compliance testing).

4.0 Measurement Results

4.1 Conducted Output Power at Antenna Terminals FCC Rules 15.247(b):

Requirements

For antennas with gains of 6 dBi or less, maximum allowed transmitter output is 1 watt (+30 dBm).
For antennas with gains greater than 6 dBi, transmitter output level must be decreased by an amount equal to (GAIN - 6) dBm.

Procedure

The antenna port of the LA-4137 was connected to the input of a spectrum analyzer. Power was Read directly and cable loss correction was included in the offset function of the spectrum analyzer to obtain the power at the LA-4137 antenna terminal.

Test Results

Frequency (MHz)	Output in dBm	Output in mWatt
2412	17.6	58
2437	19.5	89
2462	19.1	81

The maximum EIRP (with antenna gain 2 dBi) is 21.5 dBm.

Refer to the following plots for output power measurement:

4.2 6 dB RF Bandwidth
FCC Rule 15.247(a)(2):

Requirements

The minimum 6 dB bandwidth shall be at least 500 kHz

Procedure

The antenna port of the EUT was connected to the input of a spectrum analyzer. Analyzer RES BW was set to 100 kHz. For each RF output channel investigated, the spectrum analyzer center frequency was set to the channel carrier. A PEAK output reading was taken, a DISPLAY line was drawn 6 dB lower than PEAK level. The 6 dB bandwidth was determined from where the channel output spectrum intersected the display line.

Test Result

Frequency (MHz)	6 dB Bandwidth
2412	9.44 MHz
2437	9.62 MHz
2462	9.60 MHz

Refer to the following plots for 6 dB bandwidth:

- Plot 2a: Low Channel 6 dB RF Bandwidth
- Plot 2b: Middle Channel 6 dB RF Bandwidth
- Plot 2c: High Channel 6 dB RF Bandwidth

4.3 Power Density
FCC Rule 15.247(d):

Requirements

The peak power spectral density shall not be greater than 8 dBm in any 3 kHz band during any time interval of continuous transmission.

Procedure

The spectrum analyzer RES BW was set to 3 kHz. The START and STOP frequencies were set to the band edges of the maximum output passband. If there is no clear maximum amplitude in any given portion of the band, it may be necessary to make measurements at a number of bands defined by several START and STOP frequency pairs. Total SWEEP TIME is calculated as follows:

$$\text{SWEEP TIME (SEC)} = (\text{Fstop, kHz} - \text{Fstart, kHz}) / 3 \text{ kHz}$$

Antenna output of the EUT was coupled directly to spectrum analyzer; if an external attenuator and/or cable was used, these losses are compensated for with the analyzer OFFSET function.

Test Result

Frequency (MHz)	Power Density (dBm)
2463	-8.7

Frequency Span = 600 kHz

Sweep Time = Frequency Span/3 kHz
= 200 Seconds

Refer to the following plots for power density data:

- Plot 3a – 3b: Low Channel Power Density
- Plot 3c – 3d: Middle Channel Power Density
- Plot 3e – 3f: High Channel Power Density

4.4 Out-of-Band Conducted Emissions
FCC Rule 15.247(c):

Requirements

In any 100 kHz bandwidth outside the EUT passband, the RF power shall be at least 20 dB below that of the maximum in-band 100 kHz emission.

Test Result

Refer to the following plots for out of band conducted emissions data:

- Plot 4a1 – 4a8: Low Channel Emissions
- Plot 4b1 – 4b7: Middle Channel Emissions
- Plot 4c1 – 4c7: High Channel Emissions

4.5 Out-of-Band Radiated Emissions
FCC Rule 15.247(c):

For out of band emissions that are close to or less than the 20 dB attenuation requirement described in the section 4.4, radiated measurements were performed at a 3 m separation distance to determine whether these emissions complied with the 20 dB attenuation requirement.

Not required, all out-of-band conducted emissions more than 20 dB below fundamental

4.6 Transmitter Radiated Emissions in Restricted Bands
FCC Rules: 15.247 (c), 15.205, 15.209, 15.35

Radiated emission measurements were performed from 30 MHz to 24000 MHz.

For radiated emission tests, the analyzer setting was as followings:

	<u>RES BW</u>	<u>VID BW</u>
Frequency <1 GHz	100 kHz	100 kHz
Frequency >1 GHz	1 MHz 1 MHz	(Peak measurements)
	1 MHz 10 Hz	(Average measurements)

Data is included of the worst case configuration (the configuration which resulted in the highest emission levels).

The data on the following pages list the significant emission frequencies, the limit and the margin of compliance.

The field strength at the Bandedge frequencies was calculated as $E_F = E_o - \Delta$.

Where:

E_F = Field Strength at bandedge frequency, dBuV/m

E_o = Field Strength at fundamental frequency , dBuV/m

Δ = Delta between output power at fundamental frequency and at band-edge frequency

Refer to following data sheets and plots 4a4, 4a5, 4b4, 4b5 for details.

Fundamental Frequency, MHz	Average FS at fundamental frequency, dBuV/m	Minimum Delta, dB *	Calculated Average FS in restricted bands 2.31-2.39 GHz and 2.4835-2.5 GHz, dBuV/m *	Average FS Limit in restricted bands, dBuV/m	Plot number
2412	98.9	62.8	36.1	54.0	4a3, 4a5
2437	93.9	58.3	35.6	54.0	4b3, 4b4
2462	100.8	49.5	51.3	54.0	4c3, 4c4

* Worst case calculated

FS – Field Strength

Radiated Emissions Test Data

Company:	Symbol	Model #:	LA4137	Standard	FCC § 15.247 (R.B.)
EUT:	Compact Flash	S/N #:		Limit	11
Project #:	J20036369I	Test Date:	April13, 2001	Test Distance	3 meters
Test Mode:	Transmitter@2412MHz	Engineer:	Suresh K	Duty relaxation	0 dB

	Antenna Used			Pre-Amp Used			Cable Used			Transducer Used
Number:	8	7	21	8	10	13	21	0	0	0
Model:	EMCO 3115	EM LPA- 25	3160-9	CDI_P10 00	AFT18855	ACO/400	Grn_ M+L	None	None	None

Frequency	Reading	Detector	Ant	Amp	Ant. Pol.	Ant. Factor	Pre-Amp	Insert Loss	D. C. F.	Net	Limit @3m	Margin
MHz	dB(µV)	P/A/Q	#	#	H/V	dB(1/m)	dB	dB	dB	dB(µV/m)	dB(µV/m)	dB
2412.0	69.0	Peak	8	0	V	29.1	0.0	2.3	0.0	100.4	-	-
2412.0	59.8	Ave.	8	0	V	29.1	0.0	2.3	0.0	91.2	-	-
4824.0	43.3	Peak	8	8	V	34.0	28.1	3.2	0.0	52.4	74.0	-21.6
4824.0	30.4	Ave.	8	8	V	34.0	28.1	3.2	0.0	39.5	54.0	-14.5
7236.0	32.5	Peak	8	8	V	37.0	28.0	4.3	0.0	45.8	74.0	-28.2
7236.0	20.7	Ave.	8	8	V	37.0	28.0	4.3	0.0	34.0	54.0	-20.0
9648.0	33.7	Peak	8	8	V	38.5	27.3	5.0	0.0	49.9	74.0	-24.1
9648.0	21.4	Ave.	8	8	V	38.5	27.3	5.0	0.0	37.6	54.0	-16.4
12060	39.8	Peak	8	10	V	41.6	39.1	5.9	0.0	48.2	74.0	-25.8
12060	29.1	Ave.	8	10	V	41.6	39.1	5.9	0.0	37.5	54.0	-16.5
14472	39.4	Peak	8	10	V	40.7	37.8	6.5	0.0	48.8	74.0	-25.2
14472	27.3	Ave.	8	10	V	40.7	37.8	6.5	0.0	36.7	54.0	-17.3
16884	38.4	Peak	8	10	V	40.8	39.4	7.2	0.0	47.0	74.0	-27.0
16884	27.5	Ave.	8	10	V	40.8	39.4	7.2	0.0	36.1	54.0	-17.9
19296	34.1	Peak	21	13	V	40.2	23.3	7.7	0.0	58.7	74.0	-15.3
19296	22.5	Ave.	21	13	V	40.2	23.3	7.7	0.0	47.1	54.0	-6.9
21708	32.1	Peak	21	13	V	40.3	23.3	7.9	0.0	57.0	74.0	-17.0
21708	22.4	Ave.	21	13	V	40.3	23.3	7.9	0.0	47.3	54.0	-6.7
24120	33.3	Peak	21	13	V	40.4	24.2	8.5	0.0	58.0	74.0	-16.0
24120	22.7	Ave.	21	13	V	40.4	24.2	8.5	0.0	47.4	54.0	-6.6

Notes:	a) D.C.F.:Distance Correction Factor
	b) Insert. Loss (dB) = Cable A + Cable B + Cable C .
	c) Net (dB) = Reading + Antenna Factor - Pre-amp + Insert. Loss. - Transducer Loss; - Duty Relaxation (transmitter only).
	d) Negative signs (-) in Margin column signify levels below the limits.
	e) All other emissions not reported are below the equipment noise floor which is at least 10 dB below the limits.

Radiated Emissions Test Data

Company:	Symbol	Model #:	LA4137	Standard	FCC § 15.247 (R.B.)
EUT:	Compact Flash	S/N #:		Limits	11
Project #:	J20036369I	Test Date:	April 13, 2001	Test Distance	3 meters
Test Mode:	Transmitter@2437MHz	Engineer:	Suresh K	Duty Relaxation	0 dB

	Antenna Used			Pre-Amp Used			Cable Used			Transducer Used
Number:	8	7	21	8	10	13	21	0	0	0
Model:	EMCO 3115	EM LPA-25	3160-9	CDI_P100 0	AFT18855	ACO/400	Gm_M+L	None	None	None

Frequency	Reading	Detector	Ant	Amp.	Ant. Pol.	Ant. Factor	Pre-Amp	Insert. Loss	D. C. F.	Net	Limit @3m	Margin
MHz	dB(µV)	P/A/Q	#	#	H/V	dB(1/m)	dB	dB	dB	dB(µV/m)	dB(µV/m)	dB
2437.0	71.8	Peak	8	0	V	29.1	0.0	2.3	0.0	103.2	-	-
2437.0	62.5	Ave.	8	0	V	29.1	0.0	2.3	0.0	93.9	-	-
4874.0	49.3	Peak	8	8	V	34.0	28.1	3.2	0.0	58.4	74.0	-15.6
4874.0	40.1	Ave.	8	8	V	34.0	28.1	3.2	0.0	49.2	54.0	-4.8
7311.0	34.5	Peak	8	8	V	37.0	28.0	4.3	0.0	47.8	74.0	-26.2
7311.0	21.8	Ave.	8	8	V	37.0	28.0	4.3	0.0	35.1	54.0	-18.9
9748.0	33.8	Peak	8	8	V	38.5	27.3	5.0	0.0	50.0	74.0	-24.0
9748.0	21.4	Ave.	8	8	V	38.5	27.3	5.0	0.0	37.6	54.0	-16.4
12185	40.4	Peak	8	10	V	41.6	39.1	5.9	0.0	48.8	74.0	-25.2
11185	29.2	Ave.	8	10	V	41.6	39.1	5.9	0.0	37.6	54.0	-16.4
14622	39.4	Peak	8	10	V	41.3	37.4	6.8	0.0	50.1	74.0	-23.9
14622	27.3	Ave.	8	10	V	41.3	37.4	6.8	0.0	38.0	54.0	-16.0
17059	38.6	Peak	8	10	V	42.0	38.8	7.5	0.0	49.3	74.0	-24.7
17059	27.5	Ave.	8	10	V	42.0	38.8	7.5	0.0	38.2	54.0	-15.8
19496	34.2	Peak	21	13	V	40.2	23.3	7.7	0.0	58.8	74.0	-15.2
19496	22.5	Ave.	21	13	V	40.2	23.3	7.7	0.0	47.1	54.0	-6.9
21933	32.1	Peak	21	13	V	40.3	23.3	7.9	0.0	57.0	74.0	-17.0
21933	22.4	Ave.	21	13	V	40.3	23.3	7.9	0.0	47.3	54.0	-6.7
24370	33.3	Peak	21	13	V	40.4	24.2	8.5	0.0	58.0	74.0	-16.0
24370	22.7	Ave.	21	13	V	40.4	24.2	8.5	0.0	47.4	54.0	-6.6

Notes:	a) D.C.F.: Distance Correction Factor
	b) Insert. Loss (dB) = Cable A + Cable B + Cable C .
	c) Net (dB) = Reading + Antenna Factor - Pre-amp + Insert. Loss. - Transducer Loss - Duty Relaxation (transmitter only).
	d) Negative signs (-) in Margin column signify levels below the limits.
	e) All other emissions not reported are below the equipment noise floor which is at least 10 dB below the limits.

Radiated Emissions Test Data

Company:	Symbol	Model #:	LA4137	Standard	FCC § 15.247 (R.B.)
EUT:	Compact Flash	S/N #:		Limits	11
Project #:	J20036369I	Test Date:	April13, 2001	Test Distance	3 meters
Test Mode:	Transmitter@2462MHz	Engineer:	Suresh K	Duty Relaxation	0 dB

	Antenna Used			Pre-Amp Used			Cable Used			Transducer Used
Number:	8	7	21	8	10	13	21	0	0	0
Model:	EMCO 3115	EM LPA- 25	3160-9	CDI_P1 000	AFT18855	ACO/400	Grn_M+L	None	None	None

Frequency	Reading	Detector	Ant	Amp	Ant. Pol.	Ant. Factor	Pre-Amp	Insert. Loss	D. C. F.	Net	Limit @3m	Margin
MHz	dB(µV)	P/A/Q	#	#	H/V	dB(1/m)	dB	dB	dB	dB(µV/m)	dB(µV/m)	dB
2462.0	74.7	Peak	8	0	V	29.1	0.0	2.3	0.0	106.1	-	-
2462.0	63.4	Ave.	8	0	V	29.1	0.0	2.3	0.0	94.8	-	-
4924.0	45.9	Peak	8	8	V	34.0	28.1	3.2	0.0	55.0	74.0	-19.0
4924.0	33.2	Ave.	8	8	V	34.0	28.1	3.2	0.0	42.3	54.0	-11.7
7386.0	34.7	Peak	8	8	V	37.0	28.0	4.3	0.0	48.0	74.0	-26.0
7386.0	23.3	Ave.	8	8	V	37.0	28.0	4.3	0.0	36.6	54.0	-17.4
9848.0	35.1	Peak	8	8	V	38.5	27.6	5.0	0.0	51.0	74.0	-23.0
9848.0	23.2	Ave.	8	8	V	38.5	27.6	5.0	0.0	39.1	54.0	-14.9
12310	40.2	Peak	8	10	V	41.6	39.1	5.9	0.0	48.6	74.0	-25.4
12310	29.1	Ave.	8	10	V	41.6	39.1	5.9	0.0	37.5	54.0	-16.5
14772	39.8	Peak	8	10	V	41.3	37.4	6.8	0.0	50.5	74.0	-23.5
14772	27.6	Ave.	8	10	V	41.3	37.4	6.8	0.0	38.3	54.0	-15.7
17234	38.3	Peak	8	10	V	42.0	38.8	7.5	0.0	49.0	74.0	-25.0
17234	28.1	Ave.	8	10	V	42.0	38.8	7.5	0.0	38.8	54.0	-15.2
19696	35.1	Peak	21	13	V	40.3	23.3	7.7	0.0	59.8	74.0	-14.2
19696	22.5	Ave.	21	13	V	40.3	23.3	7.7	0.0	47.2	54.0	-6.8
22158	32.1	Peak	21	13	V	40.3	23.3	7.9	0.0	57.0	74.0	-17.0
22158	22.4	Ave.	21	13	V	40.3	23.3	7.9	0.0	47.3	54.0	-6.7
24620	33.3	Peak	21	13	V	40.4	24.2	8.5	0.0	58.0	74.0	-16.0
24620	22.7	Ave.	21	13	V	40.4	24.2	8.5	0.0	47.4	54.0	-6.6

Notes:	a) D.C.F.:Distance Correction Factor
	b) Insert. Loss (dB) = Cable A + Cable B -- Cable C .
	c) Net (dB) = Reading + Antenna Factor - Pre-amp + Insert. Loss. - Transducer Loss - Duty Relaxation (transmitter only).
	d) Negative signs (-) in Margin column signify levels below the limits.
	e) All other emissions not reported are below the equipment noise floor which is at least 10 dB below the limits.

Symbol Technologies, Model No. LA-4137
FCC ID: H9PLA4137P

Date of Test: April 1 to May 24, 2001

4.7 AC Line Conducted Emission
FCC Rule 15.207:

AC line conducted emission test was performed according the ANSI C63.4 standard. The EUT was connected to AC Line through the LISNs.

For the test result, see attached plot 7.1.

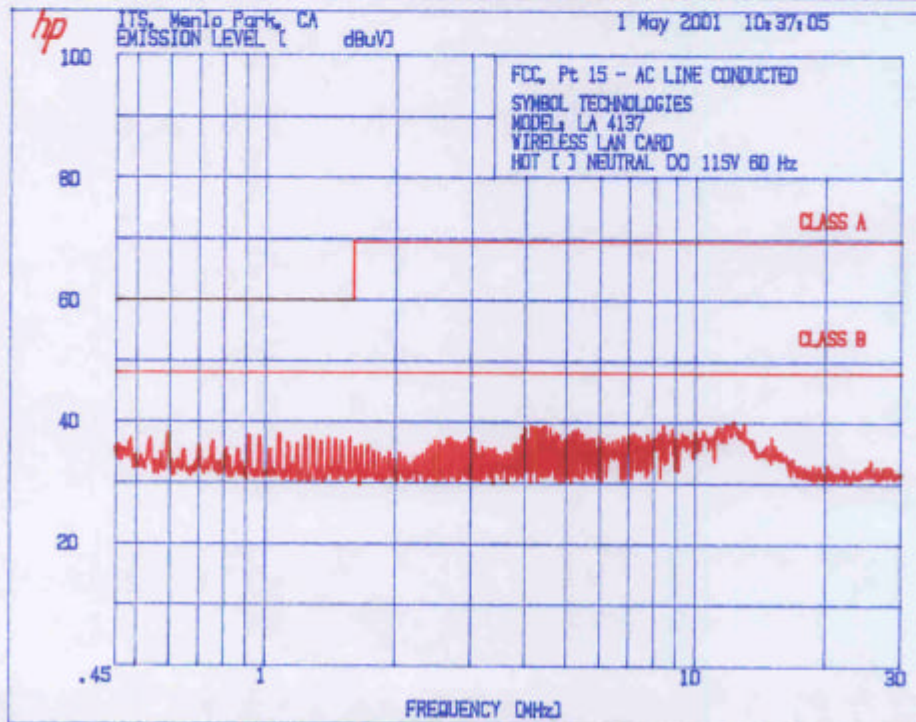
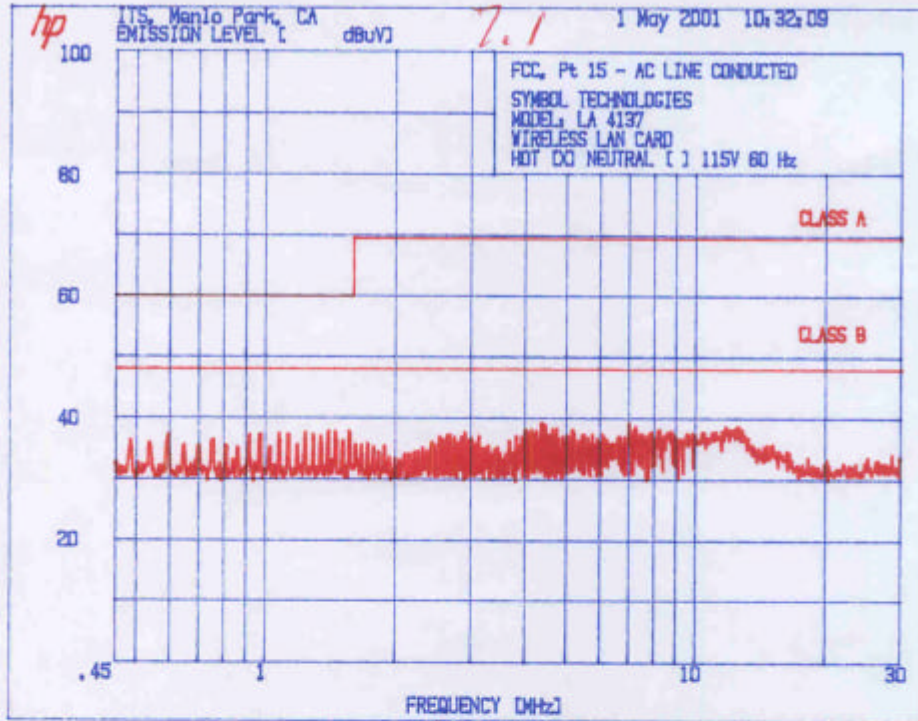

4.8 Radiated Emissions from Digital Section of Transceiver (Transmitter)
FCC Ref: 15.109

See separate DoC report.

- 4.9 Radiated Emissions from Receiver Section of Transceiver (L.O. Radiation)
FCC Ref: 15.109, 15.111

Not required - EUT operation above 960 MHz only.

5.0 List of test Equipment

EQUIPMENT	MANUFACTURER	MODEL NUMBER	SERIAL NUMBER	CAL. INTERVAL	CAL. DUE
Spectrum Analyzer w/85650 QP Adapter	Hewlett Packard	8566B	2416A00317 2043A00251	12	4/6/02
Spectrum Analyzer w/8650 QP Adaptor	Hewlett Packard	8568B	1912A0053 2521A01021	12	2/23/02
Spectrum Analyzer	Tektronix	2784	B3020108	12	8/4/01
Double-ridged Horn Antenna	EMCO	3115	9107-3712	12	3/17/02
Horn Antenna	EMCO	3160-09	Not Labeled	#	#
Pre-Amplifier,#5	CDI	P950	ITS009	12	10/6/01
Pre-Amplifier	CDI	P1000	N/A	12	10/06/01
Pre-Amplifier	Avantek	AFT-18855	8723H705	12	10/5/01
Pre-amplifier	CTT	ACO/400	47526	12	10/5/01
Power Meter	Hewlett Packard	8900D	3607U00673	12	7/31/01

No Calibration Required

6.0 Document History

Revision/ Job Number	Writer Initials	Date	Change
1.0 / J20046983D1	OM	May 25, 2001	Original document