

FCC Part 15.247 Test Report
for
Symbol Technologies
on the
Model: LA4121
FCC ID: Not Labeled

Test Report #: J20008658d
Date of Report: April 11, 2000

Job #: J20008658-C
Date of Test: April 3 & 7, 2000

Total No. of Pages Contained in this Report: 25 + data pages



<i>Barry E. Smith</i>	Barry E. Smith, Test Engineer
<i>David Chernomordik</i>	David Chernomordik, Ph.D., EMC Site Manager

All services undertaken are subject to the following general policy: Reports are submitted for exclusive use of the client to whom they are addressed. Their significance is subject to the adequacy and representative character of the samples and to the comprehensiveness of the tests, examinations or surveys made. This report shall not be reproduced except in full, without written consent of Intertek Testing Services, NA Inc. This report must not be used to claim product endorsement by NVLAP, NIST nor any other agency of the U.S. Government.

FCC Part 15 DSSS Cert. Rev 9/99



Table of Contents

1.0	Summary of Tests	2
2.0	General Description	3
2.1	Product Description	3
2.2	Related Submittal(s) Grants	3
2.3	Test Methodology	4
2.4	Test Facility.....	4
3.0	System Test Configuration	5
3.1	Support Equipment and description	5
4.2	Block Diagram of Test Setup	5
3.3	Justification.....	6
3.4	Software Exercise Program.....	6
3.5	Mode of Operation During Test	6
3.6	Modifications Required for Compliance	6
3.7	Additions, deviations and exclusions from standards	6
4.0	Measurement Results	7
4.1	Maximum Conducted Output Power at Antenna Terminals	7
4.2	Minimum 6 dB RF Bandwidth	8
4.3	Maximum Power Density Reading	9
4.4	Out of Band Conducted Emissions.....	10
4.5	Out of Band Radiated Emissions.....	11
4.7	AC Line Conducted Emission.....	13
4.8	Radiated Emissions from Digital Section of Transceiver (Transmitter).....	14
4.9	Radiated Emissions from Receiver Section of Transceiver (L.O. Radiation).....	15
4.10	Processing Gain Measurements	16
4.11	Transmitter Duty Cycle Calculation and Measurements.....	17
5.0	Appendix A : Plots	18
6.0	Appendix B: Photographs	19

Symbol Technologies, Model No. LA4121
 FCC ID:

Date of Test: April 3 & 7, 2000

1.0 Summary of Tests

MODEL: LA4121

TEST	REFERENCE	RESULTS
Max. Output power	15.247(b)	Pass
6 dB Bandwidth	15.247(a)(2)	Pass
Max. Power Density	15.247(d)	Pass
Out of Band Antenna Conducted Emission	15.247(c)	Pass
Out of Band Radiated Emission	15.247(c)	N/A
Radiated Emission in Restricted Bands	15.247(c)	Pass
AC Conducted Emission	15.207	Pass <i>see DaC report</i>
Radiated Emission from Digital Part	15.109	Pass
Radiated Emission from Receiver L.O.	15.109	Not Applicable
Processing Gain Measurements	15.247(e)	Provided by applicant
Antenna Requirement	15.203	Pass

Test Engineer: *Barry E. Smith*
 Barry E. Smith

Date: *5/5/00*

EMC Site Manager: *David Chernomordik*
 David Chernomordik, Ph.D.
 EMC Site Manager

Date: *5/5/00*



Symbol Technologies, Model No. LA4121
FCC ID:

Date of Test: April 3 & 7, 2000

2.0 General Description

2.1 Product Description

The Symbol Technologies model LA4121 is 2.4 GHz Spread Spectrum radio in the form of a PCMCIA card that is used for wireless communication from a computer to a LAN.

A pre-production version of the sample was received on January 31, 2000 in good condition.

Overview of LA4121

Applicant	Symbol Technologies
Trade Name & Model No.	Symbol Technologies / LA4121
FCC Identifier	Not Labeled
Use of Product	
Manufacturer & Model of Spread Spectrum Module	Symbol Technologies
Type of Transmission	Direct Sequence
Rated RF Output (mW)	22 dBm
Frequency Range (MHz)	2412 – 2462 MHz
Number of Channel(s)	11
Antenna(s) & Gain, dBi	9
Processing Gain Measurements	<input type="checkbox"/> Will be provided to ITS for submission with the application <input type="checkbox"/> Will be provided directly to the FCC reviewing engineer by the client or manufacturer of the spread spectrum module
Antenna Requirement	<input type="checkbox"/> The EUT uses a permanently connected antenna. <input checked="" type="checkbox"/> The antenna is affixed to the EUT using a unique connector which allows for replacement of a broken antenna, but DOES NOT use a standard antenna jack or electrical connector. <input type="checkbox"/> The EUT requires professional installation (attach supporting documentation if using this option).
Manufacturer name & address	Symbol Technologies 2145 Hamilton Avenue San Jose CA 95125

2.2 Related Submittal(s) Grants

None

2.3 Test Methodology

Both AC mains line-conducted and radiated emissions measurements were performed according to the procedures in ANSI C63.4 (1992). Radiated tests were performed at an antenna to EUT distance of 3 meters, unless stated otherwise in the "**Data Sheet**" of this Application. All other measurements were made in accordance with the procedures in part 2 of CFR 47.

2.4 Test Facility

The open area test site and conducted measurement facility used to collect the radiated data is site 2. This test facility and site measurement data have been fully placed on file with the FCC and NVLAP accredited.



3.0 System Test Configuration

3.1 Support Equipment and description

Item #	Description	Model No.	Serial No.
1	Dell PC	Latitude M233ST	Z8T5U
2	Dell Monitor	D1428-HS	2922CV22495
3	Datatronics Modem	1200CK	07-305041
4	HP Printer	2225C+	2921S45711

4.2 Block Diagram of Test Setup

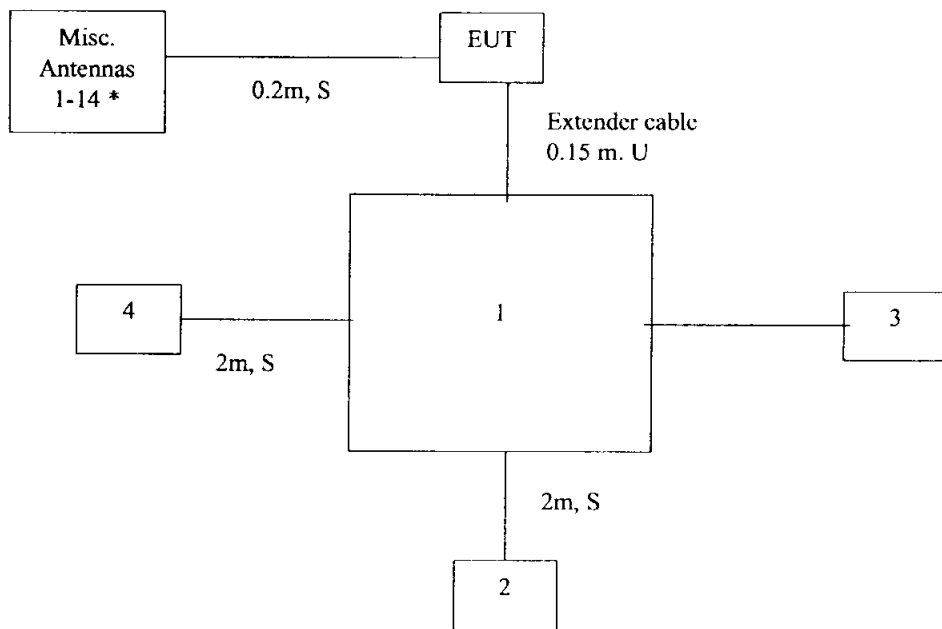

S=Shielded U=Unshielded

3.3 Justification

For emission testing, the equipment under test (EUT) was configured for testing in a typical fashion (as a customer would normally use it). During testing, all cables were manipulated to produce worst case emissions.

For radiated emission measurements, the EUT is attached to a cardboard box (if necessary) and placed on the wooden turntable. If the EUT attaches to peripherals, they are connected and operational (as typical as possible). The EUT is wired to transmit full power.

The signal is maximized through rotation and placement in the three orthogonal axes. The antenna height and polarization are varied during the search for maximum signal level. The antenna height is varied from 1 to 4 meters.

Radiated emissions are taken at three meters unless the signal level is too low for measurement at that distance. If necessary, a pre-amplifier is used and/or the test is conducted at a closer distance. All readings are extrapolated back to the equivalent three meter reading using inverse scaling with distance.

Detector functions are in peak and average modes for frequencies above 1 GHz.

3.4 Software Exercise Program

The EUT exercise program used during radiated and conducted testing was designed to exercise the various system components in a manner similar to a typical use. For emissions testing, the units were setup to transmit continuously to simplify the measurement methodology. Care was taken to ensure proper power supply voltages during testing.

3.5 Mode of Operation During Test

EUT was set to continuously transmit.

3.6 Modifications Required for Compliance

The following modifications were installed during compliance testing in order to bring the product into compliance (Please note that this list does not include changes made specifically by Symbol Technologies prior to compliance testing):

No modifications were installed by Intertek Testing Services.

3.7 Additions, deviations and exclusions from standards

No additions, deviations, or exclusions were made to the standard.

4.0 Measurement Results

4.1 Maximum Conducted Output Power at Antenna Terminals, FCC Rules 15.247(b)

Requirement

For antennas with gains of 6 dBi or less, maximum allowed transmitter output power is 1 watt (+30 dBm).

For antennas with gain greater than 6 dBi, transmitter output power must be decreased by an amount equal to (GAIN - 6) dB.

Procedure

[X] The antenna port of the EUT was connected to the input of a power meter. Power was read directly and cable loss correction was added to the reading to obtain power at the EUT antenna terminals.

[] The antenna port of the EUT was connected to the input of a spectrum analyzer. The analyzer was set for maximum RES BW and power was read directly in dBm. External attenuation and cable loss were compensated for using the OFFSET function of the analyzer.

Max. antenna gain = 9 dBi		
Frequency (MHz)	Output in dBm	Output in mWatt
2412	21.8	
2437	20.5	
2462	19.4	

Cable loss: 0 dB

External Attenuation: 0 dB

Cable loss, external attenuation:

[x] included in OFFSET function

[] added to SA raw reading

Test Result

EUT Transmit Antenna Gain(dBi) + dBm max. output power = 31.8 dBm (less than 36 dBm)

The EUT passed the test

Symbol Technologies, Model No. LA4121
FCC ID:

Date of Test: April 3 & 7, 2000

4.2 Minimum 6 dB RF Bandwidth, FCC Rule 15.247(a)(2):

Requirement

For direct sequence systems, the minimum 6 dB bandwidth shall be at least 500 kHz.

Procedure

The antenna port of the EUT was connected to the input of a spectrum analyzer. Analyzer RES BW was set to 100 kHz. For each RF output channel investigated, the spectrum analyzer center frequency was set to the channel carrier. A PEAK output reading was taken, a DISPLAY line was drawn 6 dB lower than PEAK level. The 6 dB bandwidth was determined from where the channel output spectrum intersected the display line.

Test Result

Frequency (MHz)	Min. 6 dB Bandwidth (kHz)
2437	9760

Refer to the following plots for 6 dB bandwidth sharp:

- Plot 2a: Low Channel 6 dB RF Bandwidth
- Plot 2b: Middle Channel 6 dB RF Bandwidth
- Plot 2c: High Channel 6 dB RF Bandwidth

The EUT passed the test.

4.3 Maximum Power Density Reading, FCC Rule 15.247(d):

Requirement

The peak power spectral density shall not be greater than 8 dBm in any 3 kHz band during any time interval of continuous transmission.

Procedure

The spectrum analyzer RES BW was set to 3 kHz. The START and STOP frequencies were set to the band edges of the maximum output passband. If there is no clear maximum amplitude in any given portion of the band, it may be necessary to make measurements at a number of bands defined by several START and STOP frequency pairs. Total SWEEP TIME is calculated as follows:

$$\text{SWEEP TIME (SEC)} = (\text{Fstop, kHz} - \text{Fstart, kHz}) / 3 \text{ kHz}$$

Antenna output of the EUT was coupled directly to spectrum analyzer; if an external attenuator and/or cable was used, these losses are compensated for with the analyzer OFFSET function.

Frequency (MHz)	Power Density (dBm)
2412	1.9dBm

Frequency Span = 2100 kHz

Sweep Time = Frequency Span / 3 kHz
= 700 seconds

Test Result

Refer to the following plots for power density data:

Plot 3a: Low Channel Power Density
Plot 3b: Middle Channel Power Density
Plot 3c: High Channel Power Density

4.4 Out of Band Conducted Emissions, FCC Rule 15.247(c):

Requirement

In any 100 kHz bandwidth outside the frequency band, the RF power shall be at least 20 dB below that in the 100 kHz bandwidth within the band that contains the highest level of the desired power.

Test Procedure

The antenna port of the EUT was connected to the input of a spectrum analyzer. Analyzer RES BW was set to 100 kHz. Several plots were made to show Out of Band Conducted Emissions in the frequency range from 1 MHz to 25 GHz.

Test Result

Refer to the following plots for out of band conducted emissions data:

Plot 4a.1 - 4a.6: Low Channel Emissions

Plot 4b.1 - 4b.6: Middle Channel Emissions

Plot 4c.1 - 4c.6 : High Channel Emissions

The EUT passed the test

Symbol Technologies, Model No. LA4121
FCC ID:

Date of Test: April 3 & 7, 2000

4.5 Out of Band Radiated Emissions (except Radiated emissions in Restricted Bands), FCC Rule 15.247(c).

For out of band emissions that are close to or that exceed the 20 dB attenuation requirement described in the specification, radiated measurements were performed at a 3 m separation distance to determine whether these emissions complied with the radiated emission requirement. (20 dB below in- band emissions)

- Not required. All out-of-band conducted emissions at least 20 dB below in-band conducted emissions.
- See attached data sheet

RADIATED Measurements (Fundamental & Harmonics)

Operating Frequency: 2412.0 MHz
 Distance of Measurements: 3 meters
 Channel: Low

FREQ. (MHz)	Level* (dBm)	AFCL (dB)	POL (H/V)	DET QP/AVG	F/S ($\mu\text{V}/\text{m}$)	F/S ($\text{dB}\mu\text{V}/\text{m}$)	Margin (dB)
2412.0	- 23.2	32.7	V	Peak	670656.0	116.5	n/a
4824.0	- 97.0	40.4	V	Peak	330.8	50.4	3.6
7236.0	- 102.5	47.4	V	Peak	394.5	51.9	64.6
9648.0	- 119.5	50.3	V	Peak	77.6	37.8	12.6
12060.0	< - 120						

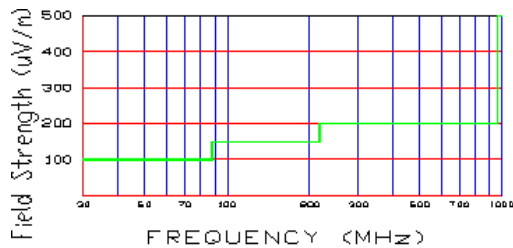

Figure 1. Restricted band harmonics and spurious limits.

Above 1 GHz limit is 500 uV/m (54dBu/m)

NOTES:

1. All harmonics in the restricted bands specified in §15.205 are below the limit shown in table 2. (note: * Restricted Band)
2. All harmonics/spurs are at least 20 dB below the highest emission in the authorized band using RBW = 100kHz
3. Average Measurements > 1GHz using RBW = 1 MHz VBW = 10 Hz
4. The peak emissions above 1 GHz are not more than 20 dB above the average limit.
5. The antenna is manipulated through typical positions, polarity and length during the tests.
6. The EUT is supplied with nominal AC voltage or/and a new/fully recharged battery.
7. The spectrum is measured from 9kHz to the 10th harmonic and the worst-case emissions are reported.
8. < - 120 are below the analyzer floor level.

RADIATED Measurements (Fundamental & Harmonics) (CONT.)

Operating Frequency: 2437.0 MHz

Distance of Measurements: 3 meters

Channel: Middle

FREQ. (MHz)	Level* (dBm)	AFCL (dB)	POL (H/V)	DET QP/AVG	F/S (μV/m)	F/S (dBμV/m)	Margin (dB)
2437.0	- 23.3	32.8	V	Peak	670656.0	116.5	n/a
4874.0	- 96.0	40.5	V	Peak	375.8	51.5	2.5
7311.0	- 103.5	48.0	V	Peak	375.8	51.5	2.5
9748.0	- 118.2	50.3	V	Peak	90.2	39.1	14.9
12185.0	< - 120						

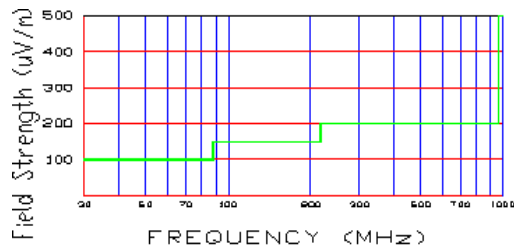

Figure 2. Restricted band harmonics and spurious limits.

Above 1 GHz limit is 500 uV/m (54dBu/m)

NOTES:

1. All harmonics in the restricted bands specified in §15.205 are below the limit shown in table 2. (note: * Restricted Band)
2. All harmonics/spurs are at least 20 dB below the highest emission in the authorized band using RBW = 100kHz
3. Average Measurements > 1GHz using RBW = 1 MHz VBW = 10 Hz
4. The peak emissions above 1 GHz are not more than 20 dB above the average limit.
5. The antenna is manipulated through typical positions, polarity and length during the tests.
6. The EUT is supplied with nominal AC voltage or/and a new/fully recharged battery.
7. The spectrum is measured from 9kHz to the 10th harmonic and the worst-case emissions are reported.
8. < - 120 are below the analyzer floor level.

RADIATED Measurements (Fundamental & Harmonics) (CONT.)

Operating Frequency: 2462.0 MHz
 Distance of Measurements: 3 meters
 Channel: High

FREQ. (MHz)	Level* (dBm)	AFCL (dB)	POL (H/V)	DET QP/AVG	F/S (μ V/m)	F/S (dB μ V/m)	Margin (dB)
2462.0	- 23.4	32.9	V	Peak	668344.0	116.5	n/a
4924.0	- 96.9	40.7	V	Peak	346.7	50.8	3.2
7386.0	- 104.0	48.2	V	Peak	363.1	51.2	2.8
9848.0	- 120	50.4	V	Peak	74.1	37.4	16.6
12310.0	< - 120						

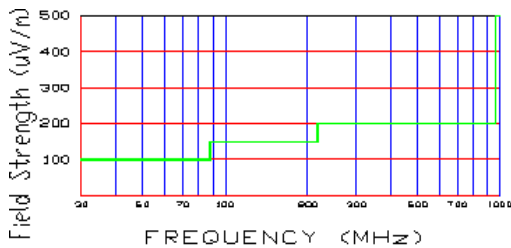

Figure 3. Restricted band harmonics and spurious limits.

Above 1 GHz limit is 500 uV/m (54dBu/m)

NOTES:

1. All harmonics in the restricted bands specified in §15.205 are below the limit shown in table 2. (note: * Restricted Band)
2. All harmonics/spurs are at least 20 dB below the highest emission in the authorized band using RBW = 100kHz
3. Average Measurements > 1GHz using RBW = 1 MHz VBW = 10 Hz
4. The peak emissions above 1 GHz are not more than 20 dB above the average limit.
5. The antenna is manipulated through typical positions, polarity and length during the tests.
6. The EUT is supplied with nominal AC voltage or/and a new/fully recharged battery.
7. The spectrum is measured from 9kHz to the 10th harmonic and the worst-case emissions are reported.
8. < - 120 are below the analyzer floor level.

4.6 Transmitter Radiated Emissions in Restricted Bands, FCC Rule 15.247 (c), 15.209, 15.35(b), (c):

Radiated emission measurements were performed according ANSI C63.4 Requirements.

Radiated emission measurements were performed from 30 MHz to 25 GHz. Analyzer resolution bandwidth (Res BW) was 100 kHz or greater for frequencies from 30 MHz to 1 GHz, and 1 MHz for frequencies above 1 GHz.

All measurements below 1 GHz were performed with peak detection unless otherwise specified, all measurements above 1 GHz were performed with peak and average detection.

In addition for antenna with highest antenna gain (antenna 15), radiated emissions on the band-edge frequencies were performed using a "delta method". The field strength at the fundamental frequencies (E_0) was measured and recorded (peak and average level) at lowest and highest channels. The conducted emission plots were made to show attenuation (delta) at the 2483.5 MHz and up to 2500 MHz (for high channel), and attenuation at 2390 MHz and down to 2310 MHz (for low channel). Radiated emission at the band-edge frequencies were calculated by subtracting "delta" from field strength at the fundamental frequencies.

Data is included of the worst case configuration (the configuration which resulted in the highest emission levels). A sample calculation, configuration photographs and data tables of the emissions are included.

For band-edge frequency 2483.5 MHz:

at 2462 MHz $E_0 = 102.1$ dBuV (average), $E_0 = 106.0$ dBuV (peak)
"delta" = 54.7 dB (from plot 6.1)

Field Strength at band-edge frequency $E_f = 47.4$ dBuV (average), $E_f = 51.3$ dBuV (peak)

For 2390 MHz

at 2412 MHz $E_0 = 104.0$ dBuV (average), $E_0 = 108.0$ dBuV (peak)
"delta" = 58.2 dB (from plot 6.3)

Field Strength at 2390 MHz, $E_f = 45.8$ dBuV (average), $E_f = 49.8$ dBuV (peak)

The data on the following pages list the significant emission frequencies, the limit and the margin of compliance.

A

1365 Adams Ct. Menlo Park, CA 94025

Symbol Technologies, Model No. LA4121
FCC ID:

Date of Test: April 3 & 7, 2000

4.7 AC Line Conducted Emission, FCC Rule 15.207:

Test was performed according the ANSI C63.4 requirements.

Not required; battery operation only

Test data in DoC report

A

1365 Adams Ct. Menlo Park, CA 94025

Symbol Technologies, Model No. LA4121
FCC ID:

Date of Test: April 3 & 7, 2000

4.8 Radiated Emissions from Digital Section of Transceiver (Transmitter), FCC Ref: 15.109

- Not required - No digital part
- Test results are attached
- Included in the separate DOC report.

A

1365 Adams Ct. Menlo Park, CA 94025

Symbol Technologies, Model No. LA4121

Date of Test: April 3 & 7, 2000

FCC ID:

4.9 Radiated Emissions from Receiver Section of Transceiver (L.O. Radiation), FCC Ref: 15.109, 15.111

[x] Not required - EUT operation above 960 MHz only

[] Not required - EUT is transmitter only

[] Test results are attached

4.10 Processing Gain Measurements, FCC Rule 15.247(e)

The processing gain shall be determined from the ratio in dB of the signal to noise ratio with the system spreading code turned OFF, to the signal to noise ratio with the system spreading code turned ON, as measured at the demodulated output of the receiver. The processing gain shall be at least 10 dB for a direct sequence spread spectrum system.

	Refer to attached test procedure and data sheets.
X	Refer to circuit analysis and processing gain calculations provided by manufacturer.

Symbol Technologies, Model No. LA4121
FCC ID:

Date of Test: April 3 & 7, 2000

4.11 Transmitter Duty Cycle Calculation and Measurements, FCC Rule 15.35(b), (c)

The EUT antenna output port was connected to the input of the spectrum analyzer. The analyzer center frequency was set to EUT RF channel carrier. The SWEEP function on the analyzer was set to ZERO SPAN. The transmitter ON time was determined from the resultant time-amplitude display:

Duty cycle = Maximum ON time in 100 msec/100

Duty cycle correction, dB = $20 * \log(\text{DC})$

	See attached spectrum analyzer chart(s) for transmitter timing
	See transmitter timing diagram provided by manufacturer
X	No Duty cycle correction was used

A

1365 Adams Ct. Menlo Park, CA 94025

Symbol Technologies, Model No. LA4121
FCC ID:

Date of Test: April 3 & 7, 2000

5.0 Appendix A : Plots

Processing Gain Calculation Symbol Technologies LA-4121 WLAN PC Card

Norman H. Nelson, Sr. EMC Engineer
May 8, 2000

Symbol calculated the processing gain from the jamming margin of the LA-4121 transceiver as specified in 15.247 (e)(2).

Test Setup

The purpose of the jamming test is to determine how effective the modulation, coding and decoding is at rejecting the corrupting influence of a CW jammer signal. Where as most setups use a BER to generate data and count errors because the modulator chip architecture prevents injecting data after chipping, Symbol chose to use another LA-4121 as the transmitter and data generator. A link between the transmitter and receiver is made and path loss adjusted so that the BER is $10E-5$. The path loss is then reduced by 10 dB so that the BER approaches zero. Finally a jamming signal is combined with the transmitted signal to degrade the system performance. The jamming signal amplitude is then adjusted to the point that the BER is degraded to $10E-5$.

The relationship between PER and BER is as follows. In order to get a good packet we need 8×1024 good bits. Stated mathematically. $1 - \text{PER} = (1 - \text{BER})^{(8 \times 24)}$. Or $\text{BER} = 1 - (1 - \text{PER})^{(1/(8 \times 1024))}$.

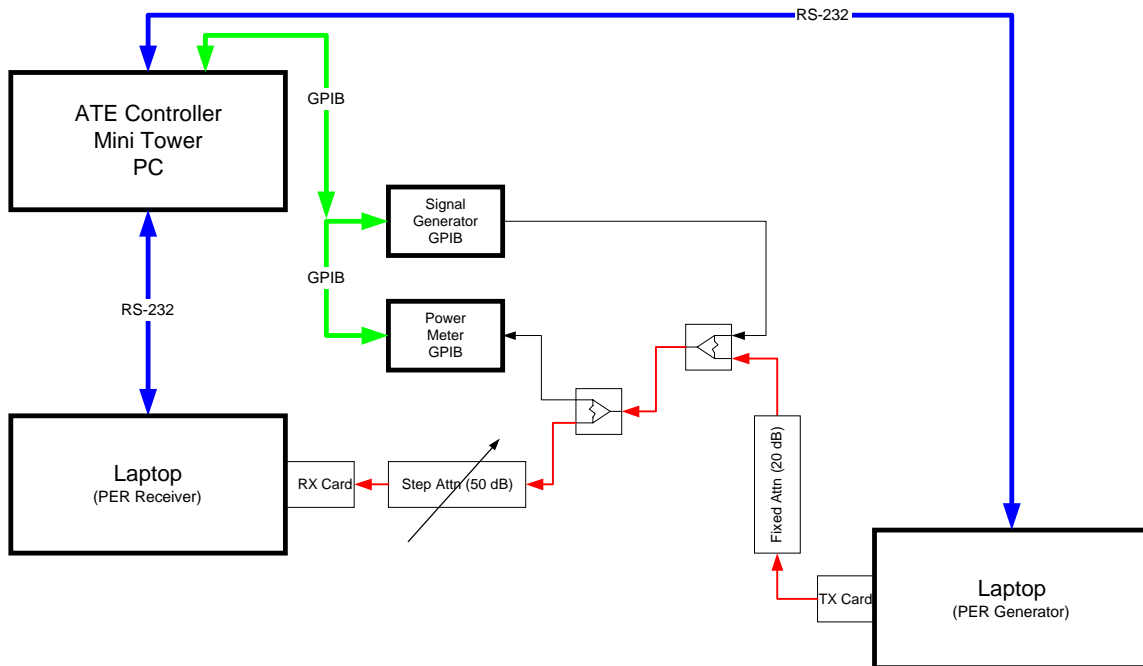

Jamming Margin Test Setup

The major blocks of the jamming margin test are a transmitter, a receiver, and a jammer. The TX card formats and transmits packets of data consisting of 1024 bytes

each. The RX card then attempts to read each packet. The Signal Generator provides the jamming signal. The splitters combine the TX and jammer signals and provide a port to measure the power levels within the RF link. The PER Generator Laptop controls the transmit card and the PER receiver laptop controls the receiver. The ATE PC automates the test by controlling the two laptops, the Signal Generator, and the power meter.

Software blocks

The key to this test is three software programs Packet Generator (PG), Packet Counter (PC), and Jam Margin Controller (JMC). The first two work together to form the PER measurement system and the last to control the jammer, the power meter, and the other two software blocks.

Packet Generator runs on the PG Laptop and controls the transmit card. A trigger on the serial port line commands the TX card to generate and transmit 1000 packets of 1024 bytes at a specified data rate.

Packet Counter runs on the PER receiver laptop and queries the RX card for the number of packets it has received. A trigger on the serial port causes the Packet Counter to report the number of packets to the ATE Controller and reset the Packet Counter to zero. The Packet counter automatically detects the data rate of the incoming packet stream.

The other Jamming Margin Controller (JMC) runs on the ATE PC and controls the Signal Generator, the Power Meter, and PGAC running on the Dual Slot laptop.

PG commands the TX card to transmit a set of 1000 packets of 1024 bytes of data. The RX card receives the packets and PC sends the number of good packets received to the serial port. The functional purpose is the same as a BER meter. A new set is run every time a new trigger is received on the serial port from JMC.

JMC controls the jammer, the power meter, and the Dual Slot program. JMC sets the frequency and level of the signal generator that acts as a jammer. JMC then sends a trigger to PG. The trigger causes PG to run another set of packets and PC reports the number of good packets back to JMC. The packet error rate is then converted to BER and JMC adjusts the Jammer level appropriately. A search algorithm is built into JMC to have the jammer converge to the right level for a $10E-5$ BER. The jammer resolution is .1 dB.

When the jammer level causes a BER of $10E-5$, the JMC program turns off the TX card and commands the power meter to read the jammer power level. JMC then turns off the jammer, turns on the TX card, and measures its power. Then S is offset for duty cycle and J/S is calculated from the two power measurements and recorded to disk. In this way as the test progresses and the TX card warms up power fluctuations due to temperature are referenced out.

The test is then repeated at the next jammer frequency. In this instance the test is conducted across the band of a single channel at 50KHz steps.

Data Rate and Modulation Description

Modulation Technique and Data rates

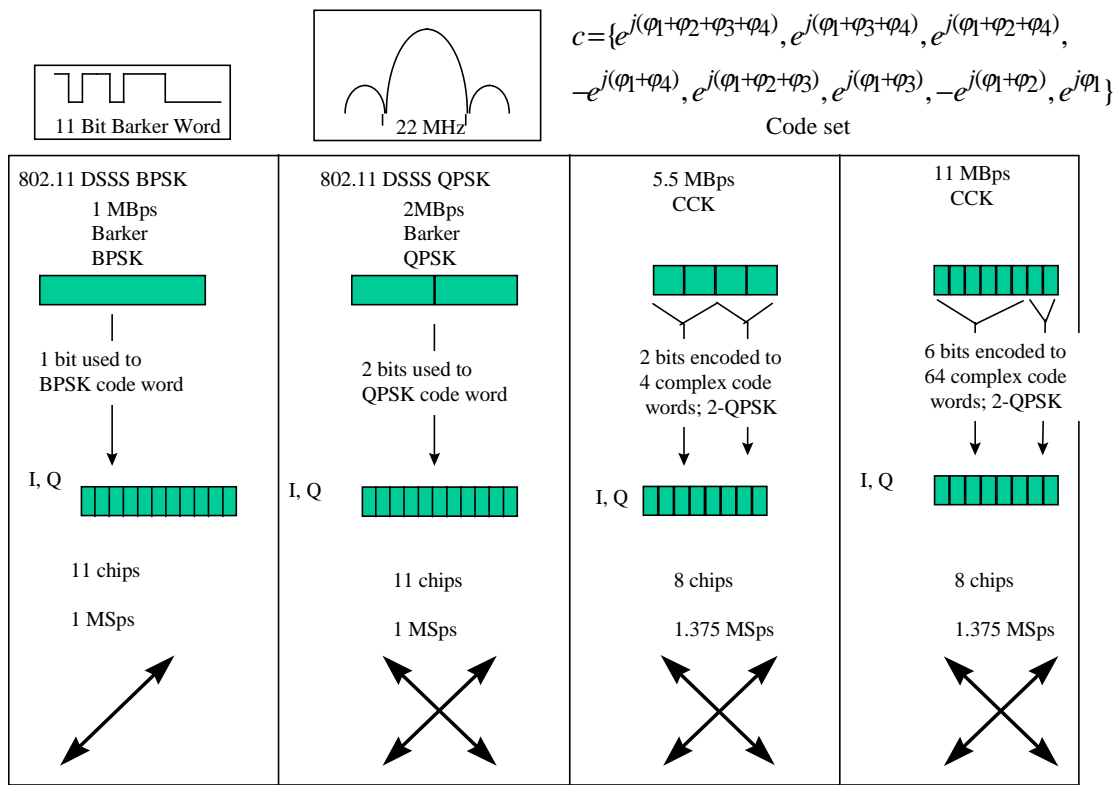

Mode	Chip/Symbol
1 MBps	11/1
2 MBps	11/2
5.5 MBps	8/2
11 MBps	8/8

Gp Calculation from J/S data

$$G_p = E_b/N_0 + J/S + L_{sys} \quad \text{Where } L_{sys} \leq 2 \text{ dB}$$

Mbps	E_b/N_0 (dB)	$G_p = J/S +$
1	10.6	12.6
2	10.6	12.6
5.5	15.6	17.6
11	16.6	18.6

Test Results

Attached are two plots of J/S and G_p vs F in MHz for 11 Mbps and 2 Mbps. The two plots are the worst case modes for each chipping rate. Theoretical calculations are given for the 1 and 5.5 Mbps modes.

The lower line shows the J/S as taken from the power ratios measured with the power meter. The upper line shows the processing gain G_p as calculated from the Jamming Margin data. Note that the lowest 20% of the data points were discarded as specified in 15.247 (e)(2).

Theoretical calculations

1 Mbps mode using BPSK

The processing gain is defined by:

$$PG = W_{ss}/R_b$$

W_{ss} is the bandwidth (11.2 MHz min).
 R_b is the data rate (1 Mbps)

$$\begin{aligned} PG &= 11.2 \text{ MHz}/1 \text{ Mbps} \\ &= 11.2 \\ &= 10\log_{10}(11.2) \\ &= 10.49 \text{ dB} \end{aligned}$$

5.5 Mbps mode using CCK

The processing gain is defined by:

$$PG = \text{BW reduction} + \text{Coding Gain}$$

$$\text{BW reduction} = \frac{\text{Chip Rate}}{\text{Symbol Rate}}$$

$$\begin{aligned} &= 10\log_{10}(11 \text{ MCps}/1.375 \\ &\quad \text{MSps}) \\ &= 9.03 \text{ dB} \end{aligned}$$

Coding Gain

$$\begin{aligned} &= 1.7 @ 11 \text{ Mbps} \\ &= 2.0 @ 5.5 \text{ Mbps} \end{aligned}$$

$$\begin{aligned} PG &= 9.03 + 2.0 \\ &= 11.03 \text{ dB} \end{aligned}$$

¹ Simon Omura, Scholtz, and Levitt *Spread Spectrum Communications Handbook* (New York: McGraw Hill, 1994), p. 138
LA-4121 Processing Gain Calculations

Results Table

Mode (Mbps)	Gp (dB)
1	10.49
2	10.13
5.5	11.03
11	11.39





Read from JS File.vi
Path: .\LabView\Project\Jamming\Read from JS File.vi
Last modified on 4/13/00 at 1:43 PM
Printed on 4/13/00 at 2:04 PM

File T2-11 Run 1 80 dB Attn.dat

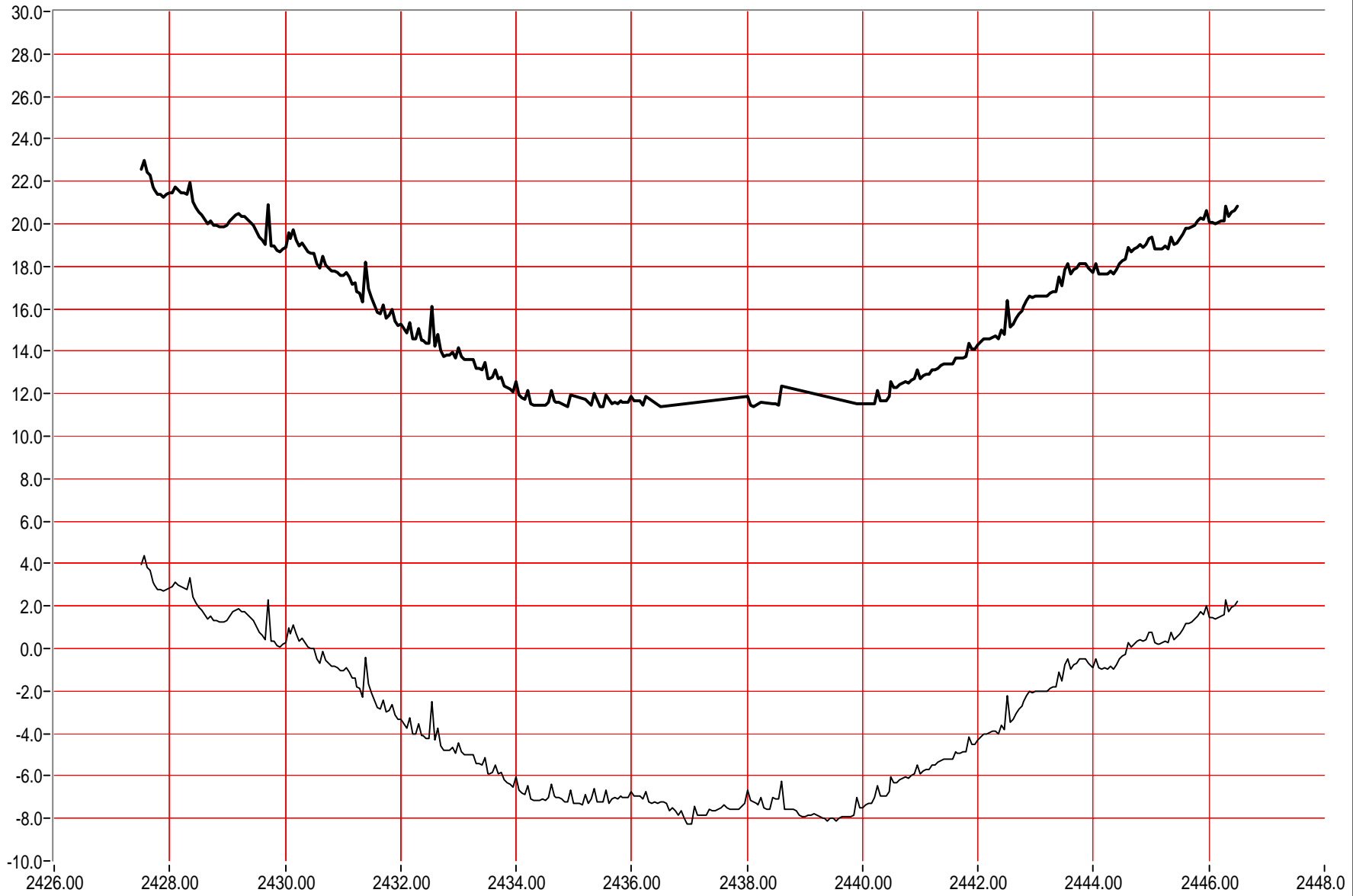
LA-4121 Processing Gain Plot: 11 Mbps



min value MHz Gp
 2434.90 11.39

Raw J/S 
Gp 

Gp Offset





Read from JS File.vi
Path: .\LabView\Project\Jamming\Read from JS File.vi
Last modified on 4/13/00 at 1:43 PM
Printed on 4/14/00 at 10:05 AM

File T2-2.dat

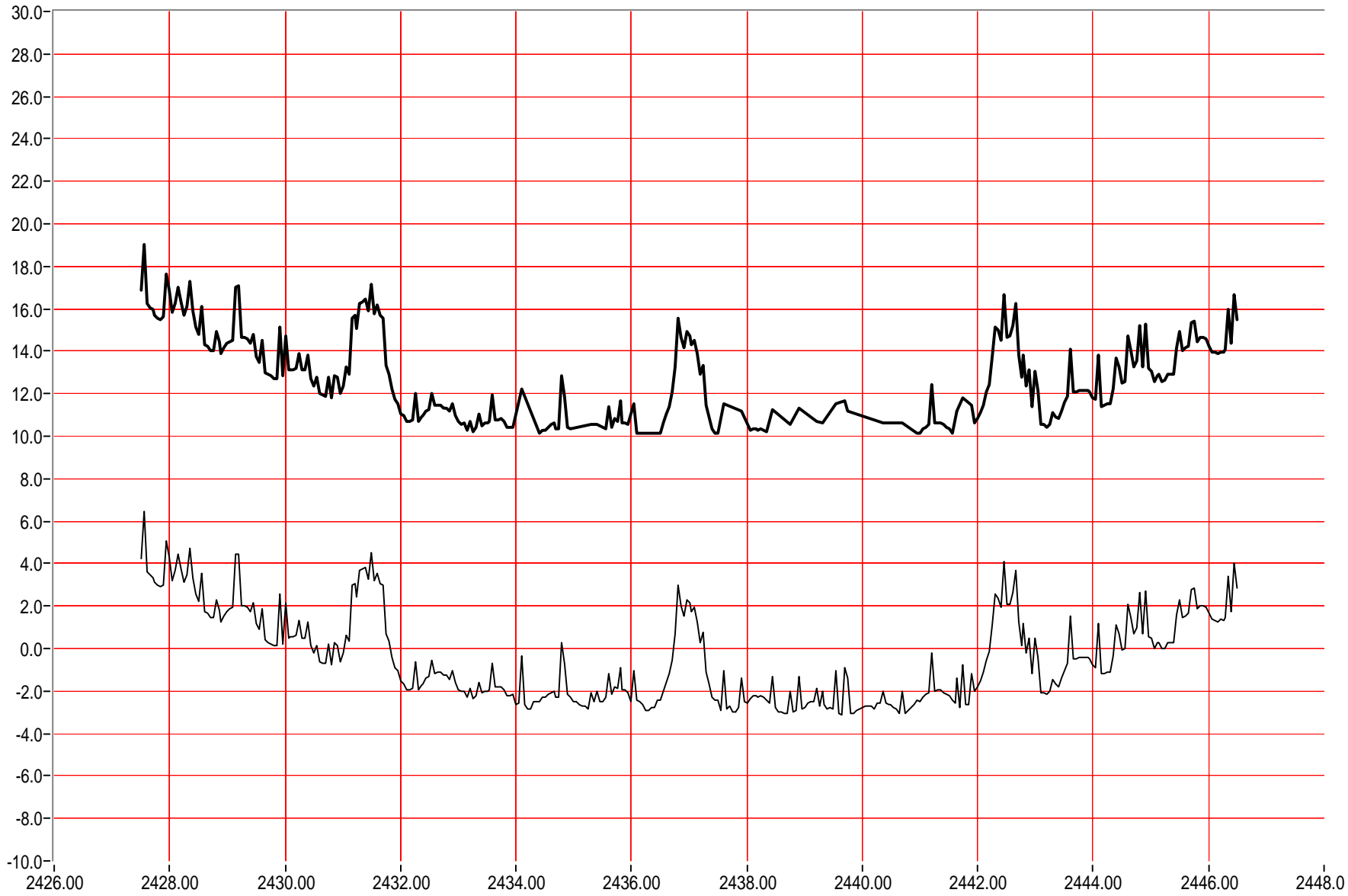
LA-4121 Processing Gain Plot: 2 Mbps



min value MHz Gp
 2441.00 10.13

Raw J/S 
Gp 

Gp Offset

Plot 2.2

MKR Δ 11.58 MHz
-0.50 dB

hp REF 10.0 dBm

ATTEN 20 dB

10 dB/

DL
2.6
dBm

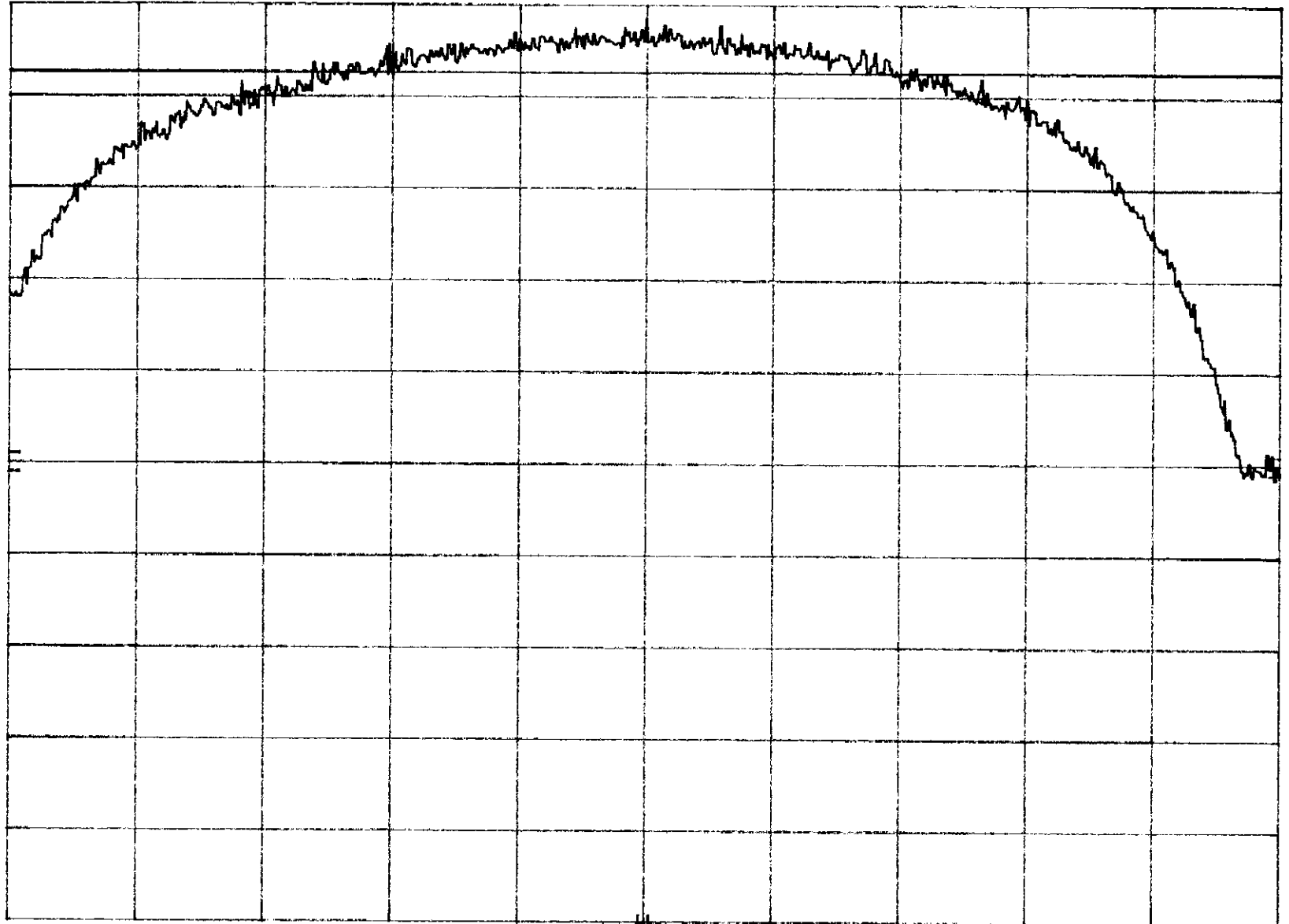

CENTER 2.412 8 GHz

RES BW 100 kHz

VBW 100 kHz

SPAN 20.0 MHz

SWP 20.0 msec

SYMBOL 4121 MID-BAND

Plot 2.6

MKR Δ 9.76 MHz

hp

REF 10.0 dBm ATTEN 20 dB

-0.30 dB

10 dB/

DL
0.1
dBm

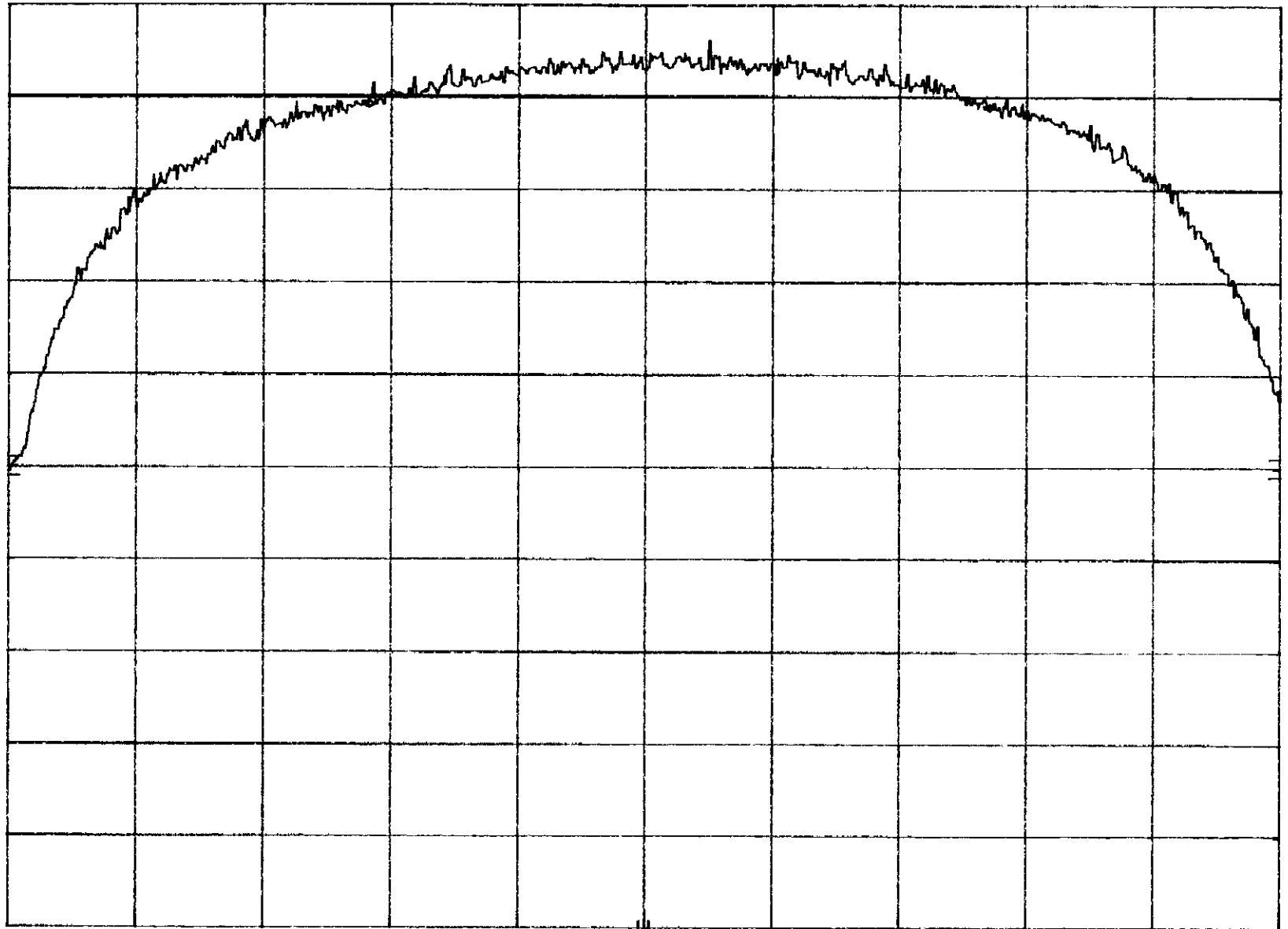

CENTER 2.437 0 GHz

RES BW 100 kHz

VBW 100 kHz

SPAN 20.0 MHz

SWP 20.0 msec

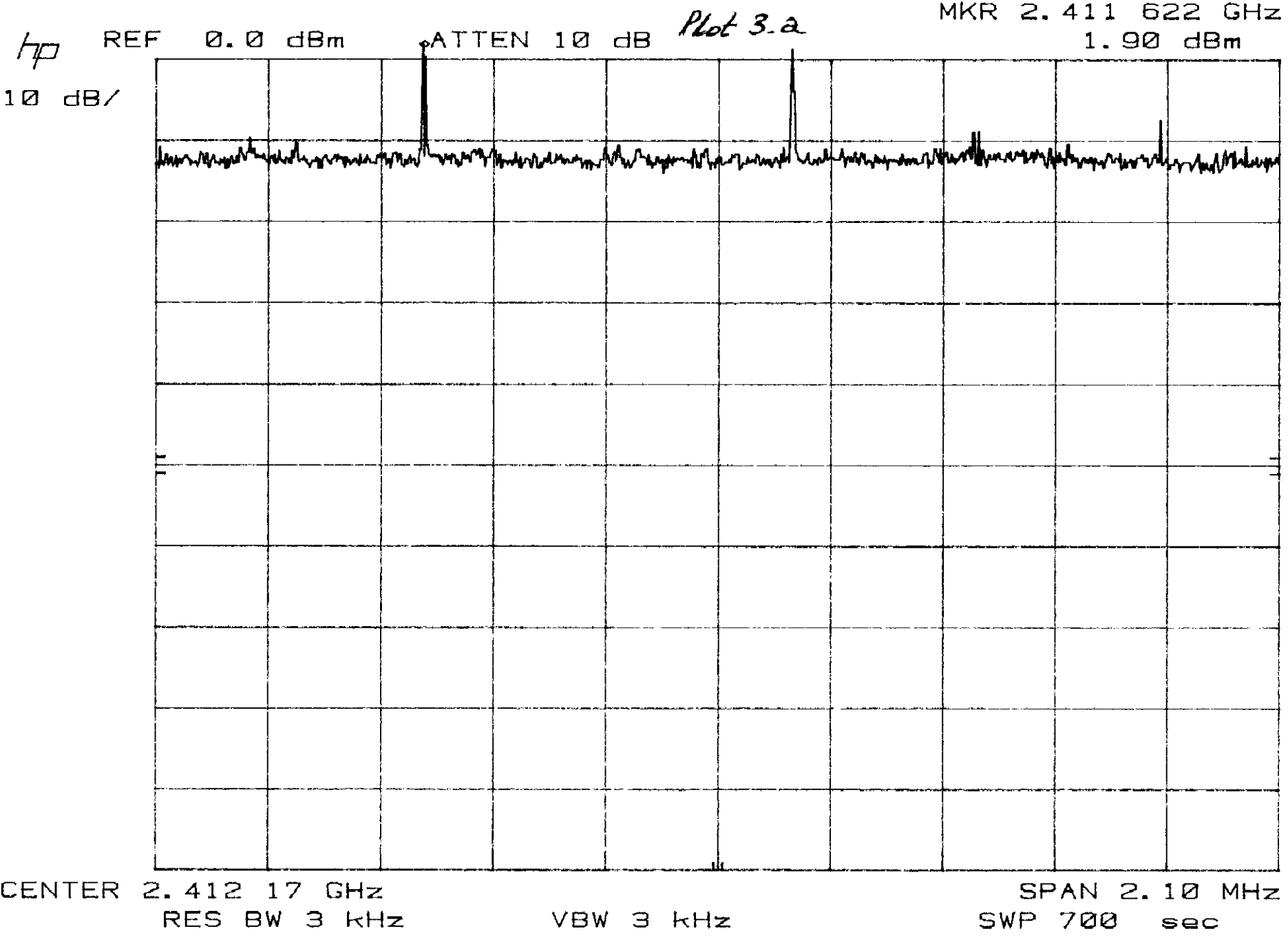

SYMMBOL 4121 MID-BAND

Plot 3.6

MKR 2.437 887 GHz

hp

REF 10.0 dBm

ATTEN 20 dB

-8.80 dBm

10 dB/

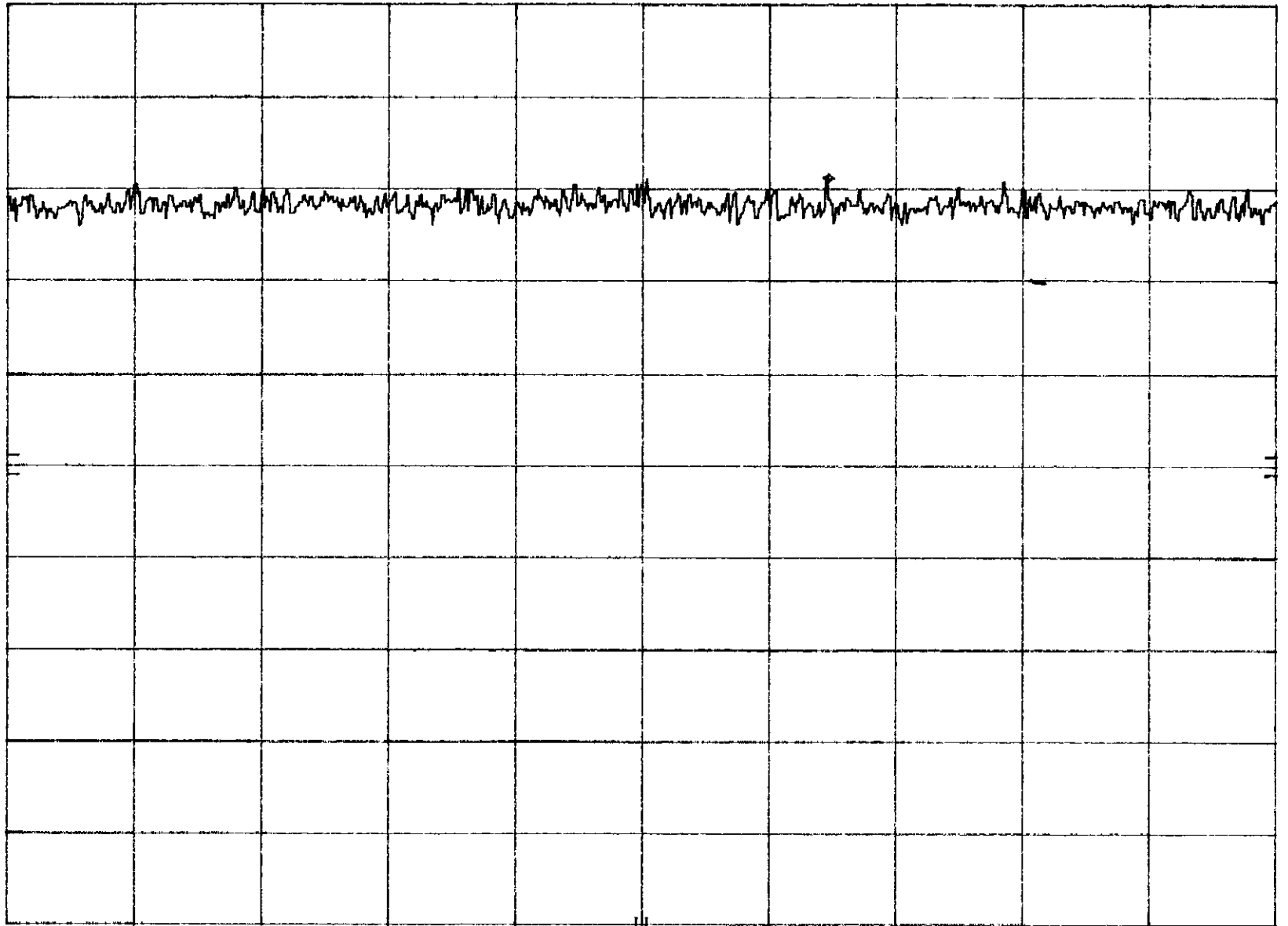

CENTER 2.437 58 GHz

RES BW 3 kHz

VBW 3 kHz

SPAN 2.10 MHz

SWP 700 sec

hp REF 10.0 dBm ATTEN 20 dB *Plot 3.c* MKR 2.462 883 GHz
-8.70 dBm

10 dB/

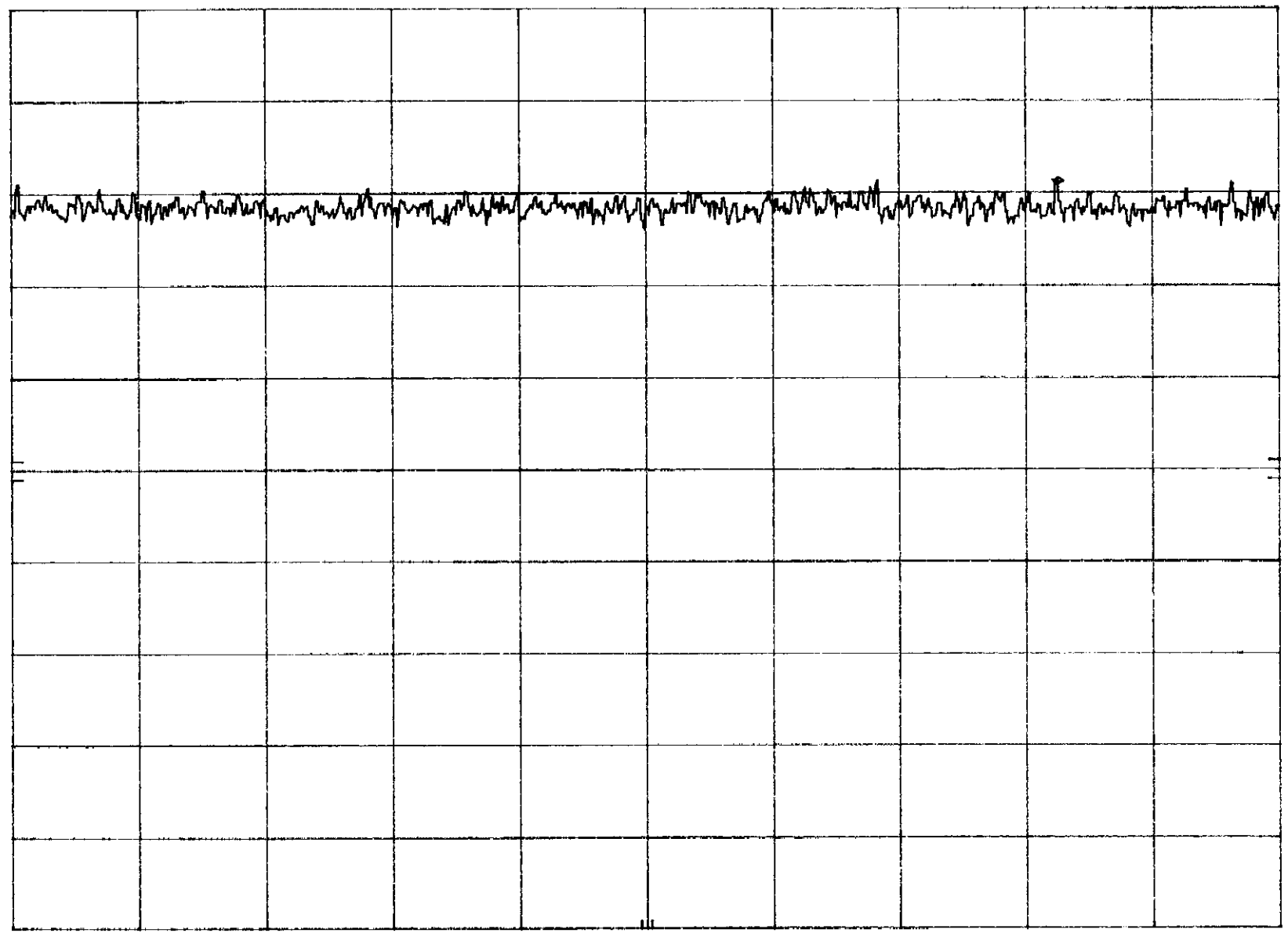

CENTER 2.462 20 GHz SPAN 2.10 MHz
RES BW 3 kHz VBW 3 kHz SWP 700 sec

Plot 4.21

SYMBOL 4121 LO-BAND

MKR 10.80 MHz

hp

REF 10.0 dBm ATTEN 20 dB

-41.20 dBm

10 dB/

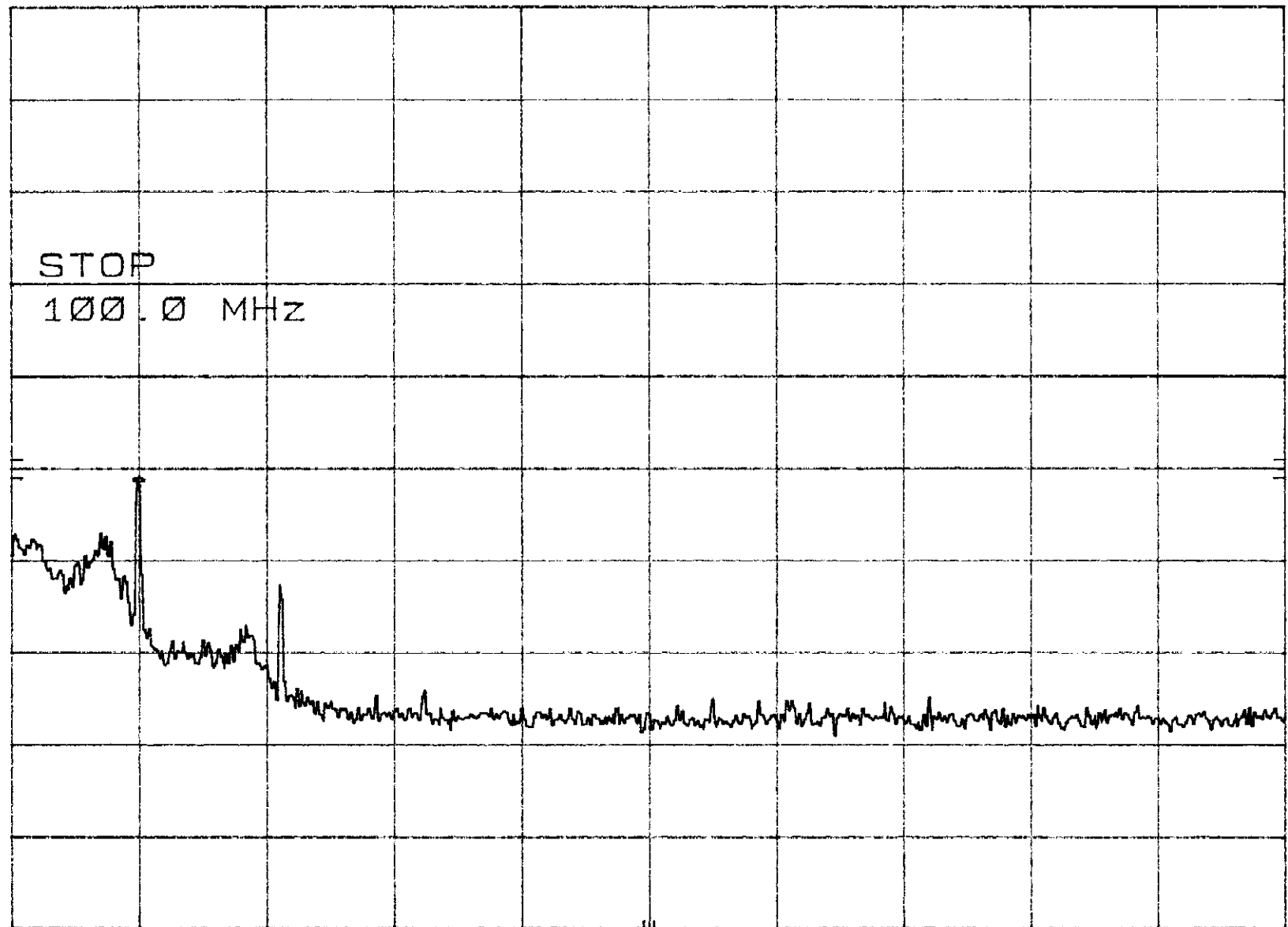

START 1.0 MHz

STOP 100.0 MHz

RES BW 100 kHz

VBW 100 kHz

SWP 29.7 msec

SYMBOL 4121 LO-BAND

Plot 4.22

MKR 602.2 MHz

hp

REF 10.0 dBm

ATTEN 20 dB

-45.00 dBm

10 dB/

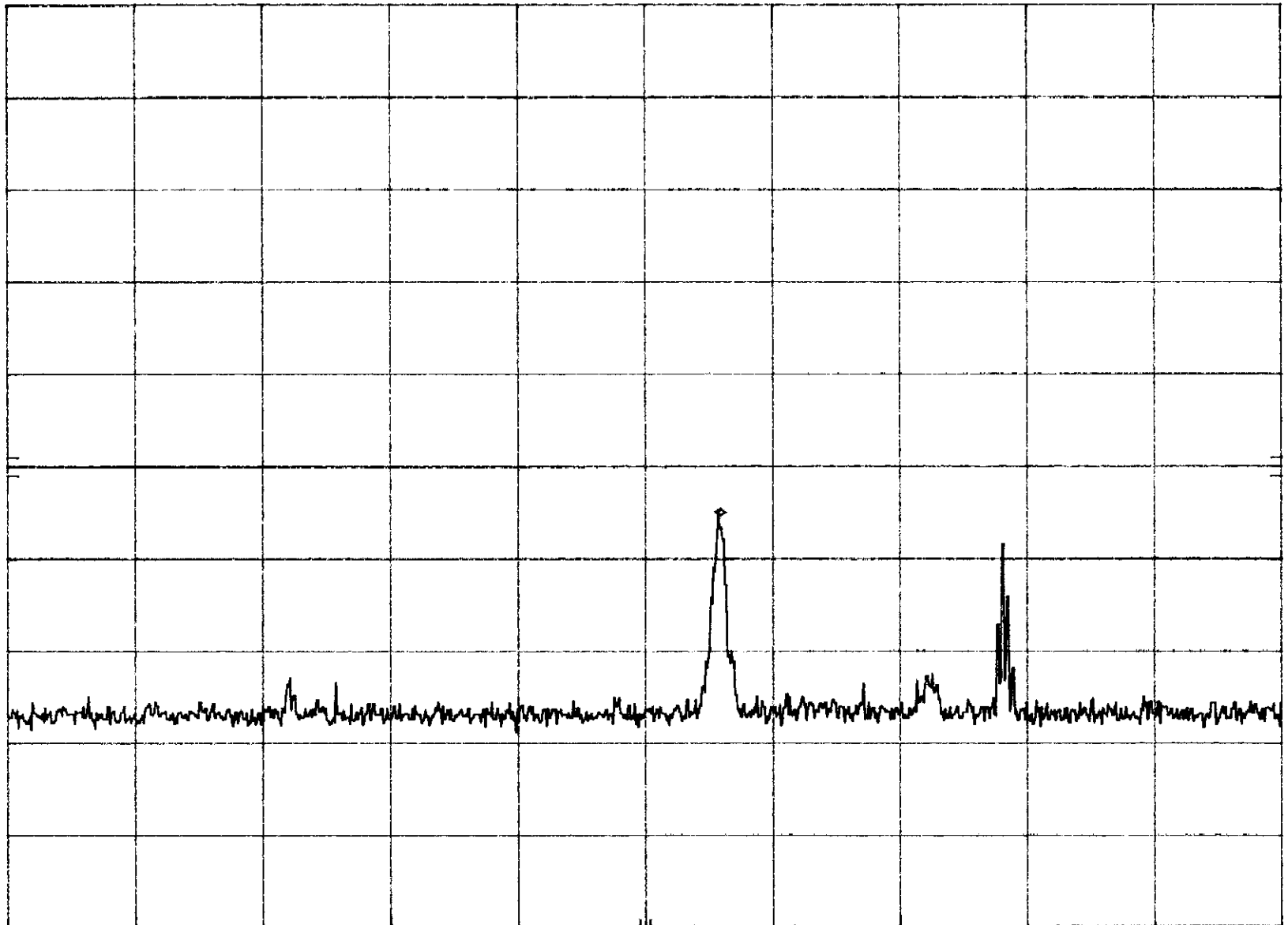

START 100 MHz

RES BW 100 kHz

VBW 100 kHz

STOP 1.000 GHz

SWP 270 msec

SYMBOL 4121 LO-BAND

Plot 4.23

MKR 1.809 GHz

hp

REF 10.0 dBm ATTEN 20 dB

-43.40 dBm

10 dB/

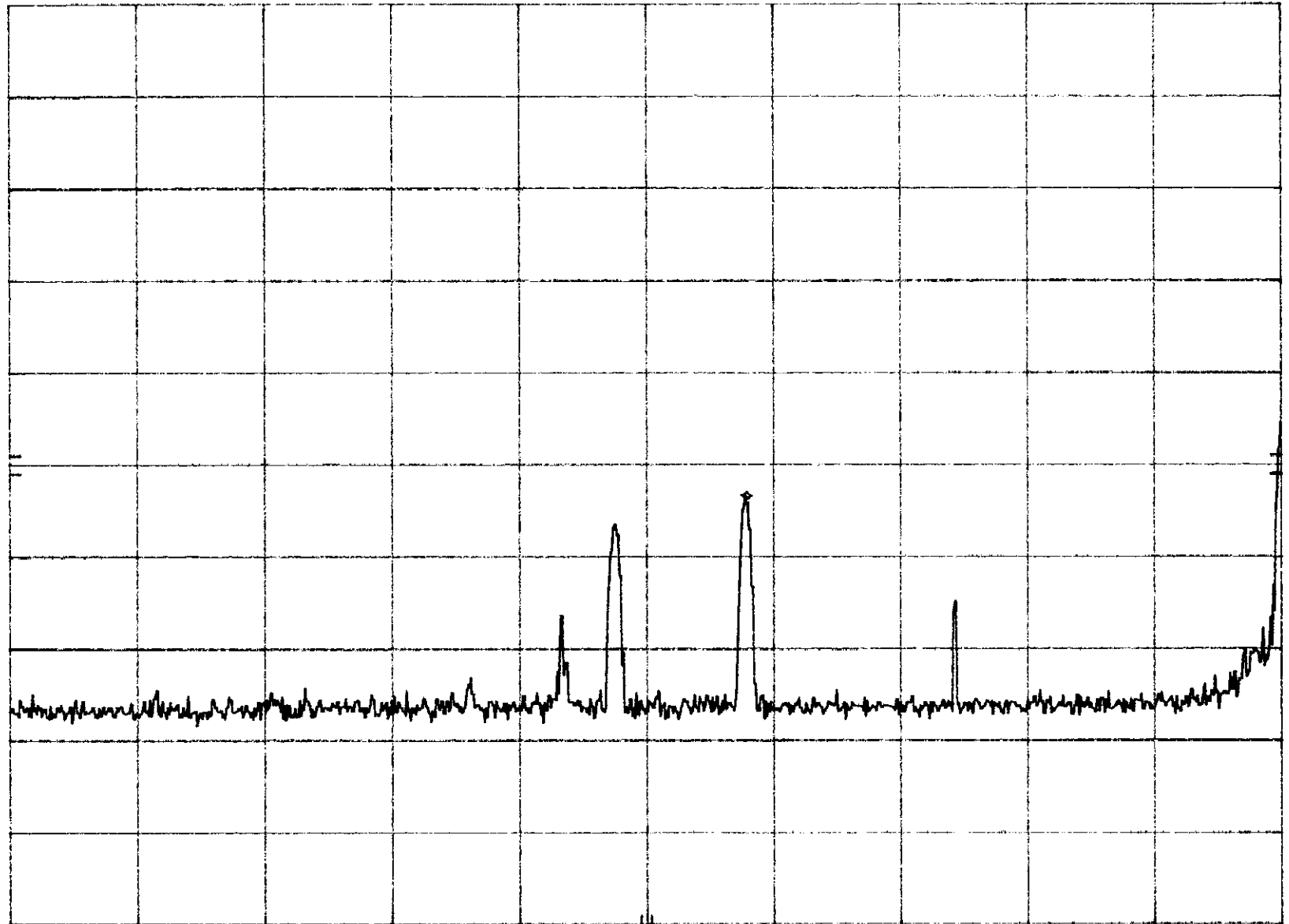

START 1.00 GHz

RES BW 100 KHz

VBW 100 KHz

STOP 2.40 GHz

SWP 420 msec

SYMBOL 4121 LO-BAND

Plot 4. a 4

MKR 2.412 86 GHz

hp

REF 10.0 dBm

ATTEN 20 dB

8.40 dBm

10 dB/

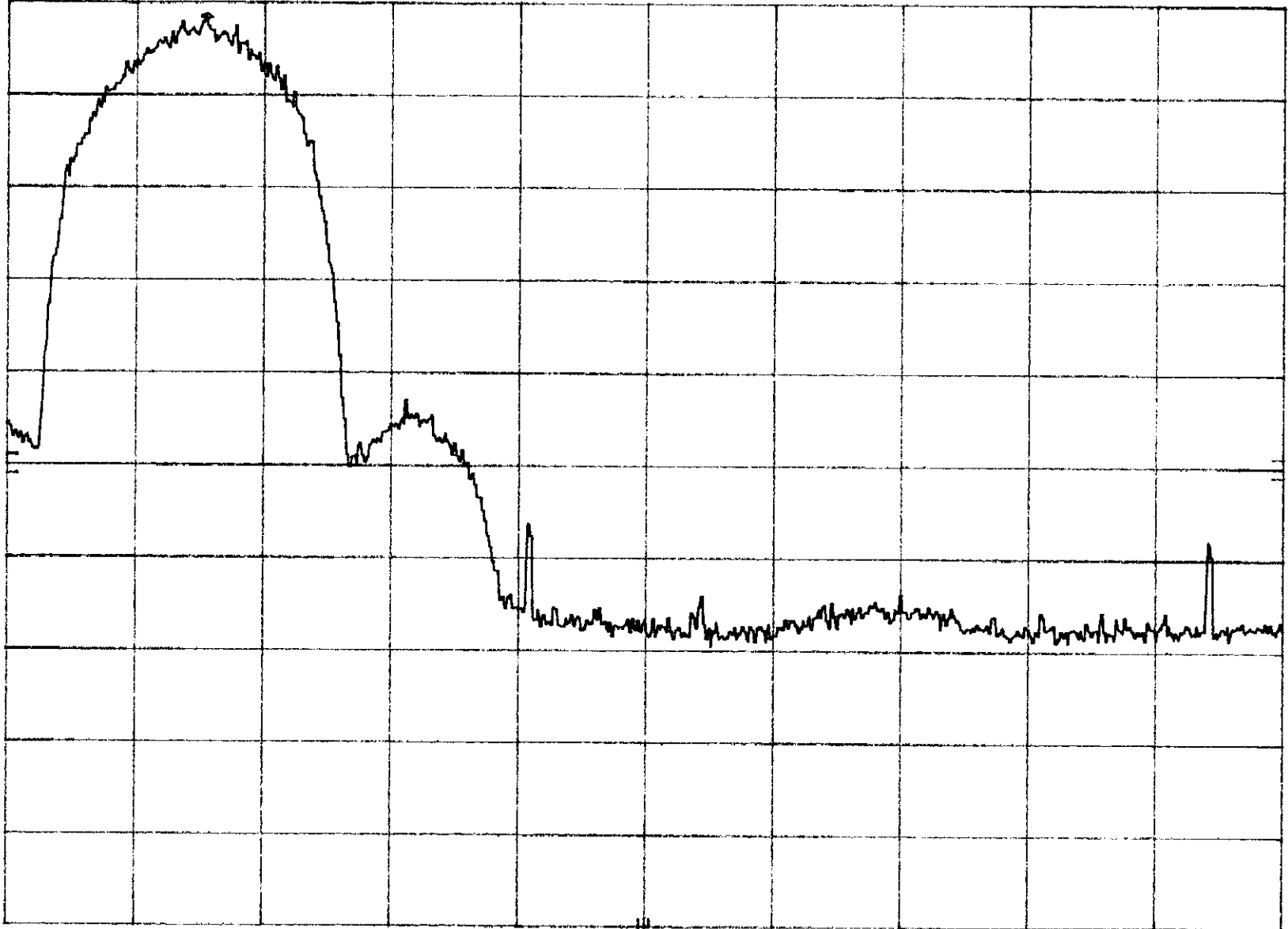

START 2.400 0 GHz

RES BW 100 KHz

VBW 100 KHz

STOP 2.483 5 GHz

SWP 25.1 msec

SYMBOL 4121 LO-BAND

Plot 4.26

MKR 23.68 GHz

hp

REF 10.0 dBm ATTEN 20 dB

-44.30 dBm

10 dB/

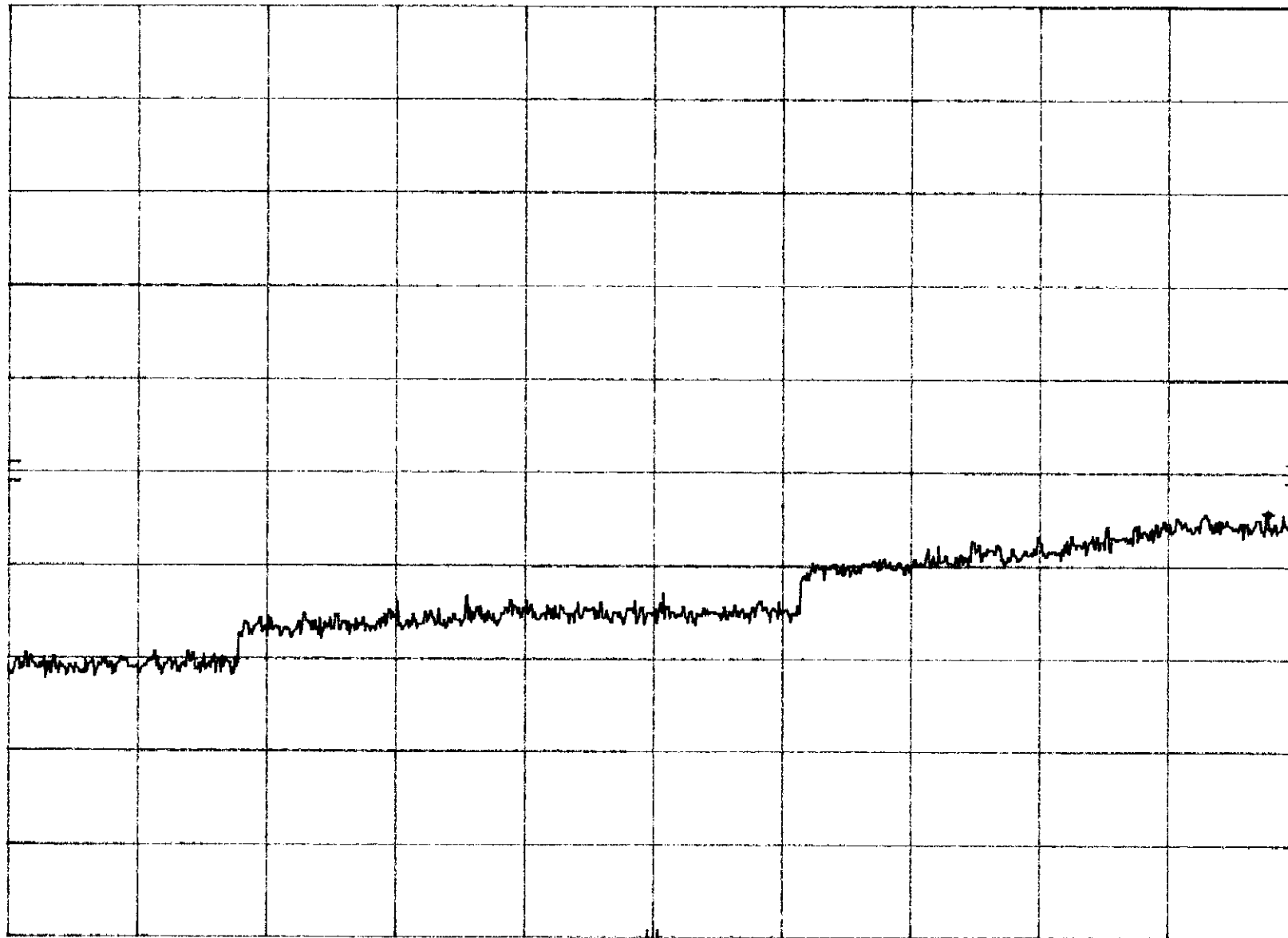

START 10.0 GHz

RES BW 100 KHz

VBW 100 KHz

STOP 24.0 GHz

SWP 4.20 sec

SYMBOL 4121 MID-BAND
REF 10.0 dBm ATTEN 20 dB

Plot 4. b1

MKR 11.00 MHz
-48.90 dBm

hp
10 dB/

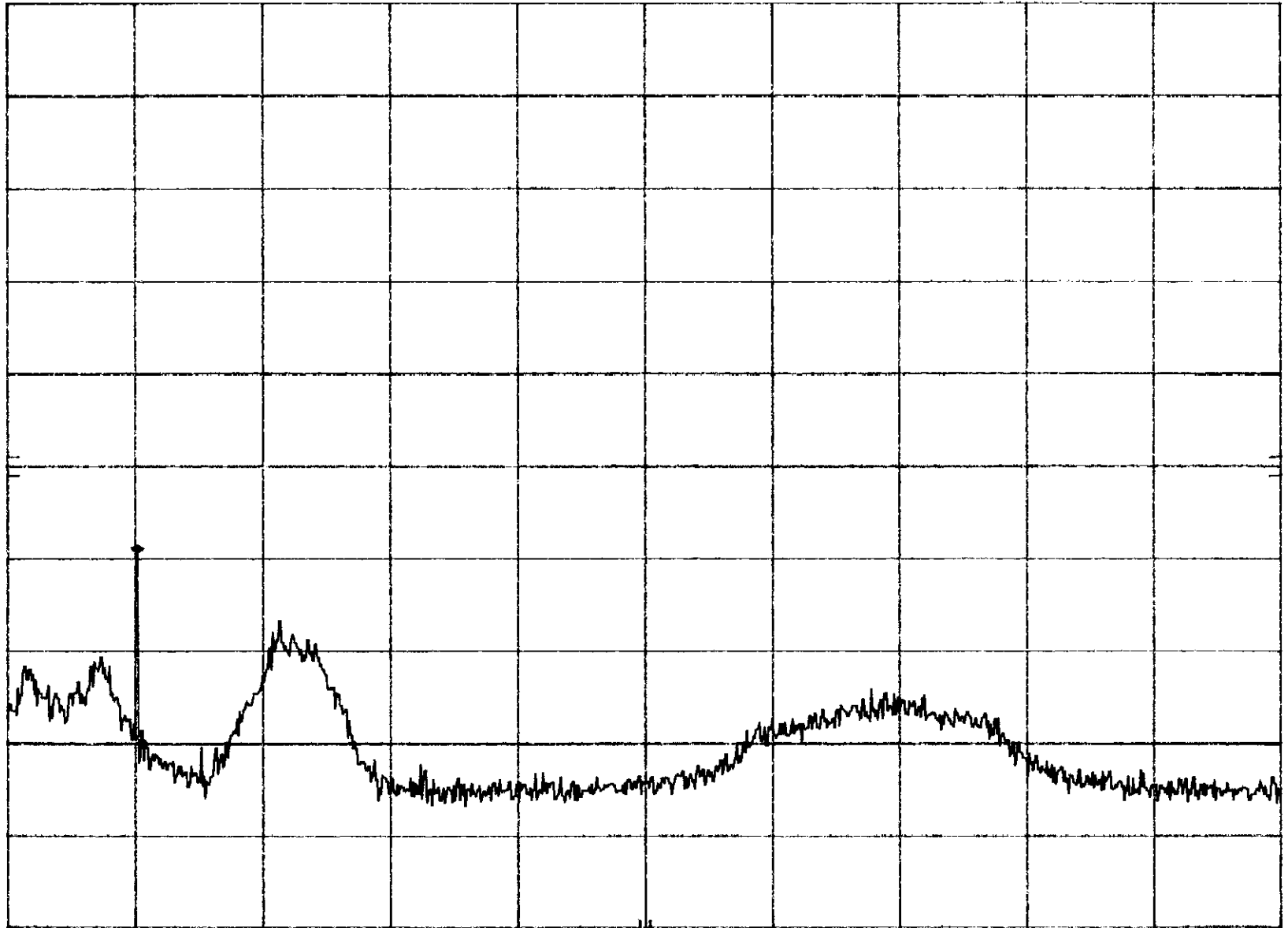

START 1.0 MHz

RES BW 30 KHz

VBW 30 KHz

STOP 100.0 MHz

SWP 297 msec

SYMBOL 4121 MID-BAND
REF 10.0 dBm ATTEN 20 dB

Plot 4. b 2

MKR 628.3 MHz
-49.00 dBm

hp
10 dB/

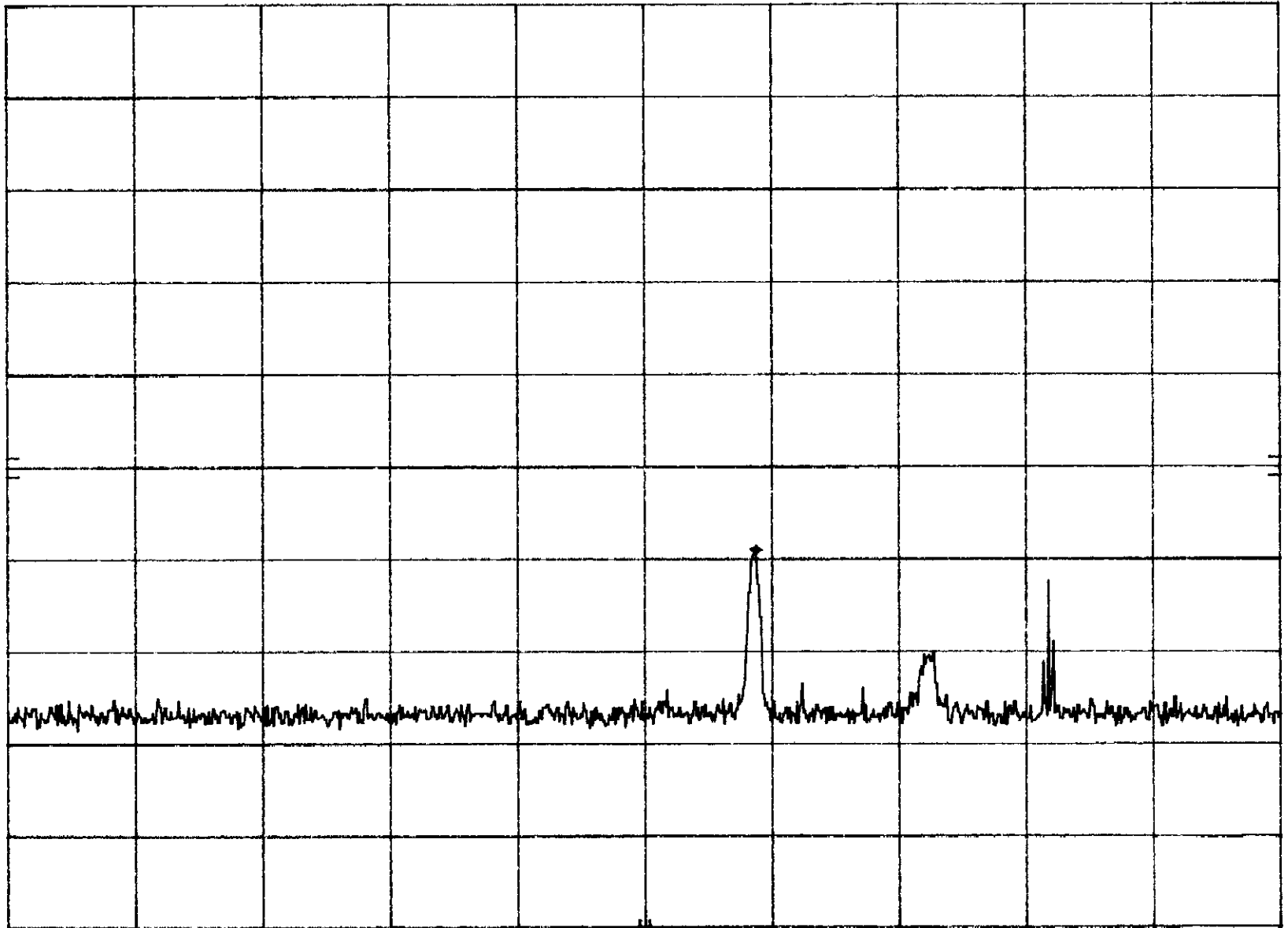

START 100 MHz

RES BW 100 KHz

VBW 100 KHz

STOP 1.000 GHz

SWP 270 msec

SYMBOL 4121 MID-BAND
REF 10.0 dBm ATTEN 20 dB

Plot 4. b 3

MKR 1.689 GHz
-46.40 dBm

hp
10 dB/

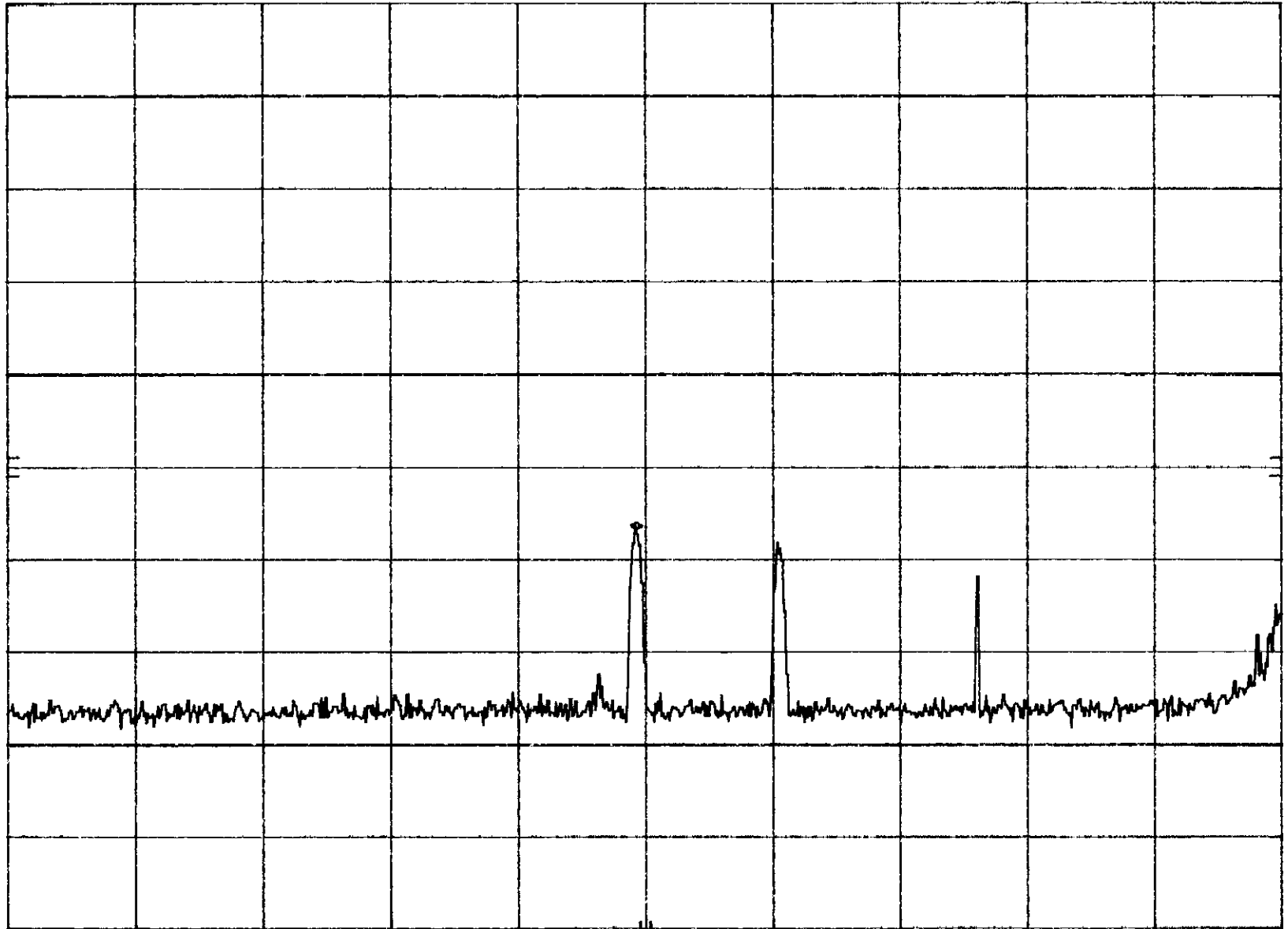

START 1.00 GHz

RES BW 100 KHz

VBW 100 KHz

STOP 2.40 GHz

SWP 420 msec

SYMMBOL 4121 MID-BAND

Plot 4.54

MKR 2.436 66 GHz

hp

REF 10.0 dBm ATTEN 20 dB

5.90 dBm

10 dB/



START 2.400 0 GHz

RES BW 100 kHz

VBW 100 kHz

STOP 2.483 5 GHz

SWP 25.1 msec

SYMBOL 4121 MID-BAND
REF 10.0 dBm ATTEN 20 dB

Plot 4.65

MKR 2.480 GHz
-54.60 dBm

hp
10 dB/

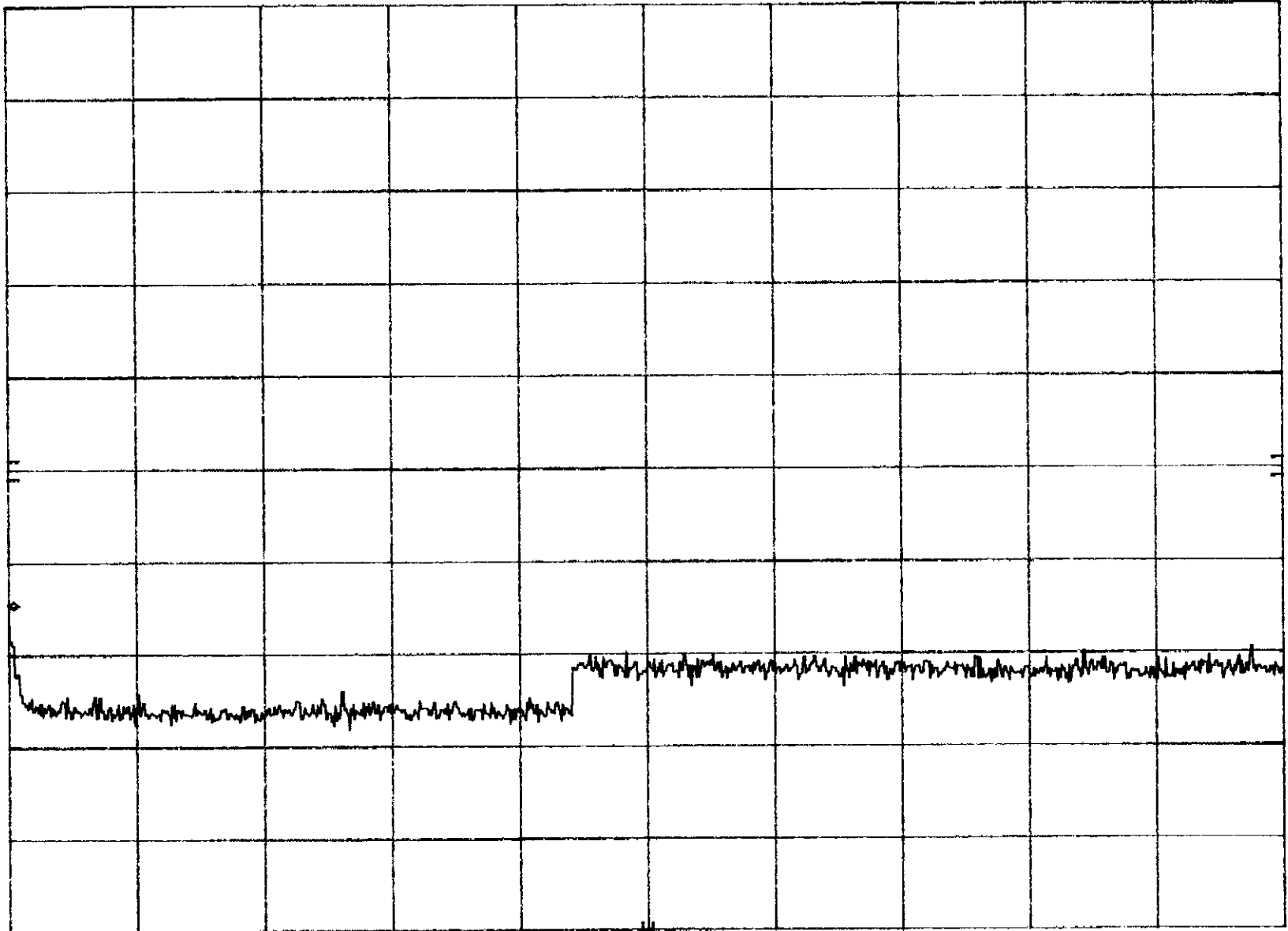

START 2.48 GHz

RES BW 100 KHZ

VBW 100 KHZ

STOP 10.00 GHz

SWP 2.26 sec

SYMBOL 4121 MID-BAND
REF 10.0 dBm ATTEN 20 dB

Plot 4.66

MKR 23.02 GHz
-43.70 dBm

hp
10 dB/

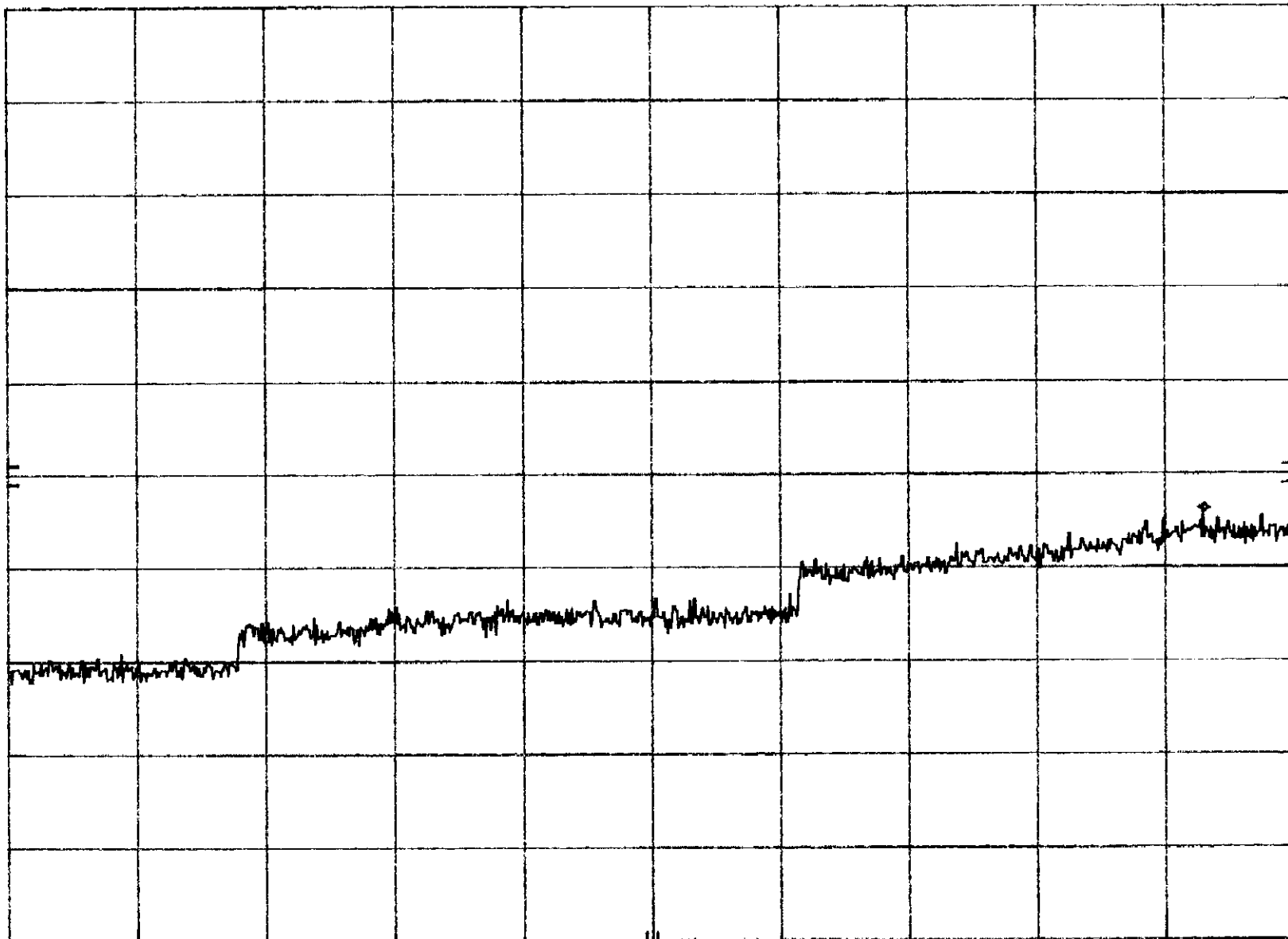

START 10.0 GHz

RES BW 100 KHz

VBW 100 KHz

STOP 24.0 GHz

SWP 4.20 sec

SYMBOL. 4121 HI-BAND *Plot 4.c1*
REF 10.0 dBm ATTEN 20 dB

MKR 11.00 MHz
-45.90 dBm

hp
10 dB/

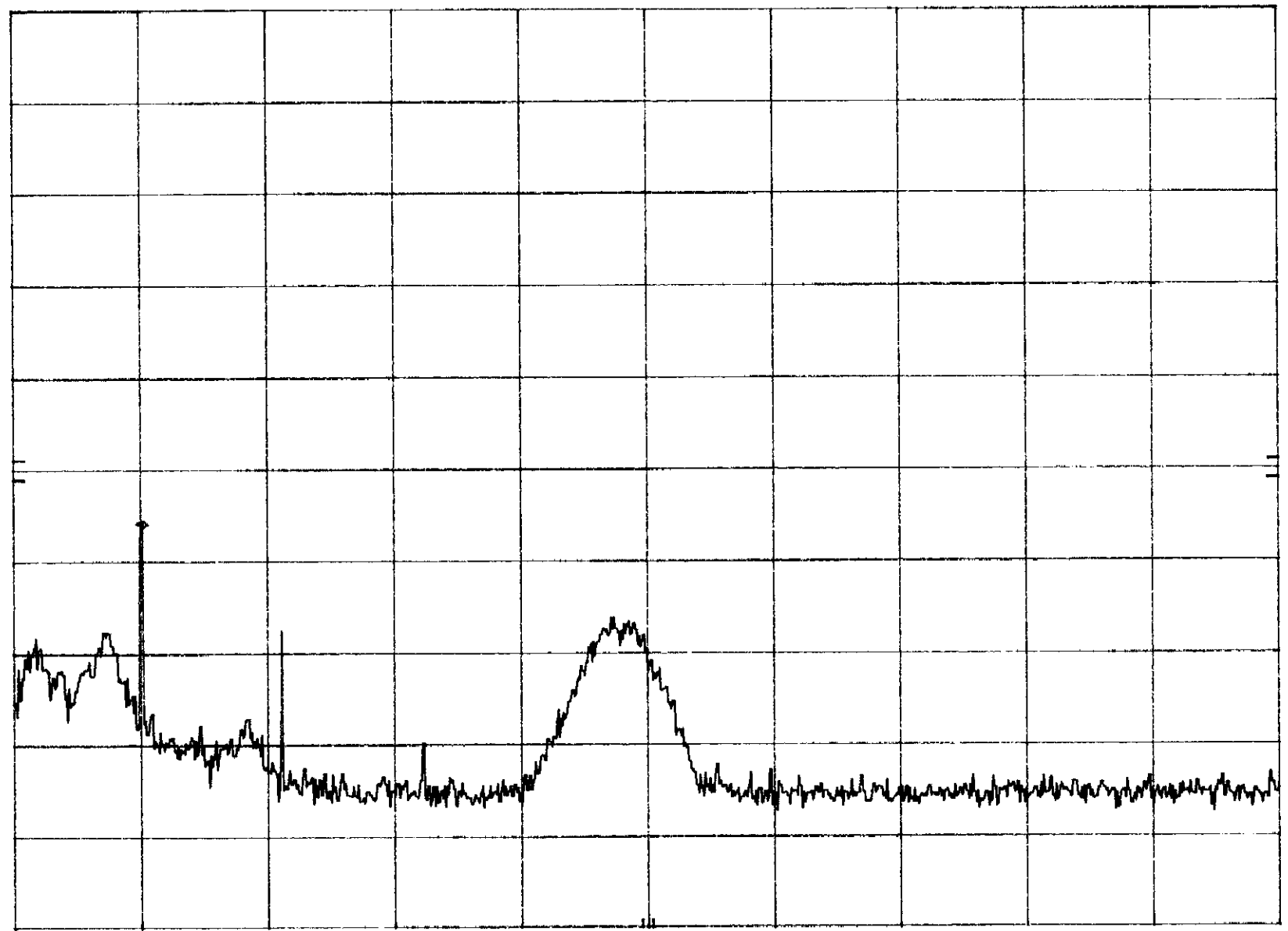

START 1.0 MHz RES BW 30 kHz VBW 30 kHz STOP 100.0 MHz
SWP 297 msec

SYMBOL. 4121 HI-BAND
REF 10.0 dBm ATTEN 20 dB

Plot 4.c 2

MKR 869.5 MHz
-43.70 dBm

hp
10 dB/

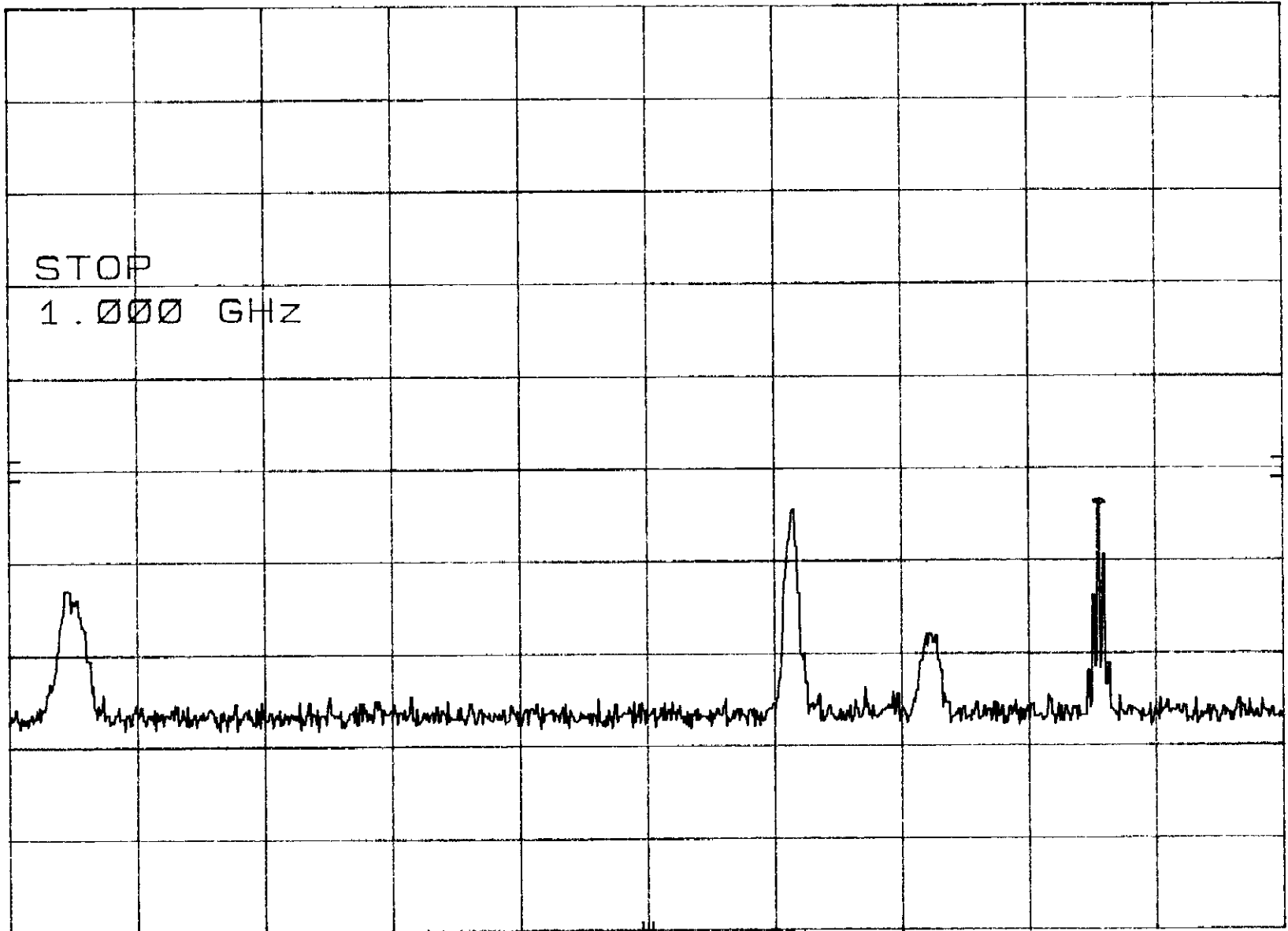

START 100 MHz

RES BW 100 kHz

VBW 100 kHz

STOP 1.000 GHz
SWP 270 msec

SYMBOL, 4121 HI-BAND
REF 10.0 dBm ATTEN 20 dB

Plot 4.c3

MKR 1.714 GHz
-43.80 dBm

hp
10 dB/

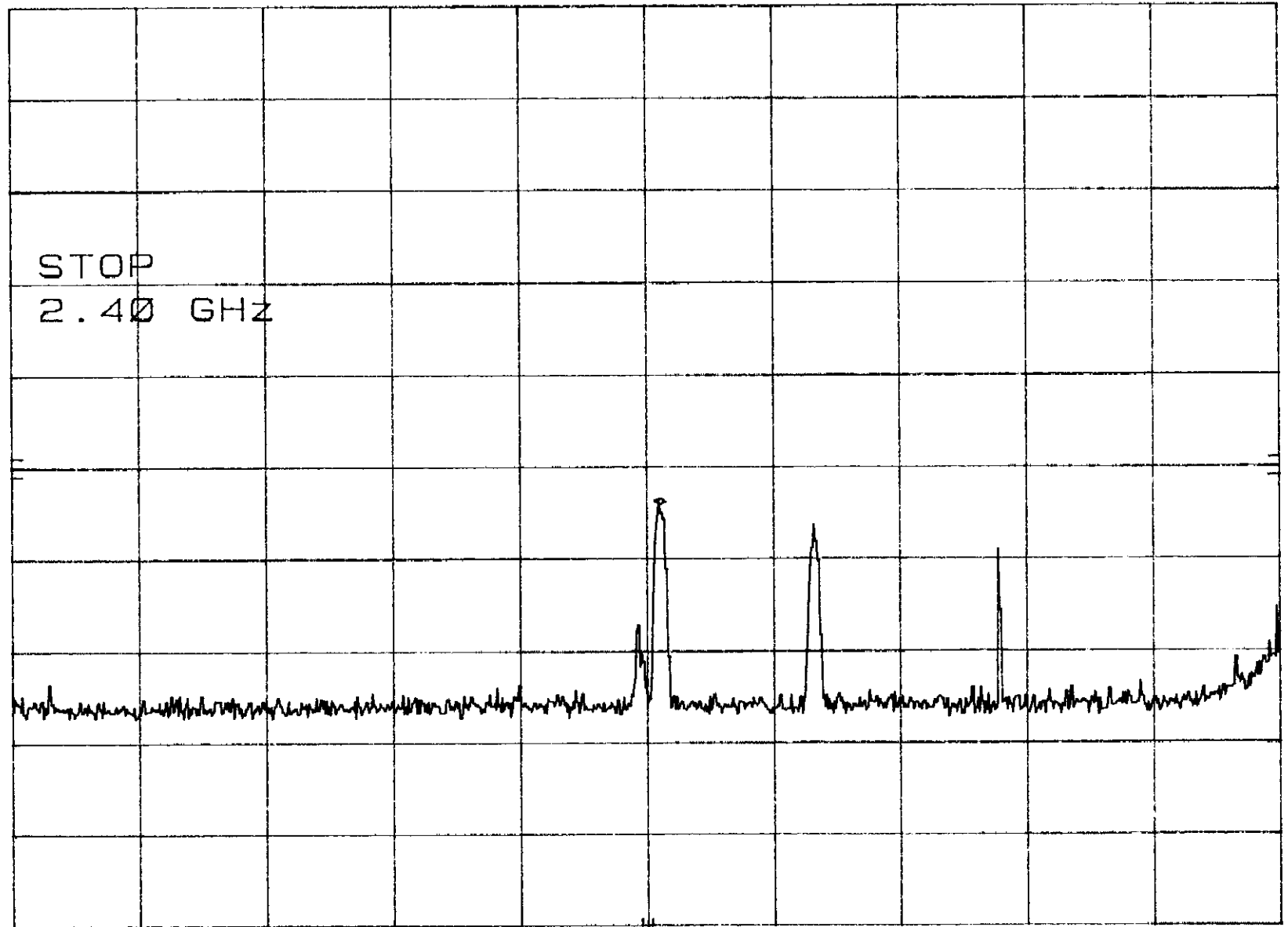

START 1.00 GHz

RES BW 100 KHz

VBW 100 KHz

STOP 2.40 GHz
SWP 420 msec

SYMBOL. 4121-
REF 10.0 dBm

ATTEN 20 dB

Plot Y.C.Y

MKR 2.464 63 GHz
5.80 dBm

hp
10 dB/

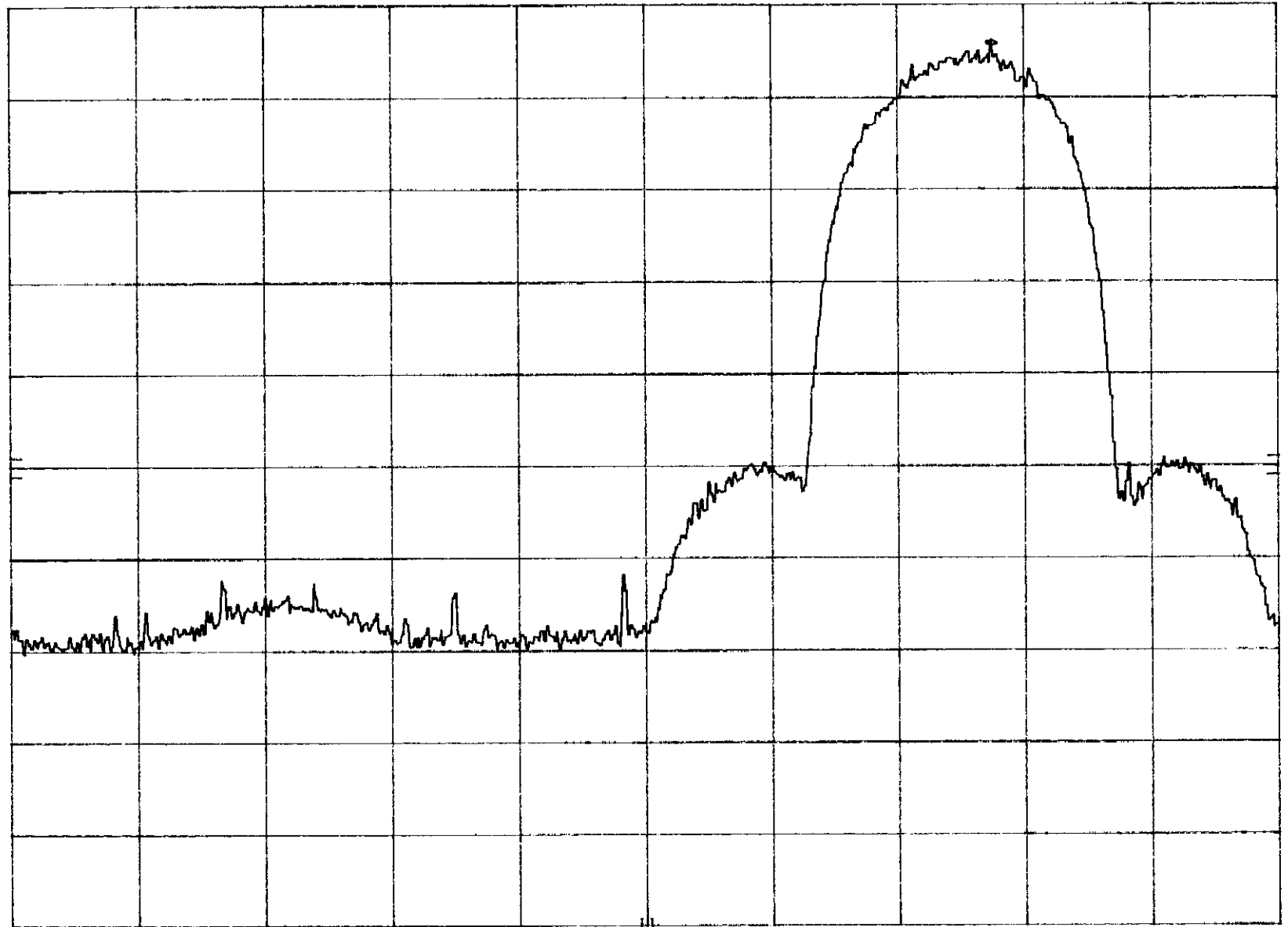

START 2.400 0 GHz

RES BW 100 KHz

VBW 100 KHz

STOP 2.483 5 GHz

SWP 25.1 msec

SYMBOL. 4121 HI-BAND
REF 10.0 dBm ATTEN 20 dB

Plot 4.c5

MKR 2.484 GHz
-51.20 dBm

hp
10 dB/

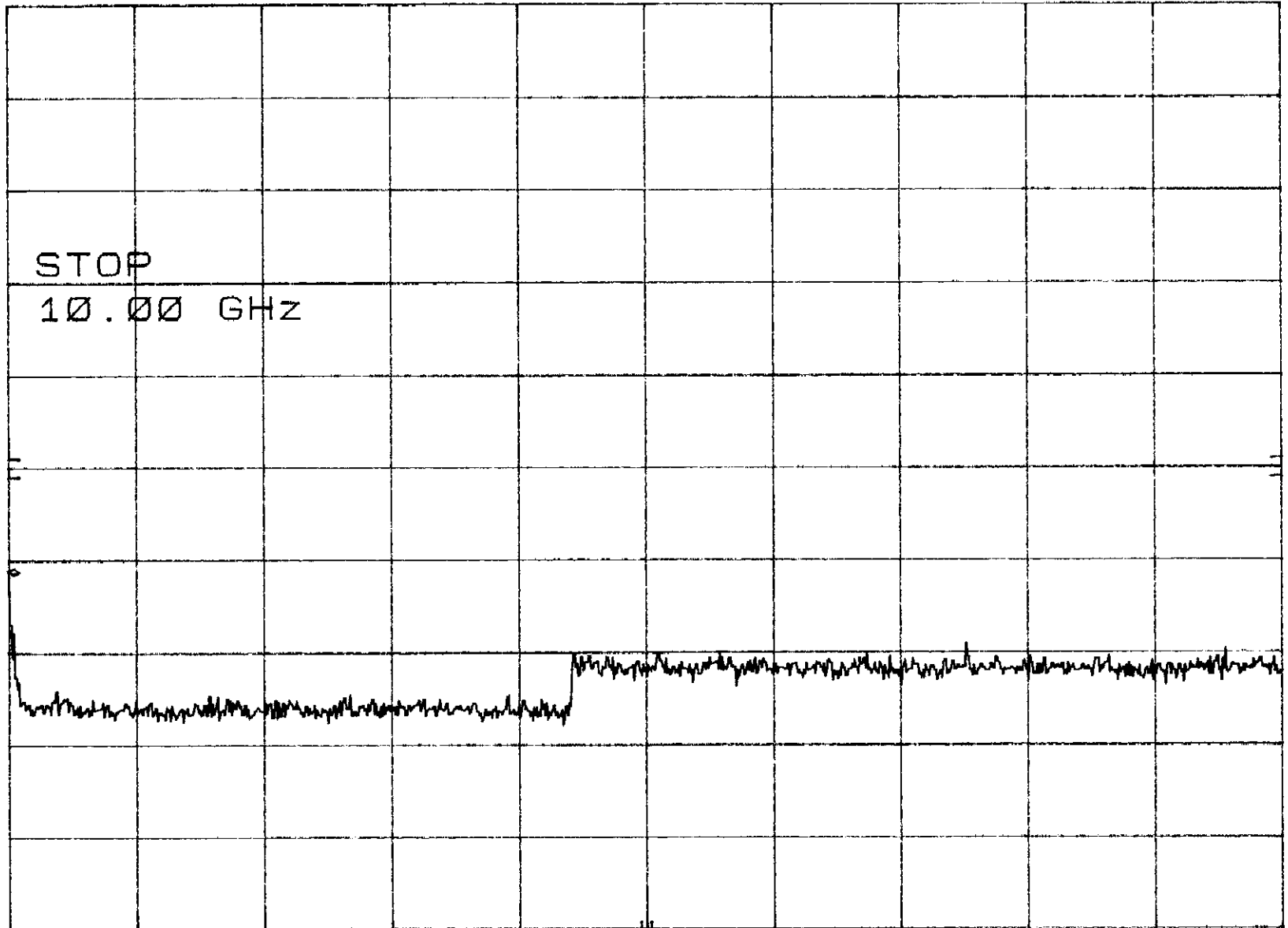

START 2.48 GHz

RES BW 100 KHz

VBW 100 KHz

STOP 10.00 GHz
SWP 2.25 sec

Plot 4.c6

SYMBOL. 4121 HI-BAND
REF 10.0 dBm ATTEN 20 dB

MKR 22.82 GHz
-43.90 dBm

hp
10 dB/

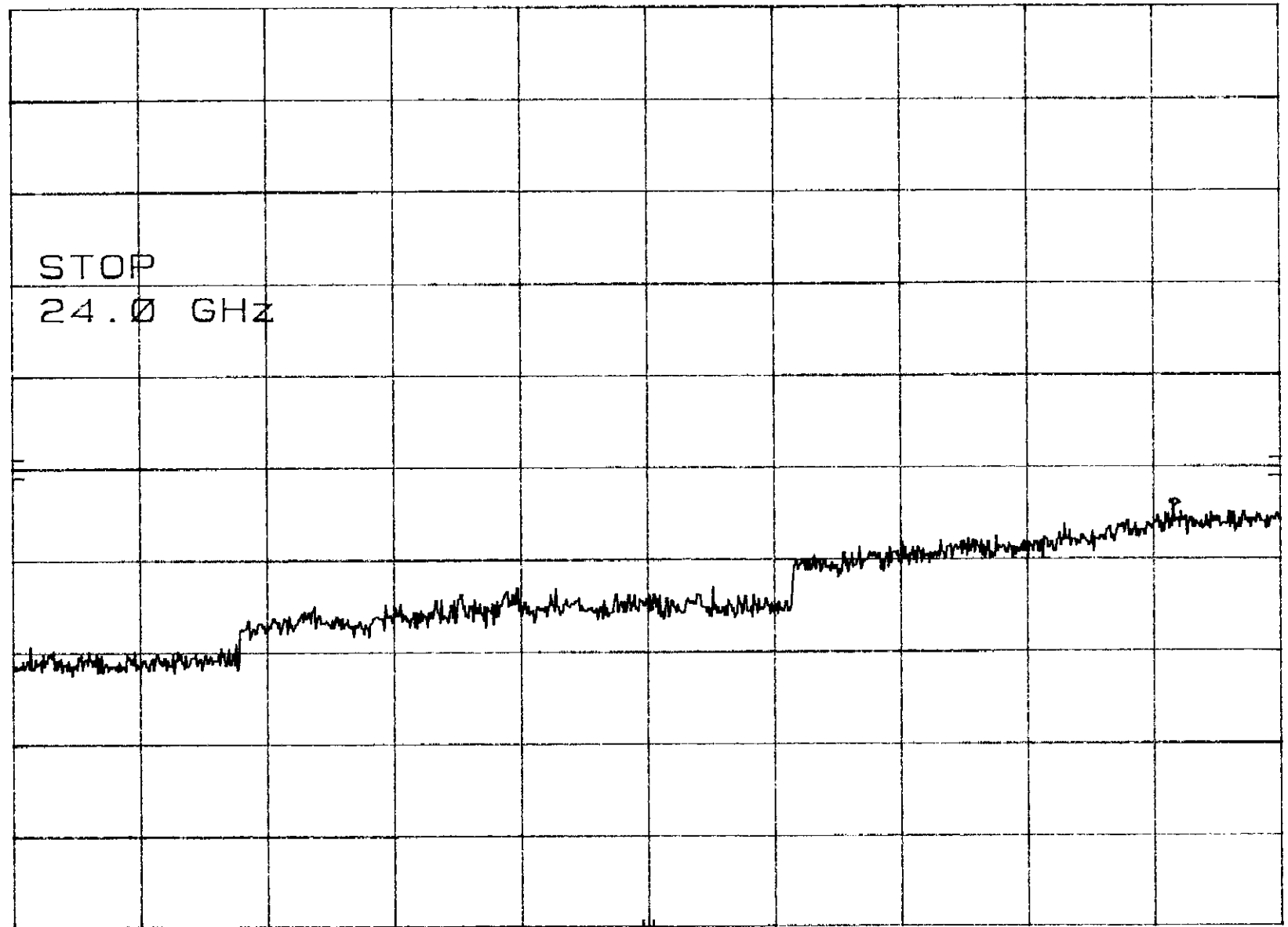

START 10.0 GHz RES BW 100 KHZ VBW 100 KHZ STOP 24.0 GHz
SWP 4.20 sec

Plot 6.1

SYMBOL. 4121

MKR Δ 21.45 MHz

hp REF 10.0 dBm

ATTEN 20 dB

-54.70 dB

10 dB/

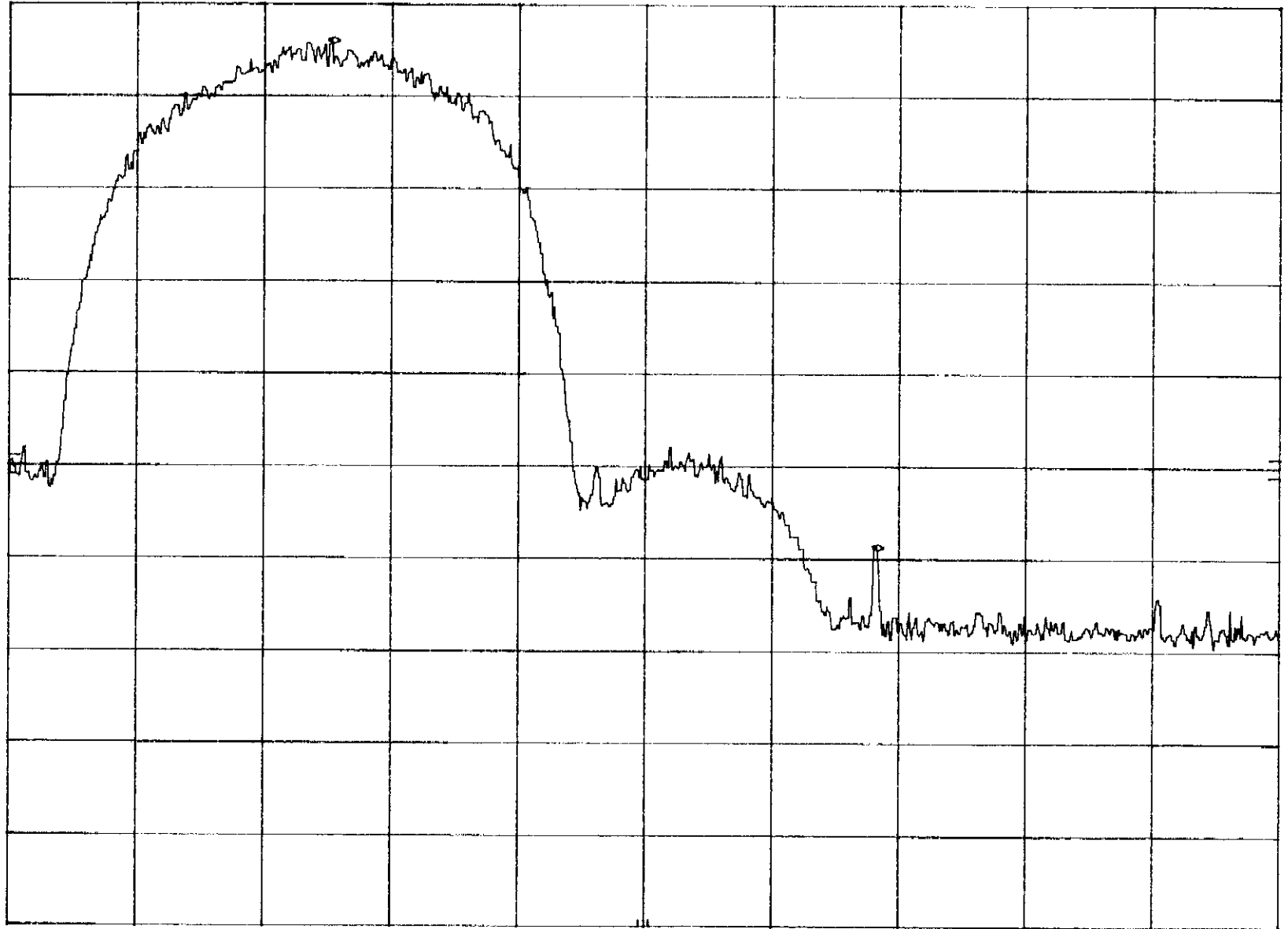

START 2.4500 GHz

RES BW 100 kHz

VBW 100 kHz

STOP 2.5000 GHz

SWP 20.0 msec

Plot 6, 2

SYMBOL. 4121

MKR 2.484 10 GHz

hp

REF 10.0 dBm

ATTEN 20 dB

-48.40 dBm

10 dB/

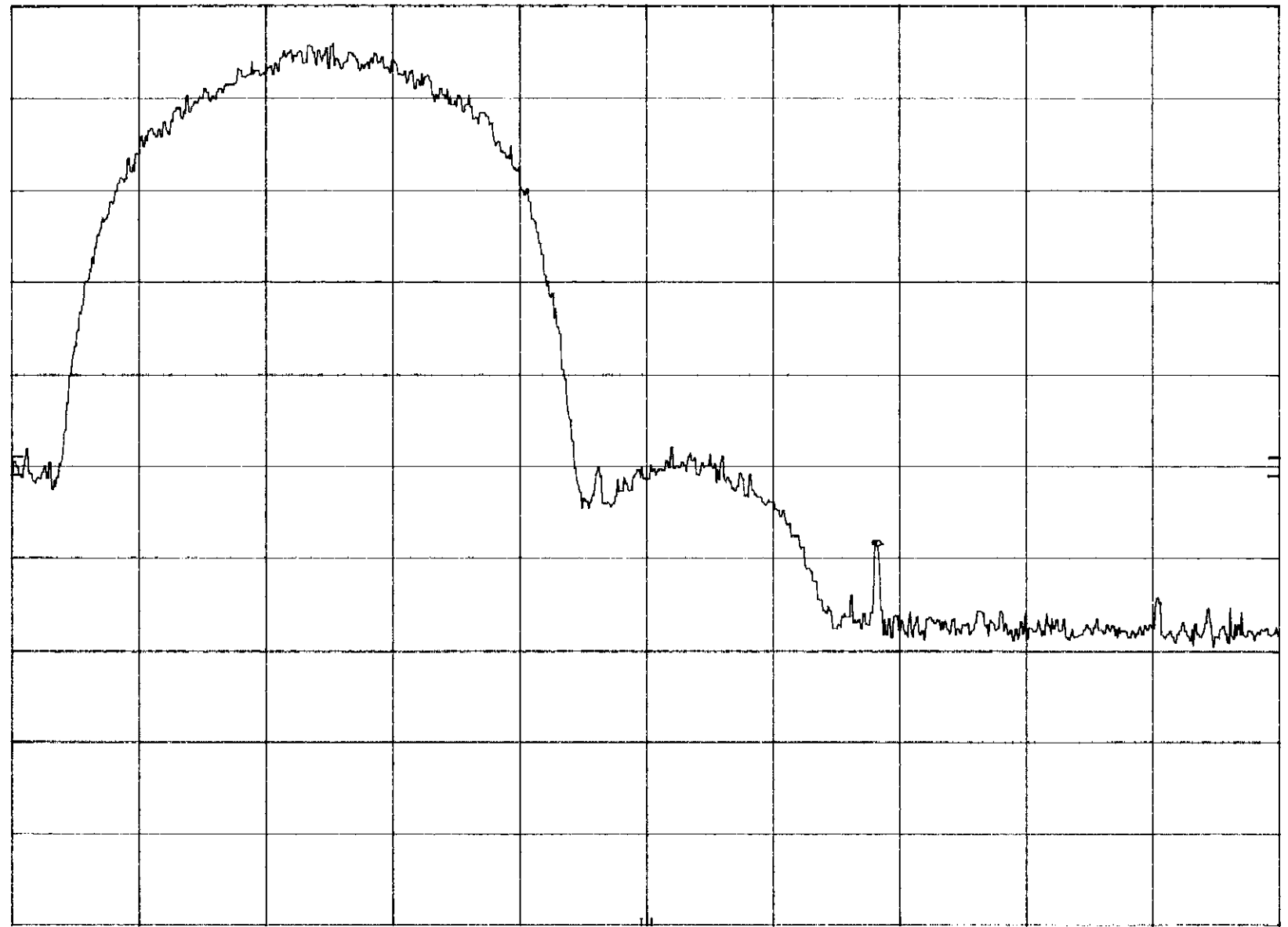

START 2.450 0 GHz

STOP 2.500 0 GHz

RES BW 100 KHz

VBW 100 KHz

SWP 20.0 msec

Plot 6.3

SYMBOL. 4121

MKR Δ -22.6 MHz

REF 10.0 dBm

ATTEN 20 dB

-58.20 dB

hp
10 dB/

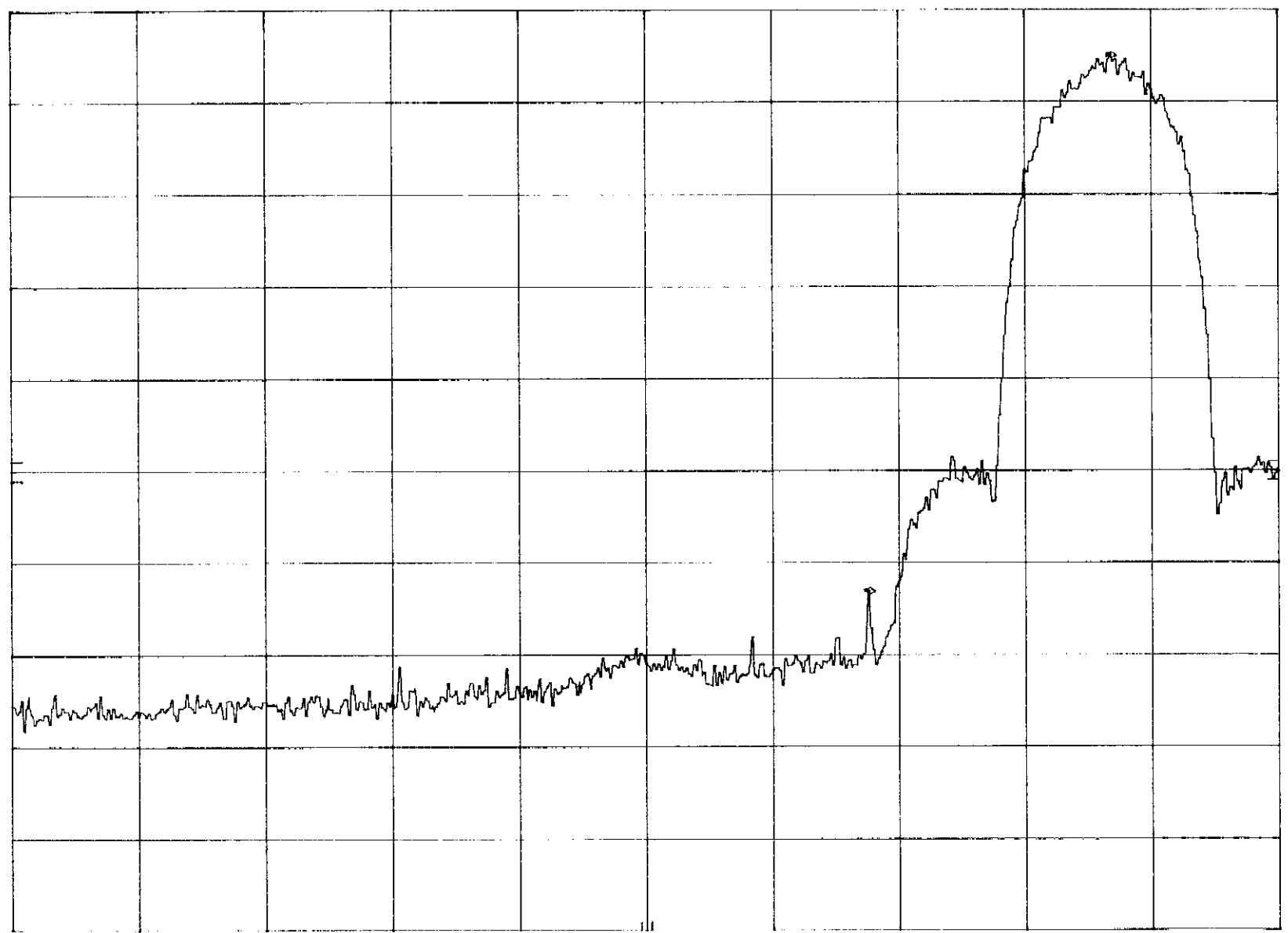

START 2.310 GHz

STOP 2.427 GHz

RES BW 100 KHz

VBW 100 KHz

SWP 35.4 msec

SYMBOL. 4121

Plot 6.4

MKR 2.389 8 GHz

hp

REF 10.0 dBm

ATTEN 20 dB

-53.10 dBm

10 dB/

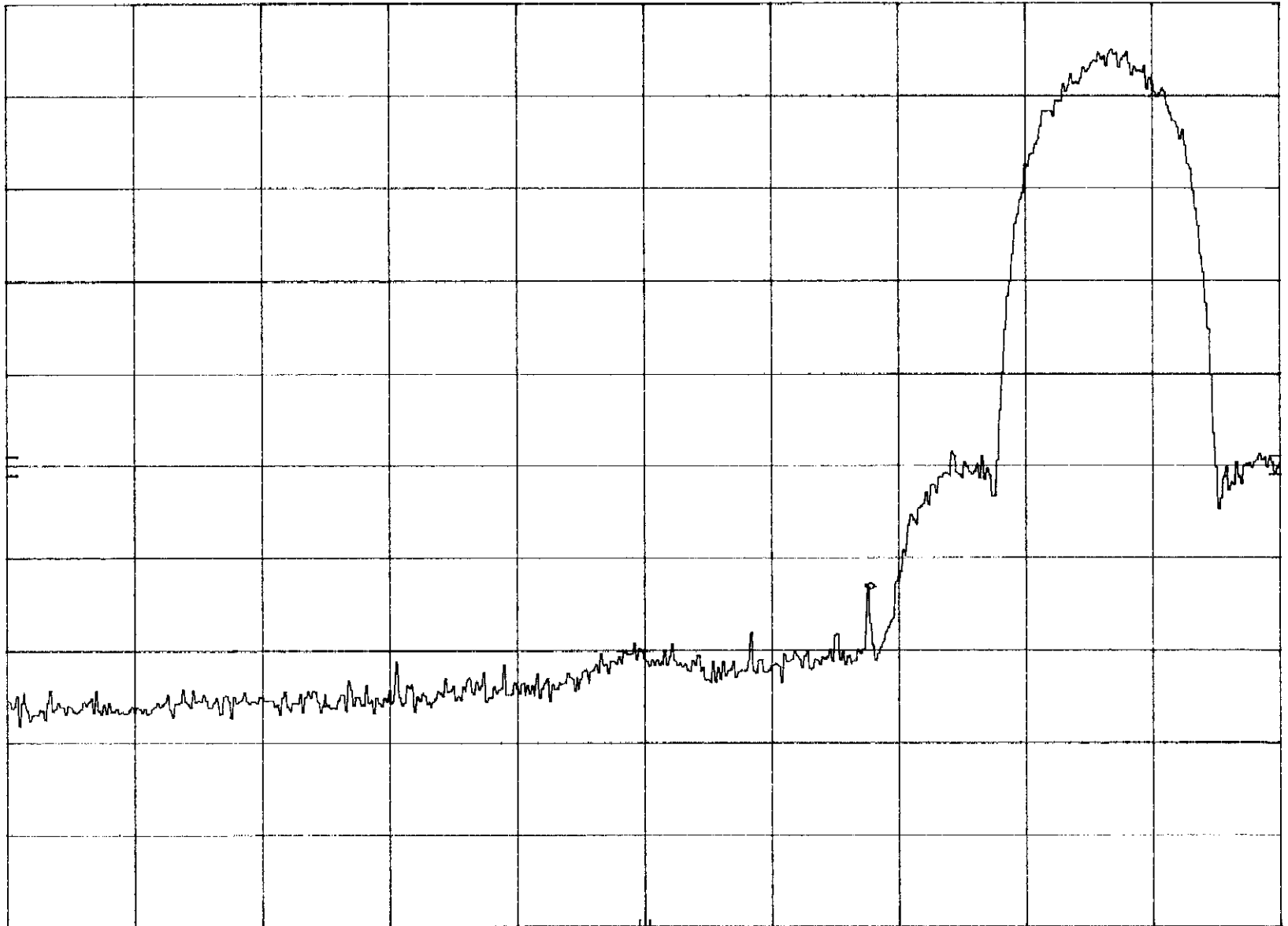

START 2.310 GHz

STOP 2.427 GHz

RES BW 100 kHz

VBW 100 kHz

SWP 35.4 msec