



Intertek Testing Services
ETL SEMKO

FCC Part 15.247 Test Report
for
Symbol Technologies
on the
Model: LA4121
FCC ID: Not Labeled

Test Report #: J20008658d
Date of Report: April 11, 2000

Job #: J20008658-C
Date of Test: April 3 & 7, 2000

Total No. of Pages Contained in this Report: 25 + data pages



<i>Barry E. Smith</i>	Barry E. Smith, Test Engineer
<i>David Chernomordik</i>	David Chernomordik, Ph.D., EMC Site Manager

All services undertaken are subject to the following general policy: Reports are submitted for exclusive use of the client to whom they are addressed. Their significance is subject to the adequacy and representative character of the samples and to the comprehensiveness of the tests, examinations or surveys made. This report shall not be reproduced except in full, without written consent of Intertek Testing Services, NA Inc. This report must not be used to claim product endorsement by NVLAP, NIST nor any other agency of the U.S. Government.

FCC Part 15 DSSS Cert. Rev 9/99



Intertek Testing Services NA Inc.
1365 Adams Court, Menlo Park, CA 94025
Telephone 650-463-2900 Fax 650-463-2910 Home Page www.ettsemko.com



Table of Contents

1.0	Summary of Tests	2
2.0	General Description	3
2.1	Product Description	3
2.2	Related Submittal(s) Grants	3
2.3	Test Methodology	4
2.4	Test Facility.....	4
3.0	System Test Configuration	5
3.1	Support Equipment and description	5
4.2	Block Diagram of Test Setup	5
3.3	Justification.....	6
3.4	Software Exercise Program.....	6
3.5	Mode of Operation During Test	6
3.6	Modifications Required for Compliance	6
3.7	Additions, deviations and exclusions from standards	6
4.0	Measurement Results	7
4.1	Maximum Conducted Output Power at Antenna Terminals	7
4.2	Minimum 6 dB RF Bandwidth	8
4.3	Maximum Power Density Reading	9
4.4	Out of Band Conducted Emissions.....	10
4.5	Out of Band Radiated Emissions.....	11
4.7	AC Line Conducted Emission.....	13
4.8	Radiated Emissions from Digital Section of Transceiver (Transmitter).....	14
4.9	Radiated Emissions from Receiver Section of Transceiver (L.O. Radiation).....	15
4.10	Processing Gain Measurements	16
4.11	Transmitter Duty Cycle Calculation and Measurements.....	17
5.0	Appendix A : Plots	18
6.0	Appendix B: Photographs	19

Symbol Technologies, Model No. LA4121
 FCC ID:

Date of Test: April 3 & 7, 2000

1.0 Summary of Tests

MODEL: LA4121

TEST	REFERENCE	RESULTS
Max. Output power	15.247(b)	Pass
6 dB Bandwidth	15.247(a)(2)	Pass
Max. Power Density	15.247(d)	Pass
Out of Band Antenna Conducted Emission	15.247(c)	Pass
Out of Band Radiated Emission	15.247(c)	N/A
Radiated Emission in Restricted Bands	15.247(c)	Pass
AC Conducted Emission	15.207	Pass <i>see DaC report</i>
Radiated Emission from Digital Part	15.109	Pass
Radiated Emission from Receiver L.O.	15.109	Not Applicable
Processing Gain Measurements	15.247(e)	Provided by applicant
Antenna Requirement	15.203	Pass

Test Engineer: *Barry E. Smith*
 Barry E. Smith

Date: *5/5/00*

EMC Site Manager: *David Chernomordik*
 David Chernomordik, Ph.D.
 EMC Site Manager

Date: *5/5/00*



Symbol Technologies, Model No. LA4121
FCC ID:

Date of Test: April 3 & 7, 2000

2.0 General Description

2.1 Product Description

The Symbol Technologies model LA4121 is 2.4 GHz Spread Spectrum radio in the form of a PCMCIA card that is used for wireless communication from a computer to a LAN.

A pre-production version of the sample was received on January 31, 2000 in good condition.

Overview of LA4121

Applicant	Symbol Technologies
Trade Name & Model No.	Symbol Technologies / LA4121
FCC Identifier	Not Labeled
Use of Product	
Manufacturer & Model of Spread Spectrum Module	Symbol Technologies
Type of Transmission	Direct Sequence
Rated RF Output (mW)	22 dBm
Frequency Range (MHz)	2412 – 2462 MHz
Number of Channel(s)	11
Antenna(s) & Gain, dBi	9
Processing Gain Measurements	<input type="checkbox"/> Will be provided to ITS for submission with the application <input type="checkbox"/> Will be provided directly to the FCC reviewing engineer by the client or manufacturer of the spread spectrum module
Antenna Requirement	<input type="checkbox"/> The EUT uses a permanently connected antenna. <input checked="" type="checkbox"/> The antenna is affixed to the EUT using a unique connector which allows for replacement of a broken antenna, but DOES NOT use a standard antenna jack or electrical connector. <input type="checkbox"/> The EUT requires professional installation (attach supporting documentation if using this option).
Manufacturer name & address	Symbol Technologies 2145 Hamilton Avenue San Jose CA 95125

2.2 Related Submittal(s) Grants

None

2.3 Test Methodology

Both AC mains line-conducted and radiated emissions measurements were performed according to the procedures in ANSI C63.4 (1992). Radiated tests were performed at an antenna to EUT distance of 3 meters, unless stated otherwise in the "**Data Sheet**" of this Application. All other measurements were made in accordance with the procedures in part 2 of CFR 47.

2.4 Test Facility

The open area test site and conducted measurement facility used to collect the radiated data is site 2. This test facility and site measurement data have been fully placed on file with the FCC and NVLAP accredited.

3.0 System Test Configuration

3.1 Support Equipment and description

Item #	Description	Model No.	Serial No.
1	Dell PC	Latitude M233ST	Z8T5U
2	Dell Monitor	D1428-HS	2922CV22495
3	Datatronics Modem	1200CK	07-305041
4	HP Printer	2225C+	2921S45711

4.2 Block Diagram of Test Setup

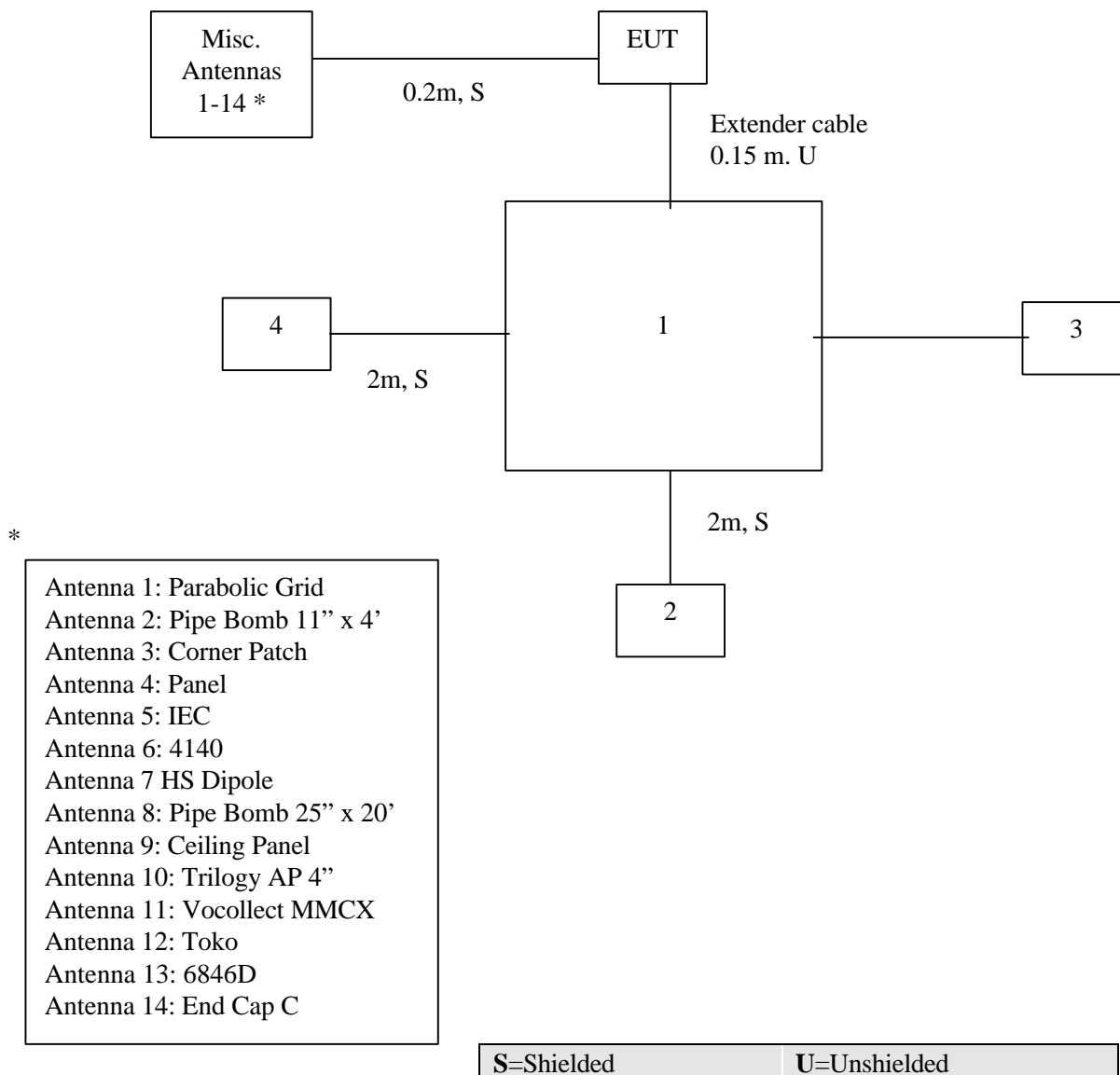

3.3 Justification

For emission testing, the equipment under test (EUT) was configured for testing in a typical fashion (as a customer would normally use it). During testing, all cables were manipulated to produce worst case emissions.

For radiated emission measurements, the EUT is attached to a cardboard box (if necessary) and placed on the wooden turntable. If the EUT attaches to peripherals, they are connected and operational (as typical as possible). The EUT is wired to transmit full power.

The signal is maximized through rotation and placement in the three orthogonal axes. The antenna height and polarization are varied during the search for maximum signal level. The antenna height is varied from 1 to 4 meters.

Radiated emissions are taken at three meters unless the signal level is too low for measurement at that distance. If necessary, a pre-amplifier is used and/or the test is conducted at a closer distance. All readings are extrapolated back to the equivalent three meter reading using inverse scaling with distance.

Detector functions are in peak and average modes for frequencies above 1 GHz.

3.4 Software Exercise Program

The EUT exercise program used during radiated and conducted testing was designed to exercise the various system components in a manner similar to a typical use. For emissions testing, the units were setup to transmit continuously to simplify the measurement methodology. Care was taken to ensure proper power supply voltages during testing.

3.5 Mode of Operation During Test

EUT was set to continuously transmit.

3.6 Modifications Required for Compliance

The following modifications were installed during compliance testing in order to bring the product into compliance (Please note that this list does not include changes made specifically by Symbol Technologies prior to compliance testing):

No modifications were installed by Intertek Testing Services.

3.7 Additions, deviations and exclusions from standards

No additions, deviations, or exclusions were made to the standard.

4.0 Measurement Results

4.1 Maximum Conducted Output Power at Antenna Terminals, FCC Rules 15.247(b)

Requirement

For antennas with gains of 6 dBi or less, maximum allowed transmitter output power is 1 watt (+30 dBm).

For antennas with gain greater than 6 dBi, transmitter output power must be decreased by an amount equal to (GAIN - 6) dB.

Procedure

[X] The antenna port of the EUT was connected to the input of a power meter. Power was read directly and cable loss correction was added to the reading to obtain power at the EUT antenna terminals.

[] The antenna port of the EUT was connected to the input of a spectrum analyzer. The analyzer was set for maximum RES BW and power was read directly in dBm. External attenuation and cable loss were compensated for using the OFFSET function of the analyzer.

Max. antenna gain = 9 dBi		
Frequency (MHz)	Output in dBm	Output in mWatt
2412	21.8	
2437	20.5	
2462	19.4	

Cable loss: 0 dB

External Attenuation: 0 dB

Cable loss, external attenuation:

[x] included in OFFSET function

[] added to SA raw reading

Test Result

EUT Transmit Antenna Gain(dBi) + dBm max. output power = 31.8 dBm (less than 36 dBm)

The EUT passed the test

Symbol Technologies, Model No. LA4121
FCC ID:

Date of Test: April 3 & 7, 2000

4.2 Minimum 6 dB RF Bandwidth, FCC Rule 15.247(a)(2):

Requirement

For direct sequence systems, the minimum 6 dB bandwidth shall be at least 500 kHz.

Procedure

The antenna port of the EUT was connected to the input of a spectrum analyzer. Analyzer RES BW was set to 100 kHz. For each RF output channel investigated, the spectrum analyzer center frequency was set to the channel carrier. A PEAK output reading was taken, a DISPLAY line was drawn 6 dB lower than PEAK level. The 6 dB bandwidth was determined from where the channel output spectrum intersected the display line.

Test Result

Frequency (MHz)	Min. 6 dB Bandwidth (kHz)
2437	9760

Refer to the following plots for 6 dB bandwidth sharp:

- Plot 2a: Low Channel 6 dB RF Bandwidth
- Plot 2b: Middle Channel 6 dB RF Bandwidth
- Plot 2c: High Channel 6 dB RF Bandwidth

The EUT passed the test.

4.3 Maximum Power Density Reading, FCC Rule 15.247(d):

Requirement

The peak power spectral density shall not be greater than 8 dBm in any 3 kHz band during any time interval of continuous transmission.

Procedure

The spectrum analyzer RES BW was set to 3 kHz. The START and STOP frequencies were set to the band edges of the maximum output passband. If there is no clear maximum amplitude in any given portion of the band, it may be necessary to make measurements at a number of bands defined by several START and STOP frequency pairs. Total SWEEP TIME is calculated as follows:

$$\text{SWEEP TIME (SEC)} = (\text{Fstop, kHz} - \text{Fstart, kHz}) / 3 \text{ kHz}$$

Antenna output of the EUT was coupled directly to spectrum analyzer; if an external attenuator and/or cable was used, these losses are compensated for with the analyzer OFFSET function.

Frequency (MHz)	Power Density (dBm)
2412	1.9dBm

Frequency Span = 2100 kHz

Sweep Time = Frequency Span / 3 kHz
= 700 seconds

Test Result

Refer to the following plots for power density data:

- Plot 3a: Low Channel Power Density
- Plot 3b: Middle Channel Power Density
- Plot 3c: High Channel Power Density

4.4 Out of Band Conducted Emissions, FCC Rule 15.247(c):

Requirement

In any 100 kHz bandwidth outside the frequency band, the RF power shall be at least 20 dB below that in the 100 kHz bandwidth within the band that contains the highest level of the desired power.

Test Procedure

The antenna port of the EUT was connected to the input of a spectrum analyzer. Analyzer RES BW was set to 100 kHz. Several plots were made to show Out of Band Conducted Emissions in the frequency range from 1 MHz to 25 GHz.

Test Result

Refer to the following plots for out of band conducted emissions data:

Plot 4a.1 - 4a.6: Low Channel Emissions

Plot 4b.1 - 4b.6: Middle Channel Emissions

Plot 4c.1 - 4c.6 : High Channel Emissions

The EUT passed the test

Symbol Technologies, Model No. LA4121
FCC ID:

Date of Test: April 3 & 7, 2000

4.5 Out of Band Radiated Emissions (except Radiated emissions in Restricted Bands), FCC Rule 15.247(c).

For out of band emissions that are close to or that exceed the 20 dB attenuation requirement described in the specification, radiated measurements were performed at a 3 m separation distance to determine whether these emissions complied with the radiated emission requirement. (20 dB below in- band emissions)

- Not required. All out-of-band conducted emissions at least 20 dB below in-band conducted emissions.
- See attached data sheet

4.6 Transmitter Radiated Emissions in Restricted Bands, FCC Rule 15.247 (c), 15.209, 15.35(b), (c):

Radiated emission measurements were performed according ANSI C63.4 Requirements.

Radiated emission measurements were performed from 30 MHz to 25 GHz. Analyzer resolution bandwidth (Res BW) was 100 kHz or greater for frequencies from 30 MHz to 1 GHz, and 1 MHz for frequencies above 1 GHz.

All measurements below 1 GHz were performed with peak detection unless otherwise specified, all measurements above 1 GHz were performed with peak and average detection.

In addition for antenna with highest antenna gain (antenna 15), radiated emissions on the band-edge frequencies were performed using a "delta method". The field strength at the fundamental frequencies (E_0) was measured and recorded (peak and average level) at lowest and highest channels. The conducted emission plots were made to show attenuation (delta) at the 2483.5 MHz and up to 2500 MHz (for high channel), and attenuation at 2390 MHz and down to 2310 MHz (for low channel). Radiated emission at the band-edge frequencies were calculated by subtracting "delta" from field strength at the fundamental frequencies.

Data is included of the worst case configuration (the configuration which resulted in the highest emission levels). A sample calculation, configuration photographs and data tables of the emissions are included.

For band-edge frequency 2483.5 MHz:

at 2462 MHz $E_0 = 102.1$ dBuV (average), $E_0 = 106.0$ dBuV (peak)
"delta" = 54.7 dB (from plot 6.1)

Field Strength at band-edge frequency $E_f = 47.4$ dBuV (average), $E_f = 51.3$ dBuV (peak)

For 2390 MHz

at 2412 MHz $E_0 = 104.0$ dBuV (average), $E_0 = 108.0$ dBuV (peak)
"delta" = 58.2 dB (from plot 6.3)

Field Strength at 2390 MHz, $E_f = 45.8$ dBuV (average), $E_f = 49.8$ dBuV (peak)

The data on the following pages list the significant emission frequencies, the limit and the margin of compliance.

**Radiated Emissions
Test Data**

Company: Symbol				Model #: LA4121		Standard		FCC § 15.247 (R.F.)				
EUT: Trilogy 2				Ant #: ML-2499-PGA1-00		Limit		11				
Project #: J20008658B				Test Date: April 3, 2000		Test Distance		3 meters				
Test Mode: Transmitting on antenna 1				Engineer: Barry S.		Duty Relaxation		0 dB				
Frequency	Reading	Detector	Ant #	Amp #	Ant Pol	Ant Factor	Pre-Amp	Insert Loss	D.C.F.	Net	Limit	Margin
Hz	dB(μV)	PKG	#	#	Hz	dB(1m)	dB	dB	dB	dB(μV/m)	dB(μV/m)	dB
2412.00E+0	76.1	Peak	8		V	29.6	0.0	2.3	0.0	108.0		
2412.00E+0	72.1	Ave.	8		V	29.6	0.0	2.3	0.0	104.0		
2390.00E+0												
4824.00E+0	28.7	Peak	8	8	V	33.5	28.1	3.2	0.0	37.3	74.0	-36.7
4824.00E+0	21.9	Ave.	8	8	V	33.5	28.1	3.2	0.0	30.5	54.0	-23.5
7236.00E+0	33.3	Peak	8	8	V	38.0	28.0	4.3	0.0	47.6	74.0	-26.4
7236.00E+0	25.9	Ave.	8	8	V	38.0	28.0	4.3	0.0	40.2	54.0	-13.8
1.21E+4	34.8	Peak	8	10	V	42.5	39.1	5.9	0.0	44.1	74.0	-30.0
1.21E+4	26.5	Ave.	8	10	V	42.5	39.1	5.9	0.0	35.8	54.0	-18.3
1.45E+4	39.2	Peak	8	10	V	41.5	37.8	6.5	0.0	49.4	74.0	-24.6
1.45E+4	31.9	Ave.	8	10	V	41.5	37.8	6.5	0.0	42.1	54.0	-11.9
1.93E+4	41.6	Peak	21	13	V	40.2	23.3	7.7	-9.5	56.7	74.0	-17.3
1.93E+4	24.6	Ave.	21	13	V	40.2	23.3	7.7	-9.5	39.7	54.0	-14.3
2.17E+4	41.5	Peak	21	13	V	40.3	23.3	0.0	-9.5	49.0	74.0	-25.0
2.17E+4	24.1	Ave.	21	13	V	40.3	23.3	0.0	-9.5	31.6	54.0	-22.4
2437.00E+0												
4874.00E+0	28.9	Peak	8	8	V	33.5	28.1	3.2	0.0	37.5	74.0	-36.6
4874.00E+0	21.5	Ave.	8	8	V	33.5	28.1	3.2	0.0	30.1	54.0	-23.9
7311.00E+0	33.5	Peak	8	8	V	38.0	28.0	4.3	0.0	47.8	74.0	-26.2
7311.00E+0	26.1	Ave.	8	8	V	38.0	28.0	4.3	0.0	40.5	54.0	-13.6
1.22E+4	34.3	Peak	8	10	V	42.5	39.1	5.9	0.0	43.6	74.0	-30.5
1.22E+4	26.2	Ave.	8	10	V	42.5	39.1	5.9	0.0	35.5	54.0	-18.6
1.95E+4	33.0	Peak	21	13	V	40.2	23.3	7.7	-9.5	48.1	74.0	-25.9
1.95E+4	22.1	Ave.	21	13	V	40.2	23.3	7.7	-9.5	37.2	54.0	-16.8
2462.00E+0	73.3	Peak	8		V	29.6	0.0	3.1	0.0	106.0		
2462.00E+0	69.4	Peak	8		V	29.6	0.0	3.1	0.0	102.1		
2483.50E+0												
4924.00E+0	29.0	Peak	8	8	V	33.5	28.1	4.9	0.0	39.3	74.0	-34.7
4924.00E+0	21.7	Ave.	8	8	V	33.5	28.1	4.9	0.0	32.0	54.0	-22.0
7386.00E+0	33.7	Peak	8	8	V	38.0	28.0	6.3	0.0	50.0	74.0	-24.0
7386.00E+0	26.2	Ave.	8	8	V	38.0	28.0	6.3	0.0	42.5	54.0	-11.5
1.23E+4	34.2	Peak	8	10	V	42.5	39.1	8.8	0.0	46.4	74.0	-27.6
1.23E+4	26.7	Ave.	8	10	V	42.5	39.1	8.8	0.0	38.9	54.0	-15.1
1.23E+4	34.2	Peak	8	10	V	42.5	39.1	8.8	-9.5	36.9	74.0	-37.1
1.23E+4	26.7	Ave.	8	10	V	42.5	39.1	8.8	-9.5	29.4	54.0	-24.6

- Notes:**
- a) D.C.F.: Distance Correction Factor
 - b) Insert Loss (dB) = Cable A + Cable B + Cable C.
 - c) Net (dB) = Reading + Antenna Factor - Pre-amp + Insert Loss - Transducer Loss - Duty Relaxation (transmitter only).
 - d) Negative signs (-) in Margin column signify levels below the limits.
 - e) All other emissions not reported are below the equipment noise floor which is at least 20 dB below the limits.
 - f) Readings with -9.5 DCF were taken at 1 meter with RBW=300kHz

**Radiated Emissions
Test Data**

Company: Symbol						Model #: LA4121		Standard		FCC 47 CFR 15.107 (A,B)			
EUT: Trilogy 2						Ant #: 50-11901-048P		Limits		11			
Project #: J20008658B						Test Date: April 3, 2000		Test Distance		3		meters	
Test Mode: Transmitting on antenna 2						Engineer: Barry S.		Duty Relaxation		0		dB	
Frequency	Reading	Detector	Ant	Amp	Ant. Pol.	Ant. Factor	Pre-Amp	Insert. Loss	D.C.F.	Net	Limit @3m	Margin	
MHz	dBµV	PAO	#	#	MV	dB(1m)	dB	dB	dB	dBµV/m	dB(µV/m)	dB	
2412													
4824	30.6	Peak	8	8	V	33.5	28.1	3.2	0.0	39.2	74.0	-34.8	
4824	23.4	Ave.	8	8	V	33.5	28.1	3.2	0.0	32.0	54.0	-22.0	
7236	33.2	Peak	8	8	V	38.0	28.0	4.3	0.0	47.5	74.0	-26.5	
7236	26.0	Ave.	8	8	V	38.0	28.0	4.3	0.0	40.3	54.0	-13.7	
12060	34.5	Peak	8	10	V	42.5	39.1	5.9	0.0	43.8	74.0	-30.3	
12060	27.3	Ave.	8	10	V	42.5	39.1	5.9	0.0	36.6	54.0	-17.5	
14472	39.7	Peak	8	10	V	41.5	37.8	6.5	0.0	49.9	74.0	-24.1	
14472	31.8	Ave.	8	10	V	41.5	37.8	6.5	0.0	42.0	54.0	-12.0	
19296	41.5	Peak	21	13	V	40.2	23.3	7.7	-9.5	56.7	74.0	-17.3	
19296	24.6	Ave.	21	13	V	40.2	23.3	7.7	-9.5	39.7	54.0	-14.3	
21708	42.0	Peak	21	13	V	40.3	23.3	0.0	-9.5	49.5	74.0	-24.5	
21708	23.6	Ave.	21	13	V	40.3	23.3	0.0	-9.5	31.1	54.0	-22.9	
2437													
4874	28.5	Peak	8	8	V	33.9	28.1	3.2	0.0	37.5	74.0	-36.5	
4874	20.5	Ave.	8	8	V	33.9	28.1	3.2	0.0	29.5	54.0	-24.5	
7311	33.3	Peak	8	8	V	38.0	28.0	4.3	0.0	47.6	74.0	-26.4	
7311	26.0	Ave.	8	8	V	38.0	28.0	4.3	0.0	40.3	54.0	-13.7	
12185	34.4	Peak	8	10	V	42.3	39.1	5.9	0.0	43.5	74.0	-30.5	
12185	26.9	Ave.	8	10	V	42.3	39.1	5.9	0.0	36.0	54.0	-18.1	
19496	32.8	Peak	21	13	V	40.2	23.3	7.7	-9.5	47.9	74.0	-26.1	
19496	21.5	Ave.	21	13	V	40.2	23.3	7.7	-9.5	36.6	54.0	-17.4	
2462													
4924	34.5	Peak	8	8	V	33.5	28.1	4.9	0.0	44.8	74.0	-29.2	
4924	25.8	Ave.	8	8	V	33.5	28.1	4.9	0.0	36.1	54.0	-17.9	
7386	34.1	Peak	8	8	V	38.0	28.0	6.3	0.0	50.4	74.0	-23.6	
7386	26.0	Ave.	8	8	V	38.0	28.0	6.3	0.0	42.3	54.0	-11.7	
12310	34.9	Peak	8	10	V	42.5	39.1	8.8	0.0	47.1	74.0	-26.9	
12310	26.5	Ave.	8	10	V	42.5	39.1	8.8	0.0	38.7	54.0	-15.3	
22158	46.0	Peak	21	13	V	40.3	23.3	0.0	-9.5	53.5	74.0	-20.5	
22158	37.8	Ave.	21	13	V	40.3	23.3	0.0	-9.5	45.3	54.0	-8.7	

- Notes:**
- a) D.C.F.: Distance Correction Factor
 - b) Insert Loss (dB) = Cable A + Cable B + Cable C
 - c) Net (dB) = Reading + Antenna Factor - Pre-amp + Insert Loss - Transducer Loss - Duty Relaxation (transmitter only).
 - d) Negative signs (-) in Margin column signify levels below the limits.
 - e) All other emissions not reported are below the equipment noise floor which is at least 20 dB below the limits.
 - f) Readings with DCF -9.5 were taken at 1 meter with RBW 300kHz

**Radiated Emissions
Test Data**

Company: Symbol						Model #: LA4121		Standard		FCC § 15.247 (R.S.)		
EUT: Trilogy 2						Ant #: ML-2499-PTA1-01		Limits		11		
Project #: J20008658B						Test Date: April 3, 2000		Ant. Distance		3 meters		
Test Mode: Transmitting on antenna 3						Engineer: Barry S.		Duty Relaxation		0 dB		
Frequency	Reading	Detector	Ant #	Amp #	Ant. Pol.	Ant. Factor	Pre-Amp	Insert. Loss	D.C.F.	Net	Limit	Margin
MHz	dB(μV)	FAO	#	#	HV	dB(dBm)	dB	dB	dB	dB(μV/m)	dB(μV/m)	dB
2412												
4824	38.4	Peak	8	8	V	33.5	28.1	3.2	0.0	47.0	74.0	-27.0
4824	29.3	Ave.	8	8	V	33.5	28.1	3.2	0.0	37.9	54.0	-16.1
7236	31.7	Peak	8	8	V	38.0	28.0	4.3	0.0	46.1	74.0	-28.0
7236	25.7	Ave.	8	8	V	38.0	28.0	4.3	0.0	40.0	54.0	-14.0
12060	34.5	Peak	8	10	V	42.5	39.1	5.9	0.0	43.8	74.0	-30.3
12060	26.8	Ave.	8	10	V	42.5	39.1	5.9	0.0	36.1	54.0	-18.0
14472	39.1	Peak	8	10	V	41.5	37.8	6.5	0.0	49.3	74.0	-24.7
14472	32.3	Ave.	8	10	V	41.5	37.8	6.5	0.0	42.5	54.0	-11.5
19296	40.9	Peak	21	13	V	40.2	23.3	7.7	-9.5	56.0	74.0	-18.0
19296	24.1	Ave.	21	13	V	40.2	23.3	7.7	-9.5	39.2	54.0	-14.8
21708	39.9	Peak	21	13	V	40.3	23.3	0.0	-9.5	47.4	74.0	-26.6
21708	21.1	Ave.	21	13	V	40.3	23.3	0.0	-9.5	28.6	54.0	-25.4
2437												
4874	35.2	Peak	8	8	V	33.5	28.1	3.2	0.0	43.8	74.0	-30.2
4874	28.4	Ave.	8	8	V	33.5	28.1	3.2	0.0	37.0	54.0	-17.0
7311	33.7	Peak	8	8	V	38.0	28.0	4.3	0.0	48.0	74.0	-26.0
7311	26.1	Ave.	8	8	V	38.0	28.0	4.3	0.0	40.4	54.0	-13.6
12185	33.5	Peak	8	10	V	42.5	39.1	5.9	0.0	42.8	74.0	-31.3
12185	24.0	Ave.	8	10	V	42.5	39.1	5.9	0.0	33.3	54.0	-20.8
19496	31.8	Peak	21	13	V	40.2	23.3	7.7	-9.5	46.9	74.0	-27.1
19496	21.1	Ave.	21	13	V	40.2	23.3	7.7	-9.5	36.2	54.0	-17.8
2462												
4924	30.5	Peak	8	8	V	33.5	28.1	4.9	0.0	40.8	74.0	-33.2
4924	24.9	Ave.	8	8	V	33.5	28.1	4.9	0.0	35.2	54.0	-18.8
7386	32.5	Peak	8	8	V	38.0	28.0	6.3	0.0	48.8	74.0	-25.2
7386	25.9	Ave.	8	8	V	38.0	28.0	6.3	0.0	42.2	54.0	-11.9
12310	36.2	Peak	8	10	V	42.5	39.1	8.8	0.0	48.4	74.0	-25.6
12310	27.1	Ave.	8	10	V	42.5	39.1	8.8	0.0	39.3	54.0	-14.7
22158	46.1	Peak	21	13	V	40.3	23.3	0.0	-9.5	53.6	74.0	-20.4
22158	38.0	Ave.	21	13	V	40.3	23.3	0.0	-9.5	45.5	54.0	-8.5

- Notes:**
- a) D.C.F.: Distance Correction Factor
 - b) Insert. Loss (dB) = Cable A + Cable B + Cable C.
 - c) Net (dB) = Reading + Antenna Factor - Pre-amp + Insert. Loss. - Transducer Loss - Duty Relaxation (transmitter only).
 - d) Negative signs (-) in Margin column signify levels below the limits.
 - e) All other emissions not reported are below the equipment noise floor which is at least 20 dB below the limits.
 - f) Readings with DCF -9.5 were taken at 1 meter with RBW 300kHz

**Radiated Emissions
Test Data**

Company: Symbol						Model #: LA4121		Standard		FCC 47 CFR			
EUT: Trilogy 2						Ant #: ML-2499-PNA1-01		Limits		11			
Project #: J20008658B						Test Date: April 3, 2000		Test Distance		3		meters	
Test Mode: Transmitting on antenna 4						Engineer: Barry S.		Duty Relaxation		0		dB	
Frequency	Reading	Detector	Ant	Amp	Ant. Pol.	Ant. Factor	Pre-Amp	Insert Loss	D.C.F.	Net	Limit	Marg'n	
MHz	dBμV	PPA/Q	F	F	NAV	dB(1m)	dB	dB	dB	dB(1m)	dB(1m)	dB	
2412													
4824	37.6	Peak	8	8	V	33.5	28.1	3.2	0.0	46.2	74.0	-27.8	
4824	28.3	Ave.	8	8	V	33.5	28.1	3.2	0.0	36.9	54.0	-17.1	
7236	34.2	Peak	8	8	V	38.0	28.0	4.3	0.0	48.5	74.0	-25.5	
7236	26.1	Ave.	8	8	V	38.0	28.0	4.3	0.0	40.4	54.0	-13.6	
12060	33.7	Peak	8	10	V	42.5	39.1	5.9	0.0	43.0	74.0	-31.1	
12060	26.0	Ave.	8	10	V	42.5	39.1	5.9	0.0	35.3	54.0	-18.8	
14472	39.0	Peak	8	10	V	41.5	37.8	6.5	0.0	49.2	74.0	-24.8	
14472	31.5	Ave.	8	10	V	41.5	37.8	6.5	0.0	41.7	54.0	-12.3	
19296	41.6	Peak	21	13	V	40.2	23.3	7.7	-9.5	56.7	74.0	-17.3	
19296	24.6	Ave.	21	13	V	40.2	23.3	7.7	-9.5	39.7	54.0	-14.3	
21708	42.0	Peak	21	13	V	40.3	23.3	0.0	-9.5	49.5	74.0	-24.5	
21708	23.6	Ave.	21	13	V	40.3	23.3	0.0	-9.5	31.1	54.0	-22.9	
2437													
4874	35.2	Peak	8	8	V	33.5	28.1	3.2	0.0	43.8	74.0	-30.2	
4874	26.0	Ave.	8	8	V	33.5	28.1	3.2	0.0	34.6	54.0	-19.4	
7311	33.9	Peak	8	8	V	38.0	28.0	4.3	0.0	48.2	74.0	-25.8	
7311	25.8	Ave.	8	8	V	38.0	28.0	4.3	0.0	40.1	54.0	-13.9	
12185	33.1	Peak	8	10	V	42.5	39.1	5.9	0.0	42.4	74.0	-31.7	
12185	25.9	Ave.	8	10	V	42.5	39.1	5.9	0.0	35.2	54.0	-18.9	
19496	32.8	Peak	21	13	V	40.2	23.3	7.7	0.0	57.4	74.0	-16.6	
19496	21.5	Ave.	21	13	V	40.2	23.3	7.7	0.0	46.1	54.0	-7.9	
2462													
4924	43.4	Peak	8	8	V	33.5	28.1	4.9	0.0	53.7	74.0	-20.4	
4924	39.0	Ave.	8	8	V	33.5	28.1	4.9	0.0	49.3	54.0	-4.7	
7386	30.9	Peak	8	8	V	38.0	28.0	6.3	0.0	47.2	74.0	-26.8	
7386	24.3	Ave.	8	8	V	38.0	28.0	6.3	0.0	40.6	54.0	-13.4	
12310	36.3	Peak	8	10	V	42.5	39.1	8.8	0.0	48.5	74.0	-25.5	
12310	26.4	Ave.	8	10	V	42.5	39.1	8.8	0.0	38.6	54.0	-15.4	
22158	46.0	Peak	21	13	V	40.3	23.3	0.0	-9.5	53.5	74.0	-20.5	
22158	37.8	Ave.	21	13	V	40.3	23.3	0.0	-9.5	45.3	54.0	-8.7	

Notes:

- a) D.C.F.: Distance Correction Factor
- b) Insert Loss (dB) = Cable A + Cable B + Cable C.
- c) Net (dB) = Reading + Antenna Factor - Pre-amp + Insert Loss - Transducer Loss - Duty Relaxation (transmitter only).
- d) Negative signs (-) in Marg'n column signify levels below the limits.
- e) All other emissions not reported are below the equipment noise floor which is at least 20 dB below the limits
- f) Readings with DCF -9.5 were taken at 1 meter with RBW 300kHz

**Radiated Emissions
Test Data**

Company:	Symbol			Model #:	LA4121	Standard:	FCC § 15.247 (R.B.)
EUT:	Antenna 5			S/N #:		Limits:	11
Project #:				Test Date:	April 7, 2000	Test Distance:	3 meters
Test Mode:	Tx @ 2412MHz			Engineer:	Xi-Ming Y.	Duty Relaxation:	0 dB

Antenna Used			Pre-Amp Used			Cable Used			Transducer Used	
Number:	2	21	8	8	10	13	0	0	3	0
Model:	EMCO 3143	KIND 3145	EMCO 3115	CDI P100	AFT18958	ACD/400	None	None	Site 2 10m	None

Frequency	Reading	Detector	Ant	Amp	Ant. Pol.	Ant. Factor	Pre-Amp	Insert. Loss	D. C. F	Net	Limit @3m	Margin
Mhz	dB(µV)	P/A/O	#	#	H/V	dB(1m)	dB	dB	dB	dB(µV/m)	dB(µV/m)	dB
4825.40	34.0	Peak	8	8	H	34.0	28.1	0.0	0.0	39.9	74.0	-34.1
4825.40	24.0	Ave.	8	8	H	34.0	28.1	0.0	0.0	29.9	54.0	-24.1
7237.30	34.0	Peak	8	8	V	38.0	28.0	0.0	0.0	44.0	74.0	-30.0
7237.30	27.0	Ave.	8	8	V	38.0	28.0	0.0	0.0	37.0	54.0	-17.0
19296.00	45.0	Peak	21	13	V	40.2	23.3	2.3	-9.5	54.7	74.0	-19.3
19296.00	35.0	Ave.	21	13	V	40.2	23.3	2.3	-9.5	44.7	54.0	-9.3
21708.00	47.0	Peak	21	13	H	40.3	23.3	2.4	-9.5	56.9	74.0	-17.1
21708.00	38.0	Ave.	21	13	H	40.3	23.3	2.4	-9.5	47.9	54.0	-6.1

Notes:

- a) D.C.F.: Distance Correction Factor
- b) Insert. Loss (dB) = Cable A + Cable B + Cable C
- c) Net (dB) = Reading + Antenna Factor - Pre-amp + Insert. Loss - Transducer Loss - Duty Relaxation (transmitter only).
- d) Negative signs (-) in Margin column signify levels below the limits.
- e) All other emissions not reported are below the equipment noise floor which is at least 20 dB below the limits.

Radiated Emissions Test Data

Company:	Symbol		Model #:	LA4121	Standard:	FCC § 15.247 (R.B.)
EUT:	Antenna	5	S/N #:		Limits:	11
Project #:			Test Date:	April 7, 2000	Test Distance:	3 meters
Test Mode:	Tx @ 2437MHz		Engineer:	Xi-Ming Y.	Duty Relaxation:	0 dB

	Antenna Used			Pre-Amp Used			Cable Used			Transducer Used
Number:	2	21	8	8	10	13	0	0	3	0
Model:	EMCO 3143	3165-9	EMCO 3145	CDI P100 9	AFT18895	ACC400	None	None	Site 2 10m	None

Frequency	Reading	Detector	Ant. #	Amp. #	Ant. Pol.	Ant. Factor	Pre-Amp	Insert. Loss	D.C.F.	Net	Limit @3m	Margin
MHz	dB(µV)	P/A/Q			H/V	dB(1m)	dB	dB	dB	dB(µV/m)	dB(µV/m)	dB
4874.00	34.5	Peak	8	8	H	34.0	28.1	0.0	0.0	40.4	74.0	-33.6
4874.00	24.2	Ave.	8	8	H	34.0	28.1	0.0	0.0	30.1	54.0	-23.9
7310.90	35.5	Peak	8	8	V	38.0	28.0	0.0	0.0	45.5	74.0	-28.5
7310.90	27.9	Ave.	8	8	V	38.0	28.0	0.0	0.0	37.9	54.0	-16.1
19496.00	45.1	Peak	21	13	V	40.2	23.3	2.3	-9.5	54.8	74.0	-19.2
19496.00	35.4	Ave.	21	13	V	40.2	23.3	2.3	-9.5	45.1	54.0	-8.9

Notes:

- a) D.C.F.: Distance Correction Factor
- b) Insert. Loss (dB) = Cable A + Cable B + Cable C
- c) Net (dB) = Reading + Antenna Factor - Pre-amp + Insert. Loss. - Transducer Loss - Duty Relaxation (transmitter only).
- d) Negative signs (-) in Margin column signify levels below the limits
- e) All other emissions not reported are below the equipment noise floor which is at least 20 dB below the limits.

Radiated Emissions Test Data

Company: Symbol	Model #: LA4121	Standard	FCC § 15.247 (R.B.)
EUT: Antenna 5	S/N #:	Limits	11
Project #:	Test Date: April 7, 2000	Test Distance	3 meters
Test Mode: Tx @ 2462MHz	Engineer: Xi-Ming Y.	Duty Relaxation	0 dB

Number	Antenna Used		Pre-Amp Used			Cable Used			Transducer Used	
	2	21	8	10	13	0	0	12	0	
Model:	EMCO 3145	EMCO 3180-9	EMCO 3145	GOI P100 6	APT 1855	ACC 400	None	None	Gm M-	None

Frequency MHz	Reading dBµV	Detector P/A/C	Ant #	Amp #	Ant. Pol. H/V	Ant. Factor dB(1m)	Pre-Amp dB	Insert. Loss dB	D.C. F. dB	Net dB(µV/m)	Limit @3m dB(µV/m)	Margin dB
4923.90	35.9	Peak	8	8	H	34.0	28.1	3.2	0.0	45.0	74.0	-29.0
4923.90	25.0	Ave.	8	8	H	34.0	28.1	3.2	0.0	34.1	54.0	-19.9
7385.90	35.6	Peak	8	8	V	38.0	28.0	4.3	0.0	49.9	74.0	-24.1
7385.90	27.5	Ave.	8	8	V	38.0	28.0	4.3	0.0	41.8	54.0	-12.2
12310.00	38.0	Peak	8	10	V	42.5	39.1	5.9	0.0	47.3	74.0	-26.8
12310.00	30.3	Ave.	8	10	V	42.5	39.1	5.9	0.0	39.6	54.0	-14.5
22158.00	45.1	Peak	21	13	V	40.3	23.3	2.4	-9.5	55.0	74.0	-19.0
22158.00	35.3	Ave.	21	13	V	40.3	23.3	2.4	-9.5	45.2	54.0	-8.8

- Notes:**
- a) D.C.F.: Distance Correction Factor
 - b) Insert. Loss (dB) = Cable A + Cable B + Cable C
 - c) Net (dB) = Reading + Antenna Factor - Pre-amp + Insert. Loss - Transducer Loss - Duty Relaxation (transmitter only)
 - d) Negative signs (-) in Margin column signify levels below the limits
 - e) All other emissions not reported are below the equipment noise floor which is at least 20 dB below the limits

**Radiated Emissions
Test Data**

Company: Symbol				Model #: LA4121		Standard		FCC 15.247 (R.D.)				
EUT: Trilogy 2				Ant#: 50-11900-001		Cable		11				
Project #: J20008658B				Test Date: April 5, 2000		Test Distance		3 meters				
Test Mode: Transmitting on antenna 6				Engineer: Barry S.		Duty Relaxation		0 dB				
Frequency	Reading	Detector	Ant #	Ant. Pol.	Ant. Factor	Pre-Amp	Insert. Loss	D.C.F.	Net	Limit	Margin	
MHz	dB(μV)	PKG	#	HV	dB(μV/m)	dB	dB	dB	dB(μV/m)	dB(μV/m)	dB	
2412												
4824	30.6	Peak	8	8	V	33.5	28.1	3.2	0.0	39.2	74.0	-34.8
4824	23.6	Ave.	8	8	V	33.5	28.1	3.2	0.0	32.2	54.0	-21.8
7236	33.4	Peak	8	8	V	38.0	28.0	4.3	0.0	47.7	74.0	-26.3
7236	26.3	Ave.	8	8	V	38.0	28.0	4.3	0.0	40.6	54.0	-13.4
12060	33.5	Peak	8	10	V	42.5	39.1	5.9	0.0	42.8	74.0	-31.3
12060	26.4	Ave.	8	10	V	42.5	39.1	5.9	0.0	35.7	54.0	-18.4
14472	39.6	Peak	8	10	V	41.5	37.8	6.5	0.0	49.8	74.0	-24.2
14472	32.2	Ave.	8	10	V	41.5	37.8	6.5	0.0	42.4	54.0	-11.6
19296	41.5	Peak	21	13	V	40.2	23.3	7.7	-9.5	56.6	74.0	-17.4
19296	24.5	Ave.	21	13	V	40.2	23.3	7.7	-9.5	39.6	54.0	-14.4
21708	41.9	Peak	21	13	V	40.3	23.3	0.0	-9.5	49.4	74.0	-24.6
21708	23.0	Ave.	21	13	V	40.3	23.3	0.0	-9.5	30.5	54.0	-23.5
2437												
4874	29.4	Peak	8	8	V	33.5	28.1	3.2	0.0	38.0	74.0	-36.0
4874	21.3	Ave.	8	8	V	33.5	28.1	3.2	0.0	29.9	54.0	-24.1
7311	33.6	Peak	8	8	V	38.0	28.0	4.3	0.0	47.9	74.0	-26.1
7311	26.0	Ave.	8	8	V	38.0	28.0	4.3	0.0	40.3	54.0	-13.7
12185	34.4	Peak	8	10	V	42.5	39.1	5.9	0.0	43.7	74.0	-30.4
12185	26.4	Ave.	8	10	V	42.5	39.1	5.9	0.0	35.7	54.0	-18.4
19496	32.0	Peak	21	13	V	40.2	23.3	7.7	-9.5	47.1	74.0	-26.9
19496	21	Ave.	21	13	V	40.2	23.3	7.7	-9.5	36.1	54.0	-17.9
2462												
4924	29.2	Peak	8	8	V	33.5	28.1	4.9	0.0	39.5	74.0	-34.5
4924	21.5	Ave.	8	8	V	33.5	28.1	4.9	0.0	31.8	54.0	-22.2
7386	33.7	Peak	8	8	V	38.0	28.0	6.3	0.0	50.0	74.0	-24.0
7386	25.9	Ave.	8	8	V	38.0	28.0	6.3	0.0	42.2	54.0	-11.8
12310	34.6	Peak	8	10	V	42.5	39.1	8.8	0.0	46.8	74.0	-27.2
12310	27.3	Ave.	8	10	V	42.5	39.1	8.8	0.0	39.5	54.0	-14.5
22158	46.5	Peak	21	13	V	40.3	23.3	0.0	-9.5	54.0	74.0	-20.0
22158	28.2	Ave.	21	13	V	40.3	23.3	0.0	-9.5	35.7	54.0	-18.3

Notes:

- a) D.C.F. Distance Correction Factor
- b) Insert. Loss (dB) = Cable A + Cable B + Cable C
- c) Net (dB) = Reading + Antenna Factor - Pre-amp + Insert. Loss. - Transducer Loss - Duty Relaxation (transmitter only).
- d) Negative signs (-) in Margin column signify levels below the limits.
- e) All other emissions not reported are below the equipment noise floor which is at least 20 dB below the limits.
- f) Readings with DCF -9.5 were taken at 1 meter with RBW 300kHz

**Radiated Emissions
Test Data**

Company: Symbol						Model #: LA4121		Standard		FCC § 15.247 (K.B.)			
EUT: Trilogy 2						Ant #: 9090 16.0001		Limits		11			
Project #: J20008658B						Test Date: April 5, 2000		Test Distance		3		meters	
Test Mode: Transmitting on antenna 7						Engineer: Barry S.		Duty Factor		0		dB	
Frequency	Reading	Detector	Ant. #	Ant. #	Ant. Pol.	Ant. Factor	Pre-Amp	Insert. Loss	D.C.F.	Net	Limit @3m	Margin	
MHz	dB(μV)	F/A/C	f	g	H/V	dB(1m)	dB	dB	dB	dB(μV/m)	dB(μV/m)	dB	
2412													
4824	31.0	Peak	8	8	V	33.5	28.1	3.2	0.0	39.6	74.0	-34.4	
4824	24.6	Ave.	8	8	V	33.5	28.1	3.2	0.0	33.2	54.0	-20.8	
7236	34.4	Peak	8	8	V	38.0	28.0	4.3	0.0	48.7	74.0	-25.3	
7236	26.4	Ave.	8	8	V	38.0	28.0	4.3	0.0	40.7	54.0	-13.3	
12060	32.1	Peak	8	10	V	42.5	39.1	5.9	0.0	41.4	74.0	-32.7	
12060	25.0	Ave.	8	10	V	42.5	39.1	5.9	0.0	34.3	54.0	-19.8	
14472	36.9	Peak	8	10	V	41.5	37.8	6.5	0.0	47.1	74.0	-26.9	
14472	30.0	Ave.	8	10	V	41.5	37.8	6.5	0.0	40.2	54.0	-13.8	
19296	41.6	Peak	21	13	V	40.2	23.3	7.7	-9.5	56.7	74.0	-17.3	
19296	24.6	Ave.	21	13	V	40.2	23.3	7.7	-9.5	39.7	54.0	-14.3	
21708	42.0	Peak	21	13	V	40.3	23.3	0.0	-9.5	49.5	74.0	-24.5	
21708	23.6	Ave.	21	13	V	40.3	23.3	0.0	-9.5	31.1	54.0	-22.9	
2437													
4874	30.6	Peak	8	8	V	33.9	28.1	3.2	0.0	39.6	74.0	-34.4	
4874	23.2	Ave.	8	8	V	33.9	28.1	3.2	0.0	32.2	54.0	-21.8	
7311	34.1	Peak	8	8	V	38.0	28.0	4.3	0.0	48.4	74.0	-25.6	
7311	25.7	Ave.	8	8	V	38.0	28.0	4.3	0.0	40.0	54.0	-14.0	
12185	33.1	Peak	8	10	V	42.3	39.1	5.9	0.0	42.2	74.0	-31.9	
12185	25.6	Ave.	8	10	V	42.3	39.1	5.9	0.0	34.7	54.0	-19.4	
19496	32.8	Peak	21	13	V	40.2	23.3	7.7	-9.5	47.9	74.0	-26.1	
19496	21.5	Ave.	21	13	V	40.2	23.3	7.7	-9.5	36.6	54.0	-17.4	
2462													
4924	30.7	Peak	8	8	V	33.5	28.1	4.9	0.0	41.0	74.0	-33.0	
4924	22.8	Ave.	8	8	V	33.5	28.1	4.9	0.0	33.1	54.0	-20.9	
7386	33.4	Peak	8	8	V	38.0	28.0	6.3	0.0	49.7	74.0	-24.3	
7386	25.9	Ave.	8	8	V	38.0	28.0	6.3	0.0	42.2	54.0	-11.8	
12310	32.2	Peak	8	10	V	42.5	39.1	8.8	0.0	44.4	74.0	-29.6	
12310	25.0	Ave.	8	10	V	42.5	39.1	8.8	0.0	37.2	54.0	-16.8	
22158	46.0	Peak	21	13	V	40.3	23.3	0.0	-9.5	53.5	74.0	-20.5	
22158	37.8	Ave.	21	13	V	40.3	23.3	0.0	-9.5	45.3	54.0	-8.7	

- Notes:**
- a) D.C.F.: Distance Correction Factor
 - b) Insert. Loss (dB) = Cable A + Cable B + Cable C.
 - c) Net (dB) = Reading + Antenna Factor - Pre-amp + Insert. Loss. - Transducer Loss - Duty Relaxation (transmitter only).
 - d) Negative signs (-) in Margin column signify levels below the limits.
 - e) All other emissions not reported are below the equipment noise floor which is at least 20 dB below the limits.
 - f) Readings with -9.5 DCF were taken at 1 meter with RBW 300kHz

**Radiated Emissions
Test Data**

Company: Symbol		Model #: LA4121		Standard		FCC § 15.247 (E-5)						
EUT: Trilogy 2		Ant #: 50-11902-240S		Limits		11						
Project #: J20008658B		Test Date: April 3, 2000		Test Distance		3						
Test Mode: Transmitting on antenna 8		Engineer: Barry S.		Duty Relaxation		0						
Frequency	Reading	Detector	Ant	Amp	Ant. Pol	Ant. Factor	Pre-Amp	Insert Loss	D.C.F.	Net	Limit (dBm)	Margin
MHz	(dBµV)	FW	F	F	HV	(dB/dB)	dB	dB	dB	(dBµV/m)	(dBµV/m)	dB
2412		Peak	8	8	V	33.5	28.1	3.2	0.0	49.8	74.0	-24.2
4824	41.2	Peak	8	8	V	33.5	28.1	3.2	0.0	41.5	54.0	-12.5
4824	32.9	Ave.	8	8	V	33.5	28.1	3.2	0.0	41.5	54.0	-12.5
7236	33.9	Peak	8	8	V	38.0	28.0	4.3	0.0	48.2	74.0	-25.8
7236	25.3	Ave.	8	8	V	38.0	28.0	4.3	0.0	39.6	54.0	-14.4
12060	32.1	Peak	8	10	V	42.5	39.1	5.9	0.0	41.4	74.0	-32.7
12060	24.8	Ave.	8	10	V	42.5	39.1	5.9	0.0	34.1	54.0	-20.0
14472	37.3	Peak	8	10	V	41.5	37.8	6.5	0.0	47.5	74.0	-26.5
14472	29.7	Ave.	8	10	V	41.5	37.8	6.5	0.0	39.9	54.0	-14.1
19296	41.6	Peak	21	13	V	40.2	23.3	7.7	-9.5	56.7	74.0	-17.3
19296	24.6	Ave.	21	13	V	40.2	23.3	7.7	-9.5	39.7	54.0	-14.3
21708	42.0	Peak	21	13	V	40.3	23.3	0.0	-9.5	49.5	74.0	-24.5
21708	23.6	Ave.	21	13	V	40.3	23.3	0.0	-9.5	31.1	54.0	-22.9
2437												
4874	37.6	Peak	14	8	V	33.9	28.1	3.2	0.0	46.6	74.0	-27.4
4874	31.3	Ave.	14	8	V	33.9	28.1	3.2	0.0	40.3	54.0	-13.7
7311	33.8	Peak	14	8	V	38.0	28.0	4.3	0.0	48.1	74.0	-25.9
7311	26.4	Ave.	14	8	V	38.0	28.0	4.3	0.0	40.7	54.0	-13.3
12185	32.3	Peak	14	10	V	42.3	39.1	5.9	0.0	41.4	74.0	-32.7
12185	25.1	Ave.	14	10	V	42.3	39.1	5.9	0.0	34.2	54.0	-19.9
19496	32.8	Peak	21	13	V	40.2	23.3	7.7	-9.5	47.9	74.0	-26.1
19496	21.5	Ave.	21	13	V	40.2	23.3	7.7	-9.5	36.6	54.0	-17.4
2462												
4924	34.3	Peak	8	8	V	33.5	28.1	4.9	0.0	44.6	74.0	-29.4
4924	24.5	Ave.	8	8	V	33.5	28.1	4.9	0.0	34.8	54.0	-19.2
7386	33.7	Peak	8	8	V	38.0	28.0	6.3	0.0	50.0	74.0	-24.0
7386	27.2	Ave.	8	8	V	38.0	28.0	6.3	0.0	43.5	54.0	-10.5
12310	32.3	Peak	8	10	V	42.5	39.1	8.8	0.0	44.5	74.0	-29.5
12310	24.9	Ave.	8	10	V	42.5	39.1	8.8	0.0	37.1	54.0	-16.9
22158	46.0	Peak	21	13	V	40.3	23.3	0.0	-9.5	53.5	74.0	-20.5
22158	36.4	Ave.	21	13	V	40.3	23.3	0.0	-9.5	43.9	54.0	-10.1

- Notes:**
- a) D.C.F.: Distance Correction Factor
 - b) Insert Loss (dB) = Cable A + Cable B + Cable C
 - c) Net (dB) = Reading + Antenna Factor - Pre-amp + Insert Loss - Transducer Loss - Duty Relaxation (transmitter only).
 - d) Negative signs (-) in Margin column signify levels below the limits.
 - e) All other emissions not reported are below the equipment noise floor which is at least 20 dB below the limits.
 - f) Readings with DCF -9.5 were taken at 1 meter with RBW 300kHz

**Radiated Emissions
Test Data**

Company: Symbol				Model #: LA4121		Standard		FCC 47 CFR 15.247 (E-S)				
EUT: Trilogy 2				Ant #: ML-2499-SD24-06		Limits		11				
Project #: J20008658B				Test Date: April 3, 2000		Test Distance		3				
Test Mode: Transmitting on antenna 9				Engineer: Barry S.		Duty Relaxation		0				
Frequency (MHz)	Reading (dB(μV))	Detector (P/A/Q)	Ant. Amp. (#)	Ant. Pol. (#)	Ant. Factor (dB/m)	Pre-Amp (dB)	Insert. Loss (dB)	D. C. F. (dB)	Net (dB(μV/m))	Limit (dB(μV/m))	Margin (dB)	
2412												
4824	37.4	Peak	8	8	V	33.5	28.1	3.2	0.0	46.0	74.0	-28.0
4824	28.4	Ave.	8	8	V	33.5	28.1	3.2	0.0	37.0	54.0	-17.0
7236	33.4	Peak	8	8	V	38.0	28.0	4.3	0.0	47.7	74.0	-26.3
7236	26.4	Ave.	8	8	V	38.0	28.0	4.3	0.0	40.7	54.0	-13.3
12060	34.2	Peak	8	10	V	42.5	39.1	5.9	0.0	43.5	74.0	-30.6
12060	27.1	Ave.	8	10	V	42.5	39.1	5.9	0.0	36.4	54.0	-17.7
14472	41.1	Peak	8	10	V	41.5	37.8	6.5	0.0	51.3	74.0	-22.7
14472	35.0	Ave.	8	10	V	41.5	37.8	6.5	0.0	45.2	54.0	-8.8
19296	41.2	Peak	21	13	V	40.2	23.3	7.7	-9.5	56.3	74.0	-17.7
19296	25.0	Ave.	21	13	V	40.2	23.3	7.7	-9.5	40.1	54.0	-13.9
21708	41.0	Peak	21	13	V	40.3	23.3	0.0	-9.5	48.5	74.0	-25.5
21708	24.4	Ave.	21	13	V	40.3	23.3	0.0	-9.5	31.9	54.0	-22.1
2437												
4874	35.6	Peak	14	8	V	33.9	28.1	3.2	0.0	44.6	74.0	-29.4
4874	25.4	Ave.	14	8	V	33.9	28.1	3.2	0.0	34.4	54.0	-19.6
7311	34.0	Peak	14	8	V	38.0	28.0	4.3	0.0	48.3	74.0	-25.7
7311	26.4	Ave.	14	8	V	38.0	28.0	4.3	0.0	40.7	54.0	-13.3
12185	35.1	Peak	14	10	V	42.3	39.1	5.9	0.0	44.2	74.0	-29.9
12185	27.9	Ave.	14	10	V	42.3	39.1	5.9	0.0	37.0	54.0	-17.1
19496	32.9	Peak	21	13	V	40.2	23.3	7.7	-9.5	48.0	74.0	-26.0
19496	23.4	Ave.	21	13	V	40.2	23.3	7.7	-9.5	38.5	54.0	-15.5
2462					V							
4924	30.5	Peak	8	8	V	33.5	28.1	4.9	0.0	40.8	74.0	-33.2
4924	23.3	Ave.	8	8	V	33.5	28.1	4.9	0.0	33.5	54.0	-20.4
7386	34.0	Peak	8	8	V	38.0	28.0	6.3	0.0	50.3	74.0	-23.7
7386	26.5	Ave.	8	8	V	38.0	28.0	6.3	0.0	42.8	54.0	-11.2
12310	35.1	Peak	8	10	V	42.5	39.1	8.8	0.0	47.3	74.0	-26.7
12310	29.5	Ave.	8	10	V	42.5	39.1	8.8	0.0	41.7	54.0	-12.3
22158	45.0	Peak	21	13	V	40.3	23.3	0.0	-9.5	52.5	74.0	-21.5
22158	35.5	Ave.	21	13	V	40.3	23.3	0.0	-9.5	43.0	54.0	-11.0

- Notes:**
- a) D.C.F. Distance Correction Factor
 - b) insert. Loss (dB) = Cable A + Cable B + Cable C.
 - c) Net (dB) = Reading + Antenna Factor - Pre-amp + Insert. Loss. - Transducer Loss - Duty Relaxation (transmitter only).
 - d) Negative signs (-) in Margin column signify levels below the limits.
 - e) All other emissions not reported are below the equipment noise floor which is at least 20 dB below the limits.
 - f) Readings with DCF -9.5 were taken at 1 meter with RBW 300kHz

**Radiated Emissions
Test Data**

Company:		Symbol		Model #:		LA4121		Standard		FCC § 15.247 (R.B.)			
EUT:		Trilogy 2		Ant #:		21-20667-01		Limits		11			
Project #:		J20008658B		Test Date:		April 3, 2000		Test Distance		3			
Test Mode:		Transmitting on antenna		O		Engineer:		Barry S.		Duty Relaxation		0	
Frequency	Reading	Detector	Ant	Amp	Ant Pol.	Ant Factor	Pre-Amp	Insert Loss	D.C.F.	Net	Limit (3m)	Margin	
MHz	dB(μV)	PKG	F	F	LV	(dB/m)	dB	dB	dB	dB(μV/m)	dB(μV/m)	dB	
2412													
4824	21.7	Peak	8	8	V	33.5	28.1	3.2	0.0	30.3	74.0	-43.7	
4824	15.9	Ave.	8	8	V	33.5	28.1	3.2	0.0	24.5	54.0	-29.5	
7236	31.1	Peak	8	8	V	38.0	28.0	4.3	0.0	45.4	74.0	-28.6	
7236	25.5	Ave.	8	8	V	38.0	28.0	4.3	0.0	39.8	54.0	-14.2	
12060	33.9	Peak	8	10	V	42.5	39.1	5.9	0.0	43.2	74.0	-30.9	
12060	26.8	Ave.	8	10	V	42.5	39.1	5.9	0.0	36.1	54.0	-18.0	
14472	39.3	Peak	8	10	V	41.5	37.8	6.5	0.0	49.5	74.0	-24.5	
14472	32.2	Ave.	8	10	V	41.5	37.8	6.5	0.0	42.4	54.0	-11.6	
19296	39.8	Peak	21	13	V	40.2	23.3	7.7	-9.5	54.9	74.0	-19.1	
19296	24.1	Ave.	21	13	V	40.2	23.3	7.7	-9.5	39.2	54.0	-14.8	
21708	29.9	Peak	21	13	V	40.3	23.3	0.0	-9.5	37.4	74.0	-36.6	
21708	23.3	Ave.	21	13	V	40.3	23.3	0.0	-9.5	30.8	54.0	-23.2	
2437													
4874	30.8	Peak	8	8	V	33.5	28.1	3.2	0.0	39.4	74.0	-34.6	
4874	23.9	Ave.	8	8	V	33.5	28.1	3.2	0.0	32.5	54.0	-21.5	
7311	33.7	Peak	8	8	V	38.0	28.0	4.3	0.0	48.0	74.0	-26.0	
7311	25.8	Ave.	8	8	V	38.0	28.0	4.3	0.0	40.1	54.0	-13.9	
12185	34.8	Peak	8	10	V	42.5	39.1	5.9	0.0	43.9	74.0	-30.2	
12185	27.5	Ave.	8	10	V	42.5	39.1	5.9	0.0	36.8	54.0	-17.3	
19496	29.0	Peak	21	13	V	40.2	23.3	7.7	-9.5	44.1	74.0	-29.9	
19496	21.5	Ave.	21	13	V	40.2	23.3	7.7	-9.5	36.6	54.0	-17.4	
2462													
4924	39.6	Peak	8	8	V	33.5	28.1	4.9	0.0	49.9	74.0	-24.1	
4924	32.2	Ave.	8	8	V	33.5	28.1	4.9	0.0	42.5	54.0	-11.5	
7386	31.1	Peak	8	8	V	38.0	28.0	6.3	0.0	47.4	74.0	-26.6	
7386	26.0	Ave.	8	8	V	38.0	28.0	6.3	0.0	42.3	54.0	-11.7	
12310	34.8	Peak	8	10	V	42.5	39.1	8.8	0.0	47.0	74.0	-27.0	
12310	27.5	Ave.	8	10	V	42.5	39.1	8.8	0.0	39.7	54.0	-14.3	
22158	45.1	Peak	21	13	V	40.3	23.3	0.0	-9.5	52.6	74.0	-21.4	
22158	32.0	Ave.	21	13	V	40.3	23.3	0.0	-9.5	39.5	54.0	-14.5	

Notes:

- a) D.C.F.: Distance Correction Factor
- b) Insert Loss (dB) = Cable A + Cable B + Cable C.
- c) Net (dB) = Reading + Antenna Factor - Pre-amp + Insert. Loss. - Transducer Loss - Duty Relaxation (transmitter only).
- d) Negative signs (-) in Margin column signify levels below the limits.
- e) All other emissions not reported are below the equipment noise floor which is at least 20 dB below the limits.
- f) Readings with DCF -9.5 were taken at 1 meter with RBW 300kHz

**Radiated Emissions
Test Data**

Company: Symbol						Model #: LA4121		Standard		FCC 47 CFR 15.247 (E-8)		
EUT: Trilogy 2						Ant #: Vocollect		Limits		11		
Project #: J20008658B						Test Date: April 3, 2000		Test Distance		3		
Test Mode: Transmitting on antenna 11						Engineer: Barry S.		Duty Relaxation		0		
Frequency	Reading	Detector	Ant	Asp.	Ant Pol	Ant Factor	Pre-Amp	Insert Loss	D.C.F.	Net	Limit	Margin
MHz	dB(μV)	PK/A	F	F	dB	dB/m	dB	dB	dB	dB(μV/m)	dB(μV/m)	dB
2412												
4824	28.9	Peak	8	8	V	33.5	28.1	3.2	0.0	37.5	74.0	-36.5
4824	22.4	Ave.	8	8	V	33.5	28.1	3.2	0.0	31.0	54.0	-23.0
7236	31.0	Peak	8	8	V	38.0	28.0	4.3	0.0	45.3	74.0	-28.7
7236	25.9	Ave.	8	8	V	38.0	28.0	4.3	0.0	40.2	54.0	-13.8
12060	34.4	Peak	8	10	V	42.5	39.1	5.9	0.0	43.7	74.0	-30.4
12060	26.6	Ave.	8	10	V	42.5	39.1	5.9	0.0	35.9	54.0	-18.2
14472	40.5	Peak	8	10	V	41.5	37.8	6.5	0.0	50.7	74.0	-23.3
14472	32.2	Ave.	8	10	V	41.5	37.8	6.5	0.0	42.4	54.0	-11.6
19296	36.0	Peak	21	13	V	40.2	23.3	7.7	-9.5	51.1	74.0	-22.9
19296	24.0	Ave.	21	13	V	40.2	23.3	7.7	-9.5	39.1	54.0	-14.9
21708	42.0	Peak	21	13	V	40.3	23.3	0.0	-9.5	49.5	74.0	-24.5
21708	22.9	Ave.	21	13	V	40.3	23.3	0.0	-9.5	30.4	54.0	-23.6
2437												
4874	28.6	Peak	8	8	V	33.5	28.1	3.2	0.0	37.2	74.0	-36.8
4874	21.2	Ave.	8	8	V	33.5	28.1	3.2	0.0	29.8	54.0	-24.2
7311	33.5	Peak	8	8	V	38.0	28.0	4.3	0.0	47.8	74.0	-26.2
7311	26.0	Ave.	8	8	V	38.0	28.0	4.3	0.0	40.3	54.0	-13.7
12185	33.9	Peak	8	10	V	42.5	39.1	5.9	0.0	43.2	74.0	-30.9
12185	26.7	Ave.	8	10	V	42.5	39.1	5.9	0.0	36.0	54.0	-18.1
19496	31.6	Peak	21	13	V	40.2	23.3	7.7	-9.5	46.7	74.0	-27.3
19496	19.8	Ave.	21	13	V	40.2	23.3	7.7	-9.5	34.9	54.0	-19.1
2462												
4924	29.4	Peak	8	8	V	33.5	28.1	4.9	0.0	39.7	74.0	-34.3
4924	21.4	Ave.	8	8	V	33.5	28.1	4.9	0.0	31.7	54.0	-22.3
7386	33.0	Peak	8	8	V	38.0	28.0	6.3	0.0	49.3	74.0	-24.7
7386	26.0	Ave.	8	8	V	38.0	28.0	6.3	0.0	42.3	54.0	-11.7
12310	34.5	Peak	8	10	V	42.5	39.1	8.8	0.0	46.7	74.0	-27.3
12310	27.7	Ave.	8	10	V	42.5	39.1	8.8	0.0	39.9	54.0	-14.1
22158	45.5	Peak	21	13	V	40.3	23.3	0.0	-9.5	53.0	74.0	-21.0
22158	36.0	Ave.	21	13	V	40.3	23.3	0.0	-9.5	43.5	54.0	-10.5

Notes:

- a) D.C.F.: Distance Correction Factor
- b) Insert Loss (dB) = Cable A + Cable B + Cable C
- c) Net (dB) = Reading + Antenna Factor - Pre-amp + Insert Loss - Transducer Loss - Duty Relaxation (transmitter only)
- d) Negative signs (-) in Margin column signify levels below the limits.
- e) All other emissions not reported are below the equipment noise floor which is at least 20 dB below the limits.
- f) Readings with DCF -9.5 were taken at 1 meter with RBW 300kHz

Radiated Emissions Test Data

Company: Symbol				Model #: LA4121		Standard		FCC 15.247 (P.B.)				
EUT: Trilogy 2				Ant #: 50-21900-022		Limits		11				
Project #: J20008658B				Test Date: April 3, 2000		Test Distance		3 meters				
Test Mode: Transmitting on antenna 2				Engineer: Barry S.		Data Calibration		0 dB				
Frequency	Reading	Detector	Ant. #	Asp. #	Ant. Pol.	Ant. Factor	Pre-Amp	Insert. Loss	D.C.F.	Net	Limit	Margin
MHz	dB(A)	Pk/Ave	#	#	V	dB(m)	dB	dB	dB	dB(A/m)	dB(A/m)	dB
2412												
4824	39.5	Peak	8	8	V	33.5	28.1	3.2	0.0	48.1	74.0	-25.9
4824	29.2	Ave.	8	8	V	33.5	28.1	3.2	0.0	37.8	54.0	-16.2
7236	34.5	Peak	8	8	V	38.0	28.0	4.3	0.0	48.8	74.0	-25.2
7236	26.8	Ave.	8	8	V	38.0	28.0	4.3	0.0	41.1	54.0	-12.9
12060	33.9	Peak	8	10	V	42.5	39.1	5.9	0.0	43.2	74.0	-30.9
12060	26.6	Ave.	8	10	V	42.5	39.1	5.9	0.0	35.9	54.0	-18.2
14472	39.0	Peak	8	10	V	41.5	37.8	6.5	0.0	49.2	74.0	-24.8
14472	31.4	Ave.	8	10	V	41.5	37.8	6.5	0.0	41.6	54.0	-12.4
19296	42.1	Peak	21	13	V	40.2	23.3	7.7	-9.5	57.2	74.0	-16.8
19296	25.0	Ave.	21	13	V	40.2	23.3	7.7	-9.5	40.1	54.0	-13.9
21708	42.4	Peak	21	13	V	40.3	23.3	0.0	-9.5	49.9	74.0	-24.1
21708	24.0	Ave.	21	13	V	40.3	23.3	0.0	-9.5	31.5	54.0	-22.5
2437												
4874	35.0	Peak	8	8	V	33.5	28.1	3.2	0.0	43.6	74.0	-30.4
4874	27.2	Ave.	8	8	V	33.5	28.1	3.2	0.0	35.8	54.0	-18.2
7311	34.5	Peak	8	8	V	38.0	28.0	4.3	0.0	48.8	74.0	-25.2
7311	27.4	Ave.	8	8	V	38.0	28.0	4.3	0.0	41.7	54.0	-12.3
12185	33.4	Peak	8	10	V	42.5	39.1	5.9	0.0	42.7	74.0	-31.4
12185	26.5	Ave.	8	10	V	42.5	39.1	5.9	0.0	35.8	54.0	-18.3
19496	31.0	Peak	21	13	V	40.2	23.3	7.7	-9.5	46.1	74.0	-27.9
19496	19.7	Ave.	21	13	V	40.2	23.3	7.7	-9.5	34.8	54.0	-19.2
2462												
4924	34.5	Peak	8	8	V	33.5	28.1	4.9	0.0	44.8	74.0	-29.2
4924	25.9	Ave.	8	8	V	33.5	28.1	4.9	0.0	36.2	54.0	-17.8
7386	34.0	Peak	8	8	V	38.0	28.0	6.3	0.0	50.3	74.0	-23.7
7386	27.0	Ave.	8	8	V	38.0	28.0	6.3	0.0	43.3	54.0	-10.7
12310	32.6	Peak	8	10	V	42.5	39.1	8.8	0.0	44.8	74.0	-29.2
12310	27.0	Ave.	8	10	V	42.5	39.1	8.8	0.0	39.2	54.0	-14.8
22158	45.3	Peak	21	13	V	40.3	23.3	0.0	-9.5	52.8	74.0	-21.2
22158	31.1	Ave.	21	13	V	40.3	23.3	0.0	-9.5	38.6	54.0	-15.4

- Notes:**
- a) D.C.F.: Distance Correction Factor
 - b) Insert. Loss (dB) = Cable A + Cable B + Cable C.
 - c) Net (dB) = Reading + Antenna Factor - Pre-amp + Insert. Loss. - Transducer Loss - Duty Relaxation (transmitter only).
 - d) Negative signs (-) in Margin column signify levels below the limits.
 - e) All other emissions not reported are below the equipment noise floor which is at least 20 dB below the limits.
 - f) Readings with DCF -9.5 were taken at 1 meter with RBW 300kHz

**Radiated Emissions
Test Data**

Company: Symbol						Model #: LA4121		Standards		FCC § 15.247 (3C-B)		
EUT: Trilogy 2						Ant #: 10-41003-01		Limits		11		
Project #: J20008658B						Test Date: April 5, 2000		Test Distance		3 meters		
Test Mode: Transmitting on antenna 3						Engineer: Barry S.		Duty Relaxation		0 dB		
Frequency	Reading	Detector	Ant #	Amp #	Ant. Pol.	Ant. Factor	Pre-Amp	Insert Loss	D.C.F.	Net	Limit	Margin
MHz	dBµV	PAW	#	#	dB	dB(1/m)	dB	dB	dB	dBµV/m	dBµV/m	dB
2412												
4824	31.2	Peak	8	8	V	33.5	28.1	3.2	0.0	39.8	74.0	-34.2
4824	22.8	Ave.	8	8	V	33.5	28.1	3.2	0.0	31.4	54.0	-22.6
7236	33.7	Peak	8	8	V	38.0	28.0	4.3	0.0	48.0	74.0	-26.0
7236	25.9	Ave.	8	8	V	38.0	28.0	4.3	0.0	40.2	54.0	-13.8
12060	34.2	Peak	8	10	V	42.5	39.1	5.9	0.0	43.5	74.0	-30.6
12060	26.5	Ave.	8	10	V	42.5	39.1	5.9	0.0	35.8	54.0	-18.3
14472	39.4	Peak	8	10	V	41.5	37.8	6.5	0.0	49.6	74.0	-24.4
14472	32.0	Ave.	8	10	V	41.5	37.8	6.5	0.0	42.2	54.0	-11.8
19296	41.6	Peak	21	13	V	40.2	23.3	7.7	-9.5	56.7	74.0	-17.3
19296	24.6	Ave.	21	13	V	40.2	23.3	7.7	-9.5	39.7	54.0	-14.3
21708	42.0	Peak	21	13	V	40.3	23.3	0.0	-9.5	49.5	74.0	-24.5
21708	23.6	Ave.	21	13	V	40.3	23.3	0.0	-9.5	31.1	54.0	-22.9
2437												
4874	30.2	Peak	8	8	V	33.5	28.1	3.2	0.0	38.8	74.0	-35.2
4874	23.5	Ave.	8	8	V	33.5	28.1	3.2	0.0	32.1	54.0	-21.9
7311	33.2	Peak	8	8	V	38.0	28.0	4.3	0.0	47.5	74.0	-26.5
7311	25.6	Ave.	8	8	V	38.0	28.0	4.3	0.0	39.9	54.0	-14.1
12185	34.7	Peak	8	10	V	42.5	39.1	5.9	0.0	44.0	74.0	-30.1
12185	26.6	Ave.	8	10	V	42.5	39.1	5.9	0.0	35.9	54.0	-18.2
19496	32.8	Peak	21	13	V	40.2	23.3	7.7	-9.5	47.9	74.0	-26.1
19496	21.5	Ave.	21	13	V	40.2	23.3	7.7	-9.5	36.6	54.0	-17.4
2462					V							
4924	29.6	Peak	8	8	V	33.5	28.1	4.9	0.0	39.9	74.0	-34.1
4924	21.6	Ave.	8	8	V	33.5	28.1	4.9	0.0	31.9	54.0	-22.1
7386	33.5	Peak	8	8	V	38.0	28.0	6.3	0.0	49.8	74.0	-24.2
7386	25.9	Ave.	8	8	V	38.0	28.0	6.3	0.0	42.2	54.0	-11.8
12310	34.2	Peak	8	10	V	42.5	39.1	8.8	0.0	46.4	74.0	-27.6
12310	27.2	Ave.	8	10	V	42.5	39.1	8.8	0.0	39.4	54.0	-14.6
22158	46.0	Peak	21	13	V	40.3	23.3	0.0	-9.5	53.5	74.0	-20.5
22158	37.8	Ave.	21	13	V	40.3	23.3	0.0	-9.5	45.3	54.0	-8.7

- Notes:**
- a) D.C.F.: Distance Correction Factor
 - b) Insert Loss (dB) = Cable A + Cable B + Cable C
 - c) Net (dB) = Reading + Antenna Factor - Pre-amp + Insert Loss - Transducer Loss - Duty Relaxation (transmitter only).
 - d) Negative signs (-) in Margin column signify levels below the limits.
 - e) All other emissions not reported are below the equipment noise floor which is at least 20 dB below the limits.
 - f) Readings with DCF -9.5 were taken at 1 meter with RBW 300kHz

**Radiated Emissions
Test Data**

Company: Symbol						Model #: LA4121		Standard		FCC § 15.247 (R.B.)		
EUT: Trilogy 2						Ant #: ML-3099-PCEC-02		Limits		11		
Project #: J20008658B						Test Date: April 3, 2000		Test Distance		3 meters		
Test Mode: Transmitting #14						Engineer: Barry S.		Duty Relaxation		0 dB		
Frequency	Reading	Detector	Ant #	Amp #	Ant. Pol.	Ant. Factor	Pre-Amp	Insert Loss	D. C. F.	Net	Limit @3m	Margin
MHz	dB(µV)	P/A/Q	#	#	H/V	dB(1/m)	dB	dB	dB	dB(µV/m)	dB(µV/m)	dB
2412												
4824	33.4	Peak	8	8	V	33.5	28.1	3.2	0.0	42.0	74.0	-32.0
4824	19.8	Ave.	8	8	V	33.5	28.1	3.2	0.0	28.4	54.0	-25.6
7236	32.6	Peak	8	8	V	38.0	28.0	4.3	0.0	46.9	74.0	-27.1
7236	24.7	Ave.	8	8	V	38.0	28.0	4.3	0.0	39.0	54.0	-15.0
12060	33.5	Peak	8	10	V	42.5	39.1	5.9	0.0	42.8	74.0	-31.3
12060	25.4	Ave.	8	10	V	42.5	39.1	5.9	0.0	34.7	54.0	-19.4
14472	39.0	Peak	8	10	V	41.5	37.8	6.5	0.0	49.2	74.0	-24.8
14472	31.5	Ave.	8	10	V	41.5	37.8	6.5	0.0	41.7	54.0	-12.3
19296	39.6	Peak	21	13	V	40.2	23.3	7.7	-9.5	54.7	74.0	-19.3
19296	24.6	Ave.	21	13	V	40.2	23.3	7.7	-9.5	39.7	54.0	-14.3
21708	42.0	Peak	21	13	V	40.3	23.3	0.0	-9.5	49.5	74.0	-24.5
21708	23.6	Ave.	21	13	V	40.3	23.3	0.0	-9.5	31.1	54.0	-22.9
2437												
4874	25.7	Peak	14	8	V	33.9	28.1	3.2	0.0	34.7	74.0	-39.3
4874	16.2	Ave.	14	8	V	33.9	28.1	3.2	0.0	25.2	54.0	-28.8
7311	32.8	Peak	14	8	V	38.0	28.0	4.3	0.0	47.1	74.0	-26.9
7311	24.8	Ave.	14	8	V	38.0	28.0	4.3	0.0	39.1	54.0	-14.9
12185	33.5	Peak	14	10	V	42.3	39.1	5.9	0.0	42.6	74.0	-31.5
12185	25.8	Ave.	14	10	V	42.3	39.1	5.9	0.0	34.9	54.0	-19.2
19496	32.8	Peak	21	13	V	40.2	23.3	7.7	-9.5	47.9	74.0	-26.1
19496	22.4	Ave.	21	13	V	40.2	23.3	7.7	-9.5	37.5	54.0	-16.5
2462												
4924	27.4	Peak	8	8	H	34.0	28.1	4.9	0.0	38.2	74.0	-35.8
4924	16.9	Ave.	8	8	H	34.0	28.1	4.9	0.0	27.7	54.0	-26.3
7386	32.3	Peak	8	8	H	36.8	28.0	6.3	0.0	47.4	74.0	-26.6
7386	25.6	Ave.	8	8	H	36.8	28.0	6.3	0.0	40.7	54.0	-13.3
12310	34.1	Peak	8	10	H	44.1	39.1	8.8	0.0	47.9	74.0	-26.1
12310	26.5	Ave.	8	10	H	44.1	39.1	8.8	0.0	40.3	54.0	-13.7
22158	43.0	Peak	21	13	H	40.3	23.3	0.0	-9.5	50.5	74.0	-23.5
22158	34.6	Ave.	21	13	H	40.3	23.3	0.0	-9.5	42.1	54.0	-11.9

Notes:

- a) D.C.F.: Distance Correction Factor
- b) Insert Loss (dB) = Cable A + Cable B + Cable C
- c) Net (dB) = Reading + Antenna Factor - Pre-amp + Insert Loss - Transducer Loss - Duty Relaxation (transmitter only)
- d) Negative signs (-) in Margin column signify levels below the limits.
- e) All other emissions not reported are below the equipment noise floor which is at least 20 dB below the limits.
- f) Readings with -9.5 DCF were taken at 1 meter with RBW 300kHz

A

1365 Adams Ct. Menlo Park, CA 94025

Symbol Technologies, Model No. LA4121
FCC ID:

Date of Test: April 3 & 7, 2000

4.7 AC Line Conducted Emission, FCC Rule 15.207:

Test was performed according the ANSI C63.4 requirements.

Not required; battery operation only

Test data in DoC report

A

1365 Adams Ct. Menlo Park, CA 94025

Symbol Technologies, Model No. LA4121
FCC ID:

Date of Test: April 3 & 7, 2000

4.8 Radiated Emissions from Digital Section of Transceiver (Transmitter), FCC Ref: 15.109

- Not required - No digital part
- Test results are attached
- Included in the separate DOC report.

A

1365 Adams Ct. Menlo Park, CA 94025

Symbol Technologies, Model No. LA4121

Date of Test: April 3 & 7, 2000

FCC ID:

4.9 Radiated Emissions from Receiver Section of Transceiver (L.O. Radiation), FCC Ref: 15.109, 15.111

[x] Not required - EUT operation above 960 MHz only

[] Not required - EUT is transmitter only

[] Test results are attached

Symbol Technologies, Model No. LA4121
FCC ID:

Date of Test: April 3 & 7, 2000

4.10 Processing Gain Measurements, FCC Rule 15.247(e)

The processing gain shall be determined from the ratio in dB of the signal to noise ratio with the system spreading code turned OFF, to the signal to noise ratio with the system spreading code turned ON, as measured at the demodulated output of the receiver. The processing gain shall be at least 10 dB for a direct sequence spread spectrum system.

	Refer to attached test procedure and data sheets.
X	Refer to circuit analysis and processing gain calculations provided by manufacturer.

Symbol Technologies, Model No. LA4121
FCC ID:

Date of Test: April 3 & 7, 2000

4.11 Transmitter Duty Cycle Calculation and Measurements, FCC Rule 15.35(b), (c)

The EUT antenna output port was connected to the input of the spectrum analyzer. The analyzer center frequency was set to EUT RF channel carrier. The SWEEP function on the analyzer was set to ZERO SPAN. The transmitter ON time was determined from the resultant time-amplitude display:

Duty cycle = Maximum ON time in 100 msec/100

Duty cycle correction, dB = $20 * \log(\text{DC})$

	See attached spectrum analyzer chart(s) for transmitter timing
	See transmitter timing diagram provided by manufacturer
X	No Duty cycle correction was used

A

1365 Adams Ct. Menlo Park, CA 94025

Symbol Technologies, Model No. LA4121
FCC ID:

Date of Test: April 3 & 7, 2000

5.0 Appendix A : Plots

Processing Gain Calculation Symbol Technologies LA-4121 WLAN PC Card

Norman H. Nelson, Sr. EMC Engineer
May 8, 2000

Symbol calculated the processing gain from the jamming margin of the LA-4121 transceiver as specified in 15.247 (e)(2).

Test Setup

The purpose of the jamming test is to determine how effective the modulation, coding and decoding is at rejecting the corrupting influence of a CW jammer signal. Where as most setups use a BER to generate data and count errors because the modulator chip architecture prevents injecting data after chipping, Symbol chose to use another LA-4121 as the transmitter and data generator. A link between the transmitter and receiver is made and path loss adjusted so that the BER is $10E-5$. The path loss is then reduced by 10 dB so that the BER approaches zero. Finally a jamming signal is combined with the transmitted signal to degrade the system performance. The jamming signal amplitude is then adjusted to the point that the BER is degraded to $10E-5$.

The relationship between PER and BER is as follows. In order to get a good packet we need 8×1024 good bits. Stated mathematically. $1 - \text{PER} = (1 - \text{BER})^{(8 \times 24)}$. Or $\text{BER} = 1 - (1 - \text{PER})^{(1/(8 \times 1024))}$.

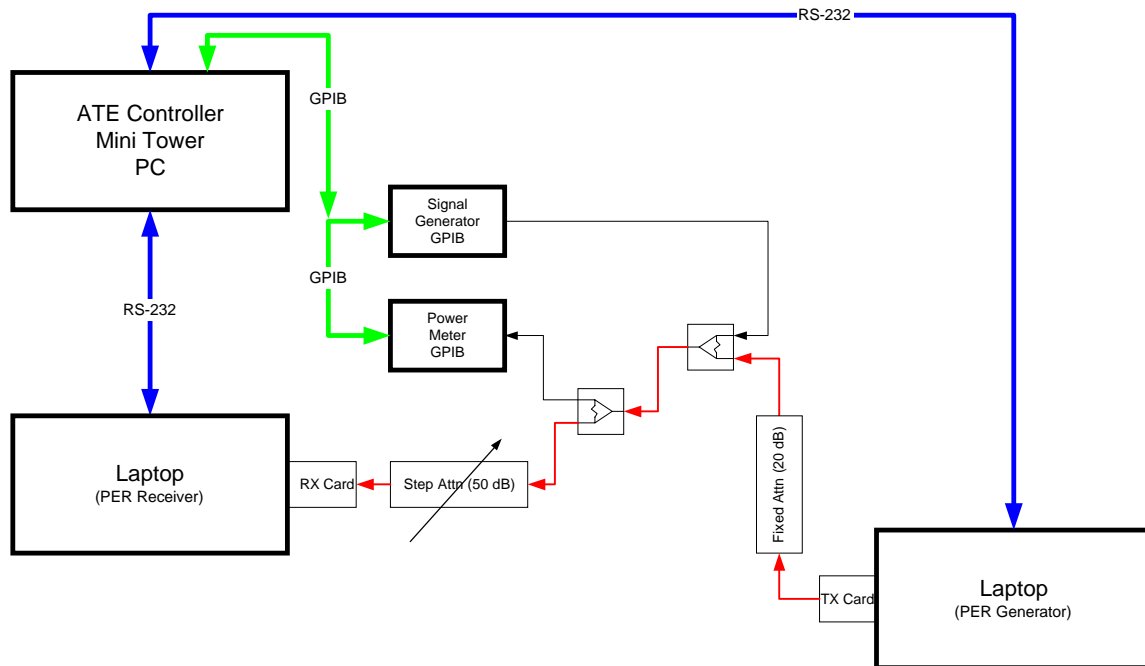

Jamming Margin Test Setup

The major blocks of the jamming margin test are a transmitter, a receiver, and a jammer. The TX card formats and transmits packets of data consisting of 1024 bytes

each. The RX card then attempts to read each packet. The Signal Generator provides the jamming signal. The splitters combine the TX and jammer signals and provide a port to measure the power levels within the RF link. The PER Generator Laptop controls the transmit card and the PER receiver laptop controls the receiver. The ATE PC automates the test by controlling the two laptops, the Signal Generator, and the power meter.

Software blocks

The key to this test is three software programs Packet Generator (PG), Packet Counter (PC), and Jam Margin Controller (JMC). The first two work together to form the PER measurement system and the last to control the jammer, the power meter, and the other two software blocks.

Packet Generator runs on the PG Laptop and controls the transmit card. A trigger on the serial port line commands the TX card to generate and transmit 1000 packets of 1024 bytes at a specified data rate.

Packet Counter runs on the PER receiver laptop and queries the RX card for the number of packets it has received. A trigger on the serial port causes the Packet Counter to report the number of packets to the ATE Controller and reset the Packet Counter to zero. The Packet counter automatically detects the data rate of the incoming packet stream.

The other Jamming Margin Controller (JMC) runs on the ATE PC and controls the Signal Generator, the Power Meter, and PGAC running on the Dual Slot laptop.

PG commands the TX card to transmit a set of 1000 packets of 1024 bytes of data. The RX card receives the packets and PC sends the number of good packets received to the serial port. The functional purpose is the same as a BER meter. A new set is run every time a new trigger is received on the serial port from JMC.

JMC controls the jammer, the power meter, and the Dual Slot program. JMC sets the frequency and level of the signal generator that acts as a jammer. JMC then sends a trigger to PG. The trigger causes PG to run another set of packets and PC reports the number of good packets back to JMC. The packet error rate is then converted to BER and JMC adjusts the Jammer level appropriately. A search algorithm is built into JMC to have the jammer converge to the right level for a $10E-5$ BER. The jammer resolution is .1 dB.

When the jammer level causes a BER of $10E-5$, the JMC program turns off the TX card and commands the power meter to read the jammer power level. JMC then turns off the jammer, turns on the TX card, and measures its power. Then S is offset for duty cycle and J/S is calculated from the two power measurements and recorded to disk. In this way as the test progresses and the TX card warms up power fluctuations due to temperature are referenced out.

The test is then repeated at the next jammer frequency. In this instance the test is conducted across the band of a single channel at 50KHz steps.

Data Rate and Modulation Description

Modulation Technique and Data rates

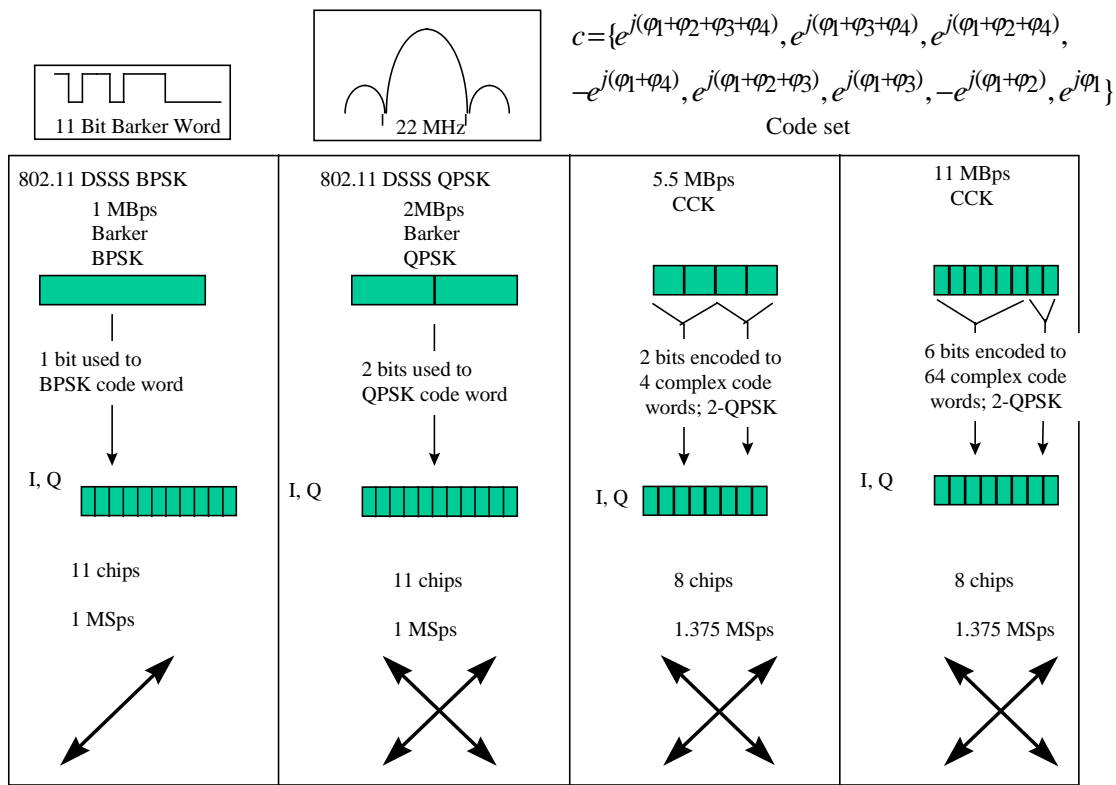

Mode	Chip/Symbol
1 MBps	11/1
2 MBps	11/2
5.5 MBps	8/2
11 MBps	8/8

Gp Calculation from J/S data

$$G_p = E_b/N_0 + J/S + L_{\text{sys}}$$

$$\text{Where } L_{\text{sys}} \leq 2 \text{ dB}$$

Mbps	E_b/N_0 (dB)	$G_p = J/S +$
1	10.6	12.6
2	10.6	12.6
5.5	15.6	17.6
11	16.6	18.6

Test Results

Attached are two plots of J/S and G_p vs F in MHz for 11 Mbps and 2 Mbps. The two plots are the worst case modes for each chipping rate. Theoretical calculations are given for the 1 and 5.5 Mbps modes.

The lower line shows the J/S as taken from the power ratios measured with the power meter. The upper line shows the processing gain G_p as calculated from the Jamming Margin data. Note that the lowest 20% of the data points were discarded as specified in 15.247 (e)(2).

Theoretical calculations

1 Mbps mode using BPSK

The processing gain is defined by:

$$PG = W_{ss}/R_b$$

W_{ss} is the bandwidth (11.2 MHz min).
 R_b is the data rate (1 Mbps)

$$\begin{aligned} PG &= 11.2 \text{ MHz}/1 \text{ Mbps} \\ &= 11.2 \\ &= 10\text{Log}_{10}(11.2) \\ &= 10.49 \text{ dB} \end{aligned}$$

5.5 Mbps mode using CCK

The processing gain is defined by:

$$PG = \text{BW reduction} + \text{Coding Gain}$$

$$\text{BW reduction} = \frac{\text{Chip Rate}}{\text{Symbol Rate}}$$

$$\begin{aligned} &= 10\text{Log}_{10}(11 \text{ MCps}/1.375 \\ &\quad \text{MSps}) \\ &= 9.03 \text{ dB} \end{aligned}$$

Coding Gain

$$\begin{aligned} &= 1.7 @ 11 \text{ Mbps} \\ &= 2.0 @ 5.5 \text{ Mbps} \end{aligned}$$

$$\begin{aligned} PG &= 9.03 + 2.0 \\ &= 11.03 \text{ dB} \end{aligned}$$

¹ Simon Omura, Scholtz, and Levitt *Spread Spectrum Communications Handbook* (New York: McGraw Hill, 1994), p. 138
LA-4121 Processing Gain Calculations

Results Table

Mode (Mbps)	Gp (dB)
1	10.49
2	10.13
5.5	11.03
11	11.39



Read from JS File.vi
Path: .\LabView\Project\Jamming\Read from JS File.vi
Last modified on 4/13/00 at 1:43 PM
Printed on 4/13/00 at 2:04 PM

File T2-11 Run 1 80 dB Attn.dat

LA-4121 Processing Gain Plot: 11 Mbps

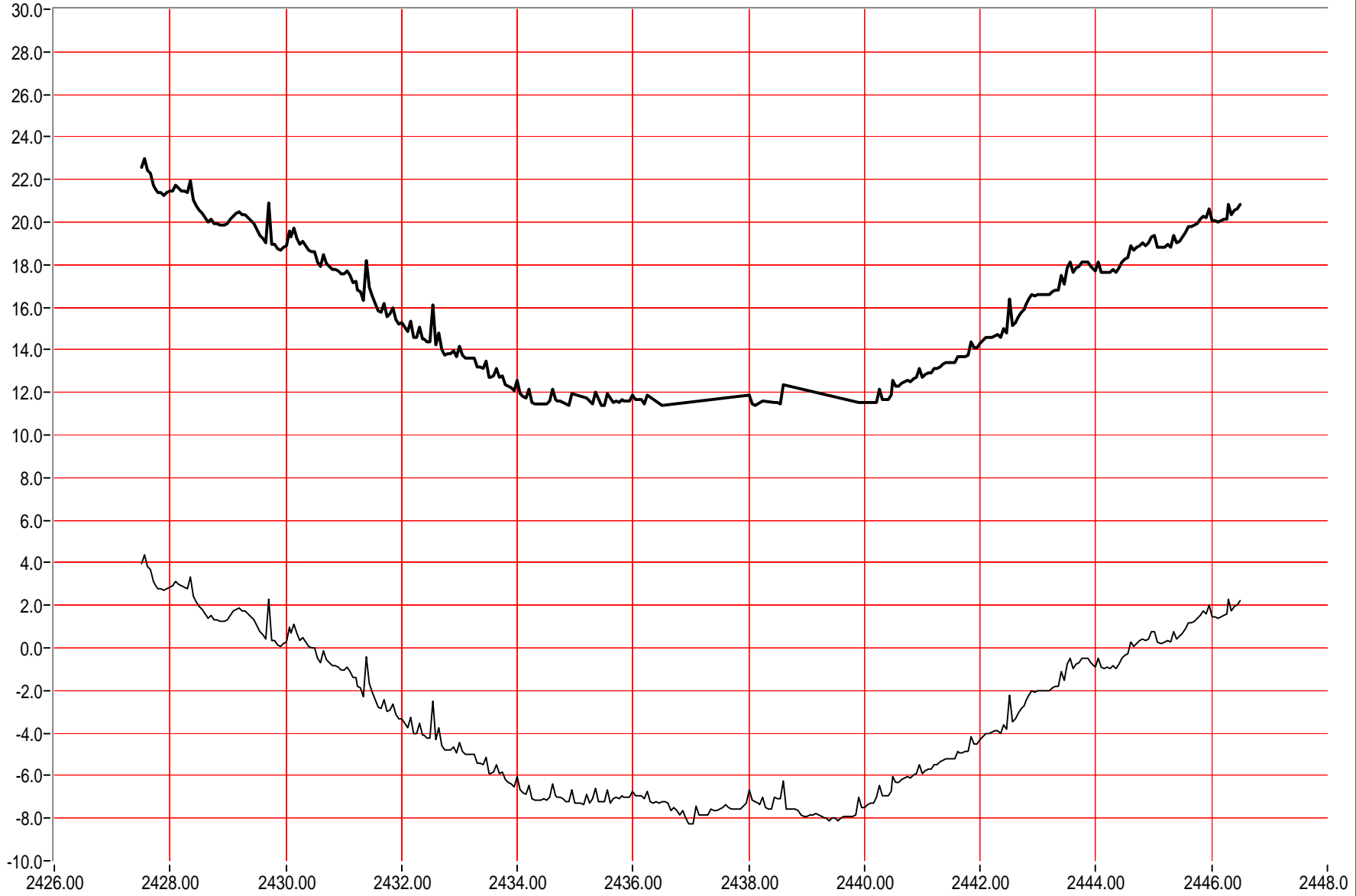

min value MHz Gp
 2434.90 11.39

Raw J/S
Gp



Gp Offset 18.60





Read from JS File.vi
Path: .\LabView\Project\Jamming\Read from JS File.vi
Last modified on 4/13/00 at 1:43 PM
Printed on 4/14/00 at 10:05 AM

File T2-2.dat

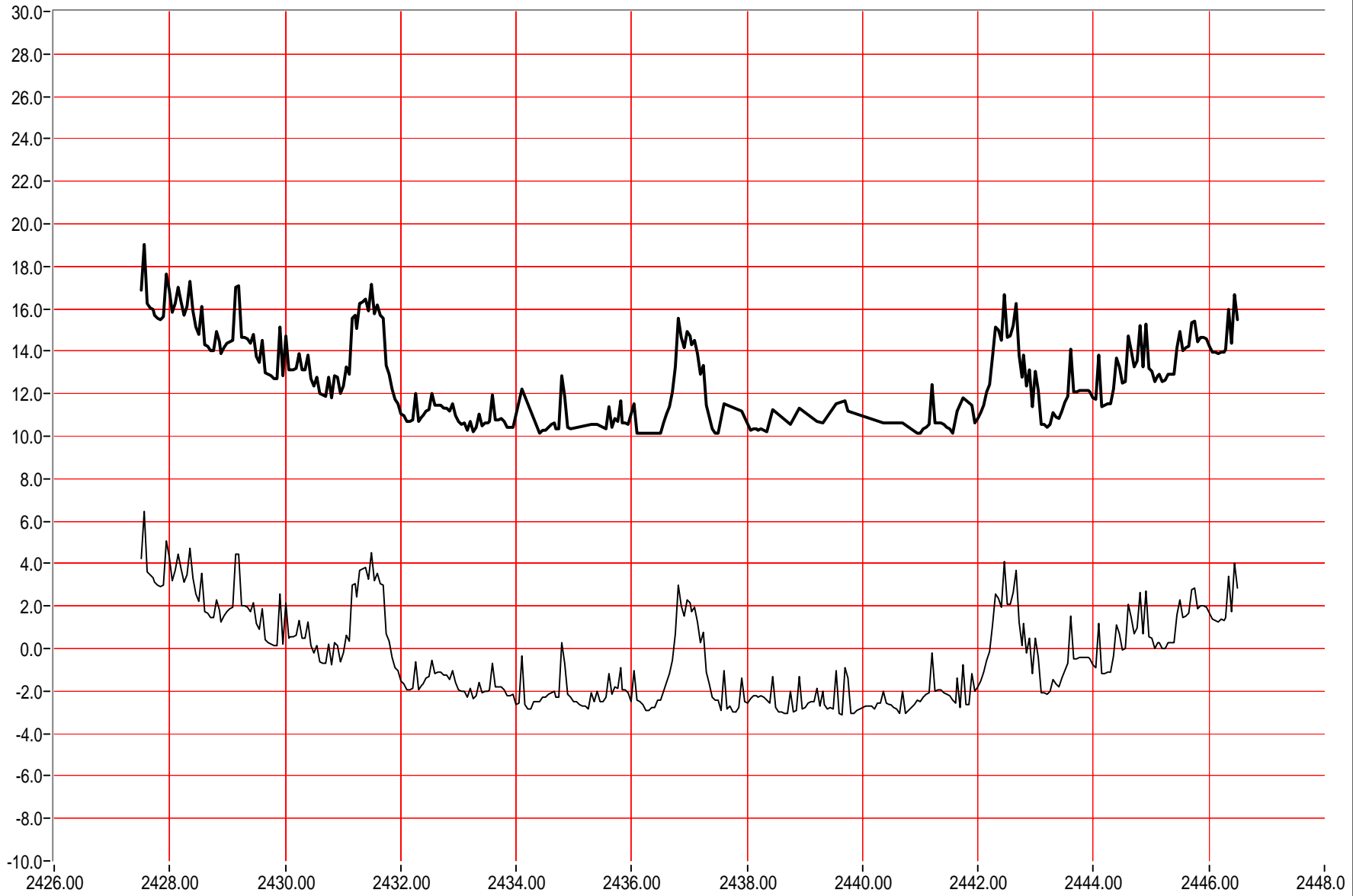
LA-4121 Processing Gain Plot: 2 Mbps



min value MHz Gp
 2441.00 10.13

Raw J/S 
Gp 

Gp Offset