



PCTEST ENGINEERING LABORATORY, INC.
 6660 – B Dobbin Road · Columbia, MD 21045 · USA
 Telephone 410.290.6652 / Fax 410.290.6654
<http://www.pctestlab.com> (email: randy@pctestlab.com)



CERTIFICATE OF COMPLIANCE (SAR EVALUATION)
-Class II Permissive Change-

APPLICANT NAME & ADDRESS:

Symbol Technologies, Inc.
 30 Plan Way
 Holtsville, NY 11742-1300
 Attn: Sandy Mazzola, Regulatory Engineer

DATE & LOCATION OF TESTING:

Dates of Tests: March 11, 2003
 Test Report S/N: SAR.230311131.H9P
 Test Site: PCTEST Lab, Columbia, MD USA

FCC ID:	H9PLA4121
APPLICANT NAME:	SYMBOL TECHNOLOGIES, INC.

EUT Type: Wireless Wall Scanner
Tx/Rx Frequency: 2412 – 2462 MHz (DTS)
Max. RF Output Power: 0.135W (21.3 dBm) Conducted
Max. SAR Measurement: 0.08 W/kg (Body-Backside)
 0.270 W/kg (Body-Top)
Trade Name/Model(s): SYMBOL MK2046-1311-WW
FCC Rule Part(s): §2.1093; FCC/OET Bulletin 65 Supplement C [July 2001]
Application Type: Certification
Test Device Serial No.: Identical Prototype [S/N: #ALP53326]
Original Grant Date: July 31, 2000
Class II Permissive Change: Added new Antenna Model: MK2046

This wireless portable device has been shown to be capable of compliance for localized specific absorption rate (SAR) for uncontrolled environment/general population exposure limits specified in ANSI/IEEE Std. C95.1-1992 and had been tested in accordance with the measurement procedures specified in FCC/OET Bulletin 65 Supplement C (2001) and IEEE Std. 1528-200X (Draft 6.5, January 15, 2002).

I attest to the accuracy of data. All measurements reported herein were performed by me or were made under my supervision and are correct to the best of my knowledge and belief. I assume full responsibility for the completeness of these measurements and vouch for the qualifications of all persons taking them.

Grant Conditions: Power output is EIRP. This device has been tested for SAR compliance for typical body touch use. This device must not be co-located or operating with another transmitter/ antenna. End-users must be informed of the body-worn operating configurations to satisfy RF exposure compliance.

PCTEST certifies that no party to this application has been denied the FCC benefits pursuant to Section 5301 of the Anti-Drug Abuse Act of 1988, 21 U.S.C. 862.



Alfred Cirwithian
 Vice President Engineering

SAR 230311131. H9P

PCTEST SAR TEST REPORT	CLASS II PERMISSIVE CHANGE SM FCC CERTIFICATION		symbol	Reviewed by: Quality Manager
SAR Filename: SAR.230311131.H9P	Test Dates: March 11, 2003	EUT Type: Symbol Wireless Wall Scanner	FCC ID: H9PLA4121	Page 1 of 35

TABLE OF CONTENTS

1. INTRODUCTION / SAR DEFINITION3

2. SAR MEASUREMENT SETUP4

3. ALIDX-500 E-FIELD PROBE SYSTEM.....5

4. PROBE CALIBRATION PROCESS.....6

5. PHANTOM & EQUIVALENT TISSUES.....7

6. TEST SYSTEM SPECIFICATIONS.....8

7. DOSIMETRIC ASSESSMENT & PHANTOM SPECS.....9

8. DEFINITION OF REFERENCE POINTS 10

9. TEST CONFIGURATION POSITION..... 11

10. ANSI/IEEE C95.1 - 1992 RF EXPOSURE LIMITS..... 12

11. MEASUREMENT UNCERTAINTIES 13

12. SAR TEST DATA SUMMARY 14

13. SAR TEST EQUIPMENT 15

14. CONCLUSION 16

15. REFERENCES..... 17

EXHIBIT A. SYSTEM VERIFICATION 18

EXHIBIT A. SAR DATA SUMMARY19-20

EXHIBIT B. RADIATED EMC TEST RESULTS21-34

EXHIBIT C. LINE CONDUCTED TEST DATA35

ATTACHEMNT ACOVER LETTER

ATTACHEMNT BSAR DATA PLOTS

ATTACHMENT CSAR TEST SETUP PHOTOGRAPHS

ATTACHMENT DDIPOLE VALIDATION

ATTACHMENT EPROBE CALIBRATION

ATTACHMENT FCLASS II PERMISSIVE CHANGE

ATTACHMENT GCOPY OF ORIGINAL GRANT

PCTEST SAR TEST REPORT	 CLASS II PERMISSIVE CHANGE FCC CERTIFICATION			Reviewed by: Quality Manager
SAR Filename: SAR.230311131.H9P	Test Dates: March 11, 2003	EUT Type: Symbol Wireless Wall Scanner	FCC ID: H9PLA4121	Page 2 of 35

1. INTRODUCTION / SAR DEFINITION

The FCC has adopted the guidelines for evaluating the environmental effects of radiofrequency radiation in ET Docket 93-62 on Aug. 6, 1996 to protect the public and workers from the potential hazards of RF emissions due to FCC-regulated portable devices.[1]

The safety limits used for the environmental evaluation measurements are based on the criteria published by the American National Standards Institute (ANSI) for localized specific absorption rate (SAR) in *IEEE/ANSI C95.1-1992 Standard for Safety Levels with Respect to Human Exposure to Radio Frequency Electromagnetic Fields, 3 kHz to 300 GHz*. (c) 1992 by the Institute of Electrical and Electronics Engineers, Inc., New York, New York 10017.[2] The measurement procedure described in *IEEE/ANSI C95.3-1992 Recommended Practice for the Measurement of Potentially Hazardous Electromagnetic Fields - RF and Microwave*[3] is used for guidance in measuring SAR due to the RF radiation exposure from the Equipment Under Test (EUT). These criteria for SAR evaluation are similar to those recommended by the National Council on Radiation Protection and Measurements (NCRP) in *Biological Effects and Exposure Criteria for Radiofrequency Electromagnetic Fields*, NCRP Report No. 86 (c) NCRP, 1986, Bethesda, MD 20814.[6] SAR is a measure of the rate of energy absorption due to exposure to an RF transmitting source. SAR values have been related to threshold levels for potential biological hazards.

SAR Definition

Specific Absorption Rate (SAR) is defined as the time derivative (rate) of the incremental energy (dU) absorbed by (dissipated in) an incremental mass (dm) contained in a volume element (dV) of a given density (ρ). It is also defined as the rate of RF energy absorption per unit mass at a point in an absorbing body (see Fig. 1.1).

$$SAR = \frac{d}{dt} \left(\frac{dU}{dm} \right) = \frac{d}{dt} \left(\frac{dU}{\rho dV} \right)$$

Figure 1.1
SAR Mathematical Equation

SAR is expressed in units of Watts per Kilogram (W/kg).

$$SAR = \sigma E^2 / \rho$$

where:

- σ = conductivity of the tissue-simulant material (S/m)
- ρ = mass density of the tissue-simulant material (kg/m³)
- E = Total RMS electric field strength (V/m)

NOTE: The primary factors that control rate of energy absorption were found to be the wavelength of the incident field in relations to the dimensions and geometry of the irradiated organism, the orientation of the organism in relation to the polarity of field vectors, the presence of reflecting surfaces, and whether conductive contact is made by the organism with a ground plane.[6]

PCTEST SAR TEST REPORT	 CLASS II PERMISSIVE CHANGE FCC CERTIFICATION			Reviewed by: Quality Manager
SAR Filename: SAR.230311131.H9P	Test Dates: March 11, 2003	EUT Type: Symbol Wireless Wall Scanner	FCC ID: H9PLA4121	Page 3 of 35

2. SAR MEASUREMENT SETUP

Robotic System

Measurements are performed using the ALIDX-500 automated dosimetric assessment system. The ALIDX-500 is made by IDX Robotics, Inc. (IDX) in the United States and consists of high precision robotics system (CRS), robot controller, Pentium 4 computer, near-field probe, probe alignment sensor, and the Left and Right SAM phantoms containing the head/brain equivalent tissue, and the flat phantoms for body/muscle equivalent. The robot is a six-axis industrial robot performing precise movements to position the probe to the location (points) of maximum electromagnetic field (EMF) (see Fig. 2.1).

System Hardware

The Robot table consists of the power supply, robot controller, safety computer, teach pendant (Joystick), six-axis robot arm, and the probe. The cell controller consists of DELL Dimension 4300 Pentium-4 1.6 GHz computer with Windows 2000 system and SAR Measurement software, National Instruments analog card, monitor, keyboard, and mouse. The robot controller is connected to the cell controller to communicate between the two computers. The probe data is connected to the cell controller via data acquisition cables.

System Electronics

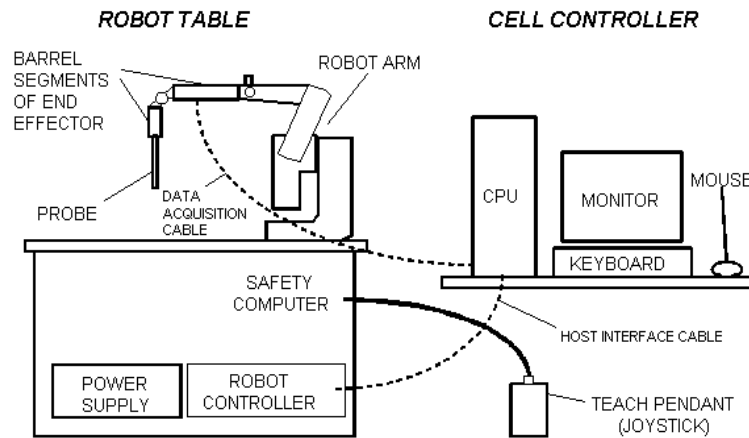



Figure 2.1
SAR Measurement System Setup

When the Robot is in the home position, the Y-axis of the coordinate system parallels the line of intersection between the tabletop and the long axis of the Robot's Large Shoulder. The Teach Pendant may be used to establish the X,Y coordinate directions by depressing the 0-X and 0-Y MOTOR/AXIS switches while in axis mode.

The robot is first taught to position the probe sensor following a specific pattern of points. In the first sweep the sensor enclosure touches the inside of the phantom head. The SAR is measured on a defined grid of points that are concentrated on the surface of the head closest to the antenna of the transmitting device (EUT).

PCTEST SAR TEST REPORT	 CLASS II PERMISSIVE CHANGE FCC CERTIFICATION 			Reviewed by: Quality Manager
SAR Filename: SAR.230311131.H9P	Test Dates: March 11, 2003	EUT Type: Symbol Wireless Wall Scanner	FCC ID: H9PLA4121	Page 4 of 35

3. ALIDX-500 E-FIELD PROBE SYSTEM

Probe Measurement System



Fig 3.1
IDX System

The near-field probe is an implantable isotropic E-field probe that measures the voltages proportional to the $|E|^2$ (electric) or $|H|^2$ (magnetic) fields. The probe is enclosed in a hollow glass protective cylinder 9-mm. outer diameter, 0.5 mm. thickness and 30 cm. in length. The E-probe contains three electrically small array of orthogonal dipoles strategically placed to provide greater accuracy and to compensate for near-field spatial gradients. The probe contains diodes that are placed over the gap of the dipoles to improve RF detection. The electrical signal detected by each diode is amplified by three DC amplifiers and are contained in a shielded container in the robot end effector so its performance is not affected by the presence of incident electromagnetic fields (see Fig. 3.1).

Probe Specifications

- Frequency Range: 10 kHz – 6.0 GHz
- Calibration: In air from 10 MHz to 6.0 GHz
In brain and muscle simulating tissue at Frequencies from 835 up to 5800MHz
- Sensitivity: 3.5 mV/mW/cm² (air – typical)
- DC Resistance: 300 kohm
- Isotropic Response: 0.25 dB
- Dynamic Range: 10 mW/kg – 100 W/kg
- Resistance to Pull: 25 N
- Probe Length: 290 mm
- Probe Tip Material: Glass
- Probe Tip Length: 40 mm
- Probe Tip Diameter: 7 ± 0.2 mm
- Application: SAR Dosimetry Testing
HAC (Hearing Aid Compatibility)
Compliance tests of mobile phones



Figure 3.2
Triangular Probe Configuration

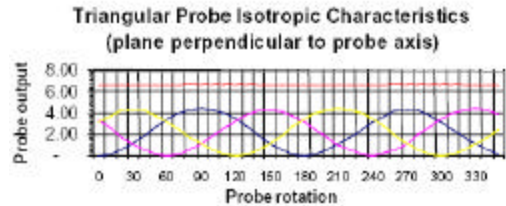



Figure 3.3
Probe Characteristics

PCTEST SAR TEST REPORT	 CLASS II PERMISSIVE CHANGE FCC CERTIFICATION			Reviewed by: Quality Manager
SAR Filename: SAR.230311131.H9P	Test Dates: March 11, 2003	EUT Type: Symbol Wireless Wall Scanner	FCC ID: H9PLA4121	Page 5 of 35

4. PROBE CALIBRATION PROCESS

Dosimetric Assessment Procedure

Each E-Probe/Probe amplifier combination has unique calibration parameters. A TEM calibration procedure is conducted to determine the proper amplifier settings to enter in the probe parameters. The amplifier settings are determined for a given frequency by subjecting the Probe to a known E-field density (1mW/cm²) using an RF Signal generator, TEM cell, and RF Power Meter. The SAR measurement software is used for Probe calibration.

Free Space Assessment

The free space E-field from amplified probe outputs is determined in a test chamber. This calibration can be performed in a TEM cell if the frequency is below 1 GHz and in a waveguide or some other methodologies above 1 GHz for free space. For the free space calibration, we place the probe in the volumetric center of the cavity and at the proper orientation with the field. We then rotate the probe 360 degrees until the three channels show the maximum reading. The power density readings equates to 1mW/cm².

Temperature Assessment

E-field temperature correlation calibration is performed in a flat phantom filled with the appropriate simulated brain tissue. The measured free space E-field in the medium correlates to temperature rise in a dielectric medium. For temperature correlation calibration a RF transparent thermistor-based temperature probe is used in conjunction with the E-field probe.

$$SAR = C \frac{\Delta T}{\Delta t}$$

where:

Δt = exposure time (30 seconds),

C = heat capacity of tissue (brain or muscle),

ΔT = temperature increase due to RF exposure.

SAR is proportional to $\Delta T / \Delta t$, the initial rate of tissue heating, before thermal diffusion takes place. Now it's possible to quantify the electric field in the simulated tissue by equating the thermally derived SAR to the E- field;

$$SAR = \frac{|E|^2 \cdot s}{r}$$

where:

σ = simulated tissue conductivity,

ρ = Tissue density (1.25 g/cm³ for brain tissue)

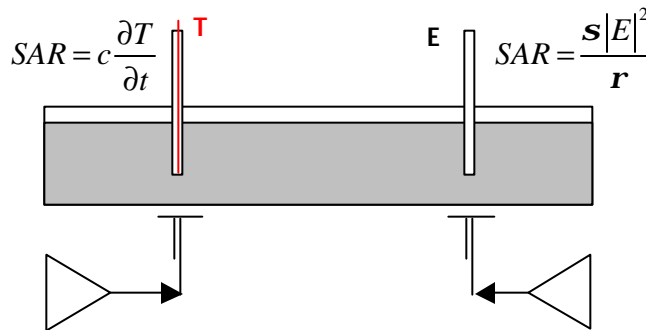



Figure 4.1 Temperature Assessment Test Configuration

PCTEST SAR TEST REPORT	 CLASS II PERMISSIVE CHANGE FCC CERTIFICATION			Reviewed by: Quality Manager
SAR Filename: SAR.230311131.H9P	Test Dates: March 11, 2003	EUT Type: Symbol Wireless Wall Scanner	FCC ID: H9PLA4121	Page 6 of 35

5. PHANTOM & EQUIVALENT TISSUES



Figure 5.1
SAM Phantoms

The Left and Right SAM Phantoms are constructed of a vivac composite integrated in a corian stand. The shape of the shell is based on data from an anatomical study designed to determine the maximum exposure in at least 90% of all users [7][8]. It enables the dosimetric evaluation of left and right hand phone usage as well as body mounted usage at the flat phantom region. A cover prevents the evaporation of the liquid. Reference markings on the Phantom allow the complete setup of all predefined phantom positions and measurement grids by manually teaching three points in the robot. (see Fig. 5.1)

Brain & Muscle Simulating Mixture Characterization

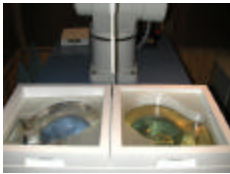

Figure 5.2
Head Simulated Tissue

The brain and muscle mixtures consist of a viscous gel using hydroxethylcellulose (HEC) gelling agent and saline solution (see Table 6.1). Preservation with a bactericide is added and visual inspection is made to make sure air bubbles are not trapped during the mixing process. The mixture is calibrated to obtain proper dielectric constant (permittivity) and conductivity of the desired tissue. The head tissue dielectric parameters recommended by the IEEE SCC-34/SC-2 have been incorporated in the following table. Other head and body tissue parameters that have not been specified in P1528 are derived from the issue dielectric parameters computed from the 4-Cole-Cole equations. The mixture characterizations used for the brain and muscle tissue simulating liquids are according to the data by C. Gabriel and G. Hartsgrove [9].(see Table 5.1)

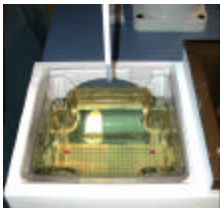

Figure 5.3
Body/Muscle Simulated Tissue

Ingredients (% by weight)	Frequency (MHz)									
	450		815		915		1900		2450	
Tissue Type	Head	Body	Head	Body	Head	Body	Head	Body	Head	Body
Water	38.56	51.16	41.45	52.4	41.05	56.0	54.9	40.4	62.7	73.2
Salt (NaCl)	3.95	1.49	1.45	1.4	1.35	0.76	0.18	0.5	0.5	0.04
Sugar	56.32	46.78	56.0	45.0	56.5	41.76	0.0	58.0	0.0	0.0
HEC	0.98	0.52	1.0	1.0	1.0	1.21	0.0	1.0	0.0	0.0
Bactericide	0.19	0.05	0.1	0.1	0.1	0.27	0.0	0.1	0.0	0.0
Triton X-100	0.0	0.0	0.0	0.0	0.0	0.0	0.0	0.0	36.8	0.0
DGBE	0.0	0.0	0.0	0.0	0.0	0.0	44.92	0.0	0.0	26.7

Salt: 99% Pure Sodium Chloride Sugar: 98% Pure Sucrose
 Water: De-ionized, 16 MΩ resistivity HEC: Hydroxyethyl Cellulose
 DGBE: 99% Di(ethylene glycol) butyl ether, [2-(2-butoxyethoxy)ethanol]
 Triton X-100 (ultra pure): Polyethylene glycol mono [4-(1,1,3,3-tetramethylbutyl)phenyl] ether

Table 5.1
Composition of the Brain & Muscle Tissue Equivalent Matter

Device Holder



Figure 5.4
Device Positioner

In combination with the SAM Phantom, the EUT Holder (see Fig. 6.2) enables the rotation of the mounted transmitter in spherical coordinates whereby the rotation point is the ear opening. Device positioning is accurate and repeatable according to the FCC and CENELEC specifications. The device holder can be locked at different phantom locations (left head, right head, flat phantom).

* Note: A simulating human hand is not used due to the complex anatomical and geometrical structure of the hand that may produce infinite number of configurations [8]. To produce the worst-case condition (the hand absorbs antenna output power), the hand is omitted during the tests.

PCTEST SAR TEST REPORT	CLASS II PERMISSIVE CHANGE FCC CERTIFICATION			Reviewed by: Quality Manager
SAR Filename: SAR.230311131.H9P	Test Dates: March 11, 2003	EUT Type: Symbol Wireless Wall Scanner	FCC ID: H9PLA4121	Page 7 of 35

6. TEST SYSTEM SPECIFICATIONS

Automated Test System Specifications

Positioner

Robot: CRS Robotics, Inc. Robot Model: F3
Repeatability: ± 0.05 mm (0.002 in.)
No. Of axes: 6

Data Acquisition Electronic (DAE) System

Cell Controller

Processor: Pentium 4
Clock Speed: 1.6 GHz
Operating System: Windows 2000™ Professional
Data Card: NI DAQ Card (in CPU)

Data Converter

Software: IDX Flexware
Connecting Lines: Data Acquisition Cable
 RS-232 Host Interface Cable
Sampling Rate: 6000 samples/sec

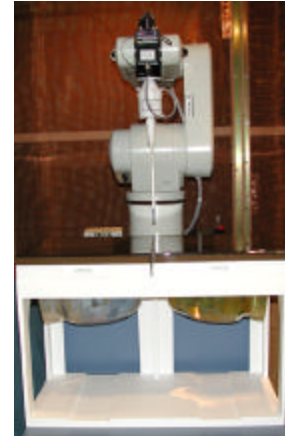



Figure 6.1
ALIDX-500 Test System

E-Field Probes

Model: E-010 S/N: PCT003
Construction: Triangular core absolute encoder system
Frequency: 10 MHz to 6.0 GHz

Phantom

Phantom: SAM Phantoms (Left & Right)
Shell Material: Vivac Composite
Thickness: 2.0 ± 0.2 mm

PCTEST SAR TEST REPORT	 CLASS II PERMISSIVE CHANGE FCC CERTIFICATION 			Reviewed by: Quality Manager
SAR Filename: SAR.230311131.H9P	Test Dates: March 11, 2003	EUT Type: Symbol Wireless Wall Scanner	FCC ID: H9PLA4121	Page 8 of 35

7. DOSIMETRIC ASSESSMENT & PHANTOM SPECS

Measurement Procedure

The measurement procedure consists of the process parameters, probe parameters, EUT product data, and measurement scans (teach points). The measurement procedure is a set of predefined points to be scanned and measured by the probe, DC amplified and processed by the cell controller. The corresponding voltages determined by the electric and magnetic fields are extrapolated to determine peak SAR value.

The SAR Measurement System measures field strength by employing two different types of systematic measurement scans; a coarse scan and a fine scan. Coarse and fine scans measure field strength in a rectangular area within the XY plane (a plane parallel to the top of the Robot Table). The measurement area is divided into a grid of small squares defined by equally spaced grid lines. During an actual measurement process, the probe moves along grid lines systematically recording the field strength at grid line intersections. Typically, after a coarse scan is completed, a fine scan is conducted at the peak field strength value (hot spot) that was measured in the coarse scan. The fine scan has a greater resolution (smaller grid squares) than the coarse scan, and covers only a fraction of the measurement area in the coarse scan.

Specific Anthropomorphic Mannequin (SAM) Specifications

The phantom for handset SAR assessment testing is a low-loss dielectric shell, with shape and dimensions derived from the anthropometric data of the 90th percentile adult male head dimensions as tabulated by the US Army. The SAM Phantom shell is bisected along the mid-sagittal plane into right and left halves (see Fig. 7.1). The perimeter sidewalls of each phantom halves are extended to allow filling with liquid to a depth that is sufficient to minimized reflections from the upper surface. The liquid depth is maintained at a minimum depth of 15cm to minimize reflections from the upper surface. The SAM shell thickness is 2.0 ± 0.2 mm.



Figure 7.1
Left and Right SAM Phantom shells

PCTEST SAR TEST REPORT	 CLASS II PERMISSIVE CHANGE FCC CERTIFICATION			Reviewed by: Quality Manager
SAR Filename: SAR.230311131.H9P	Test Dates: March 11, 2003	EUT Type: Symbol Wireless Wall Scanner	FCC ID: H9PLA4121	Page 9 of 35

8. DEFINITION OF REFERENCE POINTS

EAR Reference Point (ERP)

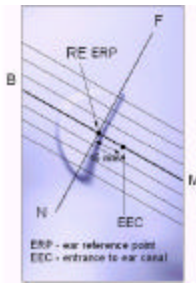

Figure 8.2 Close-up side view of ERPs

Figure 8.1 shows the front, back and side views of the SAM Twin Phantom. The point "M" is the reference point for the center of the mouth, "LE" is the left ear reference point (ERP), and "RE" is the right ERP. The ERPs are 15mm posterior to the entrance to the ear canal (EEC) along the B-M line (Back-Mouth), as shown in Figure 9.2. The plane passing through the two ear canals and M is defined as the Reference Plane. The line N-F (Neck-Front) is perpendicular to the reference plane and passing through the RE (or LE) is called the Reference Pivoting Line (see Figure 8.2). Line B-M is perpendicular to the N-F line. Both N-F and B-M lines are marked on the external phantom shell to facilitate handset positioning [5].



Figure 8.1 Front, back and side view of SAM Twin Phantom

Handset Reference Points

Two imaginary lines on the handset were established: the vertical centerline and the horizontal line. The test device was placed in a normal operating position with the "test device reference point" located along the "vertical centerline" on the front of the device aligned to the "ear reference point" (See Fig. 8.3). The "test device reference point" was then located at the same level as the center of the ear reference point. The test device was positioned so that the "vertical centerline" was bisecting the front surface of the handset at its top and bottom edges, positioning the "ear reference point" on the outer surface of the both the left and right head phantoms on the ear reference point.

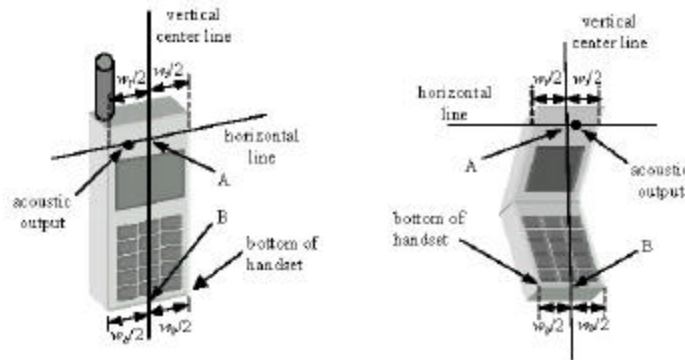



Figure 8.3 Handset Vertical Center & Horizontal Line Reference Points

PCTEST SAR TEST REPORT	 CLASS II PERMISSIVE CHANGE FCC CERTIFICATION 			Reviewed by: Quality Manager
SAR Filename: SAR.230311131.H9P	Test Dates: March 11, 2003	EUT Type: Symbol Wireless Wall Scanner	FCC ID: H9PLA4121	Page 10 of 35

9. TEST CONFIGURATION POSITION

Body Holster /Belt Clip Configurations

Body-worn operating configurations are tested with the belt-clips and holsters attached to the device and positioned against a flat phantom in a normal use configuration (see Figure 9.1). A device with a headset output is tested with a headset connected to the device. Body dielectric parameters are used.

Accessories for Body-worn operation configurations are divided into two categories: those that do not contain metallic components and those that do contain metallic components. When multiple accessories that do not contain metallic components are supplied with the device, the device is tested with only the accessory that dictates the closest spacing to the body. Then multiple accessories that contain metallic components are supplied with the device, the device is tested with each accessory that contains a unique metallic component. If multiple accessories share an identical metallic component (i.e. the same metallic belt-clip used with different holsters with no other metallic components) only the accessory that dictates the closest spacing to the body is tested.

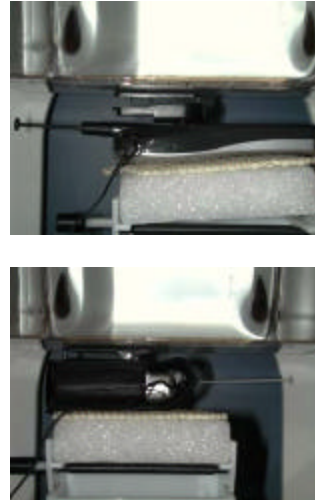



Figure 9.1 Body Belt Clip & Holster Configurations

Body-worn accessories may not always be supplied or available as options for some devices intended to be authorized for body-worn use. In this case, a test configuration where a separation distance between the back of the device and the flat phantom is used. All test position spacings are documented.

Transmitters that are designed to operate in front of a person's face, as in push-to-talk configurations, are tested for SAR compliance with the front of the device positioned to face the flat phantom. For devices that are carried next to the body such as a shoulder, waist or chest-worn transmitters, SAR compliance is tested with the accessory(ies), including headsets and microphones, attached to the device and positioned against a flat phantom in a normal use configuration.

In all cases SAR measurements are performed to investigate the worst-case positioning. Worst-case positioning is then documented and used to perform Body SAR testing.

In order for users to be aware of the body-worn operating requirements for meeting RF exposure compliance, operating instructions and cautions statements must be included in the user's manual.

PCTEST SAR TEST REPORT	 CLASS II PERMISSIVE CHANGE[†] FCC CERTIFICATION 			Reviewed by: Quality Manager
SAR Filename: SAR.230311131.H9P	Test Dates: March 11, 2003	EUT Type: Symbol Wireless Wall Scanner	FCC ID: H9PLA4121	Page 11 of 35

10. ANSI/IEEE C95.1 - 1992 RF EXPOSURE LIMITS

Uncontrolled Environment

UNCONTROLLED ENVIRONMENTS are defined as locations where there is the exposure of individuals who have no knowledge or control of their exposure. The general population/uncontrolled exposure limits are applicable to situations in which the general public may be exposed or in which persons who are exposed as a consequence of their employment may not be made fully aware of the potential for exposure or cannot exercise control over their exposure. Members of the general public would come under this category when exposure is not employment-related; for example, in the case of a wireless transmitter that exposes persons in its vicinity.

Controlled Environment

CONTROLLED ENVIRONMENTS are defined as locations where there is exposure that may be incurred by persons who are aware of the potential for exposure, (i.e. as a result of employment or occupation). In general, occupational/controlled exposure limits are applicable to situations in which persons are exposed as a consequence of their employment, who have been made fully aware of the potential for exposure and can exercise control over their exposure. This exposure category is also applicable when the exposure is of a transient nature due to incidental passage through a location where the exposure levels may be higher than the general population/uncontrolled limits, but the exposed person is fully aware of the potential for exposure and can exercise control over his or her exposure by leaving the area or by some other appropriate means.



Table 10.1. Safety Limits for Partial Body Exposure [2]

	HUMAN EXPOSURE LIMITS	
	UNCONTROLLED ENVIRONMENT General Population (W/kg) or (mW/g)	CONTROLLED ENVIRONMENT General Population (W/kg) or (mW/g)
SPATIAL PEAK SAR 1 Brain	1.60	8.00
SPATIAL AVERAGE SAR 2 Whole Body	0.08	0.40
SPATIAL PEAK SAR 3 Hands, Feet, Ankles, Wrists	4.00	20.00

1 The Spatial Peak value of the SAR averaged over any 1 gram of tissue (defined as a tissue volume in the shape of a cube) and over the appropriate averaging time.

2 The Spatial Average value of the SAR averaged over the whole body.

3 The Spatial Peak value of the SAR averaged over any 10 grams of tissue (defined as a tissue volume in the shape of a cube) and over the appropriate averaging time.

PCTEST SAR TEST REPORT	 CLASS II PERMISSIVE CHANGE[†] FCC CERTIFICATION 			Reviewed by: Quality Manager
SAR Filename: SAR.230311131.H9P	Test Dates: March 11, 2003	EUT Type: Symbol Wireless Wall Scanner	FCC ID: H9PLA4121	Page 12 of 35

11. MEASUREMENT UNCERTAINTIES

a	b	c	d	e = f(d,k)	f	g	h = cxf/e	i = cxg/e	k
Uncertainty Component	Sec.	Tol. (± %)	Prob. Dist.	Div.	c _i (1 - g)	c _i (10 - g)	1 - g u _i (± %)	10 - g u _i (± %)	v _i
Measurement System									
Probe Calibration	E1.1	6.0	N	1	1	1	6.0	6.0	∞
Axial Isotropy	E1.2	4.88	R	$\sqrt{3}$	0.5	0.5	1.4	1.4	∞
Hemishperical Isotropy	E1.2	9.6	R	$\sqrt{3}$	0.5	0.5	2.8	2.8	∞
Boundary Effect	E1.3	11.0	R	$\sqrt{3}$	1	1	6.4	6.4	∞
Linearity	E1.4	4.7	R	$\sqrt{3}$	1	1	2.7	2.7	∞
System Detection Limits	E1.5	1.0	R	$\sqrt{3}$	1	1	0.6	0.6	∞
Readout Electronics	E1.6	1.0	R	1	1	1	1.0	1.0	∞
Response Time	E1.7	0.8	R	$\sqrt{3}$	1	1	0.5	0.5	∞
Integration Time	E1.8	1.7	R	$\sqrt{3}$	1	1	1.0	1.0	∞
RF Ambient Conditions	E5.1	1.2	R	$\sqrt{3}$	1	1	0.7	0.7	∞
Probe Positioner Mechanical Tolerance	E5.2	0.4	R	$\sqrt{3}$	1	1	0.2	0.2	∞
Probe Positioning w/ respect to Phantom Shell	E5.3	2.9	R	$\sqrt{3}$	1	1	1.7	1.7	∞
Extrapolation, Interpolation & Integration Algorithms for Max. SAR Evaluation	E4.2	3.9	R	$\sqrt{3}$	1	1	2.3	2.3	∞
Test Sample Related									
Test Sample Positioning	E3.2.1	10.6	R	$\sqrt{3}$	1	1	6.1	6.1	11
Device Holder Uncertainty	E3.1.1	8.7	R	$\sqrt{3}$	1	1	5.0	5.0	8
Output Power Variation - SAR drift measurement	5.6.2	5.0	R	$\sqrt{3}$	1	1	2.9	2.9	∞
Phantom & Tissue Parameters									
Phantom Uncertainty (Shape & Thickness tolerances)	E2.1	4.0	R	$\sqrt{3}$	1	1	2.3	2.3	∞
Liquid Conductivity - deviation from target values	E2.2	5.0	R	$\sqrt{3}$	0.7	0.5	2.0	1.4	∞
Liquid Conductivity - measurement uncertainty	E2.2	10.0	R	$\sqrt{3}$	0.7	0.5	4.0	2.9	∞
Liquid Permittivity - deviation from target values	E2.2	5.0	R	$\sqrt{3}$	0.6	0.5	1.7	1.4	∞
Liquid Permittivity - measurement uncertainty	E2.2	5.0	R	$\sqrt{3}$	0.6	0.5	1.7	1.4	∞
Combined Standard Uncertainty (k=1)			RSS				14.4	14.0	
Expanded Uncertainty (k=2) (95% CONFIDENCE LEVEL)							28.8	28.0	

The above measurement uncertainties are according to IEEE Std. 1528-200X (January, 2002)

PCTEST SAR TEST REPORT		CLASS II PERMISSIVE CHANGE[†] FCC CERTIFICATION		Reviewed by: Quality Manager
SAR Filename: SAR.230311131.H9P	Test Dates: March 11, 2003	EUT Type: Symbol Wireless Wall Scanner	FCC ID: H9PLA4121	Page 13 of 35

12. SAR TEST DATA SUMMARY

See Measurement Result Data Pages

Procedures Used To Establish Test Signal

The EUT was placed into continuous transmit mode using the manufacturer's software. Such test signals offer a consistent means for testing SAR and are recommended for evaluating SAR [4].

Device Test Conditions

The transmitting EUT is powered through the AC adapter. In order to verify that the device was tested at full power, conducted output power measurements were performed before and after each SAR measurement to confirm the output power. If a power deviation of more than 5% occurred, the test was repeated.

PCTEST SAR TEST REPORT		CLASS II PERMISSIVE CHANGE FCC CERTIFICATION		Reviewed by: Quality Manager
SAR Filename: SAR.230311131.H9P	Test Dates: March 11, 2003	EUT Type: Symbol Wireless Wall Scanner	FCC ID: H9PLA4121	Page 14 of 35

13. SAR TEST EQUIPMENT



Equipment Calibration

Table 15.1 Test Equipment Calibration

EQUIPMENT SPECIFICATIONS		
Type	Calibration Date	Serial Number
CRS Robot F3	February 2003	RAF0134133
CRS C500C Motion Controller	February 2003	RCB0003303
CRS Teach Pendant (Joystick)	February 2003	STP0132231
DELL Computer, Pentium 4 1.6 GHz, Windows 2000™	February 2003	4PJZ111
E-Field Probe E-010	January 2003	PCT003
Right Ear SAM Phantom (P-SAM-R)	February 2003	94X-113
Left Ear SAM Phantom (P-SAM-L)	February 2003	94X-019
Flat SAM Phantom (P-SAM-FLAT)	February 2003	94X-097
IDX Robot End Effector (EE-103-C)	February 2003	07111223
IDX Probe Amplifier	February 2003	07111113
Validation Dipole D-835S	February 2003	PCT640
Validation Dipole D-1900S	February 2003	PCT641
Validation Dipole D-2450S	February 2003	PCT641
Brain Equivalent Matter (835MHz)	March 2003	PCTBEM101
Brain Equivalent Matter (1900MHz)	March 2003	PCTBEM301
Brain Equivalent Matter (2450MHz)	March 2003	PCTBEM501
Muscle Equivalent Matter (835MHz)	March 2003	PCTMEM201
Muscle Equivalent Matter (1900MHz)	March 2003	PCTMEM401
Muscle Equivalent Matter (2450MHz)	March 2003	PCTMEM601
Amplifier Research 5S1G4 Power Amp	March 2003	PCT540
Agilent E8241A (250kHz ~ 20GHz) Signal Generator	November 2002	US42110432
Agilent E4448A (3Hz – 50GHz) PSA Spectrum Analyzer	May 2003	PCT682
HP-8753E (30kHz ~ 6GHz) Network Analyzer	January 2003	PCT552
HP85070B Dielectric Probe Kit	January 2003	PCT501
Ambient Noise/Reflection, etc.	<12mW/kg/<3%of SAR	January 2003

NOTE:

Dipole Validation measurement was performed by PCTEST Lab before each test. The brain simulating material is calibrated by PCTEST using the dielectric probe system and network analyzer to determine the conductivity and permittivity (dielectric constant) of the brain-equivalent material.

PCTEST SAR TEST REPORT	 CLASS II PERMISSIVE CHANGE FCC CERTIFICATION 			Reviewed by: Quality Manager
SAR Filename: SAR.230311131.H9P	Test Dates: March 11, 2003	EUT Type: Symbol Wireless Wall Scanner	FCC ID: H9PLA4121	Page 15 of 35

14. CONCLUSION

Measurement Conclusion

The SAR measurement indicates that the EUT complies with the RF radiation exposure limits of the FCC. These measurements are taken to simulate the RF effects exposure under worst-case conditions. Precise laboratory measures were taken to assure repeatability of the tests. The tested device complies with the requirements in respect to all parameters subject to the test. The test results and statements relate only to the item(s) tested. Please note that the absorption and distribution of electromagnetic energy in the body are very complex phenomena that depend on the mass, shape, and size of the body, the orientation of the body with respect to the field vectors, and the electrical properties of both the body and the environment. Other variables that may play a substantial role in possible biological effects are those that characterize the environment (e.g. ambient temperature, air velocity, relative humidity, and body insulation) and those that characterize the individual (e.g. age, gender, activity level, debilitation, or disease). Because innumerable factors may interact to determine the specific biological outcome of an exposure to electromagnetic fields, any protection guide shall consider maximal amplification of biological effects as a result of field-body interactions, environmental conditions, and physiological variables.[3]

PCTEST SAR TEST REPORT		CLASS II PERMISSIVE CHANGE FCC CERTIFICATION		Reviewed by: Quality Manager
SAR Filename: SAR.230311131.H9P	Test Dates: March 11, 2003	EUT Type: Symbol Wireless Wall Scanner	FCC ID: H9PLA4121	Page 16 of 35

15. REFERENCES

- [1] Federal Communications Commission, ET Docket 93-62, Guidelines for Evaluating the Environmental Effects of Radiofrequency Radiation, Aug. 1996.
- [2] ANSI/IEEE C95.1 - 1991, *American National Standard safety levels with respect to human exposure to radio frequency electromagnetic fields, 300kHz to 100GHz*, New York: IEEE, Aug. 1992.
- [3] ANSI/IEEE C95.3 - 1991, *IEEE Recommended Practice for the Measurement of Potentially Hazardous Electromagnetic Fields - RF and Microwave*, New York: IEEE, 1992.
- [4] Federal Communications Commission, OET Bulletin 65 (Edition 97-01), Supplement C (Edition 01-01), *Evaluating Compliance with FCC Guidelines for Human Exposure to Radiofrequency Electromagnetic Fields*, July 2001.
- [5] IEEE Standards Coordinating Committee 34 – IEEE Std. 1528-200X (Draft 6.5 – January 2002), *Draft Recommended Practice for Determining the Peak Spatial-Average Specific Absorption Rate (SAR) in the Human Body Due to Wireless Communications Devices: Experimental Techniques*.
- [6] NCRP, National Council on Radiation Protection and Measurements, *Biological Effects and Exposure Criteria for RadioFrequency Electromagnetic Fields*, NCRP Report No. 86, 1986. Reprinted Feb. 1995.
- [7] V. Hombach, K. Meier, M. Burkhardt, E. Kuhn, N. Kuster, *The Dependence of EM Energy Absorption upon Human Head Modeling at 900 MHz*, IEEE Transaction on Microwave Theory and Techniques, vol. 44 no. 10, Oct. 1996, pp. 1865-1873.
- [8] N. Kuster and Q. Balzano, *Energy absorption mechanism by biological bodies in the near field of dipole antennas above 300MHz*, IEEE Transaction on Vehicular Technology, vol. 41, no. 1, Feb. 1992, pp. 17-23.
- [9] G. Hartsgrove, A. Kraszewski, A. Surowiec, *Simulated Biological Materials for Electromagnetic Radiation Absorption Studies*, University of Ottawa, Bioelectromagnetics, Canada: 1987, pp. 29-36.
- [10] Q. Balzano, O. Garay, T. Manning Jr., *Electromagnetic Energy Exposure of Simulated Users of Portable Cellular Telephones*, IEEE Transactions on Vehicular Technology, vol. 44, no.3, Aug. 1995.
- [11] W.H. Press, S.A. Teukolsky, W.T. Vetterling, and B.P. Flannery, *Numerical Recipes in C*, The Art of Scientific Computing, Second edition, Cambridge University Press, 1992.
- [12] Federal Communications Commission, OET Bulletin 65, Evaluating Compliance with FCC Guidelines for Human Exposure to Radiofrequency Electromagnetic Fields. Supplement C, Dec. 1997.
- [13] CENELEC CLC/SC111B, European Prestandard (prENV 50166-2), Human Exposure to Electromagnetic Fields High-frequency: 10kHz-300GHz, Jan. 1995.



PCTEST SAR TEST REPORT	 CLASS II PERMISSIVE CHANGE FCC CERTIFICATION 			Reviewed by: Quality Manager
SAR Filename: SAR.230311131.H9P	Test Dates: March 11, 2003	EUT Type: Symbol Wireless Wall Scanner	FCC ID: H9PLA4121	Page 17 of 35

EXHIBIT A. SYSTEM VERIFICATION

Tissue Verification

Table A.1 Simulated Tissue Verification

MEASURED TISSUE PARAMETERS					
Date(s)	03/10/03	2450MHz Brain		2450MHz Muscle	
Liquid Temperature (°C)	23.4	Target	Measured	Target	Measured
Dielectric Constant: ϵ		39.2	39.5	52.7	51.0
Conductivity: σ		1.80	1.81	1.95	1.98

Test System Validation

Prior to assessment, the system is verified to the $\pm 10\%$ of the specifications at 2450 MHz by using the system validation kit. (Graphic Plots Attached)

Table A.2 System Validation

SYSTEM DIPOLE VALIDATION TARGET & MEASURED (0.05 W)				
System Validation Kit: D-2450S, S/N: 105	2450MHz Brain	Targeted SAR_{1g} (mW/g) 2.620	Measured SAR_{1g} (mW/g) 2.54	Deviation (%) - 2.94



Figure A.0 Dipole Validation Test Setup



PCTEST SAR TEST REPORT	 CLASS II PERMISSIVE CHANGE FCC CERTIFICATION 			Reviewed by: Quality Manager
SAR Filename: SAR.230311131.H9P	Test Dates: March 11, 2003	EUT Type: Symbol Wireless Wall Scanner	FCC ID: H9PLA4121	Page 18 of 35

EXHIBIT A. SAR DATA SUMMARY

Mixture Type: 2450MHz Muscle

A.1 MEASUREMENT RESULTS (Body SAR – Back Side)							
FREQUENCY		Modulation	Begin / End POWER [‡]		Separation Distance (cm)	Antenna Position ^{††}	SAR (W/kg)
MHz	Ch.		(dBm)				
2412	01	DSSS	21.82	21.80	TOUCH	FIXED	0.06
2437	06	DSSS	20.52	20.49	TOUCH	FIXED	0.05
2462	11	DSSS	19.40	19.39	TOUCH	FIXED	0.08
ANSI / IEEE C95.1 1992 - SAFETY LIMIT Spatial Peak Uncontrolled Exposure/General Population					Muscle 1.6 W/kg (mW/g) averaged over 1 gram		

NOTES:

1. The test data reported are the worst-case SAR value with the antenna-head position set in atypical configuration. Test procedures used are according to FCC/OET Bulletin 65, Supp.C [July 2001].
2. All modes of operation were investigated, and worst-case results are reported.
3. [‡]Power Measured Conducted ERP EIRP
4. SAR Measurement System DASY3 IDX
Phantom Configuration Left Head Flat Phantom Right Head
5. SAR Configuration Head Body Hand
6. Test Signal Call Mode Manu. Test Codes Base Station Simulator
7. Tissue parameters and temperatures are listed on the SAR plots.
8. Liquid tissue depth is 15.1 cm. ± 0.1

Alfred

Alfred Cirwithian
Vice President Engineering



**Figure A.1
Body SAR Test Setup**

PCTEST SAR TEST REPORT		CLASS II PERMISSIVE CHANGE[†] FCC CERTIFICATION	Reviewed by: Quality Manager
SAR Filename: SAR.230311131.H9P	Test Dates: March 11, 2003	EUT Type: Symbol Wireless Wall Scanner	FCC ID: H9PLA4121

EXHIBIT A. SAR DATA SUMMARY (CONTINUED)

Mixture Type: 2450MHz Muscle

A.2 MEASUREMENT RESULTS (Body SAR – Top/Transmitter Side)							
FREQUENCY		Modulation	Begin / End POWER [†]		Separation Distance (cm) ^{††}	Antenna Position	SAR (W/kg)
MHz	Ch.		(dBm)				
2412	01	DSSS	21.80	21.77	TOUCH	FIXED	0.23
2437	06	DSSS	20.51	20.49	TOUCH	FIXED	0.21
2462	11	DSSS	19.43	19.39	TOUCH	FIXED	0.27
ANSI / IEEE C95.1 1992 - SAFETY LIMIT Spatial Peak Uncontrolled Exposure/General Population					Muscle 1.6 W/kg (mW/g) averaged over 1 gram		

NOTES:

1. The test data reported are the worst-case SAR value with the antenna-head position set in atypical configuration. Test procedures used are according to FCC/OET Bulletin 65, Supplement C [July 2001].
2. All modes of operation were investigated, and worst-case results are reported.
3. †Power Measured Conducted ERP EIRP
4. SAR Measurement System DASY3 IDX
Phantom Configuration Left Head Flat Phantom Right Head
5. SAR Configuration Head Body Hand
6. Test Signal Call Mode Software Base Station Simulator
7. Tissue parameters and temperatures are listed on the SAR plots.
8. Liquid tissue depth is 15.1 cm. ± 0.1



Alfred Cirwithian
Vice President Engineering



Figure A.2
Body SAR Test Setup

PCTEST SAR TEST REPORT		CLASS II PERMISSIVE CHANGE[†] FCC CERTIFICATION	Reviewed by: Quality Manager
SAR Filename: SAR.230311131.H9P	Test Dates: March 11, 2003	EUT Type: Symbol Wireless Wall Scanner	FCC ID: H9PLA4121

EXHIBIT B. TEST RESULTS

EXHIBIT B – Test Results (Cont.)

Radiated Measurements

§15.247(b) / §15.205 & §15.209

Transfer Rate: 1 Mbps
 Distance of Measurements: 3 Meters
 Channel: 01

Frequency (MHz)	Level (dBm)	Peak/Average	AFCL (dB)	POL (H/V)	F/S (dBmV/m)	F/S (mV/m)	Margin (dB)
4824	-98.0	Peak	40.4	V	49.4	294.8	4.6
7236	-103.2	Peak	47.4	V	51.2	363.9	2.8
9648	-105.6	Peak	50.3	V	51.7	384.6	2.3
12060	-135.0	Peak	53.7	V	25.7	19.3	28.3

Table B-1. Radiated Measurements @ 3 meters

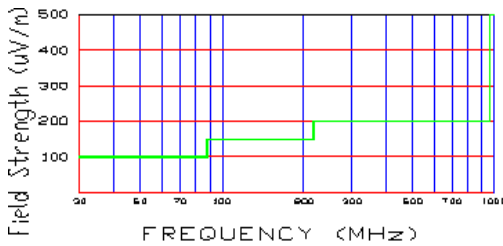

Figure B-1. Radiated limits at 3 meters.

NOTES:

1. All harmonics in the restricted bands specified in §15.205 are below the limit shown in Table G-1. (Note: * = Restricted Band measured frequency)
2. All harmonics/spurs are at least 20 dB below the highest emission in the authorized band using RBW = 100kHz
3. Average Measurements > 1GHz using RBW = 1 MHz VBW = 10 Hz
4. The peak emissions above 1 GHz are not more than 20 dB above the average limit.
5. The antenna is manipulated through typical positions, polarity and length during the tests.
6. The EUT is supplied with nominal AC voltage or/and a new/fully-recharged battery.
7. The spectrum is measured from 9kHz to the 10th harmonic and the worst-case emissions are reported.
8. < - 135 are below the analyzer floor level.
9. Above 1 GHz, the limit is 500 µV/m (54dBµ/m) at 3 meters radiated.

PCTEST SAR TEST REPORT	 CLASS II PERMISSIVE CHANGE[†] FCC CERTIFICATION			Reviewed by: Quality Manager
SAR Filename: SAR.230311131.H9P	Test Dates: March 11, 2003	EUT Type: Symbol Wireless Wall Scanner	FCC ID: H9PLA4121	Page 21 of 35

EXHIBIT B. TEST RESULTS (CONTINUED)

EXHIBIT B – Test Results (Cont.) Radiated Measurements (Cont.)

§15.247(b) / §15.205 & §15.209

Transfer Rate: 1 Mbps
 Distance of Measurements: 3 Meters
 Channel: 06

Frequency (MHz)	Level (dBm)	Peak/Average	AFCL (dB)	POL (H/V)	F/S (dBmV/m)	F/S (mV/m)	Margin (dB)
4874	-97.5	Peak	40.5	V	50.0	316.2	4.0
7311	-103.0	Peak	48.0	V	52.0	398.1	2.0
9748	-105.5	Peak	50.3	V	51.8	389.0	2.2
12185	-135.0	Peak	53.7	V	25.7	19.3	28.3

Table B-2. Radiated Measurements @ 3 meters

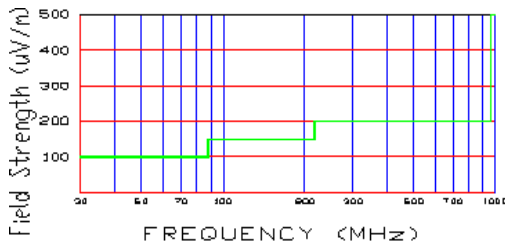

Figure B-2. Radiated limits at 3 meters.

NOTES:

- All harmonics in the restricted bands specified in §15.205 are below the limit shown in Table G-1. (Note: * = Restricted Band measured frequency)
- All harmonics/spurs are at least 20 dB below the highest emission in the authorized band using RBW = 100kHz
- Average Measurements > 1GHz using RBW = 1 MHz VBW = 10 Hz
- The peak emissions above 1 GHz are not more than 20 dB above the average limit.
- The antenna is manipulated through typical positions, polarity and length during the tests.
- The EUT is supplied with nominal AC voltage or/and a new/fully-recharged battery.
- The spectrum is measured from 9kHz to the 10th harmonic and the worst-case emissions are reported.
- < - 135 are below the analyzer floor level.
- Above 1 GHz, the limit is 500 μ V/m (54dB μ m) at 3 meters radiated.

PCTEST SAR TEST REPORT	 CLASS II PERMISSIVE CHANGE FCC CERTIFICATION			Reviewed by: Quality Manager
SAR Filename: SAR.230311131.H9P	Test Dates: March 11, 2003	EUT Type: Symbol Wireless Wall Scanner	FCC ID: H9PLA4121	Page 22 of 35

EXHIBIT B. TEST RESULTS (CONTINUED)

EXHIBIT B – Test Results (Cont.) Radiated Measurements (Cont.)

§15.247(b) / §15.205 & §15.209

Transfer Rate: 1 Mbps
 Distance of Measurements: 3 Meters
 Channel: 11

Frequency (MHz)	Level (dBm)	Peak/Average	AFCL (dB)	POL (H/V)	F/S (dBmV/m)	F/S (mV/m)	Margin (dB)
4924	-99.8	Peak	40.7	V	47.9	248.3	6.1
7386	-104.1	Peak	48.2	V	51.1	358.9	2.9
9848	-106.0	Peak	50.4	V	51.4	371.5	2.6
12310	-135.0	Peak	53.8	V	25.8	19.5	28.2

Table B-3. Radiated Measurements @ 3 meters

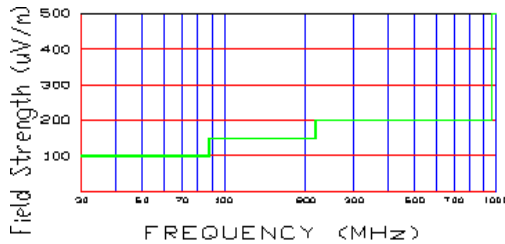

Figure B-3. Radiated limits at 3 meters.

NOTES:

1. All harmonics in the restricted bands specified in §15.205 are below the limit shown in Table G-1. (Note: * = Restricted Band measured frequency)
2. All harmonics/spurs are at least 20 dB below the highest emission in the authorized band using RBW = 100kHz
3. Average Measurements > 1GHz using RBW = 1 MHz VBW = 10 Hz
4. The peak emissions above 1 GHz are not more than 20 dB above the average limit.
5. The antenna is manipulated through typical positions, polarity and length during the tests.
6. The EUT is supplied with nominal AC voltage or/and a new/fully-recharged battery.
7. The spectrum is measured from 9kHz to the 10th harmonic and the worst-case emissions are reported.
8. < - 135 are below the analyzer floor level.
9. Above 1 GHz, the limit is 500 μ V/m (54dB μ /m) at 3 meters radiated.

PCTEST SAR TEST REPORT	CLASS II PERMISSIVE CHANGE FCC CERTIFICATION			Reviewed by: Quality Manager
SAR Filename: SAR.230311131.H9P	Test Dates: March 11, 2003	EUT Type: Symbol Wireless Wall Scanner	FCC ID: H9PLA4121	Page 23 of 35

EXHIBIT B. TEST RESULTS (CONTINUED)

EXHIBIT B – Test Results (Cont.) Radiated Measurements (Cont.)

§15.247(b) / §15.205 & §15.209

Transfer Rate: 2 Mbps
 Distance of Measurements: 3 Meters
 Channel: 01

Frequency (MHz)	Level (dBm)	Peak/Average	AFCL (dB)	POL (H/V)	F/S (dBmV/m)	F/S (mV/m)	Margin (dB)
4824	-98.4	Peak	40.4	V	49.0	281.5	5.0
7236	-103.5	Peak	47.4	V	50.9	351.6	3.1
9648	-106.1	Peak	50.3	V	51.2	363.1	2.8
12060	-135.0	Peak	53.7	V	25.7	19.3	28.3

Table B-4. Radiated Measurements @ 3 meters

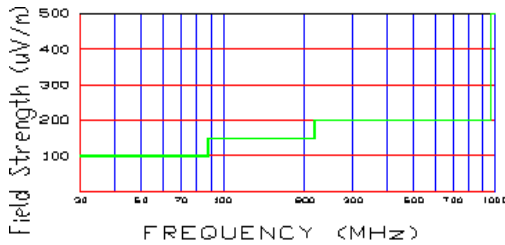

Figure B-4. Radiated limits at 3 meters.

NOTES:

1. All harmonics in the restricted bands specified in §15.205 are below the limit shown in Table G-1. (Note: * = Restricted Band measured frequency)
2. All harmonics/spurs are at least 20 dB below the highest emission in the authorized band using RBW = 100kHz
3. Average Measurements > 1GHz using RBW = 1 MHz VBW = 10 Hz
4. The peak emissions above 1 GHz are not more than 20 dB above the average limit.
5. The antenna is manipulated through typical positions, polarity and length during the tests.
6. The EUT is supplied with nominal AC voltage or/and a new/fully-recharged battery.
7. The spectrum is measured from 9kHz to the 10th harmonic and the worst-case emissions are reported.
8. < - 135 are below the analyzer floor level.
9. Above 1 GHz, the limit is 500 mV/m (54dBm/m) at 3 meters radiated.

PCTEST SAR TEST REPORT		CLASS II PERMISSIVE CHANGE[†] FCC CERTIFICATION		Reviewed by: Quality Manager
SAR Filename: SAR.230311131.H9P	Test Dates: March 11, 2003	EUT Type: Symbol Wireless Wall Scanner	FCC ID: H9PLA4121	Page 24 of 35

EXHIBIT B. TEST RESULTS (CONTINUED)

EXHIBIT B – Test Results (Cont.) Radiated Measurements (Cont.)

§15.247(b) / §15.205 & §15.209

Transfer Rate: 2 Mbps
 Distance of Measurements: 3 Meters
 Channel: 06

Frequency (MHz)	Level (dBm)	Peak/Average	AFCL (dB)	POL (H/V)	F/S (dBmV/m)	F/S (mV/m)	Margin (dB)
4874	-97.5	Peak	40.5	V	50.0	316.2	4.0
7311	-104.2	Peak	48.0	V	50.8	346.7	3.2
9748	-106.3	Peak	50.3	V	51.0	354.8	3.0
12185	-135.0	Peak	53.7	V	25.7	19.27	28.3

Table B-5. Radiated Measurements @ 3 meters

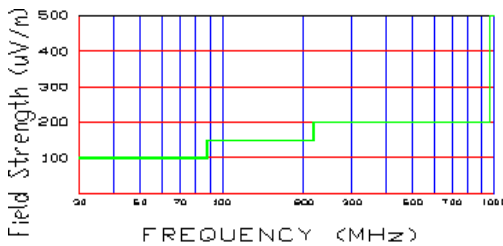

Figure B-5. Radiated limits at 3 meters.

NOTES:

1. All harmonics in the restricted bands specified in §15.205 are below the limit shown in Table G-1. (Note: * = Restricted Band measured frequency)
2. All harmonics/spurs are at least 20 dB below the highest emission in the authorized band using RBW = 100kHz
3. Average Measurements > 1GHz using RBW = 1 MHz VBW = 10 Hz
4. The peak emissions above 1 GHz are not more than 20 dB above the average limit.
5. The antenna is manipulated through typical positions, polarity and length during the tests.
6. The EUT is supplied with nominal AC voltage or/and a new/fully-recharged battery.
7. The spectrum is measured from 9kHz to the 10th harmonic and the worst-case emissions are reported.
8. < - 135 are below the analyzer floor level.
9. Above 1 GHz, the limit is 500 μ V/m (54dB μ m) at 3 meters radiated.

PCTEST SAR TEST REPORT	 CLASS II PERMISSIVE CHANGE FCC CERTIFICATION		Reviewed by: Quality Manager
SAR Filename: SAR.230311131.H9P	Test Dates: March 11, 2003	EUT Type: Symbol Wireless Wall Scanner	FCC ID: H9PLA4121
			Page 25 of 35

EXHIBIT B. TEST RESULTS (CONTINUED)

EXHIBIT B – Test Results (Cont.) Radiated Measurements (Cont.)

§15.247(b) / §15.205 & §15.209

Transfer Rate: 2 Mbps
 Distance of Measurements: 3 Meters
 Channel: 11

Frequency (MHz)	Level (dBm)	Peak/Average	AFCL (dB)	POL (H/V)	F/S (dBmV/m)	F/S (mV/m)	Margin (dB)
4924	-100.1	Peak	40.7	V	47.6	239.9	6.4
7386	-104.3	Peak	48.2	V	50.9	350.7	3.1
9848	-106.3	Peak	50.4	V	51.1	358.9	2.9
12310	-135.0	Peak	53.8	V	25.8	19.5	28.2

Table B-6. Radiated Measurements @ 3 meters

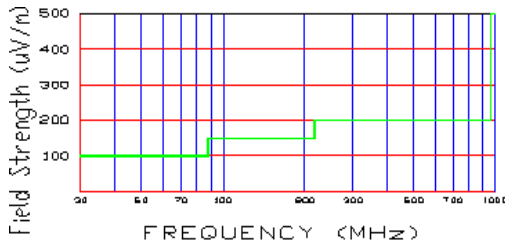

Figure B-6. Radiated limits at 3 meters.

NOTES:

1. All harmonics in the restricted bands specified in §15.205 are below the limit shown in Table G-1. (Note: * = Restricted Band measured frequency)
2. All harmonics/spurs are at least 20 dB below the highest emission in the authorized band using RBW = 100kHz
3. Average Measurements > 1GHz using RBW = 1 MHz VBW = 10 Hz
4. The peak emissions above 1 GHz are not more than 20 dB above the average limit.
5. The antenna is manipulated through typical positions, polarity and length during the tests.
6. The EUT is supplied with nominal AC voltage or/and a new/fully-recharged battery.
7. The spectrum is measured from 9kHz to the 10th harmonic and the worst-case emissions are reported.
8. < - 135 are below the analyzer floor level.
9. Above 1 GHz, the limit is 500 µV/m (54dBµ/m) at 3 meters radiated.

PCTEST SAR TEST REPORT	 CLASS II PERMISSIVE CHANGE FCC CERTIFICATION			Reviewed by: Quality Manager
SAR Filename: SAR.230311131.H9P	Test Dates: March 11, 2003	EUT Type: Symbol Wireless Wall Scanner	FCC ID: H9PLA4121	Page 26 of 35

EXHIBIT B. TEST RESULTS (CONTINUED)

EXHIBIT B – Test Results (Cont.) Radiated Measurements (Cont.)

§15.247(b) / §15.205 & §15.209

Transfer Rate: 5.5 Mbps
 Distance of Measurements: 3 Meters
 Channel: 01

Frequency (MHz)	Level (dBm)	Peak/Average	AFCL (dB)	POL (H/V)	F/S (dBmV/m)	F/S (mV/m)	Margin (dB)
4824	-99.1	Peak	40.4	V	48.3	259.7	5.7
7236	-103.9	Peak	47.4	V	50.5	335.7	3.5
9648	-106.3	Peak	50.3	V	51.0	354.8	3.0
12060	-135.0	Peak	53.7	V	25.7	19.3	28.3

Table B-7. Radiated Measurements @ 3 meters

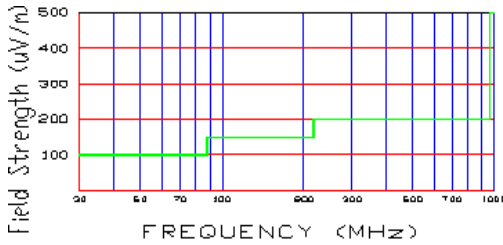

Figure B-7. Radiated limits at 3 meters.

NOTES:

1. All harmonics in the restricted bands specified in §15.205 are below the limit shown in Table G-1. (Note: * = Restricted Band measured frequency)
2. All harmonics/spurs are at least 20 dB below the highest emission in the authorized band using RBW = 100kHz
3. Average Measurements > 1GHz using RBW = 1 MHz VBW = 10 Hz
4. The peak emissions above 1 GHz are not more than 20 dB above the average limit.
5. The antenna is manipulated through typical positions, polarity and length during the tests.
6. The EUT is supplied with nominal AC voltage or/and a new/fully-recharged battery.
7. The spectrum is measured from 9kHz to the 10th harmonic and the worst-case emissions are reported.
8. < - 135 are below the analyzer floor level.
9. Above 1 GHz, the limit is 500 μ V/m (54dB μ /m) at 3 meters radiated.

PCTEST SAR TEST REPORT	 CLASS II PERMISSIVE CHANGE FCC CERTIFICATION			Reviewed by: Quality Manager
SAR Filename: SAR.230311131.H9P	Test Dates: March 11, 2003	EUT Type: Symbol Wireless Wall Scanner	FCC ID: H9PLA4121	Page 27 of 35

EXHIBIT B. TEST RESULTS (CONTINUED)

EXHIBIT B – Test Results (Cont.) Radiated Measurements (Cont.)

§15.247(b) / §15.205 & §15.209

Transfer Rate: 5.5 Mbps
 Distance of Measurements: 3 Meters
 Channel: 06

Frequency (MHz)	Level (dBm)	Peak/Average	AFCL (dB)	POL (H/V)	F/S (dBmV/m)	F/S (mV/m)	Margin (dB)
4874	-97.8	Peak	40.5	V	49.7	305.5	4.3
7311	-104.2	Peak	48.0	V	50.8	346.7	3.2
9748	-106.4	Peak	50.3	V	50.9	350.7	3.1
12185	-135.0	Peak	53.7	V	25.7	19.3	28.3

Table B-8. Radiated Measurements @ 3 meters

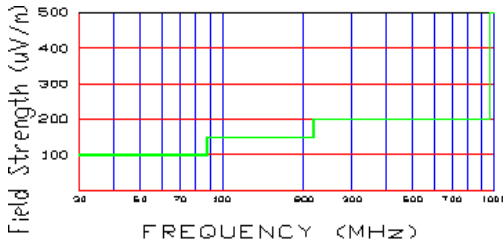

Figure B-8. Radiated limits at 3 meters.

NOTES:

1. All harmonics in the restricted bands specified in §15.205 are below the limit shown in Table G-1. (Note: * = Restricted Band measured frequency)
2. All harmonics/spurs are at least 20 dB below the highest emission in the authorized band using RBW = 100kHz
3. Average Measurements > 1GHz using RBW = 1 MHz VBW = 10 Hz
4. The peak emissions above 1 GHz are not more than 20 dB above the average limit.
5. The antenna is manipulated through typical positions, polarity and length during the tests.
6. The EUT is supplied with nominal AC voltage or/and a new/fully-recharged battery.
7. The spectrum is measured from 9kHz to the 10th harmonic and the worst-case emissions are reported.
8. < - 135 are below the analyzer floor level.
9. Above 1 GHz, the limit is 500 µV/m (54dBµ/m) at 3 meters radiated.

PCTEST SAR TEST REPORT	 CLASS II PERMISSIVE CHANGE FCC CERTIFICATION			Reviewed by: Quality Manager
SAR Filename: SAR.230311131.H9P	Test Dates: March 11, 2003	EUT Type: Symbol Wireless Wall Scanner	FCC ID: H9PLA4121	Page 28 of 35

EXHIBIT B. TEST RESULTS (CONTINUED)

EXHIBIT B – Test Results (Cont.) Radiated Measurements (Cont.)

§15.247(b) / §15.205 & §15.209

Transfer Rate: 5.5 Mbps
 Distance of Measurements: 3 Meters
 Channel: 11

Frequency (MHz)	Level (dBm)	Peak/Average	AFCL (dB)	POL (H/V)	F/S (dBmV/m)	F/S (mV/m)	Margin (dB)
4924	-99.8	Peak	40.7	V	47.9	248.3	6.1
7386	-104.1	Peak	48.2	V	51.1	358.9	2.9
9848	-106.0	Peak	50.4	V	51.4	371.5	2.6
12310	-135.0	Peak	53.8	V	25.8	19.5	28.2

Table B-9. Radiated Measurements @ 3 meters

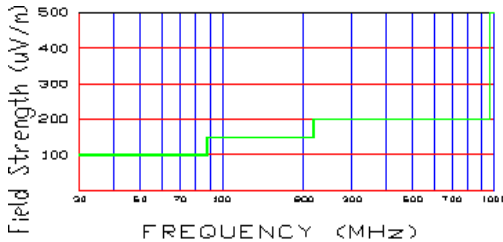

Figure B-9. Radiated limits at 3 meters.

NOTES:

1. All harmonics in the restricted bands specified in §15.205 are below the limit shown in Table G-1. (Note: * = Restricted Band measured frequency)
2. All harmonics/spurs are at least 20 dB below the highest emission in the authorized band using RBW = 100kHz
3. Average Measurements > 1GHz using RBW = 1 MHz VBW = 10 Hz
4. The peak emissions above 1 GHz are not more than 20 dB above the average limit.
5. The antenna is manipulated through typical positions, polarity and length during the tests.
6. The EUT is supplied with nominal AC voltage or/and a new/fully-recharged battery.
7. The spectrum is measured from 9kHz to the 10th harmonic and the worst-case emissions are reported.
8. < - 135 are below the analyzer floor level.
9. Above 1 GHz, the limit is 500 µV/m (54dBµ/m) at 3 meters radiated.

PCTEST SAR TEST REPORT	 CLASS II PERMISSIVE CHANGE[†] FCC CERTIFICATION			Reviewed by: Quality Manager
SAR Filename: SAR.230311131.H9P	Test Dates: March 11, 2003	EUT Type: Symbol Wireless Wall Scanner	FCC ID: H9PLA4121	Page 29 of 35

EXHIBIT B. TEST RESULTS (CONTINUED)

EXHIBIT B – Test Results (Cont.) Radiated Measurements (Cont.)

§15.247(b) / §15.205 & §15.209

Transfer Rate: 11 Mbps
 Distance of Measurements: 3 Meters
 Channel: 01

Frequency (MHz)	Level (dBm)	Peak/Average	AFCL (dB)	POL (H/V)	F/S (dBmV/m)	F/S (mV/m)	Margin (dB)
4824	-99.4	Peak	40.4	V	48.0	250.9	6.0
7236	-104.5	Peak	47.4	V	49.9	313.3	4.1
9648	-107.0	Peak	50.3	V	50.3	371.3	3.7
12060	-135.0	Peak	53.7	V	25.7	19.3	28.3

Table B-10. Radiated Measurements @ 3 meters

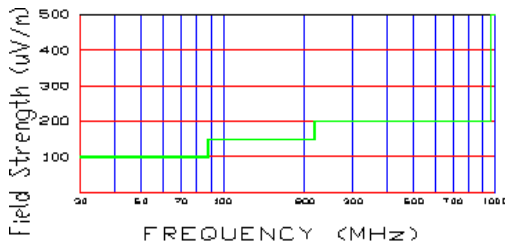

Figure B-10. Radiated limits at 3 meters.

NOTES:

1. All harmonics in the restricted bands specified in §15.205 are below the limit shown in Table G-1. (Note: * = Restricted Band measured frequency)
2. All harmonics/spurs are at least 20 dB below the highest emission in the authorized band using RBW = 100kHz
3. Average Measurements > 1GHz using RBW = 1 MHz VBW = 10 Hz
4. The peak emissions above 1 GHz are not more than 20 dB above the average limit.
5. The antenna is manipulated through typical positions, polarity and length during the tests.
6. The EUT is supplied with nominal AC voltage or/and a new/fully-recharged battery.
7. The spectrum is measured from 9kHz to the 10th harmonic and the worst-case emissions are reported.
8. < - 135 are below the analyzer floor level.
9. Above 1 GHz, the limit is 500 μ V/m (54dB μ /m) at 3 meters radiated.

PCTEST SAR TEST REPORT	 CLASS II PERMISSIVE CHANGE FCC CERTIFICATION			Reviewed by: Quality Manager
SAR Filename: SAR.230311131.H9P	Test Dates: March 11, 2003	EUT Type: Symbol Wireless Wall Scanner	FCC ID: H9PLA4121	Page 30 of 35

EXHIBIT B. TEST RESULTS (CONTINUED)

EXHIBIT B – Test Results (Cont.) Radiated Measurements (Cont.)

§15.247(b) / §15.205 & §15.209

Transfer Rate: 11 Mbps
 Distance of Measurements: 3 Meters
 Channel: 06

Frequency (MHz)	Level (dBm)	Peak/Average	AFCL (dB)	POL (H/V)	F/S (dBmV/m)	F/S (mV/m)	Margin (dB)
4874	-99.2	Peak	40.5	V	48.3	260.0	5.7
7311	-104.2	Peak	48.0	V	50.8	346.7	3.2
9748	-107.0	Peak	50.3	V	50.3	327.3	3.7
12185	-135.0	Peak	53.7	V	25.7	19.3	28.3

Table B-11. Radiated Measurements @ 3 meters

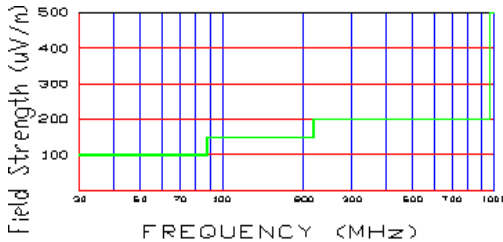

Figure B-11. Radiated limits at 3 meters.

NOTES:

1. All harmonics in the restricted bands specified in §15.205 are below the limit shown in Table G-1. (Note: * = Restricted Band measured frequency)
2. All harmonics/spurs are at least 20 dB below the highest emission in the authorized band using RBW = 100kHz
3. Average Measurements > 1GHz using RBW = 1 MHz VBW = 10 Hz
4. The peak emissions above 1 GHz are not more than 20 dB above the average limit.
5. The antenna is manipulated through typical positions, polarity and length during the tests.
6. The EUT is supplied with nominal AC voltage or/and a new/fully-recharged battery.
7. The spectrum is measured from 9kHz to the 10th harmonic and the worst-case emissions are reported.
8. < - 135 are below the analyzer floor level.
9. Above 1 GHz, the limit is 500 mV/m (54dBm/m) at 3 meters radiated.

PCTEST SAR TEST REPORT	 CLASS II PERMISSIVE CHANGE FCC CERTIFICATION			Reviewed by: Quality Manager
SAR Filename: SAR.230311131.H9P	Test Dates: March 11, 2003	EUT Type: Symbol Wireless Wall Scanner	FCC ID: H9PLA4121	Page 31 of 35

EXHIBIT B. TEST RESULTS (CONTINUED)

EXHIBIT B – Test Results (Cont.) Radiated Measurements (Cont.)

§15.247(b) / §15.205 & §15.209

Transfer Rate: 11 Mbps
 Distance of Measurements: 3 Meters
 Channel: 11

Frequency (MHz)	Level (dBm)	Peak/Average	AFCL (dB)	POL (H/V)	F/S (dBmV/m)	F/S (mV/m)	Margin (dB)
4924	-100.2	Peak	40.7	V	47.5	237.1	6.5
7386	-105.3	Peak	48.2	V	49.9	312.6	4.1
9848	-107.2	Peak	50.4	V	50.2	323.6	3.8
12310	-135.0	Peak	53.8	V	25.8	19.5	28.2

Table B-12. Radiated Measurements @ 3 meters

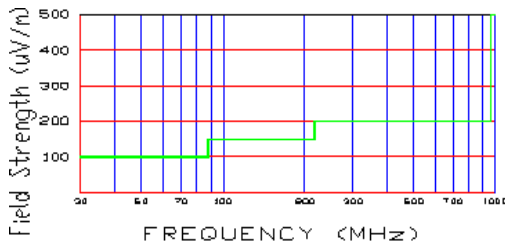

Figure B-12. Radiated limits at 3 meters.

NOTES:

1. All harmonics in the restricted bands specified in §15.205 are below the limit shown in Table G-1. (Note: * = Restricted Band measured frequency)
2. All harmonics/spurs are at least 20 dB below the highest emission in the authorized band using RBW = 100kHz
3. Average Measurements > 1GHz using RBW = 1 MHz VBW = 10 Hz
4. The peak emissions above 1 GHz are not more than 20 dB above the average limit.
5. The antenna is manipulated through typical positions, polarity and length during the tests.
6. The EUT is supplied with nominal AC voltage or/and a new/fully-recharged battery.
7. The spectrum is measured from 9kHz to the 10th harmonic and the worst-case emissions are reported.
8. < - 135 are below the analyzer floor level.
9. Above 1 GHz, the limit is 500 μ V/m (54dB μ /m) at 3 meters radiated.

PCTEST SAR TEST REPORT	 CLASS II PERMISSIVE CHANGE FCC CERTIFICATION			Reviewed by: Quality Manager
SAR Filename: SAR.230311131.H9P	Test Dates: March 11, 2003	EUT Type: Symbol Wireless Wall Scanner	FCC ID: H9PLA4121	Page 32 of 35

EXHIBIT B. TEST RESULTS (CONTINUED)

EXHIBIT B – Test Results (Cont.)

Radiated Restricted Band Measurements

§15.205 / §15.209

Special attention is made for the EUT's harmonic and spurious radiated emission in the restricted bands of operations. The EUT was tested from 9kHz and up to the tenth harmonic of the fundamental frequency of the transmitter using CISPR quasi peak detector below 1GHz. Above 1 GHz, average measurement was used, using RBW 1MHz – VBW 10Hz and linearly polarized horn antennas. All harmonics/spurs are at least 20dB below the highest emission in the authorized band using RBW = 100kHz. In addition, peak measurements were taken to ensure that the peak levels are not more than 20dB above the average limit. All out of band emissions, other than those created by the spreading sequence, data sequence, and the carrier modulation must not exceed the limits show in Table G-1 per Section 15.209.

Frequency	F/S (mV/m)	Measured Distance (Meters)
0.009 – 0.490 MHz	2400/F (kHz)	300
0.490 – 1.705 MHz	24000/F (kHz)	30
1.705 – 30.00 MHz	30	30
30.00 – 88.00 MHz	100	3
88.00 – 216.0 MHz	150	3
216.0 – 960.0 MHz	200	3
Above 960.0 MHz	500	3

Table B-13. Restricted Band Limits

TEST MEASUREMENT EQUIPMENT

HP 8562A	Spectrum Analyzer 50GHz
HP 8566B	Spectrum Analyzer 100Hz – 22GHz
HP 83017A	Microwave Analyzer 40dB Gain (0.5 – 26.5GHz)
HP 3784A	Digital Transmission Analyzer
EMCO 3115	Horn Antenna (1 – 18GHz)
HP 8495A	20dB Attenuator (DC-40GHz) 0 – 70dB
HP 8493B	10dB Attenuator
MicroCoax Cables	Low Loss Microwave Cables (1 – 26.5GHz)
CDI Dipoles	Dipole Antennas (30 – 1000MHz)
EMCO 3116	Horn Antenna (18 – 40GHz)



PCTEST SAR TEST REPORT	 CLASS II PERMISSIVE CHANGE^F FCC CERTIFICATION 			Reviewed by: Quality Manager
SAR Filename: SAR.230311131.H9P	Test Dates: March 11, 2003	EUT Type: Symbol Wireless Wall Scanner	FCC ID: H9PLA4121	Page 33 of 35

EXHIBIT B. TEST RESULTS (CONTINUED)

EXHIBIT B – Test Results (Cont.) Radiated Restricted Band Measurements (Cont.)

§15.205 /§15.209 courtesy

Operating Frequency: 2462 MHz
Distance of Measurements: 3 Meters

FREQ (MHz)	Level (dBm)	AFCL (dB/m)	POL (H/V)	F/S (dB μ V/m)	F/S (μ V/M)	Margin (dB)
2483.8	-96.5	33.0	V	43.5	149.6	-10.5
2484.7	-99.6	33.0	V	40.4	104.7	-13.6
2484.9	-103.6	33.1	V	36.5	66.8	-17.5
2485.2	-112.0	33.1	V	28.1	25.4	-25.9
2490.4	-114.0	33.2	V	26.2	20.4	-27.8
2492.3	-105.3	33.2	V	34.9	55.6	-19.1

Table B-14. Radiated Restricted Band Measurements at 3-meters

NOTES:

1. The antenna is manipulated through typical positions, polarity and length during the testing.
2. The EUT is supplied with the minimal AC voltage or/and a new/fully re-charged battery.
3. The spectrum is measured from 9kHz up to the 10th harmonic and the worst-case emissions are reported.
4. The conducted limits are shown on Figure A-14. Above 1 GHz the limit is 500 μ V/m.
5. < -135dBm is below the analyzer measurement floor level.

PCTEST SAR TEST REPORT	 CLASS II PERMISSIVE CHANGE FCC CERTIFICATION			Reviewed by: Quality Manager
SAR Filename: SAR.230311131.H9P	Test Dates: March 11, 2003	EUT Type: Symbol Wireless Wall Scanner	FCC ID: H9PLA4121	Page 34 of 35

EXHIBIT C. TEST RESULTS (CONTINUED)

EXHIBIT C – Test Results (Cont.)

Line-Conducted Test Data

§15.207

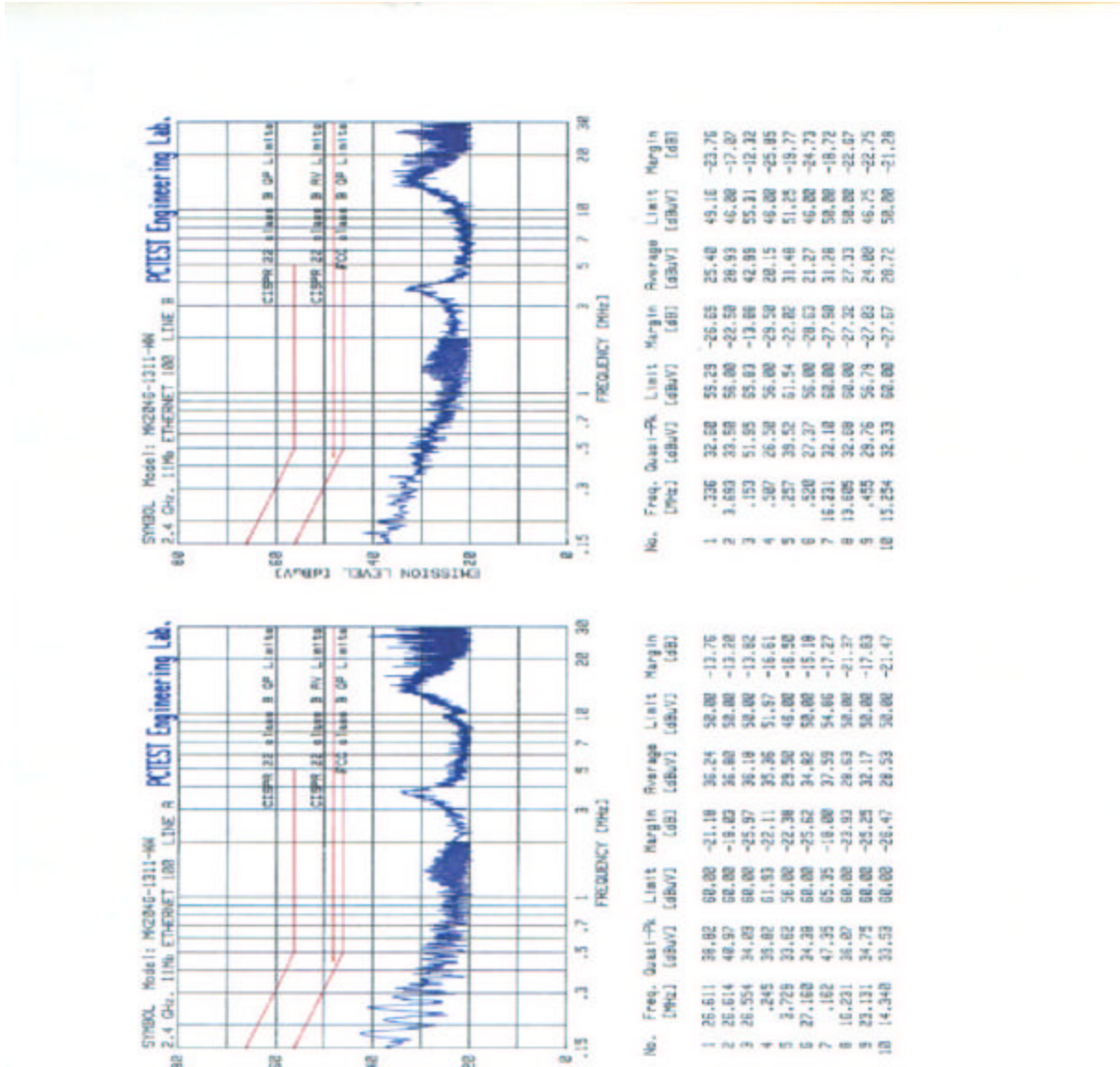

Notes:

1. All Modes of operation were investigated and the worst-case emissions are reported.
2. The limit for Class B device(s) from 150kHz to 30MHz are Specified in EN55022.
3. Line A = Phase; Line B = Neutral
4. Deviations to the Specifications: *None*.

PCTEST SAR TEST REPORT	CLASS II PERMISSIVE CHANGE FCC CERTIFICATION			Reviewed by: Quality Manager
SAR Filename: SAR.230311131.H9P	Test Dates: March 11, 2003	EUT Type: Symbol Wireless Wall Scanner	FCC ID: H9PLA4121	Page 35 of 35

APPENDIX A: SAR TEST DATA

SAR Data Report 03031114

Start : 11-Mar-03 01:34:57 pm
End : 11-Mar-03 01:40:04 pm
Code Version : 4.08
Robot Version: 4.08

Product Data:

Type : SYMBOL
Model Number : MK2046-1311-WW
Serial Number : ALP53326
Frequency : 2462 MHz
Transmit Pwr : 0.135 W
Antenna Type : Helical
Antenna Posn. : Internal

Measurement Data:

Phantom Name : SAM-FLAT-B
Phantom Type : Uniphantom
Tissue Type : Muscle
Tissue Dielectric : 51.000
Tissue Conductivity : 1.980
Tissue Density : 1.000
Robot Name : CRS

Probe Data:

Probe Name : PCT003
Probe Type : E Fld Triangle
Frequency : 2450 MHz
Tissue Type : Muscle
Calibrated Dielectric : 52.300
Calibrated Conductivity : 1.990
Calibrated Density : 1.000
Probe Offset : 2.400 mm
Conversion Factor : 9.900
Probe Sensitivity : 2.075 2.820 2.456 mV/(mW/cm^2)
Amplifier Gains : 20.00 20.00 20.00

Sample:

Rate: 6000 Samples/Sec
Count: 1000 Samples
NIDAQ Gain: 5

Comments:

DSS Mode CH-11
BODY
CF=1; Amb. Temp= 22.3 'C; Liq. Temp=21.1 'C

Area Scan - Max Peak SAR Value at x=-23.0 y=10.0 = 0.04 W/kg

Zoom Scan - Max Peak SAR Value at x=-18.0 y=5.0 z=0.0 = 0.19 W/kg

Max 1g SAR at x=-19.0 y=8.0 z=0.0 = 0.08 W/kg

Max 10g SAR at x=-23.0 y=10.0 z=0.0 = 0.03 W/kg

SAR - Z Axis
at Hotspot x:-18.0 y:5.0

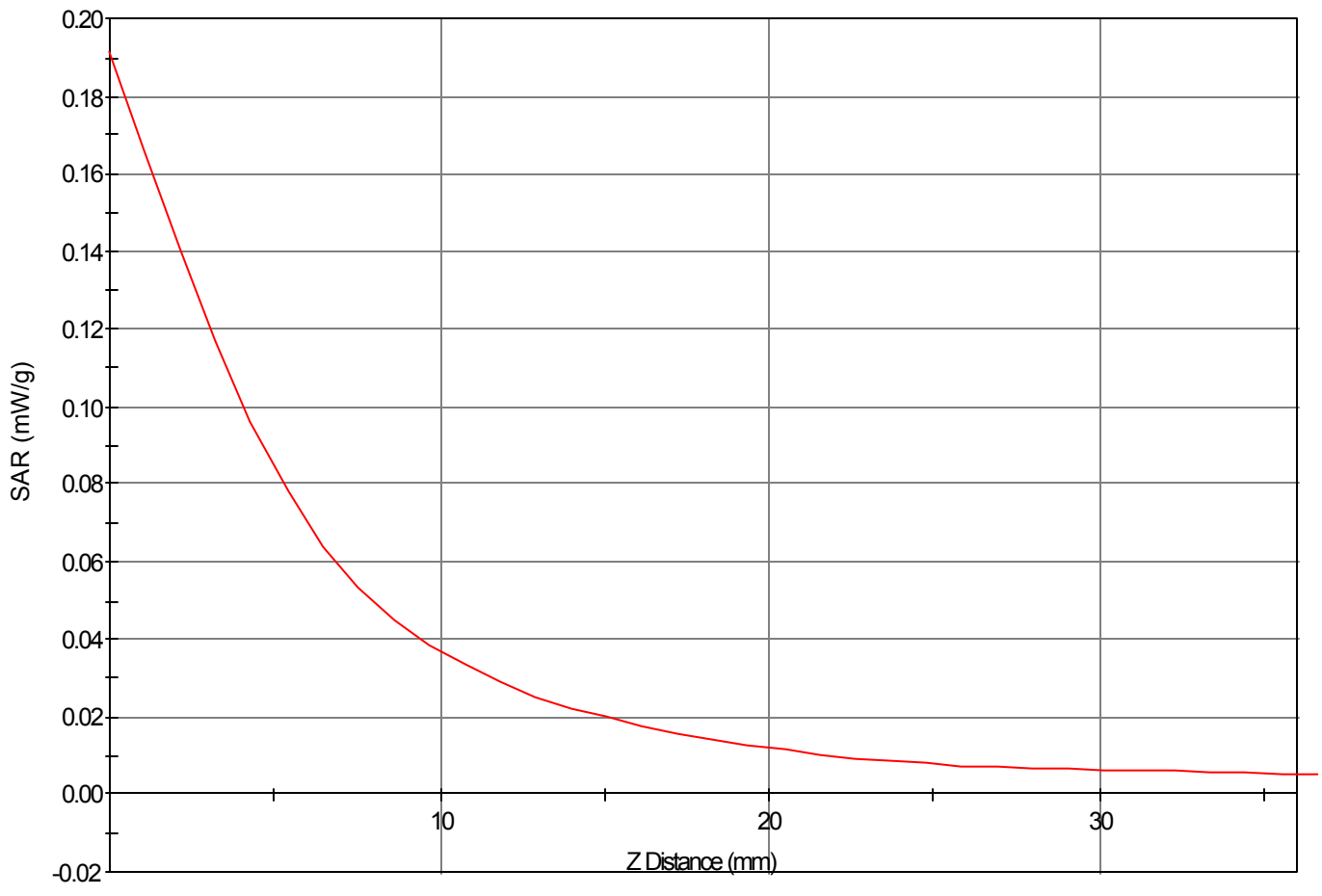

1g SAR Values

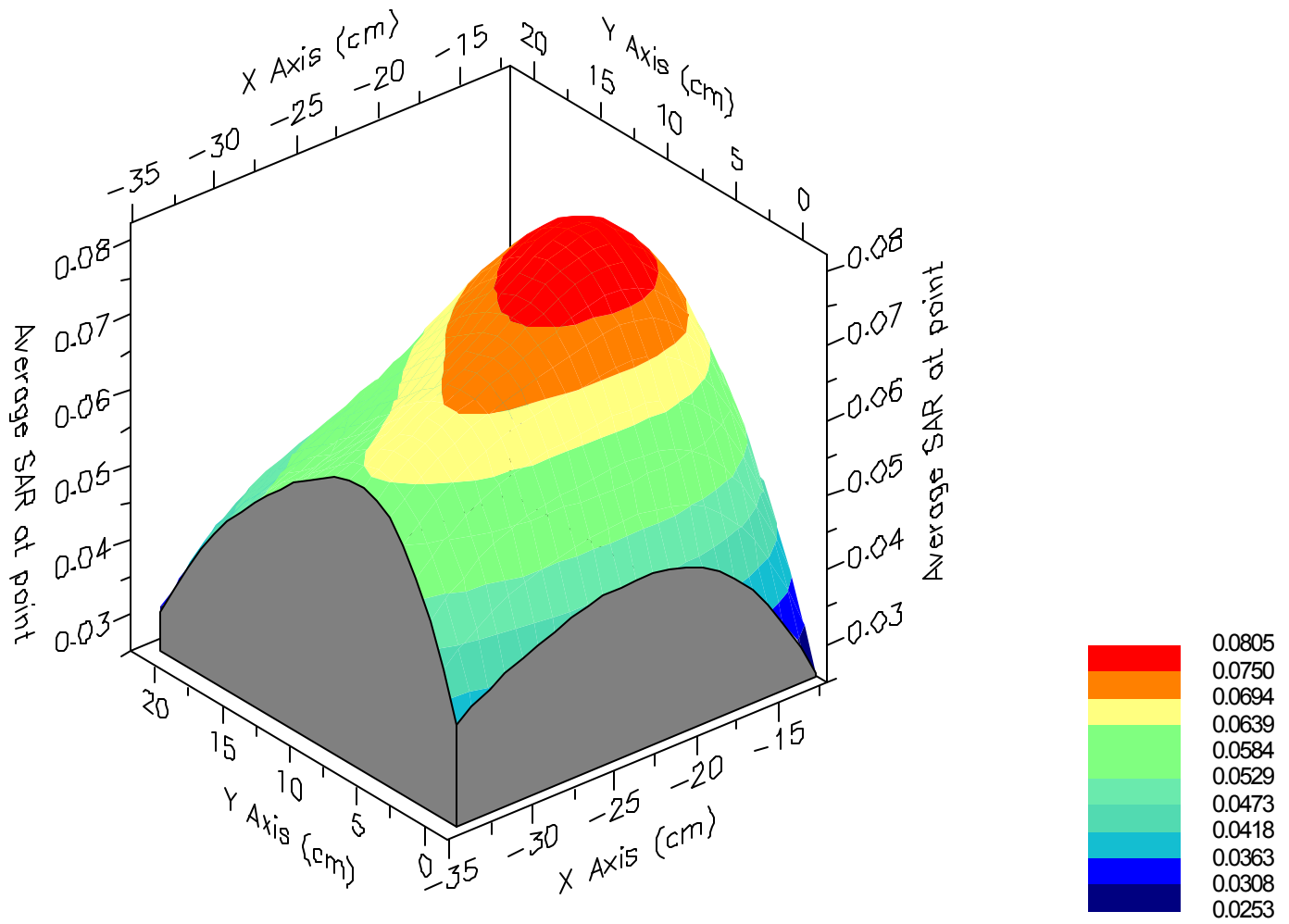

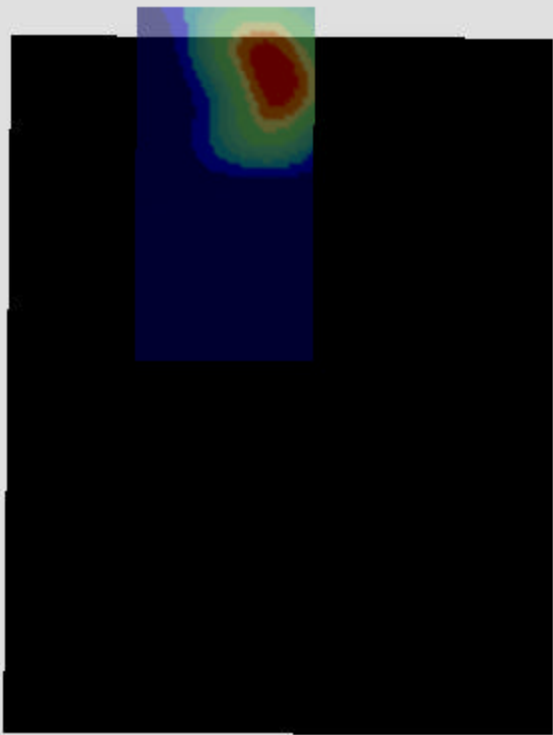

SAR Data Report 03031128

Start : 11-Mar-03 02:58:20 pm
End : 11-Mar-03 03:24:20 pm
Code Version : 4.08
Robot Version: 4.08

Product Data:

Type : SYMBOL
Model Number : MK2046-1311-WW
Serial Number : ALP53326
Frequency : 2462 MHz
Transmit Pwr : 0.135 W
Antenna Type : Helical
Antenna Posn. : Internal

Measurement Data:

Phantom Name : SAM-FLAT-B
Phantom Type : Uniphantom
Tissue Type : Muscle
Tissue Dielectric : 51.000
Tissue Conductivity : 1.980
Tissue Density : 1.000
Robot Name : CRS

Probe Data:

Probe Name : PCT003
Probe Type : E Fld Triangle
Frequency : 2450 MHz
Tissue Type : Muscle
Calibrated Dielectric : 52.300
Calibrated Conductivity : 1.990
Calibrated Density : 1.000
Probe Offset : 2.400 mm
Conversion Factor : 9.900
Probe Sensitivity : 2.075 2.820 2.456 mV/(mW/cm^2)
Amplifier Gains : 20.00 20.00 20.00

Sample:

Rate: 6000 Samples/Sec
Count: 1000 Samples
NIDAQ Gain: 5

Comments:

DSS Mode CH-11
BODY
CF=1; Amb. Temp= 22.3 'C; Liq. Temp=21.1 'C

Zoom Scan - Max Peak SAR Value at x=10.0 y=-5.0 z=0.0 = 0.58 W/kg

Max 1g SAR at x=10.0 y=-5.0 z=0.0 = 0.27 W/kg

Max 10g SAR at x=9.0 y=-5.0 z=0.0 = 0.13 W/kg

SAR - Z Axis
at Hotspot x:10.0 y:-5.0

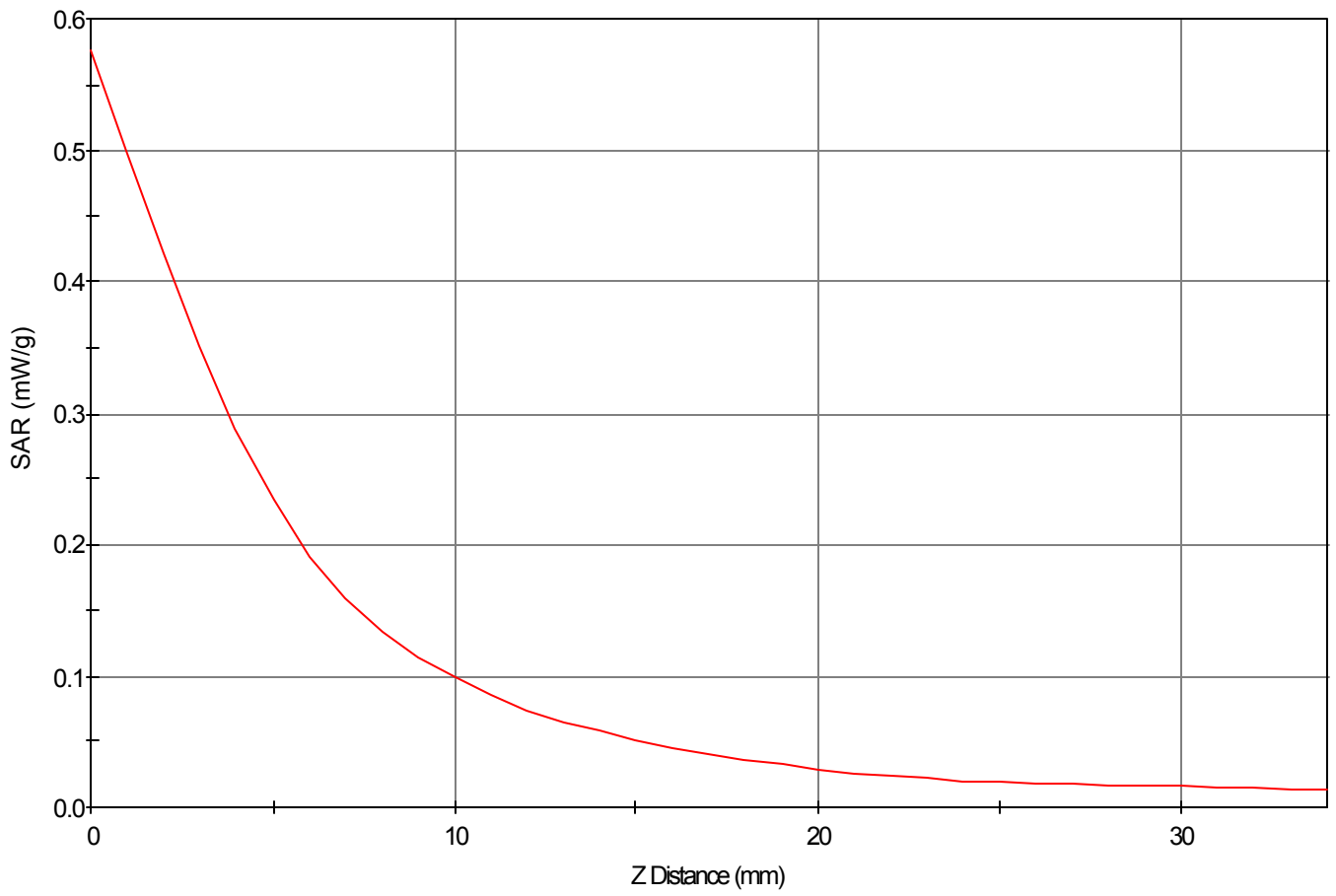

1g SAR Values

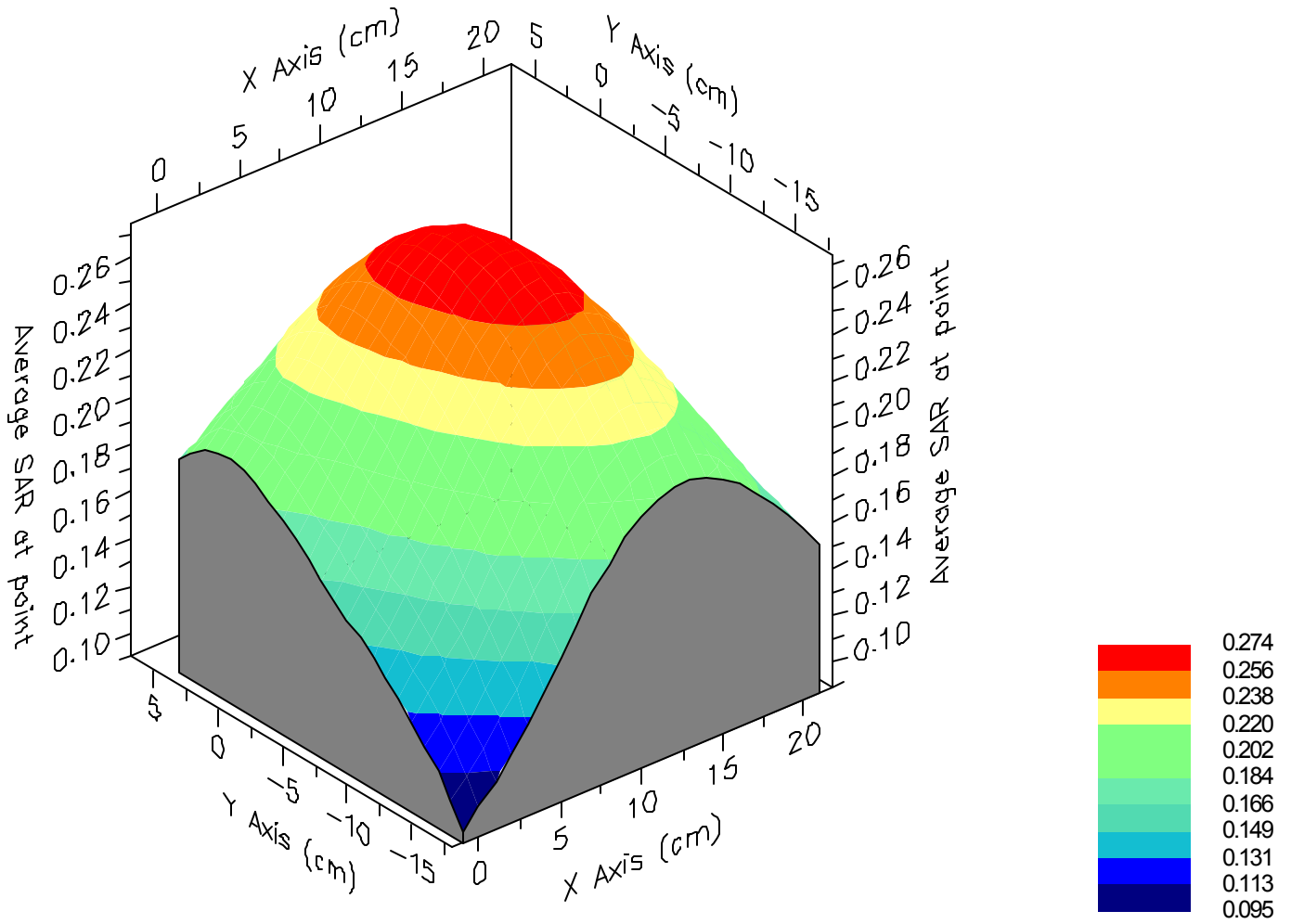

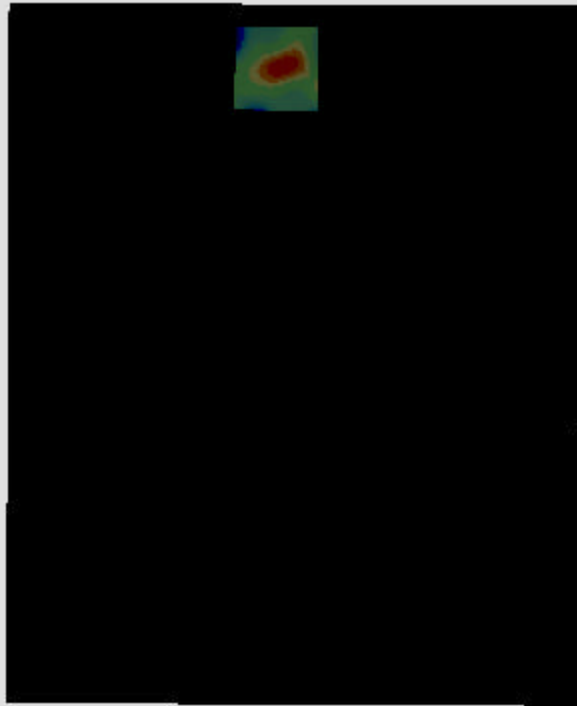

APPENDIX B: DIPOLE VALIDATION

SAR Data Report 03031103

Start : 11-Mar-03 09:14:31 am
End : 11-Mar-03 09:19:43 am
Code Version : 4.08
Robot Version: 4.08

Product Data:

Type : Validation
Frequency : 2450 MHz
Transmit Pwr : 0.050 W
Antenna Type : Dipole

Measurement Data:

Phantom Name : SAM-FLAT-B
Phantom Type : Uniphantom
Tissue Type : Brain
Tissue Dielectric : 39.50
Tissue Conductivity : 1.810
Tissue Density : 1.000
Robot Name : CRS

Probe Data:

Probe Name : PCT003
Probe Type : E Fld Triangle
Frequency : 2450 MHz
Tissue Type : Brain
Calibrated Dielectric : 39.340
Calibrated Conductivity : 1.770
Calibrated Density : 1.300
Probe Offset : 2.400 mm
Conversion Factor : 8.800
Probe Sensitivity : 2.075 2.820 2.456 mV/(mW/cm^2)
Amplifier Gains : 20.00 20.00 20.00

Sample:

Rate: 6000 Samples/Sec
Count: 1000 Samples
NIDAQ Gain: 5

Comments:

2450 MHz Validation

CF=1; Amb. Temp= 22.3 'C; Liq. Temp=21.0 'C

Area Scan - Max Peak SAR Value at x=-4.0 y=0.0 = 2.21 W/kg

Zoom Scan - Max Peak SAR Value at x=-4.0 y=0.0 z=0.0 = 5.58 W/kg

Max 1g SAR at x=-3.0 y=1.0 z=0.0 = 2.54 W/kg

Max 10g SAR at x=-3.0 y=1.0 z=0.0 = 1.05 W/kg

Validation Results at 0.05 W:

1g Nominal = 2.6, Error: -2.94 %

SAR - Z Axis
at Hotspot x:-4.0 y:0.0

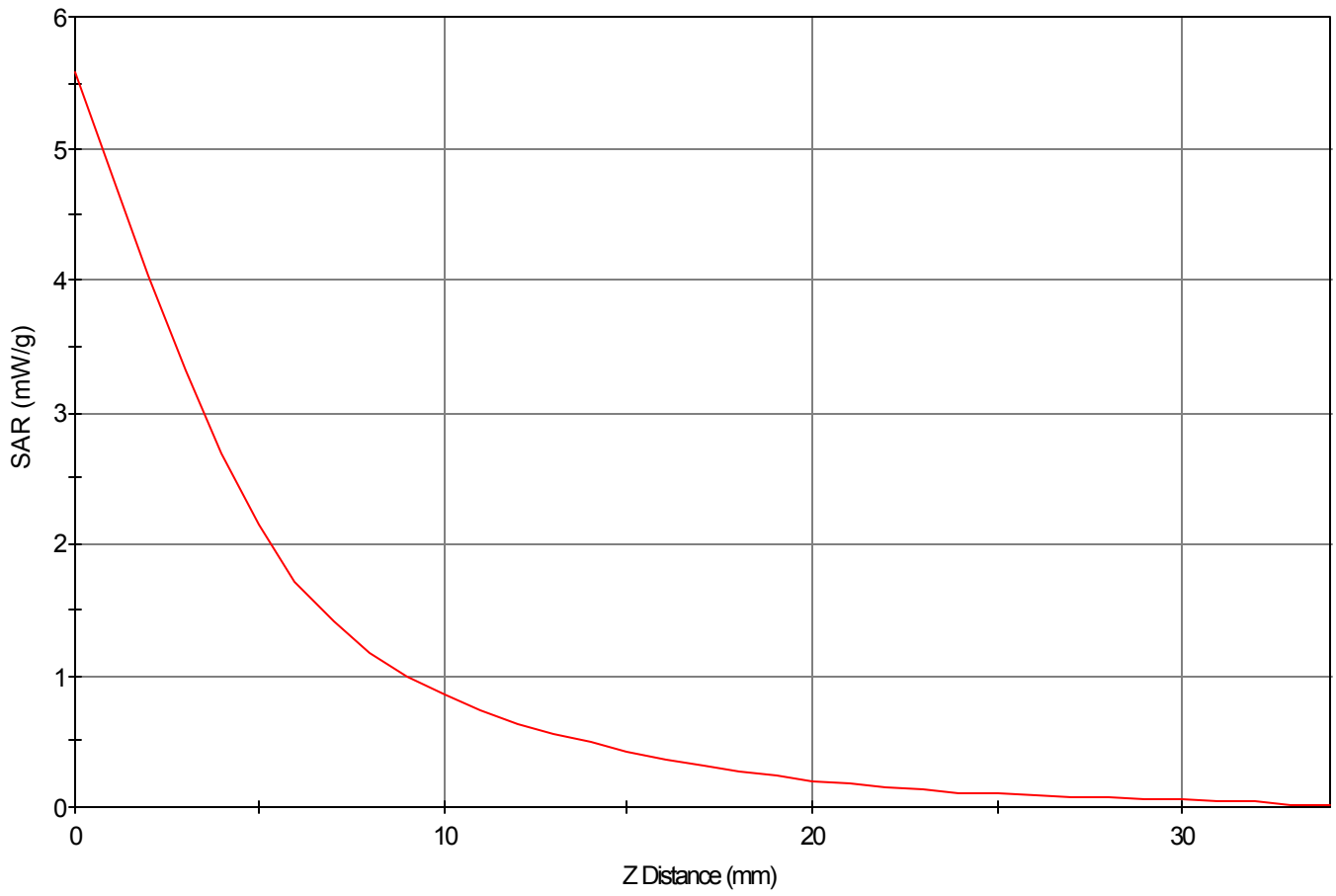

1g SAR Values

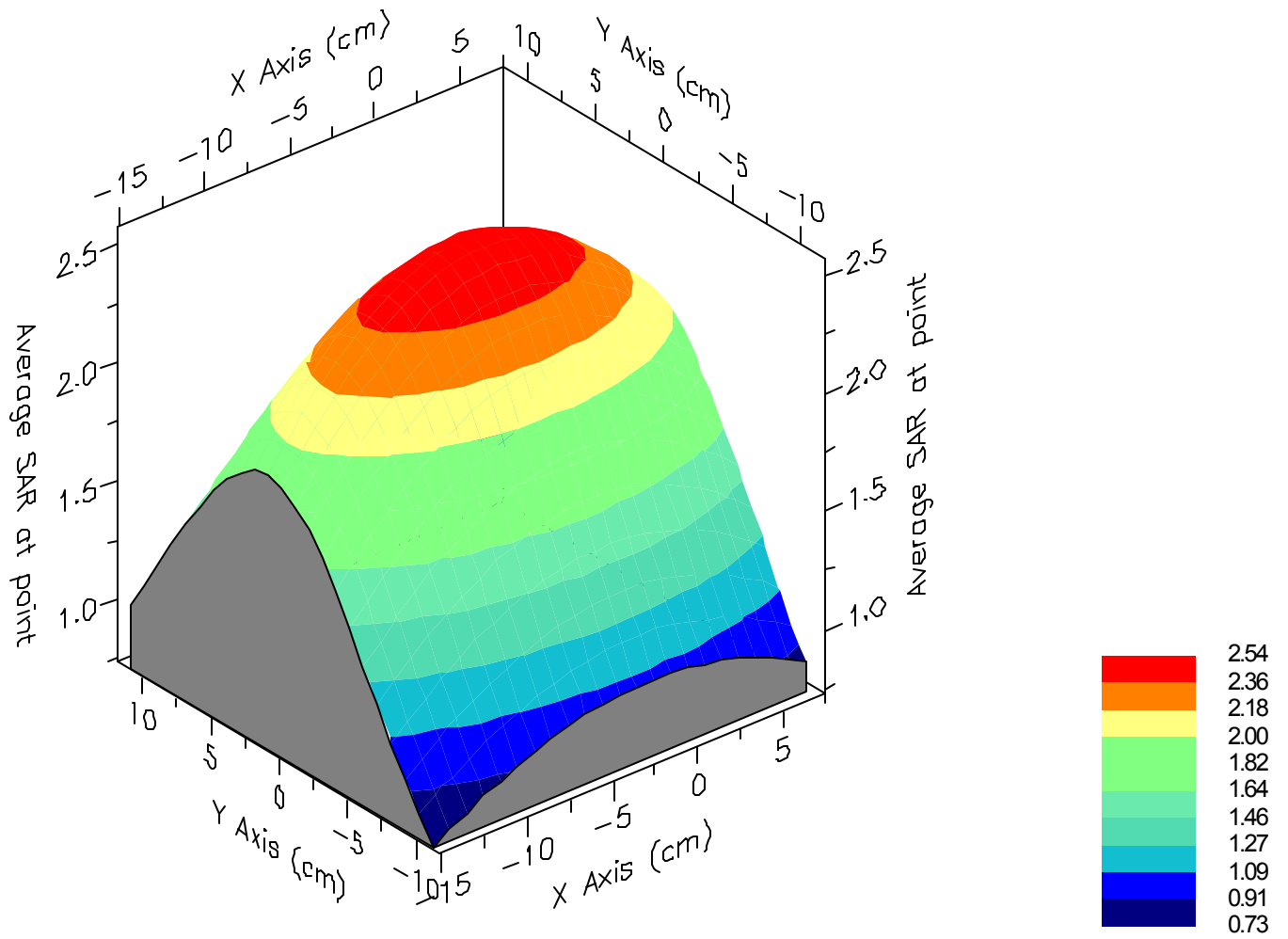

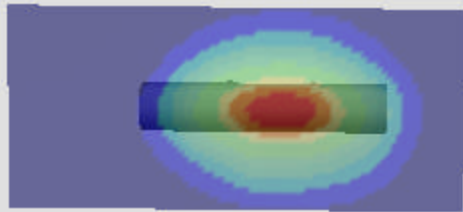

APPENDIX C: PROBE CALIBRATION

Probe E-010

SN: PCT003

Manufactured:
Calibrated:

November 4, 2002
January 3, 2003

Calibrated for the IDX System

PCTEST Calibration Laboratory

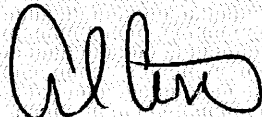
Approved By: 
Alfred Cirwithian
Vice President Engineering

Calibration is performed according to IEEE Std. P1528-200X, Sec. 7 Draft 6.5 (2001)
and all test equipment used are traceable to U.S. NIST.



Calibration Laboratory

6660-B Dobbin Road
Columbia, Maryland 21045 USA

Calibration Summary

Model: E-010

S/N: PCT003

OFFSET (cm)	ANGLE (deg)
0.24	54.73

Tissue Type	Frequency (MHz)	Dielectric Constant ϵ_r	Conductivity (S/m) σ	Conversion Factor $\gamma_x, \gamma_y, \gamma_z$
Brain	835	40.00	0.91	7.20
Brain	1880	40.20	1.41	4.05
Brain	2450	39.34	1.77	8.80
Brain	5300	37.10	4.84	3.20
Brain	5800	36.00	5.28	2.30
Muscle	835	55.70	0.98	7.70
Muscle	1900	53.90	1.48	4.40
Muscle	2450	52.30	1.99	9.90
Muscle	5300	48.80	5.43	3.45
Muscle	5800	48.50	6.05	2.50

Frequency (MHz)	Isotropy	
	%	dB
835	3.49	0.15
1880	5.35	0.23
2450	4.02	0.17
5300	4.85	0.21
5800	4.93	0.21

Boundary Effect < 2%, 2.6 mm from probe tip to phantom

Diode Compression Point: 76 mV

Environmental Conditions:

Temperature: 23.34 °C

Relative Humidity: 34%

Barometer: 100.1 kPa

This probe was calibrated under the IEEE Std 1309-1966, *IEEE Standard for Calibration of Electromagnetic Field Sensors and Probes, Excluding Antennas, from 9 kHz to 40 GHz.*

CALIBRATED BY: SA

DATE: 01/15/03

Calibration Laboratory

6660-B Dobbin Road
Columbia, Maryland 21045 USA

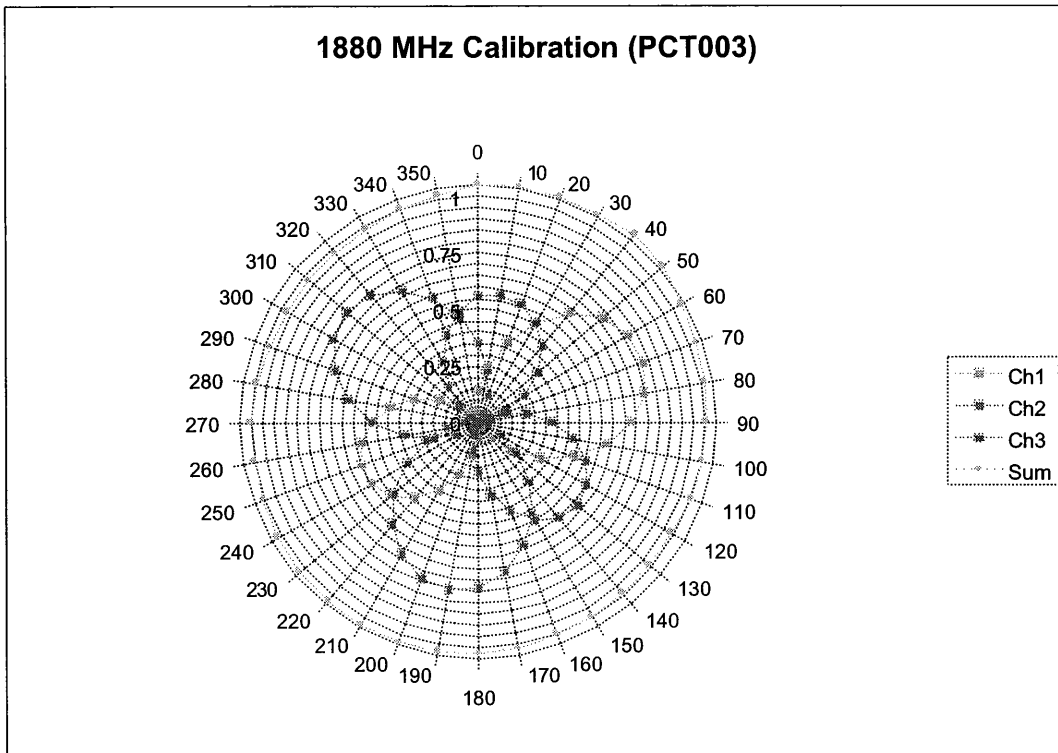

CALIBRATED BY: SA

DATE: 01/15/03

Calibration Laboratory

6660-B Dobbin Road
Columbia, Maryland 21045 USA

2440 MHz Calibration (PCT003)

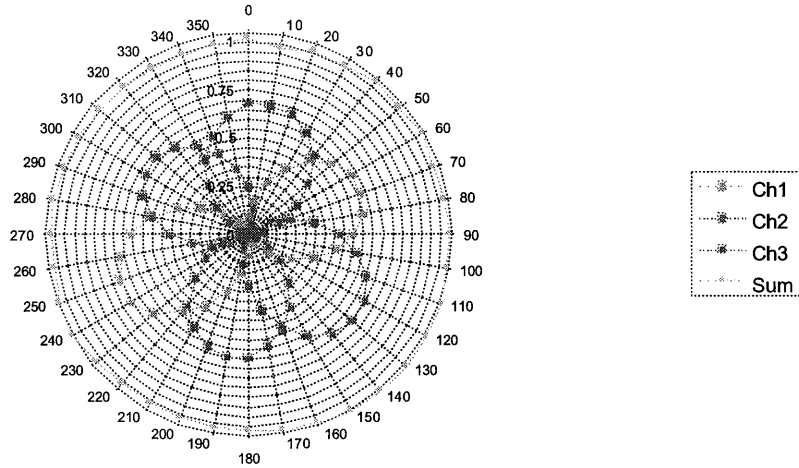

5300 MHz Calibration (PCT003)

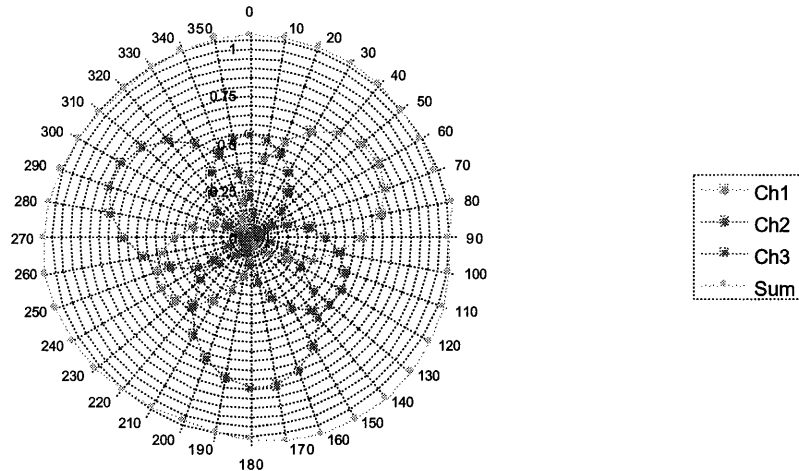

CALIBRATED BY: SA

DATE: 01/15/03

Calibration Laboratory

6660-B Dobbin Road
Columbia, Maryland 21045 USA

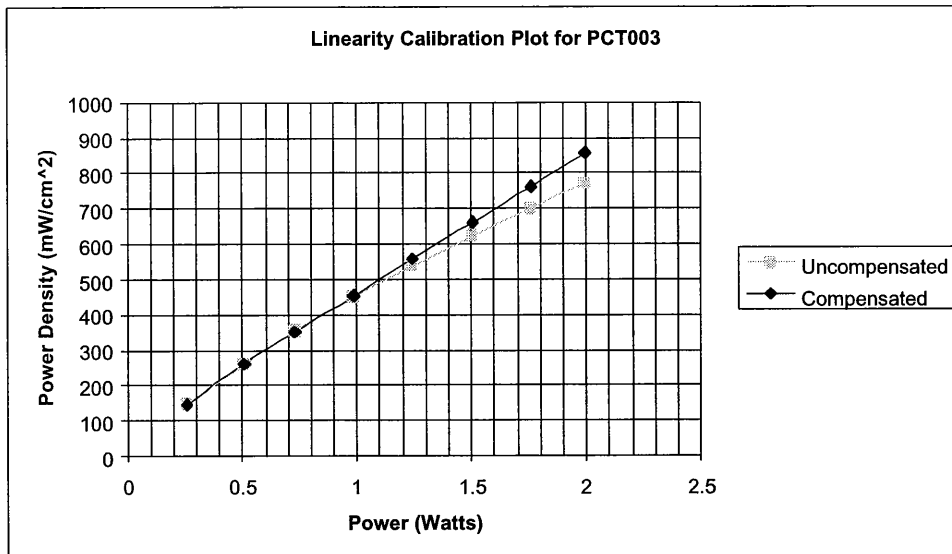

Probe Physical Characteristics

Serial Number:	PCT003
Sensor Offset:	2.4 mm
Sensor Length:	2.5 mm
Tip Enclosure:	Glass
Tip Diameter:	7 mm
Tip Length:	40 mm
Total Length:	290 mm

CALIBRATED BY: SA

DATE: 01/15/03



Calibration Laboratory

6660-B Dobbin Road
Columbia, Maryland 21045 USA

Test Equipment

The test equipment used during the probe calibration are listed as follows:

EQUIPMENT SPECIFICATIONS		
Type	Calibration Date	Asset Number/ Serial Number
CRS Robot F3	February 2002	RAF0134133
CRS C500C Motion Controller	February 2002	RCB0003303
CRS Teach Pendant (Joystick)	February 2002	STP0132231
DELL Computer, Pentium 4 1.6 GHz, Windows 2000™	February 2002	4PJZ111
E-Field Probe E-010	January 2003	PCT003
Flat SAM Phantom (P-SAM-FLAT)	February 2002	94X-097
IDX Robot End Effector (EE-103-C)	February 2002	07111223
IDX Probe Amplifier	February 2002	07111113
Validation Dipole D-835S	October 2002	PCT441
Validation Dipole D-1900S	October 2002	PCT541
Validation Dipole D-2450S	October 2002	PCT641
Validation Dipole D-5000S	November 2002	PCT741
HP-778D Dual-Directional Coupler (0.1 ~ 2.0 GHz)	November 2002	PCT664
MicroCircuits Directional Coupler (4.0 ~ 8.0 GHz)	November 2002	PE2204-6
Amplifier Research 5S1G4 Power Amp	January 2003	PCT540
IFI T184-10 Power Amplifier (4.0 ~ 18.0 GHz)	December 2002	5957
Agilent E8241A (250kHz ~ 20GHz) Signal Generator	November 2002	US42110432
HP-8648D (9kHz ~ 4 GHz) Signal Generator	January 2003	PCT526
HP-8753E (30kHz ~ 6GHz) Network Analyzer	January 2003	PCT552
HP85070B Dielectric Probe Kit	January 2003	PCT501
IFI CC110EXX TEM Cell (DC to 2000 MHz)	January 2003	PCT498
EMCO 3115 Horn Antenna (2.0 ~ 18.0 GHz)	August 2002	PCT496
Guidline 5150 Precision Dual-Thermometer	November 2002	66145

CALIBRATED BY: SA

DATE: 01/15/03



Calibration Laboratory

6660-B Dobbin Road
Columbia, Maryland 21045 USA

TEM Calibration Plot
Date: 3-Jan-03 05:19:17 pm
Probe Name: PCT003
Frequency: 835

Sensitivity: Ch1: 2.439 Ch2: 2.706 Ch3: 2.822 mV/(mW/cm²)
isotropicity: 3.49% 0.15 db Min=0.981 Max=1.051

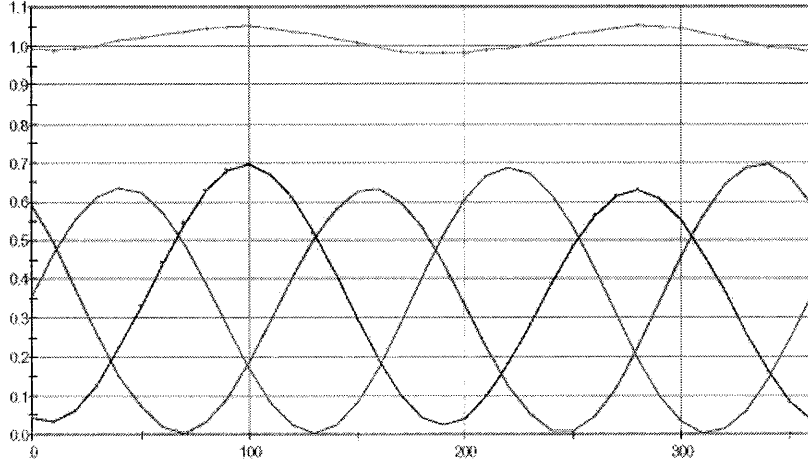

TEM Calibration Plot
Date: 3-Jan-03 05:52:39 pm
Probe Name: PCT003
Frequency: 1880

Sensitivity: Ch1: 4.794 Ch2: 5.895 Ch3: 5.327 mV/(mW/cm²)
isotropicity: 5.35% 0.23 db Min=0.971 Max=1.078

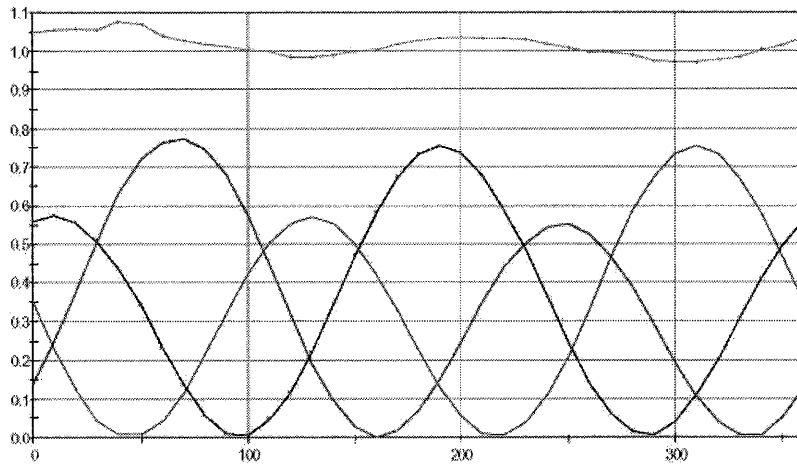

CALIBRATED BY: SA DATE: 01/15/03



Calibration Laboratory

6660-B Dobbin Road
Columbia, Maryland 21045 USA

TEM Calibration Plot
Date: 3-Jan-02 12:06:18 pm
Probe Name: PCT003
Frequency: 5800
Sensitivity: Ch1: 0.6759 Ch2: 0.8082 Ch3: 0.7596 mV/(mW/cm²)
Isotropy: 4.93% 0.21 db Min=0.973 Max=1.082

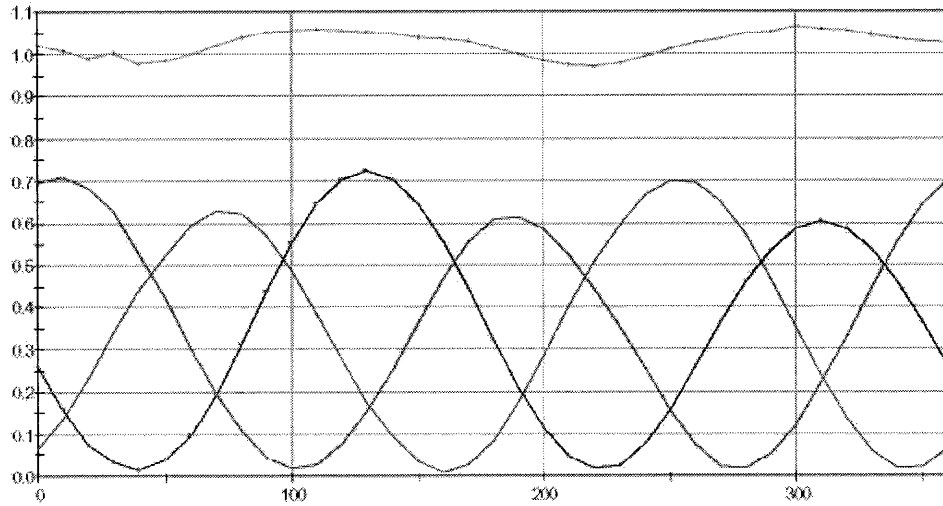

CALIBRATED BY: SA

DATE: 01/15/03