



Calibration Certificate of DASY

Calibration Laboratory of
Schmid & Partner
Engineering AG
 Zeughausstrasse 43, 8004 Zurich, Switzerland



S Schweizerischer Kalibrierdienst
C Service suisse d'étalonnage
S Servizio svizzero di taratura
S Swiss Calibration Service

Accredited by the Swiss Accreditation Service (SAS)
 The Swiss Accreditation Service is one of the signatories to the EA
 Multilateral Agreement for the recognition of calibration certificates

Accreditation No.: **SCS 108**

Client **Sporton (Auden)**

Certificate No: **D835V2-499_Mar08**

CALIBRATION CERTIFICATE

Object **D835V2 - SN: 499**

Calibration procedure(s) **QA CAL-05.v7
 Calibration procedure for dipole validation kits**

Calibration date: **March 17, 2008**

Condition of the calibrated item **In Tolerance**

This calibration certificate documents the traceability to national standards, which realize the physical units of measurements (SI).
 The measurements and the uncertainties with confidence probability are given on the following pages and are part of the certificate.

All calibrations have been conducted in the closed laboratory facility: environment temperature (22 ± 3)°C and humidity < 70%.

Calibration Equipment used (M&TE critical for calibration)

| Primary Standards | ID # | Cal Date (Calibrated by, Certificate No.) | Scheduled Calibration |
|----------------------------|----------------|---|-----------------------|
| Power meter EPM-442A | GB37480704 | 04-Oct-07 (METAS, No. 217-00736) | Oct-08 |
| Power sensor HP 8481A | US37292783 | 04-Oct-07 (METAS, No. 217-00736) | Oct-08 |
| Reference 20 dB Attenuator | SN: 5086 (20g) | 07-Aug-07 (METAS, No 217-00718) | Aug-08 |
| Reference Probe ES3DV2 | SN: 3025 | 01-Mar-08 (SPEAG, No. ES3-3025_Mar08) | Mar-09 |
| DAE4 | SN 909 | 03-Sep-07 (SPEAG, No. DAE4-909_Sep07) | Sep-08 |

| Secondary Standards | ID # | Check Date (in house) | Scheduled Check |
|---------------------------|------------------|--|------------------------|
| Power sensor HP 8481A | MY41092317 | 18-Oct-02 (SPEAG, in house check Oct-07) | In house check: Oct-09 |
| RF generator R&S SMT-06 | 100005 | 04-Aug-99 (SPEAG, in house check Oct-07) | In house check: Oct-09 |
| Network Analyzer HP 8753E | US37390585 S4206 | 18-Oct-01 (SPEAG, in house check Oct-07) | In house check: Oct-08 |

| | Name | Function | Signature |
|----------------|-----------------|-----------------------|-----------|
| Calibrated by: | Claudio Leubler | Laboratory Technician | |
| Approved by: | Katja Pokovic | Technical Manager | |

Issued: March 17, 2008

This calibration certificate shall not be reproduced except in full without written approval of the laboratory.



**Calibration Laboratory of
Schmid & Partner
Engineering AG**
Zeughausstrasse 43, 8004 Zurich, Switzerland



S Schweizerischer Kalibrierdienst
C Service suisse d'étalonnage
S Servizio svizzero di taratura
S Swiss Calibration Service

Accredited by the Swiss Accreditation Service (SAS)
The Swiss Accreditation Service is one of the signatories to the EA
Multilateral Agreement for the recognition of calibration certificates

Accreditation No.: **SCS 108**

Glossary:

TSL tissue simulating liquid
ConvF sensitivity in TSL / NORM x,y,z
N/A not applicable or not measured

Calibration is Performed According to the Following Standards:

- a) IEEE Std 1528-2003, "IEEE Recommended Practice for Determining the Peak Spatial-Averaged Specific Absorption Rate (SAR) in the Human Head from Wireless Communications Devices: Measurement Techniques", December 2003
- b) IEC 62209-1, "Procedure to measure the Specific Absorption Rate (SAR) for hand-held devices used in close proximity to the ear (frequency range of 300 MHz to 3 GHz)", February 2005
- c) Federal Communications Commission Office of Engineering & Technology (FCC OET), "Evaluating Compliance with FCC Guidelines for Human Exposure to Radiofrequency Electromagnetic Fields; Additional Information for Evaluating Compliance of Mobile and Portable Devices with FCC Limits for Human Exposure to Radiofrequency Emissions", Supplement C (Edition 01-01) to Bulletin 65

Additional Documentation:

- d) DASY4 System Handbook

Methods Applied and Interpretation of Parameters:

- *Measurement Conditions:* Further details are available from the Validation Report at the end of the certificate. All figures stated in the certificate are valid at the frequency indicated.
- *Antenna Parameters with TSL:* The dipole is mounted with the spacer to position its feed point exactly below the center marking of the flat phantom section, with the arms oriented parallel to the body axis.
- *Feed Point Impedance and Return Loss:* These parameters are measured with the dipole positioned under the liquid filled phantom. The impedance stated is transformed from the measurement at the SMA connector to the feed point. The Return Loss ensures low reflected power. No uncertainty required.
- *Electrical Delay:* One-way delay between the SMA connector and the antenna feed point. No uncertainty required.
- *SAR measured:* SAR measured at the stated antenna input power.
- *SAR normalized:* SAR as measured, normalized to an input power of 1 W at the antenna connector.
- *SAR for nominal TSL parameters:* The measured TSL parameters are used to calculate the nominal SAR result.



Measurement Conditions

DASY system configuration, as far as not given on page 1.

| | | |
|------------------------------|---------------------------|-------------|
| DASY Version | DASY4 | V4.7 |
| Extrapolation | Advanced Extrapolation | |
| Phantom | Modular Flat Phantom V4.9 | |
| Distance Dipole Center - TSL | 15 mm | with Spacer |
| Zoom Scan Resolution | dx, dy, dz = 5 mm | |
| Frequency | 835 MHz ± 1 MHz | |

Head TSL parameters

The following parameters and calculations were applied.

| | Temperature | Permittivity | Conductivity |
|----------------------------------|-----------------|--------------|------------------|
| Nominal Head TSL parameters | 22.0 °C | 41.5 | 0.90 mho/m |
| Measured Head TSL parameters | (22.0 ± 0.2) °C | 41.5 ± 6 % | 0.90 mho/m ± 6 % |
| Head TSL temperature during test | (22.0 ± 0.2) °C | ---- | ---- |

SAR result with Head TSL

| SAR averaged over 1 cm ³ (1 g) of Head TSL | Condition | |
|---|--------------------|-----------------------------------|
| SAR measured | 250 mW input power | 2.29 mW / g |
| SAR normalized | normalized to 1W | 9.16 mW / g |
| SAR for nominal Head TSL parameters ¹ | normalized to 1W | 9.16 mW / g ± 17.0 % (k=2) |

| SAR averaged over 10 cm ³ (10 g) of Head TSL | condition | |
|---|--------------------|-----------------------------------|
| SAR measured | 250 mW input power | 1.50 mW / g |
| SAR normalized | normalized to 1W | 6.00 mW / g |
| SAR for nominal Head TSL parameters ¹ | normalized to 1W | 6.00 mW / g ± 16.5 % (k=2) |

¹ Correction to nominal TSL parameters according to d), chapter "SAR Sensitivities"



Body TSL parameters

The following parameters and calculations were applied.

| | Temperature | Permittivity | Conductivity |
|----------------------------------|-----------------|--------------|------------------|
| Nominal Body TSL parameters | 22.0 °C | 55.2 | 0.97 mho/m |
| Measured Body TSL parameters | (22.0 ± 0.2) °C | 54.0 ± 6 % | 1.00 mho/m ± 6 % |
| Body TSL temperature during test | (22.0 ± 0.2) °C | --- | --- |

SAR result with Body TSL

| SAR averaged over 1 cm ³ (1 g) of Body TSL | Condition | |
|---|--------------------|-----------------------------------|
| SAR measured | 250 mW input power | 2.46 mW / g |
| SAR normalized | normalized to 1W | 9.84 mW / g |
| SAR for nominal Body TSL parameters ² | normalized to 1W | 9.52 mW / g ± 17.0 % (k=2) |

| SAR averaged over 10 cm ³ (10 g) of Body TSL | condition | |
|---|--------------------|-----------------------------------|
| SAR measured | 250 mW input power | 1.63 mW / g |
| SAR normalized | normalized to 1W | 6.52 mW / g |
| SAR for nominal Body TSL parameters ² | normalized to 1W | 6.37 mW / g ± 16.5 % (k=2) |

² Correction to nominal TSL parameters according to d), chapter "SAR Sensitivities"



Appendix

Antenna Parameters with Head TSL

| | |
|--------------------------------------|--------------------------------|
| Impedance, transformed to feed point | 52.9 Ω - 2.3 j Ω |
| Return Loss | - 28.9 dB |

Antenna Parameters with Body TSL

| | |
|--------------------------------------|--------------------------------|
| Impedance, transformed to feed point | 49.2 Ω - 3.3 j Ω |
| Return Loss | - 29.3 dB |

General Antenna Parameters and Design

| | |
|----------------------------------|----------|
| Electrical Delay (one direction) | 1.392 ns |
|----------------------------------|----------|

After long term use with 100W radiated power, only a slight warming of the dipole near the feedpoint can be measured.

The dipole is made of standard semirigid coaxial cable. The center conductor of the feeding line is directly connected to the second arm of the dipole. The antenna is therefore short-circuited for DC-signals.

No excessive force must be applied to the dipole arms, because they might bend or the soldered connections near the feedpoint may be damaged.

Additional EUT Data

| | |
|-----------------|---------------|
| Manufactured by | SPEAG |
| Manufactured on | July 10, 2003 |

DASY4 Validation Report for Head TSL

Date/Time: 17.03.2008 11:32:45

Test Laboratory: SPEAG, Zurich, Switzerland

DUT: Dipole 835 MHz; Type: D835V2; Serial: D835V2 - SN:499

Communication System: CW-835; Frequency: 835 MHz; Duty Cycle: 1:1

Medium: HSL 900 MHz;

Medium parameters used: $f = 835 \text{ MHz}$; $\sigma = 0.9 \text{ mho/m}$; $\epsilon_r = 41.5$; $\rho = 1000 \text{ kg/m}^3$

Phantom section: Flat Section

Measurement Standard: DASY4 (High Precision Assessment)

DASY4 Configuration:

- Probe: ES3DV2 - SN3025; ConvF(6.09, 6.09, 6.09); Calibrated: 01.03.2008
- Sensor-Surface: 3.4mm (Mechanical Surface Detection)
- Electronics: DAE4 Sn909; Calibrated: 03.09.2007
- Phantom: Flat Phantom 4.9L; Type: QD000P49AA; ;
- Measurement SW: DASY4, V4.7 Build 55; Postprocessing SW: SEMCAD, V1.8 Build 172

Unnamed procedure/Zoom Scan (7x7x7)/Cube 0:

Measurement grid: $dx=5\text{mm}$, $dy=5\text{mm}$, $dz=5\text{mm}$

Reference Value = 54.9 V/m; Power Drift = -0.005 dB

Peak SAR (extrapolated) = 3.34 W/kg

SAR(1 g) = 2.29 mW/g; SAR(10 g) = 1.5 mW/g

Maximum value of SAR (measured) = 2.58 mW/g

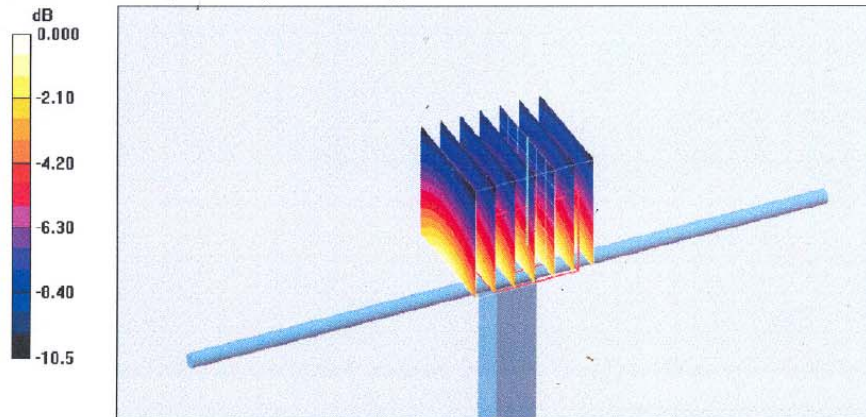

0 dB = 2.58mW/g



Impedance Measurement Plot for Head TSL

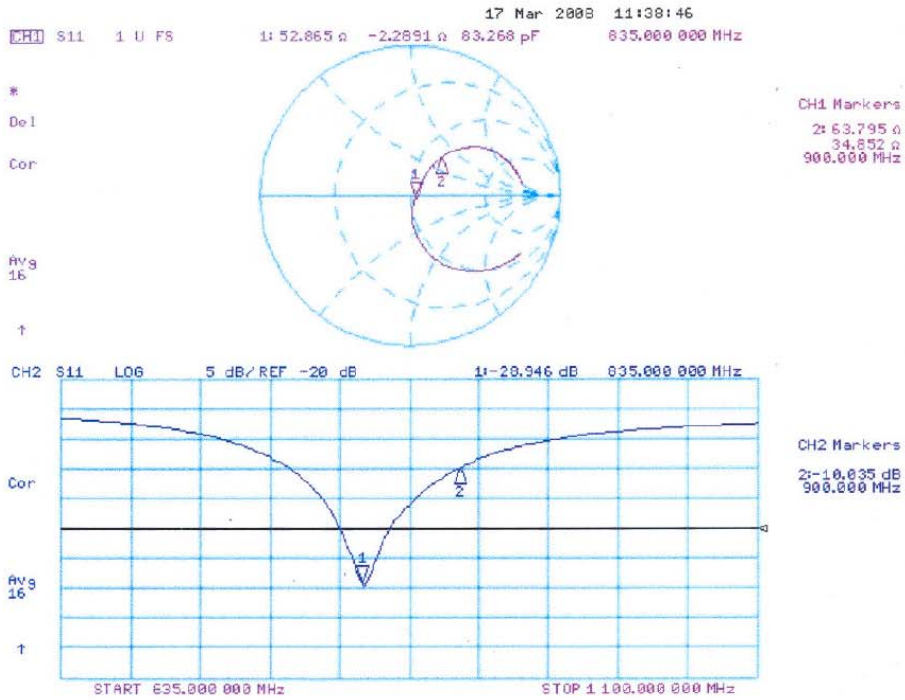

DASY4 Validation Report for Body TSL

Date/Time: 10.03.2008 12:48:36

Test Laboratory: SPEAG, Zurich, Switzerland

DUT: Dipole 835 MHz; Type: D835V2; Serial: D835V2 - SN:499

Communication System: CW; Frequency: 835 MHz; Duty Cycle: 1:1

Medium: MSL900;

Medium parameters used: $f = 835$ MHz; $\sigma = 1$ mho/m; $\epsilon_r = 54$; $\rho = 1000$ kg/m³

Phantom section: Flat Section

Measurement Standard: DASY4 (High Precision Assessment)

DASY4 Configuration:

- Probe: ES3DV2 - SN3025; ConvF(5.85, 5.85, 5.85); Calibrated: 01.03.2008
- Sensor-Surface: 4mm (Mechanical Surface Detection)
- Electronics: DAE4 Sn909; Calibrated: 03.09.2007
- Phantom: Flat Phantom 4.9L; Type: QD000P49AA; ;
- Measurement SW: DASY4, V4.7 Build 55; Postprocessing SW: SEMCAD, V1.8 Build 172

Pin = 250mW, d = 15mm/Zoom Scan (7x7x7)/Cube 0:

Measurement grid: dx=5mm, dy=5mm, dz=5mm

Reference Value = 51.8 V/m; Power Drift = 0.036 dB

Peak SAR (extrapolated) = 3.59 W/kg

SAR(1 g) = 2.46 mW/g; SAR(10 g) = 1.63 mW/g

Maximum value of SAR (measured) = 2.64 mW/g

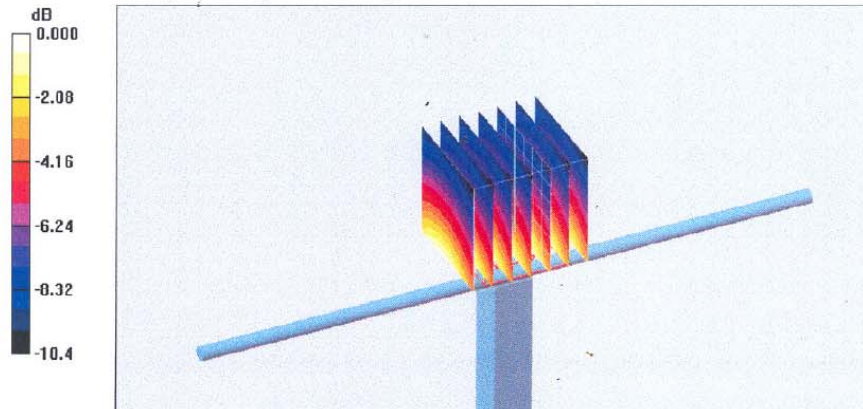

0 dB = 2.64mW/g



Impedance Measurement Plot for Body TSL

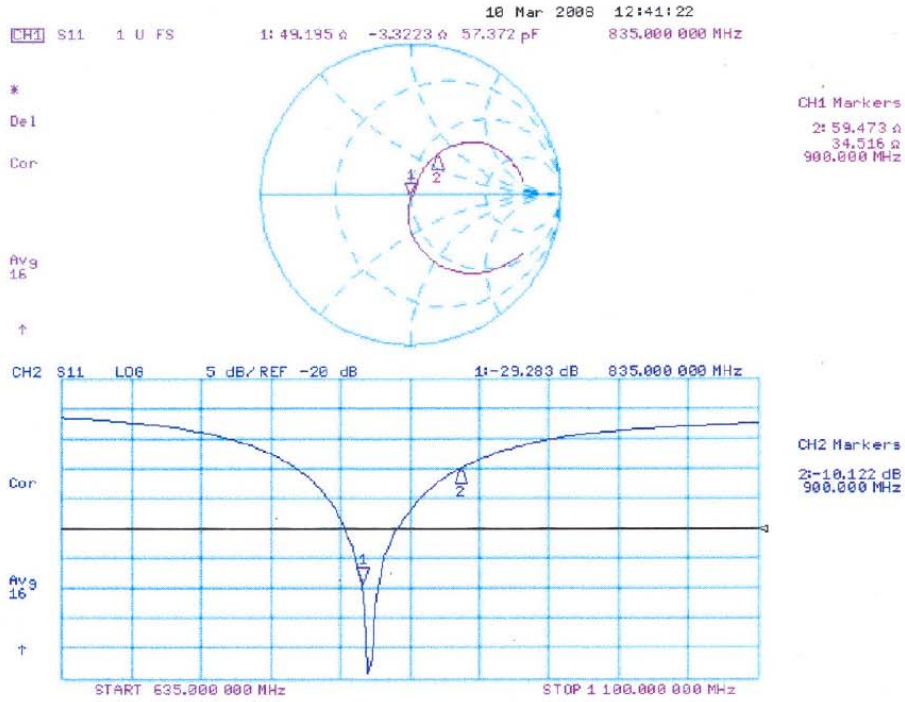



Calibration Laboratory of Schmid & Partner Engineering AG, Zeughausstrasse 43, 8004 Zurich, Switzerland



S Schweizerischer Kalibrierdienst, Service suisse d'étalonnage, Servizio svizzero di taratura, Swiss Calibration Service

Accredited by the Swiss Federal Office of Metrology and Accreditation. The Swiss Accreditation Service is one of the signatories to the EA Multilateral Agreement for the recognition of calibration certificates

Accreditation No.: SCS 108

Client: Sporton (Auden)

Certificate No: D1900V2-5d041_Mar08

CALIBRATION CERTIFICATE

Object: D1900V2 - SN: 5d041
Calibration procedure(s): QA CAL-05.v7 Calibration procedure for dipole validation kits
Calibration date: March 18, 2008
Condition of the calibrated item: In Tolerance

This calibration certificate documents the traceability to national standards, which realize the physical units of measurements (SI). The measurements and the uncertainties with confidence probability are given on the following pages and are part of the certificate.

All calibrations have been conducted in the closed laboratory facility; environment temperature (22 ± 3)°C and humidity < 70%.

Calibration Equipment used (M&TE critical for calibration)

Table with 4 columns: Primary Standards, ID #, Cal Date (Calibrated by, Certificate No.), Scheduled Calibration. Includes items like Power meter EPM-442A, Power sensor HP 8481A, Reference 20 dB Attenuator, etc.

Calibrated by: Marcel Fehr, Laboratory Technician
Approved by: Katja Pokovic, Technical Manager

Issued: March 18, 2008

This calibration certificate shall not be reproduced except in full without written approval of the laboratory.



Calibration Laboratory of
Schmid & Partner
Engineering AG
Zeughausstrasse 43, 8004 Zurich, Switzerland



S Schweizerischer Kalibrierdienst
C Service suisse d'étalonnage
S Servizio svizzero di taratura
S Swiss Calibration Service

Accredited by the Swiss Federal Office of Metrology and Accreditation
The Swiss Accreditation Service is one of the signatories to the EA
Multilateral Agreement for the recognition of calibration certificates

Accreditation No.: **SCS 108**

Glossary:

TSL tissue simulating liquid
ConvF sensitivity in TSL / NORM x,y,z
N/A not applicable or not measured

Calibration is Performed According to the Following Standards:

- IEEE Std 1528-2003, "IEEE Recommended Practice for Determining the Peak Spatial-Averaged Specific Absorption Rate (SAR) in the Human Head from Wireless Communications Devices: Measurement Techniques", December 2003
- CENELEC EN 50361, "Basic standard for the measurement of Specific Absorption Rate related to human exposure to electromagnetic fields from mobile phones (300 MHz - 3 GHz), July 2001
- Federal Communications Commission Office of Engineering & Technology (FCC OET), "Evaluating Compliance with FCC Guidelines for Human Exposure to Radiofrequency Electromagnetic Fields; Additional Information for Evaluating Compliance of Mobile and Portable Devices with FCC Limits for Human Exposure to Radiofrequency Emissions", Supplement C (Edition 01-01) to Bulletin 65

Additional Documentation:

- DASY4 System Handbook

Methods Applied and Interpretation of Parameters:

- Measurement Conditions:** Further details are available from the Validation Report at the end of the certificate. All figures stated in the certificate are valid at the frequency indicated.
- Antenna Parameters with TSL:** The dipole is mounted with the spacer to position its feed point exactly below the center marking of the flat phantom section, with the arms oriented parallel to the body axis.
- Feed Point Impedance and Return Loss:** These parameters are measured with the dipole positioned under the liquid filled phantom. The impedance stated is transformed from the measurement at the SMA connector to the feed point. The Return Loss ensures low reflected power. No uncertainty required.
- Electrical Delay:** One-way delay between the SMA connector and the antenna feed point. No uncertainty required.
- SAR measured:** SAR measured at the stated antenna input power.
- SAR normalized:** SAR as measured, normalized to an input power of 1 W at the antenna connector.
- SAR for nominal TSL parameters:** The measured TSL parameters are used to calculate the nominal SAR result.



Measurement Conditions

DASY system configuration, as far as not given on page 1.

| | | |
|------------------------------|---------------------------|-------------|
| DASY Version | DASY4 | V4.7 |
| Extrapolation | Advanced Extrapolation | |
| Phantom | Modular Flat Phantom V5.0 | |
| Distance Dipole Center - TSL | 10 mm | with Spacer |
| Zoom Scan Resolution | dx, dy, dz = 5 mm | |
| Frequency | 1900 MHz ± 1 MHz | |

Head TSL parameters

The following parameters and calculations were applied.

| | Temperature | Permittivity | Conductivity |
|----------------------------------|-----------------|--------------|------------------|
| Nominal Head TSL parameters | 22.0 °C | 40.0 | 1.40 mho/m |
| Measured Head TSL parameters | (22.0 ± 0.2) °C | 40.2 ± 6 % | 1.47 mho/m ± 6 % |
| Head TSL temperature during test | (21.1 ± 0.2) °C | --- | --- |

SAR result with Head TSL

| SAR averaged over 1 cm ² (1 g) of Head TSL | condition | |
|---|--------------------|----------------------------|
| SAR measured | 250 mW input power | 10.1 mW / g |
| SAR normalized | normalized to 1W | 40.4 mW / g |
| SAR for nominal Head TSL parameters ¹ | normalized to 1W | 39.5 mW / g ± 17.0 % (k=2) |

| SAR averaged over 10 cm ² (10 g) of Head TSL | Condition | |
|---|--------------------|----------------------------|
| SAR measured | 250 mW input power | 5.20 mW / g |
| SAR normalized | normalized to 1W | 20.8 mW / g |
| SAR for nominal Head TSL parameters ¹ | normalized to 1W | 20.6 mW / g ± 16.5 % (k=2) |

¹ Correction to nominal TSL parameters according to d), chapter "SAR Sensitivities"



Body TSL parameters

The following parameters and calculations were applied.

| | Temperature | Permittivity | Conductivity |
|----------------------------------|-----------------|--------------|------------------|
| Nominal Body TSL parameters | 22.0 °C | 53.3 | 1.52 mho/m |
| Measured Body TSL parameters | (22.0 ± 0.2) °C | 51.6 ± 8 % | 1.57 mho/m ± 6 % |
| Body TSL temperature during test | (21.4 ± 0.2) °C | --- | --- |

SAR result with Body TSL

| SAR averaged over 1 cm ³ (1 g) of Body TSL | Condition | |
|---|--------------------|----------------------------|
| SAR measured | 250 mW input power | 10.4 mW / g |
| SAR normalized | normalized to 1W | 41.6 mW / g |
| SAR for nominal Body TSL parameters ² | normalized to 1W | 40.1 mW / g ± 17.0 % (k=2) |

| SAR averaged over 10 cm ³ (10 g) of Body TSL | condition | |
|---|--------------------|----------------------------|
| SAR measured | 250 mW input power | 5.44 mW / g |
| SAR normalized | normalized to 1W | 21.8 mW / g |
| SAR for nominal Body TSL parameters ² | normalized to 1W | 21.3 mW / g ± 16.5 % (k=2) |

² Correction to nominal TSL parameters according to d), chapter "SAR Sensitivities"



Appendix

Antenna Parameters with Head TSL

| | |
|--------------------------------------|--------------------------------|
| Impedance, transformed to feed point | 54.0 Ω + 5.1 j Ω |
| Return Loss | - 24.2 dB |

Antenna Parameters with Body TSL

| | |
|--------------------------------------|--------------------------------|
| Impedance, transformed to feed point | 48.0 Ω + 6.1 j Ω |
| Return Loss | - 23.6 dB |

General Antenna Parameters and Design

| | |
|----------------------------------|----------|
| Electrical Delay (one direction) | 1.199 ns |
|----------------------------------|----------|

After long term use with 100W radiated power, only a slight warming of the dipole near the feedpoint can be measured.

The dipole is made of standard semirigid coaxial cable. The center conductor of the feeding line is directly connected to the second arm of the dipole. The antenna is therefore short-circuited for DC-signals.

No excessive force must be applied to the dipole arms, because they might bend or the soldered connections near the feedpoint may be damaged.

Additional EUT Data

| | |
|-----------------|---------------|
| Manufactured by | SPEAG |
| Manufactured on | July 04, 2003 |

DASY4 Validation Report for Head TSL

Date/Time: 18.03.2008 12:05:10

Test Laboratory: SPEAG, Zurich, Switzerland

DUT: Dipole 1900 MHz; Type: D1900V2; Serial: D1900V2 - SN:5d041

Communication System: CW; Frequency: 1900 MHz; Duty Cycle: 1:1

Medium: HSL U10 BB;

Medium parameters used: $f = 1900$ MHz; $\sigma = 1.47$ mho/m; $\epsilon_r = 40.2$; $\rho = 1000$ kg/m³

Phantom section: Flat Section

Measurement Standard: DASY4 (High Precision Assessment)

DASY4 Configuration:

- Probe: ES3DV2 - SN3025; ConvF(4.9, 4.9, 4.9); Calibrated: 01.03.2008
- Sensor-Surface: 3.4mm (Mechanical Surface Detection)
- Electronics: DAE4 Sn909; Calibrated: 03.09.2007
- Phantom: Flat Phantom 5.0 (front); Type: QD000P50AA ;
- Measurement SW: DASY4, V4.7 Build 55; Postprocessing SW: SEMCAD, V1.8 Build 172

Pin = 250 mW; d = 10 mm/Zoom Scan (7x7x7)/Cube 0:

Measurement grid: dx=5mm, dy=5mm, dz=5mm

Reference Value = 91.7 V/m; Power Drift = 0.013 dB

Peak SAR (extrapolated) = 19.1 W/kg

SAR(1 g) = 10.1 mW/g; SAR(10 g) = 5.2 mW/g

Maximum value of SAR (measured) = 11.8 mW/g

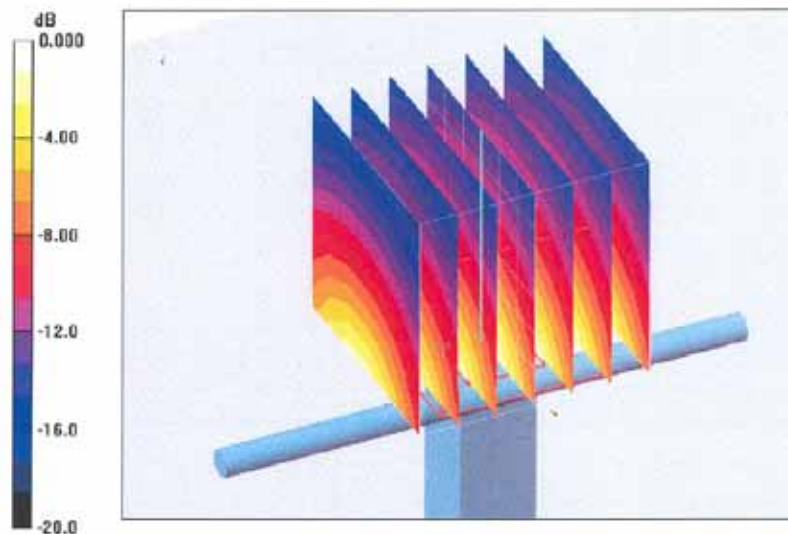

0 dB = 11.8mW/g



Impedance Measurement Plot for Head TSL

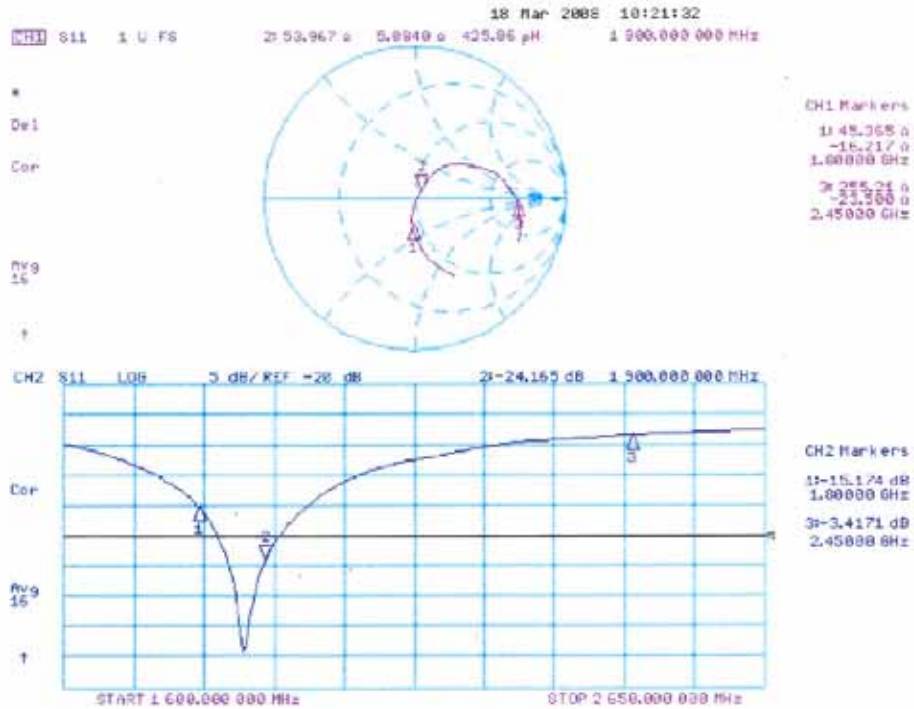

DASY4 Validation Report for Body TSL

Date/Time: 14.03.2008 13:22:24

Test Laboratory: SPEAG, Zurich, Switzerland

DUT: Dipole 1900 MHz; Type: D1900V2; Serial: D1900V2 - SN:5d041

Communication System: CW; Frequency: 1900 MHz; Duty Cycle: 1:1

Medium: MSL U10 BB;

Medium parameters used: $f = 1900$ MHz; $\sigma = 1.57$ mho/m; $\epsilon_r = 51.7$; $\rho = 1000$ kg/m³

Phantom section: Flat Section

Measurement Standard: DASY4 (High Precision Assessment)

DASY4 Configuration:

- Probe: ES3DV2 - SN3025; ConvF(4.5, 4.5, 4.5); Calibrated: 01.03.2008
- Sensor-Surface: 3.4mm (Mechanical Surface Detection)
- Electronics: DAE4 Sn909; Calibrated: 03.09.2007
- Phantom: Flat Phantom 5.0 (front); Type: QD000P50AA; ;
- Measurement SW: DASY4, V4.7 Build 55; Postprocessing SW: SEMCAD, V1.8 Build 172

Pin = 250 mW; d = 10 mm/Zoom Scan (7x7x7)/Cube 0:

Measurement grid: dx=5mm, dy=5mm, dz=5mm

Reference Value = 89.7 V/m; Power Drift = 0.004 dB

Peak SAR (extrapolated) = 18.6 W/kg

SAR(1 g) = 10.4 mW/g; SAR(10 g) = 5.44 mW/g

Maximum value of SAR (measured) = 12.0 mW/g

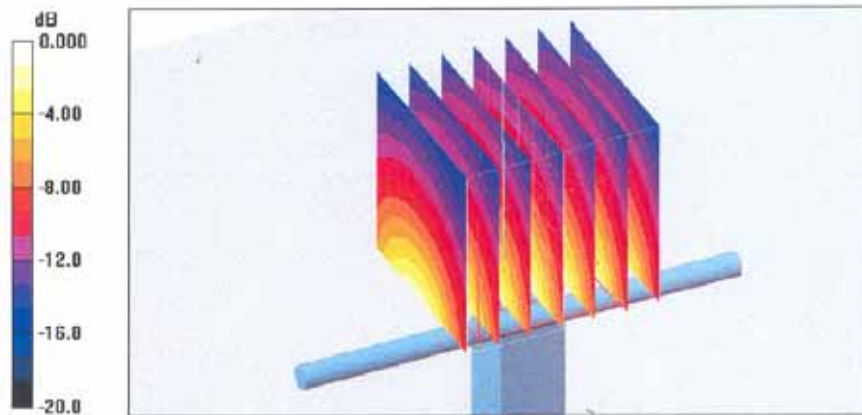

0 dB = 12.0mW/g



Impedance Measurement Plot for Body TSL

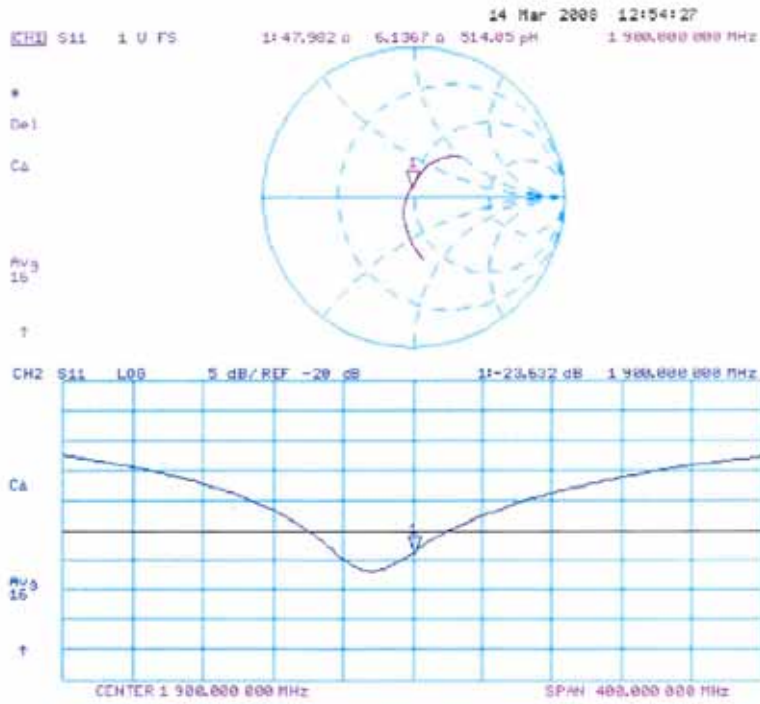



Calibration Laboratory of Schmid & Partner Engineering AG, Zeughausstrasse 43, 8004 Zurich, Switzerland



S Schweizerischer Kalibrierdienst, C Service suisse d'étalonnage, S Servizio svizzero di taratura, S Swiss Calibration Service

Accredited by the Swiss Federal Office of Metrology and Accreditation. The Swiss Accreditation Service is one of the signatories to the EA Multilateral Agreement for the recognition of calibration certificates

Accreditation No.: SCS 108

Client Sporton (Auden)

Certificate No: D2450V2-736_Jul07

CALIBRATION CERTIFICATE

Object: D2450V2 - SN: 736
Calibration procedure(s): QA CAL-05.v6 Calibration procedure for dipole validation kits
Calibration date: July 12, 2007
Condition of the calibrated item: In Tolerance

This calibration certificate documents the traceability to national standards, which realize the physical units of measurements (SI). The measurements and the uncertainties with confidence probability are given on the following pages and are part of the certificate.

All calibrations have been conducted in the closed laboratory facility: environment temperature (22 ± 3)°C and humidity < 70%.

Calibration Equipment used (M&TE critical for calibration)

Table with 4 columns: Primary Standards, ID #, Cal Date (Calibrated by, Certificate No.), Scheduled Calibration. Includes items like Power meter EPM-442A, Power sensor HP 8481A, Reference 20 dB Attenuator, etc.

Calibrated by: Name Mike Mellli, Function Laboratory Technician, Signature [Handwritten]

Approved by: Name Katja Pokovic, Function Technical Manager, Signature [Handwritten]

Issued: July 12, 2007

This calibration certificate shall not be reproduced except in full without written approval of the laboratory.

Calibration Laboratory of
Schmid & Partner
Engineering AG
Zeughausstrasse 43, 8004 Zurich, Switzerland



S Schweizerischer Kalibrierdienst
S Service suisse d'étalonnage
C Servizio svizzero di taratura
S Swiss Calibration Service

Accredited by the Swiss Federal Office of Metrology and Accreditation
The Swiss Accreditation Service is one of the signatories to the EA
Multilateral Agreement for the recognition of calibration certificates

Accreditation No.: **SCS 108**

Glossary:

| | |
|-------|---------------------------------|
| TSL | tissue simulating liquid |
| ConvF | sensitivity in TSL / NORM x,y,z |
| N/A | not applicable or not measured |

Calibration is Performed According to the Following Standards:

- IEEE Std 1528-2003, "IEEE Recommended Practice for Determining the Peak Spatial-Averaged Specific Absorption Rate (SAR) in the Human Head from Wireless Communications Devices: Measurement Techniques", December 2003
- IEC 62209-1, "Procedure to measure the Specific Absorption Rate (SAR) for hand-held devices used in close proximity to the ear (frequency range of 300 MHz to 3 GHz)", February 2005
- Federal Communications Commission Office of Engineering & Technology (FCC OET), "Evaluating Compliance with FCC Guidelines for Human Exposure to Radiofrequency Electromagnetic Fields; Additional Information for Evaluating Compliance of Mobile and Portable Devices with FCC Limits for Human Exposure to Radiofrequency Emissions", Supplement C (Edition 01-01) to Bulletin 65

Additional Documentation:

- DASY4 System Handbook

Methods Applied and Interpretation of Parameters:

- Measurement Conditions:** Further details are available from the Validation Report at the end of the certificate. All figures stated in the certificate are valid at the frequency indicated.
- Antenna Parameters with TSL:** The dipole is mounted with the spacer to position its feed point exactly below the center marking of the flat phantom section, with the arms oriented parallel to the body axis.
- Feed Point Impedance and Return Loss:** These parameters are measured with the dipole positioned under the liquid filled phantom. The impedance stated is transformed from the measurement at the SMA connector to the feed point. The Return Loss ensures low reflected power. No uncertainty required.
- Electrical Delay:** One-way delay between the SMA connector and the antenna feed point. No uncertainty required.
- SAR measured:** SAR measured at the stated antenna input power.
- SAR normalized:** SAR as measured, normalized to an input power of 1 W at the antenna connector.
- SAR for nominal TSL parameters:** The measured TSL parameters are used to calculate the nominal SAR result.



Measurement Conditions

DASY system configuration, as far as not given on page 1.

| | | |
|-------------------------------------|---------------------------|-------------|
| DASY Version | DASY4 | V4.7 |
| Extrapolation | Advanced Extrapolation | |
| Phantom | Modular Flat Phantom V5.0 | |
| Distance Dipole Center - TSL | 10 mm | with Spacer |
| Zoom Scan Resolution | dx, dy, dz = 5 mm | |
| Frequency | 2450 MHz ± 1 MHz | |

Head TSL parameters

The following parameters and calculations were applied.

| | Temperature | Permittivity | Conductivity |
|---|--------------------|---------------------|---------------------|
| Nominal Head TSL parameters | 22.0 °C | 39.2 | 1.80 mho/m |
| Measured Head TSL parameters | (22.0 ± 0.2) °C | 38.6 ± 6 % | 1.81 mho/m ± 6 % |
| Head TSL temperature during test | (22.0 ± 0.2) °C | ----- | ----- |

SAR result with Head TSL

| SAR averaged over 1 cm³ (1 g) of Head TSL | condition | |
|---|--------------------|-----------------------------------|
| SAR measured | 250 mW input power | 13.3 mW / g |
| SAR normalized | normalized to 1W | 53.2 mW / g |
| SAR for nominal Head TSL parameters ¹ | normalized to 1W | 52.7 mW / g ± 17.0 % (k=2) |

| SAR averaged over 10 cm³ (10 g) of Head TSL | condition | |
|---|--------------------|-----------------------------------|
| SAR measured | 250 mW input power | 6.17 mW / g |
| SAR normalized | normalized to 1W | 24.7 mW / g |
| SAR for nominal Head TSL parameters ¹ | normalized to 1W | 24.5 mW / g ± 16.5 % (k=2) |

¹ Correction to nominal TSL parameters according to d), chapter "SAR Sensitivities"



Body TSL parameters

The following parameters and calculations were applied.

| | Temperature | Permittivity | Conductivity |
|----------------------------------|-----------------|--------------|------------------|
| Nominal Body TSL parameters | 22.0 °C | 52.7 | 1.95 mho/m |
| Measured Body TSL parameters | (22.0 ± 0.2) °C | 53.5 ± 6 % | 1.94 mho/m ± 6 % |
| Body TSL temperature during test | (22.0 ± 0.2) °C | ----- | ----- |

SAR result with Body TSL

| SAR averaged over 1 cm ³ (1 g) of Body TSL | Condition | |
|---|--------------------|-----------------------------------|
| SAR measured | 250 mW input power | 13.0 mW / g |
| SAR normalized | normalized to 1W | 52.0 mW / g |
| SAR for nominal Body TSL parameters ² | normalized to 1W | 52.5 mW / g ± 17.0 % (k=2) |

| SAR averaged over 10 cm ³ (10 g) of Body TSL | Condition | |
|---|--------------------|-----------------------------------|
| SAR measured | 250 mW input power | 6.05 mW / g |
| SAR normalized | normalized to 1W | 24.2 mW / g |
| SAR for nominal Body TSL parameters ² | normalized to 1W | 24.4 mW / g ± 16.5 % (k=2) |

² Correction to nominal TSL parameters according to d), chapter "SAR Sensitivities"



Appendix

Antenna Parameters with Head TSL

| | |
|--------------------------------------|--------------------------------|
| Impedance, transformed to feed point | 53.1 Ω + 3.0 j Ω |
| Return Loss | - 27.6 dB |

Antenna Parameters with Body TSL

| | |
|--------------------------------------|--------------------------------|
| Impedance, transformed to feed point | 48.7 Ω + 4.6 j Ω |
| Return Loss | - 26.3 dB |

General Antenna Parameters and Design

| | |
|----------------------------------|----------|
| Electrical Delay (one direction) | 1.158 ns |
|----------------------------------|----------|

After long term use with 100W radiated power, only a slight warming of the dipole near the feedpoint can be measured.

The dipole is made of standard semirigid coaxial cable. The center conductor of the feeding line is directly connected to the second arm of the dipole. The antenna is therefore short-circuited for DC-signals.

No excessive force must be applied to the dipole arms, because they might bend or the soldered connections near the feedpoint may be damaged.

Additional EUT Data

| | |
|-----------------|-----------------|
| Manufactured by | SPEAG |
| Manufactured on | August 26, 2003 |

DASY4 Validation Report for Head TSL

Date/Time: 12.07.2007 11:00:03

Test Laboratory: SPEAG, Zurich, Switzerland

DUT: Dipole 2450 MHz; Type: D2450V2; Serial: D2450V2 - SN736

Communication System: CW-2450; Frequency: 2450 MHz; Duty Cycle: 1:1

Medium: HSL U10 BB;

Medium parameters used: $f = 2450$ MHz; $\sigma = 1.81$ mho/m; $\epsilon_r = 38.6$; $\rho = 1000$ kg/m³

Phantom section: Flat Section

Measurement Standard: DASY4 (High Precision Assessment)

DASY4 Configuration:

- Probe: ES3DV2 - SN3025 (HF); ConvP(4.5, 4.5, 4.5); Calibrated: 19.10.2006
- Sensor-Surface: 4mm (Mechanical Surface Detection)
- Electronics: DAE4 Sn601; Calibrated: 30.01.2007
- Phantom: Flat Phantom 5.0 (front); Type: QD000P50AA
- Measurement SW: DASY4, V4.7 Build 53; Postprocessing SW: SEMCAD, V1.8 Build 172

Pin = 250 mW; d = 10 mm/Zoom Scan (7x7x7)/Cube 0:

Measurement grid: dx=5mm, dy=5mm, dz=5mm

Reference Value = 93.0 V/m; Power Drift = -0.004 dB

Peak SAR (extrapolated) = 28.1 W/kg

SAR(1 g) = 13.3 mW/g; SAR(10 g) = 6.17 mW/g

Maximum value of SAR (measured) = 15.0 mW/g

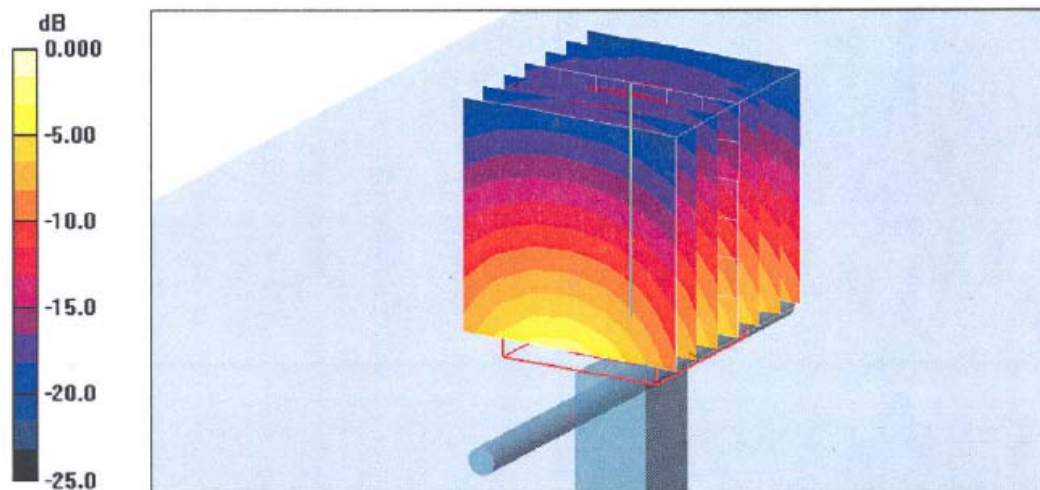

0 dB = 15.0mW/g



Impedance Measurement Plot for Head TSL

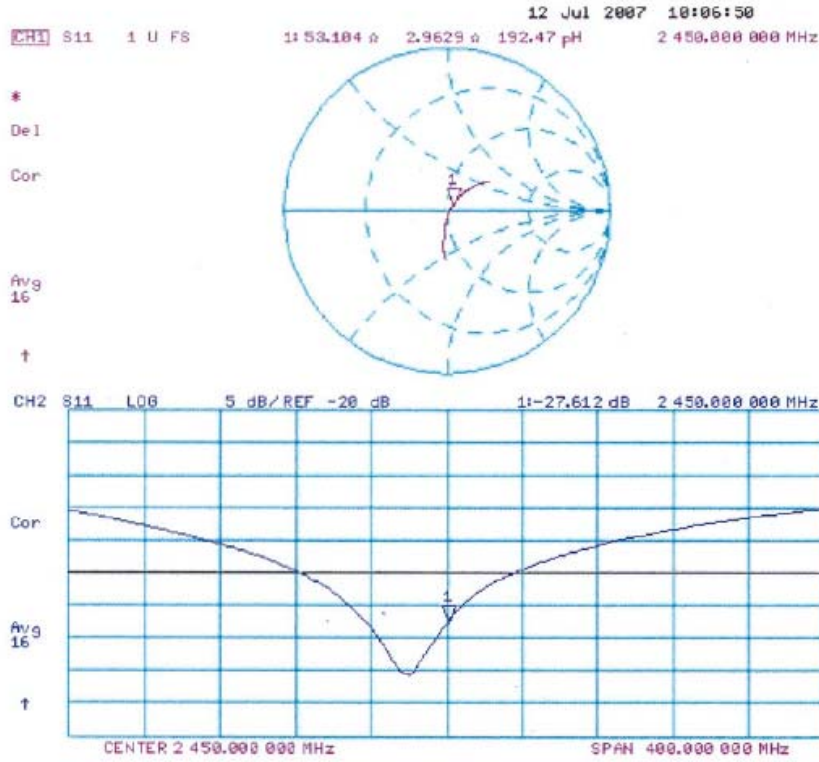

DASY4 Validation Report for Body TSL

Date/Time: 12.07.2007 12:28:49

Test Laboratory: SPEAG, Zurich, Switzerland

DUT: Dipole 2450 MHz; Type: D2450V2; Serial: D2450V2 - SN736

Communication System: CW-2450; Frequency: 2450 MHz; Duty Cycle: 1:1

Medium: MSL U10 BB;

Medium parameters used: $f = 2450$ MHz; $\sigma = 1.94$ mho/m; $\epsilon_r = 53.5$; $\rho = 1000$ kg/m³

Phantom section: Flat Section

Measurement Standard: DASY4 (High Precision Assessment)

DASY4 Configuration:

- Probe: ES3DV2 - SN3025 (HF); ConvF(4.16, 4.16, 4.16); Calibrated: 19.10.2006
- Sensor-Surface: 4mm (Mechanical Surface Detection)
- Electronics: DAE4 Sn601; Calibrated: 30.01.2007
- Phantom: Flat Phantom 5.0 (back); Type: QD000P50AA
- Measurement SW: DASY4, V4.7 Build 53; Postprocessing SW: SEMCAD, V1.8 Build 172

Pin = 250 mW; d = 10 mm/Zoom Scan (7x7x7)/Cube 0:

Measurement grid: dx=5mm, dy=5mm, dz=5mm

Reference Value = 88.6 V/m; Power Drift = 0.005 dB

Peak SAR (extrapolated) = 27.0 W/kg

SAR(1 g) = 13 mW/g; SAR(10 g) = 6.05 mW/g

Maximum value of SAR (measured) = 14.8 mW/g

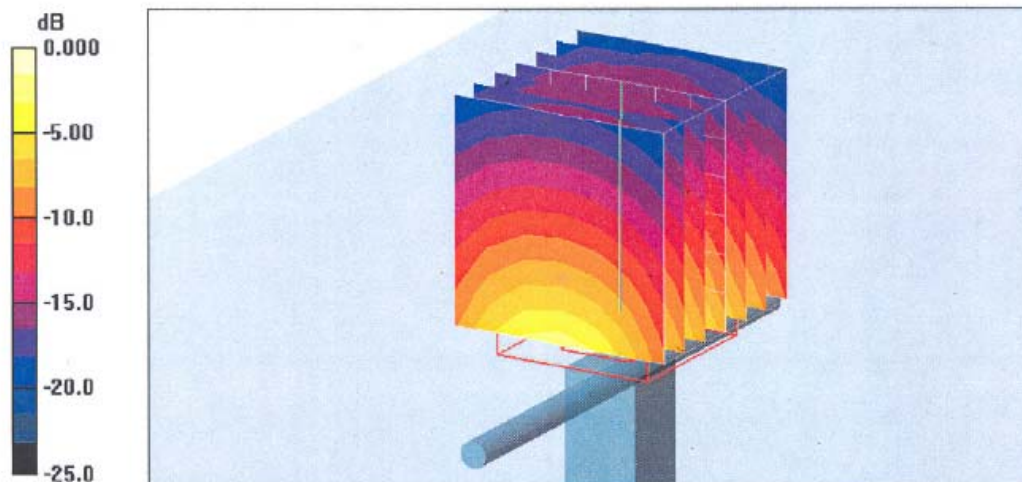

0 dB = 14.8mW/g



Impedance Measurement Plot for Body TSL

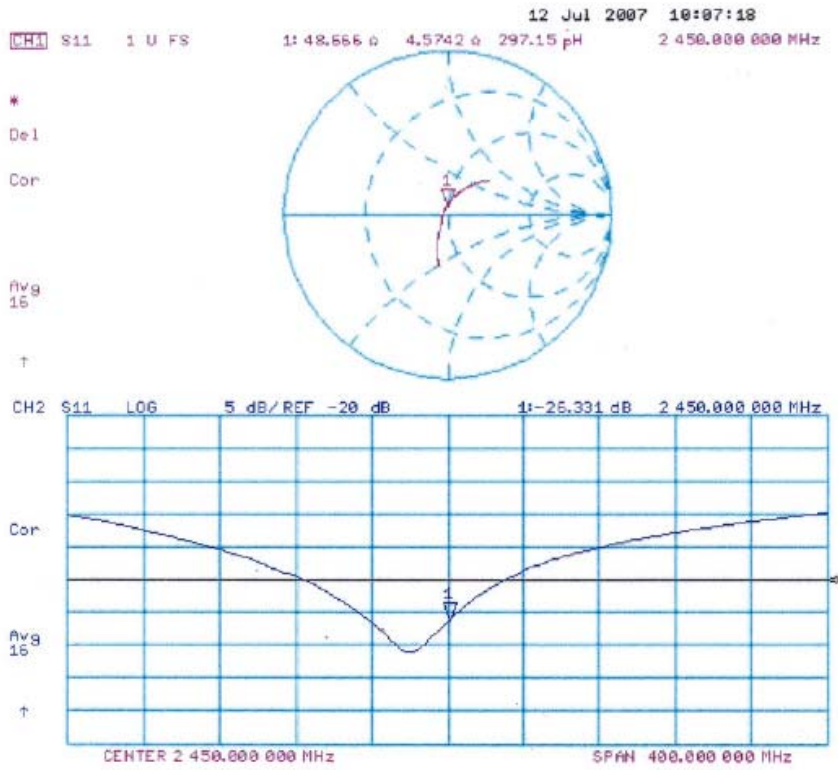



Calibration Certificate of DASY

**Calibration Laboratory of
Schmid & Partner
Engineering AG**
Zeughausstrasse 43, 8004 Zurich, Switzerland



S Schweizerischer Kalibrierdienst
C Service suisse d'étalonnage
S Servizio svizzero di taratura
S Swiss Calibration Service

Accredited by the Swiss Accreditation Service (SAS)
The Swiss Accreditation Service is one of the signatories to the EA
Multilateral Agreement for the recognition of calibration certificates

Accreditation No.: **SCS 108**

Client **Sporton (Auden)**

Certificate No: **DAE3-577_Nov08**

CALIBRATION CERTIFICATE

Object: **DAE3 - SD 000 D03 AA - SN: 577**

Calibration procedure(s): **QA CAL-06.v12
Calibration procedure for the data acquisition electronics (DAE)**

Calibration date: **November 12, 2008**

Condition of the calibrated item: **In Tolerance**

This calibration certificate documents the traceability to national standards, which realize the physical units of measurements (SI).
The measurements and the uncertainties with confidence probability are given on the following pages and are part of the certificate.

All calibrations have been conducted in the closed laboratory facility: environment temperature (22 ± 3)°C and humidity < 70%.

Calibration Equipment used (M&TE critical for calibration)

| Primary Standards | ID # | Cal Date (Certificate No.) | Scheduled Calibration |
|-----------------------------------|--------------------|----------------------------|------------------------|
| Fluke Process Calibrator Type 702 | SN: 6295803 | 30-Sep-08 (No: 7673) | Sep-09 |
| Keithley Multimeter Type 2001 | SN: 0810278 | 30-Sep-08 (No: 7670) | Sep-09 |
| Secondary Standards | ID # | Check Date (in house) | Scheduled Check |
| Calibrator Box V1.1 | SE UMS 006 AB 1004 | 06-Jun-08 (in house check) | In house check: Jun-09 |

| | | | |
|----------------|------------------------------|-------------------------------------|---------------|
| Calibrated by: | Name Andrea Guntli | Function Technician | Signature |
| Approved by: | Name Fin Bomholt | Function R&D Director | Signature |

Issued: November 12, 2008

This calibration certificate shall not be reproduced except in full without written approval of the laboratory.



Calibration Laboratory of
Schmid & Partner
Engineering AG
Zeughausstrasse 43, 8004 Zurich, Switzerland



S Schweizerischer Kalibrierdienst
C Service suisse d'étalonnage
S Servizio svizzero di taratura
S Swiss Calibration Service

Accredited by the Swiss Accreditation Service (SAS)
The Swiss Accreditation Service is one of the signatories to the EA
Multilateral Agreement for the recognition of calibration certificates

Accreditation No.: **SCS 108**

Glossary

DAE data acquisition electronics
Connector angle information used in DASY system to align probe sensor X to the robot coordinate system.

Methods Applied and Interpretation of Parameters

- **DC Voltage Measurement:** Calibration Factor assessed for use in DASY system by comparison with a calibrated instrument traceable to national standards. The figure given corresponds to the full scale range of the voltmeter in the respective range.
- **Connector angle:** The angle of the connector is assessed measuring the angle mechanically by a tool inserted. Uncertainty is not required.
- The following parameters as documented in the Appendix contain technical information as a result from the performance test and require no uncertainty.
 - **DC Voltage Measurement Linearity:** Verification of the Linearity at +10% and -10% of the nominal calibration voltage. Influence of offset voltage is included in this measurement.
 - **Common mode sensitivity:** Influence of a positive or negative common mode voltage on the differential measurement.
 - **Channel separation:** Influence of a voltage on the neighbor channels not subject to an input voltage.
 - **AD Converter Values with inputs shorted:** Values on the internal AD converter corresponding to zero input voltage
 - **Input Offset Measurement:** Output voltage and statistical results over a large number of zero voltage measurements.
 - **Input Offset Current:** Typical value for information; Maximum channel input offset current, not considering the input resistance.
 - **Input resistance:** DAE input resistance at the connector, during internal auto-zeroing and during measurement.
 - **Low Battery Alarm Voltage:** Typical value for information. Below this voltage, a battery alarm signal is generated.
 - **Power consumption:** Typical value for information. Supply currents in various operating modes.



DC Voltage Measurement

A/D - Converter Resolution nominal

High Range: 1LSB = 6.1 μ V , full range = -100...+300 mV

Low Range: 1LSB = 61nV , full range = -1.....+3mV

DASY measurement parameters: Auto Zero Time: 3 sec; Measuring time: 3 sec

| Calibration Factors | X | Y | Z |
|---------------------|--------------------------|--------------------------|--------------------------|
| High Range | 404.437 \pm 0.1% (k=2) | 403.882 \pm 0.1% (k=2) | 404.321 \pm 0.1% (k=2) |
| Low Range | 3.93985 \pm 0.7% (k=2) | 3.94699 \pm 0.7% (k=2) | 3.94542 \pm 0.7% (k=2) |

Connector Angle

| | |
|--|-----------------------------------|
| Connector Angle to be used in DASYS system | 268 $^{\circ}$ \pm 1 $^{\circ}$ |
|--|-----------------------------------|



Appendix

1. DC Voltage Linearity

| High Range | Input (μV) | Reading (μV) | Error (%) |
|-------------------|------------|--------------|-----------|
| Channel X + Input | 200000 | 200000.5 | 0.00 |
| Channel X + Input | 20000 | 20006.28 | 0.03 |
| Channel X - Input | 20000 | -19997.96 | -0.01 |
| Channel Y + Input | 200000 | 199999.8 | 0.00 |
| Channel Y + Input | 20000 | 20003.35 | 0.02 |
| Channel Y - Input | 20000 | -20003.31 | 0.02 |
| Channel Z + Input | 200000 | 200000.3 | 0.00 |
| Channel Z + Input | 20000 | 20006.28 | 0.03 |
| Channel Z - Input | 20000 | -19999.42 | 0.00 |

| Low Range | Input (μV) | Reading (μV) | Error (%) |
|-------------------|------------|--------------|-----------|
| Channel X + Input | 2000 | 2000 | 0.00 |
| Channel X + Input | 200 | 200.64 | 0.32 |
| Channel X - Input | 200 | -199.61 | -0.19 |
| Channel Y + Input | 2000 | 2000 | 0.00 |
| Channel Y + Input | 200 | 199.39 | -0.31 |
| Channel Y - Input | 200 | -201.03 | 0.52 |
| Channel Z + Input | 2000 | 2000 | 0.00 |
| Channel Z + Input | 200 | 199.42 | -0.29 |
| Channel Z - Input | 200 | -200.73 | 0.36 |

2. Common mode sensitivity

DASY measurement parameters: Auto Zero Time: 3 sec; Measuring time: 3 sec

| | Common mode Input Voltage (mV) | High Range Average Reading (μV) | Low Range Average Reading (μV) |
|-----------|--------------------------------|---------------------------------|--------------------------------|
| Channel X | 200 | 13.38 | 13.83 |
| | - 200 | -13.53 | -13.82 |
| Channel Y | 200 | -5.55 | -6.09 |
| | - 200 | 5.06 | 5.66 |
| Channel Z | 200 | -1.00 | -0.72 |
| | - 200 | -0.80 | -0.52 |

3. Channel separation

DASY measurement parameters: Auto Zero Time: 3 sec; Measuring time: 3 sec

| | Input Voltage (mV) | Channel X (μV) | Channel Y (μV) | Channel Z (μV) |
|-----------|--------------------|----------------|----------------|----------------|
| Channel X | 200 | - | 1.66 | 0.50 |
| Channel Y | 200 | 1.90 | - | 3.95 |
| Channel Z | 200 | -0.95 | 0.48 | - |



4. AD-Converter Values with inputs shorted

DASY measurement parameters: Auto Zero Time: 3 sec; Measuring time: 3 sec

| | High Range (LSB) | Low Range (LSB) |
|-----------|------------------|-----------------|
| Channel X | 15967 | 16080 |
| Channel Y | 15851 | 16385 |
| Channel Z | 16197 | 16100 |

5. Input Offset Measurement

DASY measurement parameters: Auto Zero Time: 3 sec; Measuring time: 3 sec

Input 10MΩ

| | Average (μV) | min. Offset (μV) | max. Offset (μV) | Std. Deviation (μV) |
|-----------|--------------|------------------|------------------|---------------------|
| Channel X | 1.13 | -1.22 | 2.29 | 0.58 |
| Channel Y | -1.51 | -2.99 | 0.83 | 0.52 |
| Channel Z | 0.02 | -0.89 | 0.92 | 0.38 |

6. Input Offset Current

Nominal Input circuitry offset current on all channels: <25fA

7. Input Resistance

| | Zeroing (MOhm) | Measuring (MOhm) |
|-----------|----------------|------------------|
| Channel X | 0.2000 | 198.6 |
| Channel Y | 0.2001 | 199.4 |
| Channel Z | 0.2000 | 198.8 |

8. Low Battery Alarm Voltage (verified during pre test)

| Typical values | Alarm Level (VDC) |
|----------------|-------------------|
| Supply (+ Vcc) | +7.9 |
| Supply (- Vcc) | -7.6 |

9. Power Consumption (verified during pre test)

| Typical values | Switched off (mA) | Stand by (mA) | Transmitting (mA) |
|----------------|-------------------|---------------|-------------------|
| Supply (+ Vcc) | +0.0 | +6 | +14 |
| Supply (- Vcc) | -0.01 | -8 | -9 |



Calibration Certificate of DASY

**Calibration Laboratory of
Schmid & Partner
Engineering AG**
Zeughausstrasse 43, 8004 Zurich, Switzerland



S Schweizerischer Kalibrierdienst
S Service suisse d'étalonnage
C Servizio svizzero di taratura
S Swiss Calibration Service

Accredited by the Swiss Accreditation Service (SAS)
The Swiss Accreditation Service is one of the signatories to the EA
Multilateral Agreement for the recognition of calibration certificates

Accreditation No.: **SCS 108**

Client **Sporton (Auden)**

Certificate No: **DAE4-778_Sep08**

CALIBRATION CERTIFICATE

Object: **DAE4 - SD 000 D04 BG - SN: 778**

Calibration procedure(s): **QA CAL-06.v12
Calibration procedure for the data acquisition electronics (DAE)**

Calibration date: **September 22, 2008**

Condition of the calibrated item: **In Tolerance**

This calibration certificate documents the traceability to national standards, which realize the physical units of measurements (SI).
The measurements and the uncertainties with confidence probability are given on the following pages and are part of the certificate.

All calibrations have been conducted in the closed laboratory facility: environment temperature (22 ± 3)°C and humidity < 70%.

Calibration Equipment used (M&TE critical for calibration)

| Primary Standards | ID # | Cal Date (Certificate No.) | Scheduled Calibration |
|-----------------------------------|--------------------|----------------------------|------------------------|
| Fluke Process Calibrator Type 702 | SN: 6295803 | 04-Oct-07 (No: 6467) | Oct-08 |
| Keithley Multimeter Type 2001 | SN: 0810278 | 03-Oct-07 (No: 6465) | Oct-08 |
| Secondary Standards | ID # | Check Date (in house) | Scheduled Check |
| Calibrator Box V1.1 | SE UMS 006 AB 1004 | 06-Jun-08 (in house check) | In house check: Jun-09 |

| | Name | Function | Signature |
|----------------|---------------|--------------|-----------|
| Calibrated by: | Andrea Guntli | Technician | |
| Approved by: | Fin Bornholt | R&D Director | |

Issued: September 22, 2008

This calibration certificate shall not be reproduced except in full without written approval of the laboratory.



**Calibration Laboratory of
Schmid & Partner
Engineering AG**
Zeughausstrasse 43, 8004 Zurich, Switzerland



S Schweizerischer Kalibrierdienst
C Service suisse d'étalonnage
S Servizio svizzero di taratura
S Swiss Calibration Service

Accredited by the Swiss Accreditation Service (SAS)
The Swiss Accreditation Service is one of the signatories to the EA
Multilateral Agreement for the recognition of calibration certificates

Accreditation No.: **SCS 108**

Glossary

DAE data acquisition electronics
Connector angle information used in DASY system to align probe sensor X to the robot coordinate system.

Methods Applied and Interpretation of Parameters

- **DC Voltage Measurement:** Calibration Factor assessed for use in DASY system by comparison with a calibrated instrument traceable to national standards. The figure given corresponds to the full scale range of the voltmeter in the respective range.
- **Connector angle:** The angle of the connector is assessed measuring the angle mechanically by a tool inserted. Uncertainty is not required.
- The following parameters as documented in the Appendix contain technical information as a result from the performance test and require no uncertainty.
 - **DC Voltage Measurement Linearity:** Verification of the Linearity at +10% and -10% of the nominal calibration voltage. Influence of offset voltage is included in this measurement.
 - **Common mode sensitivity:** Influence of a positive or negative common mode voltage on the differential measurement.
 - **Channel separation:** Influence of a voltage on the neighbor channels not subject to an input voltage.
 - **AD Converter Values with inputs shorted:** Values on the internal AD converter corresponding to zero input voltage
 - **Input Offset Measurement:** Output voltage and statistical results over a large number of zero voltage measurements.
 - **Input Offset Current:** Typical value for information; Maximum channel input offset current, not considering the input resistance.
 - **Input resistance:** DAE input resistance at the connector, during internal auto-zeroing and during measurement.
 - **Low Battery Alarm Voltage:** Typical value for information. Below this voltage, a battery alarm signal is generated.
 - **Power consumption:** Typical value for information. Supply currents in various operating modes.



DC Voltage Measurement

A/D - Converter Resolution nominal

High Range: 1LSB = 6.1 μ V, full range = -100...+300 mV

Low Range: 1LSB = 61nV, full range = -1.....+3mV

DASY measurement parameters: Auto Zero Time: 3 sec; Measuring time: 3 sec

| Calibration Factors | X | Y | Z |
|---------------------|--------------------------|--------------------------|--------------------------|
| High Range | 404.686 \pm 0.1% (k=2) | 403.490 \pm 0.1% (k=2) | 405.045 \pm 0.1% (k=2) |
| Low Range | 3.99455 \pm 0.7% (k=2) | 3.96369 \pm 0.7% (k=2) | 3.99417 \pm 0.7% (k=2) |

Connector Angle

| | |
|---|-----------------------------------|
| Connector Angle to be used in DASY system | 309 $^{\circ}$ \pm 1 $^{\circ}$ |
|---|-----------------------------------|



Appendix

1. DC Voltage Linearity

| High Range | Input (μV) | Reading (μV) | Error (%) |
|-------------------|-------------------------|---------------------------|-----------|
| Channel X + Input | 200000 | 200000.3 | 0.00 |
| Channel X + Input | 20000 | 20004.24 | 0.02 |
| Channel X - Input | 20000 | -20002.46 | 0.01 |
| Channel Y + Input | 200000 | 200000.4 | 0.00 |
| Channel Y + Input | 20000 | 20002.60 | 0.01 |
| Channel Y - Input | 20000 | -20002.26 | 0.01 |
| Channel Z + Input | 200000 | 200000.6 | 0.00 |
| Channel Z + Input | 20000 | 20000.78 | 0.00 |
| Channel Z - Input | 20000 | -20005.75 | 0.03 |

| Low Range | Input (μV) | Reading (μV) | Error (%) |
|-------------------|-------------------------|---------------------------|-----------|
| Channel X + Input | 2000 | 2000 | 0.00 |
| Channel X + Input | 200 | 199.37 | -0.31 |
| Channel X - Input | 200 | -200.28 | 0.14 |
| Channel Y + Input | 2000 | 2000 | 0.00 |
| Channel Y + Input | 200 | 199.63 | -0.19 |
| Channel Y - Input | 200 | -200.88 | 0.44 |
| Channel Z + Input | 2000 | 2000.1 | 0.00 |
| Channel Z + Input | 200 | 198.60 | -0.70 |
| Channel Z - Input | 200 | -201.07 | 0.53 |

2. Common mode sensitivity

DASY measurement parameters: Auto Zero Time: 3 sec; Measuring time: 3 sec

| | Common mode Input Voltage (mV) | High Range Average Reading (μV) | Low Range Average Reading (μV) |
|-----------|--------------------------------|--|---|
| Channel X | 200 | -7.46 | -6.40 |
| | -200 | 10.00 | 6.86 |
| Channel Y | 200 | -2.73 | -2.45 |
| | -200 | 0.84 | 0.43 |
| Channel Z | 200 | -10.91 | -10.94 |
| | -200 | 7.89 | 8.22 |

3. Channel separation

DASY measurement parameters: Auto Zero Time: 3 sec; Measuring time: 3 sec

| | Input Voltage (mV) | Channel X (μV) | Channel Y (μV) | Channel Z (μV) |
|-----------|--------------------|-----------------------------|-----------------------------|-----------------------------|
| Channel X | 200 | - | 3.08 | -1.34 |
| Channel Y | 200 | 1.18 | - | 4.64 |
| Channel Z | 200 | -1.74 | 1.44 | - |



4. AD-Converter Values with inputs shorted

DASY measurement parameters: Auto Zero Time: 3 sec; Measuring time: 3 sec

| | High Range (LSB) | Low Range (LSB) |
|-----------|------------------|-----------------|
| Channel X | 16048 | 16021 |
| Channel Y | 16167 | 15166 |
| Channel Z | 16416 | 15977 |

5. Input Offset Measurement

DASY measurement parameters: Auto Zero Time: 3 sec; Measuring time: 3 sec

Input 10MΩ

| | Average (μV) | min. Offset (μV) | max. Offset (μV) | Std. Deviation (μV) |
|-----------|--------------|------------------|------------------|---------------------|
| Channel X | -0.13 | -0.88 | 0.92 | 0.33 |
| Channel Y | -0.88 | -2.47 | 0.72 | 0.55 |
| Channel Z | -1.16 | -2.17 | -0.19 | 0.42 |

6. Input Offset Current

Nominal Input circuitry offset current on all channels: <25fA

7. Input Resistance

| | Zeroing (MOhm) | Measuring (MOhm) |
|-----------|----------------|------------------|
| Channel X | 0.2000 | 201.1 |
| Channel Y | 0.2000 | 201.0 |
| Channel Z | 0.2001 | 201.7 |

8. Low Battery Alarm Voltage (verified during pre test)

| Typical values | Alarm Level (VDC) |
|----------------|-------------------|
| Supply (+ Vcc) | +7.9 |
| Supply (- Vcc) | -7.6 |

9. Power Consumption (verified during pre test)

| Typical values | Switched off (mA) | Stand by (mA) | Transmitting (mA) |
|----------------|-------------------|---------------|-------------------|
| Supply (+ Vcc) | +0.0 | +6 | +14 |
| Supply (- Vcc) | -0.01 | -8 | -9 |



Calibration Laboratory of Schmid & Partner Engineering AG, Zeughausstrasse 43, 8004 Zurich, Switzerland



S Schweizerischer Kalibrierdienst, C Service suisse d'etalonnage, S Servizio svizzero di taratura, S Swiss Calibration Service

Accredited by the Swiss Accreditation Service (SA5), The Swiss Accreditation Service is one of the signatories to the EA Multilateral Agreement for the recognition of calibration certificates

Accreditation No.: SCS 108

Client Sporton (Auden)

Certificate No: ET3-1787_Aug08

CALIBRATION CERTIFICATE

Object: ET3DV6 - SN:1787
Calibration procedure(s): QA CAL-01.v6 and QA CAL-23.v3, Calibration procedure for dosimetric E-field probes
Calibration date: August 26, 2008
Condition of the calibrated item: In Tolerance

This calibration certificate documents the traceability to national standards, which realize the physical units of measurements (SI). The measurements and the uncertainties with confidence probability are given on the following pages and are part of the certificate.

All calibrations have been conducted in the closed laboratory facility; environment temperature (22 ± 3)°C and humidity < 70%.

Calibration Equipment used (M&TE critical for calibration)

Table with 4 columns: Primary Standards, ID #, Cal Date (Certificate No.), Scheduled Calibration. Lists various power meters, sensors, attenuators, and probes with their respective IDs and calibration dates.

Calibrated by: Katja Pokovic, Technical Manager
Approved by: Niels Kuster, Quality Manager

Issued: August 26, 2008

This calibration certificate shall not be reproduced except in full without written approval of the laboratory.



Calibration Laboratory of
Schmid & Partner
Engineering AG
Zeughausstrasse 43, 8004 Zurich, Switzerland



S Schweizerischer Kalibrierdienst
C Service suisse d'étalonnage
S Servizio svizzero di taratura
S Swiss Calibration Service

Accredited by the Swiss Accreditation Service (SAS)
The Swiss Accreditation Service is one of the signatories to the EA
Multilateral Agreement for the recognition of calibration certificates

Accreditation No.: SCS 108

Glossary:

| | |
|--------------------------|--|
| TSL | tissue simulating liquid |
| NORM _{x,y,z} | sensitivity in free space |
| ConvF | sensitivity in TSL / NORM _{x,y,z} |
| DCP | diode compression point |
| Polarization φ | φ rotation around probe axis |
| Polarization ϑ | ϑ rotation around an axis that is in the plane normal to probe axis (at measurement center), i.e., $\vartheta = 0$ is normal to probe axis |

Calibration is Performed According to the Following Standards:

- a) IEEE Std 1528-2003, "IEEE Recommended Practice for Determining the Peak Spatial-Averaged Specific Absorption Rate (SAR) in the Human Head from Wireless Communications Devices: Measurement Techniques", December 2003
- b) IEC 62209-1, "Procedure to measure the Specific Absorption Rate (SAR) for hand-held devices used in close proximity to the ear (frequency range of 300 MHz to 3 GHz)", February 2005

Methods Applied and Interpretation of Parameters:

- **NORM_{x,y,z}:** Assessed for E-field polarization $\vartheta = 0$ ($f \leq 900$ MHz in TEM-cell; $f > 1800$ MHz: R22 waveguide). NORM_{x,y,z} are only intermediate values, i.e., the uncertainties of NORM_{x,y,z} does not effect the E²-field uncertainty inside TSL (see below ConvF).
- **NORM(f)_{x,y,z} = NORM_{x,y,z} * frequency_response** (see Frequency Response Chart). This linearization is implemented in DASY4 software versions later than 4.2. The uncertainty of the frequency response is included in the stated uncertainty of ConvF.
- **DCP_{x,y,z}:** DCP are numerical linearization parameters assessed based on the data of power sweep (no uncertainty required). DCP does not depend on frequency nor media.
- **ConvF and Boundary Effect Parameters:** Assessed in flat phantom using E-field (or Temperature Transfer Standard for $f \leq 800$ MHz) and inside waveguide using analytical field distributions based on power measurements for $f > 800$ MHz. The same setups are used for assessment of the parameters applied for boundary compensation (alpha, depth) of which typical uncertainty values are given. These parameters are used in DASY4 software to improve probe accuracy close to the boundary. The sensitivity in TSL corresponds to NORM_{x,y,z} * ConvF whereby the uncertainty corresponds to that given for ConvF. A frequency dependent ConvF is used in DASY version 4.4 and higher which allows extending the validity from ± 50 MHz to ± 100 MHz.
- **Spherical isotropy (3D deviation from isotropy):** in a field of low gradients realized using a flat phantom exposed by a patch antenna.
- **Sensor Offset:** The sensor offset corresponds to the offset of virtual measurement center from the probe tip (on probe axis). No tolerance required.



ET3DV6 SN:1787

August 26, 2008

Probe ET3DV6

SN:1787

| | |
|------------------|-----------------|
| Manufactured: | May 28, 2003 |
| Last calibrated: | August 28, 2007 |
| Recalibrated: | August 26, 2008 |

Calibrated for DASYS Systems

(Note: non-compatible with DASYS2 system!)



ET3DV6 SN:1787

August 26, 2008

DASY - Parameters of Probe: ET3DV6 SN:1787

Sensitivity in Free Space^A

Diode Compression^B

| | | | | |
|-------|--------------|-----------------------|-------|-------|
| NormX | 1.63 ± 10.1% | μV/(V/m) ² | DCP X | 90 mV |
| NormY | 1.67 ± 10.1% | μV/(V/m) ² | DCP Y | 93 mV |
| NormZ | 2.18 ± 10.1% | μV/(V/m) ² | DCP Z | 92 mV |

Sensitivity in Tissue Simulating Liquid (Conversion Factors)

Please see Page 8.

Boundary Effect

TSL 900 MHz Typical SAR gradient: 5 % per mm

| | | | |
|---|------------------------------|--------|--------|
| Sensor Center to Phantom Surface Distance | | 3.7 mm | 4.7 mm |
| SAR _{ce} [%] | Without Correction Algorithm | 11.3 | 7.5 |
| SAR _{ce} [%] | With Correction Algorithm | 0.8 | 0.5 |

TSL 1750 MHz Typical SAR gradient: 10 % per mm

| | | | |
|---|------------------------------|--------|--------|
| Sensor Center to Phantom Surface Distance | | 3.7 mm | 4.7 mm |
| SAR _{ce} [%] | Without Correction Algorithm | 10.1 | 6.5 |
| SAR _{ce} [%] | With Correction Algorithm | 0.8 | 0.6 |

Sensor Offset

Probe Tip to Sensor Center 2.7 mm

The reported uncertainty of measurement is stated as the standard uncertainty of measurement multiplied by the coverage factor k=2, which for a normal distribution corresponds to a coverage probability of approximately 95%.

^A The uncertainties of NormX,Y,Z do not affect the E²-field uncertainty inside TSL (see Page 8).

^B Numerical linearization parameter: uncertainty not required.



ET3DV6 SN:1787

August 26, 2008

Frequency Response of E-Field

(TEM-Cell:ifi110 EXX, Waveguide: R22)

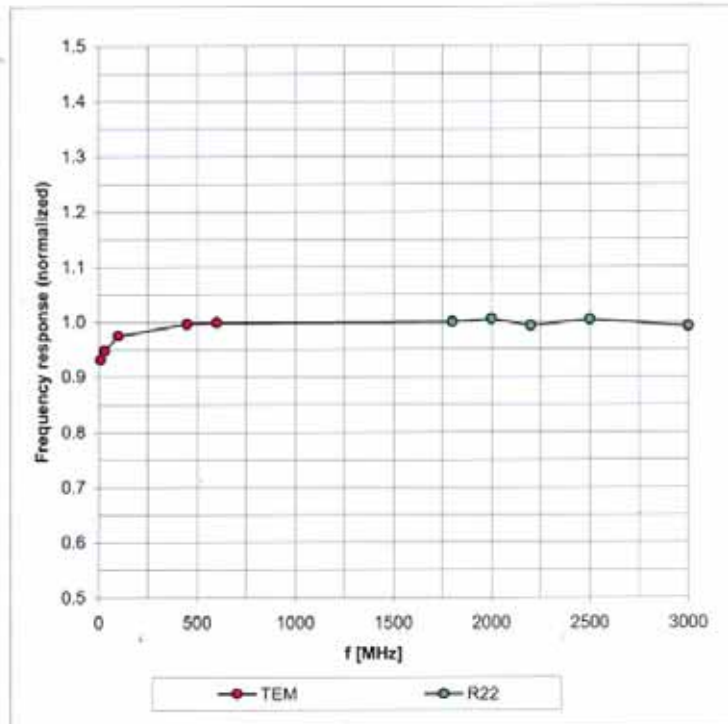

Uncertainty of Frequency Response of E-field: $\pm 6.3\%$ (k=2)



ET3DV6 SN:1787

August 26, 2008

Receiving Pattern (ϕ), $\vartheta = 0^\circ$

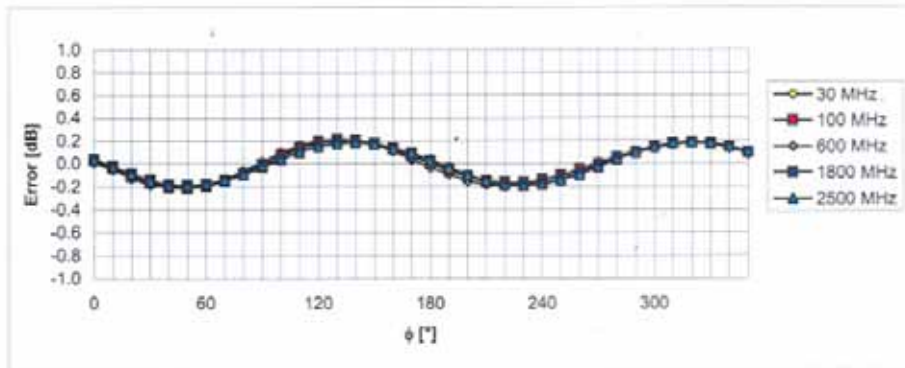
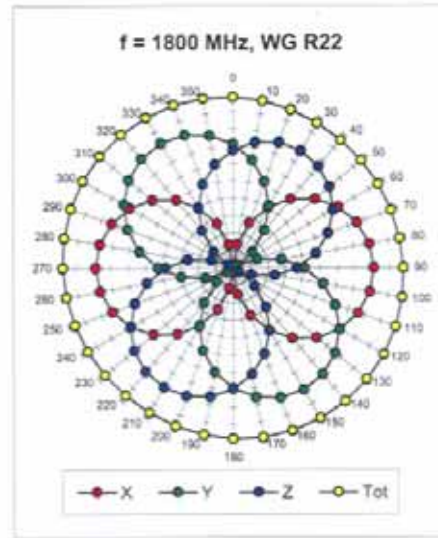
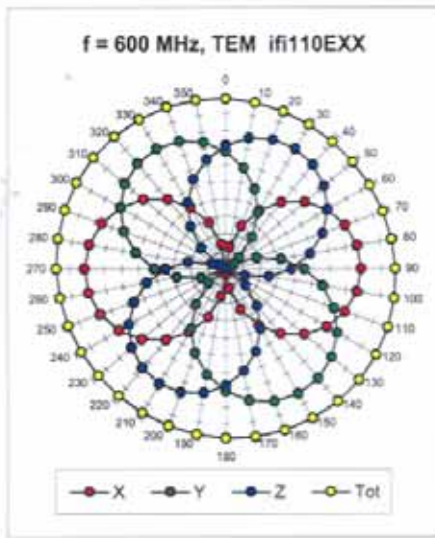

Uncertainty of Axial Isotropy Assessment: $\pm 0.5\%$ ($k=2$)



ET3DV6 SN:1787

August 26, 2008

Dynamic Range $f(\text{SAR}_{\text{head}})$ (Waveguide R22, $f = 1800 \text{ MHz}$)

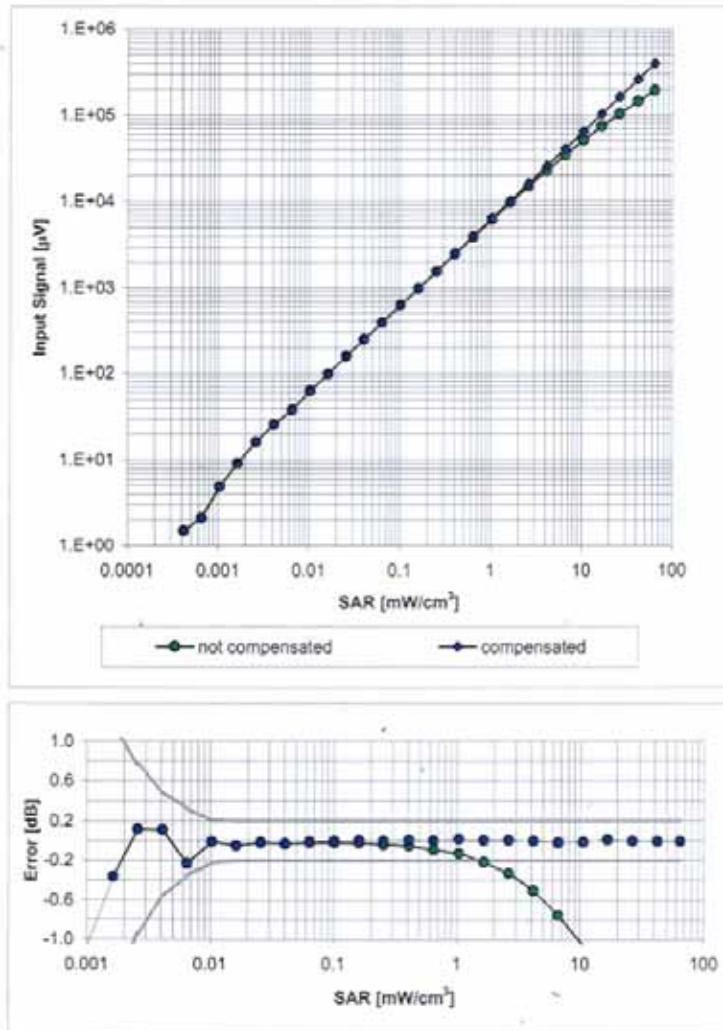

Uncertainty of Linearity Assessment: $\pm 0.6\%$ ($k=2$)



ET3DV6 SN:1787

August 26, 2008

Conversion Factor Assessment

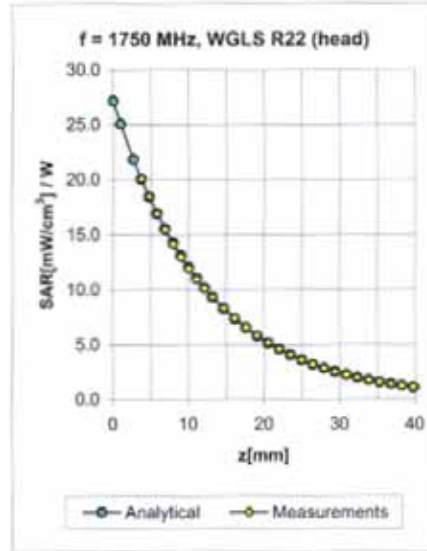
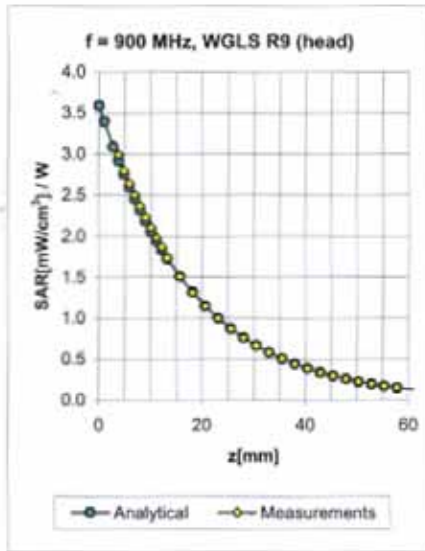

| f [MHz] | Validity [MHz] ^c | TSL | Permittivity | Conductivity | Alpha | Depth | ConvF Uncertainty |
|---------|-----------------------------|------|--------------|--------------|-------|-------|--------------------|
| 900 | ± 50 / ± 100 | Head | 41.5 ± 5% | 0.97 ± 5% | 0.30 | 2.80 | 6.06 ± 11.0% (k=2) |
| 1750 | ± 50 / ± 100 | Head | 40.1 ± 5% | 1.37 ± 5% | 0.53 | 2.11 | 5.36 ± 11.0% (k=2) |
| 1950 | ± 50 / ± 100 | Head | 40.0 ± 5% | 1.40 ± 5% | 0.59 | 1.96 | 5.01 ± 11.0% (k=2) |
| 2450 | ± 50 / ± 100 | Head | 39.2 ± 5% | 1.80 ± 5% | 0.77 | 1.57 | 4.49 ± 11.0% (k=2) |
| 900 | ± 50 / ± 100 | Body | 55.0 ± 5% | 1.05 ± 5% | 0.31 | 2.98 | 5.91 ± 11.0% (k=2) |
| 1750 | ± 50 / ± 100 | Body | 53.4 ± 5% | 1.49 ± 5% | 0.60 | 2.20 | 4.73 ± 11.0% (k=2) |
| 1950 | ± 50 / ± 100 | Body | 53.3 ± 5% | 1.52 ± 5% | 0.68 | 1.95 | 4.49 ± 11.0% (k=2) |
| 2450 | ± 50 / ± 100 | Body | 52.7 ± 5% | 1.95 ± 5% | 0.90 | 1.51 | 3.79 ± 11.0% (k=2) |

^c The validity of ± 100 MHz only applies for DASY v4.4 and higher (see Page 2). The uncertainty is the RSS of the ConvF uncertainty at calibration frequency and the uncertainty for the indicated frequency band.



ET3DV6 SN:1787

August 26, 2008

Deviation from Isotropy in HSL

Error (ϕ , θ), $f = 900$ MHz

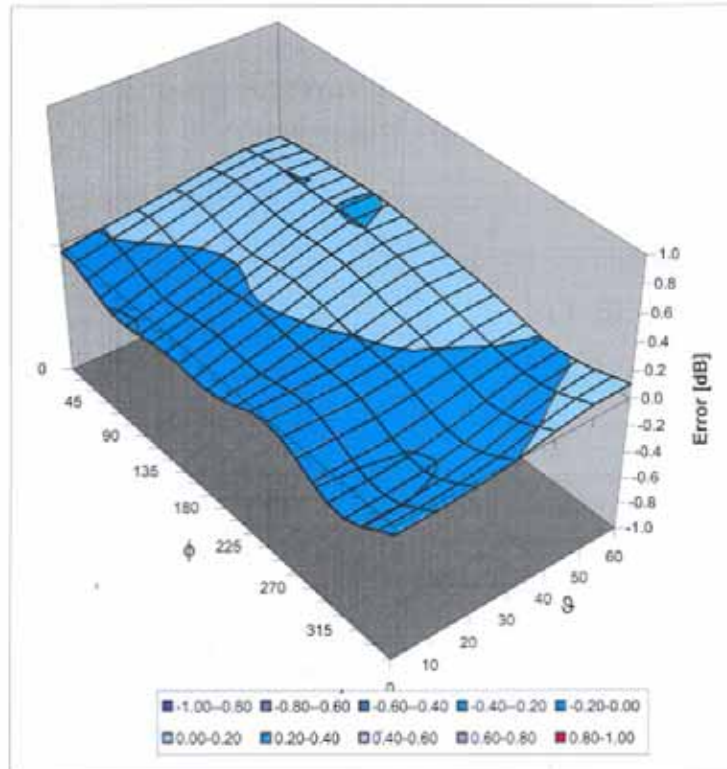

Uncertainty of Spherical Isotropy Assessment: $\pm 2.6\%$ ($k=2$)



Calibration Laboratory of Schmid & Partner Engineering AG, Zeughausstrasse 43, 8004 Zurich, Switzerland



S Schweizerischer Kalibrierdienst, C Service suisse d'etalonnage, S Servizio svizzero di taratura, S Swiss Calibration Service

Accredited by the Swiss Accreditation Service (SAS)
The Swiss Accreditation Service is one of the signatories to the EA Multilateral Agreement for the recognition of calibration certificates

Accreditation No.: SCS 108

Client Sporton (Auden)

Certificate No: ET3-1788_Sep08

CALIBRATION CERTIFICATE

Object: ET3DV6 - SN:1788
Calibration procedure(s): QA CAL-01.v6 and QA CAL-23.v3
Calibration date: September 23, 2008
Condition of the calibrated item: In Tolerance

This calibration certificate documents the traceability to national standards, which realize the physical units of measurements (SI). The measurements and the uncertainties with confidence probability are given on the following pages and are part of the certificate.

All calibrations have been conducted in the closed laboratory facility: environment temperature (22 ± 3)°C and humidity < 70%.

Calibration Equipment used (M&TE critical for calibration)

Table with 4 columns: Primary Standards, ID #, Cal Date (Certificate No.), Scheduled Calibration. Lists equipment like Power meter E4419B, Power sensor E4412A, Reference 3 dB Attenuator, etc.

Table with 4 columns: Secondary Standards, ID #, Check Date (in house), Scheduled Check. Lists equipment like RF generator HP 8648C, Network Analyzer HP 8753E.

Calibrated by: Katja Pokovic, Technical Manager
Approved by: Fin Bornholt, R&D Director

Issued: September 24, 2008

This calibration certificate shall not be reproduced except in full without written approval of the laboratory.



Calibration Laboratory of
Schmid & Partner
Engineering AG
Zeughausstrasse 43, 8004 Zurich, Switzerland



S Schweizerischer Kalibrierdienst
C Service suisse d'étalonnage
S Servizio svizzero di taratura
S Swiss Calibration Service

Accredited by the Swiss Accreditation Service (SAS)
The Swiss Accreditation Service is one of the signatories to the EA
Multilateral Agreement for the recognition of calibration certificates

Accreditation No.: SCS 108

Glossary:

| | |
|--------------------------|--|
| TSL | tissue simulating liquid |
| NORM _{x,y,z} | sensitivity in free space |
| ConvF | sensitivity in TSL / NORM _{x,y,z} |
| DCP | diode compression point |
| Polarization φ | φ rotation around probe axis |
| Polarization ϑ | ϑ rotation around an axis that is in the plane normal to probe axis (at measurement center), i.e., $\vartheta = 0$ is normal to probe axis |

Calibration is Performed According to the Following Standards:

- IEEE Std 1528-2003, "IEEE Recommended Practice for Determining the Peak Spatial-Averaged Specific Absorption Rate (SAR) in the Human Head from Wireless Communications Devices: Measurement Techniques", December 2003
- IEC 62209-1, "Procedure to measure the Specific Absorption Rate (SAR) for hand-held devices used in close proximity to the ear (frequency range of 300 MHz to 3 GHz)", February 2005

Methods Applied and Interpretation of Parameters:

- NORM_{x,y,z}:** Assessed for E-field polarization $\vartheta = 0$ ($f \leq 900$ MHz in TEM-cell; $f > 1800$ MHz: R22 waveguide). NORM_{x,y,z} are only intermediate values, i.e., the uncertainties of NORM_{x,y,z} does not effect the E²-field uncertainty inside TSL (see below ConvF).
- NORM(f)_{x,y,z} = NORM_{x,y,z} * frequency_response** (see Frequency Response Chart). This linearization is implemented in DASY4 software versions later than 4.2. The uncertainty of the frequency response is included in the stated uncertainty of ConvF.
- DCP_{x,y,z}:** DCP are numerical linearization parameters assessed based on the data of power sweep (no uncertainty required). DCP does not depend on frequency nor media.
- ConvF and Boundary Effect Parameters:** Assessed in flat phantom using E-field (or Temperature Transfer Standard for $f \leq 800$ MHz) and inside waveguide using analytical field distributions based on power measurements for $f > 800$ MHz. The same setups are used for assessment of the parameters applied for boundary compensation (alpha, depth) of which typical uncertainty values are given. These parameters are used in DASY4 software to improve probe accuracy close to the boundary. The sensitivity in TSL corresponds to NORM_{x,y,z} * ConvF whereby the uncertainty corresponds to that given for ConvF. A frequency dependent ConvF is used in DASY version 4.4 and higher which allows extending the validity from ± 50 MHz to ± 100 MHz.
- Spherical isotropy (3D deviation from isotropy):** in a field of low gradients realized using a flat phantom exposed by a patch antenna.
- Sensor Offset:** The sensor offset corresponds to the offset of virtual measurement center from the probe tip (on probe axis). No tolerance required.



ET3DV6 SN:1788

September 23, 2008

Probe ET3DV6

SN:1788

| | |
|------------------|--------------------|
| Manufactured: | May 28, 2003 |
| Last calibrated: | September 26, 2007 |
| Recalibrated: | September 23, 2008 |

Calibrated for DASYS Systems

(Note: non-compatible with DASYS2 system!)



ET3DV6 SN:1788

September 23, 2008

DASY - Parameters of Probe: ET3DV6 SN:1788

Sensitivity in Free Space^A

Diode Compression^B

| | | | | |
|-------|--------------|-----------------------|-------|-------|
| NormX | 1.73 ± 10.1% | μV/(V/m) ² | DCP X | 95 mV |
| NormY | 1.59 ± 10.1% | μV/(V/m) ² | DCP Y | 98 mV |
| NormZ | 1.72 ± 10.1% | μV/(V/m) ² | DCP Z | 91 mV |

Sensitivity in Tissue Simulating Liquid (Conversion Factors)

Please see Page 8.

Boundary Effect

TSL 900 MHz Typical SAR gradient: 5 % per mm

| | | | |
|---|------------------------------|--------|--------|
| Sensor Center to Phantom Surface Distance | | 3.7 mm | 4.7 mm |
| SAR _{be} [%] | Without Correction Algorithm | 10.6 | 6.8 |
| SAR _{be} [%] | With Correction Algorithm | 0.8 | 0.3 |

TSL 1750 MHz Typical SAR gradient: 10 % per mm

| | | | |
|---|------------------------------|--------|--------|
| Sensor Center to Phantom Surface Distance | | 3.7 mm | 4.7 mm |
| SAR _{be} [%] | Without Correction Algorithm | 8.8 | 4.9 |
| SAR _{be} [%] | With Correction Algorithm | 0.7 | 0.6 |

Sensor Offset

Probe Tip to Sensor Center 2.7 mm

The reported uncertainty of measurement is stated as the standard uncertainty of measurement multiplied by the coverage factor k=2, which for a normal distribution corresponds to a coverage probability of approximately 95%.

^A The uncertainties of NormX,Y,Z do not affect the E²-field uncertainty inside TSL (see Page 8).

^B Numerical linearization parameter: uncertainty not required.



ET3DV6 SN:1788

September 23, 2008

Frequency Response of E-Field

(TEM-Cell:ifi110 EXX, Waveguide: R22)

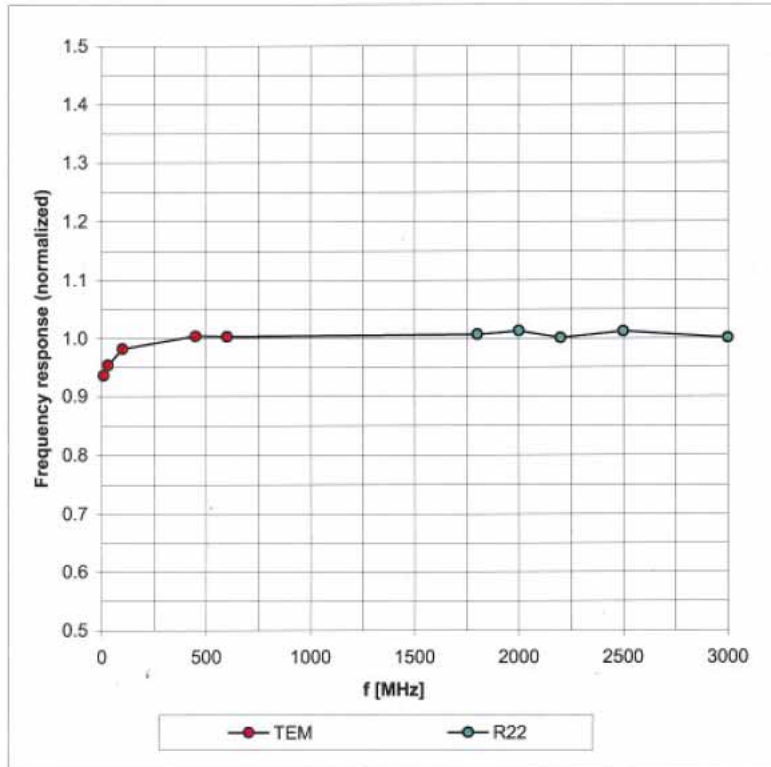

Uncertainty of Frequency Response of E-field: $\pm 6.3\%$ ($k=2$)



ET3DV6 SN:1788

September 23, 2008

Receiving Pattern (ϕ), $\vartheta = 0^\circ$

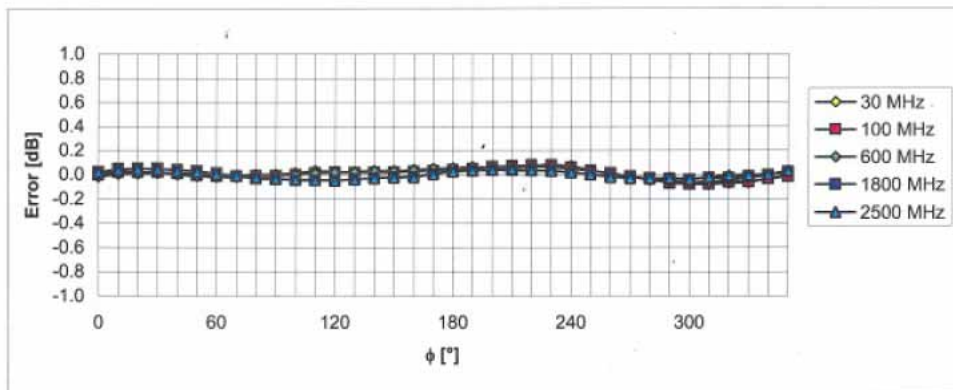
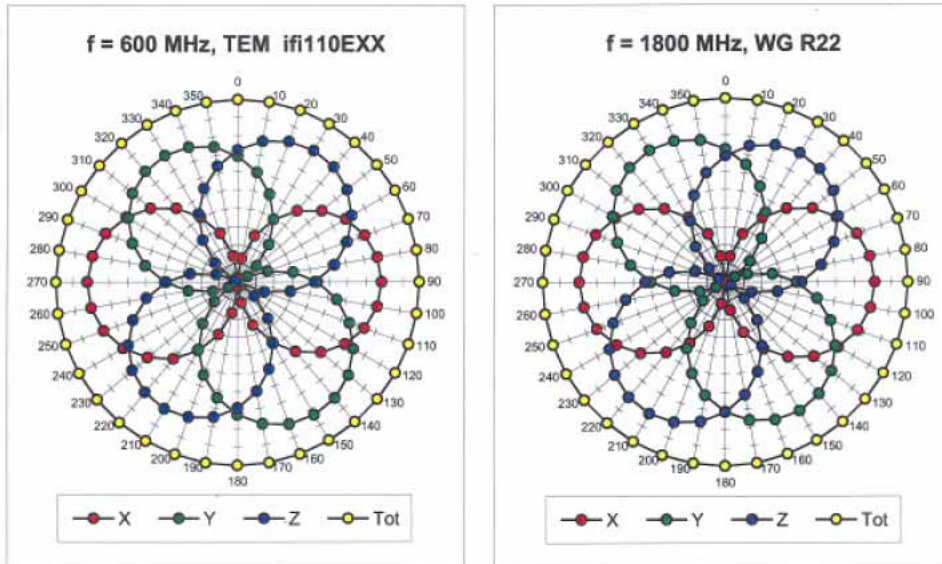

Uncertainty of Axial Isotropy Assessment: $\pm 0.5\%$ ($k=2$)



ET3DV6 SN:1788

September 23, 2008

Dynamic Range f(SAR_{head}) (Waveguide R22, f = 1800 MHz)

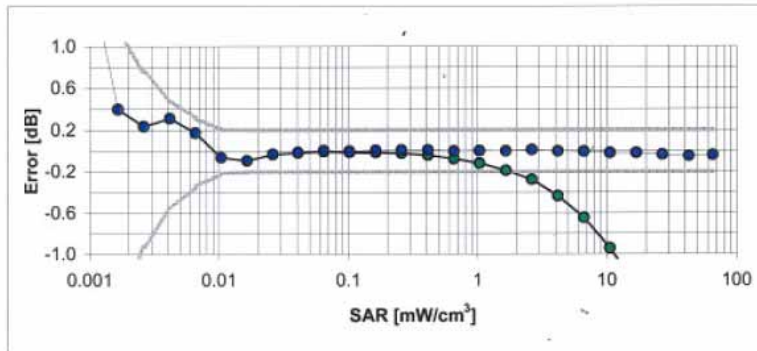
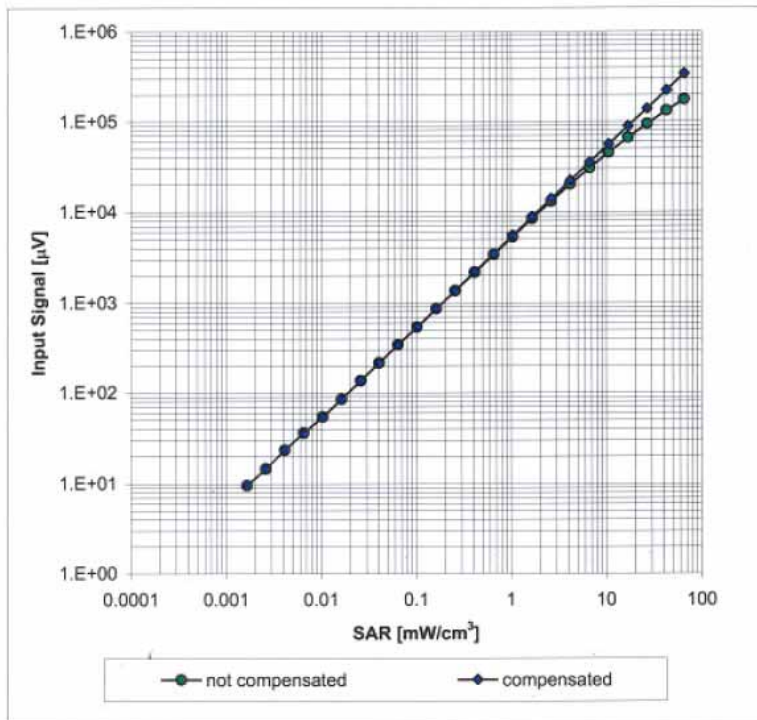

Uncertainty of Linearity Assessment: $\pm 0.6\%$ (k=2)

Conversion Factor Assessment

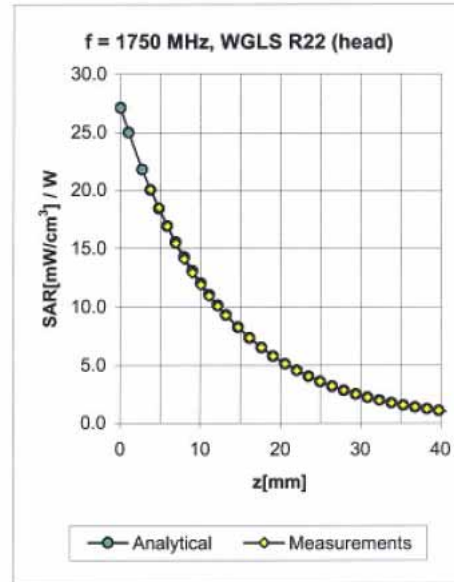
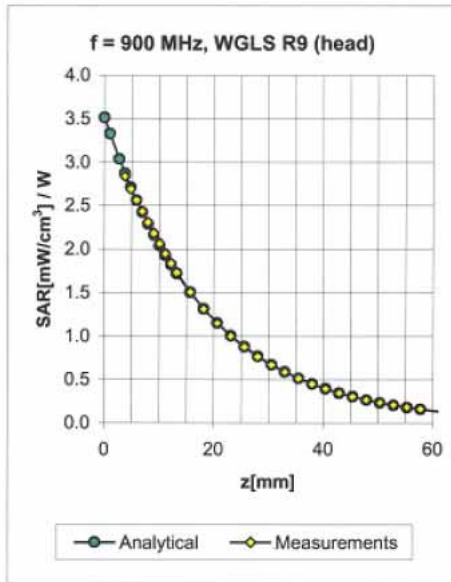

| f [MHz] | Validity [MHz] ^c | TSL | Permittivity | Conductivity | Alpha | Depth | ConvF Uncertainty |
|---------|-----------------------------|------|--------------|--------------|-------|-------|--------------------|
| 900 | ± 50 / ± 100 | Head | 41.5 ± 5% | 0.97 ± 5% | 0.44 | 2.65 | 6.55 ± 11.0% (k=2) |
| 1750 | ± 50 / ± 100 | Head | 40.1 ± 5% | 1.37 ± 5% | 0.68 | 1.98 | 5.59 ± 11.0% (k=2) |
| 1950 | ± 50 / ± 100 | Head | 40.0 ± 5% | 1.40 ± 5% | 0.75 | 1.75 | 5.13 ± 11.0% (k=2) |
| 2450 | ± 50 / ± 100 | Head | 39.2 ± 5% | 1.80 ± 5% | 0.80 | 1.45 | 4.68 ± 11.0% (k=2) |
| 900 | ± 50 / ± 100 | Body | 55.0 ± 5% | 1.05 ± 5% | 0.50 | 2.48 | 6.34 ± 11.0% (k=2) |
| 1750 | ± 50 / ± 100 | Body | 53.4 ± 5% | 1.49 ± 5% | 0.63 | 2.33 | 4.87 ± 11.0% (k=2) |
| 1950 | ± 50 / ± 100 | Body | 53.3 ± 5% | 1.52 ± 5% | 0.74 | 1.99 | 4.73 ± 11.0% (k=2) |
| 2450 | ± 50 / ± 100 | Body | 52.7 ± 5% | 1.95 ± 5% | 0.94 | 1.75 | 3.98 ± 11.0% (k=2) |

^c The validity of ± 100 MHz only applies for DASY v4.4 and higher (see Page 2). The uncertainty is the RSS of the ConvF uncertainty at calibration frequency and the uncertainty for the indicated frequency band.



ET3DV6 SN:1788

September 23, 2008

Deviation from Isotropy in HSL

Error (ϕ , θ), $f = 900$ MHz

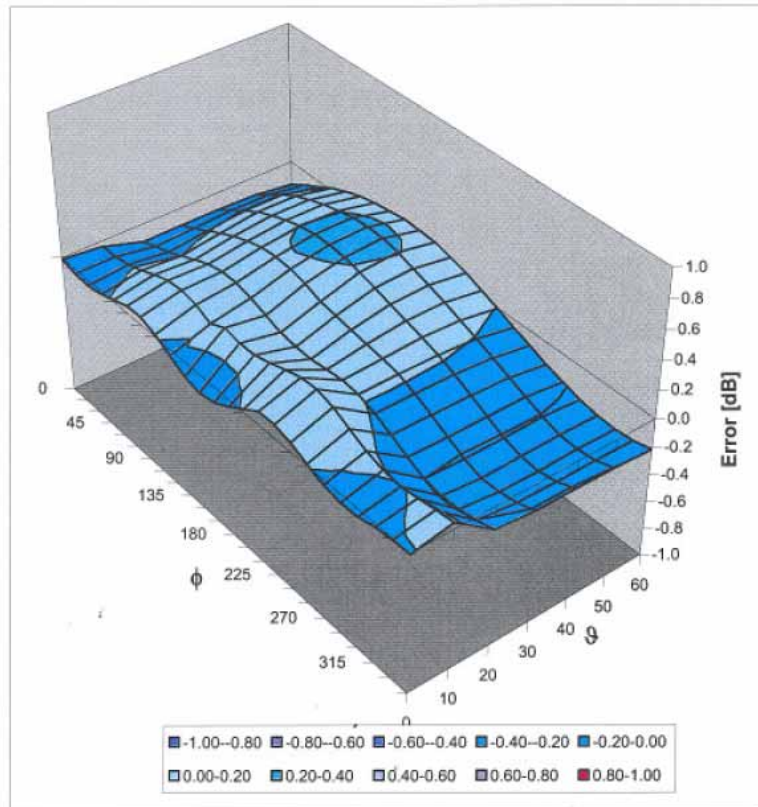

Uncertainty of Spherical Isotropy Assessment: $\pm 2.6\%$ ($k=2$)



Calibration Laboratory of Schmid & Partner Engineering AG Zeughausstrasse 43, 8004 Zurich, Switzerland



S Schweizerischer Kalibrierdienst
S Service suisse d'etalonnage
S Servizio svizzero di taratura
S Swiss Calibration Service

Accredited by the Swiss Accreditation Service (SAS)
The Swiss Accreditation Service is one of the signatories to the EA Multilateral Agreement for the recognition of calibration certificates

Accreditation No.: SCS 108

Client Sporton (Auden)

Certificate No: EX3-3514_Jan09

CALIBRATION CERTIFICATE

Object: EX3DV3 - SN:3514
Calibration procedure(s): QA CAL-01.v6, QA CAL-14.v3 and QA CAL-23.v3
Calibration date: January 21, 2009
Condition of the calibrated item: In Tolerance

This calibration certificate documents the traceability to national standards, which realize the physical units of measurements (SI). The measurements and the uncertainties with confidence probability are given on the following pages and are part of the certificate.

All calibrations have been conducted in the closed laboratory facility: environment temperature (22 ± 3)°C and humidity < 70%.

Calibration Equipment used (M&TE critical for calibration)

Table with 4 columns: Primary Standards, ID #, Cal Date (Certificate No.), Scheduled Calibration. Lists various power meters, sensors, and attenuators with their respective IDs and calibration dates.

Table with 4 columns: Secondary Standards, ID #, Check Date (in house), Scheduled Check. Lists RF generator and Network Analyzer with their IDs and check dates.

Calibrated by: Katja Pokovic, Technical Manager
Approved by: Niels Kuster, Quality Manager

Issued: January 21, 2009

This calibration certificate shall not be reproduced except in full without written approval of the laboratory.



Calibration Laboratory of
Schmid & Partner
Engineering AG
Zeughausstrasse 43, 8004 Zurich, Switzerland



S Schweizerischer Kalibrierdienst
C Service suisse d'étalonnage
S Servizio svizzero di taratura
S Swiss Calibration Service

Accredited by the Swiss Accreditation Service (SAS)
The Swiss Accreditation Service is one of the signatories to the EA
Multilateral Agreement for the recognition of calibration certificates

Accreditation No.: SCS 108

Glossary:

| | |
|--------------------------|--|
| TSL | tissue simulating liquid |
| NORM _{x,y,z} | sensitivity in free space |
| ConvF | sensitivity in TSL / NORM _{x,y,z} |
| DCP | diode compression point |
| Polarization φ | φ rotation around probe axis |
| Polarization ϑ | ϑ rotation around an axis that is in the plane normal to probe axis (at measurement center), i.e., $\vartheta = 0$ is normal to probe axis |

Calibration is Performed According to the Following Standards:

- IEEE Std 1528-2003, "IEEE Recommended Practice for Determining the Peak Spatial-Averaged Specific Absorption Rate (SAR) in the Human Head from Wireless Communications Devices: Measurement Techniques", December 2003
- IEC 62209-1, "Procedure to measure the Specific Absorption Rate (SAR) for hand-held devices used in close proximity to the ear (frequency range of 300 MHz to 3 GHz)", February 2005

Methods Applied and Interpretation of Parameters:

- NORM_{x,y,z}**: Assessed for E-field polarization $\vartheta = 0$ ($f \leq 900$ MHz in TEM-cell; $f > 1800$ MHz: R22 waveguide). NORM_{x,y,z} are only intermediate values, i.e., the uncertainties of NORM_{x,y,z} does not effect the E²-field uncertainty inside TSL (see below ConvF).
- NORM(f)_{x,y,z}** = NORM_{x,y,z} * frequency_response (see Frequency Response Chart). This linearization is implemented in DASY4 software versions later than 4.2. The uncertainty of the frequency response is included in the stated uncertainty of ConvF.
- DCP_{x,y,z}**: DCP are numerical linearization parameters assessed based on the data of power sweep (no uncertainty required). DCP does not depend on frequency nor media.
- ConvF and Boundary Effect Parameters**: Assessed in flat phantom using E-field (or Temperature Transfer Standard for $f \leq 800$ MHz) and inside waveguide using analytical field distributions based on power measurements for $f > 800$ MHz. The same setups are used for assessment of the parameters applied for boundary compensation (alpha, depth) of which typical uncertainty values are given. These parameters are used in DASY4 software to improve probe accuracy close to the boundary. The sensitivity in TSL corresponds to NORM_{x,y,z} * ConvF whereby the uncertainty corresponds to that given for ConvF. A frequency dependent ConvF is used in DASY version 4.4 and higher which allows extending the validity from ± 50 MHz to ± 100 MHz.
- Spherical isotropy (3D deviation from isotropy)**: in a field of low gradients realized using a flat phantom exposed by a patch antenna.
- Sensor Offset**: The sensor offset corresponds to the offset of virtual measurement center from the probe tip (on probe axis). No tolerance required.



EX3DV3 SN:3514

January 21, 2009

Probe EX3DV3

SN:3514

| | |
|------------------|-------------------|
| Manufactured: | December 15, 2002 |
| Last calibrated: | January 31, 2008 |
| Recalibrated: | January 21, 2009 |

Calibrated for DASY Systems

(Note: non-compatible with DASY2 system!)



EX3DV3 SN:3514

January 21, 2009

DASY - Parameters of Probe: EX3DV3 SN:3514

| | | | | |
|--|--------------|-----------------------|--------------------------------|-------|
| Sensitivity in Free Space ^A | | | Diode Compression ^B | |
| NormX | 0.66 ± 10.1% | μV/(V/m) ² | DCP X | 91 mV |
| NormY | 0.70 ± 10.1% | μV/(V/m) ² | DCP Y | 94 mV |
| NormZ | 0.60 ± 10.1% | μV/(V/m) ² | DCP Z | 95 mV |

Sensitivity in Tissue Simulating Liquid (Conversion Factors)

Please see Page 8.

Boundary Effect

| | | | | |
|-----|--|----------------------------------|--------|--|
| TSL | 900 MHz | Typical SAR gradient: 5 % per mm | | |
| | Sensor Center to Phantom Surface Distance | 2.0 mm | 3.0 mm | |
| | SAR _{be} [%] Without Correction Algorithm | 7.7 | 4.4 | |
| | SAR _{be} [%] With Correction Algorithm | 0.8 | 0.3 | |

| | | | | |
|-----|--|-----------------------------------|--------|--|
| TSL | 1810 MHz | Typical SAR gradient: 10 % per mm | | |
| | Sensor Center to Phantom Surface Distance | 2.0 mm | 3.0 mm | |
| | SAR _{be} [%] Without Correction Algorithm | 6.2 | 3.4 | |
| | SAR _{be} [%] With Correction Algorithm | 0.7 | 0.3 | |

Sensor Offset

Probe Tip to Sensor Center 1.0 mm

The reported uncertainty of measurement is stated as the standard uncertainty of measurement multiplied by the coverage factor k=2, which for a normal distribution corresponds to a coverage probability of approximately 95%.

^A The uncertainties of NormX,Y,Z do not affect the E²-field uncertainty inside TSL (see Page 8).

^B Numerical linearization parameter; uncertainty not required.



EX3DV3 SN:3514

January 21, 2009

Frequency Response of E-Field

(TEM-Cell: ifi110 EXX, Waveguide: R22)

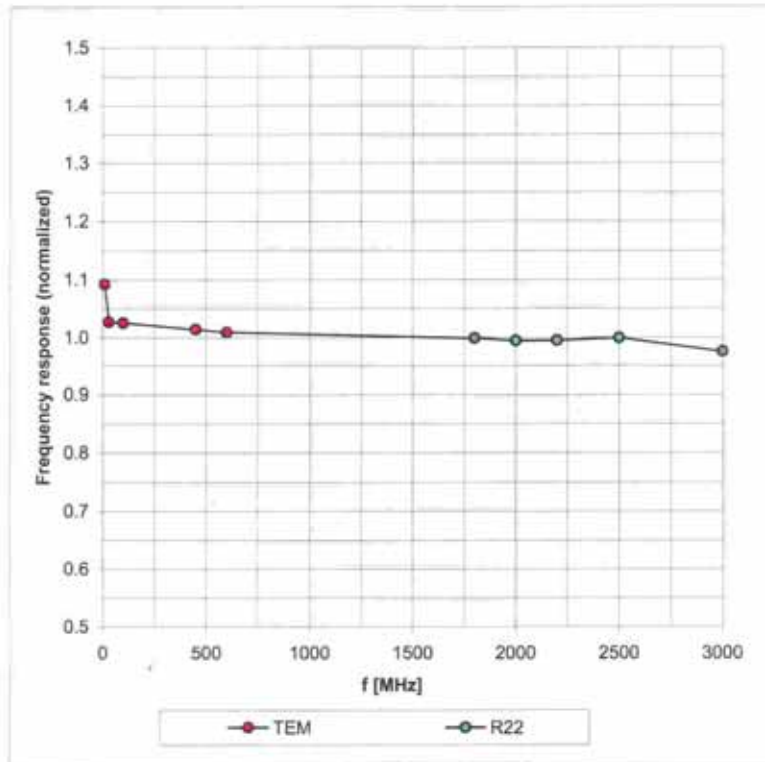

Uncertainty of Frequency Response of E-field: $\pm 6.3\%$ (k=2)



EX3DV3 SN:3514

January 21, 2009

Receiving Pattern (ϕ), $\vartheta = 0^\circ$

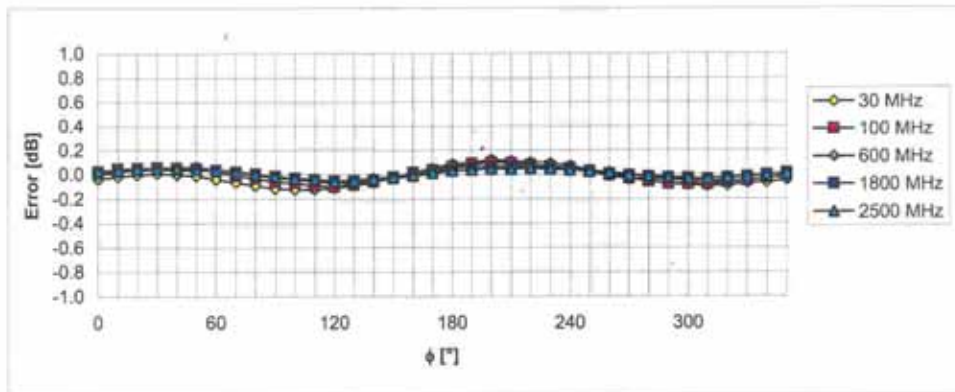
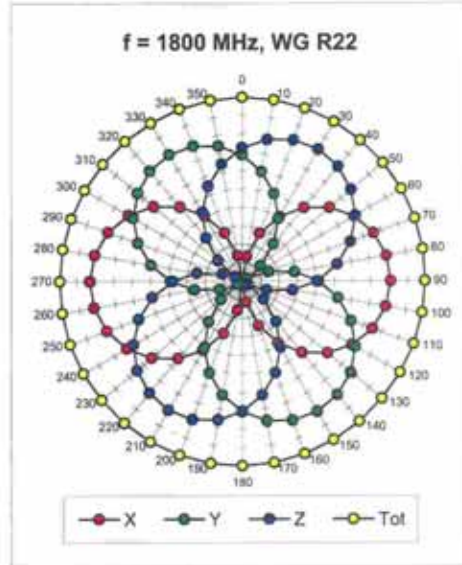
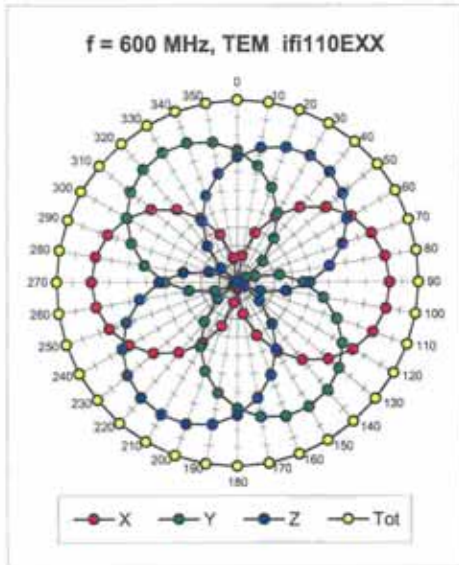

Uncertainty of Axial Isotropy Assessment: $\pm 0.5\%$ ($k=2$)



EX3DV3 SN:3514

January 21, 2009

Dynamic Range $f(\text{SAR}_{\text{head}})$ (Waveguide R22, $f = 1800 \text{ MHz}$)

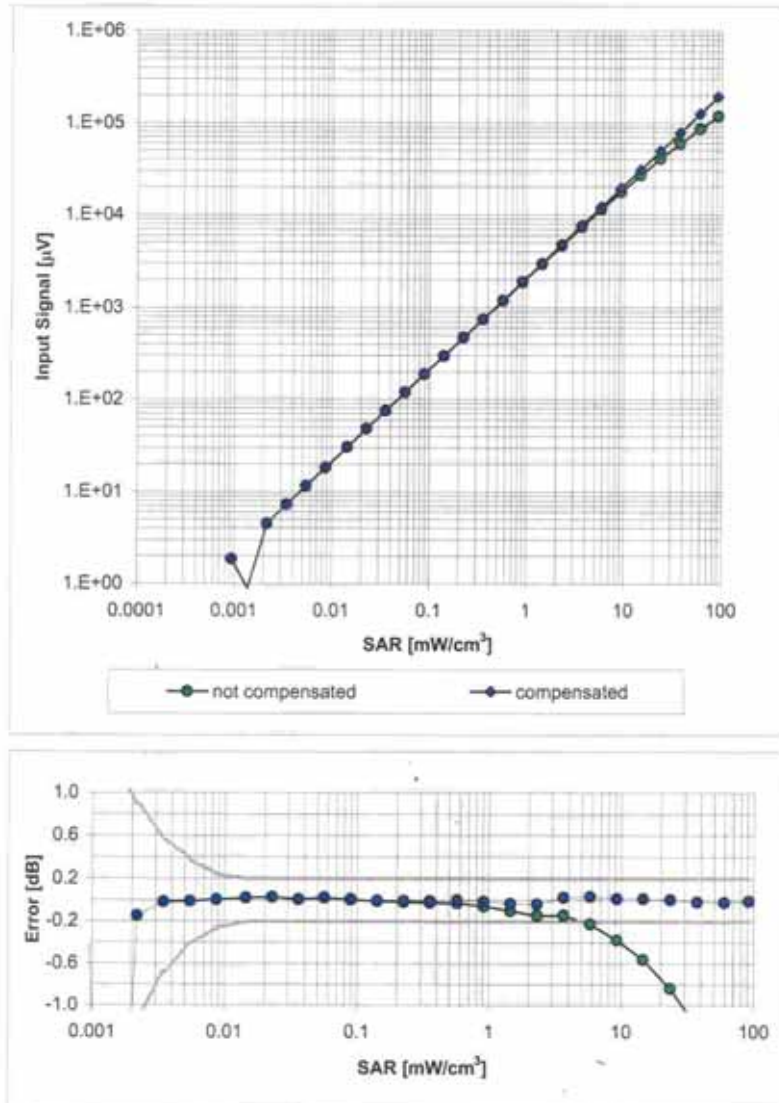

Uncertainty of Linearity Assessment: $\pm 0.6\%$ ($k=2$)



EX3DV3 SN:3514

January 21, 2009

Conversion Factor Assessment

| f [MHz] | Validity [MHz] ^c | TSL | Permittivity | Conductivity | Alpha | Depth | ConvF Uncertainty |
|---------|-----------------------------|------|--------------|--------------|-------|-------|--------------------|
| 900 | ± 50 / ± 100 | Head | 41.5 ± 5% | 0.97 ± 5% | 0.45 | 0.76 | 9.31 ± 11.0% (k=2) |
| 1810 | ± 50 / ± 100 | Head | 40.0 ± 5% | 1.40 ± 5% | 0.60 | 0.63 | 8.16 ± 11.0% (k=2) |
| 2300 | ± 50 / ± 100 | Head | 39.4 ± 5% | 1.71 ± 5% | 0.53 | 0.63 | 7.78 ± 11.0% (k=2) |
| 2600 | ± 50 / ± 100 | Head | 39.0 ± 5% | 1.96 ± 5% | 0.16 | 2.19 | 7.34 ± 11.0% (k=2) |
| 3500 | ± 50 / ± 100 | Head | 37.9 ± 5% | 2.91 ± 5% | 0.50 | 0.86 | 6.89 ± 13.1% (k=2) |
| 5200 | ± 50 / ± 100 | Head | 36.0 ± 5% | 4.66 ± 5% | 0.40 | 1.70 | 4.78 ± 13.1% (k=2) |
| 5300 | ± 50 / ± 100 | Head | 35.9 ± 5% | 4.76 ± 5% | 0.40 | 1.70 | 4.40 ± 13.1% (k=2) |
| 5500 | ± 50 / ± 100 | Head | 35.6 ± 5% | 4.96 ± 5% | 0.40 | 1.70 | 4.22 ± 13.1% (k=2) |
| 5600 | ± 50 / ± 100 | Head | 35.5 ± 5% | 5.07 ± 5% | 0.40 | 1.70 | 4.13 ± 13.1% (k=2) |
| 5800 | ± 50 / ± 100 | Head | 35.3 ± 5% | 5.27 ± 5% | 0.40 | 1.70 | 4.13 ± 13.1% (k=2) |
| | | | | | | | |
| 900 | ± 50 / ± 100 | Body | 55.0 ± 5% | 1.05 ± 5% | 0.42 | 0.76 | 9.41 ± 11.0% (k=2) |
| 1810 | ± 50 / ± 100 | Body | 53.3 ± 5% | 1.52 ± 5% | 0.85 | 0.56 | 8.18 ± 11.0% (k=2) |
| 2300 | ± 50 / ± 100 | Body | 52.8 ± 5% | 1.85 ± 5% | 0.18 | 4.17 | 7.60 ± 11.0% (k=2) |
| 2600 | ± 50 / ± 100 | Body | 52.5 ± 5% | 2.16 ± 5% | 0.34 | 1.14 | 7.20 ± 11.0% (k=2) |
| 3500 | ± 50 / ± 100 | Body | 51.3 ± 5% | 3.31 ± 5% | 0.53 | 0.81 | 6.40 ± 13.1% (k=2) |
| 5200 | ± 50 / ± 100 | Body | 49.0 ± 5% | 5.30 ± 5% | 0.45 | 1.75 | 4.29 ± 13.1% (k=2) |
| 5300 | ± 50 / ± 100 | Body | 48.9 ± 5% | 5.42 ± 5% | 0.45 | 1.75 | 3.94 ± 13.1% (k=2) |
| 5500 | ± 50 / ± 100 | Body | 48.6 ± 5% | 5.65 ± 5% | 0.45 | 1.75 | 3.88 ± 13.1% (k=2) |
| 5600 | ± 50 / ± 100 | Body | 48.5 ± 5% | 5.77 ± 5% | 0.45 | 1.75 | 3.89 ± 13.1% (k=2) |
| 5800 | ± 50 / ± 100 | Body | 48.2 ± 5% | 6.00 ± 5% | 0.45 | 1.75 | 3.85 ± 13.1% (k=2) |

^c The validity of ± 100 MHz only applies for DASY v4.4 and higher (see Page 2). The uncertainty is the RSS of the ConvF uncertainty at calibration frequency and the uncertainty for the indicated frequency band.



EX3DV3 SN:3514

January 21, 2009

Deviation from Isotropy in HSL Error (ϕ , θ), $f = 900$ MHz

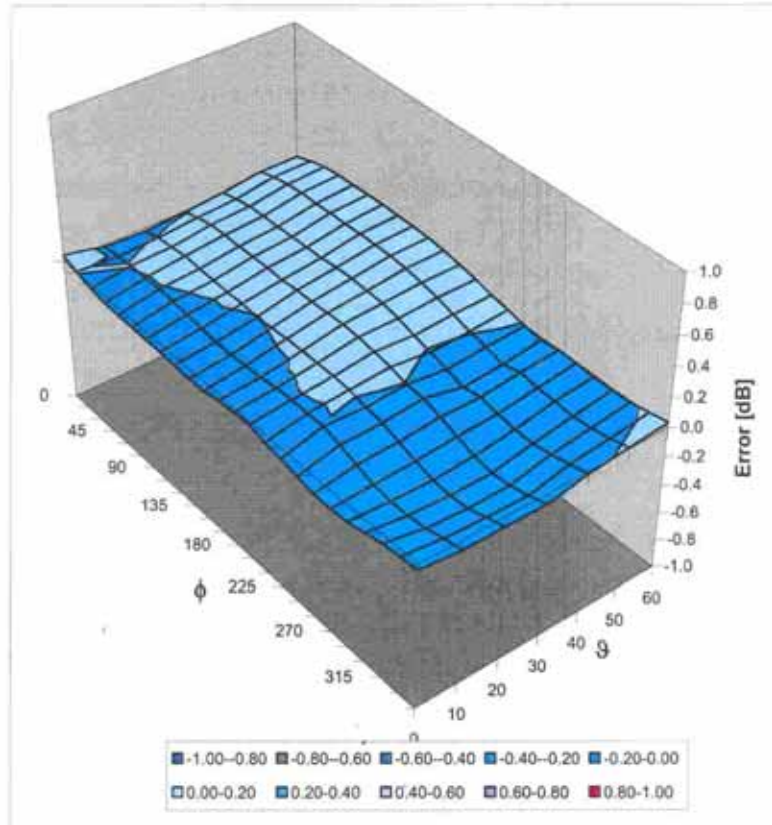

Uncertainty of Spherical Isotropy Assessment: $\pm 2.6\%$ ($k=2$)