

# FCC Test Report

**EQUIPMENT** : Mobile Computer  
**BRAND NAME** : Symbol  
**MODEL NAME** : FR6074  
**FCC ID** : H9PFR6074  
**STANDARD** : 47 CFR Part 2, 22(H), 24(E)  
**CLASSIFICATION** : PCS Licensed transmitter Held to Ear (PCE)  
**Tx/Rx FREQUENCY RANGE** : GSM850 : 824.2 ~ 848.8 MHz /  
869.2 ~ 893.8 MHz  
GSM1900 : 1850.2 ~ 1909.8 MHz /  
1930.2 ~ 1989.8 MHz  
**MAX. ERP/EIRP POWER** : GSM850(GSM) : 0.34 W  
GSM850(EDGE) : 0.08 W  
GSM1900(GSM) : 0.78 W  
GSM1900(EDGE) : 0.30 W  
**EMISSION DESIGNATOR** : GSM : 246KGXW  
EDGE : 246KG7W  
**APPLICANT** : Symbol Technologies, Inc., A Motorola Company  
230 Victoria Street #12-06/10 Bugis Junction Office Tower  
Singapore 188024

The product sample received on Oct. 31, 2009 and completely tested on Feb. 13, 2009. We, SPORTON INTERNATIONAL INC., would like to declare that the tested sample has been evaluated in accordance with the procedures given in ANSI C63.4-2003 and shown compliance with the applicable technical standards.

The test results in this report apply exclusively to the tested model / sample. Without written approval of SPORTON INTERNATIONAL INC., the test report shall not be reproduced except in full.



Reviewed by: Roy Wu / Manager



**SPORTON INTERNATIONAL INC.**

No. 52, Hwa Ya 1<sup>st</sup> Rd., Hwa Ya Technology Park, Kwei-Shan Hsiang, Tao Yuan Hsien, Taiwan, R.O.C.



# TABLE OF CONTENTS

**REVISION HISTORY..... 3**

**SUMMARY OF TEST RESULT ..... 4**

**1 GENERAL DESCRIPTION ..... 5**

    1.1 Applicant..... 5

    1.2 Manufacturer ..... 5

    1.3 Feature of Equipment Under Test..... 6

    1.4 Testing Site ..... 8

    1.5 Applied Standards ..... 8

    1.6 Ancillary Equipment List..... 8

**2 TEST CONFIGURATION OF EQUIPMENT UNDER TEST ..... 9**

    2.1 Test Mode..... 9

    2.2 Connection Diagram of Test System ..... 10

**3 TEST RESULT..... 12**

    3.1 Conducted Output Power Measurement..... 12

    3.2 Effective Radiated Power and Effective Isotropic Radiated Power Measurement ..... 14

    3.3 Occupied Bandwidth and Band Edge Measurement ..... 18

    3.4 Conducted Emission Measurement ..... 27

    3.5 Field Strength of Spurious Radiation Measurement ..... 38

    3.6 Frequency Stability Measurement..... 55

**4 LIST OF MEASURING EQUIPMENTS ..... 58**

**5 UNCERTAINTY OF EVALUATION ..... 59**

**6 CERTIFICATION OF TAF ACCREDITATION ..... 60**

**APPENDIX A. PHOTOGRAPHS OF EUT**

**APPENDIX B. SETUP PHOTOGRAPHS**



### REVISION HISTORY

REPORT NO.	VERSION	DESCRIPTION	ISSUED DATE
FG803027-01	Rev. 01	Initial issue of report	Mar. 17, 2009



### SUMMARY OF TEST RESULT

Report Section	FCC Rule	IC Rule	Description	Limit	Result
3.1	§2.1046	N/A	Conducted Output Power	N/A	PASS
3.2	§22.913(a)(2)	RSS-132(4.4) SRSP-503(5.1.3)	Effective Radiated Power	< 7 Watts for FCC (<6.3 Watts for IC)	PASS
3.3	§24.232(c)	RSS-133 (6.4) SRSP-510(5.1.2)	Equivalent Isotropic Radiated Power	< 2 Watts	PASS
3.4	§2.1049 §22.917(a) §24.238(a)	N/A	Occupied Bandwidth	N/A	PASS
3.5	§2.1051 §22.917(a) §24.238(a)	RSS-132 (4.5.1) RSS-133 (6.5.1)	Band Edge Measurement	< 43+10log <sub>10</sub> (P[Watts])	PASS
3.6	§2.1051 §22.917(a) §24.238(a)	RSS-132 (4.5.1) RSS-133 (6.5.1)	Conducted Emission	< 43+10log <sub>10</sub> (P[Watts])	PASS
3.7	§2.1053 §22.917(a) §24.238(a)	RSS-132 (4.5.1) RSS-133 (6.5.1)	Field Strength of Spurious Radiation	< 43+10log <sub>10</sub> (P[Watts])	PASS
3.8	§2.1055 §22.355 §24.235	RSS-132(4.3) RSS-133(6.3)	Frequency Stability for Temperature & Voltage	< 2.5 ppm	PASS



# **1 General Description**

## **1.1 Applicant**

**Symbol Technologies, Inc., A Motorola Company**

230 Victoria Street #12-06/10 Bugis Junction Office Tower Singapore 188024

## **1.2 Manufacturer**

**Inventec Appliances Corp.**

No. 37, Wugong 5th Road, Wugu Industrial Park, Taipei Country 248, Taiwan, R.O.C.

### 1.3 Feature of Equipment Under Test

Product Feature & Specification	
Equipment	Mobile Computer
Brand Name	Symbol
Model Name	FR6074
FCC ID	H9PFR6074
Tx Frequency	GSM850 : 824 MHz ~ 849 MHz GSM1900 : 1850 MHz ~ 1910 MHz
Rx Frequency	GSM850 : 869 MHz ~ 894 MHz GSM1900 : 1930 MHz ~ 1990 MHz
Maximum Output Power to Antenna	GSM850 : 32.16 dBm GSM1900 : 29.01 dBm
Maximum ERP/EIRP	GSM850(GSM) : 0.34 W ( 25.30 dBm ) GSM850(EDGE) : 0.08 W ( 19.07 dBm ) GSM1900(GSM) : 0.78 W ( 28.92 dBm ) GSM1900(EDGE) : 0.30 W ( 24.81 dBm )
Antenna Type	Fixed Internal Antenna
HW Version	DVT
SW Version	Modem: 0024-010709-M OS: Handy-DVT1-0.31.0057-020209-WWE-H
GPRS / EGPRS Multislot class	12
Type of Modulation	GSM / GPRS : GMSK EDGE : 8PSK
Type of Emission	GSM : 246KGXW EDGE : 246KG7W
EUT Stage	Identical Prototype

**Accessories List:**

<b>Cradle</b>	<b>Brand Name</b>	Symbol
	<b>Model Name</b>	CRD7X00-1
	<b>Power Rating</b>	12Vdc, 3.33A
<b>Cradle Adapter</b>	<b>Brand Name</b>	HIPRO
	<b>Model Name</b>	HP-O2040D43
	<b>Power Rating</b>	I/P: 100-240Vac, 50-60Hz, 1.5A; O/P: 12V, 3.33A
	<b>Power Cord Type</b>	1.8 meter shielded cable with ferrite core
<b>Product Charging Adapter</b>	<b>Brand Name</b>	MOTOROLA
	<b>Model Name</b>	EADP-16BB A
	<b>Power Rating</b>	I/P: 100-240Vac, 50-60Hz, 0.4A; O/P: 5.4V, 3A
<b>Product Charging Cable 1</b>	<b>Power Cord Type</b>	1.83 meter shielded cable without ferrite core
	<b>Brand Name</b>	MOTOROLA
	<b>Part Number</b>	25-102775-01R
<b>Product Charging Cable 2</b>	<b>Power Rating</b>	I/P: 5.4V, 3A
	<b>Power Cord Type</b>	1.35 meter non-shielded cable with ferrite core
	<b>Brand Name</b>	MOTOROLA
<b>Product Charging Cable 2</b>	<b>Part Number</b>	25-118708-01R
	<b>Power Rating</b>	I/P: 5.4V, 3A
	<b>Power Cord Type</b>	1.35 meter non-shielded cable with ferrite core
<b>Battery</b>	<b>Brand Name</b>	MOTOROLA
	<b>Part Number</b>	82-71364-05
	<b>Power Rating</b>	3.7Vdc, 3600mAh, 13.3Wh
	<b>Type</b>	Li-ion
<b>Earphone</b>	<b>Brand Name</b>	Symbol
	<b>Part Number</b>	90-17C28-001R
	<b>Signal Line Type</b>	1.24 meter non-shielded cable without ferrite core
<b>USB Cable</b>	<b>Brand Name</b>	MOTOROLA
	<b>Part Number</b>	25-68596-01R
	<b>Type</b>	1.58 meter shielded cable without ferrite core

**Remark:**

1. The above EUT's information was declared by manufacturer. Please refer to the specifications or user's manual for more detailed description.
2. For accessories equipped with this EUT, please refer to the appendix of the external photo.
3. Product Charging Cable 1 (P/N: 25-102775-01R) and Product Charging Cable 2 (P/N: 25-118708-01R) are exactly the same which was declared by the manufacturer, and only Product Charging Cable 1 (P/N: 25-102775-01R) was performed on all the tests.

## 1.4 Testing Site

<b>Test Site</b>	SPORTON INTERNATIONAL INC.		
<b>Test Site Location</b>	No. 52, Hwa Ya 1 <sup>st</sup> Rd., Hwa Ya Technology Park, Kwei-Shan Hsiang, Tao Yuan Hsien, Taiwan, R.O.C. TEL: +886-3-327-3456 FAX: +886-3-328-4978		
<b>Test Site No.</b>	<b>Sporton Site No.</b>		<b>FCC/IC Registration No.</b>
	TH02-HY	03CH07-HY	TW1022/4086B-1

## 1.5 Applied Standards

According to the specifications of the manufacturer, the EUT must comply with the requirements of the following standards:

- ♦ 47 CFR Part 2, 22(H), 24(E)
- ♦ ANSI C63.4-2003
- ♦ ANSI / TIA / EIA-603-C-2004
- ♦ IC RSS-132, RSS-133

**Remark:**

1. All test items were verified and recorded according to the standards and without any deviation during the test.
2. This EUT has also been tested and complied with the requirements of FCC Part 15, Subpart B (DoC), recorded in a separate test report.

## 1.6 Ancillary Equipment List

Item	Equipment	Trade Name	Model No.	FCC ID	Data Cable	Power Cord
1.	System Simulator	R&S	CMU200	N/A	N/A	Unshielded, 1.8 m
2.	WLAN AP	SMC	SMC-100	N/A	N/A	Unshielded, 1.8 m
3.	BT Base Station	Anritsu	8852B	N/A	N/A	Unshielded, 1.8 m



## 2 Test Configuration of Equipment Under Test

### 2.1 Test Mode

During all testing, EUT is in link mode with base station emulator at maximum power level. The spurious emission measurements were carried out in semi-anechoic chamber with 3-meter test range, and EUT is rotated on three test planes to find out the worst emission.

Frequency range investigated for radiated emission is as follows:

1. 30 MHz to 9000 MHz for GSM850
2. 30MHz to 19000 MHz for GSM1900

Test Modes		
Band	Radiated TCs	Conducted TCs
GSM 850	<ul style="list-style-type: none"> <li>■ GSM Link</li> <li>■ EDGE Link</li> <li>■ GSM Link + BT Link</li> <li>■ GSM Link + WLAN Link</li> </ul>	<ul style="list-style-type: none"> <li>■ GSM Link</li> <li>■ GPRS Link</li> <li>■ EDGE Link</li> </ul>
GSM 1900	<ul style="list-style-type: none"> <li>■ GSM Link</li> <li>■ EDGE Link</li> <li>■ GSM Link + BT Link</li> <li>■ EDGE Link + WLAN Link</li> </ul>	<ul style="list-style-type: none"> <li>■ GSM Link</li> <li>■ GPRS Link</li> <li>■ EDGE Link</li> </ul>

**Note:** The maximum power levels are GSM and EDGE multi-slot class 8 modes, only these modes were used for all tests. The power table is listed as follows:

Band	GSM 850			GSM 1900		
	128	189	251	512	661	810
<b>GSM</b>	<b>32.16</b>	31.99	31.72	28.91	28.96	<b>29.01</b>
<b>GPRS 8</b>	32.11	31.92	31.66	28.92	28.96	28.99
<b>GPRS 10</b>	32.05	31.88	31.59	28.88	28.93	28.94
<b>GPRS 12</b>	32.00	31.83	31.55	28.83	28.92	28.93
<b>EGPRS 8</b>	<b>25.58</b>	25.44	25.24	24.51	24.62	<b>24.63</b>
<b>EGPRS 10</b>	25.57	25.42	25.21	24.49	24.60	24.59
<b>EGPRS 12</b>	25.55	25.40	25.18	24.47	24.58	24.58

## 2.2 Connection Diagram of Test System

<GSM Link Mode>

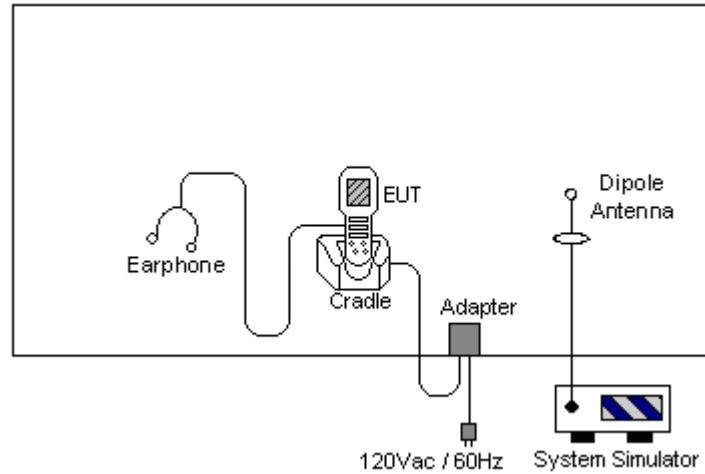

<BT Link Mode>

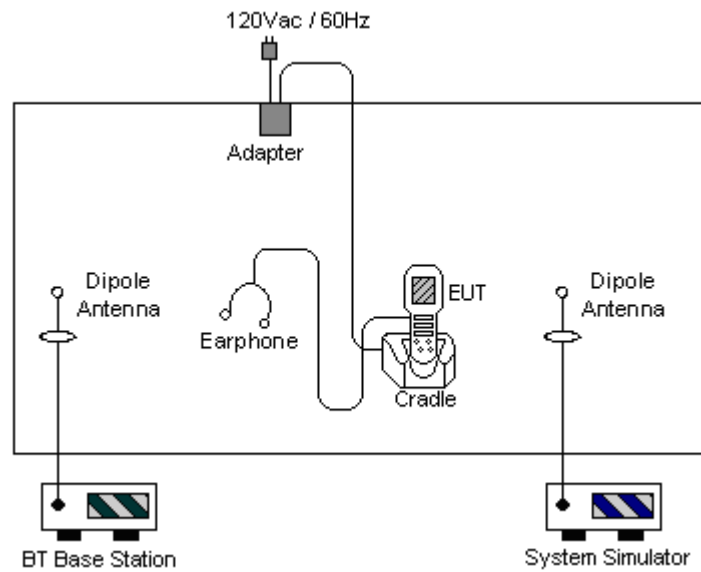

<WLAN Link Mode>

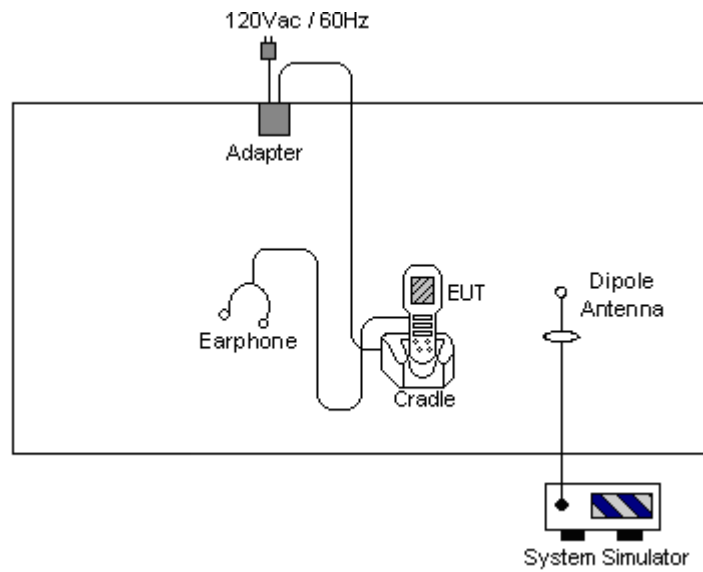

### 3 Test Result

#### 3.1 Conducted Output Power Measurement

##### 3.1.1 Description of the Conducted Output Power Measurement

A base station simulator was used to establish communication with the EUT. Its parameters were set to transmit the maximum power on the EUT. The measured power in the radio frequency on the transmitter output terminals shall be reported.

##### 3.1.2 Measuring Instruments

See list of measuring instruments of this test report.

##### 3.1.3 Test Procedures

1. The transmitter output port was connected to base station.
2. Set EUT at maximum power through base station.
3. Select lowest, middle, and highest channels for each band and different modulation.

##### 3.1.4 Test Setup

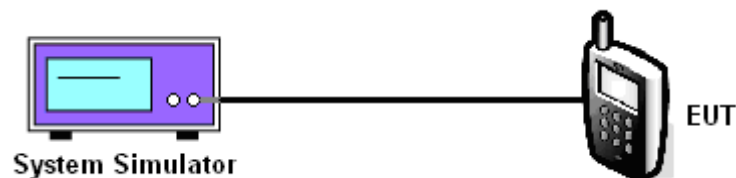

3.1.5 Test Result of Conducted Output Power

Cellular				
Modes	Channel	Frequency (MHz)	Conducted Power	
			(dBm)	(Watts)
GSM	128 (Low)	824.2	32.16	1.64
	189 (Mid)	836.4	31.99	1.58
	251 (High)	848.8	31.72	1.49
EDGE 8	128 (Low)	824.2	25.58	0.36
	189 (Mid)	836.4	25.44	0.35
	251 (High)	848.8	25.24	0.33

PCS				
Modes	Channel	Frequency (MHz)	Conducted Power	
			(dBm)	(Watts)
GSM	512 (Low)	1850.2	28.91	0.78
	661 (Mid)	1880.0	28.96	0.79
	810 (High)	1909.8	29.01	0.80
EDGE 8	512 (Low)	1850.2	24.51	0.28
	661 (Mid)	1880.0	24.62	0.29
	810 (High)	1909.8	24.63	0.29

## 3.2 Effective Radiated Power and Effective Isotropic Radiated Power Measurement

### 3.2.1 Description of the ERP/EIRP Measurement

ERP/EIRP is measured by substitution method according to ANSI / TIA / EIA-603-C-2004. The ERP of mobile transmitters must not exceed 7 Watts and the EIRP of mobile transmitters are limited to 2 Watts.

### 3.2.2 Measuring Instruments

See list of measuring instruments of this test report.

### 3.2.3 Test Procedures

1. The EUT was placed on a turntable with 1.0 meter height in a fully anechoic chamber.
2. The EUT was set at 1.2 meters from the receiving antenna, which was mounted on the antenna tower.
3. The table was rotated 360 degrees to determine the position of the highest radiated power.
4. The height of the receiving antenna is adjusted to look for the maximum ERP/EIRP.
5. Taking the record of maximum ERP/EIRP.
6. A dipole antenna was substituted in place of the EUT and was driven by a signal generator.
7. The conducted power at the terminal of the dipole antenna is measured.
8. Repeat step 3 to step 5 to get the maximum ERP/EIRP of the substitution antenna.
9.  $ERP/EIRP = P_s + E_t - E_s + G_s = P_s + R_t - R_s + G_s$

$P_s$  (dBm) : Input power to substitution antenna.

$G_s$  (dBi or dBd) : Substitution antenna Gain.

$E_t = R_t + AF$

$E_s = R_s + AF$

$AF$  (dB/m) : Receive antenna factor

$R_t$  : The highest received signal in spectrum analyzer for EUT.

$R_s$  : The highest received signal in spectrum analyzer for substitution antenna.

### 3.2.4 Test Setup

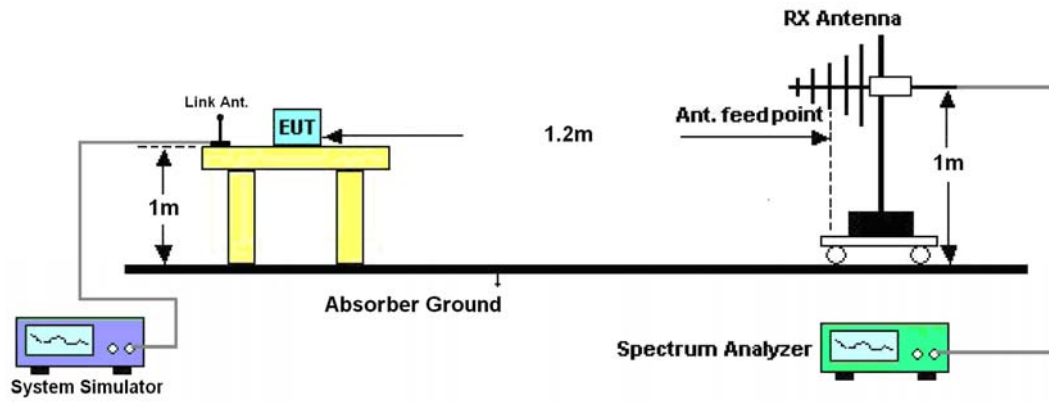



3.2.5 Test Result of ERP

GSM850 (GSM) Radiated Power ERP						
Horizontal Polarization						
Frequency (MHz)	Rt (dBm)	Rs (dBm)	Ps (dBm)	Gs (dBd)	ERP (dBm)	ERP (W)
824.20	-29.59	-48.12	0.00	-1.08	17.45	0.06
836.40	-30.17	-48.28	0.00	-0.93	17.18	0.05
848.80	-30.04	-48.35	0.00	-0.76	17.55	0.06
Vertical Polarization						
Frequency (MHz)	Rt (dBm)	Rs (dBm)	Ps (dBm)	Gs (dBd)	ERP (dBm)	ERP (W)
824.20	-21.59	-47.97	0.00	-1.08	25.30	0.34
836.40	-24.22	-48.01	0.00	-0.93	22.86	0.19
848.80	-25.18	-48.05	0.00	-0.76	22.11	0.16

GSM850 (EDGE 8) Radiated Power ERP						
Horizontal Polarization						
Frequency (MHz)	Rt (dBm)	Rs (dBm)	Ps (dBm)	Gs (dBd)	ERP (dBm)	ERP (W)
824.20	-35.42	-48.12	0.00	-1.08	11.62	0.01
836.40	-35.36	-48.28	0.00	-0.93	11.99	0.02
848.80	-35.73	-48.35	0.00	-0.76	11.86	0.02
Vertical Polarization						
Frequency (MHz)	Rt (dBm)	Rs (dBm)	Ps (dBm)	Gs (dBd)	ERP (dBm)	ERP (W)
824.20	-27.82	-47.97	0.00	-1.08	19.07	0.08
836.40	-31.22	-48.01	0.00	-0.93	15.86	0.04
848.80	-31.07	-48.05	0.00	-0.76	16.22	0.04





3.2.6 Test Result of EIRP

GSM1900 (GSM) Radiated Power EIRP						
Horizontal Polarization						
Frequency (MHz)	Rt (dBm)	Rs (dBm)	Ps (dBm)	Gs (dBi)	EIRP (dBm)	EIRP (W)
1850.20	-25.85	-51.88	0.00	1.96	27.99	0.63
1880.00	-26.28	-52.99	0.00	2.00	28.71	0.74
1909.80	-27.34	-54.28	0.00	1.98	28.92	0.78
Vertical Polarization						
Frequency (MHz)	Rt (dBm)	Rs (dBm)	Ps (dBm)	Gs (dBi)	EIRP (dBm)	EIRP (W)
1850.20	-27.69	-52.13	0.00	1.96	26.40	0.44
1880.00	-28.66	-53.17	0.00	2.00	26.51	0.45
1909.80	-28.56	-54.13	0.00	1.98	27.55	0.57

GSM1900 (EDGE 8) Radiated Power EIRP						
Horizontal Polarization						
Frequency (MHz)	Rt (dBm)	Rs (dBm)	Ps (dBm)	Gs (dBi)	EIRP (dBm)	EIRP (W)
1850.20	-30.25	-51.88	0.00	1.96	23.59	0.23
1880.00	-30.59	-52.99	0.00	2.00	24.40	0.28
1909.80	-31.45	-54.28	0.00	1.98	24.81	0.30
Vertical Polarization						
Frequency (MHz)	Rt (dBm)	Rs (dBm)	Ps (dBm)	Gs (dBi)	EIRP (dBm)	EIRP (W)
1850.20	-30.26	-52.13	0.00	1.96	23.83	0.24
1880.00	-31.85	-53.17	0.00	2.00	23.32	0.21
1909.80	-31.56	-54.13	0.00	1.98	24.55	0.29

### 3.3 Occupied Bandwidth and Band Edge Measurement

#### 3.3.1 Description of Occupied Bandwidth and Band Edge Measurement

The power of any emission outside of the authorized operating frequency ranges must be lower than the transmitter power (P) by a factor of at least  $43 + 10 \log (P)$  dB.

The emission bandwidth is defined as the width of the signal between two points, located at the 2 sides of the carrier frequency, outside of which all emissions are attenuated at least 26 dB below the transmitter power.

#### 3.3.2 Measuring Instruments

See list of measuring instruments of this test report.

#### 3.3.3 Test Procedures

1. The EUT was connected to Spectrum Analyzer and Base Station via power divider.
2. The 99% and 26 dB occupied bandwidth (BW) of the middle channel for the highest RF powers were measured.
3. The band edges of low and high channels for the highest RF powers were measured. Setting RBW as roughly BW/100.
4. The RBW was replaced by 10 kHz, due to the spectrum analyzer IF-Filter including an excess of the limit. A worst case correction factor of  $10 \log (1\% \text{ BW}/\text{measurement RBW})$  was implemented.

#### 3.3.4 Test Setup

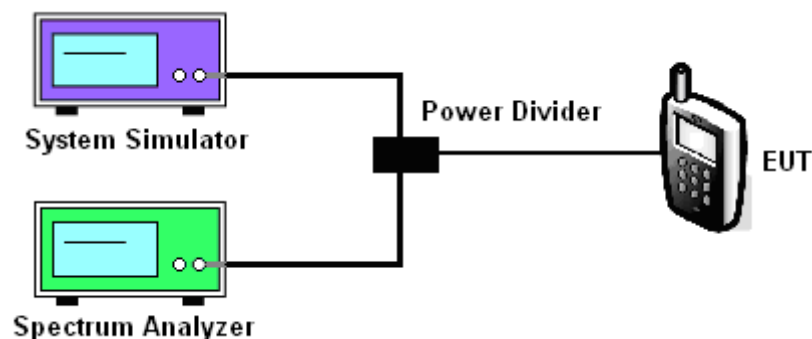



### 3.3.5 Test Result (Plots) of Occupied Bandwidth

Band :	GSM 850	Power Stage :	High
Test Mode :	GSM Link		

99% Occupied Bandwidth Plot on Channel 189

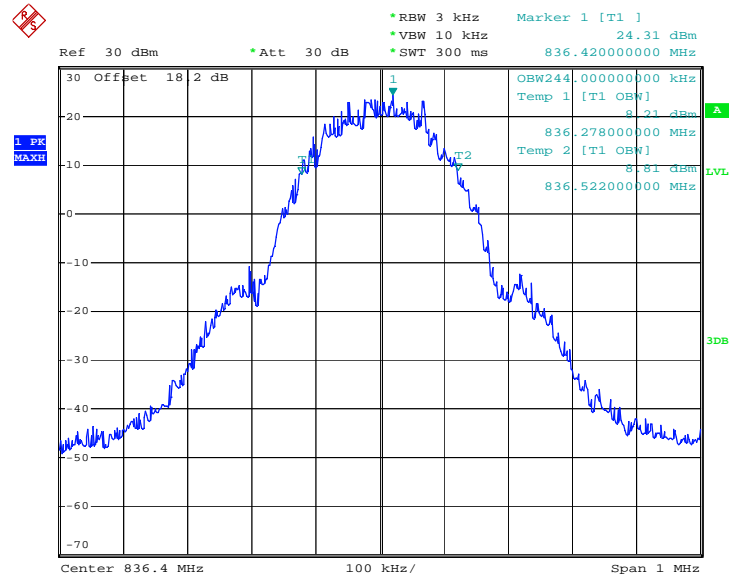

Date: 27.SEP.2008 02:55:26

26dB Bandwidth Plot on Channel 189

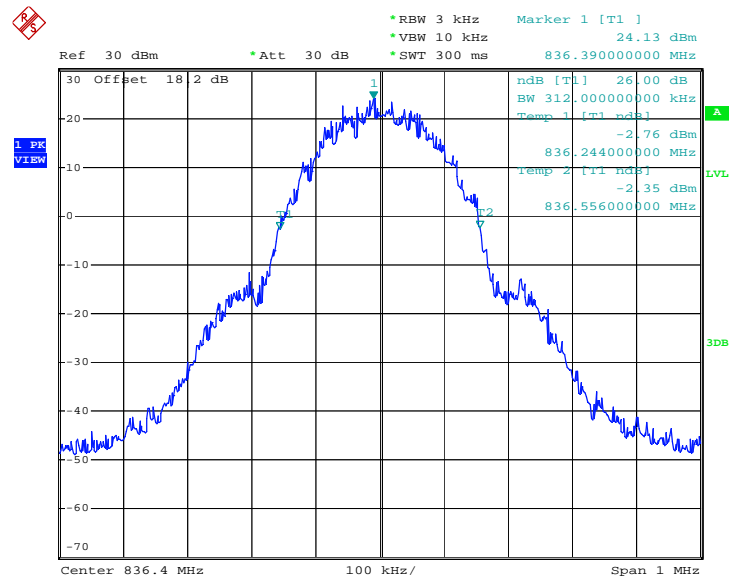

Date: 27.SEP.2008 02:53:27



Band :	GSM 850	Power Stage :	High
Test Mode :	EDGE Link		

99% Occupied Bandwidth Plot on Channel 189

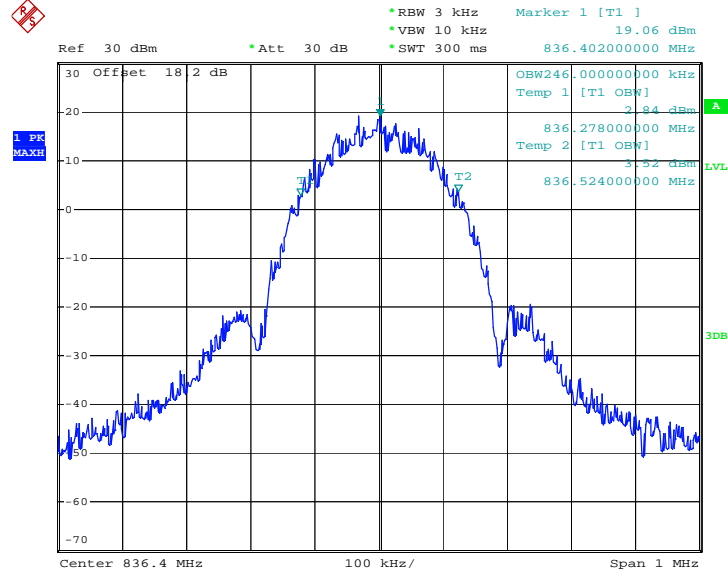

Date: 2.OCT.2008 14:43:08

26dB Bandwidth Plot on Channel 189

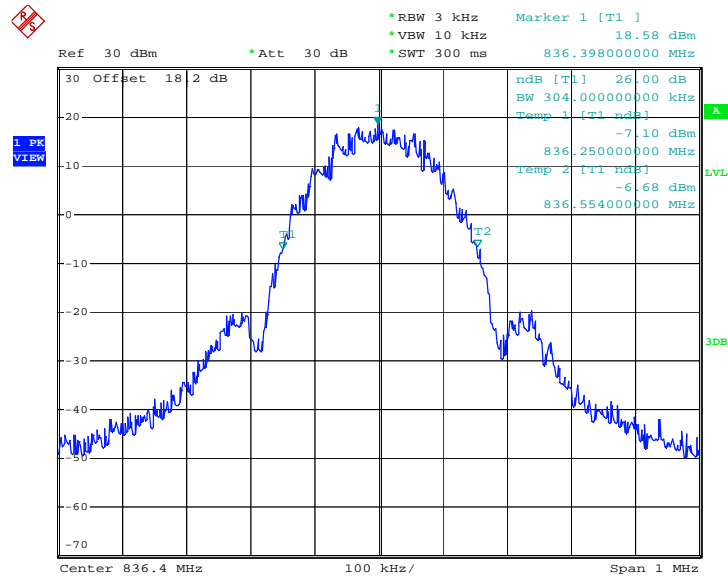

Date: 2.OCT.2008 14:40:48



<b>Band :</b>	GSM 1900	<b>Power Stage :</b>	High
<b>Test Mode :</b>	GSM Link		

99% Occupied Bandwidth Plot on Channel 661

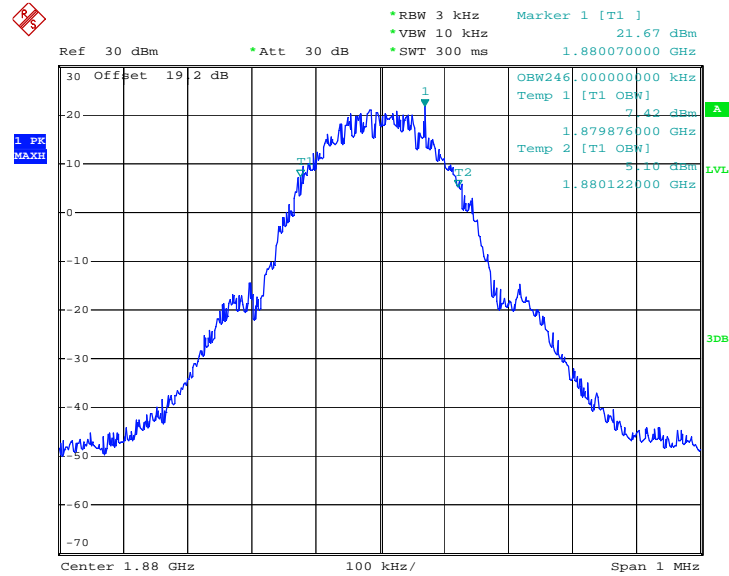

Date: 2.OCT.2008 16:31:00

26dB Bandwidth Plot on Channel 661

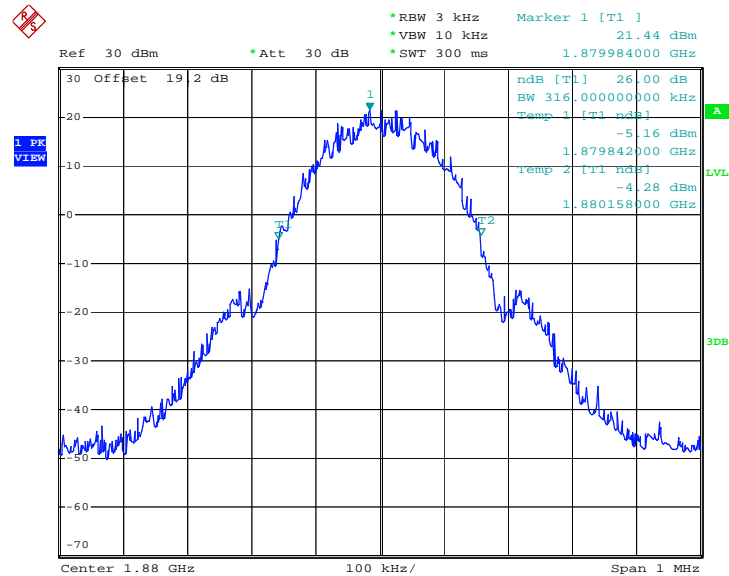

Date: 2.OCT.2008 16:28:05



<b>Band :</b>	GSM 1900	<b>Power Stage :</b>	High
<b>Test Mode :</b>	EDGE Link		

**99% Occupied Bandwidth Plot on Channel 661**

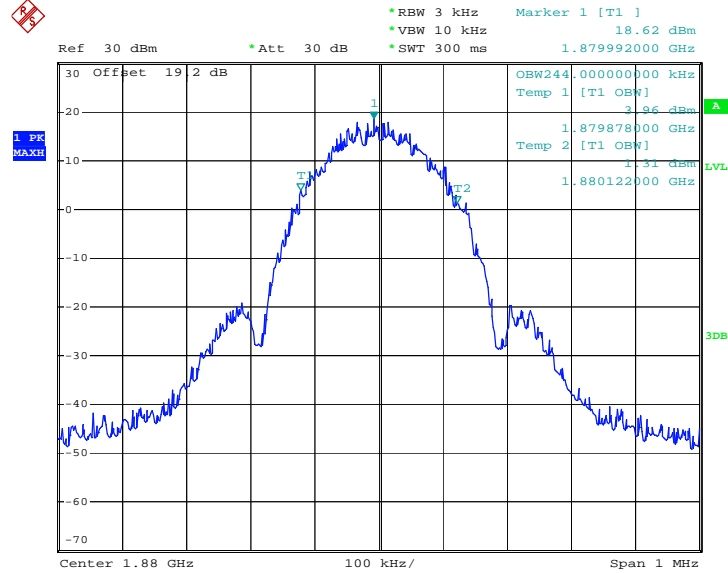

Date: 2.OCT.2008 16:47:51

**26dB Bandwidth Plot on Channel 661**

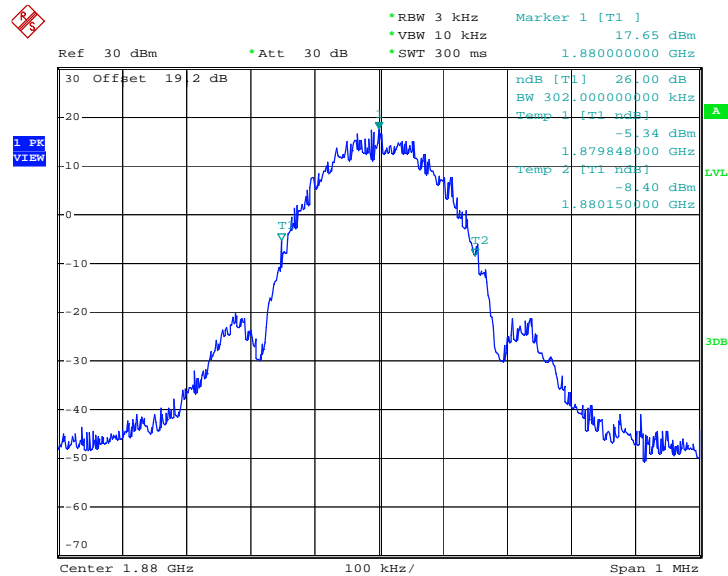

Date: 2.OCT.2008 16:41:58



### 3.3.6 Test Result (Plots) of Conducted Band Edges

Band :	GSM850	Power Stage :	High
Test Mode :	GSM Link		

Lower Band Edge Plot on Channel 128

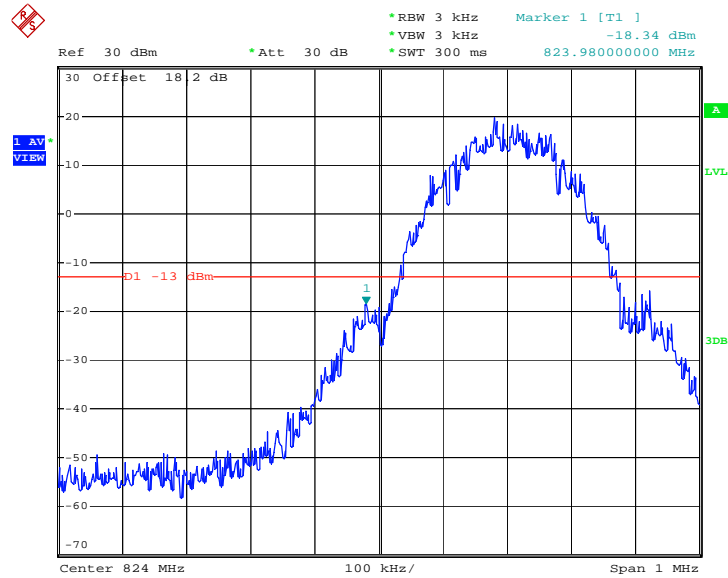

Date: 27.SEP.2008 02:58:27

Higher Band Edge Plot on Channel 251

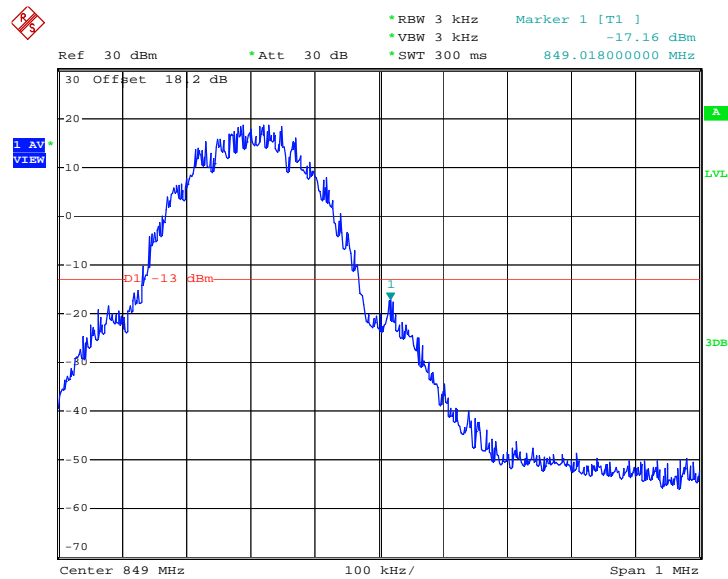

Date: 27.SEP.2008 03:00:12



Band :	GSM850	Power Stage :	High
Test Mode :	EDGE Link		

Lower Band Edge Plot on Channel 128

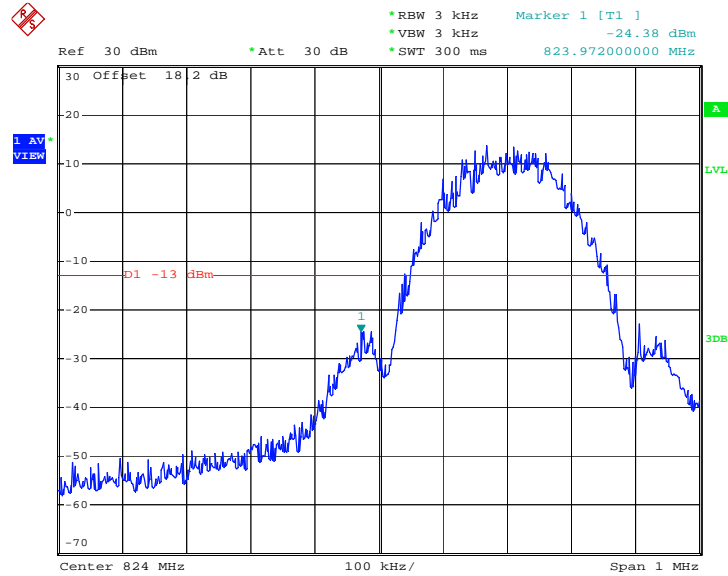

Date: 2.OCT.2008 14:45:44

Higher Band Edge Plot on Channel 251

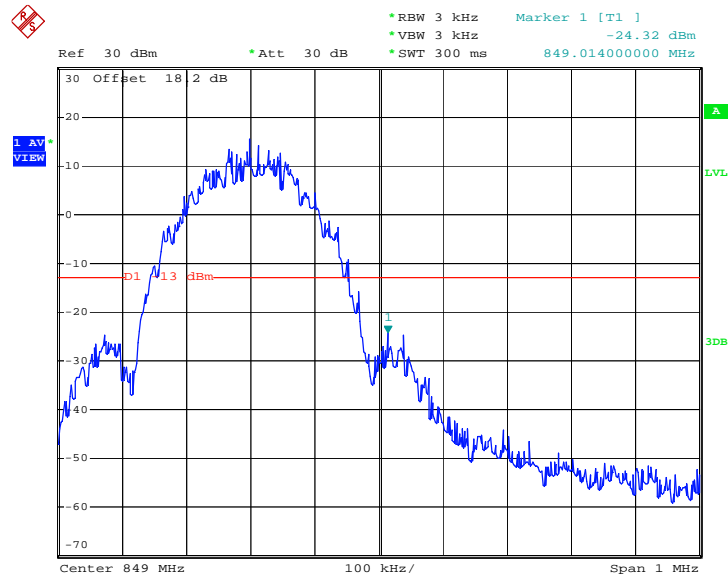

Date: 2.OCT.2008 14:47:40





Band :	GSM1900	Power Stage :	High
Test Mode :	GSM Link		

Lower Band Edge Plot on Channel 512

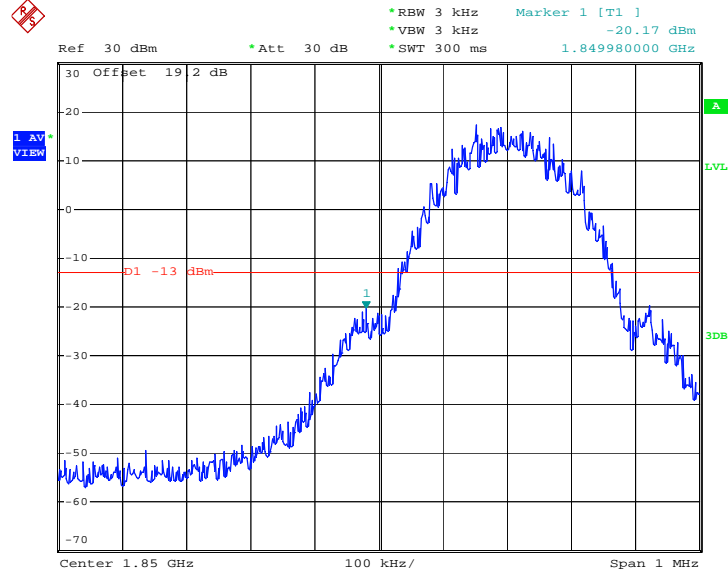

Date: 2.OCT.2008 16:33:08

Higher Band Edge Plot on Channel 810

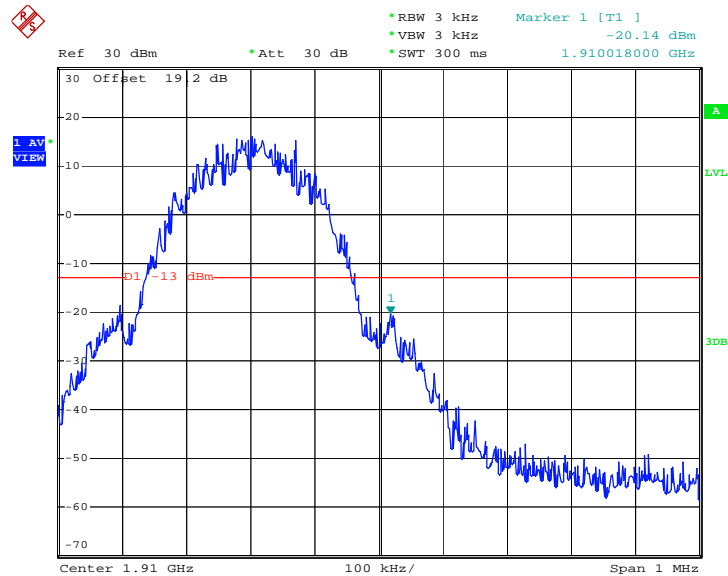

Date: 2.OCT.2008 16:34:52



Band :	GSM1900	Power Stage :	High
Test Mode :	EDGE Link		

Lower Band Edge Plot on Channel 512

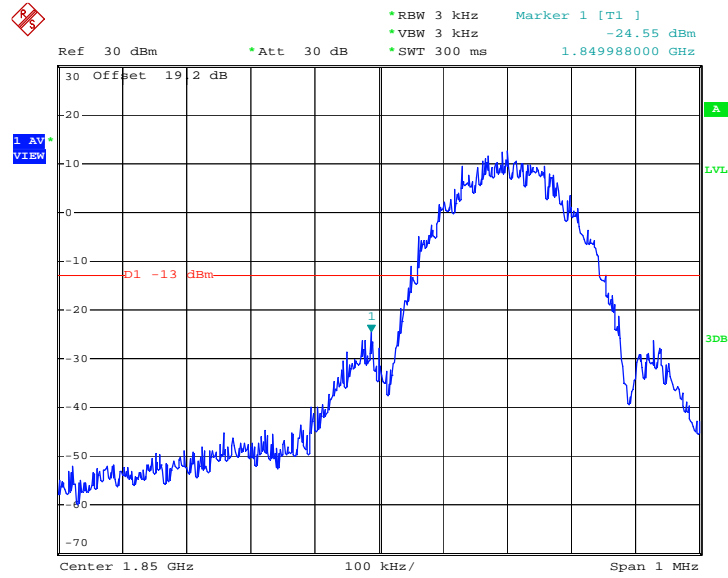

Date: 2.OCT.2008 16:39:42

Higher Band Edge Plot on Channel 810

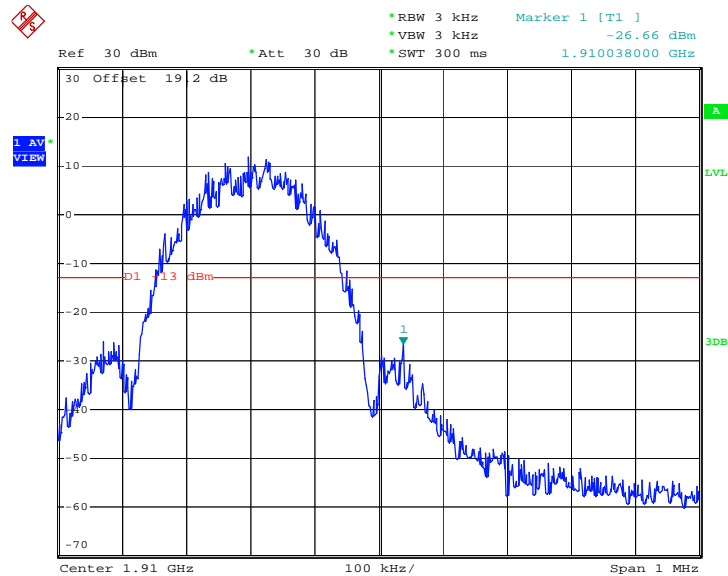

Date: 2.OCT.2008 16:37:57

## 3.4 Conducted Emission Measurement

### 3.4.1 Description of Conducted Emission Measurement

The power of any emission outside of the authorized operating frequency ranges must be lower than the transmitter power (P) by a factor of at least  $43 + 10 \log (P)$  dB.

It is measured by means of a calibrated spectrum analyzer and scanned from 30 MHz up to a frequency including its 10<sup>th</sup> harmonic.

### 3.4.2 Measuring Instruments

See list of measuring instruments of this test report.

### 3.4.3 Test Procedures

1. The EUT was connected to spectrum analyzer and base station via power divider.
2. The middle channel for the highest RF power within the transmitting frequency was measured.
3. The conducted spurious emission for the whole frequency range was taken.

### 3.4.4 Test Setup

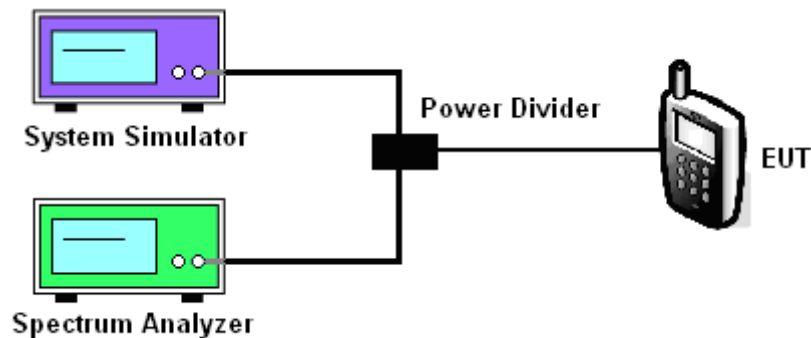



3.4.5 Test Result (Plots) of Conducted Emission

Band :	GSM850	Channel :	CH189
Test Mode :	GSM Link		

Conducted Emission Plot between 30M-1G

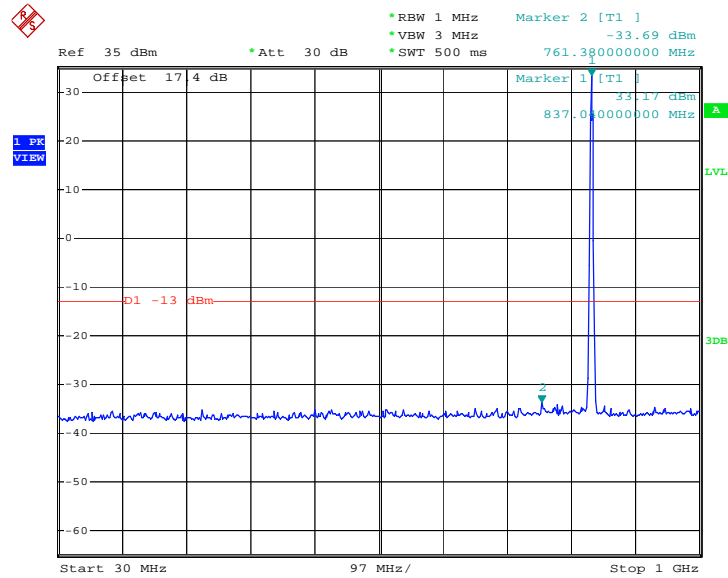

Date: 27.SEP.2008 03:19:01

Conducted Emission Plot between 1GHz ~ 3GHz

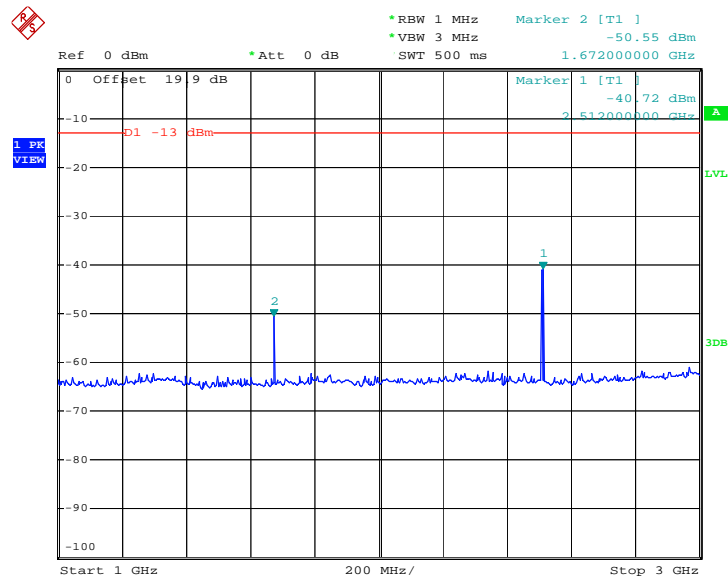

Date: 27.SEP.2008 03:21:41



### Conducted Emission Plot between 3GHz ~ 7GHz

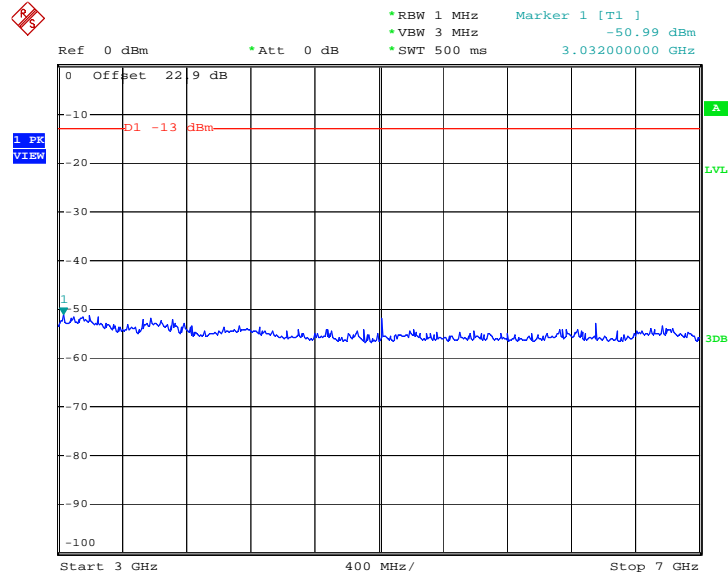

Date: 27.SEP.2008 03:22:11

### Conducted Emission Plot between 7GHz ~ 9GHz

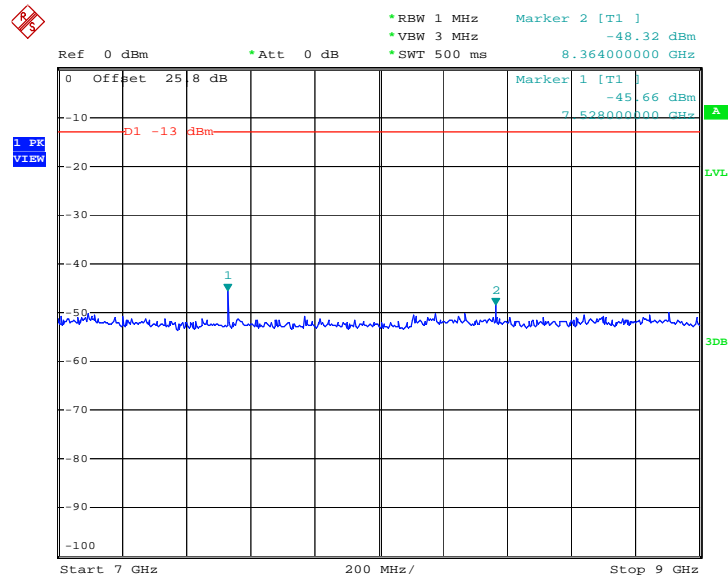

Date: 27.SEP.2008 03:22:48



Band :	GSM850	Channel :	CH189
Test Mode :	EDGE Link		

Conducted Emission Plot between 30M-1G

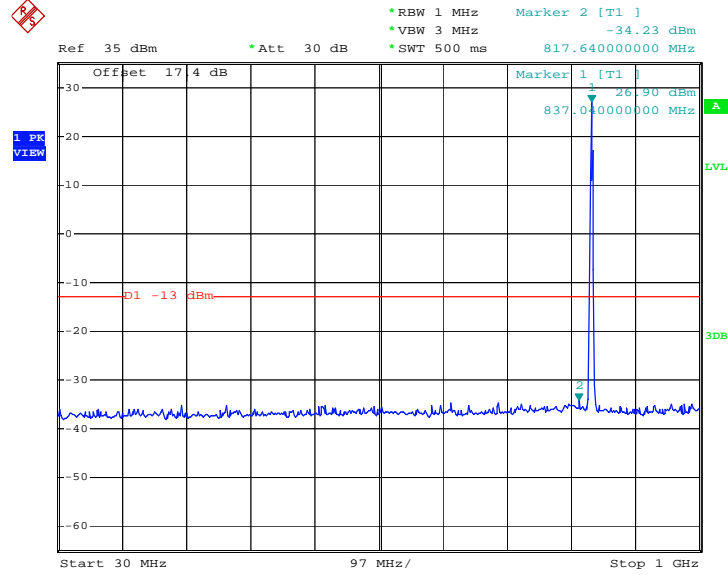

Date: 2.OCT.2008 14:59:30

Conducted Emission Plot between 1GHz ~ 3GHz

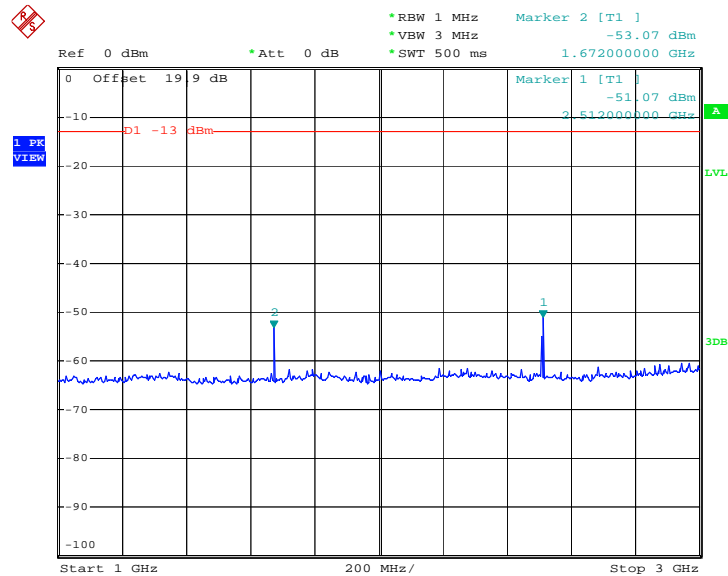

Date: 2.OCT.2008 15:01:23



### Conducted Emission Plot between 3GHz ~ 7GHz

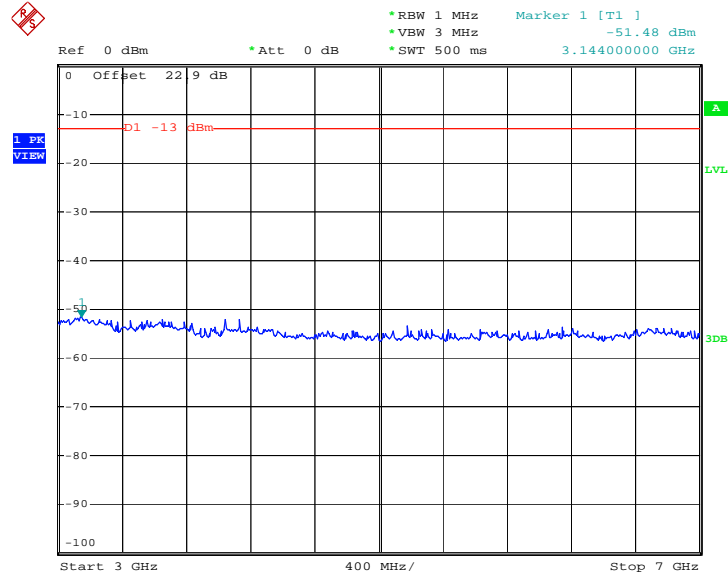

Date: 2.OCT.2008 15:01:59

### Conducted Emission Plot between 7GHz ~ 9GHz

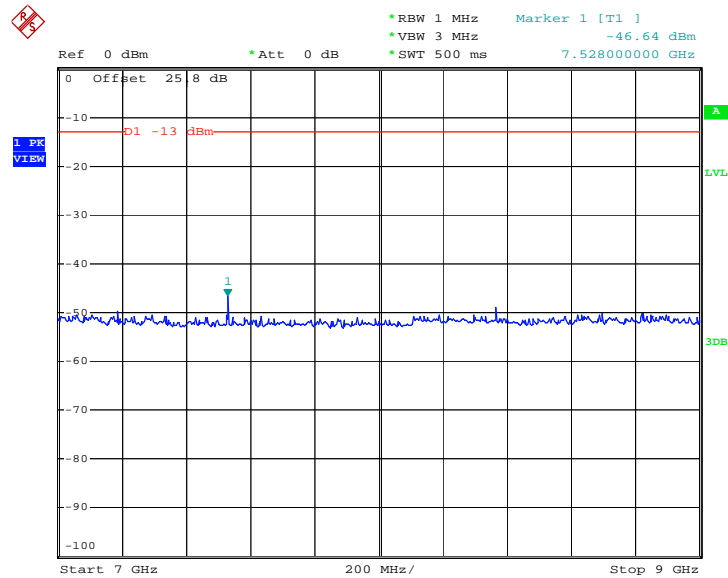

Date: 2.OCT.2008 15:02:41



Band :	GSM1900	Channel :	CH661
Test Mode :	GSM Link		

Conducted Emission Plot between 30M-1G

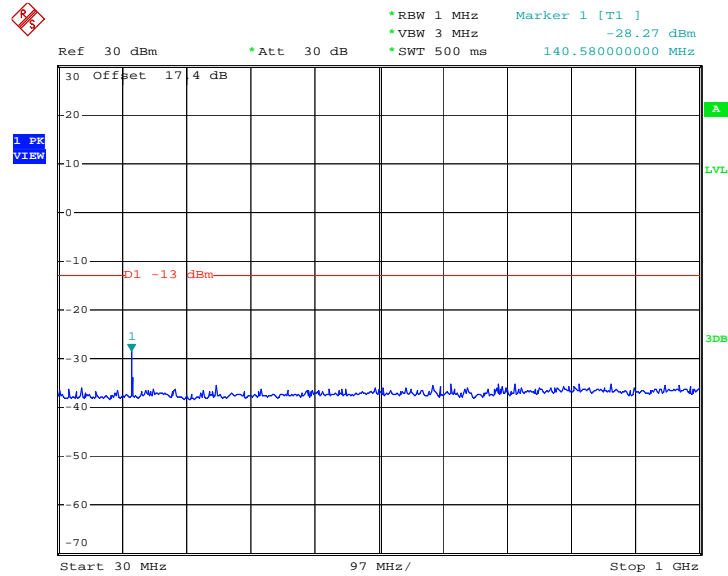

Date: 2.OCT.2008 16:58:40

Conducted Emission Plot between 1GHz ~ 3GHz

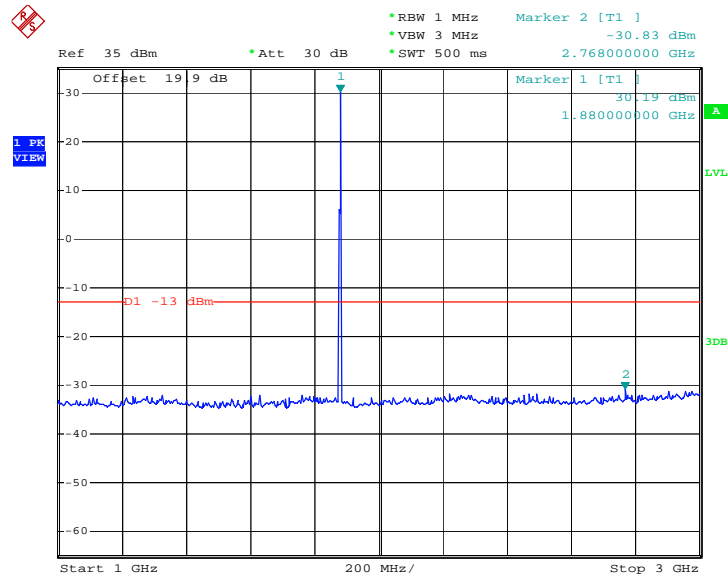

Date: 2.OCT.2008 17:02:36





### Conducted Emission Plot between 3G-7G

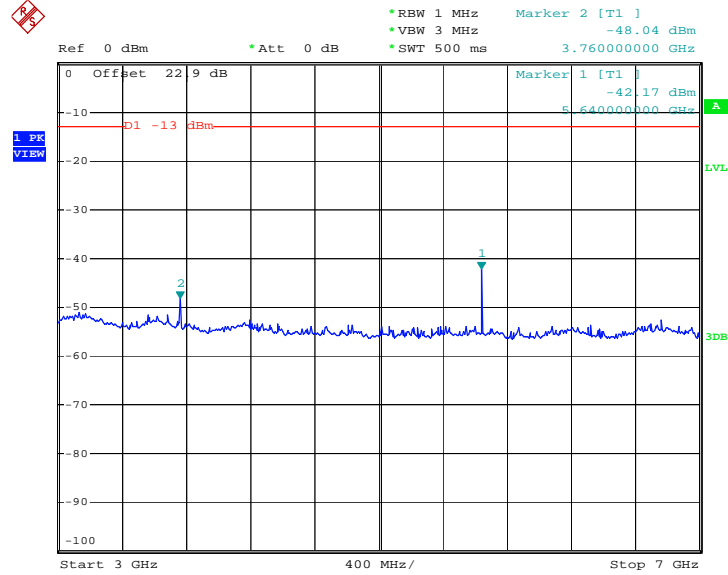

Date: 2.OCT.2008 17:03:42

### Conducted Emission Plot between 7G-13.6G

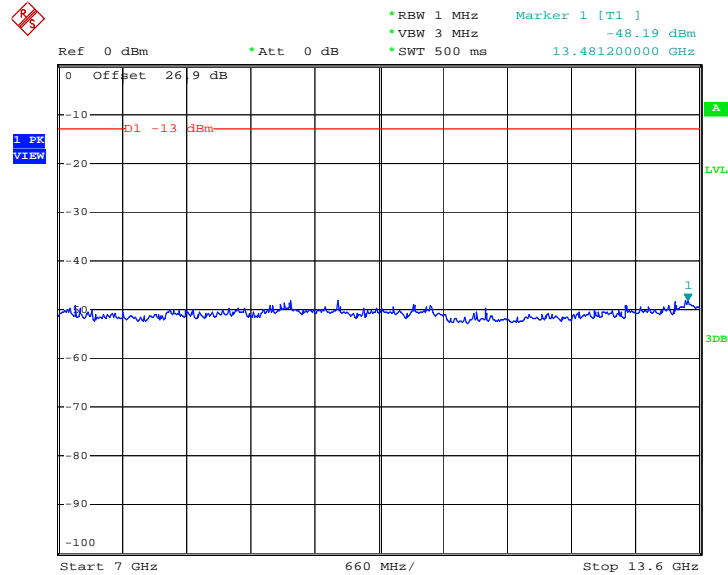

Date: 2.OCT.2008 17:05:17



Conducted Emission Plot between 13.6G-19.1G

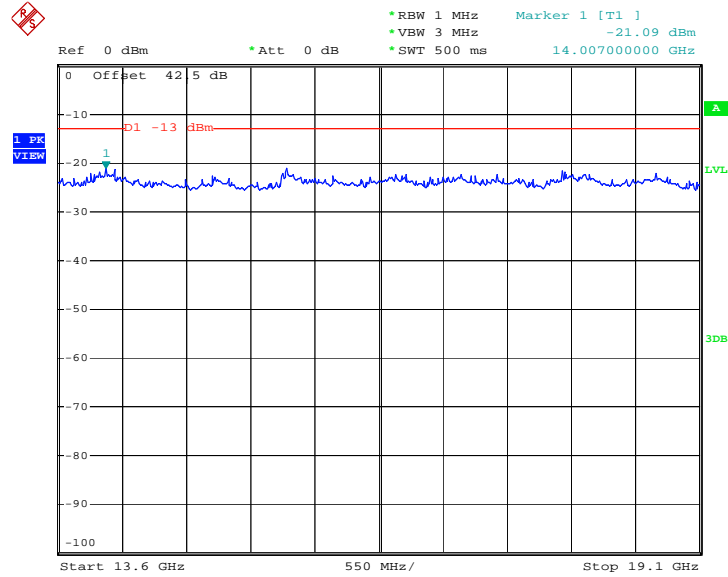

Date: 2.OCT.2008 17:05:54



Band :	GSM1900	Channel :	CH661
Test Mode :	EDGE Link		

Conducted Emission Plot between 30M-1G

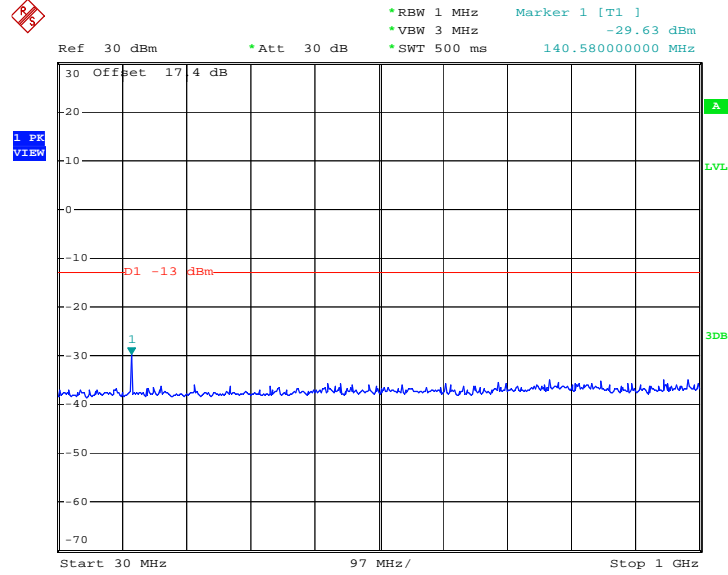

Date: 2.OCT.2008 16:59:05

Conducted Emission Plot between 1GHz ~ 3GHz

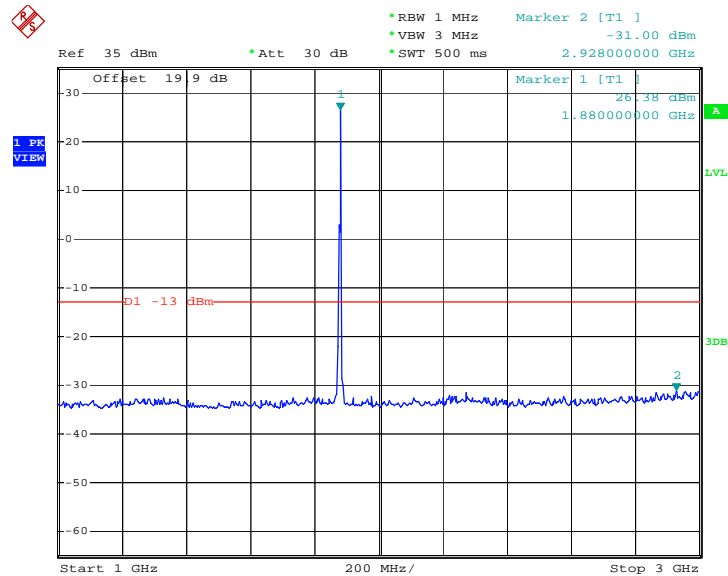

Date: 2.OCT.2008 17:01:30



### Conducted Emission Plot between 3G-7G

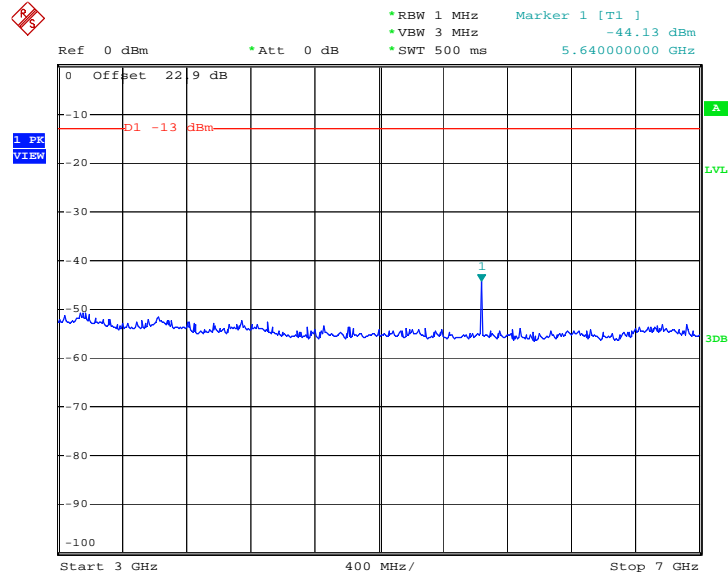

Date: 2.OCT.2008 17:04:11

### Conducted Emission Plot between 7G-13.6G

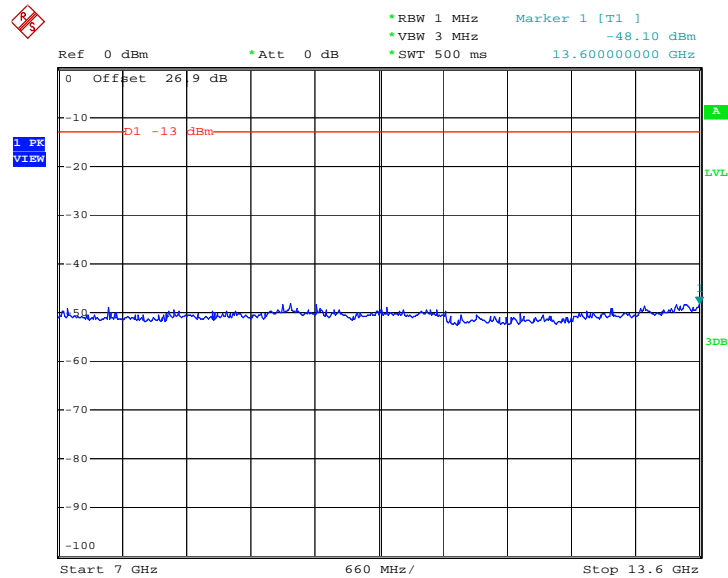

Date: 2.OCT.2008 17:04:56



Conducted Emission Plot between 13.6G-19.1G

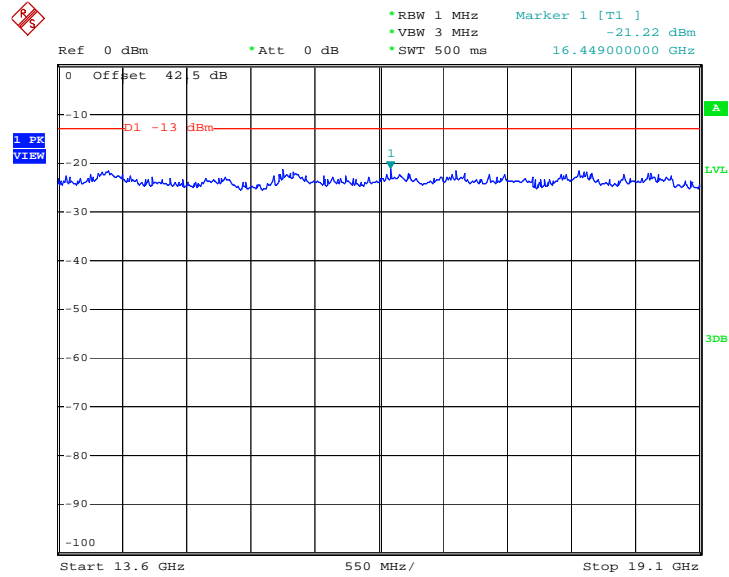

Date: 2.OCT.2008 17:06:25

### 3.5 Field Strength of Spurious Radiation Measurement

#### 3.5.1 Description of Field Strength of Spurious Radiated Measurement

The radiated spurious emission was measured by substitution method according to ANSI / TIA / EIA-603-C-2004. The power of any emission outside of the authorized operating frequency ranges must be attenuated below the transmitter power (P) by a factor of at least  $43 + 10 \log (P)$  dB. The spectrum is scanned from 30 MHz up to a frequency including its 10th harmonic.

#### 3.5.2 Measuring Instruments

See list of measuring instruments of this test report.

#### 3.5.3 Test Procedures

4. The EUT was placed on a rotatable wooden table with 0.8 meter about ground.
5. The EUT was set 3 meters from the receiving antenna, which was mounted on the antenna tower.
6. The table was rotated 360 degrees to determine the position of the highest spurious emission.
7. The height of the receiving antenna is varied between one meter and four meters to search the maximum spurious emission for both horizontal and vertical polarizations.
8. Taking the record of maximum spurious emission.
9. A horn antenna was substituted in place of the EUT and was driven by a signal generator.
10. Tune the output power of signal generator to the same emission level with EUT maximum spurious emission.
11. Taking the record of output power at antenna port.
12. Repeat step 7 to step 8 for another polarization.
13. Emission level (dBm) = output power + substitution Gain.

#### 3.5.4 Test Setup

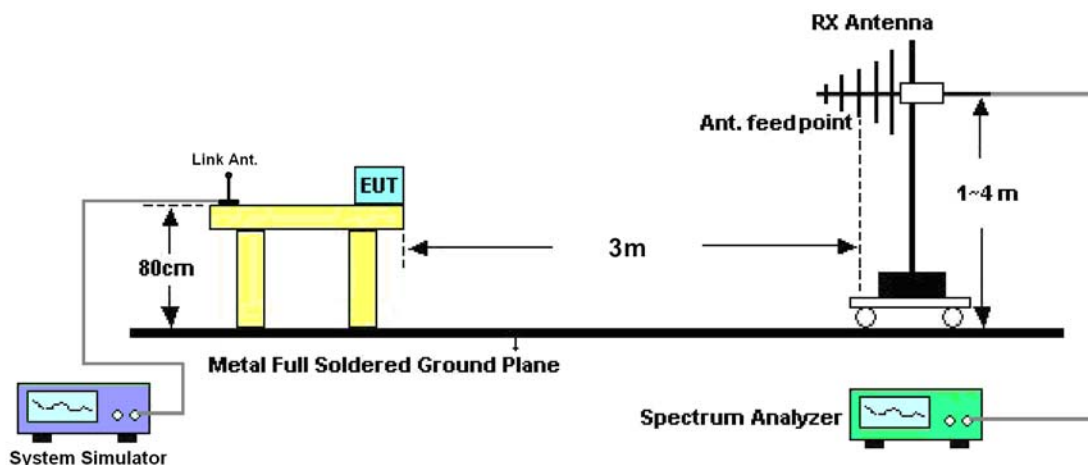



3.5.5 Test Result of Field Strength of Spurious Radiated

Band :	GSM850	Temperature :	21~23°C
Test Mode :	GSM Link	Relative Humidity :	52~54%
Test Engineer :	Elvis Chen	Polarization :	Horizontal
Remark :	Spurious emissions within 30-1000MHz were found more than 20dB below limit line.		

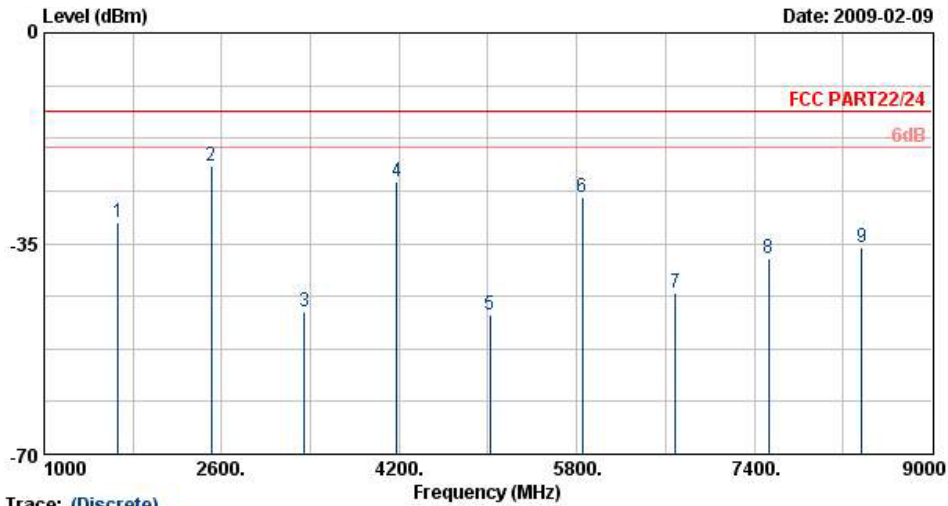

Trace: (Discrete)  
 Site : 03CH07-HY  
 Condition : FCC PART22/24 HF-EIRP(080306) HORIZONTAL  
 Project : FG 803027-01  
 Mode : Mode 1

Frequency ( MHz )	ERP ( dBm )	Limit ( dBm )	Over Limit ( dB )	SPA Reading ( dBm )	S.G. Power ( dBm )	TX Cable loss ( dB )	TX Antenna Gain ( dBi )	Polarization ( H/V )	Result
1669	-31.46	-13	-18.46	-39.86	-30.47	3.39	4.55	H	Pass
2509	-22.17	-13	-9.17	-30.72	-22.23	3.71	5.92	H	Pass
3346	-46.21	-13	-33.21	-53.92	-48.14	3.13	7.21	H	Pass
4175	-24.67	-13	-11.67	-37.36	-27.08	3.01	7.57	H	Pass
5015	-46.80	-13	-33.80	-61.56	-50.55	2.61	8.51	H	Pass
5850	-27.43	-13	-14.43	-45.83	-29.88	4.38	8.98	H	Pass
6690	-43.31	-13	-30.31	-65.12	-45.5	5.22	9.56	H	Pass
7530	-37.52	-13	-24.52	-61.64	-38.86	6.22	9.71	H	Pass
8370	-35.62	-13	-22.62	-55.12	-38.36	5.59	10.48	H	Pass



Band :	GSM850	Temperature :	21~23°C
Test Mode :	GSM Link	Relative Humidity :	52~54%
Test Engineer :	Elvis Chen	Polarization :	Vertical
Remark :	Spurious emissions within 30-1000MHz were found more than 20dB below limit line.		

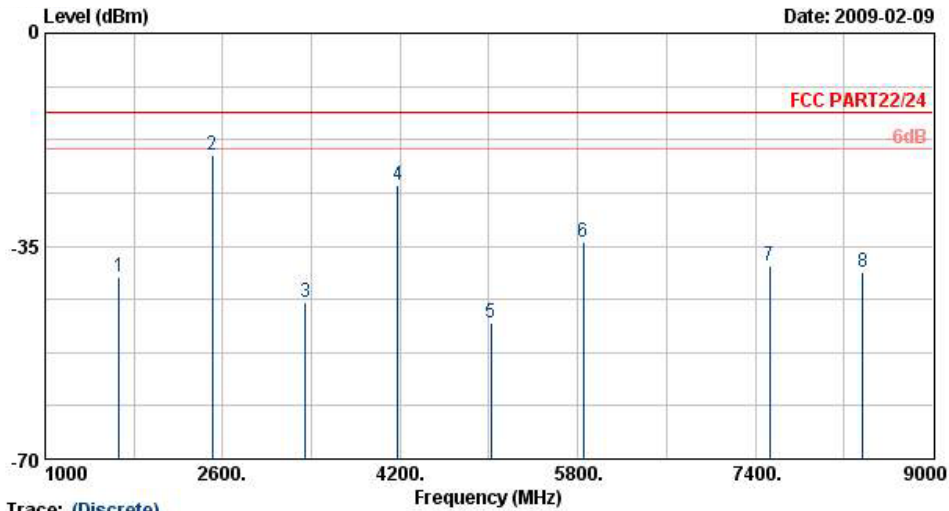

Trace: (Discrete)  
 Site : 03CH07-HY  
 Condition : FCC PART22/24 HF-EIRP(080306) VERTICAL  
 Project : FG 803027-01  
 Mode : Mode 1

Frequency ( MHz )	ERP ( dBm )	Limit ( dBm )	Over Limit ( dB )	SPA Reading ( dBm )	S.G. Power ( dBm )	TX Cable loss ( dB )	TX Antenna Gain ( dBi )	Polarization ( H/V )	Result
1669	-40.02	-13	-27.02	-45.88	-38.64	3.39	4.16	V	Pass
2509	-19.98	-13	-6.98	-32.05	-19.84	3.71	5.72	V	Pass
3346	-44.17	-13	-31.17	-55.21	-46.37	3.13	7.48	V	Pass
4175	-25.11	-13	-12.11	-40.21	-28.23	3.01	8.28	V	Pass
5015	-47.67	-13	-34.67	-62.58	-52.03	2.61	9.12	V	Pass
5850	-34.28	-13	-21.28	-50.3	-37.77	4.38	10.02	V	Pass
7530	-38.26	-13	-25.26	-62.16	-41.51	5.22	10.62	V	Pass
8370	-39.41	-13	-26.41	-60.99	-41.85	6.22	10.81	V	Pass





Band :	GSM850	Temperature :	21~23°C
Test Mode :	EDGE Link	Relative Humidity :	52~54%
Test Engineer :	Elvis Chen	Polarization :	Horizontal
Remark :	Spurious emissions within 30-1000MHz were found more than 20dB below limit line.		

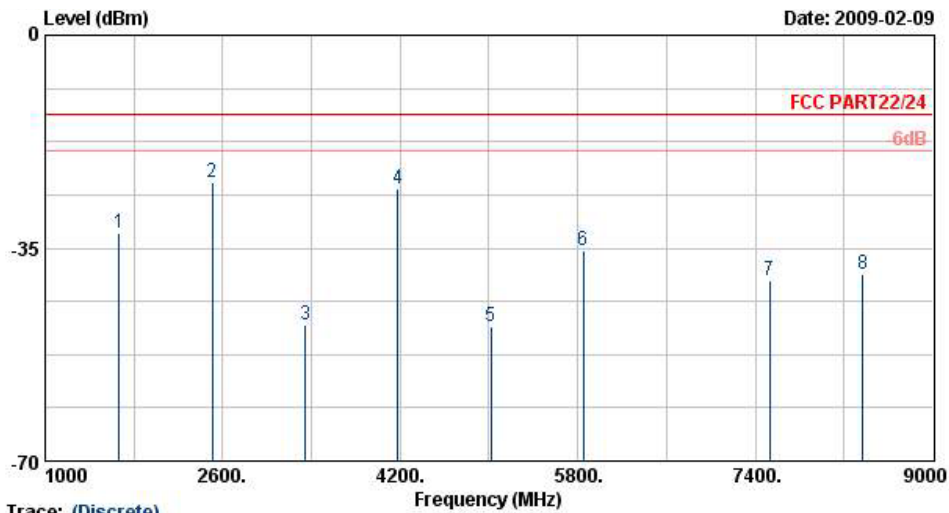

Site : 03CH07-HY  
 Condition : FCC PART22/24 HF-EIRP(080306) HORIZONTAL  
 Project : FG 803027-01  
 Mode : Mode 2

Frequency ( MHz )	ERP ( dBm )	Limit ( dBm )	Over Limit ( dB )	SPA Reading ( dBm )	S.G. Power ( dBm )	TX Cable loss ( dB )	TX Antenna Gain ( dBi )	Polarization ( H/V )	Result
1669	-32.64	-13	-19.64	-41.07	-31.65	3.39	4.55	H	Pass
2509	-24.16	-13	-11.16	-32.87	-24.22	3.71	5.92	H	Pass
3346	-47.54	-13	-34.54	-58.49	-49.47	3.13	7.21	H	Pass
4175	-25.34	-13	-12.34	-38.03	-27.75	3.01	7.57	H	Pass
5015	-47.84	-13	-34.84	-62.6	-51.59	2.61	8.51	H	Pass
5850	-35.33	-13	-22.33	-51.92	-37.78	4.38	8.98	H	Pass
7530	-40.27	-13	-27.27	-64.39	-41.61	6.22	9.71	H	Pass
8370	-39.35	-13	-26.35	-61.17	-42.09	5.59	10.48	H	Pass



Band :	GSM850	Temperature :	21~23°C
Test Mode :	EDGE Link	Relative Humidity :	52~54%
Test Engineer :	Elvis Chen	Polarization :	Vertical
Remark :	Spurious emissions within 30-1000MHz were found more than 20dB below limit line.		

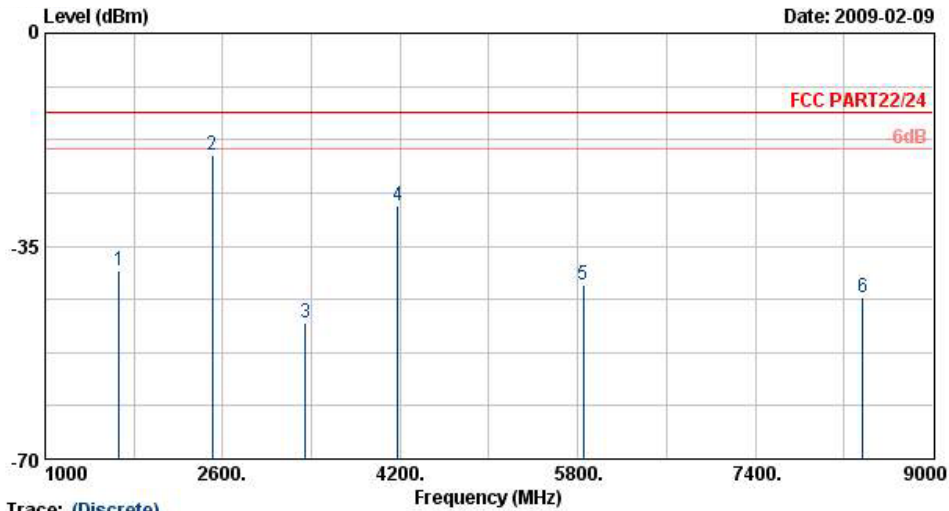

Trace: (Discrete)  
 Site : 03CH07-HY  
 Condition : FCC PART22/24 HF-EIRP(080306) VERTICAL  
 Project : FG 803027-01  
 Mode : Mode 2

Frequency ( MHz )	ERP ( dBm )	Limit ( dBm )	Over Limit ( dB )	SPA Reading ( dBm )	S.G. Power ( dBm )	TX Cable loss ( dB )	TX Antenna Gain ( dBi )	Polarization ( H/V )	Result
1669	-38.92	-13	-25.92	-44.85	-37.54	3.39	4.16	V	Pass
2509	-20.15	-13	-7.15	-32.22	-20.01	3.71	5.72	V	Pass
3346	-47.61	-13	-34.61	-60.05	-49.81	3.13	7.48	V	Pass
4175	-28.48	-13	-15.48	-43.6	-31.6	3.01	8.28	V	Pass
5850	-41.25	-13	-28.25	-56.55	-44.74	4.38	10.02	V	Pass
8370	-43.58	-13	-30.58	-65.16	-47.2	5.59	11.36	V	Pass



<b>Band :</b>	GSM1900	<b>Temperature :</b>	21~23°C
<b>Test Mode :</b>	GSM Link	<b>Relative Humidity :</b>	52~54%
<b>Test Engineer :</b>	Elvis Chen	<b>Polarization :</b>	Horizontal
<b>Remark :</b>	Spurious emissions within 30-1000MHz were found more than 20dB below limit line.		

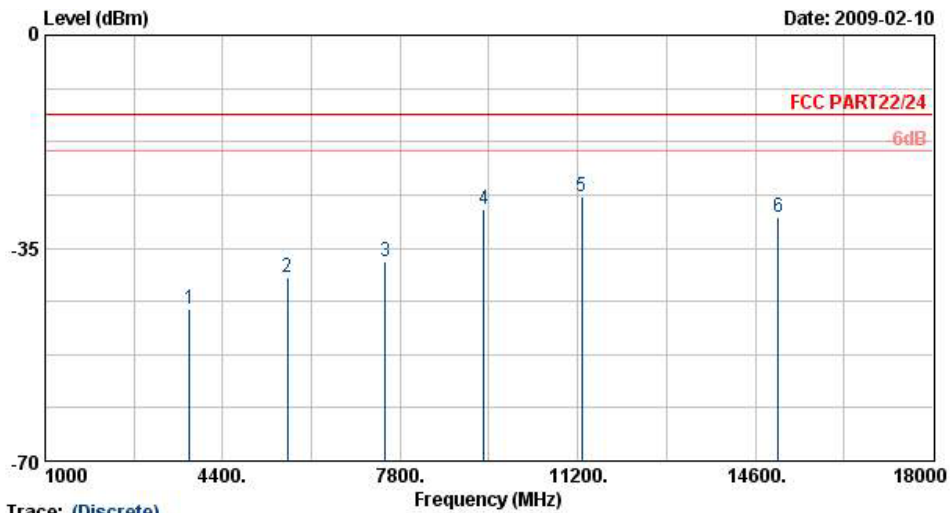

Site : 03CH07-HY  
 Condition : FCC PART22/24 HF-EIRP(080306) HORIZONTAL  
 Project : FG 803027-01  
 Mode : Mode 1

Frequency ( MHz )	EIRP ( dBm )	Limit ( dBm )	Over Limit ( dB )	SPA Reading ( dBm )	S.G. Power ( dBm )	TX Cable loss ( dB )	TX Antenna Gain ( dBi )	Polarization ( H/V )	Result
3760	-45.04	-13	-32.04	-59.14	-48.41	4.03	7.40	H	Pass
5640	-39.94	-13	-26.94	-60.54	-44.88	3.87	8.81	H	Pass
7520	-37.28	-13	-24.28	-60.03	-41.16	5.83	9.71	H	Pass
9396	-28.70	-13	-15.70	-54.48	-33.4	6.02	10.72	H	Pass
11280	-26.67	-13	-13.67	-59.79	-28.95	8.48	10.76	H	Pass
15033	-29.82	-13	-16.82	-62.32	-32.75	8.78	11.71	H	Pass



Band :	GSM1900	Temperature :	21~23°C
Test Mode :	GSM Link	Relative Humidity :	52~54%
Test Engineer :	Elvis Chen	Polarization :	Vertical
Remark :	Spurious emissions within 30-1000MHz were found more than 20dB below limit line.		

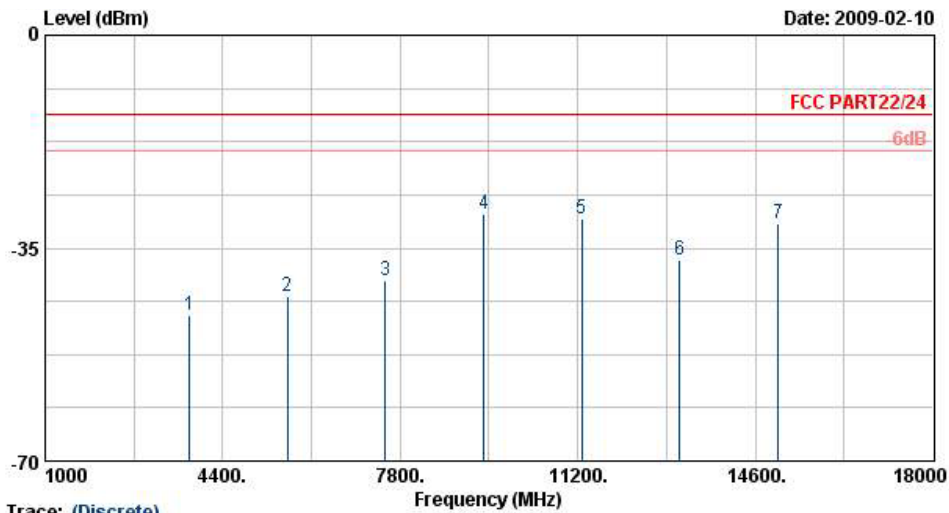

Trace: (Discrete)  
 Site : 03CH07-HY  
 Condition : FCC PART22/24 HF-EIRP(080306) VERTICAL  
 Project : FG 803027-01  
 Mode : Mode 1

Frequency ( MHz )	EIRP ( dBm )	Limit ( dBm )	Over Limit ( dB )	SPA Reading ( dBm )	S.G. Power ( dBm )	TX Cable loss ( dB )	TX Antenna Gain ( dBi )	Polarization ( H/V )	Result
3760	-46.03	-13	-33.03	-61.93	-49.91	4.03	7.91	V	Pass
5636	-42.87	-13	-29.87	-63.27	-48.77	3.87	9.77	V	Pass
7520	-40.37	-13	-27.37	-62.85	-45.35	5.83	10.81	V	Pass
9396	-29.39	-13	-16.39	-58.06	-34.89	6.02	11.52	V	Pass
11280	-30.21	-13	-17.21	-63.24	-33.09	8.48	11.36	V	Pass
13156	-36.90	-13	-23.90	-67.35	-40.93	8.13	12.16	V	Pass
15033	-30.93	-13	-17.93	-62.4	-34.36	8.78	12.21	V	Pass



Band :	GSM1900	Temperature :	21~23°C
Test Mode :	EDGE Link	Relative Humidity :	52~54%
Test Engineer :	Elvis Chen	Polarization :	Horizontal
Remark :	Spurious emissions within 30-1000MHz were found more than 20dB below limit line.		

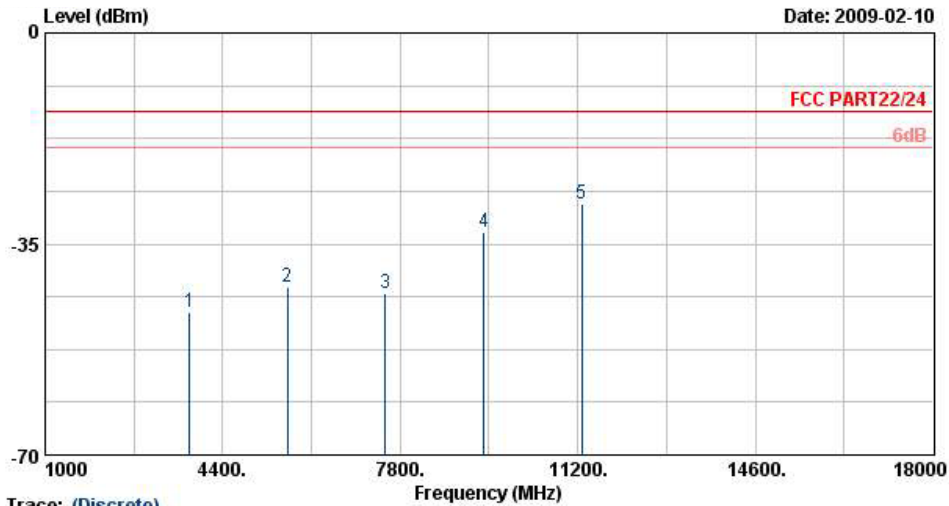

Site : 03CH07-HY  
 Condition : FCC PART22/24 HF-EIRP(080306) HORIZONTAL  
 Project : FG 803027-01  
 Mode : Mode 2

Frequency ( MHz )	EIRP ( dBm )	Limit ( dBm )	Over Limit ( dB )	SPA Reading ( dBm )	S.G. Power ( dBm )	TX Cable loss ( dB )	TX Antenna Gain ( dBi )	Polarization ( H/V )	Result
3760	-46.39	-13	-33.39	-60.33	-49.76	4.03	7.40	H	Pass
5636	-42.12	-13	-29.12	-62.2	-47.06	3.87	8.81	H	Pass
7520	-43.23	-13	-30.23	-64.64	-47.11	5.83	9.71	H	Pass
9396	-32.93	-13	-19.93	-58.13	-37.63	6.02	10.72	H	Pass
11280	-28.26	-13	-15.26	-61.13	-30.54	8.48	10.76	H	Pass



<b>Band :</b>	GSM1900	<b>Temperature :</b>	21~23°C
<b>Test Mode :</b>	EDGE Link	<b>Relative Humidity :</b>	52~54%
<b>Test Engineer :</b>	Elvis Chen	<b>Polarization :</b>	Vertical
<b>Remark :</b>	Spurious emissions within 30-1000MHz were found more than 20dB below limit line.		

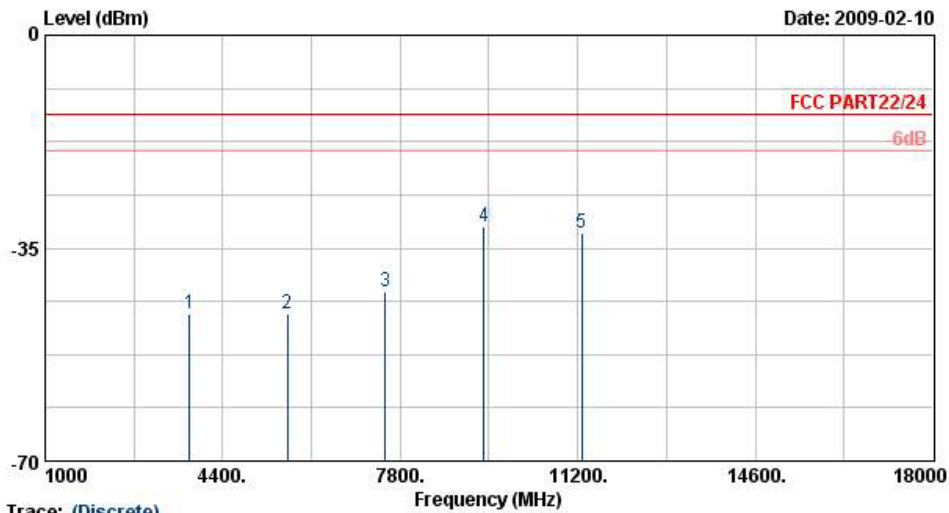

Trace: (Discrete)  
 Site : 03CH07-HY  
 Condition : FCC PART22/24 HF-EIRP(080306) VERTICAL  
 Project : FG 803027-01  
 Mode : Mode 2

Frequency ( MHz )	EIRP ( dBm )	Limit ( dBm )	Over Limit ( dB )	SPA Reading ( dBm )	S.G. Power ( dBm )	TX Cable loss ( dB )	TX Antenna Gain ( dBi )	Polarization ( H/V )	Result
3760	-45.88	-13	-32.88	-61.78	-49.76	4.03	7.91	V	Pass
5636	-45.70	-13	-32.70	-65.3	-51.6	3.87	9.77	V	Pass
7520	-42.24	-13	-29.24	-64.33	-47.22	5.83	10.81	V	Pass
9396	-31.59	-13	-18.59	-60.74	-37.09	6.02	11.52	V	Pass
11280	-32.40	-13	-19.40	-64.98	-35.28	8.48	11.36	V	Pass



Band :	GSM850	Temperature :	21~23°C
Test Mode :	GSM + BT Link	Relative Humidity :	52~54%
Test Engineer :	Elvis Chen	Polarization :	Horizontal
Remark :	Spurious emissions within 30-1000MHz were found more than 20dB below limit line.		

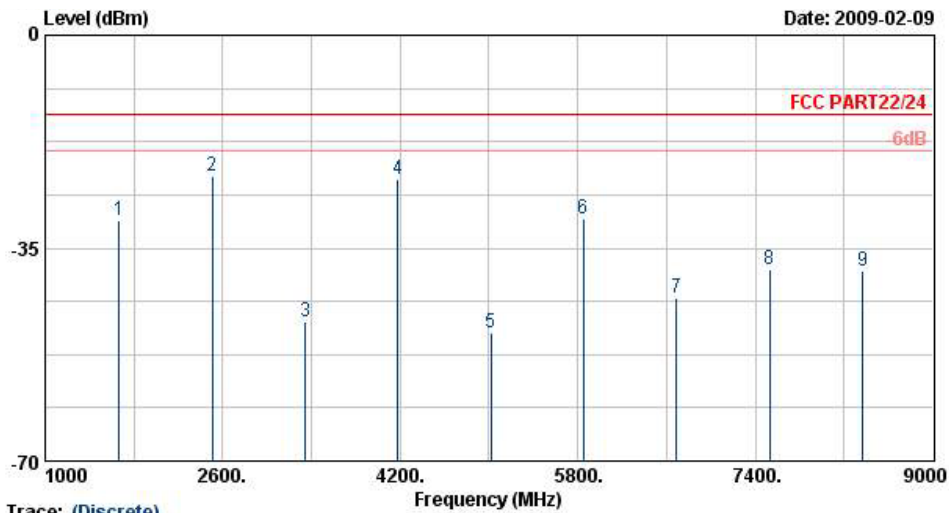

Site : 03CH07-HY  
 Condition : FCC PART22/24 HF-EIRP(080306) HORIZONTAL  
 Project : FG 803027-01  
 Mode : Mode 1

Frequency ( MHz )	ERP ( dBm )	Limit ( dBm )	Over Limit ( dB )	SPA Reading ( dBm )	S.G. Power ( dBm )	TX Cable loss ( dB )	TX Antenna Gain ( dBi )	Polarization ( H/V )	Result
1669	-30.35	-13	-17.35	-38.97	-29.36	3.39	4.55	H	Pass
2509	-23.14	-13	-10.14	-31.8	-23.2	3.71	5.92	H	Pass
3346	-47.09	-13	-34.09	-54.65	-49.02	3.13	7.21	H	Pass
4175	-23.77	-13	-10.77	-36.34	-26.18	3.01	7.57	H	Pass
5015	-48.90	-13	-35.90	-63.66	-52.65	2.61	8.51	H	Pass
5850	-30.19	-13	-17.19	-47.4	-32.64	4.38	8.98	H	Pass
6690	-43.15	-13	-30.15	-64.96	-45.34	5.22	9.56	H	Pass
7530	-38.40	-13	-25.40	-62.52	-39.74	6.22	9.71	H	Pass
8370	-38.83	-13	-25.83	-57.74	-41.57	5.59	10.48	H	Pass



Band :	GSM850	Temperature :	21~23°C
Test Mode :	GSM + BT Link	Relative Humidity :	52~54%
Test Engineer :	Elvis Chen	Polarization :	Vertical
Remark :	Spurious emissions within 30-1000MHz were found more than 20dB below limit line.		

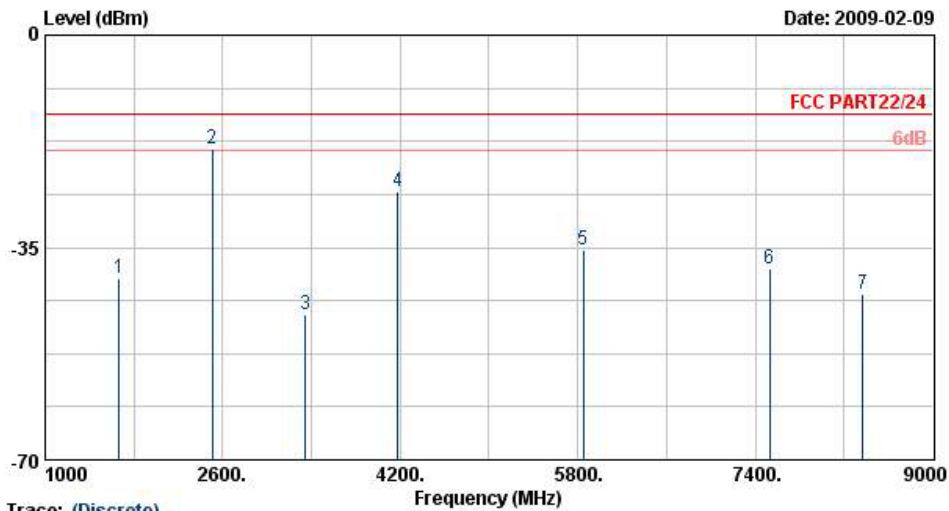

Trace: (Discrete)  
 Site : 03CH07-HY  
 Condition : FCC PART22/24 HF-EIRP(080306) VERTICAL  
 Project : FG 803027-01  
 Mode : Mode 1

Frequency ( MHz )	ERP ( dBm )	Limit ( dBm )	Over Limit ( dB )	SPA Reading ( dBm )	S.G. Power ( dBm )	TX Cable loss ( dB )	TX Antenna Gain ( dBi )	Polarization ( H/V )	Result
1669	-40.11	-13	-27.11	-45.97	-38.73	3.39	4.16	V	Pass
2509	-19.01	-13	-6.01	-30.79	-18.57	3.71	5.72	V	Pass
3346	-46.00	-13	-33.00	-56.53	-48.2	3.13	7.48	V	Pass
4175	-25.70	-13	-12.70	-40.9	-28.82	3.01	8.28	V	Pass
5850	-35.37	-13	-22.37	-51.46	-38.86	4.38	10.02	V	Pass
7530	-38.40	-13	-25.40	-62.3	-40.84	6.22	10.81	V	Pass
8370	-42.58	-13	-29.58	-64.16	-46.2	5.59	11.36	V	Pass





Band :	GSM850	Temperature :	21~23°C
Test Mode :	GSM + WLAN Link	Relative Humidity :	52~54%
Test Engineer :	Elvis Chen	Polarization :	Horizontal
Remark :	Spurious emissions within 30-1000MHz were found more than 20dB below limit line.		

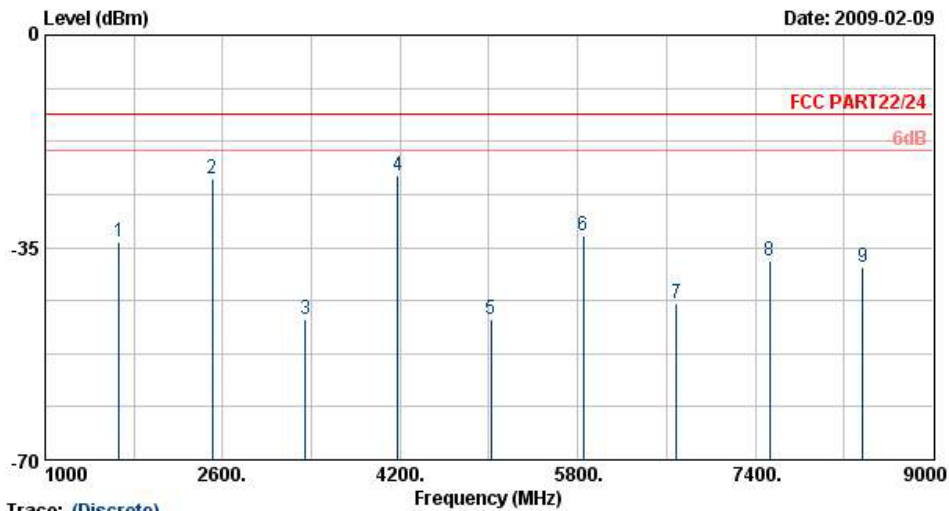

Site : 03CH07-HY  
 Condition : FCC PART22/24 HF-EIRP(080306) HORIZONTAL  
 Project : FG 803027-01  
 Mode : Mode 2

Frequency ( MHz )	ERP ( dBm )	Limit ( dBm )	Over Limit ( dB )	SPA Reading ( dBm )	S.G. Power ( dBm )	TX Cable loss ( dB )	TX Antenna Gain ( dBi )	Polarization ( H/V )	Result
1669	-34.15	-13	-21.15	-42.54	-33.16	3.39	4.55	H	Pass
2509	-23.74	-13	-10.74	-32.45	-23.8	3.71	5.92	H	Pass
3346	-46.86	-13	-33.86	-54.42	-48.79	3.13	7.21	H	Pass
4175	-23.15	-13	-10.15	-35.85	-25.56	3.01	7.57	H	Pass
5015	-46.91	-13	-33.91	-61.67	-50.66	2.61	8.51	H	Pass
5850	-32.96	-13	-19.96	-49.94	-35.41	4.38	8.98	H	Pass
6690	-44.21	-13	-31.21	-66.02	-46.4	5.22	9.56	H	Pass
7530	-37.32	-13	-24.32	-61.44	-38.66	6.22	9.71	H	Pass
8370	-38.24	-13	-25.24	-57.38	-40.98	5.59	10.48	H	Pass



<b>Band :</b>	GSM850	<b>Temperature :</b>	21~23°C
<b>Test Mode :</b>	GSM + WLAN Link	<b>Relative Humidity :</b>	52~54%
<b>Test Engineer :</b>	Elvis Chen	<b>Polarization :</b>	Vertical
<b>Remark :</b>	Spurious emissions within 30-1000MHz were found more than 20dB below limit line.		

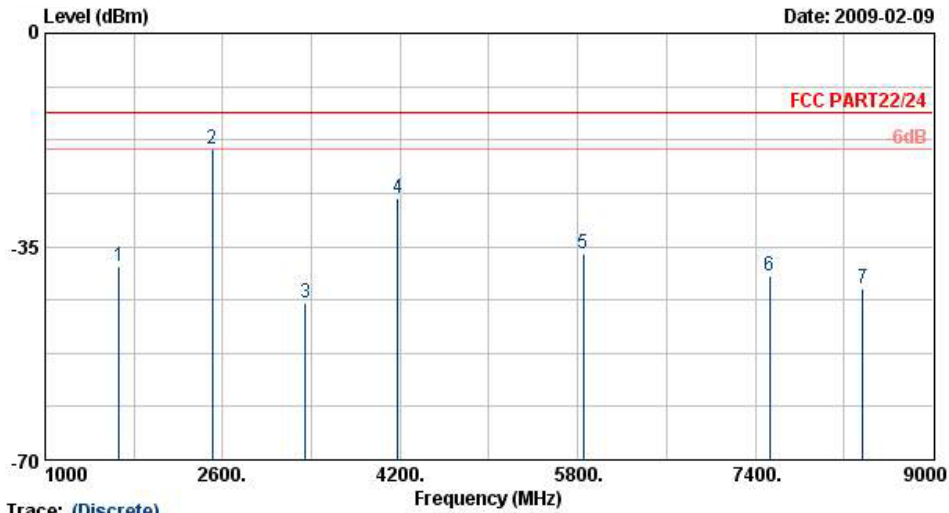

Trace: (Discrete)  
 Site : 03CH07-HY  
 Condition : FCC PART22/24 HF-EIRP(080306) VERTICAL  
 Project : FG 803027-01  
 Mode : Mode 2

Frequency ( MHz )	ERP ( dBm )	Limit ( dBm )	Over Limit ( dB )	SPA Reading ( dBm )	S.G. Power ( dBm )	TX Cable loss ( dB )	TX Antenna Gain ( dBi )	Polarization ( H/V )	Result
1669	-38.31	-13	-25.31	-44.32	-36.93	3.39	4.16	V	Pass
2509	-19.07	-13	-6.07	-30.95	-18.73	3.71	5.72	V	Pass
3346	-44.24	-13	-31.24	-55.28	-46.44	3.13	7.48	V	Pass
4175	-26.97	-13	-13.97	-41.82	-30.09	3.01	8.28	V	Pass
5850	-36.21	-13	-23.21	-52.24	-39.70	4.38	10.02	V	Pass
7530	-39.72	-13	-26.72	-63.62	-42.16	6.22	10.81	V	Pass
8370	-41.93	-13	-28.93	-60.65	-45.55	5.59	11.36	V	Pass



Band :	GSM1900	Temperature :	21~23°C
Test Mode :	GSM + BT Link	Relative Humidity :	52~54%
Test Engineer :	Elvis Chen	Polarization :	Horizontal
Remark :	Spurious emissions within 30-1000MHz were found more than 20dB below limit line.		

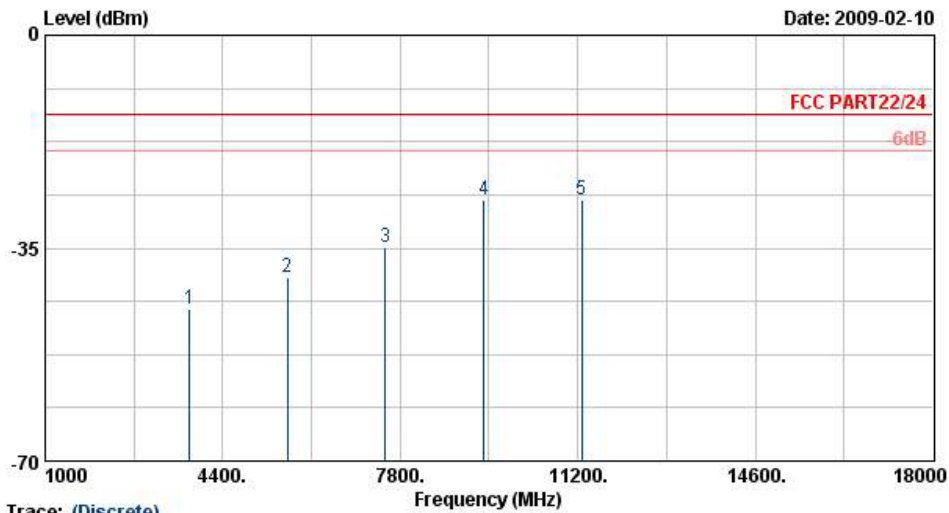

Trace: (Discrete)  
 Site : 03CH07-HY  
 Condition : FCC PART22/24 HF-EIRP(080306) HORIZONTAL  
 Project : FG 803027-01  
 Mode : Mode 1

Frequency ( MHz )	EIRP ( dBm )	Limit ( dBm )	Over Limit ( dB )	SPA Reading ( dBm )	S.G. Power ( dBm )	TX Cable loss ( dB )	TX Antenna Gain ( dBi )	Polarization ( H/V )	Result
3760	-44.92	-13	-31.92	-59.02	-48.29	4.03	7.40	H	Pass
5636	-39.75	-13	-26.75	-60.35	-44.69	3.87	8.81	H	Pass
7520	-34.85	-13	-21.85	-57.94	-38.73	5.83	9.71	H	Pass
9396	-27.11	-13	-14.11	-53.14	-31.81	6.02	10.72	H	Pass
11280	-26.98	-13	-13.98	-60.1	-29.26	8.48	10.76	H	Pass



Band :	GSM1900	Temperature :	21~23°C
Test Mode :	GSM + BT Link	Relative Humidity :	52~54%
Test Engineer :	Elvis Chen	Polarization :	Vertical
Remark :	Spurious emissions within 30-1000MHz were found more than 20dB below limit line.		

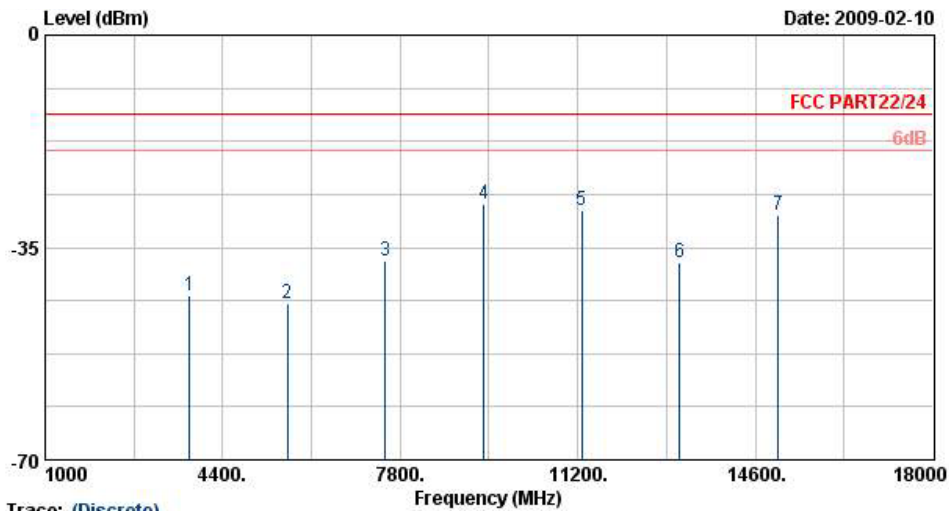

Site : 03CH07-HY  
 Condition : FCC PART22/24 HF-EIRP(080306) VERTICAL  
 Project : FG 803027-01  
 Mode : Mode 1

Frequency ( MHz )	EIRP ( dBm )	Limit ( dBm )	Over Limit ( dB )	SPA Reading ( dBm )	S.G. Power ( dBm )	TX Cable loss ( dB )	TX Antenna Gain ( dBi )	Polarization ( H/V )	Result
3760	-42.85	-13	-29.85	-59.5	-46.73	4.03	7.91	V	Pass
5636	-44.15	-13	-31.15	-64.48	-50.05	3.87	9.77	V	Pass
7520	-37.34	-13	-24.34	-60.35	-42.32	5.83	10.81	V	Pass
9396	-27.85	-13	-14.85	-57.52	-33.35	6.02	11.52	V	Pass
11280	-28.90	-13	-15.90	-62.09	-31.78	8.48	11.36	V	Pass
13156	-37.43	-13	-24.43	-67.88	-41.46	8.13	12.16	V	Pass
15033	-29.62	-13	-16.62	-61.09	-33.05	8.78	12.21	V	Pass



Band :	GSM1900	Temperature :	21~23°C
Test Mode :	EDGE + WLAN Link	Relative Humidity :	52~54%
Test Engineer :	Elvis Chen	Polarization :	Horizontal
Remark :	Spurious emissions within 30-1000MHz were found more than 20dB below limit line.		

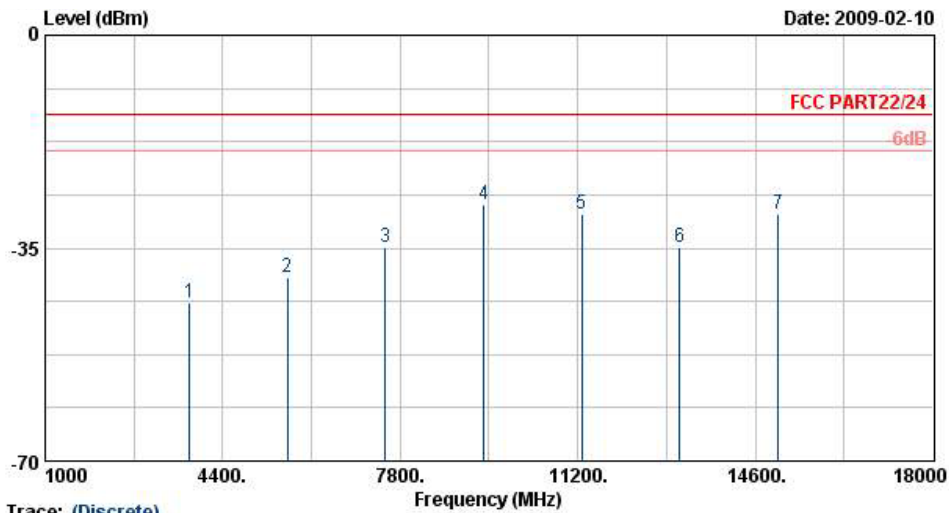

Trace: (Discrete)  
 Site : 03CH07-HY  
 Condition : FCC PART22/24 HF-EIRP(080306) HORIZONTAL  
 Project : FG 803027-01  
 Mode : Mode 2

Frequency ( MHz )	EIRP ( dBm )	Limit ( dBm )	Over Limit ( dB )	SPA Reading ( dBm )	S.G. Power ( dBm )	TX Cable loss ( dB )	TX Antenna Gain ( dBi )	Polarization ( H/V )	Result
3760	-43.89	-13	-30.89	-58.38	-47.26	4.03	7.40	H	Pass
5636	-39.83	-13	-26.83	-60.43	-44.77	3.87	8.81	H	Pass
7520	-34.97	-13	-21.97	-58.06	-38.85	5.83	9.71	H	Pass
9396	-27.81	-13	-14.81	-53.77	-32.51	6.02	10.72	H	Pass
11280	-29.39	-13	-16.39	-62.06	-31.67	8.48	10.76	H	Pass
13156	-34.87	-13	-21.87	-67.3	-37.77	8.13	11.03	H	Pass
15033	-29.38	-13	-16.38	-61.88	-32.31	8.78	11.71	H	Pass



<b>Band :</b>	GSM1900	<b>Temperature :</b>	21~23°C
<b>Test Mode :</b>	EDGE + WLAN Link	<b>Relative Humidity :</b>	52~54%
<b>Test Engineer :</b>	Elvis Chen	<b>Polarization :</b>	Vertical
<b>Remark :</b>	Spurious emissions within 30-1000MHz were found more than 20dB below limit line.		

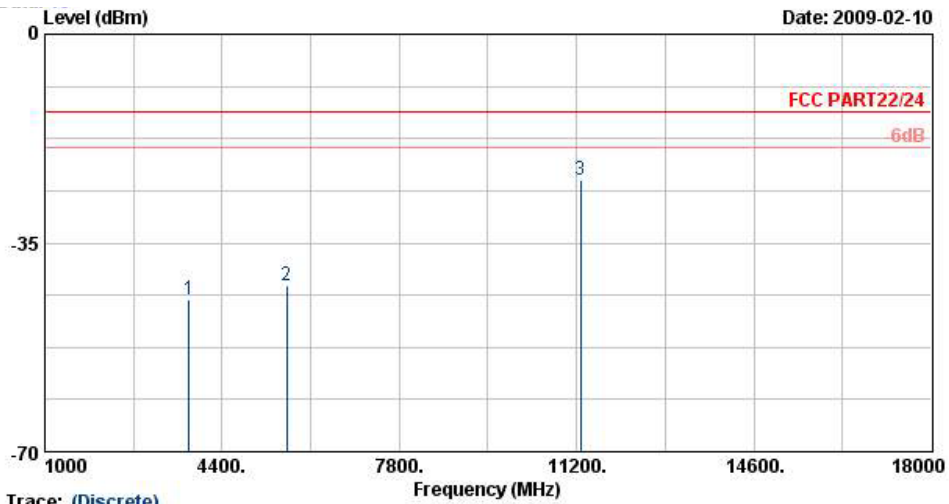

Trace: (Discrete)  
 Site : 03CH07-HY  
 Condition : FCC PART22/24 HF-EIRP(080306) VERTICAL  
 Project : FG 803027-01  
 Mode : Mode 2

Frequency ( MHz )	EIRP ( dBm )	Limit ( dBm )	Over Limit ( dB )	SPA Reading ( dBm )	S.G. Power ( dBm )	TX Cable loss ( dB )	TX Antenna Gain ( dBi )	Polarization ( H/V )	Result
3760	-44.55	-13	-31.55	-60.83	-48.43	4.03	7.91	V	Pass
5636	-42.20	-13	-29.20	-62.91	-48.1	3.87	9.77	V	Pass
11280	-24.54	-13	-11.54	-58.56	-27.42	8.48	11.36	V	Pass

## 3.6 Frequency Stability Measurement

### 3.6.1 Description of Frequency Stability Measurement

The frequency stability shall be measured by variation of ambient temperature and variation of primary supply voltage to ensure that the fundamental emission stays within the authorized frequency block. The frequency stability of the transmitter shall be maintained within  $\pm 0.00025\%$  ( $\pm 2.5\text{ppm}$ ) of the center frequency.

### 3.6.2 Measuring Instruments

See list of measuring instruments of this test report.

### 3.6.3 Test Procedures for Temperature Variation

1. The EUT was set up in the thermal chamber and connected with the base station.
2. With power OFF, the temperature was decreased to  $-30^{\circ}\text{C}$  and the EUT was stabilized for three hours. Power was applied and the maximum change in frequency was recorded within one minute.
3. With power OFF, the temperature was raised in  $10^{\circ}\text{C}$  step up to  $50^{\circ}\text{C}$ . The EUT was stabilized at each step for at least half an hour. Power was applied and the maximum frequency change was recorded within one minute.
4. If the EUT can not be turned on at  $-30^{\circ}\text{C}$ , the testing lowest temperature will be raised in  $10^{\circ}\text{C}$  step until the EUT can be turned on.

### 3.6.4 Test Procedures for Voltage Variation

1. The EUT was placed in a temperature chamber at  $25\pm 5^{\circ}\text{C}$  and connected with the base station.
2. The power supply voltage to the EUT was varied from BEP to 115% of the nominal value measured at the input to the EUT.
3. The variation in frequency was measured for the worst case.

### 3.6.5 Test Setup

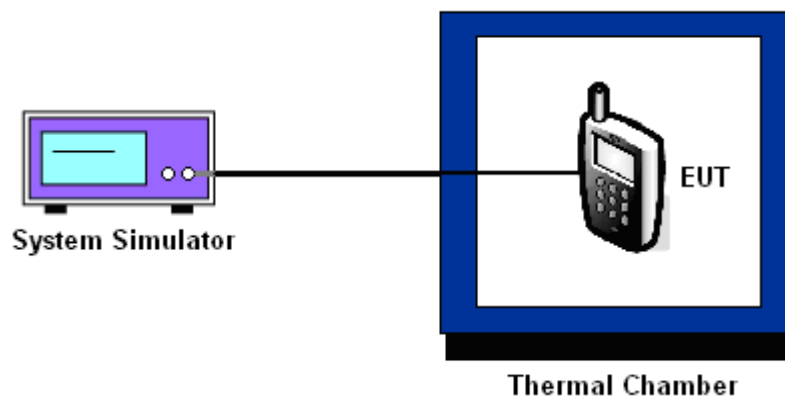

3.6.6 Test Result of Temperature Variation

Band :	GSM 850	Channel :	189
Limit (ppm) :	2.5		

Temperature (°C)	GSM		EDGE 8		Result
	Freq. Dev. (Hz)	Deviation (ppm)	Freq. Dev. (Hz)	Deviation (ppm)	
-30	-15	-0.02	-24	-0.03	PASS
-20	-56	-0.07	-38	-0.04	
-10	-65	-0.08	-35	-0.04	
0	-32	-0.04	-26	-0.03	
10	31	0.04	17	0.02	
20	20	0.02	28	0.03	
30	-45	-0.05	-33	-0.04	
40	-63	-0.07	-49	-0.06	
50	-88	-0.10	-74	-0.09	

Band :	GSM 1900	Channel :	661
Limit (ppm) :	2.5		

Temperature (°C)	GSM		EDGE 8		Result
	Freq. Dev. (Hz)	Deviation (ppm)	Freq. Dev. (Hz)	Deviation (ppm)	
-30	-69	-0.04	-56	-0.03	PASS
-20	-75	-0.04	-78	-0.04	
-10	-88	-0.05	-62	-0.03	
0	-45	-0.02	-37	-0.02	
10	-33	-0.02	15	0.01	
20	-72	-0.04	27	0.01	
30	-57	-0.03	-35	-0.02	
40	-69	-0.04	-57	-0.03	
50	-82	-0.04	-89	-0.05	



**3.6.7 Test Result of Voltage Variation**

Band & Channel	Mode	Voltage (Volt)	Freq. Dev. (Hz)	Deviation (ppm)	Limit (ppm)	Result
GSM 850 CH189	GSM	3.7	-35	-0.04	2.5	PASS
		BEP	-26	-0.03		
		4.2	-43	-0.05		
	EDGE 8	3.7	-43	-0.05		
		BEP	-50	-0.06		
		4.2	-42	-0.05		
GSM 1900 CH661	GSM	3.7	-58	-0.03		
		BEP	-53	-0.03		
		4.2	-73	-0.04		
	EDGE 8	3.7	-83	-0.04		
		BEP	-81	-0.04		
		4.2	-82	-0.04		

Remark:

1. Normal Voltage = 3.7V.
2. Battery End Point (BEP) = 3.2 V.



### 4 List of Measuring Equipments

Instrument	Manufacturer	Model No.	Serial No.	Characteristics	Calibration Date	Due Date	Remark
System Simulator	R&S	CMU200	105934	N/A	Nov. 08, 2008	Nov. 07, 2009	Conducted (TH02-HY)
Spectrum Analyzer	R&S	FSP40	100055	9kHz~40GHz	Jun. 26, 2008	Jun. 25, 2009	Conducted (TH02-HY)
Thermal Chamber	TEN BILLION	TTH-D35P	TBN-930701	N/A	Aug. 01, 2008	Jul. 31, 2009	Conducted (TH02-HY)
Bilog Antenna	SCHAFFNER	CBL6111C	2726	30MHz~1GHz	Nov. 20, 2008	Nov. 19, 2009	Radiation (03CH07-HY)
Spectrum Analyzer	R&S	FSP	101067	9kHz~30GHz	Dec. 02, 2008	Dec. 01, 2009	Radiation (03CH07-HY)
Double Ridge Horn Antenna	ESCO	3117	75962	1G~18GHz	Aug. 13, 2008	Aug. 12, 2009	Radiation (03CH07-HY)
Pre Amplifier	Agilent	8449B	3008A02362	1G~26.5GHz	Dec. 17, 2008	Dec. 16, 2009	Radiation (03CH07-HY)
Pre Amplifier	COM-POWER	PA-103A	161241	10~1000MHz. 32dB.GAIN	Mar. 31, 2008	Mar. 30, 2009	Radiation (03CH07-HY)
Double Ridge Horn Antenna	ESCO	3117	66584	1G~18GHz	Aug. 06, 2008	Aug. 05, 2009	Radiation (03CH07-HY)
SHF-EHF Horn	SCHWARZBECK	BBHA 9170	BBHA9170251	15G - 40GHz	Oct. 16, 2008	Oct. 15, 2009	Radiation (03CH07-HY)

## 5 Uncertainty of Evaluation

### Uncertainty of Radiated Emission Measurement (30 MHz ~ 1000 MHz)

Contribution	Uncertainty of $x_i$		$u(x_i)$
	dB	Probability Distribution	
Receiver reading	0.41	Normal(k=2)	0.21
Antenna factor calibration	0.83	Normal(k=2)	0.42
Cable loss calibration	0.25	Normal(k=2)	0.13
Pre Amplifier Gain calibration	0.27	Normal(k=2)	0.14
RCV/SPA specification	2.50	Rectangular	0.72
Antenna Factor Interpolation for Frequency	1.00	Rectangular	0.29
Site imperfection	1.43	Rectangular	0.83
Mismatch	+0.39/-0.41	U-shaped	0.28
<b>Combined standard uncertainty Uc(y)</b>	<b>1.27</b>		
<b>Measuring uncertainty for a level of confidence of 95% U=2Uc(y)</b>	<b>2.54</b>		

### Uncertainty of Radiated Emission Measurement (1 GHz ~ 40 GHz)

Contribution	Uncertainty of $x_i$		$u(x_i)$	$C_i$	$C_i * u(x_i)$
	dB	Probability Distribution			
Receiver reading	±0.10	Normal(k=1)	0.10	1	0.10
Antenna factor calibration	±1.70	Normal(k=2)	0.85	1	0.85
Cable loss calibration	±0.50	Normal(k=2)	0.25	1	0.25
Receiver Correction	±2.00	Rectangular	1.15	1	1.15
Antenna Factor Directional	±1.50	Rectangular	0.87	1	0.87
Site imperfection	±2.80	Triangular	1.14	1	1.14
Mismatch Receiver VSWR $\Gamma_1 = 0.197$ Antenna VSWR $\Gamma_2 = 0.194$ Uncertainty = $20 \log(1 - \Gamma_1 * \Gamma_2)$	+0.34/-0.35	U-shaped	0.244	1	0.244
<b>Combined standard uncertainty Uc(y)</b>	<b>2.36</b>				
<b>Measuring uncertainty for a level of confidence of 95% U=2Uc(y)</b>	<b>4.72</b>				

## 6 Certification of TAF Accreditation



Certificate No. : I.1190-081212

財團法人全國認證基金會  
Taiwan Accreditation Foundation

### Certificate of Accreditation

This is to certify that

**Sporton International Inc.**  
**EMC & Wireless Communications Laboratory**  
No.52, Hwa Ya 1st Rd., Hwa Ya Technology Park, Kwei-Shan Hsiang, Tao Yuan Hsien,  
Taiwan, R.O.C.

**is accredited in respect of laboratory**

<b>Accreditation Criteria</b>	: ISO/IEC 17025:2005
<b>Accreditation Number</b>	: 1190
<b>Originally Accredited</b>	: December 15, 2003
<b>Effective Period</b>	: January 10, 2007 to January 09, 2010
<b>Accredited Scope</b>	: Testing Field, see described in the Appendix
<b>Specific Accreditation Program</b>	: Accreditation Program for Designated Testing Laboratory for Commodities Inspection Accreditation Program for Telecommunication Equipment Testing Laboratory Accreditation Program for BSMI Mutual Recognition Arrangement with Foreign Authorities



Jay-San Chen  
President, Taiwan Accreditation Foundation  
Date : December 12, 2008

PI, total 18 pages

The Appendix forms an integral part of this Certificate, which shall be invalid when use without the Appendix



## **Appendix A. Photographs of EUT**

Please refer to Sporton report number EP803027-01 as below.