



**Specific Absorption Rate (SAR) Test Report**  
for  
**Symbol Technologies, Inc., A Motorola Company**  
on the  
**Mobile Computer**

**Report Number : FA803027-01B**  
**Trade Name : Symbol**  
**Model Name : FR6074**  
**FCC ID : H9PFR6074**  
**Date of Testing : Dec. 14, 2008**  
**Date of Report : Mar. 17, 2009**  
**Date of Review : Mar. 17, 2009**

- The test results refer exclusively to the tested model/sample only.
- Without written approval of SPORTON INTERNATIONAL INC., the test report shall not be reproduced except in full.
- Report Version: Rev. 01

**SPORTON INTERNATIONAL INC.**

**No. 52, Hwa Ya 1<sup>st</sup> Rd., Hwa Ya Technology Park, Kwei-Shan Hsiang, Tao Yuan Hsien, Taiwan, R.O.C.**



## Table of Contents

- 1. **Statement of Compliance** .....3
- 2. **Administration Data** .....4
  - 2.1 Testing Laboratory .....4
  - 2.2 Applicant .....4
  - 2.3 Manufacturer .....4
  - 2.4 Application Details .....4
- 3. **General Information** .....5
  - 3.1 Description of Device Under Test (DUT) .....5
  - 3.2 Basic Description of Accessories .....6
  - 3.3 Product Photos .....7
  - 3.4 Applied Standards .....7
  - 3.5 Device Category and SAR Limits .....7
  - 3.6 Test Conditions .....7
    - 3.6.1 Ambient Condition .....7
    - 3.6.2 Test Configuration .....8
- 4. **Specific Absorption Rate (SAR)** .....9
  - 4.1 Introduction .....9
  - 4.2 SAR Definition .....9
- 5. **SAR Measurement Setup** .....10
  - 5.1 DASY4 E-Field Probe System .....11
    - 5.1.1 ET3DV6 E-Field Probe Specification .....11
    - 5.1.2 ET3DV6 E-Field Probe Calibration .....11
  - 5.2 DATA Acquisition Electronics (DAE) .....12
  - 5.3 Robot .....12
  - 5.4 Measurement Server .....12
  - 5.5 SAM Twin Phantom .....13
  - 5.6 Device Holder for SAM Twin Phantom .....14
  - 5.7 Data Storage and Evaluation .....15
    - 5.7.1 Data Storage .....15
    - 5.7.2 Data Evaluation .....15
  - 5.8 Test Equipment List .....17
- 6. **Tissue Simulating Liquids** .....18
- 7. **Uncertainty Assessment** .....20
- 8. **SAR Measurement Evaluation** .....22
  - 8.1 Purpose of System Performance check .....22
  - 8.2 System Setup .....22
  - 8.3 Validation Results .....24
- 9. **Description for DUT Testing Position** .....25
- 10. **Measurement Procedures** .....27
  - 10.1 Spatial Peak SAR Evaluation .....27
  - 10.2 Scan Procedures .....28
  - 10.3 SAR Averaged Methods .....28
- 11. **SAR Test Results** .....29
  - 11.1 Conducted Power .....29
  - 11.2 Test Records for Head SAR Test .....29
  - 11.3 Test Records for Body SAR Test .....29
- 12. **References** .....30

Appendix A - System Performance Check Data  
 Appendix B - SAR Measurement Data  
 Appendix C - Calibration Data  
 Appendix D - Product Photos  
 Appendix E - Test Setup Photos



**1. Statement of Compliance**

The Specific Absorption Rate (SAR) maximum results found during testing for the **Symbol Technologies, Inc., A Motorola Company Mobile Computer FR6074** are as follows (with expanded uncertainty 21.9%):

Position	SAR	802.11b/g (W/kg)
Head		0.016
Body		0.019

They are in compliance with Specific Absorption Rate (SAR) for general population/uncontrolled exposure limits specified in FCC 47 CFR part 2 (2.1093) and ANSI/IEEE C95.1-1999 and had been tested in accordance with the measurement methods and procedures specified in IEEE P1528-2003 and OET Bulletin 65 Supplement C (Edition 01-01).

Approved by

Roy Wu  
Manager



**2. Administration Data**

**2.1 Testing Laboratory**

**Company Name :** Sporton International Inc.  
**Address :** No.52, Hwa-Ya 1<sup>st</sup> RD., Hwa Ya Technology Park, Kwei-Shan Hsiang, TaoYuan Hsien, Taiwan, R.O.C.  
**Test Site :** SAR01-HY  
**Telephone Number :** 886-3-327-3456  
**Fax Number :** 886-3-328-4978

**2.2 Applicant**

**Company Name :** Symbol Technologies, Inc., A Motorola Company  
**Address :** 230 Victoria Street #12-06/10 Bugis Junction Office Tower Singapore 188024

**2.3 Manufacturer**

**Company Name :** Inventec Appliances Corp.  
**Address :** No. 37, Wugong 5th Road, Wugu Industrial Park, Taipei Country 248, Taiwan, R.O.C.

**2.4 Application Details**

**Date of reception of application:** Oct. 31, 2008  
**Start of test :** Dec. 14, 2008  
**End of test :** Dec. 14, 2008



### 3. General Information

#### 3.1 Description of Device Under Test (DUT)

Product Feature & Specification	
DUT Type :	Mobile Computer
Trade Name :	Symbol
Model Name :	FR6074
FCC ID :	H9PFR6074
Tx Frequency :	802.11/g : 2400 MHz ~ 2483.5 MHz Bluetooth : 2400 MHz ~ 2483.5 MHz
Rx Frequency :	802.11b/g : 2400 MHz ~ 2483.5 MHz Bluetooth : 2400 MHz ~ 2483.5 MHz
Maximum Output Power to Antenna :	802.11b : 16.93 dBm 802.11g : 15.57 dBm Bluetooth : 2.91 dBm
Antenna Type :	802.11b/g : PIFA Antenna Bluetooth : PIFA Antenna
HW Version :	DVT
SW Version :	Modem: 0024-010709-M OS: Handy-DVT1-0.31.0057-020209-WWE-H
Type of Modulation :	Bluetooth (1Mbps) : GFSK Bluetooth EDR (2Mbps) : $\pi/4$ -DQPSK Bluetooth EDR (3Mbps) : 8-DPSK 802.11b : DSSS 802.11g : OFDM
DUT Stage :	Identical Prototype

**3.2 Basic Description of Accessories**

<b>Cradle</b>	<b>Brand Name</b>	Symbol
	<b>Model Name</b>	CRD7X00-1
	<b>Power Rating</b>	12Vdc, 3.33A
<b>Cradle Adapter</b>	<b>Brand Name</b>	HIPRO
	<b>Model Name</b>	HP-O2040D43
	<b>Power Rating</b>	I/P: 100-240Vac, 50-60Hz, 1.5A; O/P: 12V, 3.33A
	<b>Power Cord Type</b>	1.8 meter shielded cable with ferrite core
<b>Product Charging Adapter</b>	<b>Brand Name</b>	MOTOROLA
	<b>Model Name</b>	EADP-16BB A
	<b>Power Rating</b>	I/P: 100-240Vac, 50-60Hz, 0.4A; O/P: 5.4V, 3A
<b>Product Charging Cable 1</b>	<b>Power Cord Type</b>	1.83 meter shielded cable without ferrite core
	<b>Brand Name</b>	MOTOROLA
	<b>Part Number</b>	25-102775-01R
<b>Product Charging Cable 2</b>	<b>Power Rating</b>	I/P: 5.4V, 3A
	<b>Power Cord Type</b>	1.35 meter non-shielded cable with ferrite core
	<b>Brand Name</b>	MOTOROLA
<b>Product Charging Cable 2</b>	<b>Part Number</b>	25-118708-01R
	<b>Power Rating</b>	I/P: 5.4V, 3A
	<b>Power Cord Type</b>	1.35 meter non-shielded cable with ferrite core
<b>Battery</b>	<b>Brand Name</b>	MOTOROLA
	<b>Part Number</b>	82-71364-05
	<b>Power Rating</b>	3.7Vdc, 3600mAh, 13.3Wh
	<b>Type</b>	Li-ion
<b>Earphone</b>	<b>Brand Name</b>	Symbol
	<b>Part Number</b>	90-17C28-001R
	<b>Signal Line Type</b>	1.24 meter non-shielded cable without ferrite core
<b>USB Cable</b>	<b>Brand Name</b>	MOTOROLA
	<b>Part Number</b>	25-68596-01R
	<b>Type</b>	1.58 meter shielded cable without ferrite core

**Remark:**

1. The above DUT's information was declared by manufacturer. Please refer to the specifications or user's manual for more detailed description.
2. Product Charging Cable 1 (P/N: 25-102775-01R) and Product Charging Cable 2 (P/N: 25-118708-01R) are exactly the same which was declared by the manufacturer, and only Product Charging Cable 1 (P/N: 25-102775-01R) was performed on all the tests.



**3.3 Product Photos**

Refer to Appendix D.

**3.4 Applied Standards**

The Specific Absorption Rate (SAR) testing specification, method and procedure for this Mobile Computer is in accordance with the following standards:

- 47 CFR Part 2 (2.1093)
- IEEE C95.1-1999
- IEEE P1528-2003
- OET Bulletin 65 Supplement C (Edition 01-01)
- KDB 248227 r1.2
- KDB 648474 D01 v01r05

**3.5 Device Category and SAR Limits**

This device belongs to portable device category because its radiating structure is allowed to be used within 20 centimeters of the body of the user. Limit for General Population/Uncontrolled exposure should be applied for this device, it is 1.6 W/kg as averaged over any 1 gram of tissue.

**3.6 Test Conditions**

**3.6.1 Ambient Condition**

<b>Ambient Temperature</b>	20-24°C
<b>Humidity</b>	<60%

### 3.6.2 Test Configuration

For WLAN link mode, engineering testing software installed on the DUT can provide continuous transmitting RF signal. This RF signal utilized in SAR measurement has almost 100% duty cycle and its crest factor is 1.

The data rates for WLAN SAR testing were set in 11Mbps for 802.11b and 48Mbps for 802.11g due to the highest RF output power. Power tables of 802.11b/g are as below:

**<802.11b>**

Channel	Frequency (MHz)	Data Rate			
		1M bps	2M bps	5.5M bps	11M bps
CH 01	2412 MHz	14.05 dBm	14.06 dBm	15.30 dBm	15.62 dBm
CH 06	2437 MHz	14.22 dBm	14.37 dBm	15.66 dBm	15.99 dBm
CH 11	2462 MHz	15.26 dBm	15.30 dBm	16.55 dBm	<b>16.93 dBm</b>

**<802.11g>**

Channel	Frequency (MHz)	Data Rate							
		6M bps	9M bps	12M bps	18M bps	24M bps	36M bps	48M bps	54M bps
CH 01	2412 MHz	12.19 dBm	13.46 dBm	13.86 dBm	13.76 dBm	13.58 dBm	14.11 dBm	14.39 dBm	13.99 dBm
CH 06	2437 MHz	13.01 dBm	13.74 dBm	13.94 dBm	13.85 dBm	13.86 dBm	14.11 dBm	15.18 dBm	14.81 dBm
CH 11	2462 MHz	13.40 dBm	14.67 dBm	14.82 dBm	14.91 dBm	14.77 dBm	14.96 dBm	<b>15.57 dBm</b>	15.20 dBm

According to the unlicensed transmitters of KDB 648474,

- test highest output channel only if SAR is  $\leq 0.8$  W/kg
- test all required channels if SAR is  $> 0.8$  W/kg

According KDB 648474, the closest separation distance between WLAN and Bluetooth is 5.571cm and output power of Bluetooth is less than  $2P_{Ref}$ , so the standalone SAR of Bluetooth and simultaneous transmission SAR of WLAN and Bluetooth were not required.



## 4. Specific Absorption Rate (SAR)

### 4.1 Introduction

SAR is related to the rate at which energy is absorbed per unit mass in an object exposed to a radio field. The SAR distribution in a biological body is complicated and is usually carried out by experimental techniques or numerical modeling. The standard recommends limits for two tiers of groups, occupational/controlled and general population/uncontrolled, based on a person's awareness and ability to exercise control over his or her exposure. In general, occupational/controlled exposure limits are higher than the limits for general population/uncontrolled.

### 4.2 SAR Definition

The SAR definition is the time derivative (rate) of the incremental energy (dW) absorbed by (dissipated in) an incremental mass (dm) contained in a volume element (dv) of a given density ( $\rho$ ). The equation description is as below:

$$\mathbf{SAR} = \frac{d}{dt} \left( \frac{dW}{dm} \right) = \frac{d}{dt} \left( \frac{dW}{\rho dv} \right)$$

*SAR is expressed in units of Watts per kilogram (W/kg)*

SAR measurement can be either related to the temperature elevation in tissue by

$$\mathbf{SAR} = C \frac{\delta T}{\delta t}$$

, where C is the specific heat capacity,  $\delta T$  is the temperature rise and  $\delta t$  the exposure duration,

or related to the electrical field in the tissue by

$$\mathbf{SAR} = \frac{\sigma |E|^2}{\rho}$$

, where  $\sigma$  is the conductivity of the tissue,  $\rho$  is the mass density of the tissue and  $E$  is the rms electrical field strength.

However for evaluating SAR of low power transmitter, electrical field measurement is typically applied.

## 5. SAR Measurement Setup

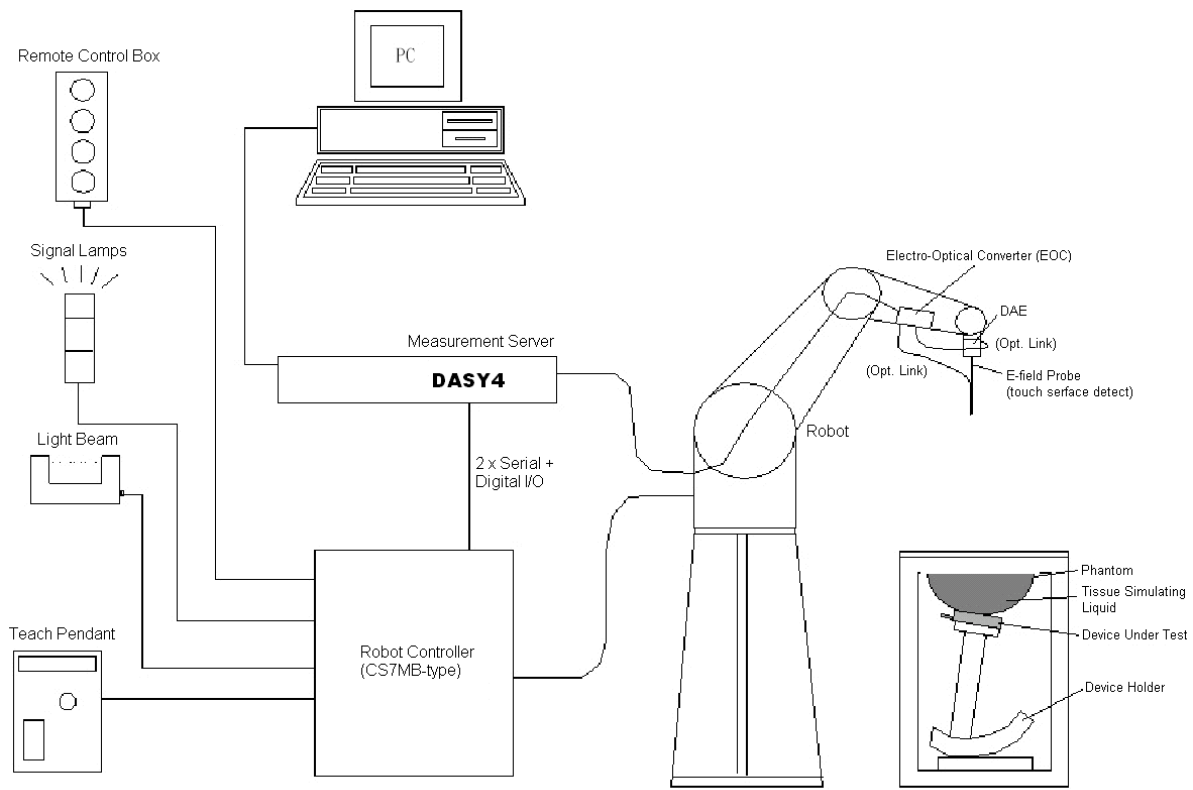

**Fig. 5.1 DASY4 System**

The DASY4 system for performance compliance tests is illustrated above graphically. This system consists of the following items:

- A standard high precision 6-axis robot with controller, a teach pendant and software
- A data acquisition electronic (DAE) attached to the robot arm extension
- A dosimetric probe equipped with an optical surface detector system
- The electro-optical converter (ECO) performs the conversion between optical and electrical signals
- A measurement server performs the time critical tasks such as signal filtering, control of the robot operation and fast movement interrupts.
- A probe alignment unit which improves the accuracy of the probe positioning
- A computer operating Windows XP
- DASY4 software
- Remote control with teach pendant and additional circuitry for robot safety such as warning lamps, etc.
- The SAM twin phantom
- A device holder
- Tissue simulating liquid
- Dipole for evaluating the proper functioning of the system

Some of the components are described in details in the following sub-sections.

**5.1 DASY4 E-Field Probe System**

The SAR measurement is conducted with the dosimetric probe ET3DV6 (manufactured by SPEAG). The probe is specially designed and calibrated for use in liquid with high permittivity. The dosimetric probe has special calibration in liquid at different frequency. This probe has a built in optical surface detection system to prevent from collision with phantom.

**5.1.1 ET3DV6 E-Field Probe Specification**

<ET3DV6>

<b>Construction</b>	Symmetrical design with triangular core Built-in optical fiber for surface detection system Built-in shielding against static charges PEEK enclosure material (resistant to organic solvents)
<b>Frequency</b>	10 MHz to 3 GHz
<b>Directivity</b>	± 0.2 dB in brain tissue (rotation around probe axis) ± 0.4 dB in brain tissue (rotation perpendicular to probe axis)
<b>Dynamic Range</b>	5 μ W/g to 100mW/g; Linearity: ±0.2dB
<b>Surface Detection</b>	± 0.2 mm repeatability in air and clear liquids on reflecting surface
<b>Dimensions</b>	Overall length: 330mm Tip length: 16mm Body diameter: 12mm Tip diameter: 6.8mm Distance from probe tip to dipole centers: 2.7mm
<b>Application</b>	General dosimetry up to 3GHz Compliance tests for mobile phones and Wireless LAN Fast automatic scanning in arbitrary phantoms

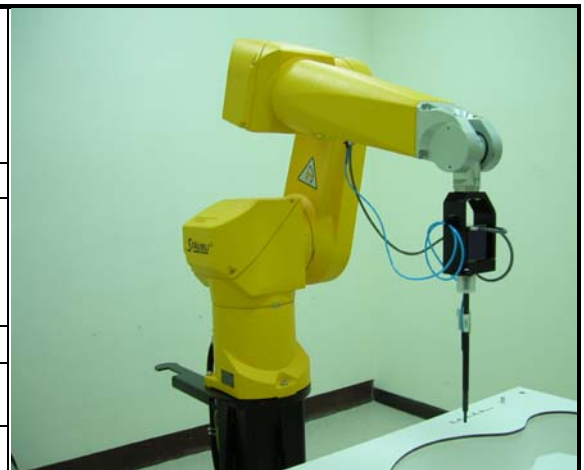

**Fig. 5.2 Probe Setup on Robot**

**5.1.2 ET3DV6 E-Field Probe Calibration**

Each probe needs to be calibrated according to a dosimetric assessment procedure with accuracy better than ± 10%. The spherical isotropy shall be evaluated and within ± 0.25dB. The sensitivity parameters (NormX, NormY, and NormZ), the diode compression parameter (DCP) and the conversion factor (ConvF) of the probe are tested. The calibration data are as below:

➤ ET3DV6 sn1787

<b>Sensitivity</b>	X axis : 1.63 μV	Y axis : 1.67 μV	Z axis : 2.18 μV	
<b>Diode compression point</b>	X axis : 90 mV	Y axis : 93 mV	Z axis : 92 mV	
<b>Conversion factor (Head / Body)</b>	<b>Frequency (MHz)</b>	<b>X axis</b>	<b>Y axis</b>	<b>Z axis</b>
	2350~2550	4.49 / 3.79	4.49 / 3.79	4.49 / 3.79
<b>Boundary effect (Head / Body)</b>	<b>Frequency (MHz)</b>	<b>Alpha</b>	<b>Depth</b>	
	2350~2550	0.77 / 0.90	1.57 / 1.51	

NOTE: The probe parameters have been calibrated by the SPEAG.

### **5.2 DATA Acquisition Electronics (DAE)**

The data acquisition electronics (DAE3) consists of a highly sensitive electrometer-grade preamplifier with auto-zeroing, a channel and gain-switching multiplexer, a fast 16 bit AD-converter and a command decoder and control logic unit. Transmission to the measurement server is accomplished through an optical downlink for data and status information as well as an optical uplink for commands and the clock.

The mechanical probe mounting device includes two different sensor systems for frontal and sideways probe contacts. They are used for mechanical surface detection and probe collision detection.

The input impedance of the DAE3 is 200M Ohm; the inputs are symmetrical and floating. Common mode rejection is above 80dB.

### **5.3 Robot**

The DASY4 system uses the high precision robots RX90BL type out of the newer series from Stäubli SA (France). For the 6-axis controller DASY4 system, the CS7MB robot controller version from Stäubli is used. The RX robot series have many features that are important for our application:

- High precision (repeatability 0.02 mm)
- High reliability (industrial design)
- Jerk-free straight movements
- Low ELF interference (the closed metallic construction shields against motor control fields)
- 6-axis controller

### **5.4 Measurement Server**

The DASY4 measurement server is based on a PC/104 CPU board with  
166 MHz CPU  
32 MB chipset and  
64 MB RAM.

Communication with  
the DAE3 electronic box  
the 16-bit AD-converter system for optical detection and digital I/O interface.

The measurement server performs all the real-time data evaluation for field measurements and surface detection, controls robot movements and handles safety operations.

### 5.5 SAM Twin Phantom

The SAM twin phantom is a fiberglass shell phantom with 2mm shell thickness (except the ear region where shell thickness increases to 6mm). It has three measurement areas:

- Left head
- Right head
- Flat phantom

The bottom plate contains three pair of bolts for locking the device holder. The device holder positions are adjusted to the standard measurement positions in the three sections. A white cover is provided to tap the phantom during off-periods to prevent water evaporation and changes in the liquid parameters. On the phantom top, three reference markers are provided to identify the phantom position with respect to the robot.

The phantom can be used with the following tissue simulating liquids:

- \*Water-sugar based liquid
- \*Glycol based liquids

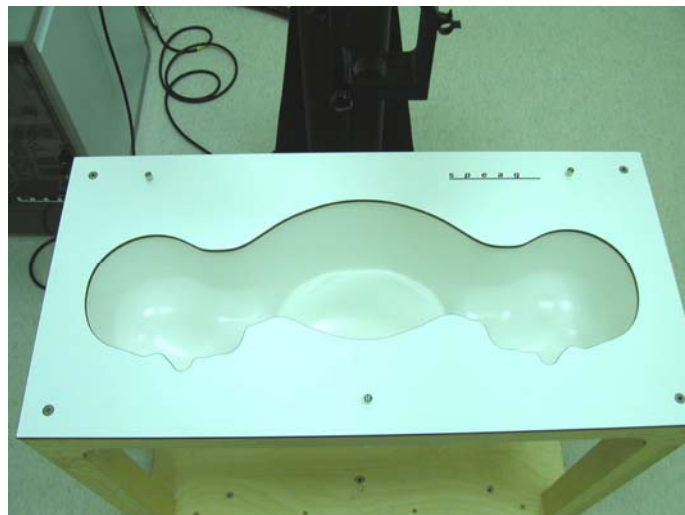

**Fig. 5.3 Top View of Twin Phantom**



**Fig. 5.4 Bottom View of Twin Phantom**

### 5.6 Device Holder for SAM Twin Phantom

The SAR in the Phantom is approximately inversely proportional to the square of the distance between the source and the liquid surface. For a source in 5 mm distance, a positioning uncertainty of  $\pm 0.5\text{mm}$  would produce a SAR uncertainty of  $\pm 20\%$ . An accurate device position is therefore crucial for accurate and repeatable measurement. The position in which the devices must be measured, are defined by the standards.

The DASY4 device holder is designed to cope with different positions given in the standard. It has two scales for the device rotation (with respect to the body axis) and the device inclination (with respect to the line between the ear reference points). The rotation centers for both scales is the ear reference point (EPR).

Thus the device needs no repositioning when changing the angles.

The DASY4 device holder has been made out of low-loss POM material having the following dielectric parameters: relative permittivity  $\epsilon_r = 3$  and loss tangent  $\delta = 0.02$ . The amount of dielectric material has been reduced in the closest vicinity of the device, since measurements have suggested that the influence of the clamp on the test results could thus be lowered.



**Fig. 5.5 Device Holder**



5.7 Data Storage and Evaluation

5.7.1 Data Storage

The DASY4 software stores the assessed data from the data acquisition electronics as raw data (in microvolt readings from the probe sensors), together with all the necessary software parameters for the data evaluation (probe calibration data, liquid parameters and device frequency and modulation data) in measurement files. The post-processing software evaluates the desired unit and format for output each time the data is visualized or exported. This allows verification of the complete software setup even after the measurement and allows correction of erroneous parameter settings. For example, if a measurement has been performed with an incorrect crest factor parameter in the device setup, the parameter can be corrected afterwards and the data can be reevaluated.

The measured data can be visualized or exported in different units or formats, depending on the selected probe type (e.g., [V/m], [A/m], [mW/g]). Some of these units are not available in certain situations or give meaningless results, e.g., a SAR-output in a non-loss media, will always be zero. Raw data can also be exported to perform the evaluation with other software packages.

5.7.2 Data Evaluation

The DASY4 post-processing software (SEMCAD) automatically executes the following procedures to calculate the field units from the microvolt readings at the probe connector. The parameters used in the evaluation are stored in the configuration modules of the software :

<b>Probe parameters :</b>	- Sensitivity	$Norm_i, a_{i,0}, a_{i,1}, a_{i,2}$
	- Conversion factor	$ConvF_i$
	- Diode compression point	$dcp_i$
<b>Device parameters :</b>	- Frequency	$f$
	- Crest factor	$cf$
<b>Media parameters :</b>	- Conductivity	$\sigma$
	- Density	$\rho$

These parameters must be set correctly in the software. They can be found in the component documents or they can be imported into the software from the configuration files issued for the DASY4 components. In the direct measuring mode of the multi-meter option, the parameters of the actual system setup are used. In the scan visualization and export modes, the parameters stored in the corresponding document files are used.

The first step of the evaluation is a linearization of the filtered input signal to account for the compression characteristics of the detector diode. The compensation depends on the input signal, the diode type and the DC-transmission factor from the diode to the evaluation electronics. If the exciting field is pulsed, the crest factor of the signal must be known to correctly compensate for peak power.

The formula for each channel can be given as :

$$V_i = U_i + U_i^2 \cdot \frac{cf}{dcp_i}$$

with  $V_i$  = compensated signal of channel  $i$  ( $i = x, y, z$ )  
 $U_i$  = input signal of channel  $i$  ( $i = x, y, z$ )  
 $cf$  = crest factor of exciting field (DASY parameter)  
 $dcp_i$  = diode compression point (DASY parameter)

From the compensated input signals, the primary field data for each channel can be evaluated :

E-field probes :  $E_i = \sqrt{\frac{V_i}{Norm_i ConvF}}$

H-field probes :  $H_i = \sqrt{V_i} \frac{a_{i0} + a_{i1}f + a_{i2}f^2}{f}$

with  $V_i$  = compensated signal of channel  $i$  ( $i = x, y, z$ )  
 $Norm_i$  = sensor sensitivity of channel  $i$  ( $i = x, y, z$ )  
 $\mu V/(V/m)^2$  for E-field Probes  
 $ConvF$  = sensitivity enhancement in solution  
 $a_{ij}$  = sensor sensitivity factors for H-field probes  
 $f$  = carrier frequency [GHz]  
 $E_i$  = electric field strength of channel  $i$  in V/m  
 $H_i$  = magnetic field strength of channel  $i$  in A/m

The RSS value of the field components gives the total field strength (Hermitian magnitude) :

$$E_{tot} = \sqrt{E_x^2 + E_y^2 + E_z^2}$$

The primary field data are used to calculate the derived field units.

$$SAR = E_{tot}^2 \cdot \frac{\sigma}{\rho \cdot 1000}$$

with  $SAR$  = local specific absorption rate in mW/g  
 $E_{tot}$  = total field strength in V/m  
 $\sigma$  = conductivity in [mho/m] or [Siemens/m]  
 $\rho$  = equivalent tissue density in g/cm<sup>3</sup>

\* Note that the density is set to 1, to account for actual head tissue density rather than the density of the tissue simulating liquid.

The power flow density is calculated assuming the excitation field to be a free space field.

$$P_{pwe} = \frac{E_{tot}^2}{3770} \quad \text{or} \quad P_{pwe} = H_{tot}^2 \cdot 37.7$$

with  $P_{pwe}$  = equivalent power density of a plane wave in mW/cm<sup>2</sup>  
 $E_{tot}$  = total electric field strength in V/m  
 $H_{tot}$  = total magnetic field strength in A/m





5.8 Test Equipment List

Manufacturer	Name of Equipment	Type/Model	Serial Number	Calibration	
				Last Cal.	Due Date
SPEAG	Dosimetric E-Filed Probe	ET3DV6	1787	Aug. 26, 2008	Aug. 25, 2009
SPEAG	2450MHz System Validation Kit	D2450V2	736	Jul. 12, 2007	Jul. 11, 2009
SPEAG	Data Acquisition Electronics	DAE3	577	Nov. 12, 2008	Nov. 11, 2009
SPEAG	Device Holder	N/A	N/A	NCR	NCR
SPEAG	SAM Phantom	QD 000 P40 C	TP-1446	NCR	NCR
SPEAG	SAM Phantom	QD 000 P40 C	TP-1383	NCR	NCR
Agilent	PNA Series Network Analyzer	E8358A	US40260131	Apr. 02, 2008	Apr. 01, 2009
Agilent	Wireless Communication Test Set	E5515C	GB46311322	Dec. 22, 2006	Dec. 21, 2008
R&S	Universal Radio Communication Tester	CMU200	105934	Nov. 11, 2008	Nov. 10, 2009
Agilent	Dielectric Probe Kit	85070D	US01440205	NCR	NCR
Agilent	Dual Directional Coupler	778D	50422	NCR	NCR
AR	Power Amplifier	5S1G4M2	0328767	NCR	NCR
R&S	Power Meter	NRVD	101394	Oct. 20, 2008	Oct. 19, 2009
R&S	Power Sensor	NRV-Z1	100130	Oct. 20, 2008	Oct. 19, 2009

Table 5.1 Test Equipment List

**6. Tissue Simulating Liquids**

For the measurement of the field distribution inside the SAM phantom with DASY4, the phantom must be filled with around 25 liters of homogeneous tissue simulating liquid. The liquid height from the ear reference point (ERP) of the phantom to the liquid top surface is (head SAR) or from the flat phantom to the liquid top surface (body SAR) is 15.2cm.

The following ingredients for tissue simulating liquid are used:

- **Water:** deionized water (pure H<sub>2</sub>O), resistivity  $\geq 16M\Omega$  - as basis for the liquid
- **Sugar:** refined sugar in crystals, as available in food shops – to reduce relative permittivity
- **Salt:** pure NaCl – to increase conductivity
- **Cellulose:** Hydroxyethyl-cellulose, medium viscosity (75-125 mPa.s, 2% in water, 20°C), CAS#54290-to increase viscosity and to keep sugar in solution.
- **Preservative:** Preventol D-7 Bayer AG, D-51368 Leverkusen, CAS#55965-84-9- to prevent the spread of bacteria and molds.
- **DGMBE:** Deithlenglycol-monobuthyl ether (DGMBE), Fluka Chemie GmbH, CAS#112-34-5 – to reduce relative permittivity.

Table 6.1 gives the recipes for one liter of head and body tissue simulating liquid for frequency band 2450 MHz.

Ingredient	HSL-2450	MSL-2450
<b>Water</b>	550.0 ml	698.3 ml
<b>Cellulose</b>	0 g	0 g
<b>Salt</b>	0 g	0 g
<b>Preventol D-7</b>	0 g	0 g
<b>Sugar</b>	0 g	0 g
<b>DGMBE</b>	450.0 ml	301.7 ml
<b>Total amount</b>	1 liter (1.0 kg)	1 liter (1.0 kg)
<b>Dielectric Parameters at 22°</b>	f = 2450MHz $\epsilon_r = 39 \pm 5\%$ , $\sigma = 1.84 \pm 5\%$ S/m	f = 2450MHz $\epsilon_r = 52.7 \pm 5\%$ , $\sigma = 1.95 \pm 5\%$ S/m

**Table 6.1 Recipes for Tissue Simulating Liquid**

The dielectric parameters of the liquids were verified prior to the SAR evaluation using an Agilent 85070D Dielectric Probe Kit and an Agilent Network Analyzer.

Table 6.2 shows the measuring results for head and muscle simulating liquid.

Band	Position	Temperature (°C)	Frequency (MHz)	Conductivity (σ)	Permittivity (ε <sub>r</sub> )	Measurement Date
802.11b/g	Head	21.4	2412	1.82	38.3	Dec. 14, 2008
			2437	1.84	38.2	
			2462	1.86	38.1	
	Body	21.5	2412	1.95	51.3	Dec. 14, 2008
			2437	1.98	51.2	
			2462	2.01	51.1	

**Table 6.2 Measuring Results for Simulating Liquid**

The measuring data are consistent with  $\epsilon_r = 39.2 \pm 5\%$ ,  $\sigma = 1.80 \pm 5\%$  for head 802.11b/g and  $\epsilon_r = 52.7 \pm 5\%$ ,  $\sigma = 1.95 \pm 5\%$  for body 802.11b/g.

## 7. Uncertainty Assessment

The component of uncertainty may generally be categorized according to the methods used to evaluate them. The evaluation of uncertainty by the statistical analysis of a series of observations is termed a Type A evaluation of uncertainty. The evaluation of uncertainty by means other than the statistical analysis of a series of observation is termed a Type B evaluation of uncertainty. Each component of uncertainty, however evaluated, is represented by an estimated standard deviation, termed standard uncertainty, which is determined by the positive square root of the estimated variance.

A Type A evaluation of standard uncertainty may be based on any valid statistical method for treating data. This includes calculating the standard deviation of the mean of a series of independent observations; using the method of least squares to fit a curve to the data in order to estimate the parameter of the curve and their standard deviations; or carrying out an analysis of variance in order to identify and quantify random effects in certain kinds of measurement.

A type B evaluation of standard uncertainty is typically based on scientific judgment using all of the relevant information available. These may include previous measurement data, experience and knowledge of the behavior and properties of relevant materials and instruments, manufacture’s specification, data provided in calibration reports and uncertainties assigned to reference data taken from handbooks. Broadly speaking, the uncertainty is either obtained from an outdoor source or obtained from an assumed distribution, such as the normal distribution, rectangular or triangular distributions indicated in Table 7.1

Uncertainty Distributions	Normal	Rectangular	Triangular	U-shape
<b>Multiplying factor<sup>(a)</sup></b>	1/k <sup>(b)</sup>	1/√3	1/√6	1/√2

(a) standard uncertainty is determined as the product of the multiplying factor and the estimated range of variations in the measured quantity

(b)  $k$  is the coverage factor

**Table 7.1 Multiplying Factions for Various Distributions**

The combined standard uncertainty of the measurement result represents the estimated standard deviation of the result. It is obtained by combining the individual standard uncertainties of both Type A and Type B evaluation using the usual “root-sum-squares” (RSS) methods of combining standard deviations by taking the positive square root of the estimated variances.

Expanded uncertainty is a measure of uncertainty that defines an interval about the measurement result within which the measured value is confidently believed to lie. It is obtained by multiplying the combined standard uncertainty by a coverage factor. Typically, the coverage factor ranges from 2 to 3. Using a coverage factor allows the true value of a measured quantity to be specified with a defined probability within the specified uncertainty range. For purpose of this document, a coverage factor two is used, which corresponds to confidence interval of about 95 %. The DASY4 uncertainty Budget is showed in Table 7.2.



Error Description	Uncertainty Value ± %	Probability Distribution	Divisor	Ci (1g)	Standard Unc. (1g)	vi or Veff
<b>Measurement Equipment</b>						
Probe Calibration	±5.9 %	Normal	1	1	±5.9 %	∞
Axial Isotropy	±4.7 %	Rectangular	√3	0.7	±1.9 %	∞
Hemispherical Isotropy	±9.6 %	Rectangular	√3	0.7	±3.9 %	∞
Boundary Effects	±1.0 %	Rectangular	√3	1	±0.6 %	∞
Linearity	±4.7 %	Rectangular	√3	1	±2.7 %	∞
System Detection Limits	±1.0 %	Rectangular	√3	1	±0.6 %	∞
Readout Electronics	±0.3 %	Normal	1	1	±0.3 %	∞
Response Time	±0.8 %	Rectangular	√3	1	±0.5 %	∞
Integration Time	±2.6 %	Rectangular	√3	1	±1.5 %	∞
RF Ambient Noise	±3.0 %	Rectangular	√3	1	±1.7 %	∞
RF Ambient Reflections	±3.0 %	Rectangular	√3	1	±1.7 %	∞
Probe Positioner	±0.4 %	Rectangular	√3	1	±0.2 %	∞
Probe Positioning	±2.9 %	Rectangular	√3	1	±1.7 %	∞
Max. SAR Eval.	±1.0 %	Rectangular	√3	1	±0.6 %	∞
<b>Test Sample Related</b>						
Device Positioning	±2.9 %	Normal	1	1	±2.9	145
Device Holder	±3.6 %	Normal	1	1	±3.6	5
Power Drift	±5.0 %	Rectangular	√3	1	±2.9	∞
<b>Phantom and Setup</b>						
Phantom Uncertainty	±4.0 %	Rectangular	√3	1	±2.3	∞
Liquid Conductivity (target)	±5.0 %	Rectangular	√3	0.64	±1.8	∞
Liquid Conductivity (meas.)	±2.5 %	Normal	1	0.64	±1.6	∞
Liquid Permittivity (target)	±5.0 %	Rectangular	√3	0.6	±1.7	∞
Liquid Permittivity (meas.)	±2.5 %	Normal	1	0.6	±1.5	∞
<b>Combined Standard Uncertainty</b>					<b>±10.9</b>	<b>387</b>
<b>Coverage Factor for 95 %</b>		<b>K=2</b>				
<b>Expanded uncertainty (Coverage factor = 2)</b>					<b>±21.9</b>	

Table 7.2 Uncertainty Budget of DASY4

## 8. SAR Measurement Evaluation

Each DASY4 system is equipped with one or more system validation kits. These units, together with the predefined measurement procedures within the DASY4 software, enable the user to conduct the system performance check and system validation. System validation kit includes a dipole, tripod holder to fix it underneath the flat phantom and a corresponding distance holder.

### 8.1 Purpose of System Performance check

The system performance check verifies that the system operates within its specifications. System and operator errors can be detected and corrected. It is recommended that the system performance check be performed prior to any usage of the system in order to guarantee reproducible results. The system performance check uses normal SAR measurements in a simplified setup with a well characterized source. This setup was selected to give a high sensitivity to all parameters that might fail or vary over time. The system check does not intend to replace the calibration of the components, but indicates situations where the system uncertainty is exceeded due to drift or failure.

### 8.2 System Setup

In the simplified setup for system evaluation, the DUT is replaced by a calibrated dipole and the power source is replaced by a continuous wave which comes from a signal generator at frequency 2450 MHz. The calibrated dipole must be placed beneath the flat phantom section of the SAM twin phantom with the correct distance holder. The distance holder should touch the phantom surface with a light pressure at the reference marking and be oriented parallel to the long side of the phantom. The equipment setup is shown below:

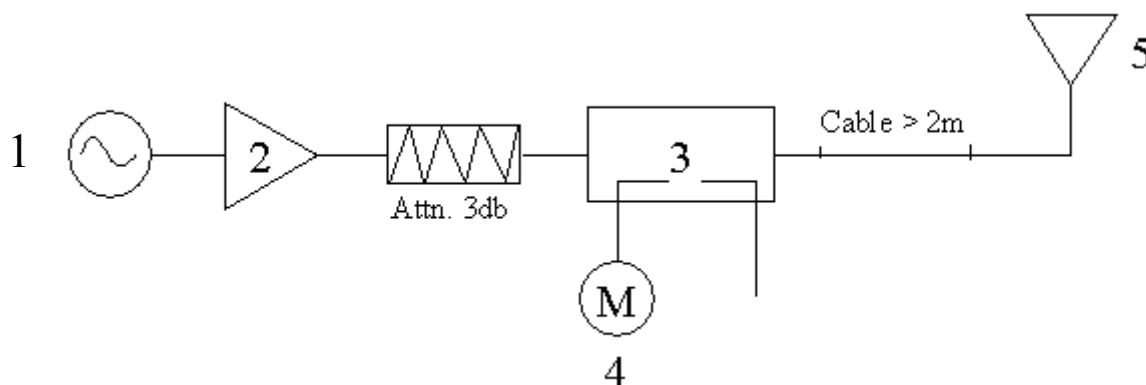

**Fig. 8.1 System Setup for System Evaluation**

1. Signal Generator
2. Amplifier
3. Directional Coupler
4. Power Meter
5. 2450 MHz Dipole

The output power on dipole port must be calibrated to 20dBm (100mW) before dipole is connected.



**Fig 8.2 Dipole Setup**



### 8.3 Validation Results

Comparing to the original SAR value provided by SPEAG, the validation data should be within its specification of 10 %. Table 8.1 shows the target SAR and measured SAR after normalized to 1W input power.

Frequency	Position	SAR	Target (W/kg)	Measurement data (W/kg)	Variation	Measurement Date
2450 MHz	Head	SAR (1g)	52.7	54.6	3.6 %	Dec. 14, 2008
		SAR (10g)	24.5	25.5	4.1 %	
	Body	SAR (1g)	52.5	50.6	-3.6 %	Dec. 14, 2008
		SAR (10g)	24.4	23.3	-4.5 %	

**Table 8.1 Target and Measurement Data Comparison**

The table above indicates the system performance check can meet the variation criterion.



## 9. Description for DUT Testing Position

This DUT was tested in six different positions. They are right cheek, right tilted, left cheek, left tilted, face with 1.5 cm Gap and bottom with 1.5 cm Gap as illustrated below:

### 1) “Cheek Position”

- i) To position the device with the vertical center line of the body of the device and the horizontal line crossing the center piece in a plane parallel to the sagittal plane of the phantom. While maintaining the device in this plane, align the vertical center line with the reference plane containing the three ear and mouth reference point (M, RE and LE) and align the center of the ear piece with the line RE-LE.
- ii) To move the device towards the phantom with the ear piece aligned with the line LE-RE until the phone touched the ear. While maintaining the device in the reference plane and maintaining the phone contact with the ear, move the bottom of the phone until any point on the front side is in contact with the cheek of the phantom or until contact with the ear is lost (see Fig. 9.1).

### 2) “Tilted Position”

- i) To position the device in the “cheek” position described above.
- ii) While maintaining the device the reference plane described above and pivoting against the ear, move it outward away from the mouth by an angle of 15 degrees or until contact with the ear is lost (see Fig. 9.2).

### 3) “Body Worn”

- i) To position the device parallel to the phantom surface.
- ii) To adjust the phone parallel to the flat phantom.
- iii) To adjust the distance between the DUT surface and the flat phantom to 1.5 cm.

Remark: Please refer to Appendix E for the test setup photos.

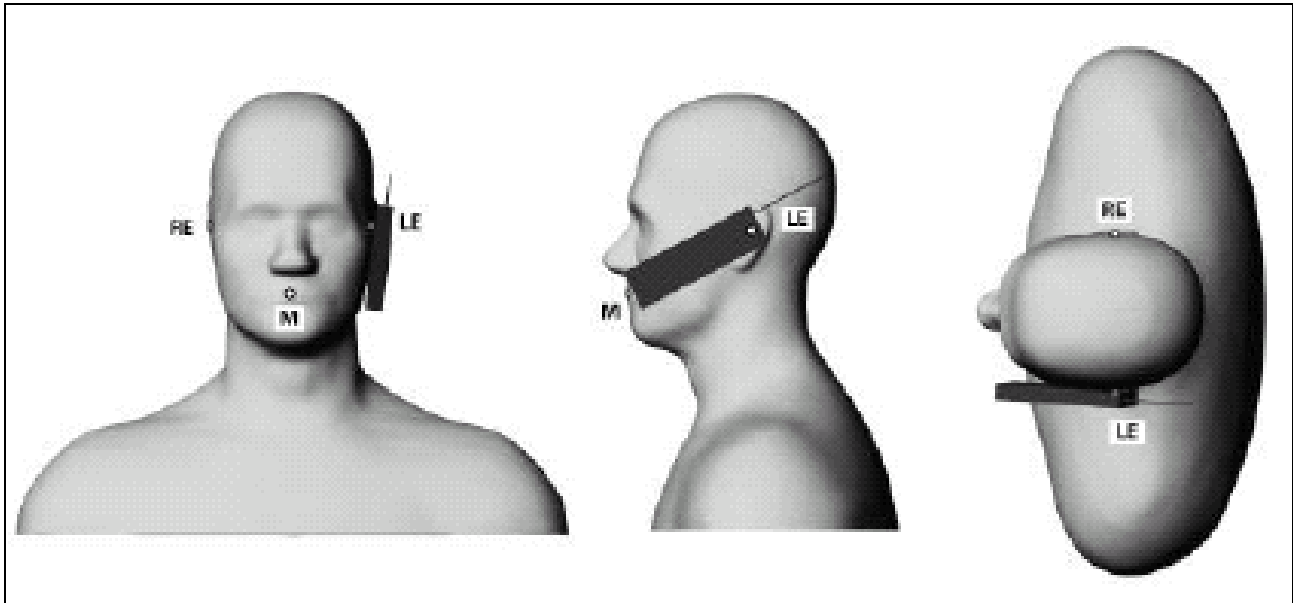

**Fig. 9.1 Phone Position 1, “Cheek” or “Touch” Position.** The reference points for the right ear (RE), left ear (LE) and mouth (M), which define the plane for phone positioning, are indicated.

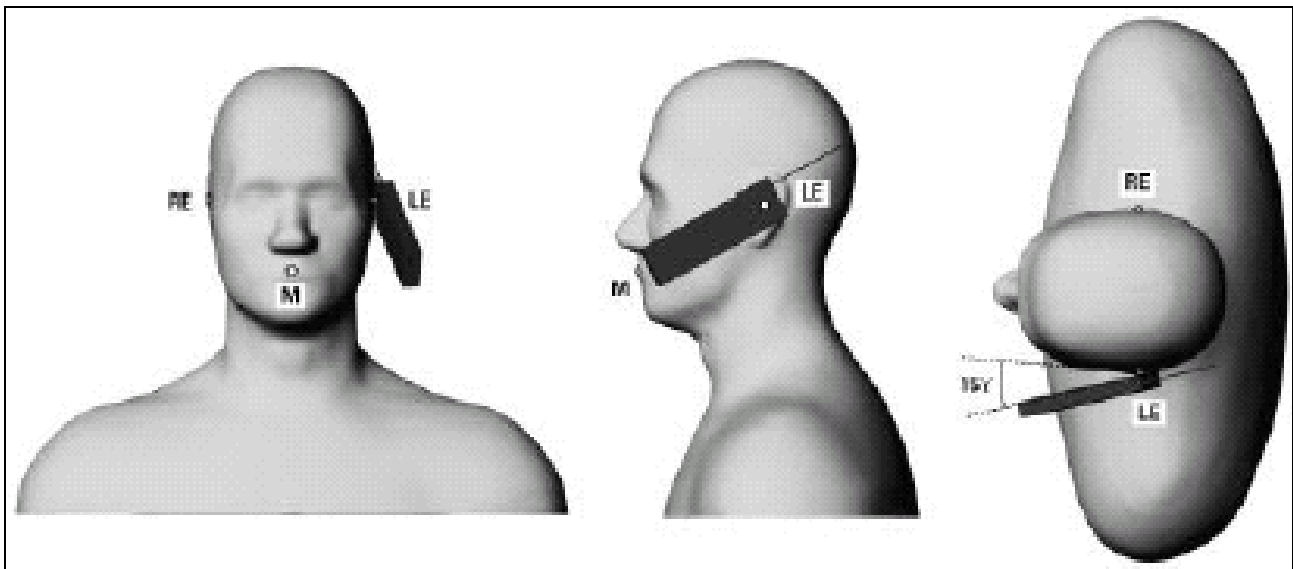

**Fig. 9.2 Phone Position 2, “Tilted Position”.** The reference point for the right ear (RE), left ear (LE) and mouth (M), which define the plane for phone positioning, are indicated.

## **10. Measurement Procedures**

The measurement procedures are as follows:

- Using engineering software to transmit RF power continuously (continuous Tx)
- Measuring output power through RF cable and power meter
- Placing the DUT in the positions described in the last section
- Setting scan area, grid size and other setting on the DASY4 software
- Taking data

According to the IEEE P1528 standard, the recommended procedure for assessing the peak spatial-average SAR value consists of the following steps:

- Power reference measurement
- Area scan
- Zoom scan
- Power reference measurement

### **10.1 Spatial Peak SAR Evaluation**

The procedure for spatial peak SAR evaluation has been implemented according to the IEEE P1528 standard. It can be conducted for 1g and 10g, as well as for user-specific masses. The DASY4 software includes all numerical procedures necessary to evaluate the spatial peak SAR value.

The base for the evaluation is a "cube" measurement. The measured volume must include the 1g and 10g cubes with the highest averaged SAR values. For that purpose, the center of the measured volume is aligned to the interpolated peak SAR value of a previously performed area scan.

The entire evaluation of the spatial peak values is performed within the post-processing engine (SEMCAD). The system always gives the maximum values for the 1g and 10g cubes. The algorithm to find the cube with highest averaged SAR is divided into the following stages:

- extraction of the measured data (grid and values) from the Zoom Scan
- calculation of the SAR value at every measurement point based on all stored data (A/D values and measurement parameters)
- generation of a high-resolution mesh within the measured volume
- interpolation of all measured values from the measurement grid to the high-resolution grid
- extrapolation of the entire 3-D field distribution to the phantom surface over the distance from sensor to surface
- calculation of the averaged SAR within masses of 1g and 10g



## **10.2 Scan Procedures**

First Area Scan is used to locate the approximate location(s) of the local peak SAR value(s). The measurement grid within an Area Scan is defined by the grid extent, grid step size and grid offset. Next, in order to determine the EM field distribution in a three-dimensional spatial extension, Zoom Scan is required. The Zoom Scan measures 5x5x7 points with step size 8, 8 and 5 mm. The Zoom Scan is performed around the highest E-field value to determine the averaged SAR-distribution over 1 g.

## **10.3 SAR Averaged Methods**

In DASY4, the interpolation and extrapolation are both based on the modified Quadratic Shepard's method. The interpolation scheme combines a least-square fitted function method and a weighted average method which are the two basic types of computational interpolation and approximation.

Extrapolation routines are used to obtain SAR values between the lowest measurement points and the inner phantom surface. The extrapolation distance is determined by the surface detection distance and the probe sensor offset. The uncertainty increases with the extrapolation distance. To keep the uncertainty within 1% for the 1 g and 10 g cubes, the extrapolation distance should not be larger than 5 mm.



11. SAR Test Results

11.1 Conducted Power

Band	802.11b (dBm)	802.11g (dBm)
Channel	11 Mbps	48 Mbps
1	15.62	14.39
6	15.99	15.18
11	16.93	15.57

※Unit: dBm

11.2 Test Records for Head SAR Test

Position	Band	Channel	Frequency (MHz)	Modulation Type	Measured 1g SAR (W/kg)	Limit (W/kg)	Result
Right Cheek	802.11b	11	2462	DSSS	0.016	1.6	Pass
Right Cheek	802.11g	11	2462	OFDM	0.014	1.6	Pass
Right Tilted	802.11b	11	2462	DSSS	0.00435	1.6	Pass
Left Cheek	802.11b	11	2462	DSSS	0.012	1.6	Pass
Left Tilted	802.11b	11	2462	DSSS	0.0039	1.6	Pass

11.3 Test Records for Body SAR Test

Position	Band	Channel	Frequency (MHz)	Modulation Type	Measured 1g SAR (W/kg)	Limit (W/kg)	Result
Bottom with 1.5cm Gap	802.11b	11	2462	DSSS	0.019	1.6	Pass
Bottom with 1.5cm Gap	802.11g	11	2462	OFDM	0.012	1.6	Pass
Face with 1.5cm Gap	802.11b	11	2462	DSSS	0.00923	1.6	Pass

Test Engineer : A-Rod Chen, and Jason Wang



## **12. References**

- [1] FCC 47 CFR Part 2 “Frequency Allocations and Radio Treaty Matters; General Rules and Regulations”
- [2] IEEE Std. P1528-2003, “Recommended Practice for Determining the Peak Spatial-Average Specific Absorption Rate (SAR) in the Human Head from Wireless Communications Devices: Measurement Techniques”, April 21, 2003
- [3] Supplement C (Edition 01-01) to OET Bulletin 65 (Edition 97-01), “Additional Information for Evaluating Compliance of Mobile and Portable Devices with FCC Limits for Human Exposure to RF Emissions”, June 2001
- [4] IEEE Std. C95.3-2002, “IEEE Recommended Practice for the Measurement of Potentially Hazardous Electromagnetic Fields-RF and Microwave”, 2002
- [5] IEEE Std. C95.1-1999, “IEEE Standard for Safety Levels with Respect to Human Exposure to Radio Frequency Electromagnetic Fields, 3 kHz to 300 GHz”, 1999
- [6] Robert J. Renka, “Multivariate Interpolation Of Large Sets Of Scattered Data”, University of North Texas ACM Transactions on Mathematical Software, vol. 14, no. 2, June 1988, pp. 139-148
- [7] DASY4 System Handbook
- [8] KDB 248227 r1.2 SAR Measurement Procedures for 802.11abg Transmitters
- [9] KDB 447498 D01 v03r01 Mobile and Portable Device RF Exposure Procedures

## Appendix A - System Performance Check Data

Test Laboratory: Sporton International Inc. SAR/HAC Testing Lab

Date: 2008/12/14

### System Check\_Head\_2450MHz\_081214

#### DUT: Dipole 2450 MHz

Communication System: CW; Frequency: 2450 MHz; Duty Cycle: 1:1

Medium: HSL\_2450 Medium parameters used:  $f = 2450$  MHz;  $\sigma = 1.85$  mho/m;  $\epsilon_r = 38.1$ ;  $\rho = 1000$  kg/m<sup>3</sup>

Ambient Temperature : 22.5 °C; Liquid Temperature : 21.4 °C

#### DASY4 Configuration:

- Probe: ET3DV6 - SN1787; ConvF(4.49, 4.49, 4.49); Calibrated: 2008/8/26
- Sensor-Surface: 4mm (Mechanical Surface Detection)
- Electronics: DAE3 Sn577; Calibrated: 2008/11/12
- Phantom: SAM-Left; Type: QD 000 P40 C; Serial: TP-1477
- Measurement SW: DASY4, V4.7 Build 71; Postprocessing SW: SEMCAD, V1.8 Build 184

**Pin=100mW/Area Scan (91x91x1):** Measurement grid: dx=10mm, dy=10mm

Maximum value of SAR (interpolated) = 6.24 mW/g

**Pin=100mW/Zoom Scan (7x7x7)/Cube 0:** Measurement grid: dx=5mm, dy=5mm, dz=5mm

Reference Value = 59.0 V/m; Power Drift = 0.002 dB

Peak SAR (extrapolated) = 12.0 W/kg

**SAR(1 g) = 5.46 mW/g; SAR(10 g) = 2.55 mW/g**

Maximum value of SAR (measured) = 6.08 mW/g

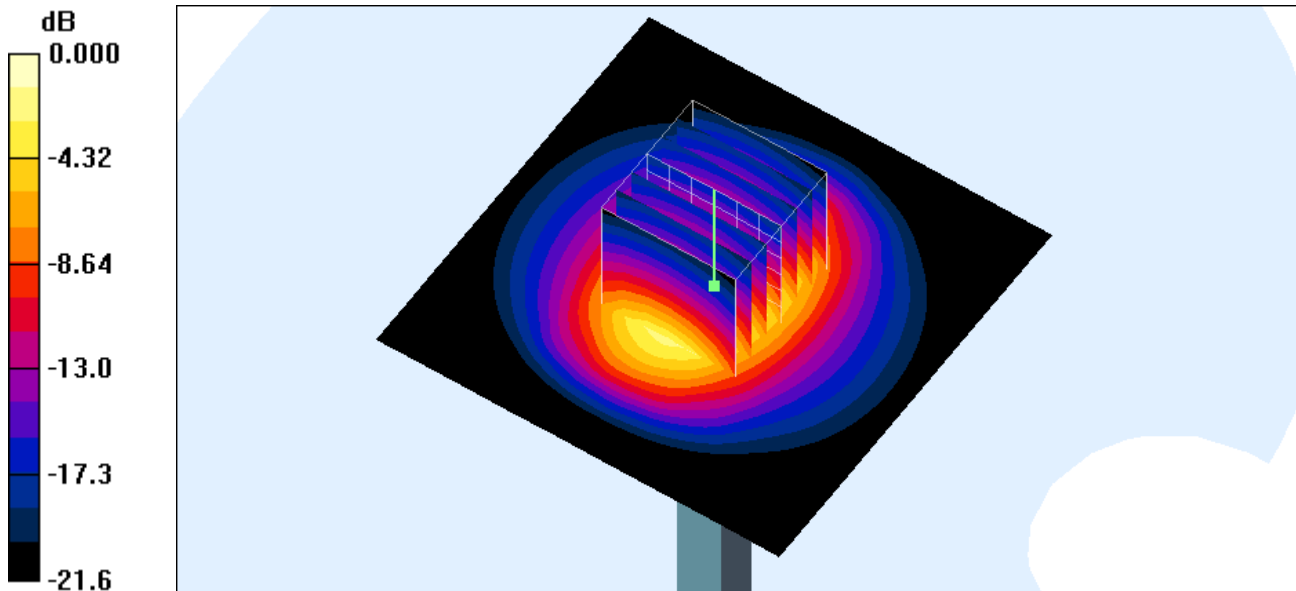

0 dB = 6.08mW/g

Test Laboratory: Sporton International Inc. SAR/HAC Testing Lab

Date: 2008/12/14

**System Check\_Body\_2450MHz\_081214**

**DUT: Dipole 2450 MHz**

Communication System: CW; Frequency: 2450 MHz; Duty Cycle: 1:1  
Medium: MSL\_2450 Medium parameters used:  $f = 2450 \text{ MHz}$ ;  $\sigma = 1.99 \text{ mho/m}$ ;  $\epsilon_r = 51.2$ ;  $\rho = 1000 \text{ kg/m}^3$   
Ambient Temperature : 22.4 °C; Liquid Temperature : 21.5 °C

DASY4 Configuration:

- Probe: ET3DV6 - SN1787; ConvF(3.79, 3.79, 3.79); Calibrated: 2008/8/26
- Sensor-Surface: 4mm (Mechanical Surface Detection)
- Electronics: DAE3 Sn577; Calibrated: 2008/11/12
- Phantom: SAM-Left; Type: QD 000 P40 C; Serial: TP-1477
- Measurement SW: DASY4, V4.7 Build 71; Postprocessing SW: SEMCAD, V1.8 Build 184

**Pin=100mW/Area Scan (91x91x1):** Measurement grid: dx=10mm, dy=10mm  
Maximum value of SAR (interpolated) = 5.77 mW/g

**Pin=100mW/Zoom Scan (7x7x7)/Cube 0:** Measurement grid: dx=5mm, dy=5mm, dz=5mm  
Reference Value = 54.0 V/m; Power Drift = 0.057 dB

Peak SAR (extrapolated) = 11.7 W/kg

**SAR(1 g) = 5.06 mW/g; SAR(10 g) = 2.33 mW/g**

Maximum value of SAR (measured) = 5.64 mW/g

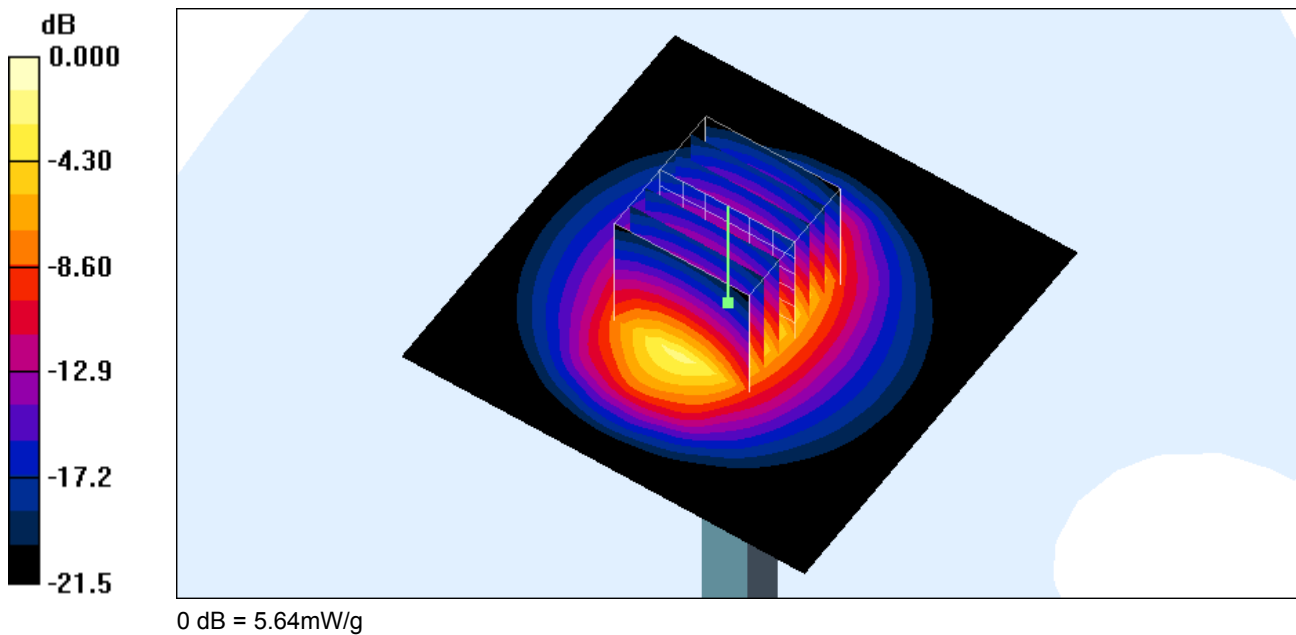



## Appendix B - SAR Measurement Data

Test Laboratory: Sporton International Inc. SAR/HAC Testing Lab

Date: 2008/12/14

Right Cheek\_802.11b Ch11

DUT: 803027-01

Communication System: 802.11b ; Frequency: 2462 MHz;Duty Cycle: 1:1  
Medium: HSL\_2450 Medium parameters used:  $f = 2462$  MHz;  $\sigma = 1.86$  mho/m;  $\epsilon_r = 38.1$ ;  $\rho = 1000$  kg/m<sup>3</sup>  
Ambient Temperature : 22.5 °C; Liquid Temperature : 21.4 °C

DASY4 Configuration:

- Probe: ET3DV6 - SN1787; ConvF(4.49, 4.49, 4.49); Calibrated: 2008/8/26
- Sensor-Surface: 4mm (Mechanical Surface Detection)
- Electronics: DAE3 Sn577; Calibrated: 2008/11/12
- Phantom: SAM-Left; Type: QD 000 P40 C; Serial: TP-1477
- Measurement SW: DASY4, V4.7 Build 71; Postprocessing SW: SEMCAD, V1.8 Build 184

**Ch11/Area Scan (71x141x1):** Measurement grid: dx=15mm, dy=15mm  
Maximum value of SAR (interpolated) = 0.018 mW/g

**Ch11/Zoom Scan (5x5x7)/Cube 0:** Measurement grid: dx=8mm, dy=8mm, dz=5mm  
Reference Value = 1.12 V/m; Power Drift = -0.136 dB  
Peak SAR (extrapolated) = 0.045 W/kg  
**SAR(1 g) = 0.016 mW/g; SAR(10 g) = 0.0076 mW/g**  
Maximum value of SAR (measured) = 0.016 mW/g

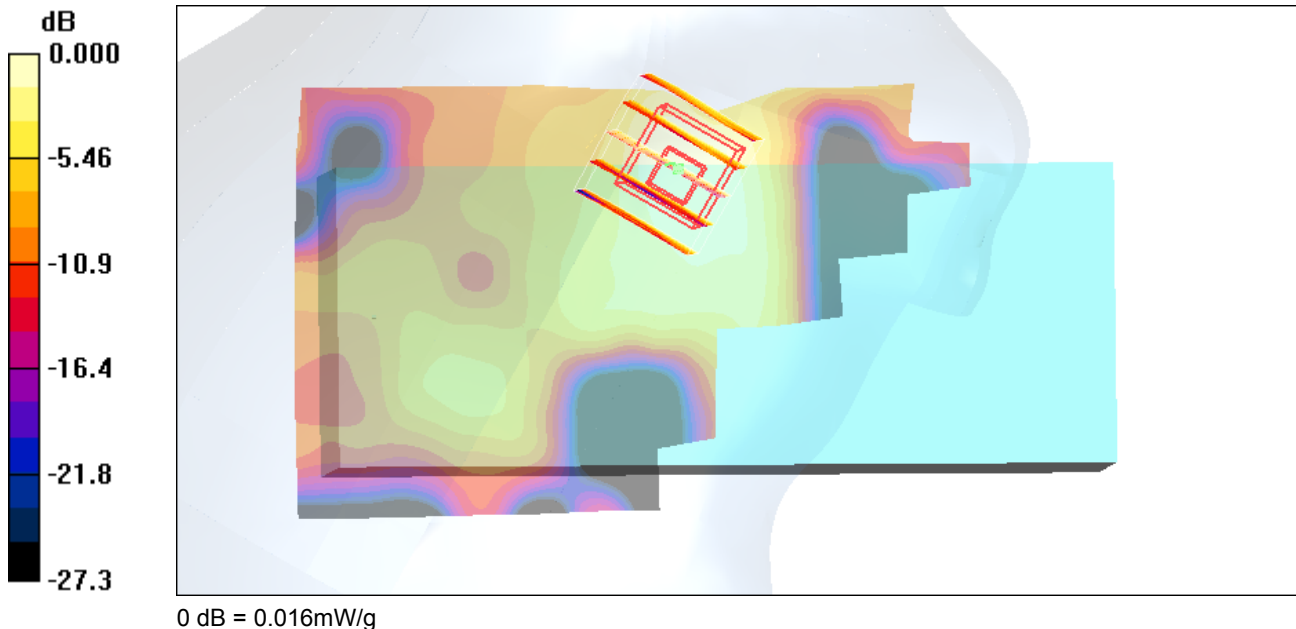

Test Laboratory: Sporton International Inc. SAR/HAC Testing Lab

Date: 2008/12/14

**Right Tilted\_802.11b Ch11**

**DUT: 803027-01**

Communication System: 802.11b ; Frequency: 2462 MHz;Duty Cycle: 1:1  
Medium: HSL\_2450 Medium parameters used:  $f = 2462 \text{ MHz}$ ;  $\sigma = 1.86 \text{ mho/m}$ ;  $\epsilon_r = 38.1$ ;  $\rho = 1000 \text{ kg/m}^3$   
Ambient Temperature : 22.5 °C; Liquid Temperature : 21.4 °C

DASY4 Configuration:

- Probe: ET3DV6 - SN1787; ConvF(4.49, 4.49, 4.49); Calibrated: 2008/8/26
- Sensor-Surface: 4mm (Mechanical Surface Detection)
- Electronics: DAE3 Sn577; Calibrated: 2008/11/12
- Phantom: SAM-Left; Type: QD 000 P40 C; Serial: TP-1477
- Measurement SW: DASY4, V4.7 Build 71; Postprocessing SW: SEMCAD, V1.8 Build 184

**Ch11/Area Scan (71x141x1):** Measurement grid: dx=15mm, dy=15mm  
Maximum value of SAR (interpolated) = 0.007 mW/g

**Ch11/Zoom Scan (5x5x7)/Cube 0:** Measurement grid: dx=8mm, dy=8mm, dz=5mm  
Reference Value = 1.41 V/m; Power Drift = 0.159 dB  
Peak SAR (extrapolated) = 0.017 W/kg  
**SAR(1 g) = 0.00435 mW/g; SAR(10 g) = 0.00165 mW/g**  
Maximum value of SAR (measured) = 0.007 mW/g

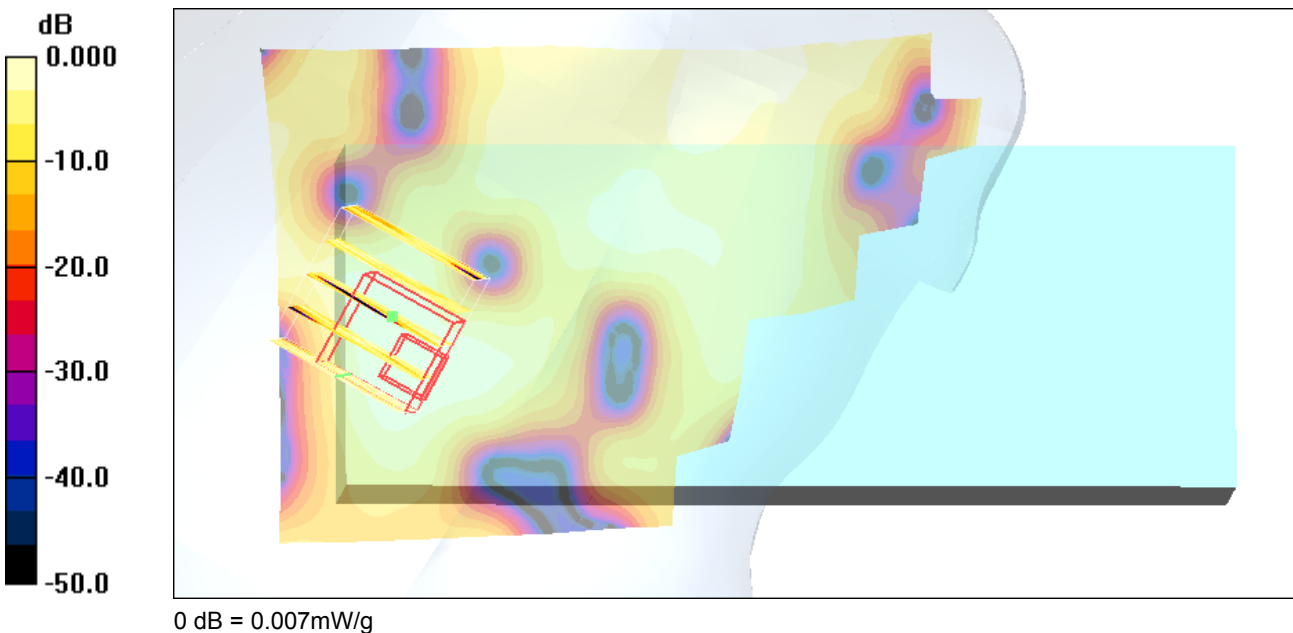

Test Laboratory: Sporton International Inc. SAR/HAC Testing Lab

Date: 2008/12/14

**Left Cheek\_802.11b Ch11**

**DUT: 803027-01**

Communication System: 802.11b ; Frequency: 2462 MHz;Duty Cycle: 1:1  
 Medium: HSL\_2450 Medium parameters used: f = 2462 MHz;  $\sigma = 1.86$  mho/m;  $\epsilon_r = 38.1$ ;  $\rho = 1000$  kg/m<sup>3</sup>  
 Ambient Temperature : 22.5 °C; Liquid Temperature : 21.4 °C

DASY4 Configuration:

- Probe: ET3DV6 - SN1787; ConvF(4.49, 4.49, 4.49); Calibrated: 2008/8/26
- Sensor-Surface: 4mm (Mechanical Surface Detection)
- Electronics: DAE3 Sn577; Calibrated: 2008/11/12
- Phantom: SAM-Left; Type: QD 000 P40 C; Serial: TP-1477
- Measurement SW: DASY4, V4.7 Build 71; Postprocessing SW: SEMCAD, V1.8 Build 184

**Ch11/Area Scan (71x141x1):** Measurement grid: dx=15mm, dy=15mm  
 Maximum value of SAR (interpolated) = 0.013 mW/g

**Ch11/Zoom Scan (5x5x7)/Cube 0:** Measurement grid: dx=8mm, dy=8mm, dz=5mm  
 Reference Value = 1.20 V/m; Power Drift = 0.122 dB  
 Peak SAR (extrapolated) = 0.022 W/kg  
**SAR(1 g) = 0.012 mW/g; SAR(10 g) = 0.00658 mW/g**  
 Maximum value of SAR (measured) = 0.014 mW/g

**Ch11/Zoom Scan (5x5x7)/Cube 1:** Measurement grid: dx=8mm, dy=8mm, dz=5mm  
 Reference Value = 1.20 V/m; Power Drift = 0.122 dB  
 Peak SAR (extrapolated) = 0.018 W/kg  
**SAR(1 g) = 0.00958 mW/g; SAR(10 g) = 0.00556 mW/g**  
 Maximum value of SAR (measured) = 0.012 mW/g

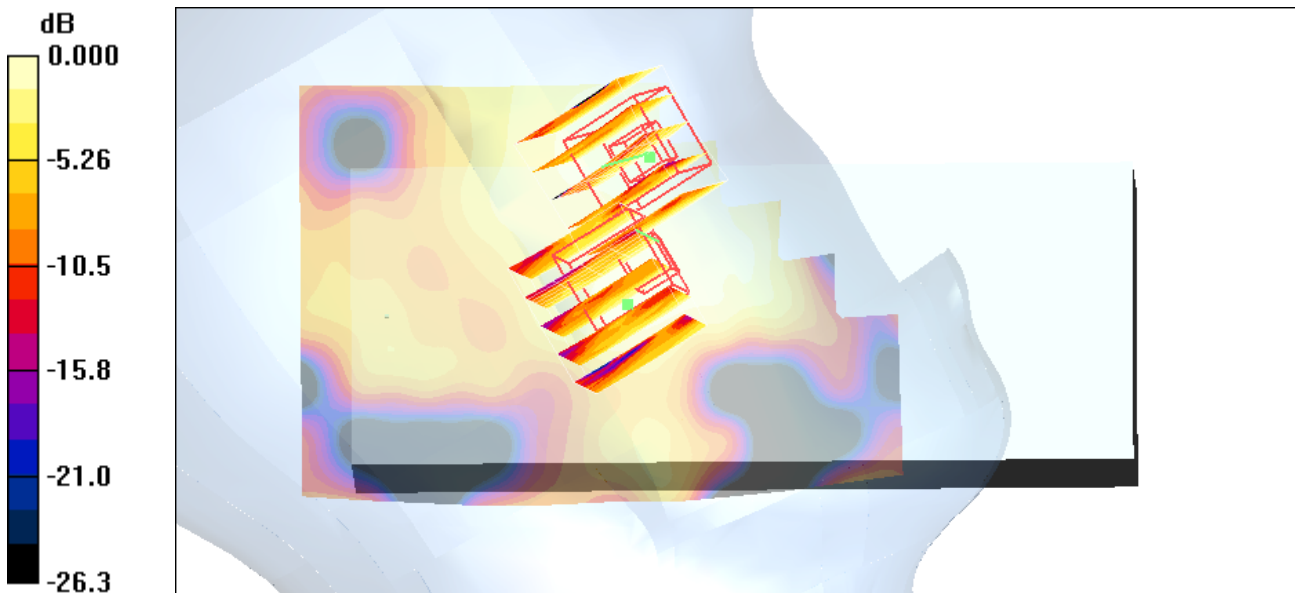

0 dB = 0.012mW/g



Test Laboratory: Sporton International Inc. SAR/HAC Testing Lab

Date: 2008/12/14

**Left Tilted\_802.11b Ch11**

**DUT: 803027-01**

Communication System: 802.11b ; Frequency: 2462 MHz;Duty Cycle: 1:1  
Medium: HSL\_2450 Medium parameters used:  $f = 2462 \text{ MHz}$ ;  $\sigma = 1.86 \text{ mho/m}$ ;  $\epsilon_r = 38.1$ ;  $\rho = 1000 \text{ kg/m}^3$   
Ambient Temperature : 22.4 °C; Liquid Temperature : 21.4 °C

DASY4 Configuration:

- Probe: ET3DV6 - SN1787; ConvF(4.49, 4.49, 4.49); Calibrated: 2008/8/26
- Sensor-Surface: 4mm (Mechanical Surface Detection)
- Electronics: DAE3 Sn577; Calibrated: 2008/11/12
- Phantom: SAM-Left; Type: QD 000 P40 C; Serial: TP-1477
- Measurement SW: DASY4, V4.7 Build 71; Postprocessing SW: SEMCAD, V1.8 Build 184

**Ch11/Area Scan (71x141x1):** Measurement grid: dx=15mm, dy=15mm  
Maximum value of SAR (interpolated) = 0.006 mW/g

**Ch11/Zoom Scan (5x5x7)/Cube 0:** Measurement grid: dx=8mm, dy=8mm, dz=5mm  
Reference Value = 1.46 V/m; Power Drift = -0.106 dB  
Peak SAR (extrapolated) = 0.008 W/kg  
**SAR(1 g) = 0.0039 mW/g; SAR(10 g) = 0.00191 mW/g**  
Maximum value of SAR (measured) = 0.004 mW/g

**Ch11/Zoom Scan (5x5x7)/Cube 1:** Measurement grid: dx=8mm, dy=8mm, dz=5mm  
Reference Value = 1.46 V/m; Power Drift = -0.106 dB  
Peak SAR (extrapolated) = 0.013 W/kg  
**SAR(1 g) = 0.00322 mW/g; SAR(10 g) = 0.00115 mW/g**

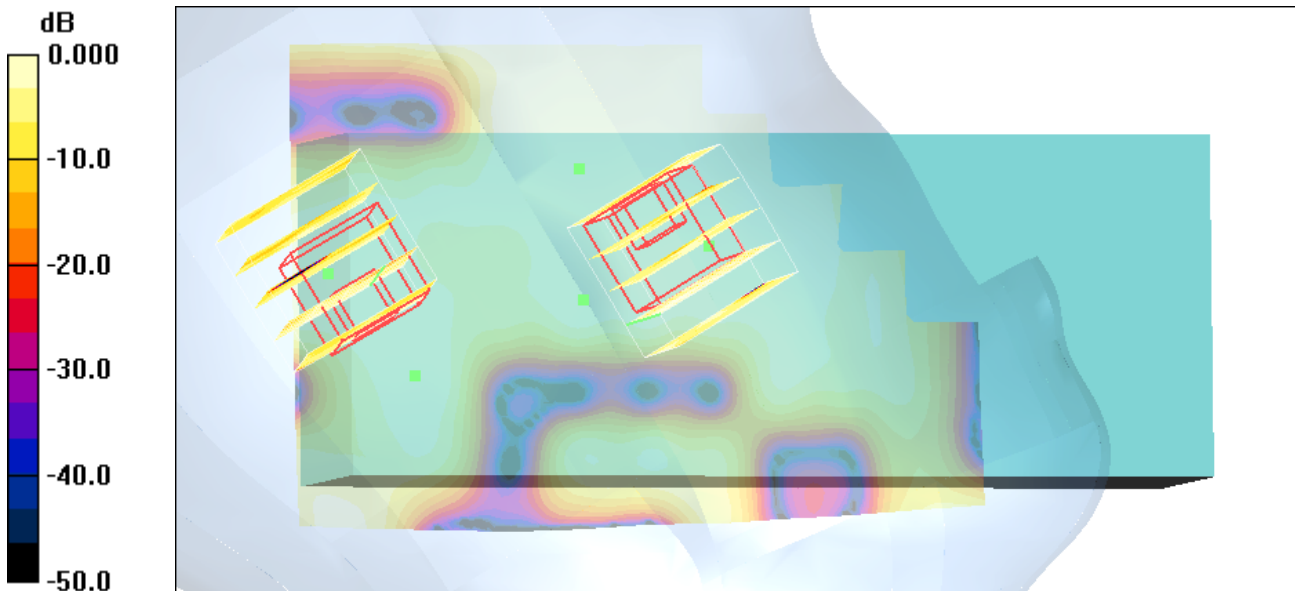

0 dB = 0.004mW/g

Test Laboratory: Sporton International Inc. SAR/HAC Testing Lab

Date: 2008/12/14

**Body\_802.11b Ch11\_Face with 1.5cm Gap**

**DUT: 803027-01**

Communication System: 802.11b ; Frequency: 2462 MHz;Duty Cycle: 1:1  
Medium: MSL\_2450 Medium parameters used:  $f = 2462$  MHz;  $\sigma = 2.01$  mho/m;  $\epsilon_r = 51.1$ ;  $\rho = 1000$  kg/m<sup>3</sup>  
Ambient Temperature : 22.5 °C; Liquid Temperature : 21.5°C

DASY4 Configuration:

- Probe: ET3DV6 - SN1787; ConvF(3.79, 3.79, 3.79); Calibrated: 2008/8/26
- Sensor-Surface: 4mm (Mechanical Surface Detection)
- Electronics: DAE3 Sn577; Calibrated: 2008/11/12
- Phantom: SAM-Left; Type: QD 000 P40 C; Serial: TP-1477
- Measurement SW: DASY4, V4.7 Build 71; Postprocessing SW: SEMCAD, V1.8 Build 184

**Ch11/Area Scan (71x141x1):** Measurement grid: dx=15mm, dy=15mm  
Maximum value of SAR (interpolated) = 0.012 mW/g

**Ch11/Zoom Scan (5x5x7)/Cube 0:** Measurement grid: dx=8mm, dy=8mm, dz=5mm  
Reference Value = 2.01 V/m; Power Drift = -0.129 dB  
Peak SAR (extrapolated) = 0.021 W/kg  
**SAR(1 g) = 0.00923 mW/g; SAR(10 g) = 0.00438 mW/g**  
Maximum value of SAR (measured) = 0.010 mW/g

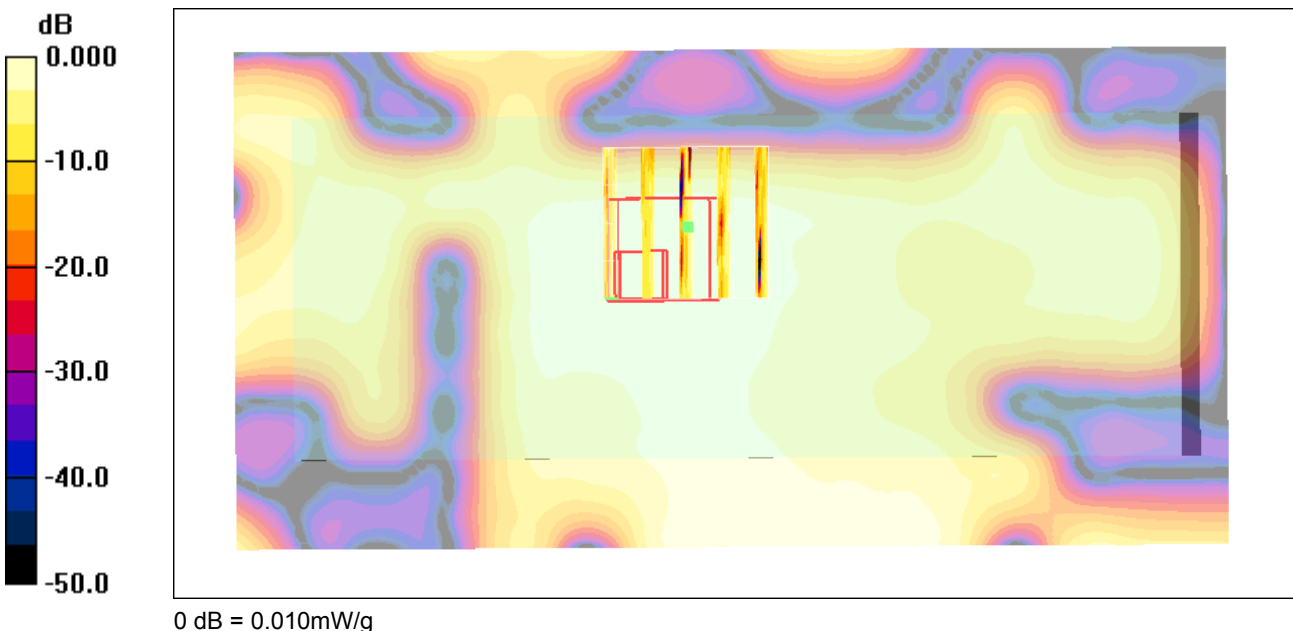

Test Laboratory: Sporton International Inc. SAR/HAC Testing Lab

Date: 2008/12/14

**Body\_802.11b Ch11\_Bottom with 1.5cm Gap**

**DUT: 803027-01**

Communication System: 802.11b ; Frequency: 2462 MHz;Duty Cycle: 1:1  
 Medium: MSL\_2450 Medium parameters used:  $f = 2462 \text{ MHz}$ ;  $\sigma = 2.01 \text{ mho/m}$ ;  $\epsilon_r = 51.1$ ;  $\rho = 1000 \text{ kg/m}^3$   
 Ambient Temperature : 22.5 °C; Liquid Temperature : 21.5 °C

DASY4 Configuration:

- Probe: ET3DV6 - SN1787; ConvF(3.79, 3.79, 3.79); Calibrated: 2008/8/26
- Sensor-Surface: 4mm (Mechanical Surface Detection)
- Electronics: DAE3 Sn577; Calibrated: 2008/11/12
- Phantom: SAM-Left; Type: QD 000 P40 C; Serial: TP-1477
- Measurement SW: DASY4, V4.7 Build 71; Postprocessing SW: SEMCAD, V1.8 Build 184

**Ch11/Area Scan (71x141x1):** Measurement grid: dx=15mm, dy=15mm  
 Maximum value of SAR (interpolated) = 0.019 mW/g

**Ch11/Zoom Scan (5x5x7)/Cube 0:** Measurement grid: dx=8mm, dy=8mm, dz=5mm  
 Reference Value = 2.01 V/m; Power Drift = -0.158 dB  
 Peak SAR (extrapolated) = 0.042 W/kg  
**SAR(1 g) = 0.019 mW/g; SAR(10 g) = 0.011 mW/g**  
 Maximum value of SAR (measured) = 0.019 mW/g

**Ch11/Zoom Scan (5x5x7)/Cube 1:** Measurement grid: dx=8mm, dy=8mm, dz=5mm  
 Reference Value = 2.01 V/m; Power Drift = -0.158 dB  
 Peak SAR (extrapolated) = 0.037 W/kg  
**SAR(1 g) = 0.018 mW/g; SAR(10 g) = 0.011 mW/g**

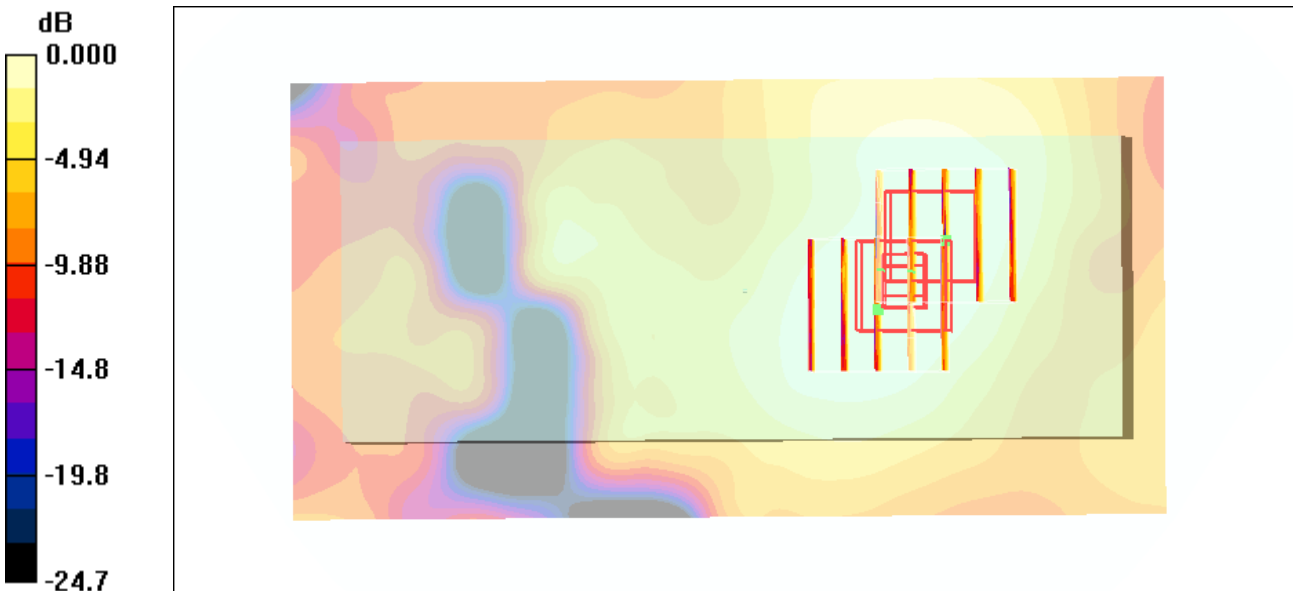

0 dB = 0.019mW/g



Test Laboratory: Sporton International Inc. SAR/HAC Testing Lab

Date: 2008/12/14

**Right Cheek\_802.11b Ch11\_2D**

**DUT: 803027-01**

Communication System: 802.11b ; Frequency: 2462 MHz;Duty Cycle: 1:1  
Medium: HSL\_2450 Medium parameters used:  $f = 2462$  MHz;  $\sigma = 1.86$  mho/m;  $\epsilon_r = 38.1$ ;  $\rho = 1000$  kg/m<sup>3</sup>  
Ambient Temperature : 22.5 °C; Liquid Temperature : 21.4 °C

DASY4 Configuration:

- Probe: ET3DV6 - SN1787; ConvF(4.49, 4.49, 4.49); Calibrated: 2008/8/26
- Sensor-Surface: 4mm (Mechanical Surface Detection)
- Electronics: DAE3 Sn577; Calibrated: 2008/11/12
- Phantom: SAM-Left; Type: QD 000 P40 C; Serial: TP-1477
- Measurement SW: DASY4, V4.7 Build 71; Postprocessing SW: SEMCAD, V1.8 Build 184

**Ch11/Area Scan (71x141x1):** Measurement grid: dx=15mm, dy=15mm  
Maximum value of SAR (interpolated) = 0.018 mW/g

**Ch11/Zoom Scan (5x5x7)/Cube 0:** Measurement grid: dx=8mm, dy=8mm, dz=5mm  
Reference Value = 1.12 V/m; Power Drift = -0.136 dB  
Peak SAR (extrapolated) = 0.045 W/kg  
**SAR(1 g) = 0.016 mW/g; SAR(10 g) = 0.0076 mW/g**  
Maximum value of SAR (measured) = 0.016 mW/g

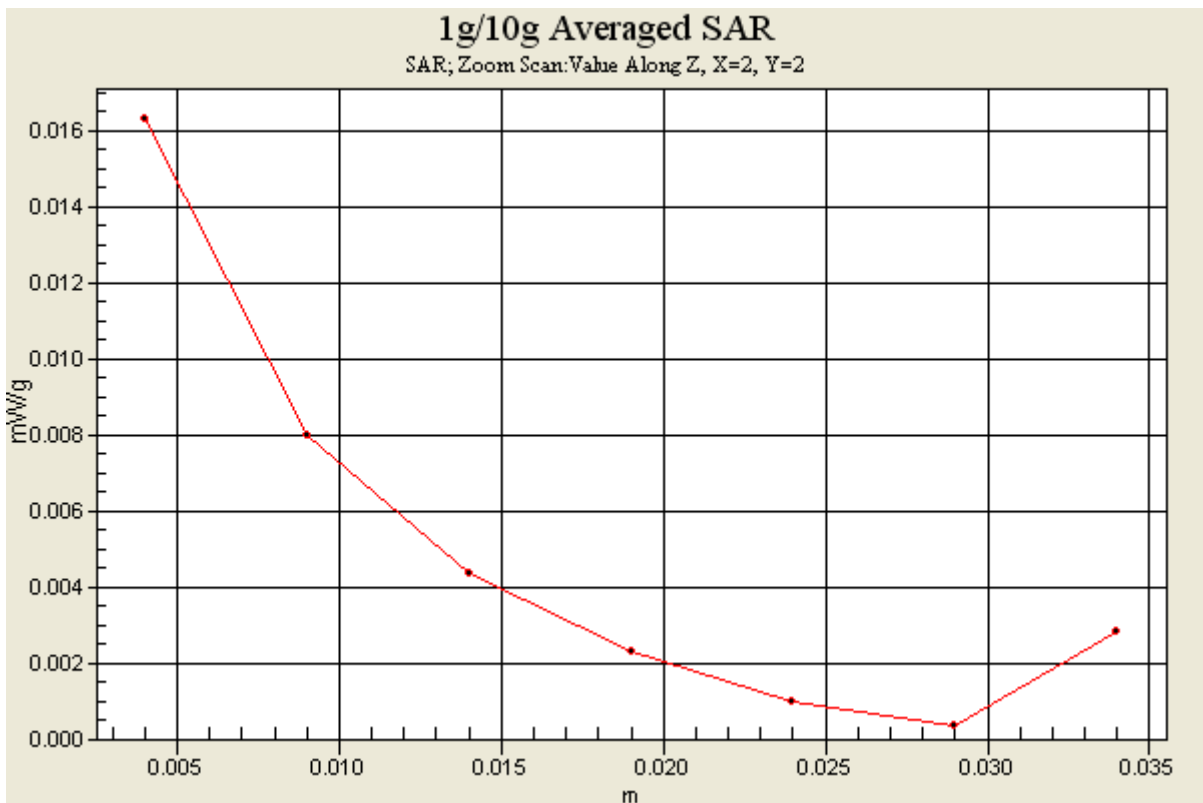



Test Laboratory: Sporton International Inc. SAR/HAC Testing Lab

Date: 2008/12/14

Body\_802.11b Ch11\_Bottom with 1.5cm Gap\_2D

DUT: 803027-01

Communication System: 802.11b ; Frequency: 2462 MHz;Duty Cycle: 1:1

Medium: MSL\_2450 Medium parameters used: f = 2462 MHz;  $\sigma = 2.01$  mho/m;  $\epsilon_r = 51.1$ ;  $\rho = 1000$  kg/m<sup>3</sup>

Ambient Temperature : 22.5 °C ; Liquid Temperature : 21.5 °C

DASY4 Configuration:

- Probe: ET3DV6 - SN1787; ConvF(3.79, 3.79, 3.79); Calibrated: 2008/8/26
- Sensor-Surface: 4mm (Mechanical Surface Detection)
- Electronics: DAE3 Sn577; Calibrated: 2008/11/12
- Phantom: SAM-Left; Type: QD 000 P40 C; Serial: TP-1477
- Measurement SW: DASY4, V4.7 Build 71; Postprocessing SW: SEMCAD, V1.8 Build 184

Ch11/Area Scan (71x141x1): Measurement grid: dx=15mm, dy=15mm

Maximum value of SAR (interpolated) = 0.019 mW/g

Ch11/Zoom Scan (5x5x7)/Cube 0: Measurement grid: dx=8mm, dy=8mm, dz=5mm

Reference Value = 2.01 V/m; Power Drift = -0.158 dB

Peak SAR (extrapolated) = 0.042 W/kg

SAR(1 g) = 0.019 mW/g; SAR(10 g) = 0.011 mW/g

Maximum value of SAR (measured) = 0.019 mW/g

Ch11/Zoom Scan (5x5x7)/Cube 1: Measurement grid: dx=8mm, dy=8mm, dz=5mm

Reference Value = 2.01 V/m; Power Drift = -0.158 dB

Peak SAR (extrapolated) = 0.037 W/kg

SAR(1 g) = 0.018 mW/g; SAR(10 g) = 0.011 mW/g

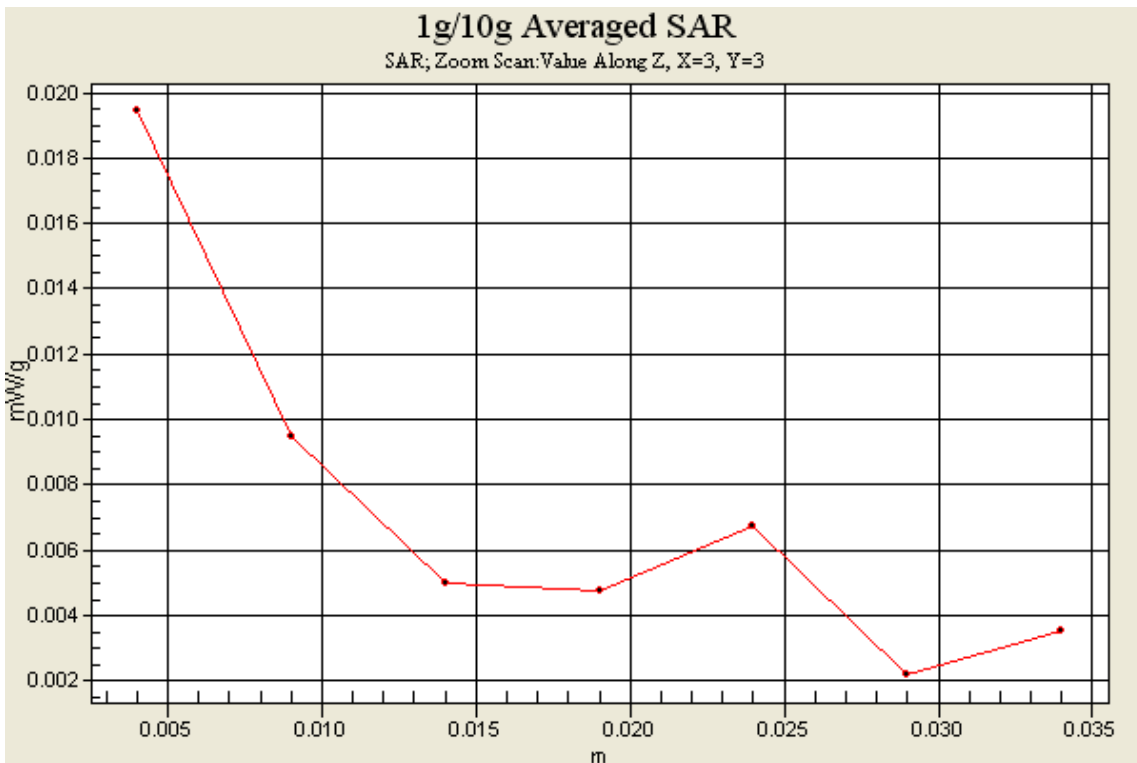





## *Appendix C – Calibration Data*

Please refer to the calibration certificates of DASY as below.