



FCC Part 15.247 Test Report  
for  
Symbol Technologies  
on the  
Spread Spectrum Radio  
Model: DM4046  
FCC ID: H9PDM4046

Test Report #: J20029320  
Date of Report: November 17, 2000

Job #: J20029320  
Date of Test: October 29-31, 2000

Total No. of Pages Contained in this Report: 23 + data pages

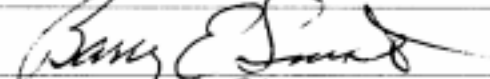

	Barry Smith, Test Engineer
	David Chernomordik, Ph.D., EMC Site Manager

All services undertaken are subject to the following general policy: Reports are submitted for exclusive use of the client to whom they are addressed. Their significance is subject to the adequacy and representative character of the samples and to the comprehensiveness of the tests, examinations or surveys made. This report shall not be reproduced except in full, without written consent of Intertek Testing Services, NA Inc. This report must not be used to claim product endorsement by NVLAP, NIST nor any other agency of the U.S. Government.

FCC Part 15 DSSS Cert, Rev 9/99

**Intertek Testing Services NA, Inc.**

1365 Adams Court, Menlo Park, CA 94025

Telephone 650-463-2900 Fax 650-463-2910 Home Page [www.etlsemko.com](http://www.etlsemko.com)



**Table of Contents**

1.0 Summary of Tests ..... 2

2.0 General Description ..... 3

    2.1 Product Description ..... 3

    2.2 Related Submittal(s) Grants ..... 3

    2.3 Test Methodology ..... 4

    2.4 Test Facility ..... 4

3.0 System Test Configuration ..... 5

    3.1 Support Equipment and description ..... 5

    3.2 Block Diagram of Test Setup ..... 5

    3.3 Justification ..... 6

    3.4 Software Exercisc Program ..... 6

    3.5 Mode of Operation During Test ..... 0

    3.6 Modifications Required for Compliance ..... 7

    3.7 Additions, deviations and exclusions from standards ..... 7

4.0 Measurement Results ..... 8

    4.1 Conducted Output Power at Antenna Tcrminals ..... 8

    4.2 6 dB RF Bandwidth ..... 9

    4.3 Power Density Reading ..... 10

    4.4 Out-of-Band Conducted Emissions ..... 11

    4.5 Out-of-Band Radiated Emissions ..... 12

    4.6 Transmitter Rndintcd Emissions in Restricted Bands.. ..... 13

    4.7 AC Line Conducted Emission ..... 16

    4.x Radiated Emissions from Digital Section of Transceiver ..... 17

    4.0 Radiated Emissions from Receiver Section of Transceiver (L.O. Radiation) ..... 19

    4.10 Processing Gain ..... 20

    4.1 I Transmitter Duty Cycle Calculation and Measurements ..... 21

5.0 List of test equipment ..... 19

6.0 Document History ..... 20

Symbol Technologies,  
FCC ID: H9PDM4046

Date of Test: October 29-31, 2000

1.0 Summary of Tests

**MODEL: DM4046**  
**FCC ID: H9PDM4046**

TEST	REFERENCE	RESULTS
Conducted Output Power.	15.247(b)	Pass
6 dB Bandwidth	15.247(a)(2)	Pass
Power Density	15.247(d)	Pass
Out-of-Band Antenna Conducted Emission	15.247(c)	Pass
Out-of-Band Radiated Emission	15.247(c)	N/A. EUT pass out-of-band antenna conducted emission
Radiated Emission in Restricted Bands	15.247(c)	Pass
AC Conducted Emission	15.207	Pass
Radiated Emission from Digital Part	15.109	Pass
Radiated Emission from Receiver L.O.	15.109	N/A. Receiver operating frequency is above 960 MHz
Processing Gain	15.247(e)	Pass
Antenna Requirement	15.203	Pass
RF Exposure Requirement	2.1093	N/A. Source-based averaged RF power is below 100 mW

Test Engineer:

  
Barry Smith

Date:

11/20/00

Reviewer:

  
David Chernomordik, Ph.D.  
EMC Site Manager

Date:

11/20/00

Symbol Technologies,  
FCC ID: H9PDM4046

Date of Test: October 29-31, 2000

## 2.0 General Description

### 2.1 Product Description

This EUT is used in two configurations. The DP4046 is the EUT mounted in an integrated Voice Communication device with bar code scanner and two antennas for spatial diversity.

The NP4046 is a Voice Communication device with a single antenna driven by the EUT.

A pre-production version of the sample was received on October 28, 2000 in good condition.

### Overview of the Model No. DM4046

Applicant	Symbol Technologies
Trade Name & Model No.	Symbol Technologies/DM4046
FCC Identifier	H9PDM4046
Use of Product	Wireless voice communication
Manufacturer & Model of Spread Spectrum Module	Symbol Technologies
Type of Transmission	Direct Sequence Spread Spectrum
Rated RF Output	145 mW
Frequency Range (MHz)	2412 - 2462
Number of Channel(s)	11
Data transfer rate	11 Mbps
Antenna(s) & Gain, dBi	Screw-in antenna, 0 dBi Stick-on antenna, 2 dBi PCB board antenna, 2 dBi
Processing Gain	More than 10 dB
Antenna Requirement	<input type="checkbox"/> The EUT uses a permanently connected antenna. <input checked="" type="checkbox"/> The antenna is affixed to the EUT using a unique connector, which allows for replacement of a broken antenna, but DOES NOT use a standard antenna jack or electrical connector. <input type="checkbox"/> The EUT requires professional installation (attach supporting documentation if using this option).
Manufacturer name & address	Symbol Technologies 2145 Hamilton Avenue San Jose, CA 95125

### 2.2 Related Submittal(s) Grants

The radio topology is identical to the FCC ID H9PLA4121. The difference between the two is that this radio is mechanically changed to fit inside a family of Voice over IP Communication devices. The H9PLA4121 is in a PC Card configuration.

### 2.3 Test Methodology

Both AC mains line-conducted and radiated emissions measurements were performed according to the procedures in ANSI C63.4 (1992). Radiated tests were performed at an antenna to EUT distance of 3 meters, unless stated otherwise in the "**Data Sheet**" of this Application. All other measurements were made in accordance with the procedures in part 2 of CFR 47.

### 2.4 Test Facility

The open area test site and conducted measurement facility used to collect the radiated data is site 2. This test facility and site measurement data have been fully placed on file with the FCC and NVLAP accredited.

**3.0 System Test Configuration**

3.1 Support Equipment and description

Item #	Description	Model No.	Serial No.
1	FH phone	ND3010	F574876
2	FH hub	AP-302C	P886389
3	DS hub	AP-4111	00A0F88B4367
4	Ethernet hub	EN104	SB15A94004450
5	Dell laptop	PPL	ZHWTD

3.2 Block Diagram of Test Setup

For transmitter testing

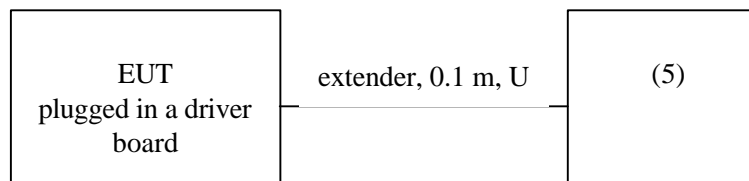

For digital part and receiver testing

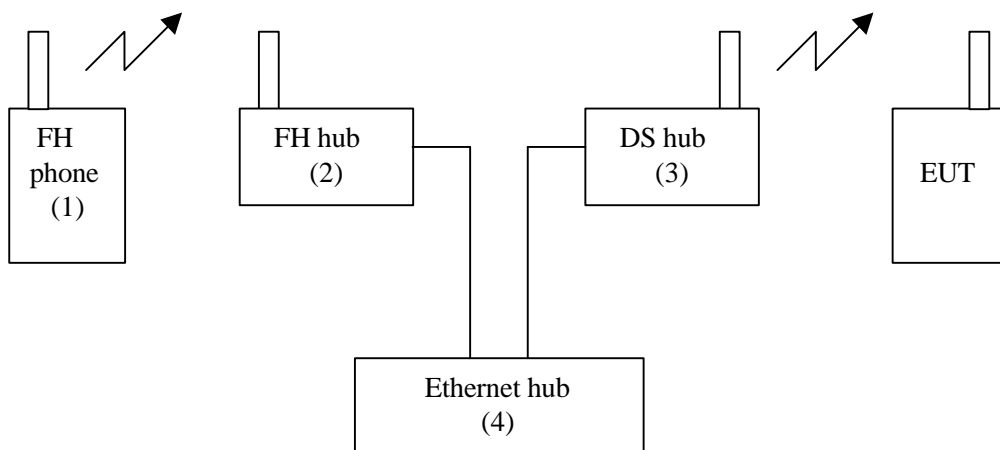

* = EUT	S = Shielded;	F = With Ferrite
** = No ferrites on video cable	U = Unshielded	

### 3.3 Justification

For emission testing, the equipment under test (EUT) was configured for testing in a typical fashion (as a customer would normally use it). During testing, all cables were manipulated to produce worst case emissions.

For radiated emission measurements, the EUT is attached to a cardboard box (if necessary) and placed on the wooden turntable. If the EUT attaches to peripherals, they are connected and operational (as typical as possible). The EUT is wired to transmit full power.

The signal is maximized through rotation and placement in the three orthogonal axes. The antenna height and polarization are varied during the search for maximum signal level. The antenna height is varied from 1 to 4 meters.

Radiated emissions are taken at three meters unless the signal level is too low for measurement at that distance. If necessary, a pre-amplifier is used and/or the test is conducted at a closer distance. All readings are extrapolated back to the equivalent 3-meter reading using inverse scaling with distance.

### 3.4 Software Exercise Program

The EUT exercise program used during radiated and conducted testing was designed to exercise the various system components in a manner similar to a typical use. For emissions testing, the units were setup to transmit continuously to simplify the measurement methodology. Care was taken to ensure proper power supply voltages during testing.

### 3.5 Mode of Operation during Test

For emissions testing, the EUT was setup to transmit continuously to simplify the measurement methodology. The transmitting signal was set to low, middle, and high frequencies.

Symbol Technologies,  
FCC ID: H9PDM4046

Date of Test: October 29-31, 2000

---

3.6 Modifications Required for Compliance

The following modifications were installed during compliance testing in order to bring the product into compliance (Please note that this list does not include changes made specifically by Glenayre Western Multiplex prior to compliance testing):

No modifications were made by Intertek Testing Services

3.7 Additions, deviations and exclusions from standards

No additions, deviations, or exclusions were made to the standard.



Symbol Technologies,  
FCC ID: H9PDM4046

Date of Test: October 29-31, 2000

**4.0 Measurement Results**

## 4.1 Conducted Output Power at Antenna Terminals, FCC Rules 15.247(b)

Requirements:

For antennas with gains of 6 dBi or less, maximum allowed transmitter output power is 1 watt (+30 dBm). For antennas with gains greater than 6 dBi, transmitter output level must be decreased by an amount equal to (GAIN - 6) dB.

Procedure:

- The antenna port of the EUT was connected to the input of a peak power meter. Power was read directly and cable loss correction was added to the reading to obtain power at the EUT antenna terminals.
- The antenna port of the EUT was connected to the input of a spectrum analyzer. The analyzer was set for maximum RES BW and power was read directly in dBm. External attenuation and cable loss were compensated for using the OFFSET function of the analyzer.

Test Result:

Frequency (MHz)	Output in dBm	Output in mWatt
Low Channel: 2412.0	20.4	109.6
Mid Channel: 2437.0	21.3	134.9
High Channel: 2462.0	21.6	144.5

Cable loss: 0.3 dBExternal Attenuation: 10.0 dB

Cable loss, external attenuation:

- included in OFFSET function  
 added to SA raw reading

The maximum antenna gain is 2 dBi, therefore the maximum allowed peak output power equal 30 dBm

Symbol Technologies,  
FCC ID: H9PDM4046

Date of Test: October 29-31, 2000

4.2 6 dB RF Bandwidth, FCC Rule 15.247(a)(2)

The antenna port of the EUT was connected to the input of a spectrum analyzer. Analyzer RES BW was set to 100 kHz. For each RF output channel investigated, the spectrum analyzer center frequency was set to the channel carrier. A PEAK output reading was taken, a DISPLAY line was drawn 6 dB lower than PEAK level. The 6 dB bandwidth was determined from where the channel output spectrum intersected the display line.

Frequency (MHz)	Min. 6 dB Bandwidth (MHz)
2412	10.3

Refer to the following plots for 6 dB bandwidth sharp:

Plot 2a: Low Channel 6 dB RF Bandwidth

Plot 2b: Mid Channel 6 dB RF Bandwidth

Plot 2c: High Channel 6 dB RF Bandwidth

Plot 2a.

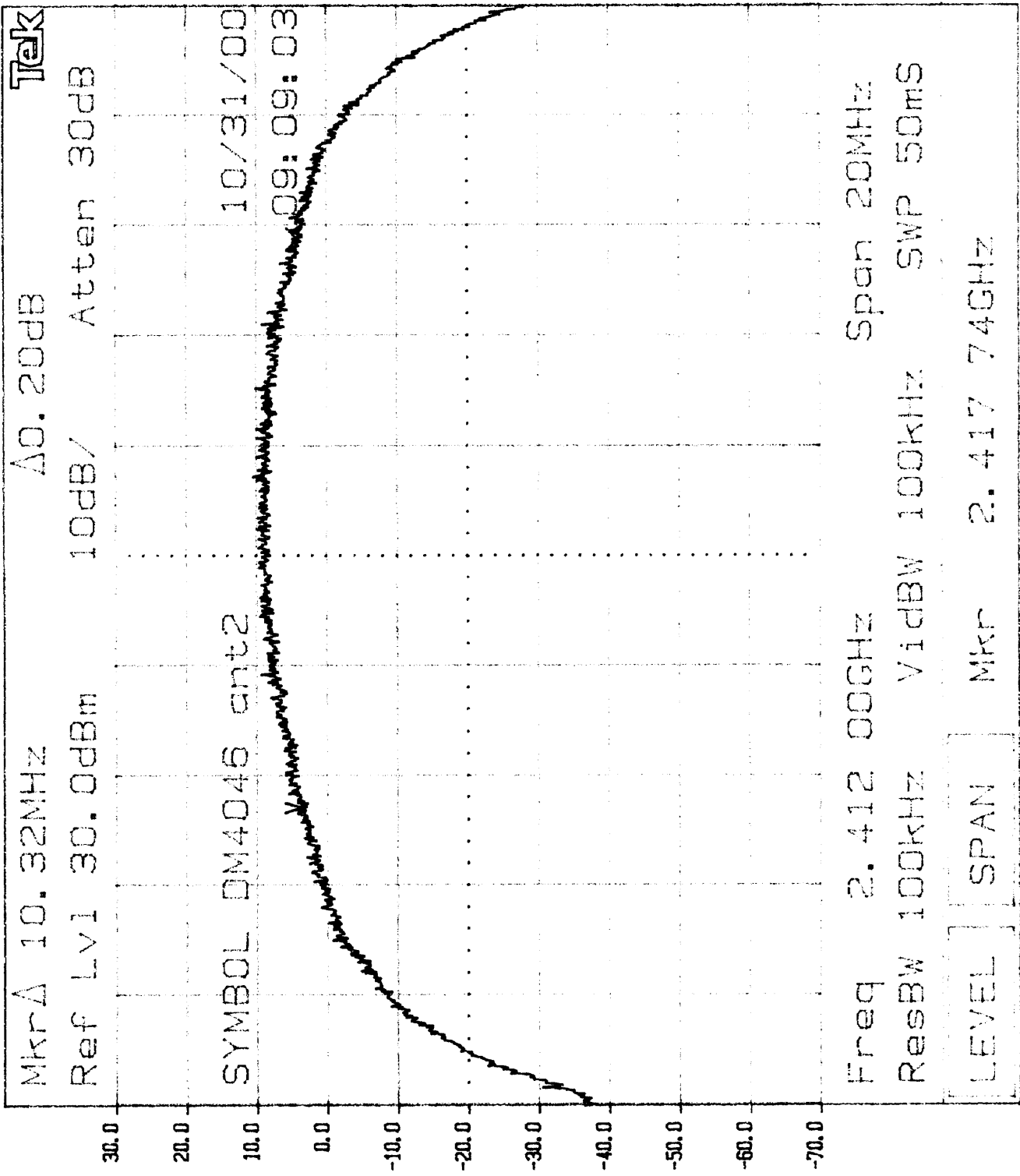

Plot 26

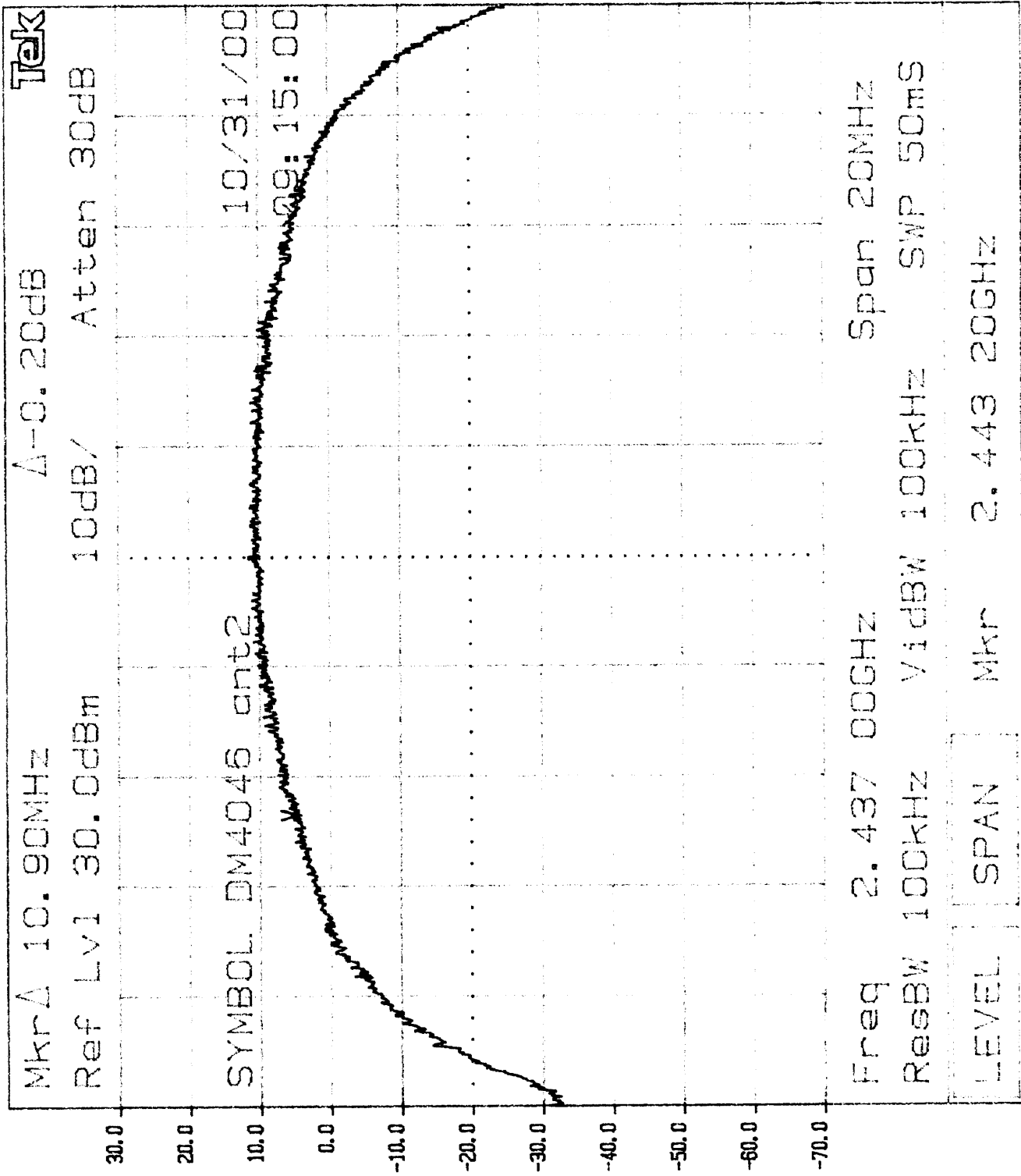

Mkr  $\Delta$  10.34MHz  $\Delta$  10.00dB Tek

Ref Lvl 30.0dBm 10dB/ Atten 30dB

SYMBOL DM4046 ant2 10/31/00  
09:18:03

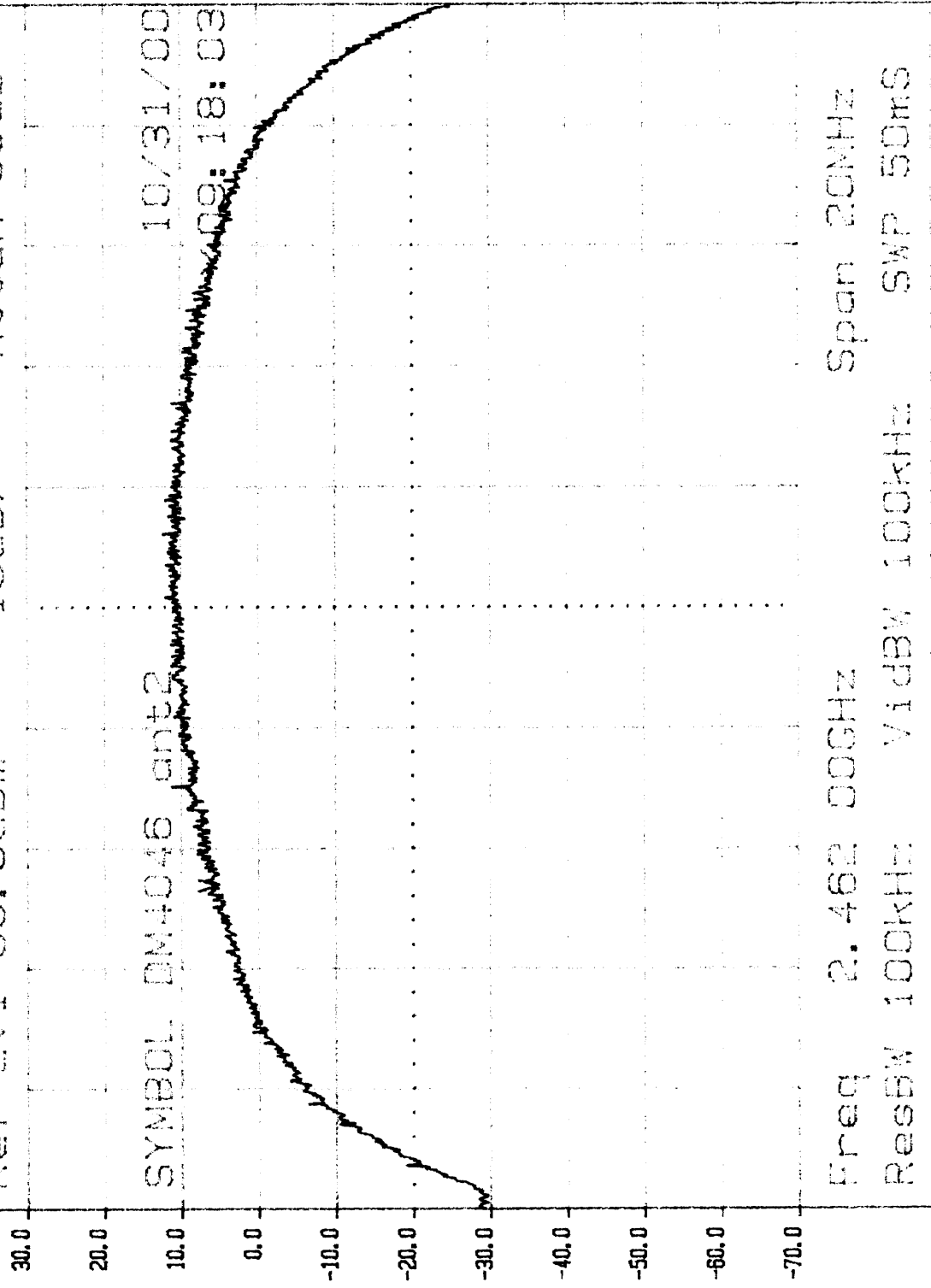

Plot 2c

LEVEL SPAN

Symbol Technologies,  
FCC ID: H9PDM4046

Date of Test: October 29-31, 2000

## 4.3 Power Density, FCC Rule 15.247(d)

The spectrum analyzer RES BW was set to 3 kHz. The START and STOP frequencies were set to the band edges of the maximum output passband. If there is no clear maximum amplitude in any given portion of the band, it may be necessary to make measurements at a number of bands defined by several START and STOP frequency pairs. The specification calls for a 1 second interval at each 3 kHz bandwidth; total SWEEP TIME is calculated as follows:

$$\text{SWEEP TIME (SEC)} = (\text{Fstop, kHz} - \text{Fstart, kHz}) / 3 \text{ kHz}$$

Antenna output of the EUT was coupled directly to spectrum analyzer; if an external attenuator and/or cable was used, these losses are compensated for with the analyzer OFFSET function.

Frequency	Maximum Power Density	Power Density Limit
2437 MHz	-3.0 dBm	8.0 dBm

Frequency Span = 600 kHz

Sweep Time = Frequency Span/3 kHz  
= 200 seconds

Refer to the following plots for power density data:

Plot 3.a: Low Channel Power Density

Plot 3.b: Mid Channel Power Density

Plot 3.c: High Channel Power Density

Plot 3a

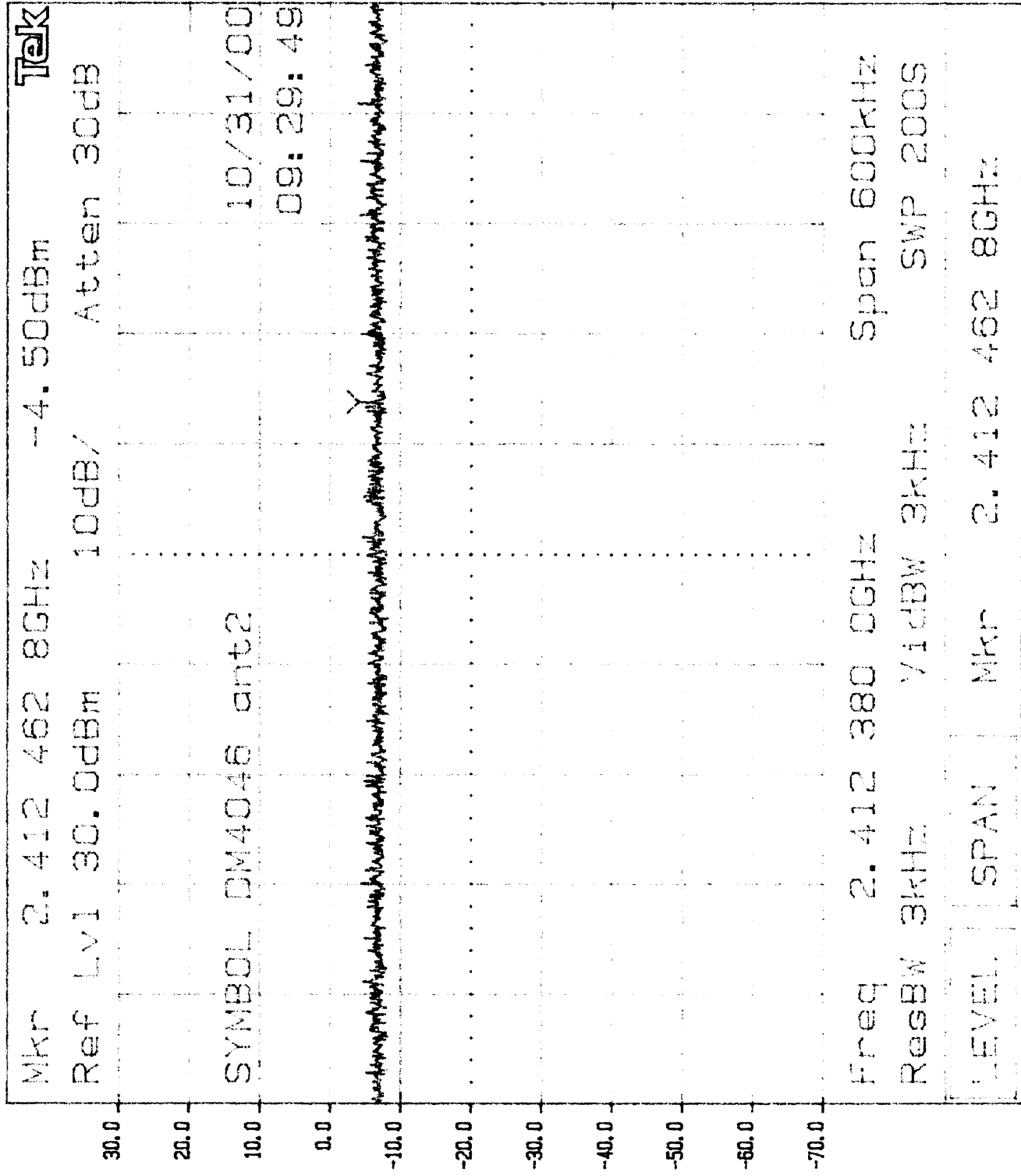

KNOB 2 KNOB 1 KEYPAD Tektronix 2784

Plot 36

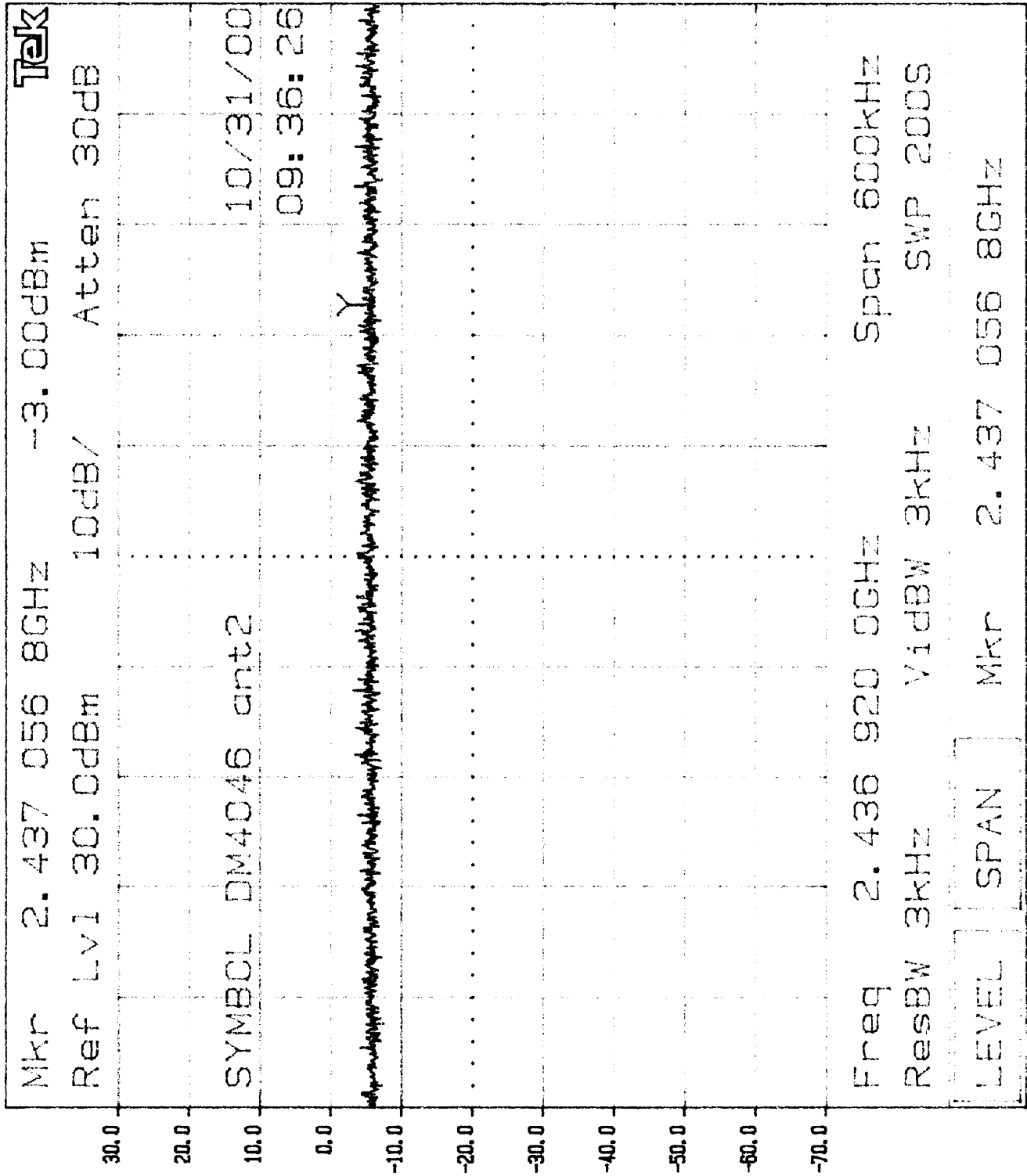



Plot 3c

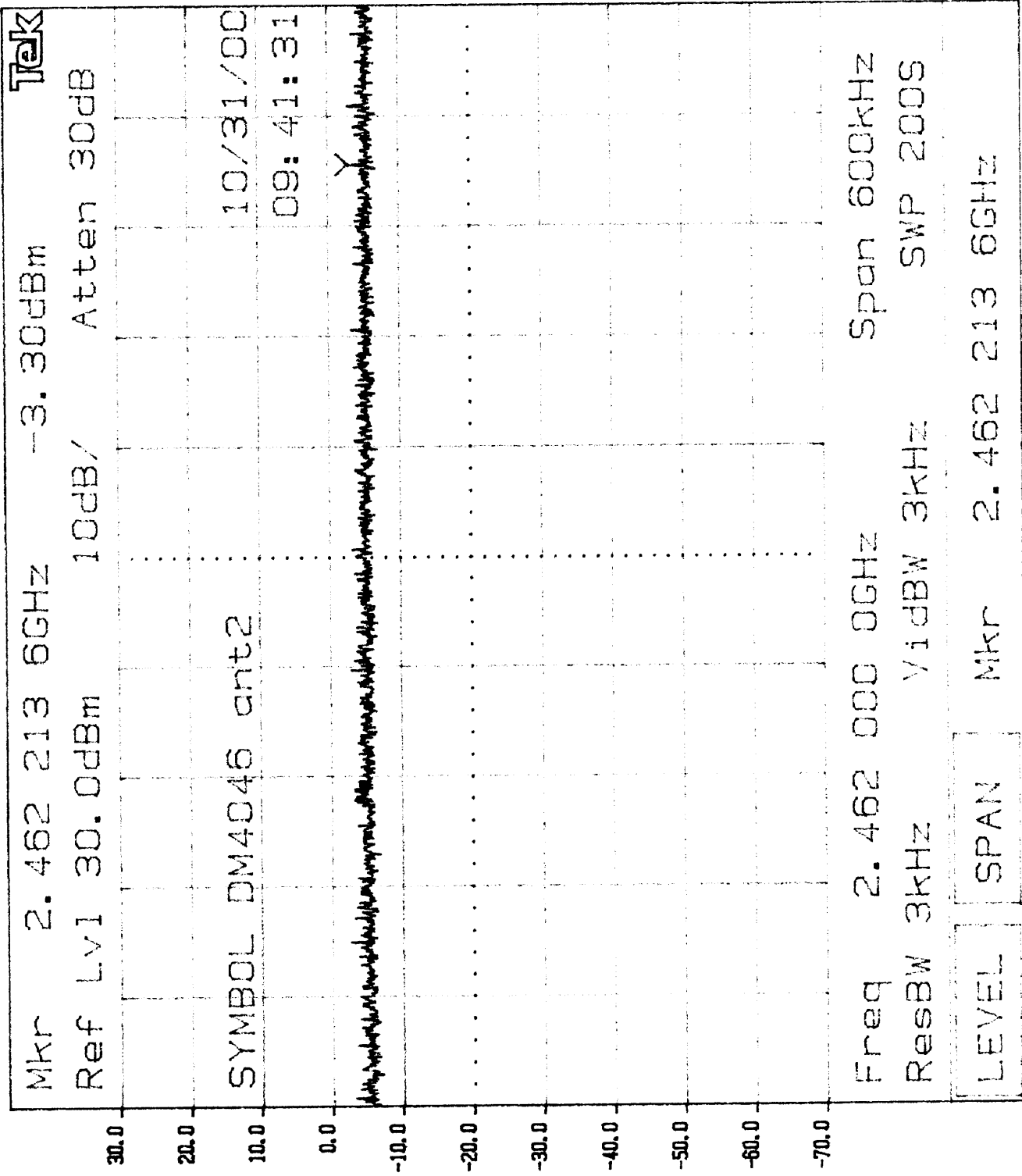

Symbol Technologies,  
FCC ID: H9PDM4046

Date of Test: October 29-31, 2000

4.4 Out-of-Band Conducted Emissions, FCC Rule 15.247(c)

Requirements:

In any 100 kHz bandwidth outside the EUT passband, the RF power shall be at least 20 dB below that of the maximum in-band 100 kHz emission.

Test Result:

Refer to the following plots for out-of-band conducted emissions data:

Plot 4.a.1 – 4.a.6: Low Channel Emissions

Plot 4.b.1 – 4.b.6: Mid Channel Emissions

Plot 4.c.1 – 4.c.6: High Channel Emissions

Plot 4a1

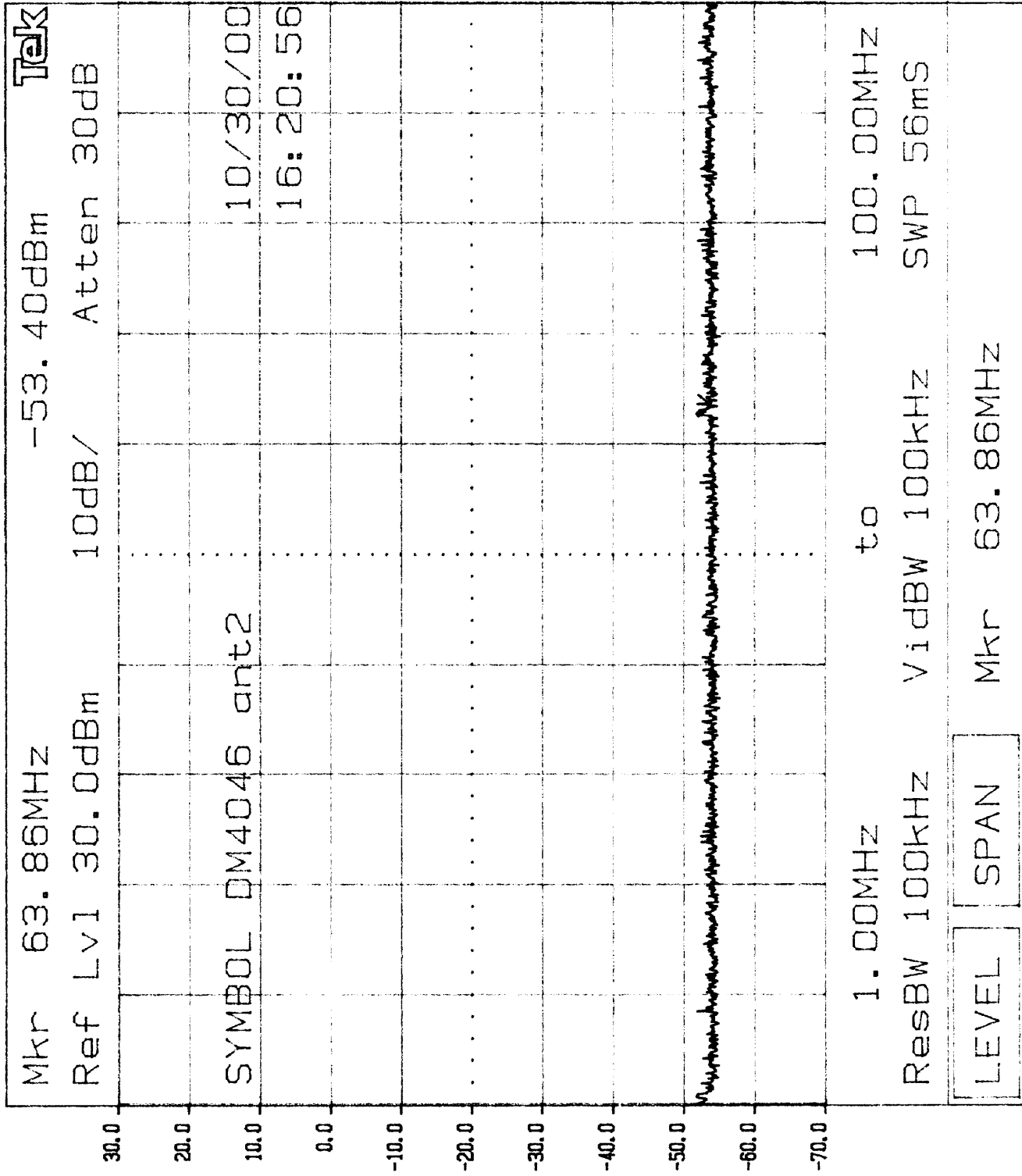

Mkr 462.7MHz -50.90dBm Tek

Ref Lvl 30.0dBm 10dB/ Atten 30dB

Plot 4a.2

SYMBOL DM4046 ant2 10/30/00

16:23:57

30.0  
20.0  
10.0  
0.0  
-10.0  
-20.0  
-30.0  
-40.0  
-50.0  
-60.0  
-70.0

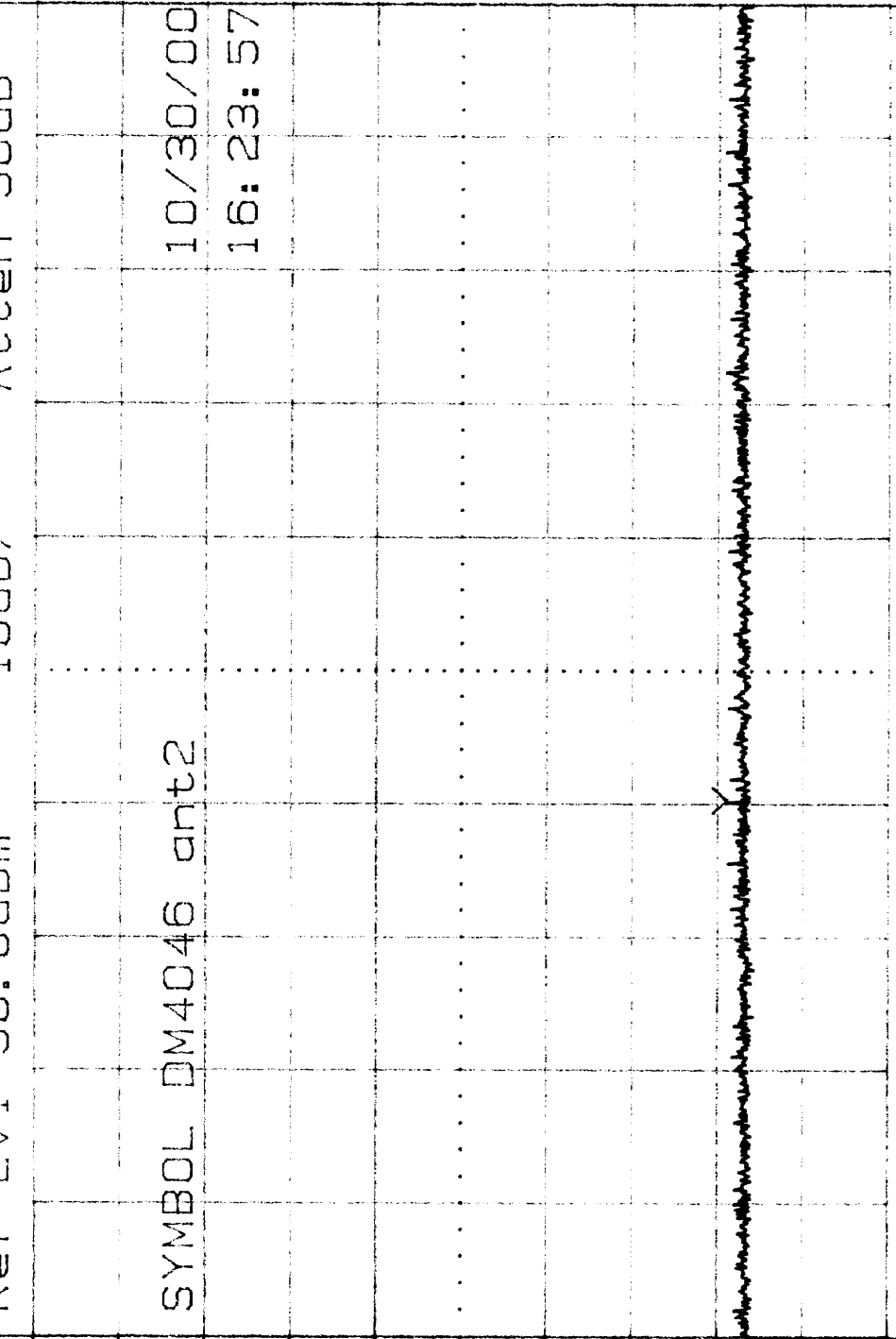

100.0MHz to 1.000 0GHz  
ResBW 100kHz VidBW 100kHz SWP 510mS

LEVEL SPAN

Mkr 462.7MHz

Plot 4a3

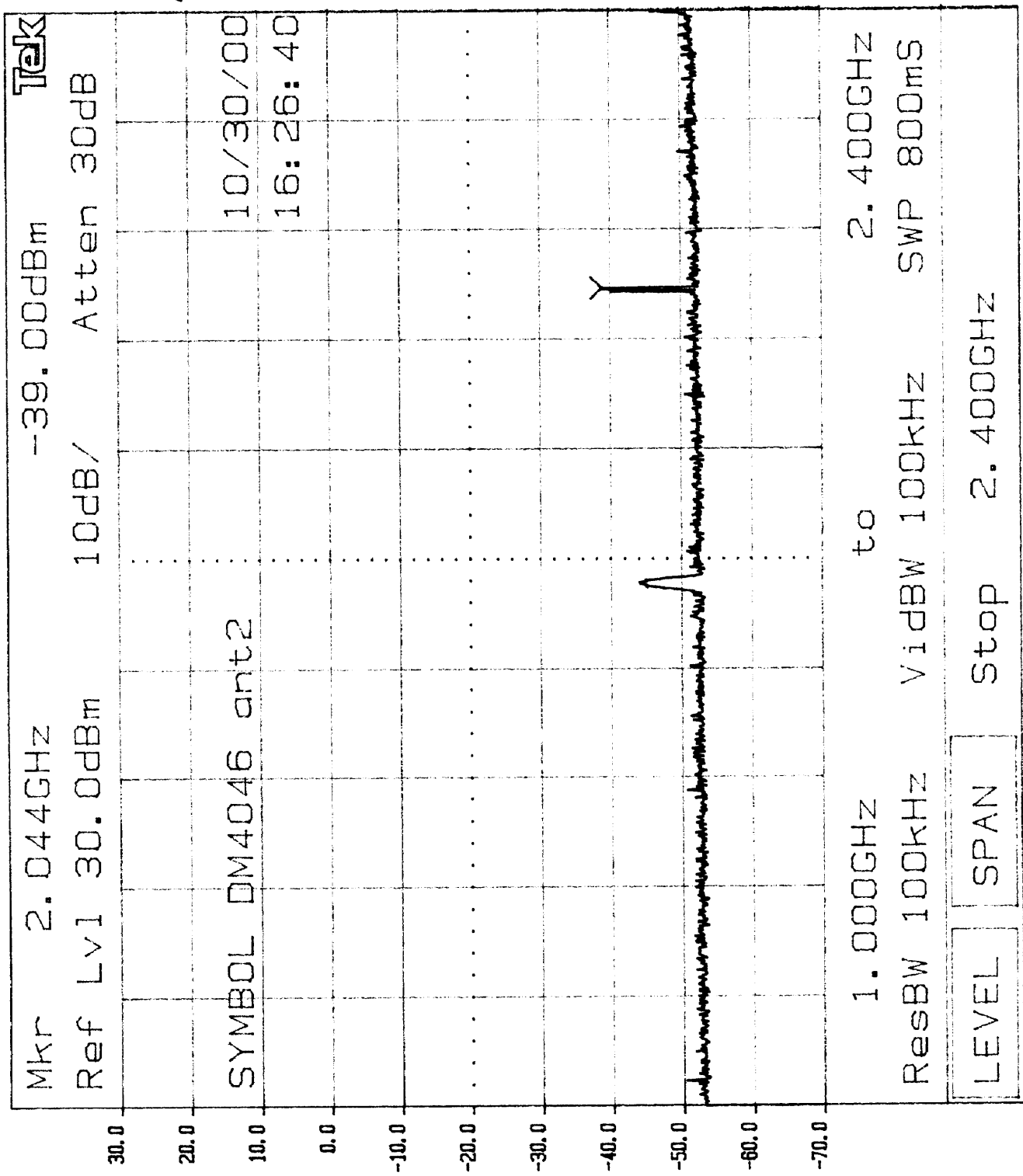

Plot 424

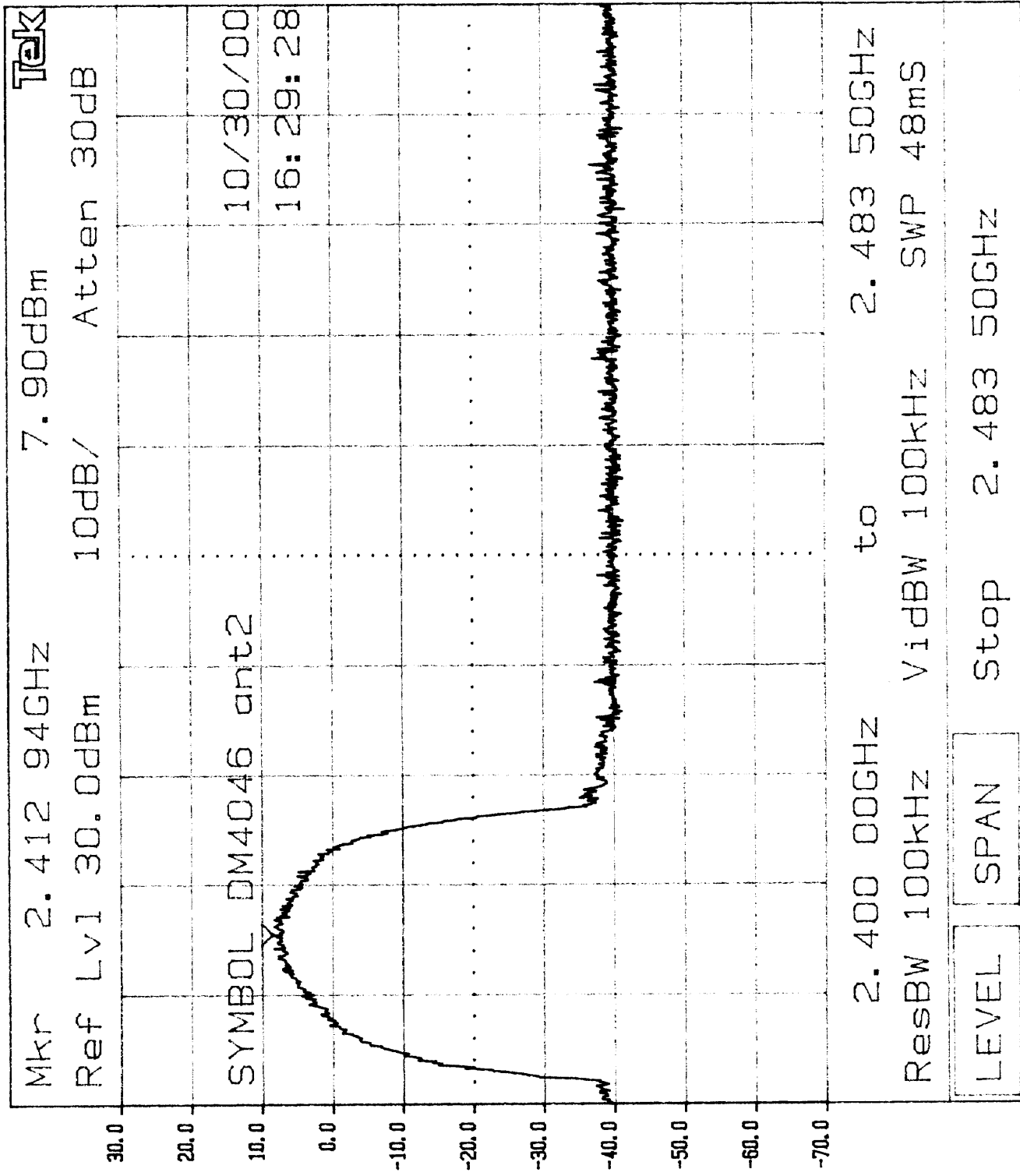

Plot 425

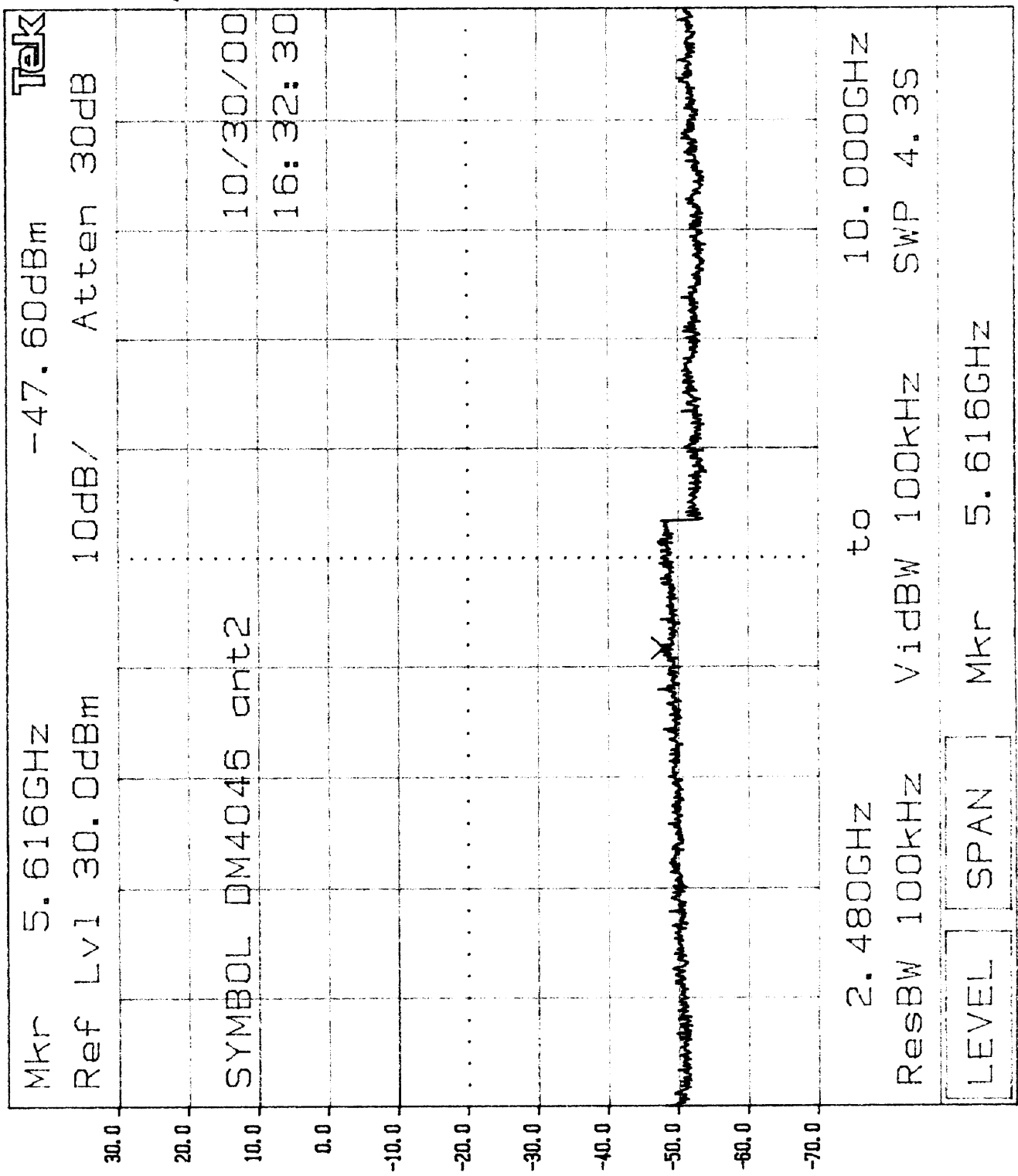

Plot 426

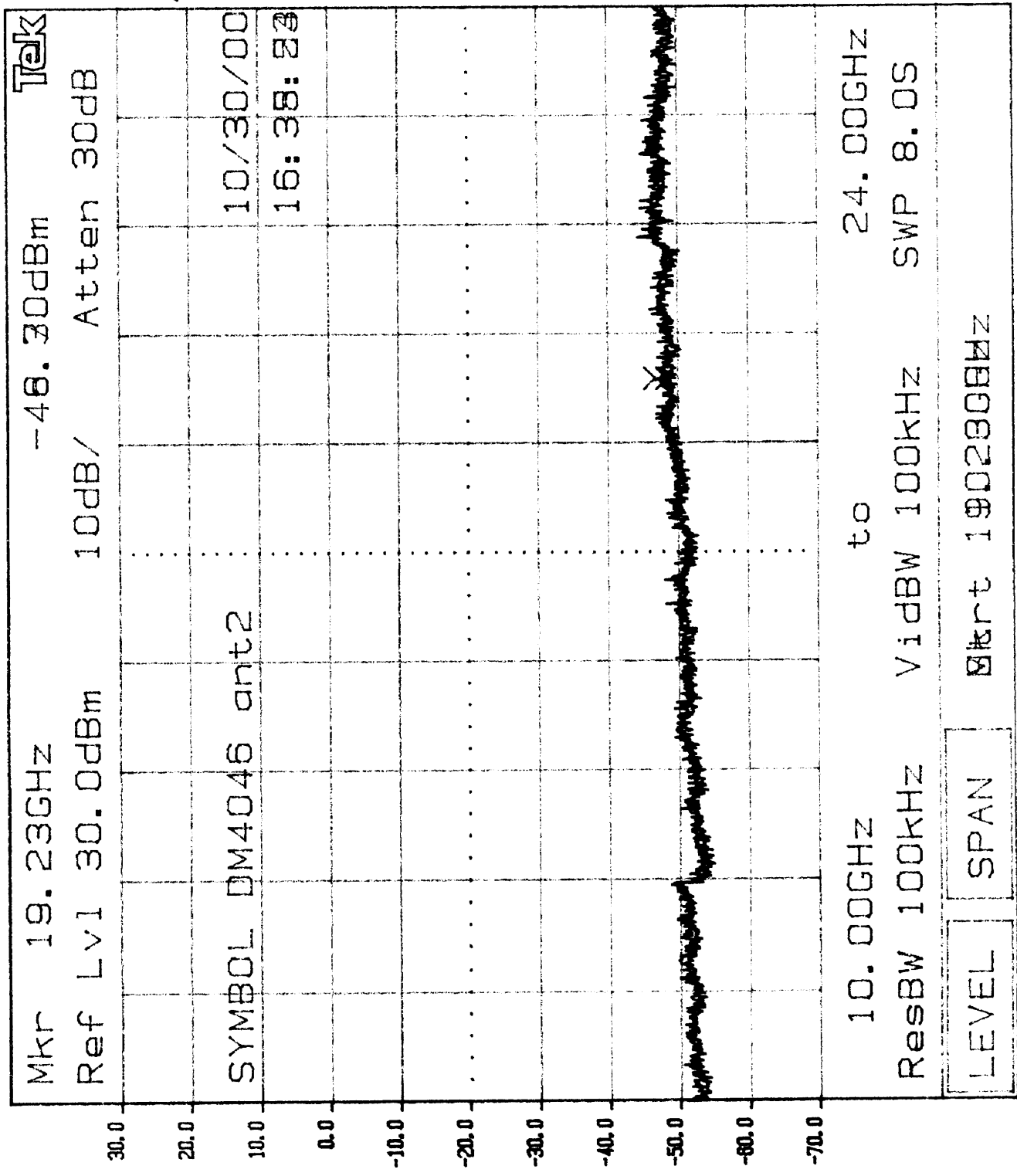



Mkr 50.50MHz -53.10dBm Tek

Ref Lvl 30.0dBm 10dB/ Atten 30dB

Plot 46.1

SYMBOL DM4046 ant2 10/31/00

08:29:47

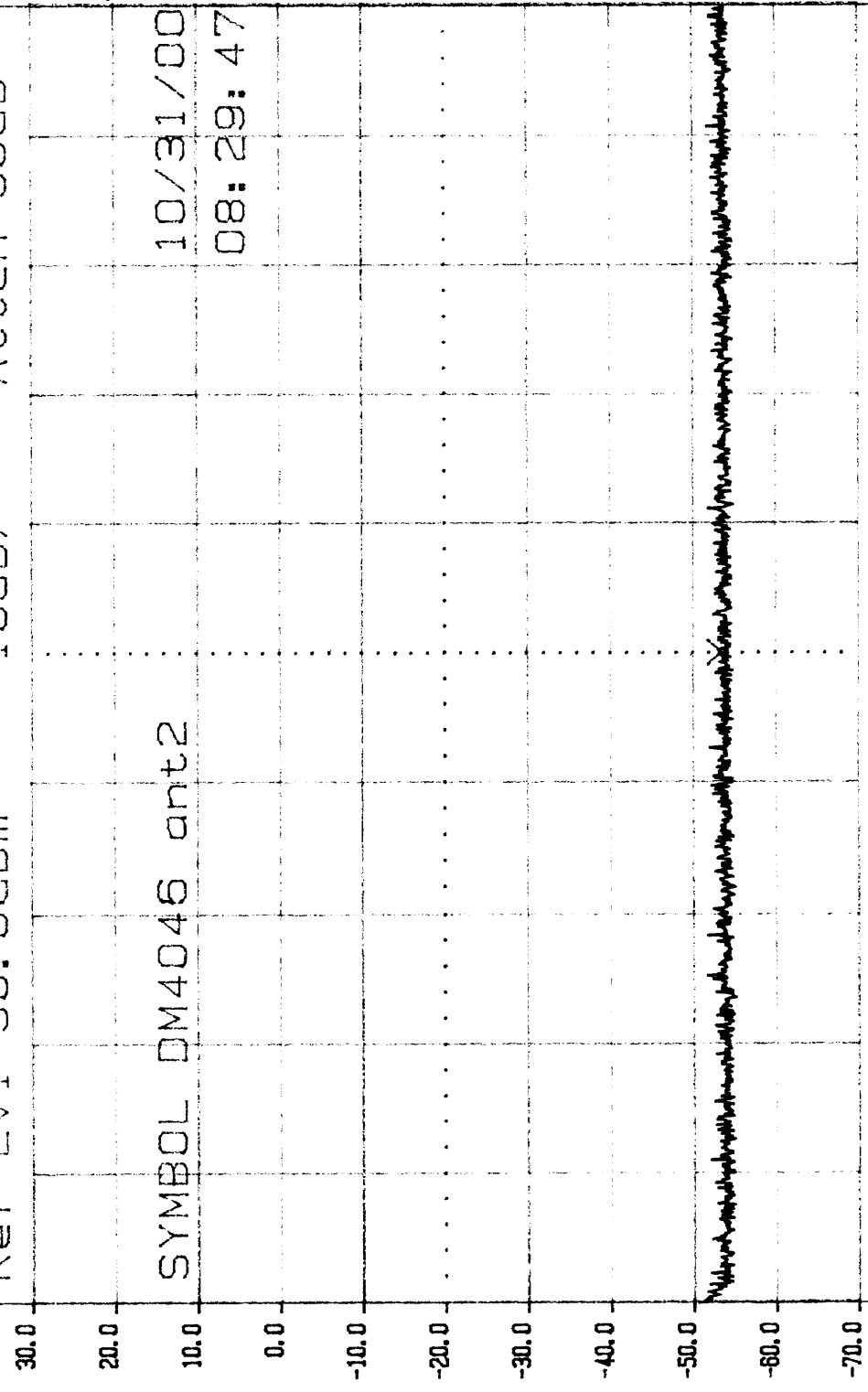

1.00MHz to 100.00MHz  
ResBW 100kHz VidBW 100kHz SWP 56ms

LEVEL SPAN Stop 100.00MHz

Plot 462

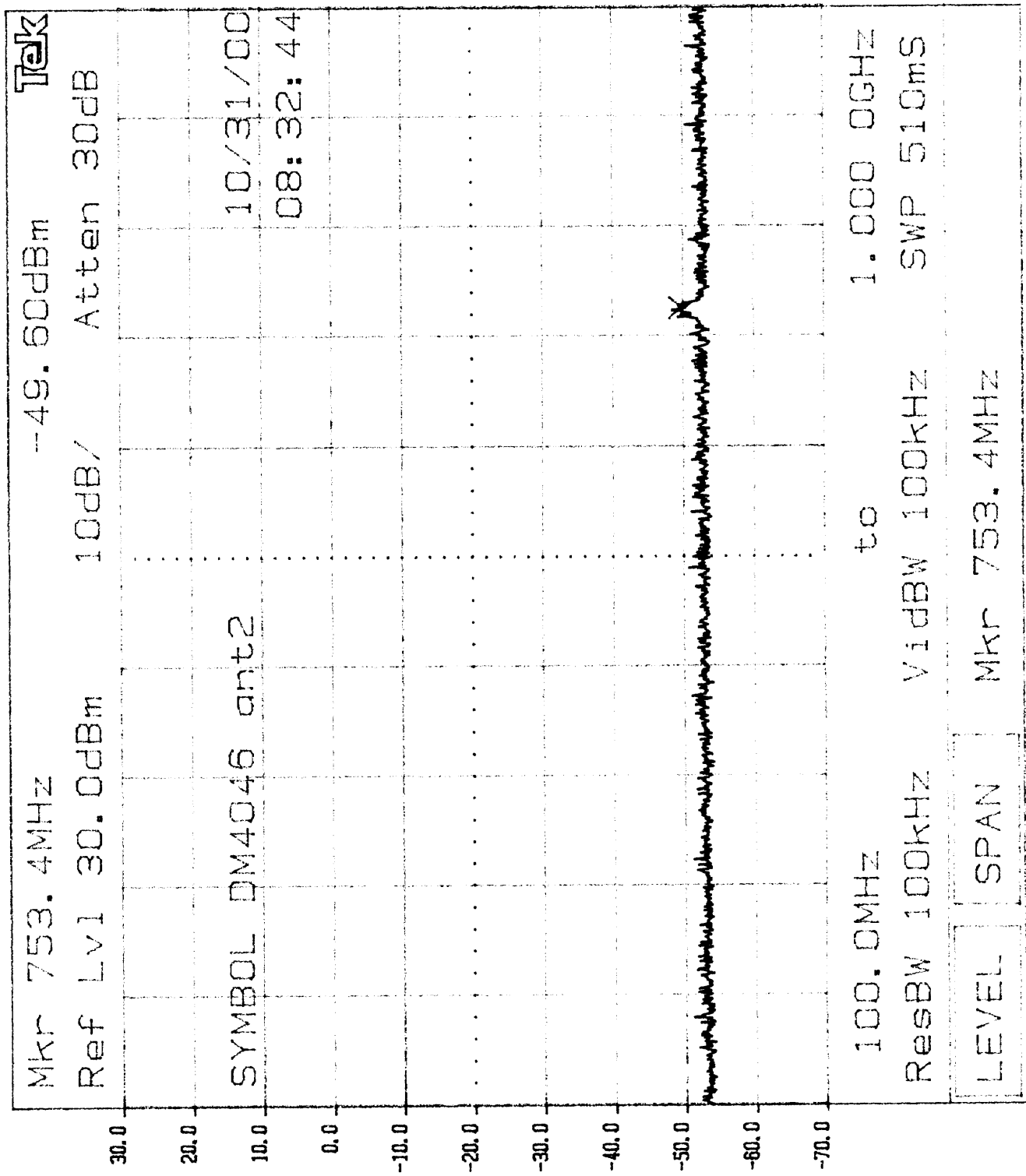

Plot 463

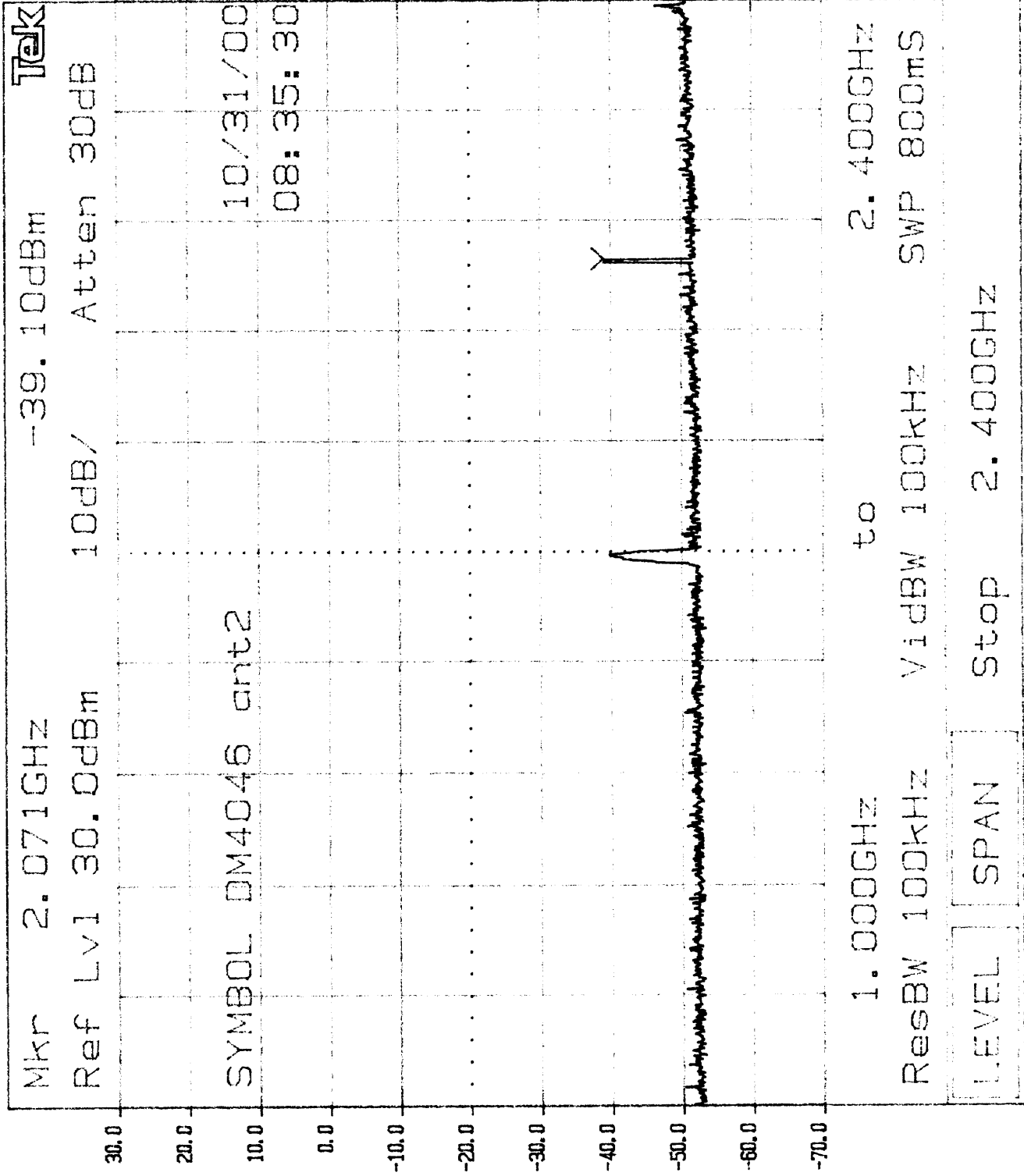

Tek

Mkr 2.437 32GHz 10.50dBm

Ref Lvl 30.0dBm 10dB/ Atten 30dB

Plot 464

SYMBOL DM4046 ant2  
10/31/00  
08:38:19

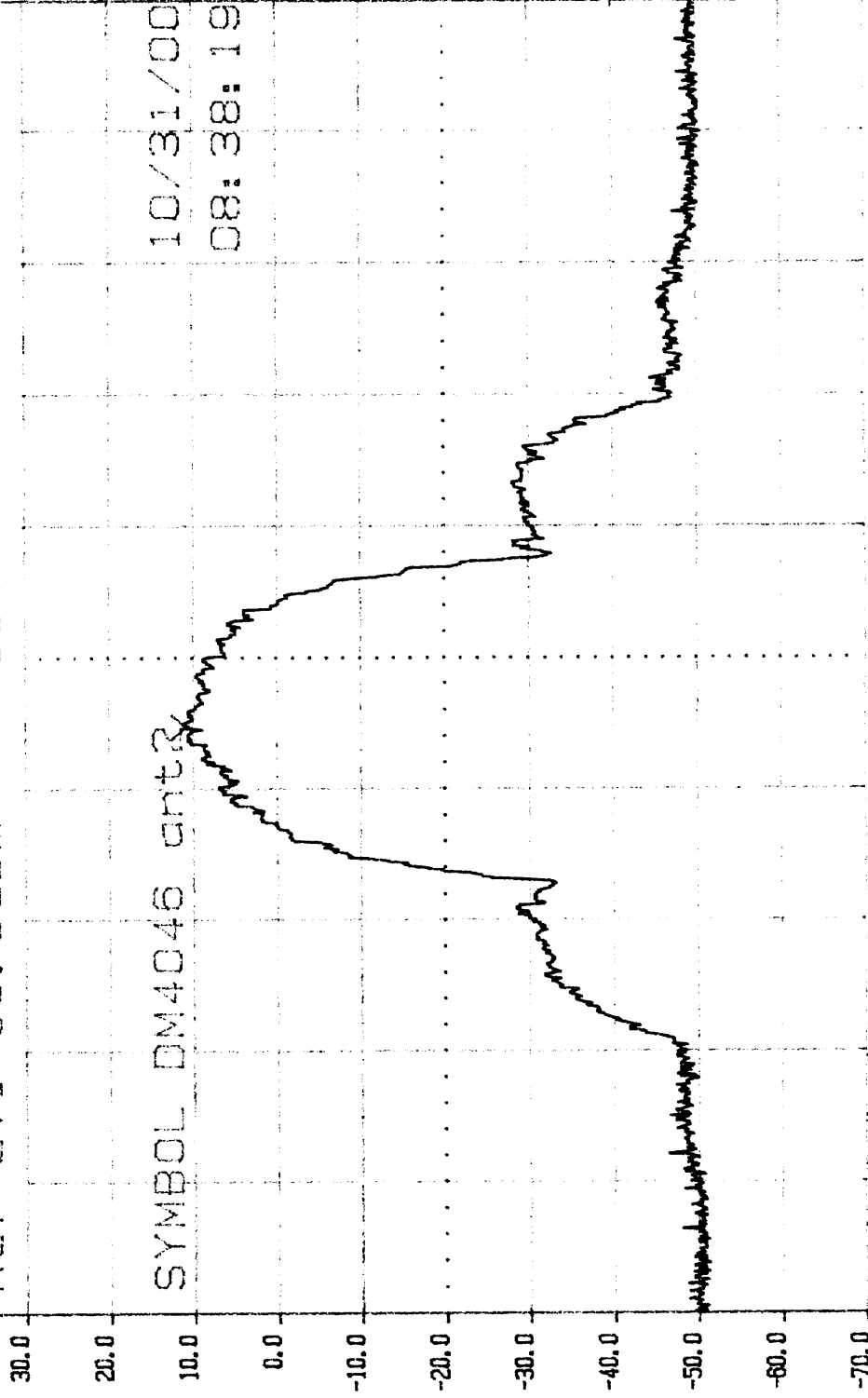

2.400 00GHz to 2.483 50GHz  
ResBW 100kHz VidBW 100kHz SWP 48ms

LEVEL SPAN Strt 2.400 00GHz

Plot 465

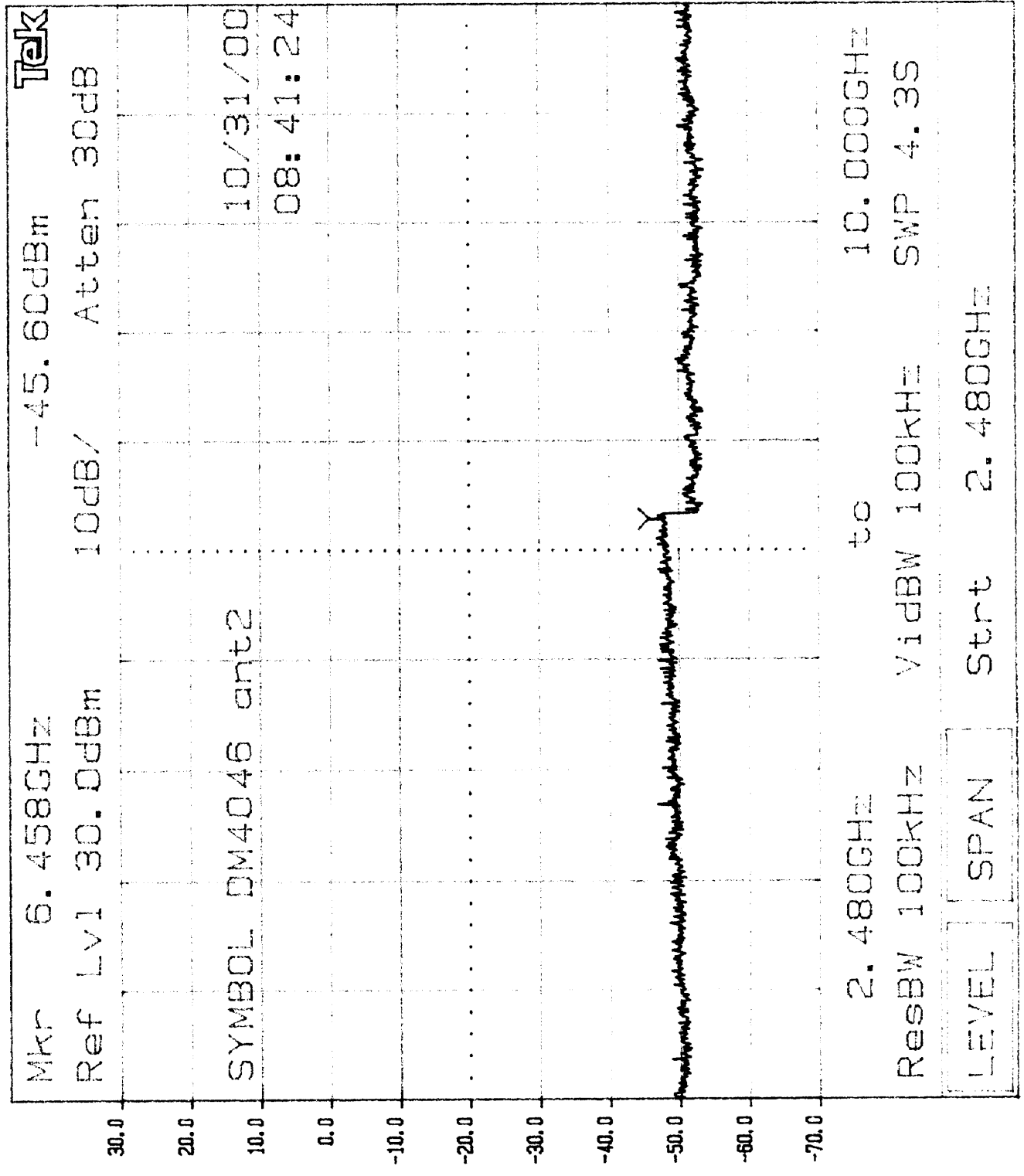



P6t4c1

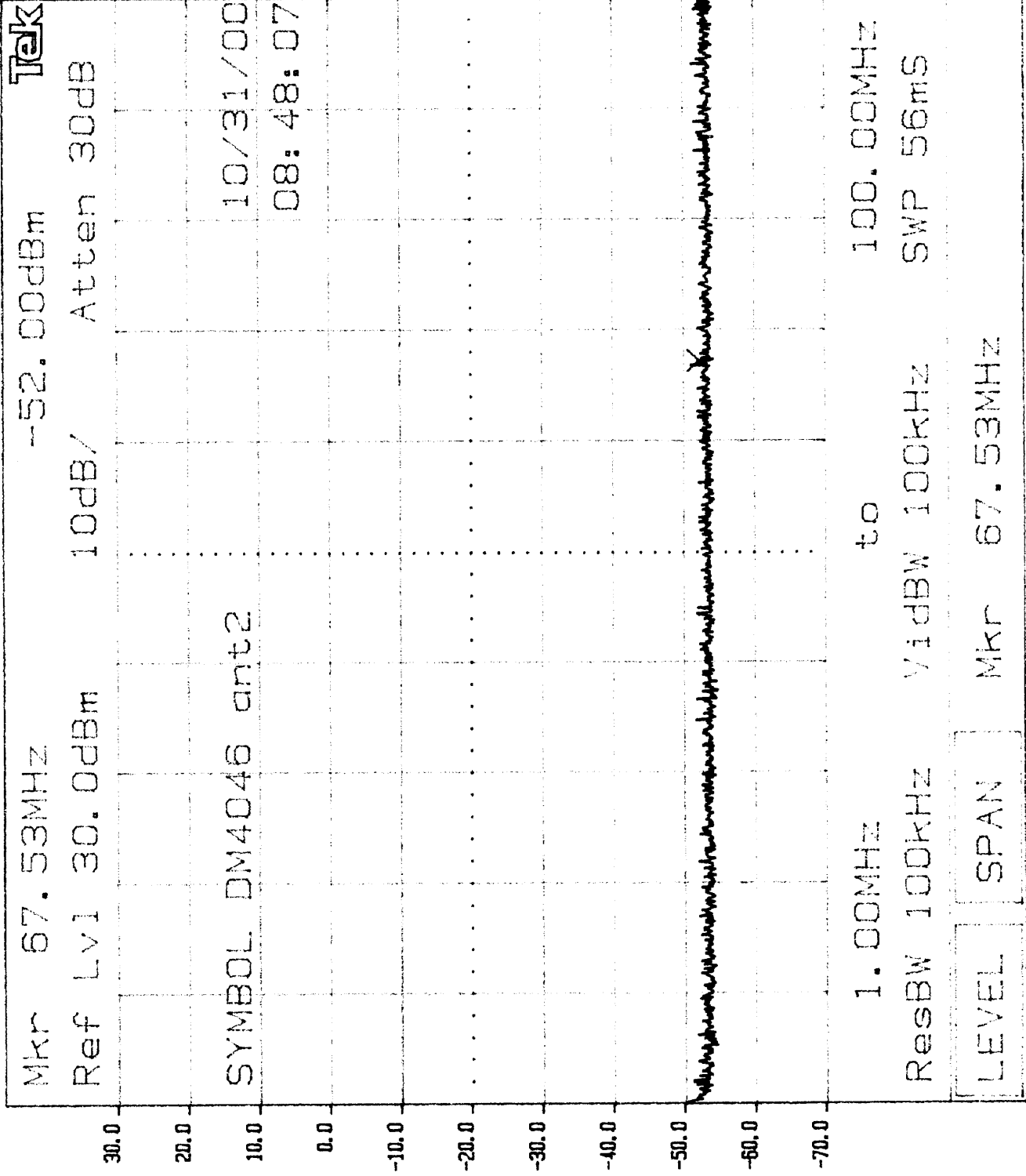

Plot 4c 2

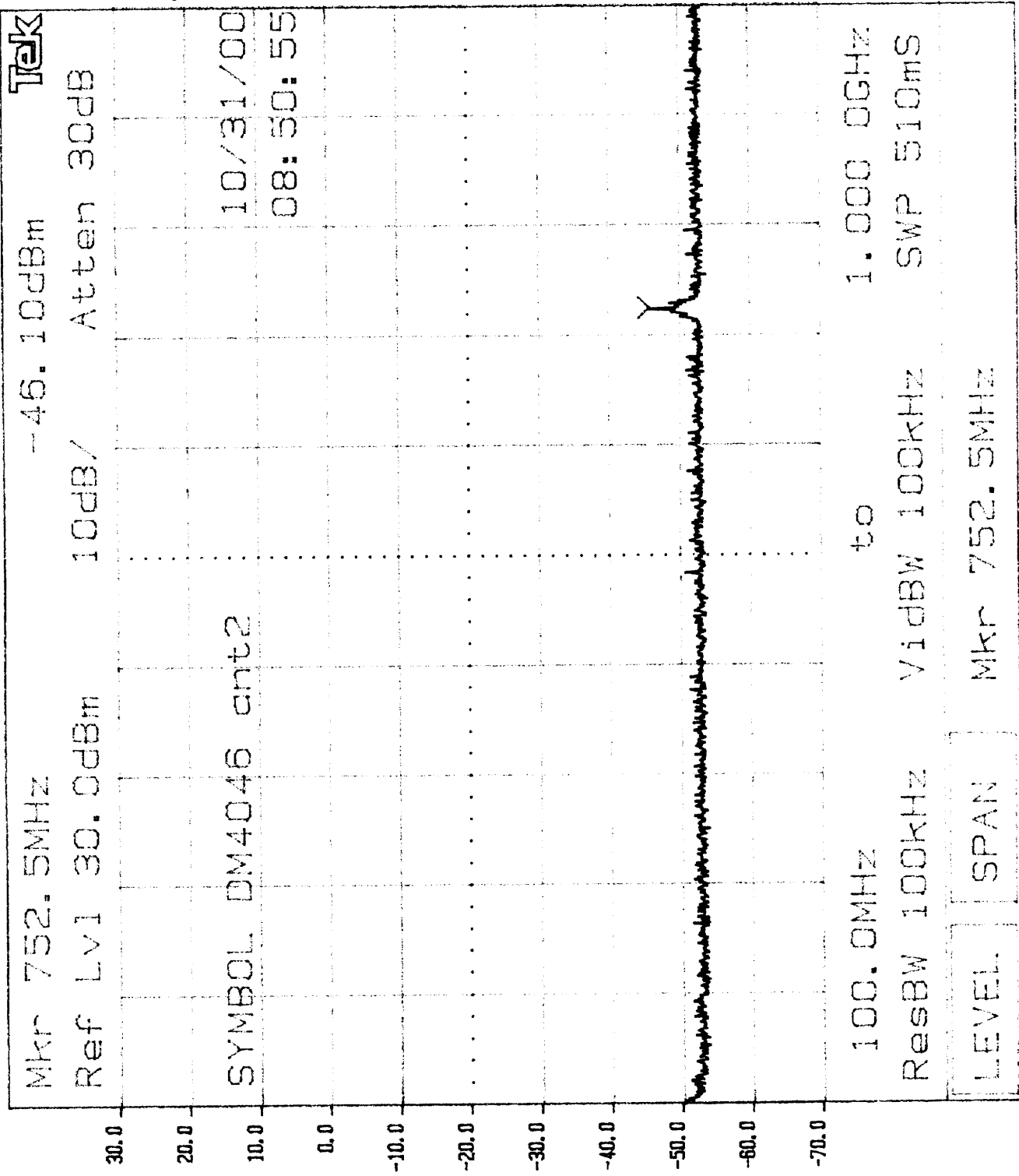



Plot 4c3

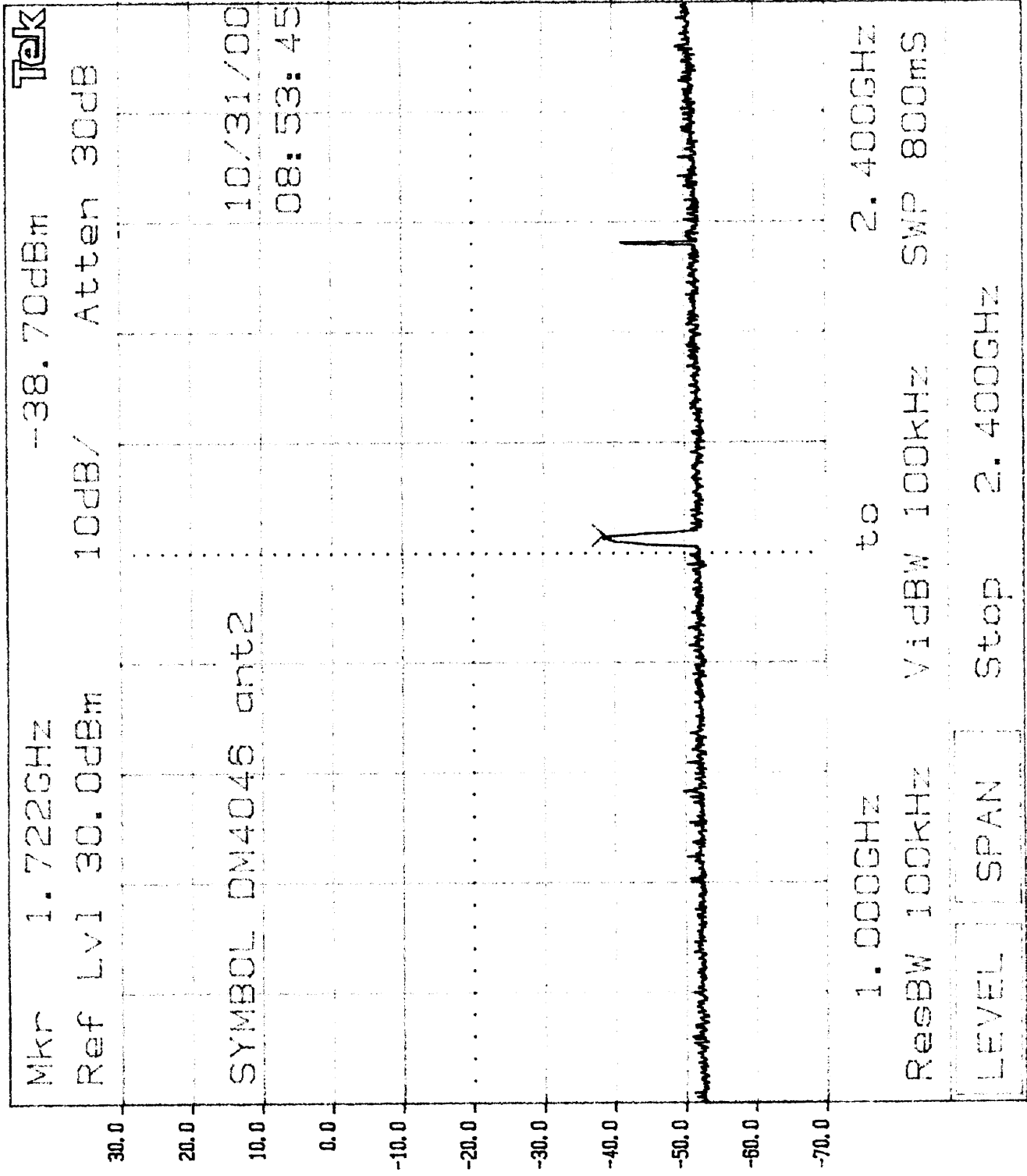

Plot 4c4

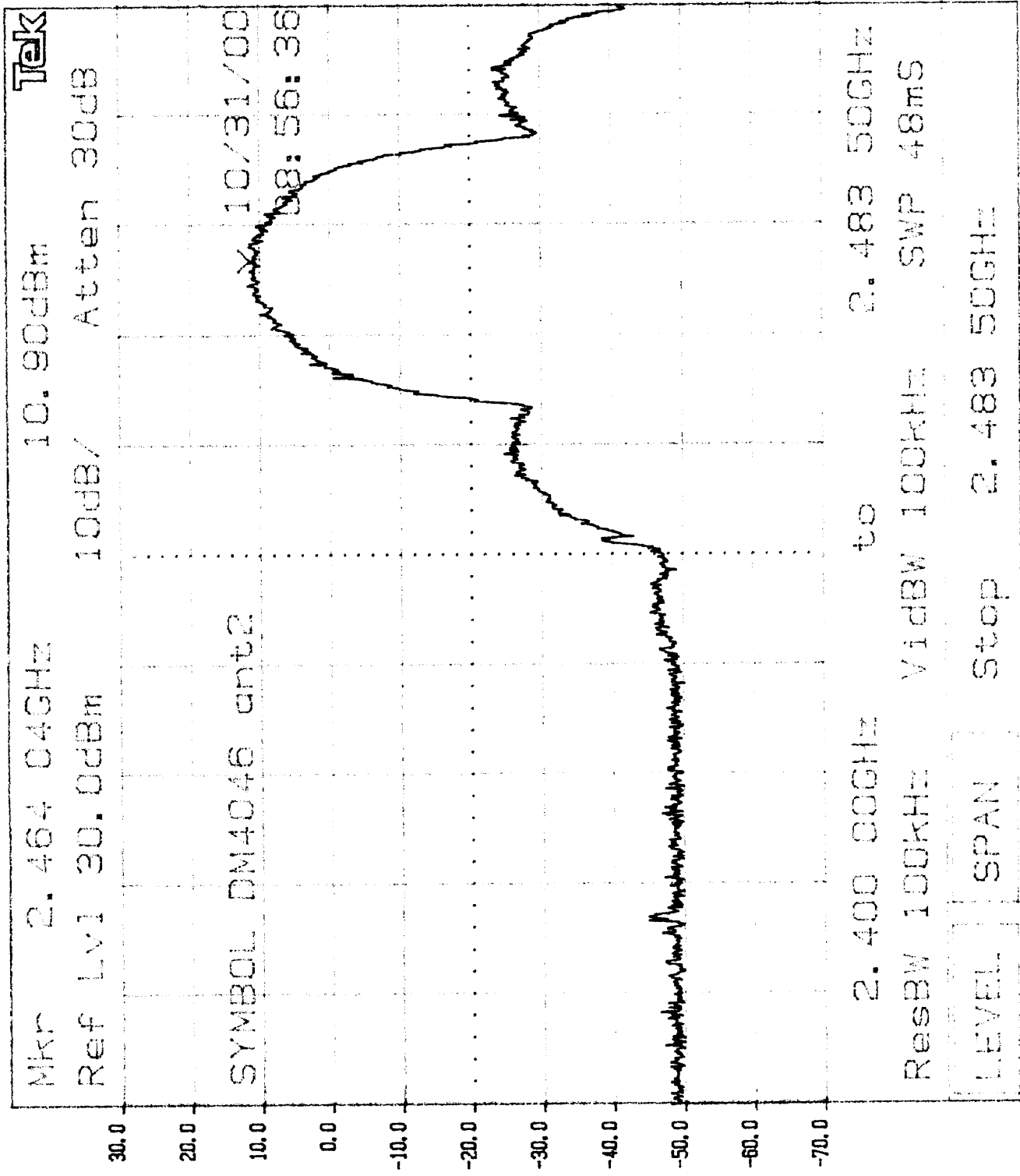

Plot 4c5

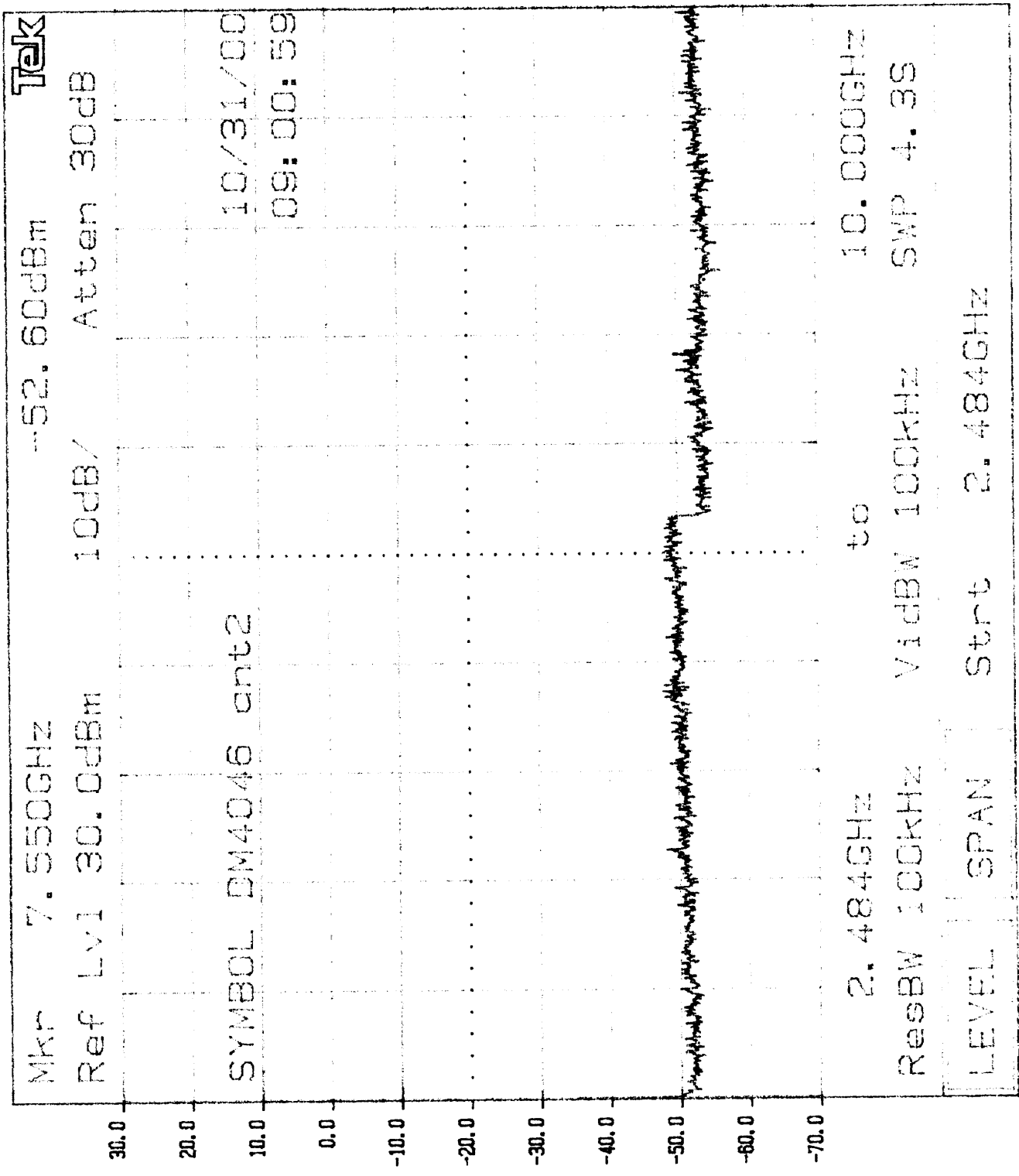

Plot 4c.6

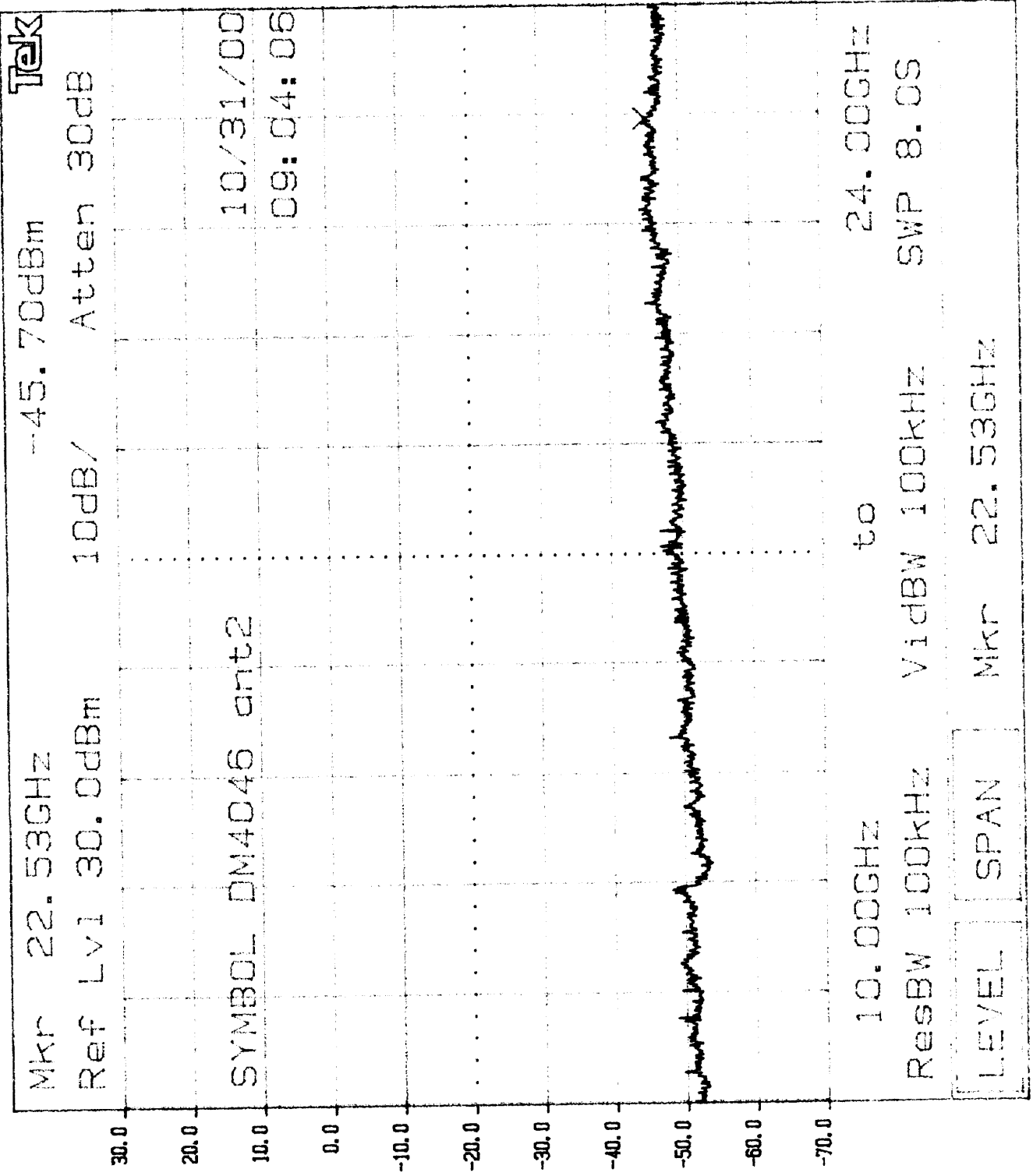

---

Symbol Technologies,  
FCC ID: H9PDM4046

Date of Test: October 29-31, 2000

#### 4.5 Out-of-Band Radiated Emissions, FCC Rule 15.247(c)

For out-of-band emissions that are close to the 20 dB attenuation requirement described in the specification, radiated measurements were performed at a 3 m separation distance to determine whether these emissions complied with the 20 dB attenuation requirement.

Not required. Out-of-band conducted emissions are more than 20 dB below the emission at the fundamental frequency

## 4.6 Transmitter Radiated Emissions in Restricted Bands, FCC Rule 15.35(b), (c)

Radiated emission measurements were performed from 30 MHz to 25000 MHz. Spectrum analyzer resolution bandwidth is 100 kHz or greater for frequencies from 30 MHz to 1000 MHz, and 1 MHz for frequencies above 1000 MHz. The EUT was positioned on a non-conductive turntable, 0.8m above the ground plane on an open test site. The radiated emission was measured at 3 m distance. To maximize emissions, the system was rotated through 360°, the antenna height was varied from 1m to 4 m, and the antenna polarization was changed. Data is included of the worst case configuration (the configuration which resulted in the highest emission levels). A sample calculation, configuration photographs and data tables of the emissions are included. All measurements were performed with peak and average detectors unless otherwise specified.

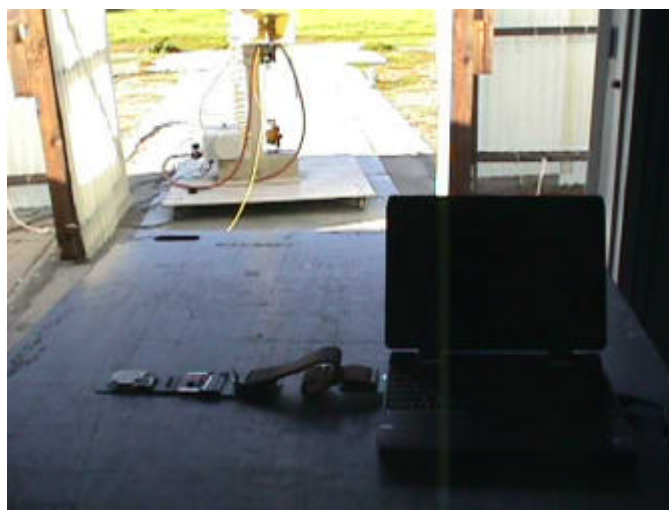
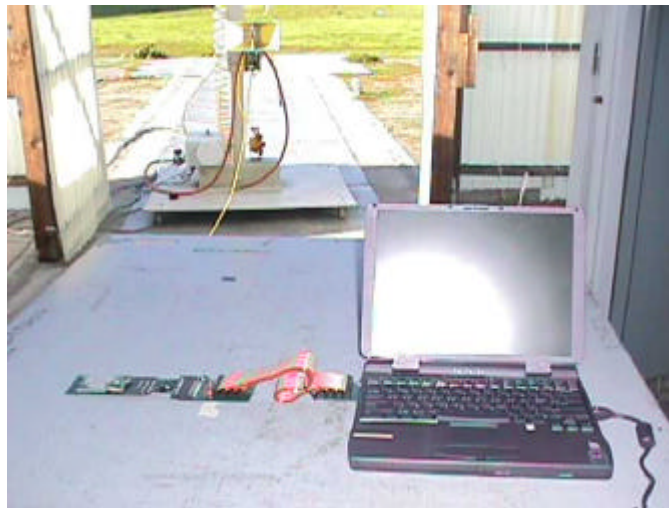
Configuration Photograph:

DP4046 Configuration

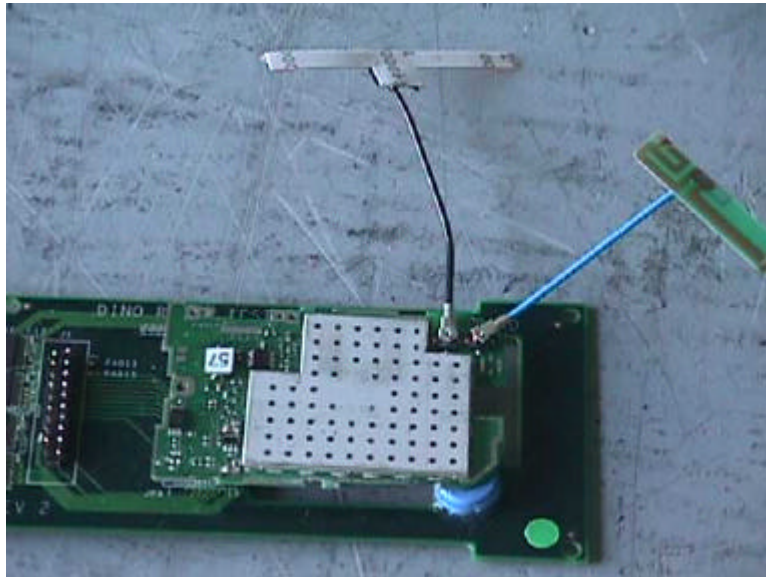

NP4046 Configuration

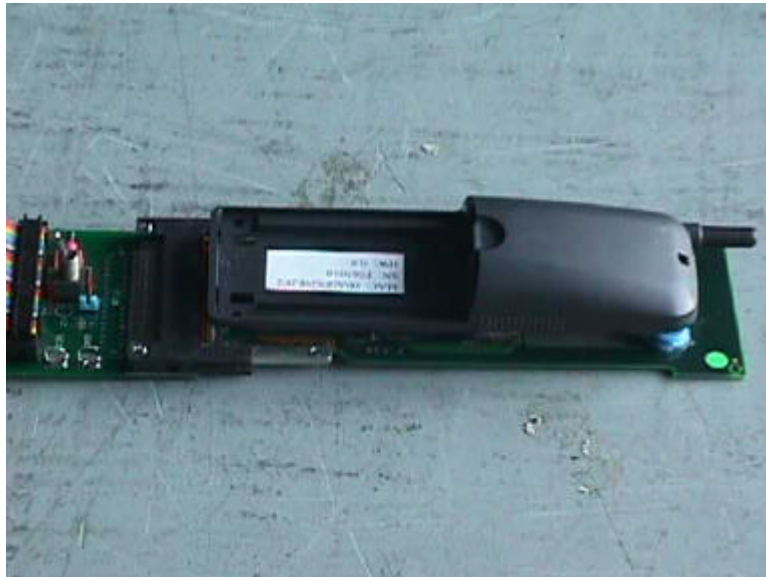

Test Result:

The data on the following pages (data sheets ## 1 to 3) list the significant emission frequencies, the limit and the margin of compliance.

In addition, the field strength in the restricted bands: 2483.5 MHz to 2500 MHz and 2310 MHz to 2390 MHz was calculated as follows:

$$E_f = E_0 - \text{delta} - \text{DC}$$

where  $E_0$  is the field strength at the fundamental frequency (high or low channels) in dB(uV/m);  
 "delta" is the difference in conducted emissions between the level at the fundamental frequency and the highest level in the restricted band in dB;  
 DC is the Duty Cycle correction factor in dB

The results are presented in the Table 2.

Table 2

Frequency, MHz	Antenna	Field Strength, $E_0$ dB(uV/m) *	delta, dB	Duty Cycle, dB	Field Strength, $E_f$ dB(uV/m)	Limit (average), dB(uV/m)	Margin, dB
2390.0	Screw-in	106.0 at 2412 MHz	64.2 **	19.4	22.4	54.0	-31.6
2390.0	Stick-on	117.2 at 2412 MHz	64.2 **	19.4	33.6	54.0	-20.4
2390.0	PCB board	111.6 at 2412 MHz	64.2 **	19.4	28.0	54.0	-26.0
2483.5	Screw-in	109.5 at 2462 MHz	59.2 ***	19.4	30.9	54.0	-23.1
2483.5	Stick-on	117.4 at 2462 MHz	59.2 ***	19.4	38.8	54.0	-15.2
2483.5	PCB board	114.7 at 2462 MHz	59.2 ***	19.4	36.1	54.0	-17.9

\* see data sheets on the next pages

\*\* from Plot 6.1

\*\*\* from Plot 6.2



**Radiated Emissions  
Test Data**

Company: Symbol						Model #: NP4046			Standard		FCC § 15.247 (R.B.)	
EUT: Screw in Antenna						S/N #: 50-21900-043			Limits		11	
Project #: J20029320						Test Date: Oct 31, 2000			Test Distance		3 meters	
Test Mode:						Engineer: Barry S.			Duty Relaxation		0 dB	
Frequency	Reading	Detector	Ant	Amp.	Ant. Pol.	Ant. Factor	Pre-Amp	Insert. Loss	D. C. F.	Net	Limit @3m	Margin
MHz	dB(µV)	P/A/G	#	#	H/V	dB(1/m)	dB	dB	dB	dB(µV/m)	dB(µV/m)	dB
2412	73.6	Peak	14		V	30.1	0.0	2.3	0.0	106.0		
4824	23.0	Peak	14	8	V	33.9	28.1	3.2	0.0	32.0	74.0	-42.0
4824	17.0	Ave.	14	8	V	33.9	28.1	3.2	0.0	26.0	54.0	-28.0
7236	36.6	Peak	14	8	V	38.0	28.0	4.3	0.0	50.9	74.0	-23.1
7236	29.3	Ave.	14	8	V	38.0	28.0	4.3	0.0	43.6	54.0	-10.4
12060	51.2	Peak	14	10	V	42.3	39.1	5.9	0.0	60.3	74.0	-13.7
12060	47.6	Ave.	14	10	V	42.3	39.1	5.9	0.0	56.7	54.0	2.7
14472	38.2	Peak	14	10	V	40.7	37.8	6.5	0.0	47.6	74.0	-26.4
14472	30.6	Ave.	14	10	V	40.7	37.8	6.5	0.0	40.0	54.0	-14.0
19296*	37.0	Peak	21	13	V	40.2	23.3	7.7	-9.5	52.1	74.0	-21.9
19296*	24.7	Ave.	21	13	V	40.2	23.3	7.7	-9.5	39.8	54.0	-14.2
2437	73.6	Peak	14		H	28.8	0.0	2.3	0.0	104.7		
4874	24.9	Peak	14	8	V	33.9	28.1	3.2	0.0	33.9	74.0	-40.1
4874	16.3	Ave.	14	8	V	33.9	28.1	3.2	0.0	25.3	54.0	-28.7
7311	36.3	Peak	14	8	V	38.0	28.0	4.3	0.0	50.6	74.0	-23.4
7311	30.5	Ave.	14	8	V	38.0	28.0	4.3	0.0	44.8	54.0	-9.2
12185	53.5	Peak	14	10	V	42.3	39.1	5.9	0.0	62.6	74.0	-11.4
12185	47.3	Ave.	14	10	V	42.3	39.1	5.9	0.0	56.4	54.0	2.4
19496*	39.5	Peak	21	13	V	40.2	23.3	7.7	-9.5	54.6	74.0	-19.4
19496*	22.2	Ave.	21	13	V	40.2	23.3	7.7	-9.5	37.3	54.0	-16.7
2462	78.4	Peak	14		H	28.8	0.0	2.3	0.0	109.5		
4924	25.0	Peak	14	8	V	33.9	28.1	3.2	0.0	34.0	74.0	-40.0
4924	16.0	Ave.	14	8	V	33.9	28.1	3.2	0.0	25.0	54.0	-29.0
7386	39.5	Peak	14	8	V	38.0	28.0	4.3	0.0	53.8	74.0	-20.2
7386	33.4	Ave.	14	8	V	38.0	28.0	4.3	0.0	47.7	54.0	-6.3
12310	54.9	Peak	14	10	V	42.3	39.1	5.9	0.0	64.0	74.0	-10.0
12310	48.1	Ave.	14	10	V	42.3	39.1	5.9	0.0	57.2	54.0	3.2
19696*	45.0	Peak	21	13	V	40.3	23.3	7.7	-9.5	60.2	74.0	-13.8
19696*	31.3	Ave.	21	13	V	40.3	23.3	7.7	-9.5	46.5	54.0	-7.5
22158*	41.4	Peak	21	13	V	40.3	23.3	7.9	-9.5	56.8	74.0	-17.2
22158*	30.0	Peak	21	13	V	40.3	23.3	7.9	-9.5	45.4	74.0	-28.6

- \*Readings taken at 1 meter with RBW 300KHz
- Symbol Technologies declares a duty cycle factor of 19.37 dB. This amount may be subtracted from the margin column.

**Radiated Emissions  
Test Data**

2

Company:		Symbol		Model #:		DP4046		Standard		FCC § 15.247 (R.B.)		
EUT:		Stick on Antenna		S/N #:		50-21900-044		Limits		11		
Project #:		J20029320		Test Date:		Oct 31, 2000		Test Distance		3 meters		
Test Mode:		calling another phone thru hub		Engineer:		Barry S.		Duty Relaxation		0 dB		
Frequency	Reading	Detector	Ant	Amp.	Ant. Pol.	Ant. Factor	Pre-Amp	Insert. Loss	D. C. F.	Net	Limit @3m	Margin
MHz	dB(µV)	P/A/Q	#	#	H/V	dB(1/m)	dB	dB	dB	dB(µV/m)	dB(µV/m)	dB
2412	84.8	Peak	14		V	30.1	0.0	2.3	0.0	117.2		
4824	35.6	Peak	14	8	V	33.9	28.1	3.2	0.0	44.6	74.0	-29.4
4824	27.9	Ave.	14	8	V	33.9	28.1	3.2	0.0	36.9	54.0	-17.1
7236	37.5	Peak	14	8	V	38.0	28.0	4.3	0.0	51.8	74.0	-22.2
7236	33.3	Ave.	14	8	V	38.0	28.0	4.3	0.0	47.6	54.0	-6.4
12060	36.0	Peak	14	10	V	42.3	39.1	5.9	0.0	45.1	74.0	-28.9
12060	28.9	Ave.	14	10	V	42.3	39.1	5.9	0.0	38.0	54.0	-16.0
14472	37.9	Peak	14	10	V	40.7	37.8	6.5	0.0	47.3	74.0	-26.7
14472	30.9	Ave.	14	10	V	40.7	37.8	6.5	0.0	40.3	54.0	-13.7
19296*	41.0	Peak	21	13	V	40.2	23.3	7.7	-9.5	56.1	74.0	-17.9
19296*	24.0	Ave.	21	13	V	40.2	23.3	7.7	-9.5	39.1	54.0	-14.9
2437	85.5	Peak	14		V	30.1	0.0	2.3	0.0	117.9		
4874	25.3	Peak	14	8	V	33.9	28.1	3.2	0.0	34.3	74.0	-39.7
4874	17.7	Ave.	14	8	V	33.9	28.1	3.2	0.0	26.7	54.0	-27.3
7311	40.9	Peak	14	8	V	38.0	28.0	4.3	0.0	55.2	74.0	-18.8
7311	38.4	Ave.	14	8	V	38.0	28.0	4.3	0.0	52.7	54.0	-1.3
12185	37.7	Peak	14	10	V	42.3	39.1	5.9	0.0	46.8	74.0	-27.2
12185	31.8	Ave.	14	10	V	42.3	39.1	5.9	0.0	40.9	54.0	-13.1
19496*	33.7	Peak	21	13	V	40.2	23.3	7.7	-9.5	48.8	74.0	-25.2
19496*	22.0	Ave.	21	13	V	40.2	23.3	7.7	-9.5	37.1	54.0	-16.9
2462	85.0	Peak	14		V	30.1	0.0	2.3	0.0	117.4		
4924	25.4	Peak	14	8	V	33.9	28.1	3.2	0.0	34.4	74.0	-39.6
4924	18.5	Ave.	14	8	V	33.9	28.1	3.2	0.0	27.5	54.0	-26.5
7386	44.1	Peak	14	8	V	38.0	28.0	4.3	0.0	58.4	74.0	-15.6
7386	43.1	Ave.	14	8	V	38.0	28.0	4.3	0.0	57.4	54.0	3.4
12310	37.8	Peak	14	10	V	42.3	39.1	5.9	0.0	46.9	74.0	-27.1
12310	32.1	Ave.	14	10	V	42.3	39.1	5.9	0.0	41.2	54.0	-12.8
19696*	44.0	Peak	21	13	V	40.3	23.3	7.7	-9.5	59.2	74.0	-14.8
19696*	34.3	Ave.	21	13	V	40.3	23.3	7.7	-9.5	49.5	54.0	-4.5
22158*	41.1	Peak	1	2	V	23.0	0.0	7.9	-9.5	62.5	74.0	-11.5
22158*	29.8	Peak	1	2	V	23.0	0.0	7.9	-9.5	51.2	74.0	-22.8

- \*Readings taken at 1 meter with RBW 300KHz
- Symbol Technologies declares a duty cycle factor of 19.37 dB. This amount may be subtracted from the margin column.

**Radiated Emissions Test Data** 3

Company: Symbol					Model #: DP4046					Standard		FCC § 15.247 (R.B.)	
EUT: PCB Antenna					S/N #: 50-21900-045					Limits		11	
Project #: J20029320					Test Date: Oct 31, 2000					Test Distance		3 meters	
Test Mode: calling another phone thru hub					Engineer: Barry S.					Duty Relaxation		0 dB	
Frequency	Reading	Detector	Ant. #	Amp. #	Ant. Pol.	Ant. Factor	Pre-Amp	Insert. Loss	D. C. F	Net	Limit @3m	Margin	
MHz	dB(µV)	P/A/G	#	#	H/V	dB(1/m)	dB	dB	dB	dB(µV/m)	dB(µV/m)	dB	
2412	79.2	Peak	14		V	30.1	0.0	2.3	0.0	111.6			
4824	25.8	Peak	14	8	V	33.9	28.1	3.2	0.0	34.8	74.0	-39.2	
4824	17.3	Ave.	14	8	V	33.9	28.1	3.2	0.0	26.3	54.0	-27.7	
7236	34.8	Peak	14	8	V	38.0	28.0	4.3	0.0	49.1	74.0	-24.9	
7236	28.6	Ave.	14	8	V	38.0	28.0	4.3	0.0	42.9	54.0	-11.1	
12060	36.1	Peak	14	10	V	42.3	39.1	5.9	0.0	45.2	74.0	-28.8	
12060	28.7	Ave.	14	10	V	42.3	39.1	5.9	0.0	37.8	54.0	-16.2	
14472	38.5	Peak	14	10	V	40.7	37.8	6.5	0.0	47.9	74.0	-26.1	
14472	30.9	Ave.	14	10	V	40.7	37.8	6.5	0.0	40.3	54.0	-13.7	
19296*	39.0	Peak	21	13	V	40.2	23.3	7.7	-9.5	54.1	74.0	-19.9	
19296*	26.1	Ave.	21	13	V	40.2	23.3	7.7	-9.5	41.2	54.0	-12.8	
2437	81.4	Peak	14		V	30.1	0.0	2.3	0.0	113.8			
4874	25.0	Peak	14	8	V	33.9	28.1	3.2	0.0	34.0	74.0	-40.0	
4874	17.5	Ave.	14	8	V	33.9	28.1	3.2	0.0	26.5	54.0	-27.5	
7311	34.7	Peak	14	8	V	38.0	28.0	4.3	0.0	49.0	74.0	-25.0	
7311	28.3	Ave.	14	8	V	38.0	28.0	4.3	0.0	42.6	54.0	-11.4	
12185	35.6	Peak	14	10	V	42.3	39.1	5.9	0.0	44.7	74.0	-29.3	
12185	28.5	Ave.	14	10	V	42.3	39.1	5.9	0.0	37.6	54.0	-16.4	
19496*	33.7	Peak	21	13	V	40.2	23.3	7.7	-9.5	48.8	74.0	-25.2	
19496*	22.0	Ave.	21	13	V	40.2	23.3	7.7	-9.5	37.1	54.0	-16.9	
2462	82.3	Peak	14		V	30.1	0.0	2.3	0.0	114.7			
4924	25.4	Peak	14	8	V	33.9	28.1	3.2	0.0	34.4	74.0	-39.6	
4924	17.7	Ave.	14	8	V	33.9	28.1	3.2	0.0	26.7	54.0	-27.3	
7386	34.9	Peak	14	8	V	38.0	28.0	4.3	0.0	49.2	74.0	-24.8	
7386	28.6	Ave.	14	8	V	38.0	28.0	4.3	0.0	42.9	54.0	-11.1	
12310	36.3	Peak	14	10	V	42.3	39.1	5.9	0.0	45.4	74.0	-28.6	
12310	29.9	Ave.	14	10	V	42.3	39.1	5.9	0.0	39.0	54.0	-15.0	
19696*	43.5	Peak	21	13	V	40.3	23.3	7.7	-9.5	58.7	74.0	-15.3	
19696*	34.5	Ave.	21	13	V	40.3	23.3	7.7	-9.5	49.7	54.0	-4.3	
22158*	41.1	Peak	21	13	V	40.3	23.3	7.9	-9.5	56.5	74.0	-17.5	
22158*	29.9	Peak	21	13	V	40.3	23.3	7.9	-9.5	45.3	74.0	-28.7	

- \*Readings taken at 1 meter with RBW 300KHz
- Symbol Technologies declares a duty cycle factor of 19.37 dB. This amount may be subtracted from the margin column.

Plot 6.1

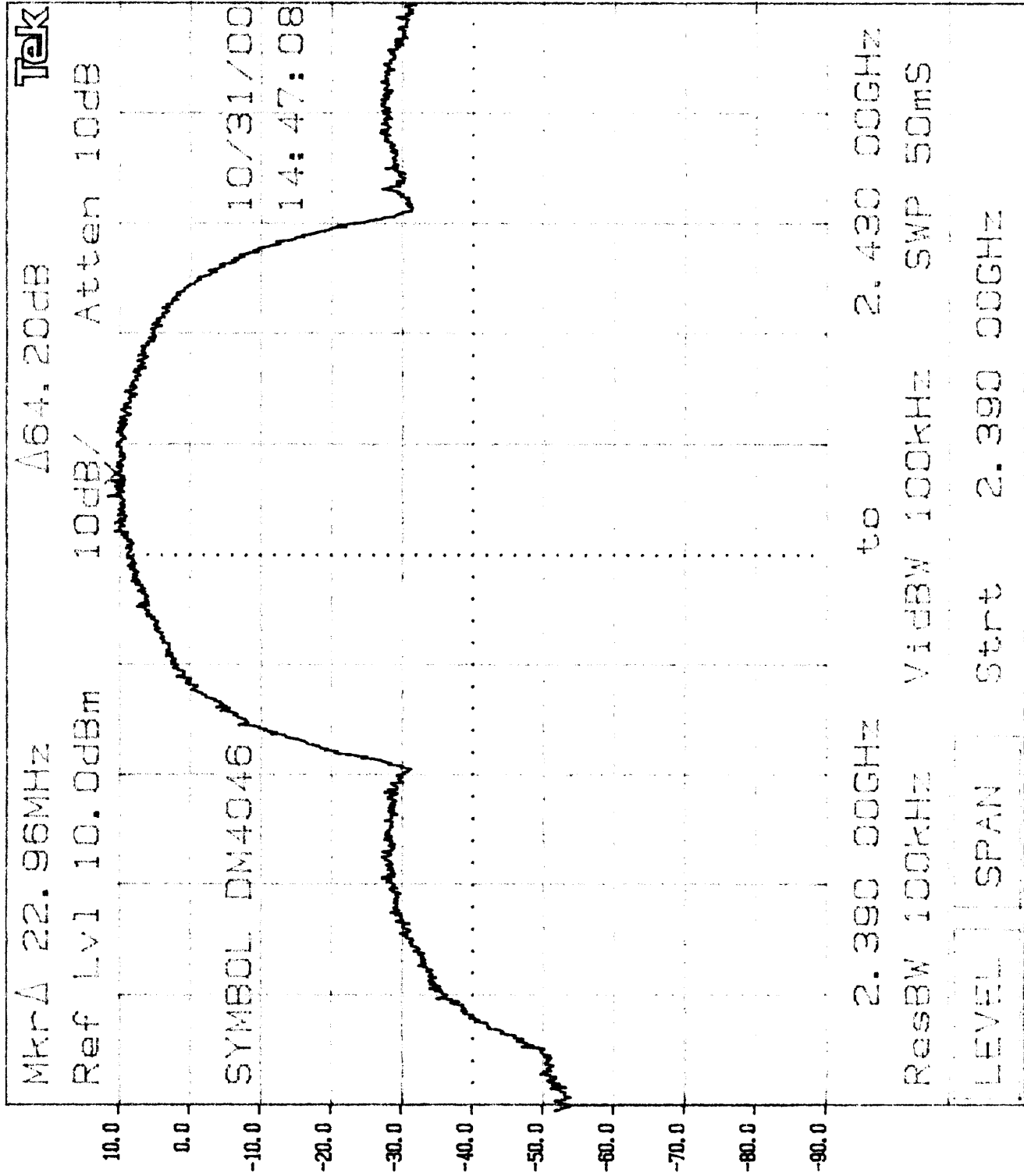

Plot 6.2

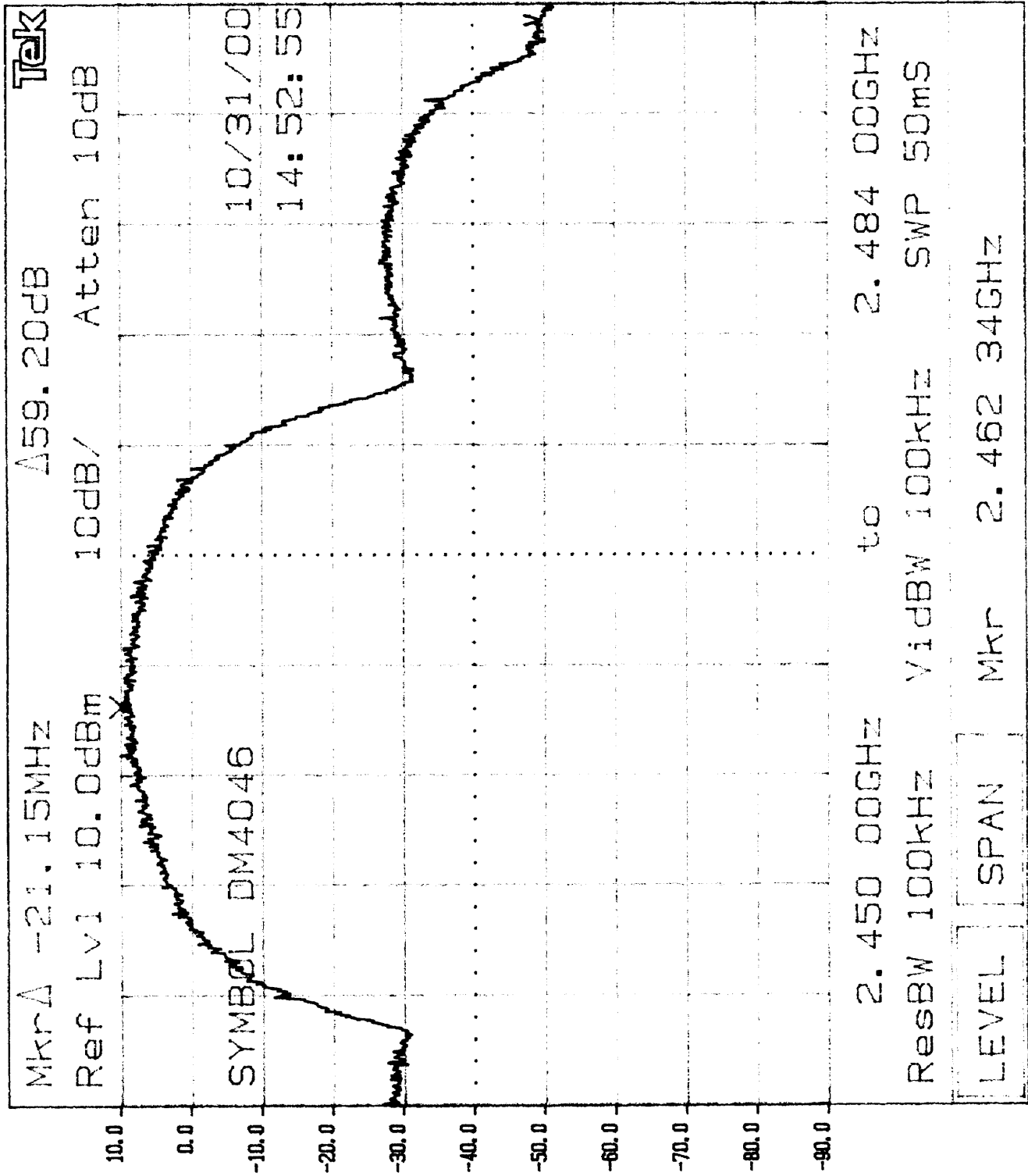

Symbol Technologies,  
FCC ID: H9PDM4046

Date of Test: October 29-31, 2000

4.7 AC Line Conducted Emission, FCC Rule 15.207

Not required; battery operation only

Test data attached

## 4.8 Radiated Emissions from Digital Section of Transceiver (Transmitter), FCC Rule 15.109

Radiated emission measurements were performed from 30 MHz to 1000 MHz.

The EUT was positioned on a non-conductive turntable, 0.8m above the ground plane on an open test site. The radiated emission was measured at 3 m distance. To maximize emissions, the system was rotated through 360°, the antenna height was varied from 1m to 4 m, and the antenna polarization was changed. Data is included of the worst case configuration (the configuration which resulted in the highest emission levels). A sample calculation, configuration photographs and data tables of the emissions are included. All measurements were performed with peak detectors unless otherwise specified.

Configuration Photograph

DP4046 Configuration



NP4046 Configuration



---

Symbol Technologies,  
FCC ID: H9PDM4046

Date of Test: October 29-31, 2000

Test Result:

The data on the following pages (data sheets ## 1 to 2) list the significant emission frequencies, the limit and the margin of compliance.



**Radiated Emissions Test Data**

Company: Symbol		Model #: DP4046	Standard:	FCC § 15B
EUT:		S/N #:	Limits:	2
Project #: J20029320	Test Date: Oct 26, 2000		Test Distance:	3 meters
Test Mode: calling another phone thru hub	Engineer: Barry Smith		Duty Relaxation:	0 dB

Number:	Antenna Used				Pre-Amp Used			Cable Used			Transducer Used
	1	0	2	0	0	3	0	0	0		
Model:	EMCO 3143	None	None	HP B447D	None	None	Site 310m	None	None	None	

Frequency	Reading	Detector	Ant #	Amp #	Ant. Pol.	Ant. Factor	Pre-Amp	Insert. Loss	D. C. F.	Net	Limit @3m	Margin
MHz	dB(μV)	P/A/Q	#	#	H/V	dB(1/m)	dB	dB	dB	dB(μV/m)	dB(μV/m)	dB
40.00E+0	41.7	Peak	1	2	V	6.5	32.0	1.9	0.0	18.1	40.0	-21.9
46.70E+0	48.3	Peak	1	2	V	6.7	32.0	1.9	0.0	24.9	40.0	-15.1
53.10E+0	44.8	Peak	1	2	V	5.2	32.0	2.1	0.0	20.1	40.0	-19.9
40.90E+0	45.2	Peak	1	2	V	7.2	32.0	1.9	0.0	22.3	40.0	-17.7
60.00E+0	48.6	Peak	1	2	V	5.0	32.0	2.3	0.0	23.9	40.0	-16.1
80.00E+0	41.4	Peak	1	2	V	6.8	32.0	2.4	0.0	18.6	40.0	-21.4

**Notes:**

a) D.C.F.: Distance Correction Factor  
 b) Insert. Loss (dB) = Cable A + Cable B + Cable C  
 c) Net (dB) = Reading + Antenna Factor - Pre-amp + Insert. Loss. - Transducer Loss - Duty Relaxation (transmitter only).  
 d) Negative signs (-) in Margin column signify levels below the limits.  
 e) All other emissions not reported are below the equipment noise floor which is at least 20 dB below the limits.

**Radiated Emissions  
Test Data**

Company: Symbol	Model #: NP4046	Standard	FCC § 15B
EUT:	S/N #:	Limits	2
Project #: J20029320	Test Date: Oct 26, 2000	Test Distance	3 meters
Test Mode: calling another phone thru hub	Engineer: Barry S.	Duty Relaxation	0 dB

Antenna Used			Pre-Amp Used			Cable Used			Transducer Used
Number:	1	0	2	0	0	3	0	0	0
Model:	EMCO 3143	None	None	HP 8447D	None	None	Site 3 fcm	None	None

Frequency	Reading	Detector	Ant #	Amp #	Ant. Pol.	Ant. Factor	Pre-Amp	Insert. Loss	D. C. F.	Net	Limit @3m	Margin
MHz	dB(µV)	P/A/Q	#	#	H/V	dB(f/m)	dB	dB	dB	dB(µV/m)	dB(µV/m)	dB
40.00	41.0	Peak	1	2	V	7.3	32.0	1.9	0.0	18.2	40.0	-21.8
59.80	59.7	Peak	1	2	V	5.0	32.0	2.1	0.0	34.8	40.0	-5.2
67.36	59.0	Peak	1	2	V	6.7	32.0	2.3	0.0	36.0	40.0	-4.0
81.80	33.7	Peak	1	2	V	6.8	32.0	2.4	0.0	10.9	40.0	-29.1
396.00	36.9	Peak	1	2	V	15.3	32.0	4.6	0.0	24.8	46.0	-21.2

- Notes:**
- a) D.C.F.: Distance Correction Factor
  - b) Insert. Loss (dB) = Cable A + Cable B + Cable C .
  - c) Net (dB) = Reading + Antenna Factor - Pre-amp + Insert. Loss. - Transducer Loss - Duty Relaxation (transmitter only).
  - d) Negative signs (-) in Margin column signify levels below the limits.
  - e) All other emissions not reported are below the equipment noise floor which is at least 20 dB below the limits.

Symbol Technologies,  
FCC ID: H9PDM4046

Date of Test: October 29-31, 2000

- 4.9 Radiated Emissions from Receiver Section of Transceiver (L.O. Radiation), FCC Rules 15.109, 15.111
- [X] Not required - EUT operation above 960 MHz only
- [ ] Not required - EUT is transmitter only
- [ ] Test results are attached

Symbol Technologies,  
FCC ID: H9PDM4046

Date of Test: October 29-31, 2000

4.10 Processing Gain , FCC Rule 15.247(e)

The processing gain shall be determined from the ratio in dB of the signal to noise ratio with the system spreading code turned OFF, to the signal to noise ratio with the system spreading code turned ON, as measured at the demodulated output of the receiver. The processing gain shall be at least 10 dB for a direct sequence spread spectrum system.

	Refer to attached test procedure and data sheets.
	Refer to circuit analysis and processing gain calculations provided by manufacturer.
X	Refer to Processing Gain Attachment of FCC Application H9PLA4121

Symbol Technologies,  
FCC ID: H9PDM4046

Date of Test: October 29-31, 2000

4.11 Transmitter Duty Cycle Calculation and Measurements, FCC Rule 15.35(b), (c)

The EUT antenna output port was connected to the input of the spectrum analyzer. The analyzer center frequency was set to EUT RF channel carrier. The SWEEP function on the analyzer was set to ZERO SPAN. The transmitter ON time was determined from the resultant time-amplitude display:

Duty Cycle = Maximum ON time in 100 msec/100

Duty Cycle correction, dB =  $20 * \log(\text{DC})=19.4$  dB

	See attached spectrum analyzer chart(s) for transmitter timing
X	See transmitter Duty Cycle Exhibit
	No duty cycle was applied

Symbol Technologies,  
FCC ID: H9PDM4046

Date of Test: October 29-31, 2000

**5.0 List of test equipment**

<b>Equipment</b>	<b>Manufacturer</b>	<b>Model</b>	<b>Serial #</b>	<b>Cal. Int.</b>	<b>Cal. Due</b>	<b>Used</b>
Biconical Antenna	EMCO	3104	3789	12	4/10/01	X
Log Periodic Antenna	EMCO	EM LPA-25	1079	12	4/10/01	X
Double-ridged Horn Antenna	EMCO	3115	8812-3049	12	2/5/01	X
Horn Antenna	EMCO	3160-9	N/A	#	#	X
Pre-amplifier	ComPower	CPPA-102	1256	12	4/28/01	X
Pre-amplifier	CDI	P1000	N/A	12	10/14/00	X
Pre-amplifier	Avantek	AFT18855	8723H705	12	10/14/00	X
Pre-amplifier	CTT	ACO/400	47526	12	10/14/00	X
Spectrum Analyzer w/8650 QP Adapter	Hewlett Packard	HP 8566B	2416A00317 2521A01021	6	2/03/01	X
Spectrum Analyzer	Tektronix	2784	B3020108	12	8/4/01	X
Peak Power Meter	Hewlett Packard	8900D	3607U00673	12	7/31/01	X
Peak Power Sensor	Hewlett Packard	84811A	3318A05091	12	12/7/99	X

# Calibration is not required

Symbol Technologies,  
FCC ID: H9PDM4046

Date of Test: October 29-31, 2000

**6.0 Document History**

<b>Revision/Job Number</b>	<b>Date</b>	<b>Change</b>
1.0 / J20029320	11/17/2000	Original document