

***Electromagnetic Emissions Test Report
and
Application for Grant of Equipment Authorization
pursuant to***

***Industry Canada RSS-Gen Issue 1 / RSS 210 Issue 6
FCC Part 15, Subpart E***

***on the
Symbol Technologies, Inc.
Transmitter
Model: CB3000 Wireless Bridge Adaptor***

UPN: 1549D-CB3000
FCC ID: H9PCB3000

GRANTEE: Symbol Technologies, Inc.
6480 Via del Oro
San Jose, CA 95119

TEST SITE: Elliott Laboratories, Inc.
684 W. Maude Ave
Sunnyvale, CA 94086

REPORT DATE: January 23, 2007

FINAL TEST DATE: November 6, December 4 and December 6,
2006

AUTHORIZED SIGNATORY: _____

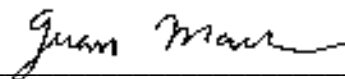

Juan Martinez
Senior EMC Engineer



2016-01

Elliott Laboratories, Inc. is accredited by the A2LA, certificate number 2016-01, to perform the test(s) listed in this report. This report shall not be reproduced, except in its entirety, without the written approval of Elliott Laboratories, Inc.

REVISION HISTORY

Revision #	Date	Comments	Modified By
1	January 29, 2007	Initial Release	David Guidotti
2	February 12, 2007	Added notes to test summary for 4.9dBi and 13 dBi test results	Juan Martinez

TABLE OF CONTENTS

COVER PAGE	1
REVISION HISTORY	2
TABLE OF CONTENTS	3
SCOPE	5
OBJECTIVE	6
STATEMENT OF COMPLIANCE	6
TEST RESULTS SUMMARY	7
UNII / LELAN DEVICES	7
GENERAL REQUIREMENTS APPLICABLE TO ALL BANDS.....	8
MEASUREMENT UNCERTAINTIES	8
EQUIPMENT UNDER TEST (EUT) DETAILS	9
GENERAL.....	9
ANTENNA SYSTEM	9
ENCLOSURE.....	9
MODIFICATIONS.....	9
SUPPORT EQUIPMENT.....	10
EUT INTERFACE PORTS.....	10
EUT OPERATION.....	10
TEST SITE	11
GENERAL INFORMATION.....	11
CONDUCTED EMISSIONS CONSIDERATIONS.....	11
RADIATED EMISSIONS CONSIDERATIONS.....	11
MEASUREMENT INSTRUMENTATION	12
RECEIVER SYSTEM.....	12
INSTRUMENT CONTROL COMPUTER.....	12
LINE IMPEDANCE STABILIZATION NETWORK (LISN).....	12
FILTERS/ATTENUATORS.....	13
ANTENNAS.....	13
ANTENNA MAST AND EQUIPMENT TURNTABLE.....	13
INSTRUMENT CALIBRATION.....	13
TEST PROCEDURES	14
EUT AND CABLE PLACEMENT.....	14
CONDUCTED EMISSIONS.....	14
RADIATED EMISSIONS.....	14
RADIATED EMISSIONS.....	15
BANDWIDTH MEASUREMENTS.....	17
SPECIFICATION LIMITS AND SAMPLE CALCULATIONS.....	17
GENERAL TRANSMITTER RADIATED EMISSIONS SPECIFICATION LIMITS.....	18
FCC 15.407 (A) OUTPUT POWER LIMITS.....	18
OUTPUT POWER AND SPURIOUS LIMITS – UNII DEVICES.....	19
SAMPLE CALCULATIONS - CONDUCTED EMISSIONS.....	19
SAMPLE CALCULATIONS - RADIATED EMISSIONS.....	20
SAMPLE CALCULATIONS - FIELD STRENGTH TO EIRP CONVERSION.....	21

TABLE OF CONTENTS (Continued)

EXHIBIT 1: Test Equipment Calibration Data..... 1
EXHIBIT 2: Test Measurement Data..... 2
EXHIBIT 3: Photographs of Test Configurations..... 3
EXHIBIT 4: Proposed FCC ID Label & Label Location 4
EXHIBIT 5: Detailed Photographs..... 5
EXHIBIT 6: Operator's Manual..... 6
EXHIBIT 7: Block Diagram..... 7
EXHIBIT 8: Schematic Diagrams..... 8
EXHIBIT 9: Theory of Operation..... 9
EXHIBIT 10: Advertising Literature..... 10
EXHIBIT 11: RF Exposure Information 11

SCOPE

An electromagnetic emissions test has been performed on the Symbol Technologies, Inc. model CB3000 Wireless Bridge Adaptor pursuant to the following rules:

Industry Canada RSS-Gen Issue 1
RSS 210 Issue 6 "Low-power Licence-exempt Radiocommunication Devices (All Frequency Bands): Category I Equipment"
FCC Part 15, Subpart E requirements for UNII Devices

Conducted and radiated emissions data has been collected, reduced, and analyzed within this report in accordance with measurement guidelines set forth in the following reference standards and as outlined in Elliott Laboratories test procedures:

The intentional radiator above has been tested in a simulated typical installation to demonstrate compliance with the relevant Industry Canada performance and procedural standards.

Final system data was gathered in a mode that tended to maximize emissions by varying orientation of EUT, orientation of power and I/O cabling, antenna search height, and antenna polarization.

Every practical effort was made to perform an impartial test using appropriate test equipment of known calibration. All pertinent factors have been applied to reach the determination of compliance.

The test results recorded herein are based on a single type test of the Symbol Technologies, Inc. model CB3000 Wireless Bridge Adaptor and therefore apply only to the tested sample. The sample was selected and prepared by Alan Parrish of Symbol Technologies, Inc.

OBJECTIVE

The primary objective of the manufacturer is compliance with the regulations outlined in the previous section.

Prior to marketing in the USA, all unlicensed transmitters and transceivers require certification. Receive-only devices operating between 30 MHz and 960 MHz are subject to either certification or a manufacturer's declaration of conformity, with all other receive-only devices exempt from the technical requirements.

Prior to marketing in Canada, Class I transmitters, receivers and transceivers require certification. Class II devices are required to meet the appropriate technical requirements but are exempt from certification requirements.

Certification is a procedure where the manufacturer submits test data and technical information to a certification body and receives a certificate or grant of equipment authorization upon successful completion of the certification body's review of the submitted documents. Once the equipment authorization has been obtained, the label indicating compliance must be attached to all identical units, which are subsequently manufactured.

Maintenance of compliance is the responsibility of the manufacturer. Any modification of the product which may result in increased emissions should be checked to ensure compliance has been maintained (i.e., printed circuit board layout changes, different line filter, different power supply, harnessing or I/O cable changes, etc.).

STATEMENT OF COMPLIANCE

The tested sample of Symbol Technologies, Inc. model CB3000 Wireless Bridge Adaptor complied with the requirements of the following regulations:

RSS 210 Issue 6 "Low-power Licence-exempt Radiocommunication Devices (All Frequency Bands): Category I Equipment"
FCC Part 15, Subpart E requirements for UNII Devices

Maintenance of compliance is the responsibility of the manufacturer. Any modification of the product which may result in increased emissions should be checked to ensure compliance has been maintained (i.e., printed circuit board layout changes, different line filter, different power supply, harnessing or I/O cable changes, etc.).

TEST RESULTS SUMMARY**UNII / LELAN DEVICES****Operation in the 5.47 – 5.725 GHz Band**

FCC Rule Part	RSS Rule Part	Description	Measured Value / Comments	Limit / Requirement	Result (margin)
15.407(a)(2)		26dB Bandwidth	38.5 MHz		N/A
15.407(a)(2)	A9.2(2)	Output Power	19.7dBm dBm (0.094 W)	Note: This is for the 4.9dBi antenna	Complies
15.407(a)(2)	A9.2(2)	Power Spectral Density	7.14 dBm/MHz	Note: This is for the 4.9dBi antenna	Complies
15.407(a)(2)	A9.2(2)	Output Power	14.4dBm dBm (0.028 W)	Note: This is for the 13dBi antenna	Complies
15.407(a)(2)	A9.2(2)	Power Spectral Density	3.77 dBm/MHz	Note: This is for the 13dBi antenna	Complies
	A9.5b	Peak Spectral Density	10.3 dBm/MHz	Shall not exceed the average value by more than 3dB	Complies
15.407(a)(2)	A9.4	Dynamic frequency selection / Transmit power control	DFS has already been evaluated with the lowest gain antenna 3 dBi. This application is to add higher gain antennas.		N/A
15.407(a)(2)	A9.4	Dynamic frequency selection / Transmit power control	Refer to separate test report		Complies

General requirements for all bands

FCC Rule Part	RSS Rule Part	Description	Measured Value / Comments	Limit / Requirement	Result
	A9.5a	Modulation	Class II Change to add new frequency	Digital modulation is required	Complies
	RSP 100	99% bandwidth	17.8 MHz		
15.407(b) (5) / 15.209	A9.3	Spurious Emissions below 1GHz	Class II change no change to digital circuit		N/A
15.407(b) (2)	A9.3	Spurious Emissions above 1GHz	53.1dB μ V/m (451.9 μ V/m) @ 10999.3MHz		Complies (-0.9 dB)
15.407(a)(6)	-	Peak Excursion Ratio	11.53 dB	< 13dB	Complies
	A9.5c	Channel Selection	The device was tested at the highest, lowest and center channels in each operating range.	Device shall be tested on the top, bottom and center channels in each band	N/A
15.407 (c)	A9.5d	Operation in the absence of information to transmit	Operation is discontinued in the absence of information (Class II change)	Device shall automatically discontinue operation in the absence of information to transmit	Complies
15.407 (g)	A9.5e	Frequency Stability	Frequency stability is better than 10ppm (Class II change)		Complies
	A9.9g	User Manual information	Class II change		Complies

GENERAL REQUIREMENTS APPLICABLE TO ALL BANDS

FCC Rule Part	RSS Rule part	Description	Measured Value / Comments	Limit / Requirement	Result (margin)
15.203	-	RF Connector	Class II change		Complies
15.109	RSS GEN 7.2.3 Table 1	Receiver spurious emissions	22.4dB μ V/m (13.2 μ V/m) @ 132.871MHz (-7.6dB)		Complies
15.207	RSS GEN Table 2	AC Conducted Emissions	Class II change	Refer to standard	Complies
15.247 (b) (5) 15.407 (f)	RSS 102	RF Exposure Requirements	Class II change	Refer to OET 65, FCC Part 1 and RSS 102	Complies
	RSP 100 RSS GEN 7.1.5	User Manual	Class II change	Statement required regarding non-interference	
	RSP 100 RSS GEN 7.1.5	User Manual	Class II change	Statement required regarding detachable antenna	

MEASUREMENT UNCERTAINTIES

ISO Guide 17025 requires that an estimate of the measurement uncertainties associated with the emissions test results be included in the report. The measurement uncertainties given below are based on a 95% confidence level and were calculated in accordance with UKAS document LAB 34.

Measurement Type	Frequency Range (MHz)	Calculated Uncertainty (dB)
Conducted Emissions	0.15 to 30	± 2.4
Radiated Emissions	0.015 to 30	± 3.0
Radiated Emissions	30 to 1000	± 3.6
Radiated Emissions	1000 to 40000	± 6.0

EQUIPMENT UNDER TEST (EUT) DETAILS**GENERAL**

The Symbol Technologies, Inc. model CB3000 Wireless Bridge Adaptor is a Wireless bridge router that is designed to provide wireless internet and network service. Since the EUT would be placed on a table top during operation, the EUT was treated as table-top equipment during testing to simulate the end-user environment. The electrical rating of the EUT is 120 Volts , 60 Hz, 1 Amps.

The sample was received on November 6, 2006 and tested on November 6, December 4 and December 6, 2006. The EUT consisted of the following component(s):

Manufacturer	Model	Description	Serial Number	FCC ID
Symbol Technology	CB3000	wireless bridge router	6146529900788	H9PCB3000
Symbol Technology	Antenna	5.15-5.875 GHz 13dBi wide band Panel Antenna	ML-5299- WPNA1	-
Symbol Technology	Antenna	5.15-5.875 GHz 4.9dBi wide band Omnidirectional Antenna	ML05299- HPA1-01	-

ANTENNA SYSTEM

The antenna system used with the Symbol Technologies, Inc. model CB3000 Wireless Bridge Adaptor consists of Reverse polarity connector.

ENCLOSURE

The EUT enclosure is primarily constructed of plastic. It measures approximately 17.5 cm wide by 10 cm deep by 3 cm high.

MODIFICATIONS

The EUT did not require modifications during testing in order to comply with emissions specifications.

SUPPORT EQUIPMENT

The following equipment was used as local support equipment for emissions testing:

Manufacturer	Model	Description	Serial Number	FCC ID
Dell	PP01L	Laptop	01014	DoC
Epson	740	Printer	A6R1320291	-

No support equipment was used during emissions testing.

EUT INTERFACE PORTS

The I/O cabling configuration during emissions testing was as follows:

Port	Connected To	Cable(s)		
		Description	Shielded or Unshielded	Length(m)
Ethernet	Laptop	Cat5	Unshielded	1.0
AC Power	AC Mains	Multiwire	Unshielded	1.8
RF	Antenna	-	-	-

EUT OPERATION

EUT was set to transmit at maximum power at 6Mbps on channels 5500, 5600, and 5700 MHz.

TEST SITE

GENERAL INFORMATION

Final test measurements were taken on November 6, December 4 and December 6, 2006 at the Elliott Laboratories Open Area Test Site #1 & 2 located at 684 West Maude Avenue, Sunnyvale, California. Pursuant to section 2.948 of the FCC's Rules and section 3.3 of RSP-100, construction, calibration, and equipment data has been filed with the Commission.

ANSI C63.4:2003 recommends that ambient noise at the test site be at least 6 dB below the allowable limits. Ambient levels are below this requirement with the exception of predictable local TV, radio, and mobile communications traffic. The test site contains separate areas for radiated and conducted emissions testing. Considerable engineering effort has been expended to ensure that the facilities conform to all pertinent requirements of ANSI C63.4:2003 and RSS 212.

CONDUCTED EMISSIONS CONSIDERATIONS

Conducted emissions testing is performed in conformance with ANSI C63.4:2003 and RSS 212. Measurements are made with the EUT connected to the public power network through a nominal, standardized RF impedance, which is provided by a line impedance stabilization network, known as a LISN. A LISN is inserted in series with each current-carrying conductor in the EUT power cord.

RADIATED EMISSIONS CONSIDERATIONS

The FCC has determined that radiation measurements made in a shielded enclosure are not suitable for determining levels of radiated emissions. Radiated measurements are performed in an open field environment or in a semi-anechoic chamber. The test sites are maintained free of conductive objects within the CISPR defined elliptical area incorporated in ANSI C63.4:2003 guidelines and meet the Normalized Site Attenuation (NSA) requirements of ANSI C63.4:2003 / RSS 212.

MEASUREMENT INSTRUMENTATION

RECEIVER SYSTEM

An EMI receiver as specified in CISPR 16-1 is used for emissions measurements. The receivers used can measure over the frequency range of 9 kHz up to 2000 MHz. These receivers allow both ease of measurement and high accuracy to be achieved. The receivers have Peak, Average, and CISPR (Quasi-peak) detectors built into their design so no external adapters are necessary. The receiver automatically sets the required bandwidth for the CISPR detector used during measurements. If the repetition frequency of the signal being measured is below 20Hz, peak measurements are made in lieu of Quasi-Peak measurements.

For measurements above the frequency range of the receivers, a spectrum analyzer is utilized because it provides visibility of the entire spectrum along with the precision and versatility required to support engineering analysis. Average measurements above 1000MHz are performed on the spectrum analyzer using the linear-average method with a resolution bandwidth of 1 MHz and a video bandwidth of 10 Hz, unless the signal is pulsed in which case the average (or video) bandwidth of the measuring instrument is reduced to onset of pulse desensitization and then increased.

INSTRUMENT CONTROL COMPUTER

The receivers utilize either a Rohde & Schwarz EZM Spectrum Monitor/Controller or contain an internal Spectrum Monitor/Controller to view and convert the receiver measurements to the field strength at an antenna or voltage developed at the LISN measurement port, which is then compared directly with the appropriate specification limit. This provides faster, more accurate readings by performing the conversions described under Sample Calculations within the Test Procedures section of this report. Results are printed in a graphic and/or tabular format, as appropriate. A personal computer is used to record all measurements made with the receivers.

The Spectrum Monitor provides a visual display of the signal being measured. In addition, the controller or a personal computer run automated data collection programs which control the receivers. This provides added accuracy since all site correction factors, such as cable loss and antenna factors are added automatically.

LINE IMPEDANCE STABILIZATION NETWORK (LISN)

Line conducted measurements utilize a fifty microhenry Line Impedance Stabilization Network as the monitoring point. The LISN used also contains a 250 uH CISPR adapter. This network provides for calibrated radio frequency noise measurements by the design of the internal low pass and high pass filters on the EUT and measurement ports, respectively.

FILTERS/ATTENUATORS

External filters and precision attenuators are often connected between the receiving antenna or LISN and the receiver. This eliminates saturation effects and non-linear operation due to high amplitude transient events.

ANTENNAS

A loop antenna is used below 30 MHz. For the measurement range 30 MHz to 1000 MHz either a combination of a biconical antenna and a log periodic or a bi-log antenna is used. Above 1000 MHz, horn antennas are used. The antenna calibration factors to convert the received voltage to an electric field strength are included with appropriate cable loss and amplifier gain factors to determine an overall site factor, which is then programmed into the test receivers or incorporated into the test software.

ANTENNA MAST AND EQUIPMENT TURNTABLE

The antennas used to measure the radiated electric field strength are mounted on a non-conductive antenna mast equipped with a motor-drive to vary the antenna height. Measurements below 30 MHz are made with the loop antenna at a fixed height of 1m above the ground plane.

ANSI C63.4:2003 and RSS 212 specify that the test height above ground for table mounted devices shall be 80 centimeters. Floor mounted equipment shall be placed on the ground plane if the device is normally used on a conductive floor or separated from the ground plane by insulating material from 3 to 12 mm if the device is normally used on a non-conductive floor. During radiated measurements, the EUT is positioned on a motorized turntable in conformance with this requirement.

INSTRUMENT CALIBRATION

All test equipment is regularly checked to ensure that performance is maintained in accordance with the manufacturer's specifications. All antennas are calibrated at regular intervals with respect to tuned half-wave dipoles. An exhibit of this report contains the list of test equipment used and calibration information.

TEST PROCEDURES

EUT AND CABLE PLACEMENT

The regulations require that interconnecting cables be connected to the available ports of the unit and that the placement of the unit and the attached cables simulate the worst case orientation that can be expected from a typical installation, so far as practicable. To this end, the position of the unit and associated cabling is varied within the guidelines of ANSI C63.4:2003, and the worst-case orientation is used for final measurements.

CONDUCTED EMISSIONS

Conducted emissions are measured at the plug end of the power cord supplied with the EUT. Excess power cord length is wrapped in a bundle between 30 and 40 centimeters in length near the center of the cord. Preliminary measurements are made to determine the highest amplitude emission relative to the specification limit for all the modes of operation. Placement of system components and varying of cable positions are performed in each mode. A final peak mode scan is then performed in the position and mode for which the highest emission was noted on all current carrying conductors of the power cord.

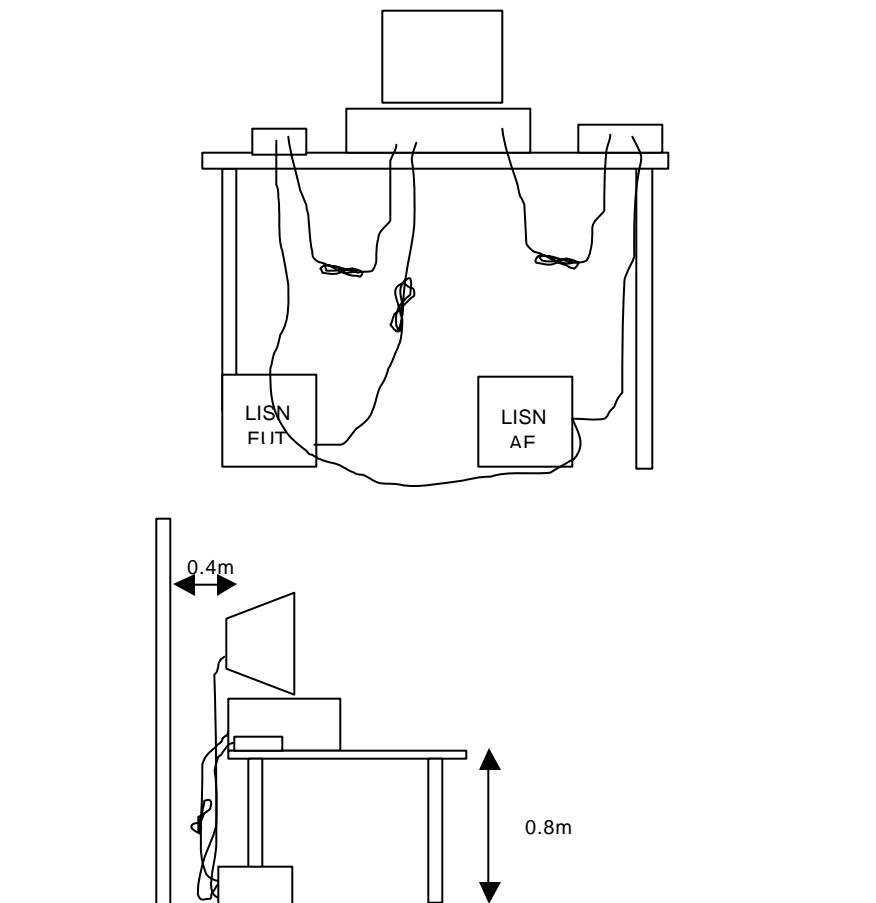

RADIATED EMISSIONS

A preliminary scan of the radiated emissions is performed in which all significant EUT frequencies are identified with the system in a nominal configuration. At least two scans are performed, one scan for each antenna polarization (horizontal and vertical; loop parallel and perpendicular to the EUT). During the preliminary scans, the EUT is rotated through 360°, the antenna height is varied (for measurements above 30 MHz) and cable positions are varied to determine the highest emission relative to the limit. Preliminary scans may be performed in a fully anechoic chamber for the purposes of identifying the frequencies of the highest emissions from the EUT.

A speaker is provided in the receiver to aid in discriminating between EUT and ambient emissions. Other methods used during the preliminary scan for EUT emissions involve scanning with near field magnetic loops, monitoring I/O cables with RF current clamps, and cycling power to the EUT.

Final maximization is a phase in which the highest amplitude emissions identified in the spectral search are viewed while the EUT azimuth angle is varied from 0 to 360 degrees relative to the receiving antenna. The azimuth, which results in the highest emission is then maintained while varying the antenna height from one to four meters (for measurements above 30 MHz, measurements below 30 MHz are made with the loop antenna at a fixed height of 1m). The result is the identification of the highest amplitude for each of the highest peaks. Each recorded level is corrected in the receiver using appropriate factors for cables, connectors, antennas, and preamplifier gain.

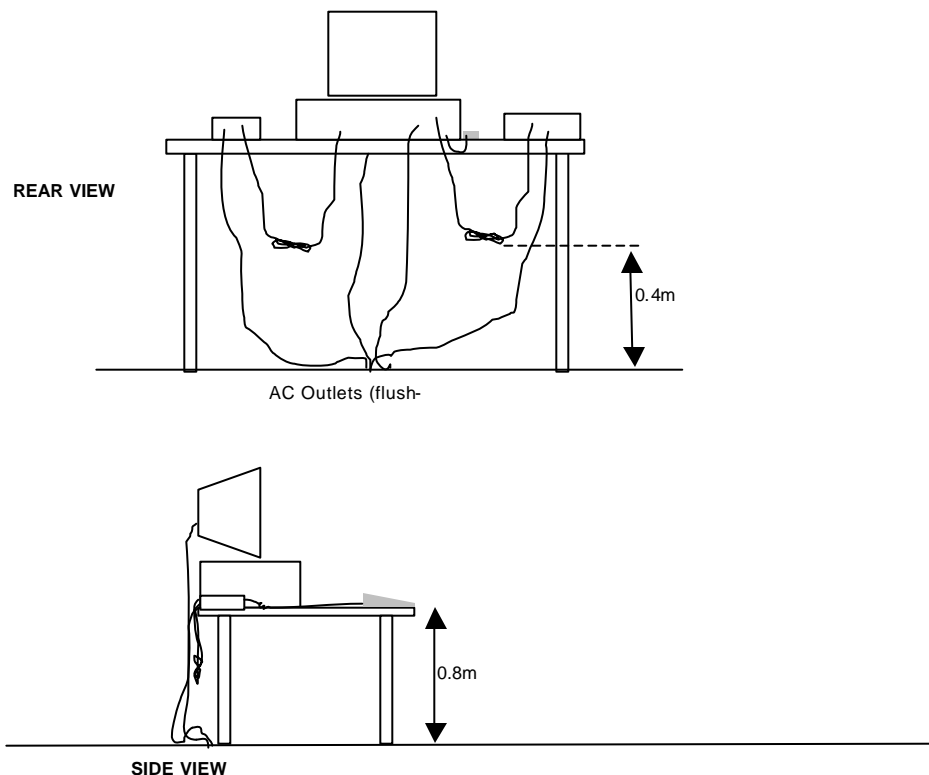

Typical Test Configuration for Radiated Field Strength Measurements

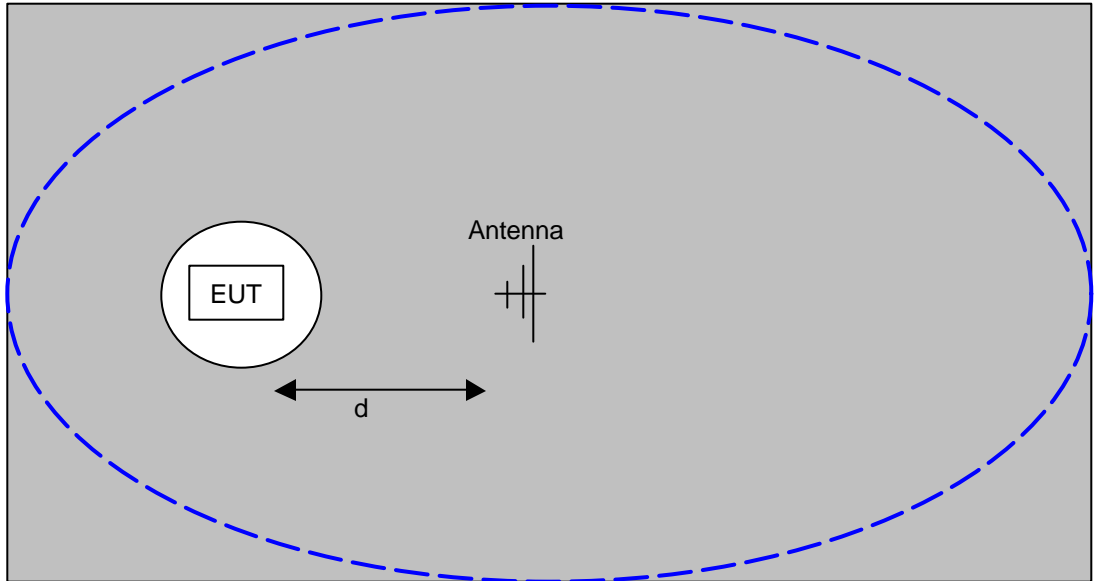

The ground plane extends beyond the ellipse defined in CISPR 16 / CISPR 22 / ANSI C63.4 and is large enough to accommodate test distances (d) of 3m and 10m. Refer to the test data tables for the actual measurement distance.

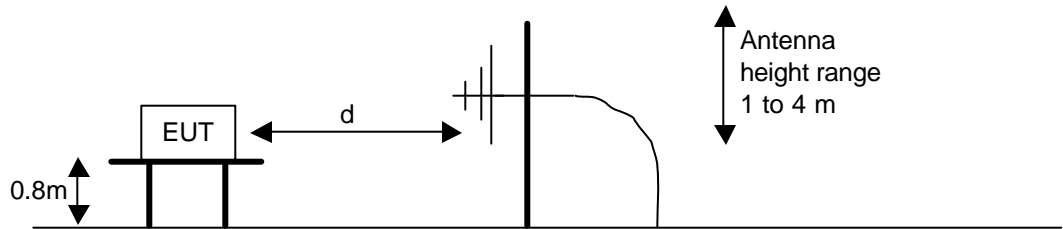

Test Configuration for Radiated Field Strength Measurements
OATS- Plan and Side Views

BANDWIDTH MEASUREMENTS

The 6dB, 20dB and/or 26dB signal bandwidth is measured in using the bandwidths recommended by ANSI C63.4. When required, the 99% bandwidth is measured using the methods detailed in RSS GEN.

SPECIFICATION LIMITS AND SAMPLE CALCULATIONS

The limits for conducted emissions are given in units of microvolts, and the limits for radiated emissions are given in units of microvolts per meter at a specified test distance. Data is measured in the logarithmic form of decibels relative to one microvolt, or dB microvolts (dBuV). For radiated emissions, the measured data is converted to the field strength at the antenna in dB microvolts per meter (dBuV/m). The results are then converted to the linear forms of uV and uV/m for comparison to published specifications.

For reference, converting the specification limits from linear to decibel form is accomplished by taking the base ten logarithm, then multiplying by 20. These limits in both linear and logarithmic form are as follows:

GENERAL TRANSMITTER RADIATED EMISSIONS SPECIFICATION LIMITS

The table below shows the limits for the spurious emissions from transmitters that fall in restricted bands¹ (with the exception of transmitters operating under FCC Part 15 Subpart D and RSS 210 Annex 9), the limits for all emissions from a low power device operating under the general rules of RSS 310 (tables 3 and 4), RSS 210 (table 2) and FCC Part 15 Subpart C section 15.209.

Frequency Range (MHz)	Limit (uV/m)	Limit (dBuV/m @ 3m)
0.009-0.490	$2400/F_{\text{KHz}} @ 300\text{m}$	$67.6-20*\log_{10}(F_{\text{KHz}}) @ 300\text{m}$
0.490-1.705	$24000/F_{\text{KHz}} @ 30\text{m}$	$87.6-20*\log_{10}(F_{\text{KHz}}) @ 30\text{m}$
1.705 to 30	30 @ 30m	29.5 @ 30m
30 to 88	100 @ 3m	40 @ 3m
88 to 216	150 @ 3m	43.5 @ 3m
216 to 960	200 @ 3m	46.0 @ 3m
Above 960	500 @ 3m	54.0 @ 3m

FCC 15.407 (a) OUTPUT POWER LIMITS

The table below shows the limits for output power and output power density. Where the signal bandwidth is less than 20 MHz the maximum output power is reduced to the power spectral density limit plus 10 times the log of the bandwidth (in MHz).

Operating Frequency (MHz)	Output Power	Power Spectral Density
5150 - 5250	50mW (17 dBm)	4 dBm/MHz
5250 - 5350	250 mW (24 dBm)	11 dBm/MHz
5725 – 5825	1 Watts (30 dBm)	17 dBm/MHz

For system using antennas with gains exceeding 6dBi, the output power and power spectral density limits are reduced by 1dB for every dB the antenna gain exceeds 6dBi.

Fixed point-to-point applications using the 5725 – 5825 MHz band may use antennas with gains of up to 23dBi without this limitation. If the gain exceeds 23dBi then the output power limit of 1 Watt is reduced by 1dB for every dB the gain exceeds 23dBi.

¹ The restricted bands are detailed in FCC 15.203, RSS 210 Table 1 and RSS 310 Table 2

OUTPUT POWER AND SPURIOUS LIMITS -UNII DEVICES

The table below shows the limits for output power and output power density defined by FCC Part 15 Subpart E. Where the signal bandwidth is less than 20 MHz the maximum output power is reduced to the power spectral density limit plus 10 times the log of the bandwidth (in MHz).

Operating Frequency (MHz)	Output Power	Power Spectral Density
5150 - 5250	50mW (17 dBm)	10 dBm/MHz
5250 - 5350	250 mW (24 dBm)	11 dBm/MHz
5470 - 5725	250 mW (24 dBm)	11 dBm/MHz
5725 - 5825	1 Watts (30 dBm)	17 dBm/MHz

The peak excursion envelope is limited to 13dB.

For system using antennas with gains exceeding 6dBi, the output power and power spectral density limits are reduced by 1dB for every dB the antenna gain exceeds 6dBi.

Fixed point-to-point applications using the 5725 – 5825 MHz band may use antennas with gains of up to 23dBi without this limitation. If the gain exceeds 23dBi then the output power limit of 1 Watt is reduced by 1dB for every dB the gain exceeds 23dBi.

SAMPLE CALCULATIONS - CONDUCTED EMISSIONS

Receiver readings are compared directly to the conducted emissions specification limit (decibel form) as follows:

$$R_r - S = M$$

where:

R_r = Receiver Reading in dBuV

S = Specification Limit in dBuV

M = Margin to Specification in +/- dB

SAMPLE CALCULATIONS - RADIATED EMISSIONS

Receiver readings are compared directly to the specification limit (decibel form). The receiver internally corrects for cable loss, preamplifier gain, and antenna factor. The calculations are in the reverse direction of the actual signal flow, thus cable loss is added and the amplifier gain is subtracted. The Antenna Factor converts the voltage at the antenna coaxial connector to the field strength at the antenna elements.

A distance factor, when used for electric field measurements above 30MHz, is calculated by using the following formula:

$$F_d = 20 * \text{LOG}_{10} (D_m/D_s)$$

where:

F_d = Distance Factor in dB

D_m = Measurement Distance in meters

D_s = Specification Distance in meters

For electric field measurements below 30MHz the extrapolation factor is either determined by making measurements at multiple distances or a theoretical value is calculated using the formula:

$$F_d = 40 * \text{LOG}_{10} (D_m/D_s)$$

Measurement Distance is the distance at which the measurements were taken and Specification Distance is the distance at which the specification limits are based. The antenna factor converts the voltage at the antenna coaxial connector to the field strength at the antenna elements.

The margin of a given emission peak relative to the limit is calculated as follows:

$$R_c = R_r + F_d$$

and

$$M = R_c - L_s$$

where:

$$R_r = \text{Receiver Reading in dBuV/m}$$

$$F_d = \text{Distance Factor in dB}$$

$$R_c = \text{Corrected Reading in dBuV/m}$$

$$L_s = \text{Specification Limit in dBuV/m}$$

$$M = \text{Margin in dB Relative to Spec}$$

SAMPLE CALCULATIONS - FIELD STRENGTH TO EIRP CONVERSION

Where the radiated electric field strength is expressed in terms of the equivalent isotropic radiated power (eirp), or where a field strength measurement of output power is made in lieu of a direct measurement, the following formula is used to convert between eirp and field strength at a distance of 3m from the equipment under test:

$$E = \frac{1000000 \sqrt{30 P}}{3} \text{ microvolts per meter}$$

where P is the eirp (Watts)

EXHIBIT 1: Test Equipment Calibration Data

1 Page

Radiated Emissions, 30 - 40,000 MHz, 04-Dec-06**Engineer: Mehran Birgani**

<u>Manufacturer</u>	<u>Description</u>	<u>Model #</u>	<u>Asset #</u>	<u>Cal Due</u>
Elliott Laboratories	Biconical Antenna, 30-300 MHz	EL30.300	54	07-Mar-07
Hewlett Packard	Microwave Preamplifier, 1-26.5GHz	8449B	870	15-Nov-07
EMCO	Antenna, Horn, 1-18 GHz (SA40, 30 Hz)	3115	1142	07-Jun-08
Hewlett Packard	High Pass filter, 8.2 GHz	P/N 84300-80039	1156	05-Jul-07
EMCO	Log Periodic Antenna, 0.2-1 GHz	3146	1294	25-May-07
Rohde & Schwarz	Test Receiver, 0.009-2750 MHz	ESN	1332	21-Nov-07
Hewlett Packard	SpecAn 9 kHz - 40 GHz, FMT (SA40) Blue	8564E (84125C)	1393	10-Jan-07

Radiated Emissions, 30 - 40,000 MHz, 06-Dec-06**Engineer: Mehran Birgani**

<u>Manufacturer</u>	<u>Description</u>	<u>Model #</u>	<u>Asset #</u>	<u>Cal Due</u>
Hewlett Packard	Microwave Preamplifier, 1-26.5GHz	8449B	870	15-Nov-07
EMCO	Antenna, Horn, 1-18 GHz (SA40, 30 Hz)	3115	1142	07-Jun-08
Hewlett Packard	High Pass filter, 8.2 GHz	P/N 84300-80039	1156	05-Jul-07
Hewlett Packard	SpecAn 9 kHz - 40 GHz, FMT (SA40) Blue	8564E (84125C)	1393	10-Jan-07

EXHIBIT 2: Test Measurement Data

25 Pages



EMC Test Data

Client:	Symbol Technologies	Job Number:	J66283
Model:	CB3000 Wireless Bridge Adaptor	Test-Log Number:	T66330
		Project Manager:	Sheareen
Contact:	Alan Parrish		
Emissions Spec:	FCC 15.401	Class:	Radio
Immunity Spec:	-	Environment:	-

EMC Test Data

For The

Symbol Technologies

Model

CB3000 Wireless Bridge Adaptor

Date of Last Test: 1/10/2007



EMC Test Data

Client:	Symbol Technologies	Job Number:	J66283
Model:	CB3000 Wireless Bridge Adaptor	Test-Log Number:	T66330
		Project Manager:	Sheareen
Contact:	Alan Parrish		
Emissions Spec:	FCC 15.401	Class:	Radio
Immunity Spec:	-	Environment:	-

EUT INFORMATION

The following information was collected during the test sessions(s).

General Description

The EUT is a Wireless bridge router that is designed to provide wireless internet and network service. Since the EUT would be placed on a table top during operation, the EUT was treated as table-top equipment during testing to simulate the end-user environment. The electrical rating of the EUT is 120 Volts , 60 Hz, 1 Amps.

Equipment Under Test

Manufacturer	Model	Description	Serial Number	FCC ID
Symbol Technology	CB3000	wireless bridge router	6146529900788	H9PCB3000
Symbol Technology	Antenna	5.15-5.875 GHz 13dBi wide band Panel Antenna	ML-5299-WPNA1	-
Symbol Technology	Antenna	5.15-5.875 GHz 4.9dBi wide band Omnidirectional Anetnna	ML-5299-HPA1-01	-

Other EUT Details

None

EUT Antenna (Intentional Radiators Only)

The antenna connects to the EUT via a non-standard reverse polarity antenna connector, thereby meeting the requirements of FCC 15.203.

EUT Enclosure

The EUT enclosure is primarily constructed of plastic . It measures approximately 17.5 cm wide by 10 cm deep by 3 cm high.



EMC Test Data

Client:	Symbol Technologies	Job Number:	J66283
Model:	CB3000 Wireless Bridge Adaptor	T-Log Number:	T66330
Contact:	Alan Parrish	Project Manager:	Sheareen
Emissions Spec:	FCC 15.401	Class:	Radio
Immunity Spec:	-	Environment:	-

Test Configuration #1

The following information was collected during the test sessions(s).

Local Support Equipment

Manufacturer	Model	Description	Serial Number	FCC ID
Dell	PP01L	Laptop	01014	DoC
Epson	740	Printer	A6R1320291	-

Remote Support Equipment

Manufacturer	Model	Description	Serial Number	FCC ID
None	-	-	-	-

Cabling and Ports

Port	Connected To	Cable(s)		
		Description	Shielded or Unshielded	Length(m)
Ethernet	Laptop	Cat5	Unshielded	1.0
AC Power	AC Mains	Multewire	Unshielded	1.8
RF	Antenna	-	-	-

EUT Operation During Radio Tests

EUT was set to transmit at maximum power at 6Mbps on channels 5500, 5600, and 5700 MHz.

Client: Symbol Technologies	Job Number: J66283
Model: CB3000 Wireless Bridge Adaptor	T-Log Number: T66330
	Account Manager: Sheareen
Contact: Alan Parrish	
Spec: FCC 15.401	Class: N/A

**Radiated Emissions
13dBi Antenna**

Test Specifics

Objective: The objective of this test session is to perform engineering evaluation testing of the EUT with respect to the specification listed above.

Date of Test: 12/4/2006	Config. Used: 1
Test Engineer: Mehran Birgani	Config Change: None
Test Location: SVOATS #2	EUT Voltage: 120V/60Hz

General Test Configuration

The EUT and all local support equipment were located on the turntable for radiated spurious emissions testing.

For radiated emissions testing the measurement antenna was located 3 meters from the EUT.

Ambient Conditions: Temperature: 10 °C
 Rel. Humidity: 53 %

Summary of Results

Run #	Test Performed	Limit	Pass / Fail	Result / Margin
1	RE, 30 - 18000 MHz Spurious Emissions	FCC Part 15.407 RSS 210	Pass	22.4dBµV/m (13.2µV/m) @ 132.871MHz (-7.6dB)

Modifications Made During Testing:

No modifications were made to the EUT during testing

Deviations From The Standard

No deviations were made from the requirements of the standard.

Client: Symbol Technologies	Job Number: J66283
Model: CB3000 Wireless Bridge Adaptor	T-Log Number: T66330
	Account Manager: Sheareen
Contact: Alan Parrish	
Spec: FCC 15.401	Class: N/A

Run #1: Radiated Spurious Emissions, 30 - 18000 MHz. Receive Mode, Center Channel @ 5600 MHz

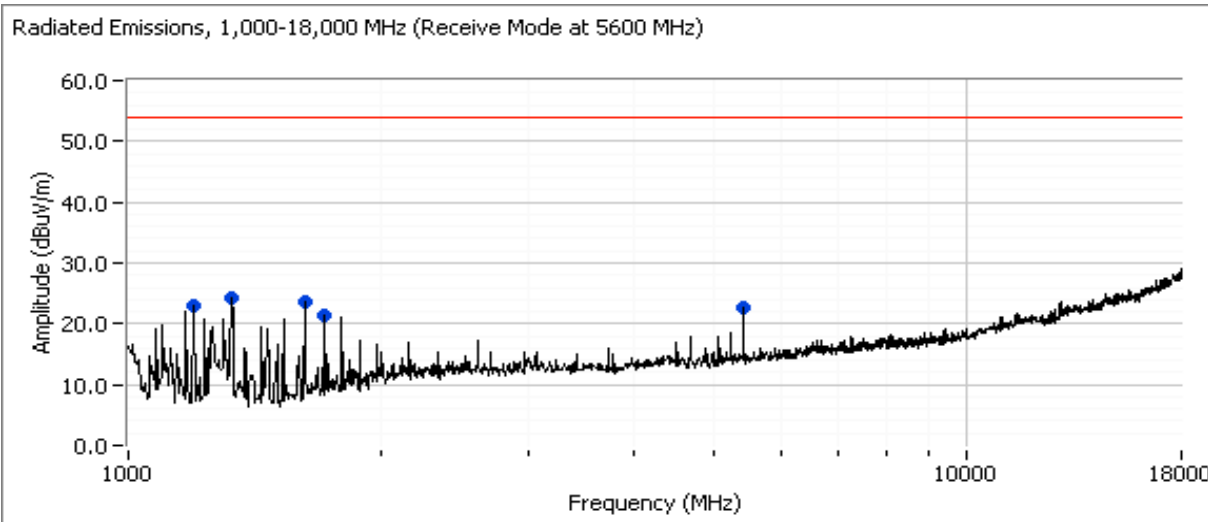
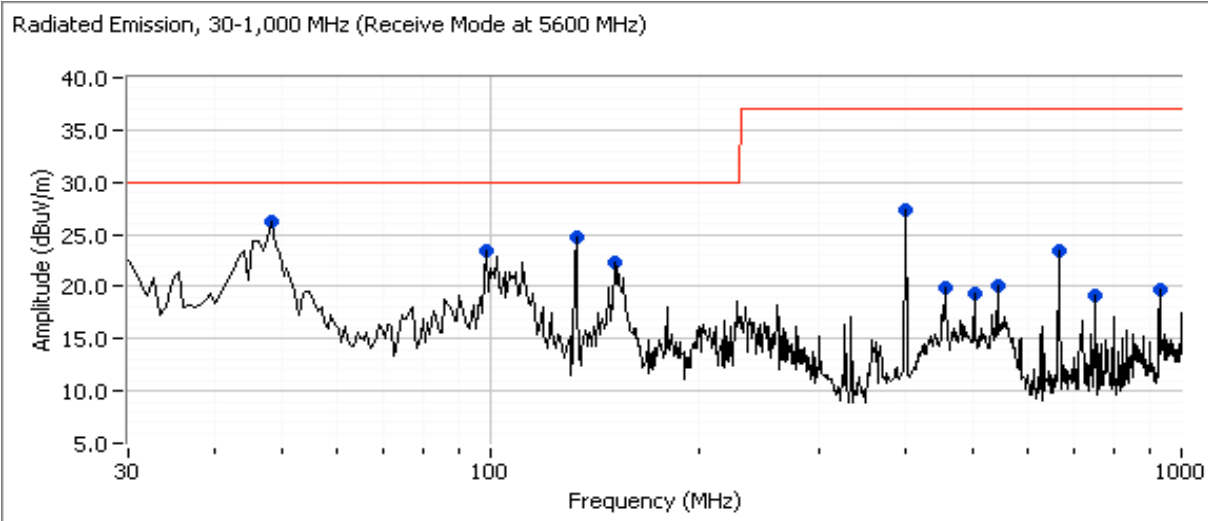



EMC Test Data

Client:	Symbol Technologies	Job Number:	J66283
Model:	CB3000 Wireless Bridge Adaptor	T-Log Number:	T66330
		Account Manager:	Sheareen
Contact:	Alan Parrish		
Spec:	FCC 15.401	Class:	N/A

Run #1: Radiated Spurious Emissions, 30 - 18000 MHz. Receive Mode, Center Channel @ 5600 MHz

Frequency MHz	Level dBµV/m	Pol V/H	15.407 / RSS 210		Detector Pk/QP/Avg	Azimuth degrees	Height meters	Comments
			Limit	Margin				
132.871	22.4	V	30.0	-7.6	Peak	110	1.1	
150.283	22.3	H	30.0	-7.7	Peak	178	1.9	
47.768	21.4	V	30.0	-8.6	Peak	18	1.0	
98.396	18.9	V	30.0	-11.1	Peak	24	1.0	
398.637	24.1	H	37.0	-12.9	Peak	0	3.0	
666.016	23.4	V	37.0	-13.6	Peak	20	1.0	
500.006	20.4	V	37.0	-16.6	Peak	360	1.0	
540.007	20.0	V	37.0	-17.0	Peak	19	1.0	
930.812	19.8	V	37.0	-17.2	Peak	0	1.0	
750.090	19.2	V	37.0	-17.8	Peak	23	1.0	
455.030	15.4	V	37.0	-21.6	Peak	300	1.0	

Note 1 All channels were scanned at chamber, showed no difference between low, center and high channel. Center channel data was used at open site for final qualification.

Client: Symbol Technologies	Job Number: J66283
Model: CB3000 Wireless Bridge Adaptor	T-Log Number: T66330
	Account Manager: Sheareen
Contact: Alan Parrish	
Spec: FCC 15.401	Class: N/A

**Radiated Emissions
4.9dBi Antenna**

Test Specifics

Objective: The objective of this test session is to perform engineering evaluation testing of the EUT with respect to the specification listed above.

Date of Test: 12/4/2006	Config. Used: 1
Test Engineer: Mehran Birgani	Config Change: None
Test Location: SVOATS #2	EUT Voltage: 120V/60Hz

General Test Configuration

The EUT and all local support equipment were located on the turntable for radiated spurious emissions testing.

For radiated emissions testing the measurement antenna was located 3 meters from the EUT.

Ambient Conditions: Temperature: 10 °C
 Rel. Humidity: 53 %

Summary of Results

Run #	Test Performed	Limit	Pass / Fail	Result / Margin
1	RE, 30 - 18000 MHz Spurious Emissions	FCC Part 15.407 RSS 210	Pass	22.4dBµV/m (13.2µV/m) @ 132.871MHz (-7.6dB)

Modifications Made During Testing:

No modifications were made to the EUT during testing

Deviations From The Standard

No deviations were made from the requirements of the standard.

Client: Symbol Technologies	Job Number: J66283
Model: CB3000 Wireless Bridge Adaptor	T-Log Number: T66330
	Account Manager: Sheareen
Contact: Alan Parrish	
Spec: FCC 15.401	Class: N/A

Run #1: Radiated Spurious Emissions, 30 - 18000 MHz. Receive Mode, Center Channel @ 5600 MHz

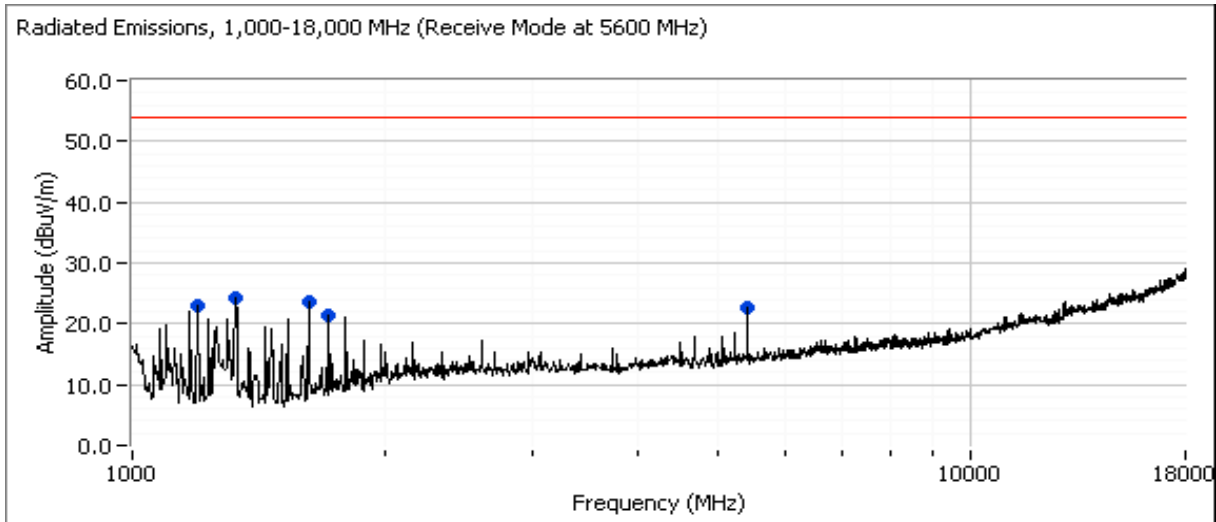
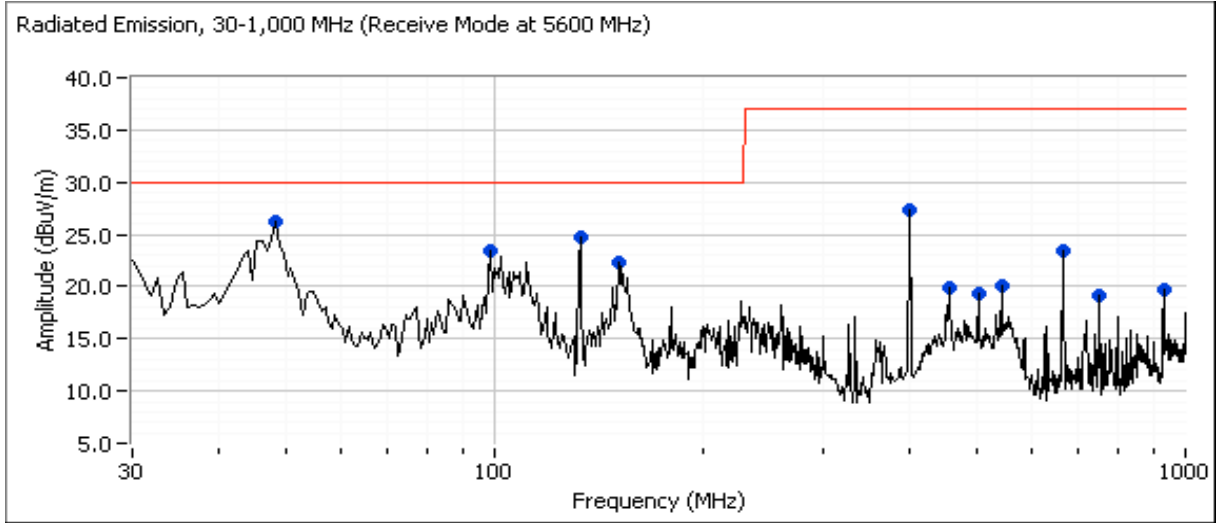



EMC Test Data

Client:	Symbol Technologies	Job Number:	J66283
Model:	CB3000 Wireless Bridge Adaptor	T-Log Number:	T66330
		Account Manager:	Sheareen
Contact:	Alan Parrish		
Spec:	FCC 15.401	Class:	N/A

Run #1: Radiated Spurious Emissions, 30 - 18000 MHz. Receive Mode, Center Channel @ 5600 MHz

Frequency MHz	Level dBµV/m	Pol V/H	15.407 / RSS 210		Detector Pk/QP/Avg	Azimuth degrees	Height meters	Comments
			Limit	Margin				
132.871	22.4	V	30.0	-7.6	Peak	110	1.1	
150.283	22.3	H	30.0	-7.7	Peak	178	1.9	
47.768	21.4	V	30.0	-8.6	Peak	18	1.0	
98.396	18.9	V	30.0	-11.1	Peak	24	1.0	
398.637	24.1	H	37.0	-12.9	Peak	0	3.0	
666.016	23.4	V	37.0	-13.6	Peak	20	1.0	
500.006	20.4	V	37.0	-16.6	Peak	360	1.0	
540.007	20.0	V	37.0	-17.0	Peak	19	1.0	
930.812	19.8	V	37.0	-17.2	Peak	0	1.0	
750.090	19.2	V	37.0	-17.8	Peak	23	1.0	
455.030	15.4	V	37.0	-21.6	Peak	300	1.0	

Note 1	All channels were scanned at chamber, showed no difference between low, center and high channel. Center channel data was used at open site for final qualification.
--------	---

Client:	Symbol Technologies	Job Number:	J66283
Model:	CB3000 Wireless Bridge Adaptor	T-Log Number:	T66330
		Account Manager:	Sheareen
Contact:	Alan Parrish		
Spec:	FCC 15.401	Class:	N/A

**Radiated Emissions
13dBi Antenna**

Test Specifics

Objective: The objective of this test session is to perform final qualification testing of the EUT with respect to the specification listed above.

Date of Test: 12/6/2006	Config. Used: 1
Test Engineer: Mehran Birgani	Config Change: None
Test Location: SVOATS #2	EUT Voltage: 120V/60Hz

General Test Configuration

The EUT and all local support equipment were located on the turntable for radiated spurious emissions testing.

For radiated emissions testing the measurement antenna was located 3 meters from the EUT.

Ambient Conditions:

Temperature:	12 °C
Rel. Humidity:	61 %

Summary of Results

Run #	Test Performed	Limit	Pass / Fail	Result / Margin
1a - c	RE, 30 - 40,000 MHz Spurious Emissions	FCC Part 15.209 / 15.247(c)	Pass	53.1dBµV/m (451.9µV/m) @ 10999.3MHz (-0.9dB)

Modifications Made During Testing:

No modifications were made to the EUT during testing

Deviations From The Standard

No deviations were made from the requirements of the standard.



EMC Test Data

Client:	Symbol Technologies	Job Number:	J66283
Model:	CB3000 Wireless Bridge Adaptor	T-Log Number:	T66330
Contact:	Alan Parrish	Account Manager:	Sheareen
Spec:	FCC 15.401	Class:	N/A

Run #1a: Radiated Spurious Emissions, 30 - 40000 MHz. Low Channel @ 5500 MHz

Frequency MHz	Level dB μ V/m	Pol V/H	15.209 / 15E		Detector Pk/QP/Avg	Azimuth degrees	Height meters	Comments
			Limit	Margin				
10999.270	53.1	H	54.0	-0.9	AVG	135	1.3	
11000.700	51.4	V	54.0	-2.6	AVG	185	1.1	
16502.300	46.5	V	54.0	-7.5	AVG	157	1.0	
16499.900	46.4	H	54.0	-7.6	AVG	127	1.4	
10999.270	65.7	H	74.0	-8.3	PK	135	1.3	
11000.700	63.2	V	74.0	-10.8	PK	185	1.1	
16502.300	59.1	V	74.0	-14.9	PK	157	1.0	
16499.900	58.2	H	74.0	-15.8	PK	127	1.4	

Note 1: For emissions in restricted bands, the limit of 15.209 was used. For all other emissions, the limit was set to -27dBm/MHz (~68dBuV/m).

Run #1b: Radiated Spurious Emissions, 30 - 40000 MHz. Center Channel @ 5600 MHz

Frequency MHz	Level dB μ V/m	Pol V/H	15.209 / 15.247		Detector Pk/QP/Avg	Azimuth degrees	Height meters	Comments
			Limit	Margin				
16797.400	49.1	V	54.0	-4.9	AVG	158	1.0	
11200.700	48.9	V	54.0	-5.1	AVG	130	1.1	
11201.400	45.9	H	54.0	-8.1	AVG	165	1.0	
16795.730	45.9	H	54.0	-8.1	AVG	145	1.0	
11200.700	60.4	V	74.0	-13.6	PK	130	1.1	
16797.400	60.2	V	74.0	-13.8	PK	158	1.0	
16795.730	58.0	H	74.0	-16.0	PK	145	1.0	
11201.400	57.3	H	74.0	-16.7	PK	165	1.0	

Note 1: For emissions in restricted bands, the limit of 15.209 was used. For all other emissions, the limit was set to -27dBm/MHz (~68dBuV/m).



EMC Test Data

Client:	Symbol Technologies	Job Number:	J66283
Model:	CB3000 Wireless Bridge Adaptor	T-Log Number:	T66330
Contact:	Alan Parrish	Account Manager:	Sheareen
Spec:	FCC 15.401	Class:	N/A

Run #1c: Radiated Spurious Emissions, 30 - 40000 MHz. High Channel @ 5700 MHz

Frequency MHz	Level dB μ V/m	Pol V/H	15.209 / 15.247		Detector Pk/QP/Avg	Azimuth degrees	Height meters	Comments
			Limit	Margin				
17098.130	52.1	V	54.0	-1.9	AVG	157	1.0	
17098.600	50.9	H	54.0	-3.1	AVG	152	1.0	
11399.770	46.8	H	54.0	-7.2	AVG	145	1.4	
11399.100	44.9	V	54.0	-9.1	AVG	177	1.0	
17098.130	64.7	V	74.0	-9.3	PK	157	1.0	
17098.600	63.0	H	74.0	-11.0	PK	152	1.0	
11399.770	59.6	H	74.0	-14.4	PK	145	1.4	
11399.100	55.9	V	74.0	-18.1	PK	177	1.0	

Note 1: For emissions in restricted bands, the limit of 15.209 was used. For all other emissions, the limit was set to -27dBm/MHz (~68dBuV/m).

Client:	Symbol Technologies	Job Number:	J66283
Model:	CB3000 Wireless Bridge Adaptor	T-Log Number:	T66330
		Account Manager:	Sheareen
Contact:	Alan Parrish		
Spec:	FCC 15.401	Class:	N/A

**Radiated Emissions
4.9dBi Antenna**

Test Specifics

Objective: The objective of this test session is to perform final qualification testing of the EUT with respect to the specification listed above.

Date of Test: 12/4/2006	Config. Used: 1
Test Engineer: Mehran Birgani	Config Change: None
Test Location: SVOATS #2	EUT Voltage: 120V/60Hz

General Test Configuration

The EUT and all local support equipment were located on the turntable for radiated spurious emissions testing.

For radiated emissions testing the measurement antenna was located 3 meters from the EUT.

Ambient Conditions: Temperature: 10 °C
 Rel. Humidity: 53 %

Summary of Results

Run #	Test Performed	Limit	Pass / Fail	Result / Margin
1a - c	RE, 30 - 40,000 MHz Spurious Emissions	FCC Part 15.209 / 15.247(c)	Pass	50.5dBµV/m (335.0µV/m) @ 17098.7MHz (-3.5dB)

Modifications Made During Testing:

No modifications were made to the EUT during testing

Deviations From The Standard

No deviations were made from the requirements of the standard.



EMC Test Data

Client:	Symbol Technologies	Job Number:	J66283
Model:	CB3000 Wireless Bridge Adaptor	T-Log Number:	T66330
Contact:	Alan Parrish	Account Manager:	Sheareen
Spec:	FCC 15.401	Class:	N/A

Run #1a: Radiated Spurious Emissions, 30 - 40000 MHz. Low Channel @ 5500 MHz

Frequency MHz	Level dB μ V/m	Pol V/H	15.209 / 15E		Detector Pk/QP/Avg	Azimuth degrees	Height meters	Comments
			Limit	Margin				
16500.470	45.7	V	54.0	-8.3	AVG	154	1.0	
16498.870	45.5	H	54.0	-8.5	AVG	188	1.0	
10995.860	45.2	H	54.0	-8.8	AVG	303	1.0	
10989.810	43.5	V	54.0	-10.5	AVG	291	1.0	
16498.870	57.4	H	74.0	-16.6	PK	188	1.0	
16500.470	57.0	V	74.0	-17.0	PK	154	1.0	
10995.860	51.1	H	74.0	-22.9	PK	303	1.0	
10989.810	50.5	V	74.0	-23.5	PK	291	1.0	

Note 1: For emissions in restricted bands, the limit of 15.209 was used. For all other emissions, the limit was set to -27dBm/MHz (~68dBuV/m).

Run #1b: Radiated Spurious Emissions, 30 - 40000 MHz. Center Channel @ 5600 MHz

Frequency MHz	Level dB μ V/m	Pol V/H	15.209 / 15.247		Detector Pk/QP/Avg	Azimuth degrees	Height meters	Comments
			Limit	Margin				
16800.400	50.4	V	54.0	-3.6	AVG	152	1.0	
16798.870	49.1	H	54.0	-4.9	AVG	139	1.0	
11202.400	46.0	V	54.0	-8.0	AVG	353	1.0	
11200.380	44.9	H	54.0	-9.1	AVG	217	1.0	
16800.400	62.5	V	74.0	-11.5	PK	152	1.0	
16798.870	61.6	H	74.0	-12.4	PK	139	1.0	
11202.400	57.8	V	74.0	-16.2	PK	353	1.0	
11200.380	56.1	H	74.0	-17.9	PK	217	1.0	

Note 1: For emissions in restricted bands, the limit of 15.209 was used. For all other emissions, the limit was set to -27dBm/MHz (~68dBuV/m).



EMC Test Data

Client:	Symbol Technologies	Job Number:	J66283
Model:	CB3000 Wireless Bridge Adaptor	T-Log Number:	T66330
Contact:	Alan Parrish	Account Manager:	Sheareen
Spec:	FCC 15.401	Class:	N/A

Run #1c: Radiated Spurious Emissions, 30 - 40000 MHz. High Channel @ 5700 MHz

Frequency	Level	Pol	15.209 / 15.247		Detector	Azimuth	Height	Comments
MHz	dB μ V/m	V/H	Limit	Margin	Pk/QP/Avg	degrees	meters	
17098.730	50.5	V	54.0	-3.5	AVG	199	1.0	
17102.870	49.7	H	54.0	-4.3	AVG	139	1.0	
11402.430	46.6	V	54.0	-7.4	AVG	203	1.0	
11400.130	45.7	H	54.0	-8.3	AVG	215	1.0	
17098.730	63.1	V	74.0	-10.9	PK	199	1.0	
17102.870	61.7	H	74.0	-12.3	PK	139	1.0	
11400.130	59.3	H	74.0	-14.7	PK	215	1.0	
11402.430	57.4	V	74.0	-16.6	PK	203	1.0	

Note 1: For emissions in restricted bands, the limit of 15.209 was used. For all other emissions, the limit was set to -27dBm/MHz (-68dBuV/m).



EMC Test Data

Client:	Symbol Technologies	Job Number:	J66283
Model:	CB3000 Wireless Bridge Adaptor	T-Log Number:	T66330
		Account Manager:	Sheareen
Contact:	Alan Parrish		
Standard:	FCC 15.401	Class:	N/A

FCC Part 15 Subpart E Tests

Test Specific Details

Objective: The objective of this test session is to perform final qualification testing of the EUT with respect to the specification listed above.

Date of Test: 12/6/2006	Config. Used: 1
Test Engineer: Mehran B	Config Change: None
Test Location: SVOATS #1	EUT Voltage: 120V/60Hz

General Test Configuration

When measuring the conducted emissions from the EUT's antenna port, the antenna port of the EUT was connected to the spectrum analyzer or power meter via a suitable attenuator to prevent overloading the measurement system. All measurements are corrected to allow for the external attenuators and cables used.

Ambient Conditions: Temperature: 13 °C
 Rel. Humidity: 34 %

Summary of Results

Run #	Test Performed	Limit	Pass / Fail	Result / Margin
1	Power, 5470 - 5725MHz	15.407(a)(2)	Pass	19.7 dBm
1	PSD, 5470 - 5725MHz	15.407(a)(2)	Pass	7.14
1	26dB Bandwidth	15.407	Pass	> 20 MHz
1	99% Bandwidth	RSS 210	Pass	17.8 MHz
2	Peak Excursion Envelope	15.407(a) (6)	Pass	11.53 dB

Modifications Made During Testing:

No modifications were made to the EUT during testing

Deviations From The Standard

No deviations were made from the requirements of the standard.

Client:	Symbol Technologies	Job Number:	J66283
Model:	CB3000 Wireless Bridge Adaptor	T-Log Number:	T66330
		Account Manager:	Sheareen
Contact:	Alan Parrish		
Standard:	FCC 15.401	Class:	N/A

Run #1: Bandwidth, Output Power and Power spectral Density

Antenna Gain: 4.9 dBi

Frequency (MHz)	Software Setting	Bandwidth		Output Power ¹ dBm		Power (Watts)	PSD ² dBm/MHz			Result
		26dB	99% ⁴	Measured	Limit		Measured	FCC Limit	RSS Limit ³	
5500	22.0	34.4	17.1	18.7	24.0	0.074	6.05	11.0	9.4	Pass
5600	22.0	34.5	17.5	19.7	24.0	0.094	7.14	11.0	10.3	Pass
5700	22.0	38.5	17.8	19.7	24.0	0.094	7.12	11.0	10.2	Pass

Note 1:	Output power measured using a spectrum analyzer (see plots below): RBW=1MHz, VB=3 MHz, sample detector, power averaging on (transmitted signal was continuous) and power integration over 100 MHz
Note 2:	Measured using the same analyzer settings used for output power.
Note 3:	For RSS210 the measured value of the PSD (see note 3) must not exceed the average value (calculated from the measured power divided by the measured 99% bandwidth) by more than 3dB.
Note 4:	99% Bandwidth measured in accordance with RSS GEN - RB > 1% of span and VB >=3xRB

Client: Symbol Technologies	Job Number: J66283
Model: CB3000 Wireless Bridge Adaptor	T-Log Number: T66330
Contact: Alan Parrish	Account Manager: Sheareen
Standard: FCC 15.401	Class: N/A

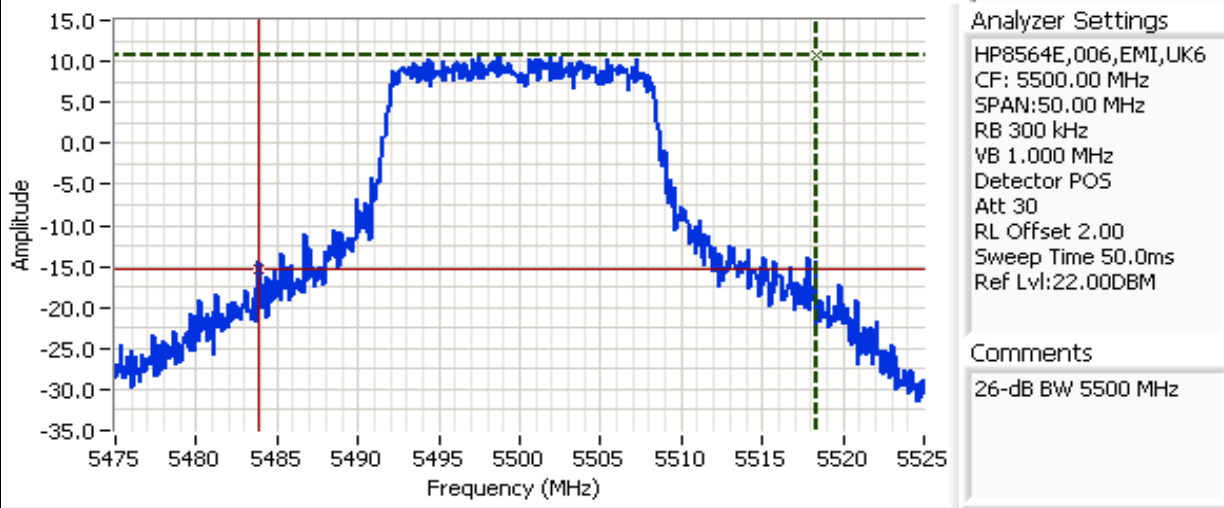
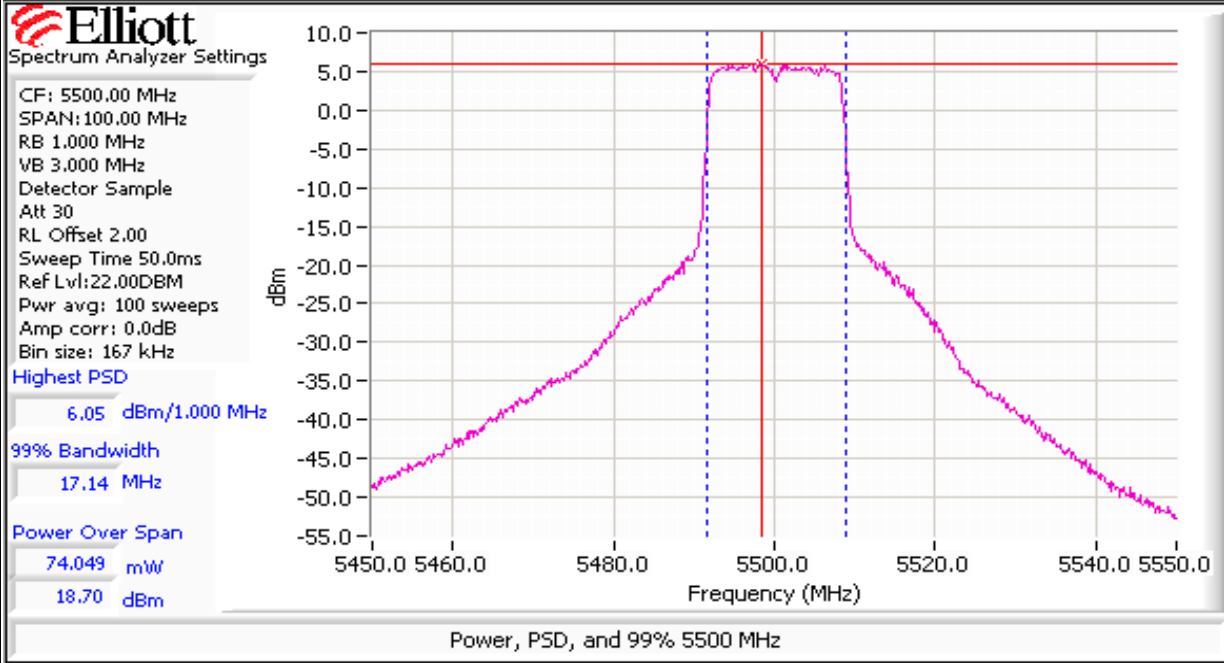

Cursor 1	5518.33	10.67	
Cursor 2	5483.91	-15.33	

Delta Freq. 34.42
Delta Amplitude 26.00



Client: Symbol Technologies	Job Number: J66283
Model: CB3000 Wireless Bridge Adaptor	T-Log Number: T66330
Contact: Alan Parrish	Account Manager: Sheareen
Standard: FCC 15.401	Class: N/A

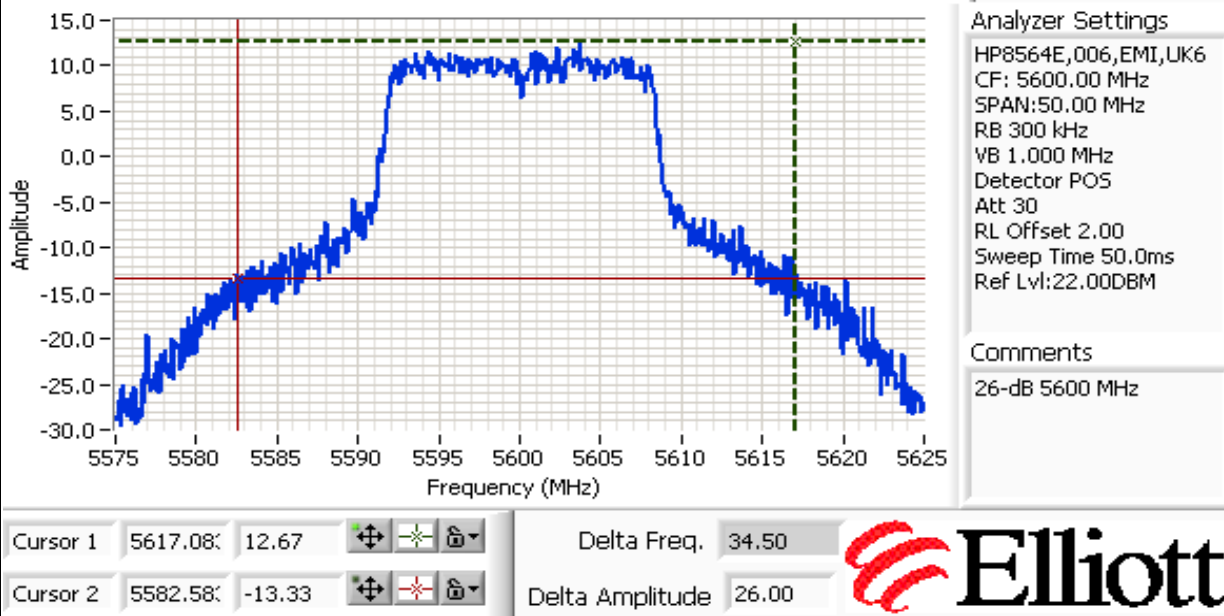
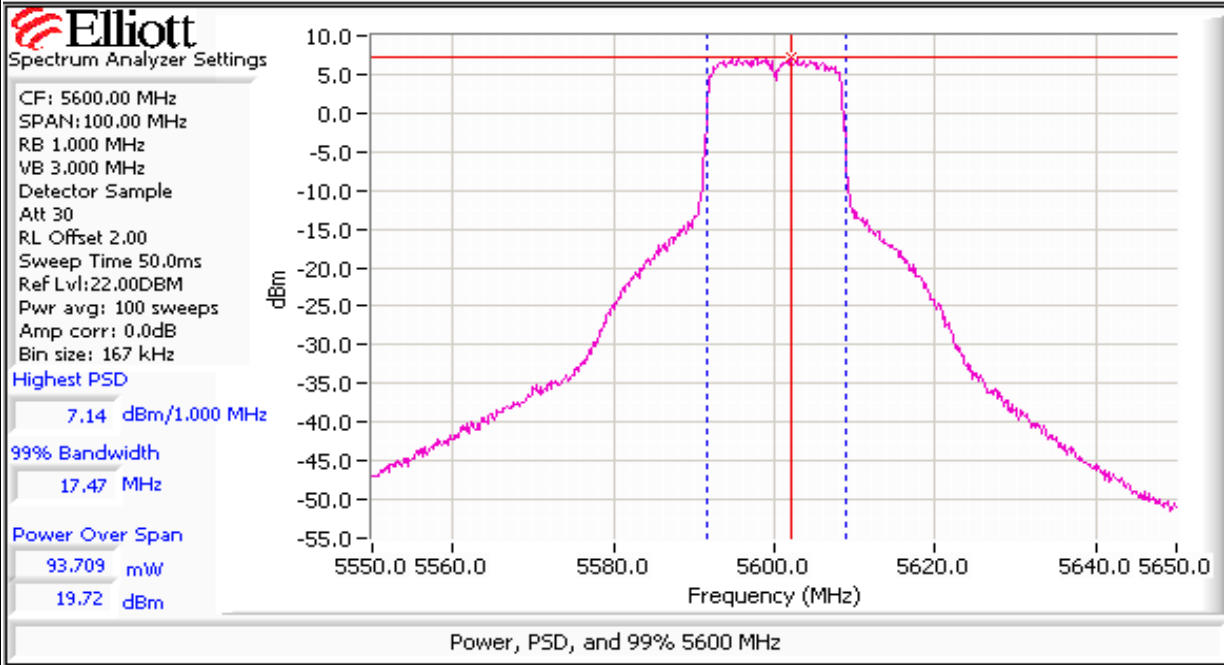

Client: Symbol Technologies	Job Number: J66283
Model: CB3000 Wireless Bridge Adaptor	T-Log Number: T66330
Contact: Alan Parrish	Account Manager: Sheareen
Standard: FCC 15.401	Class: N/A

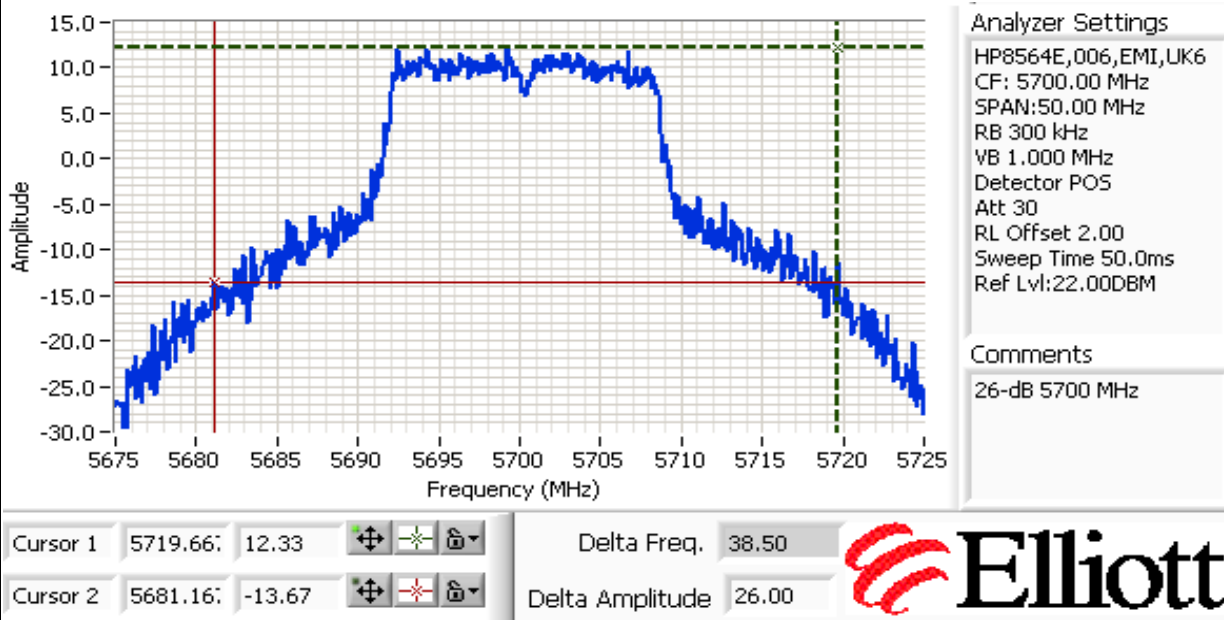
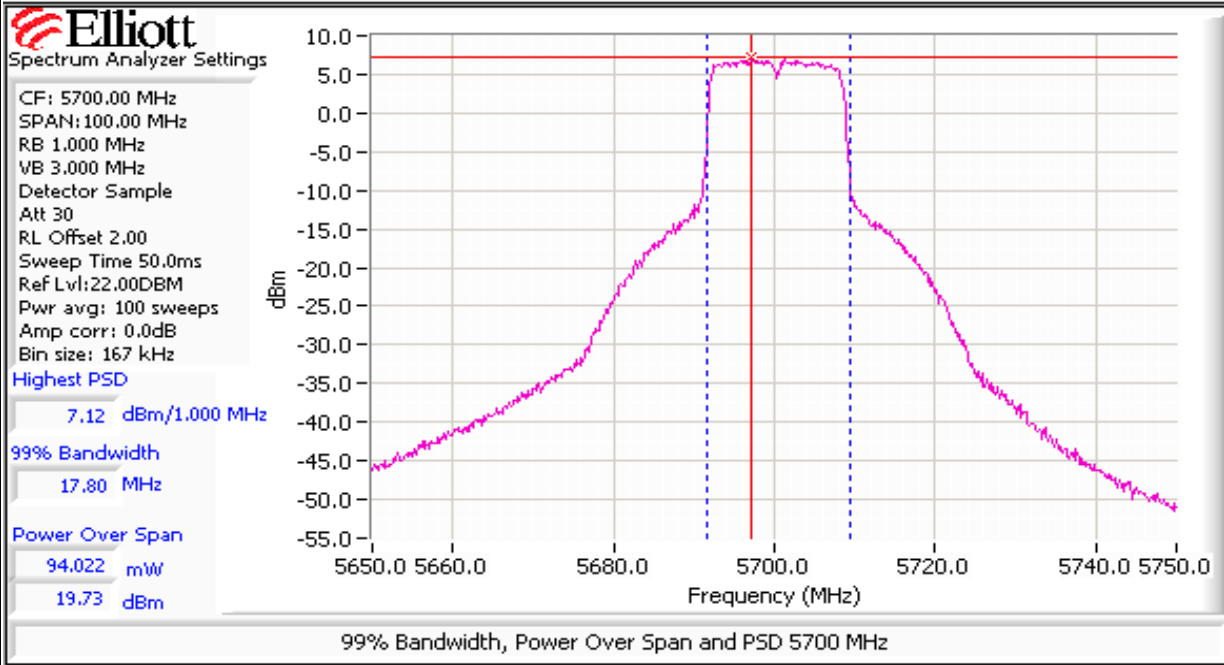

Client: Symbol Technologies	Job Number: J66283
Model: CB3000 Wireless Bridge Adaptor	T-Log Number: T66330
	Account Manager: Sheareen
Contact: Alan Parrish	
Standard: FCC 15.401	Class: N/A

Antenna Gain: **13** dBi

Frequency (MHz)	Software Setting	Bandwidth		Output Power ¹ dBm		Power (Watts)	PSD ² dBm/MHz			Result
		26dB	99% ⁴	Measured	Limit		Measured	FCC Limit	RSS Limit ³	
5500	17.0	-	17.2	14.3	17.0	0.027	3.41	4.0	4.9	Pass
5600	17.0	-	17.5	14.3	17.0	0.027	3.65	4.0	4.9	Pass
5700	17.0	-	17.2	14.4	17.0	0.028	3.77	4.0	5.1	Pass

- Note 1: Output power measured using a spectrum analyzer (see plots below):
 RBW=1MHz, VB=3 MHz, sample detector, power averaging on (transmitted signal was continuous) and power integration over 100 MHz
- Note 2: Measured using the same analyzer settings used for output power.
- Note 3: For RSS210 the measured value of the PSD (see note 3) must not exceed the average value (calculated from the measured power divided by the measured 99% bandwidth) by more than 3dB.
- Note 4: 99% Bandwidth measured in accordance with RSS GEN - RB > 1% of span and VB >=3xRB

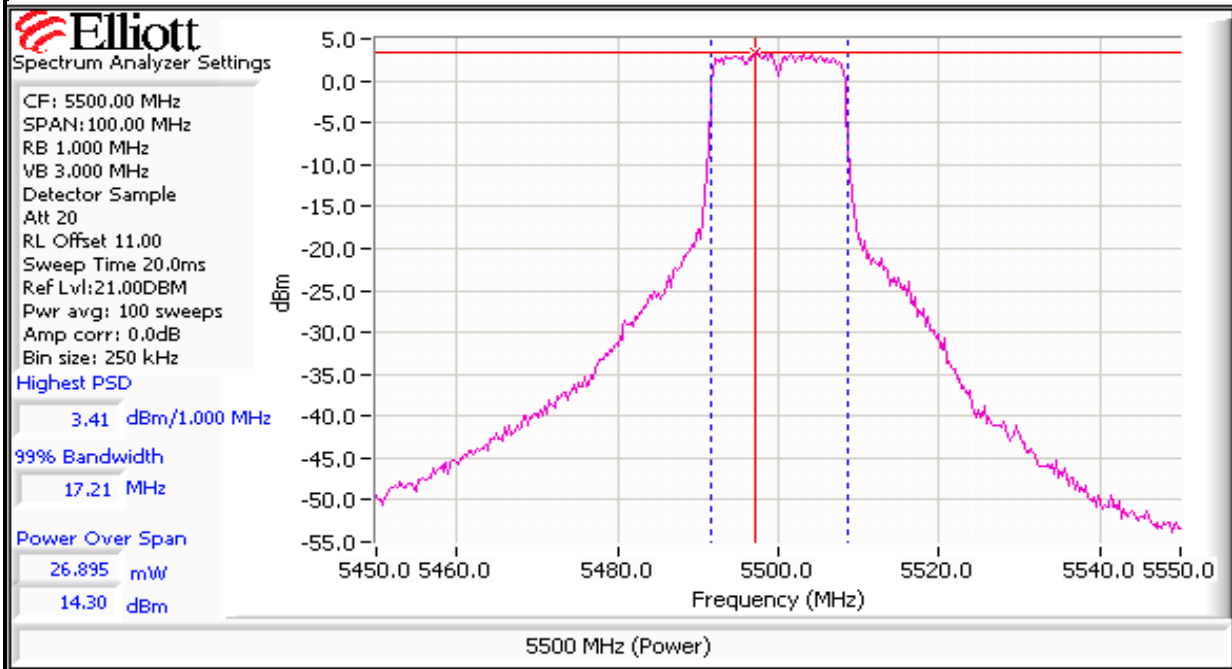

Client: Symbol Technologies	Job Number: J66283
Model: CB3000 Wireless Bridge Adaptor	T-Log Number: T66330
Contact: Alan Parrish	Account Manager: Sheareen
Standard: FCC 15.401	Class: N/A

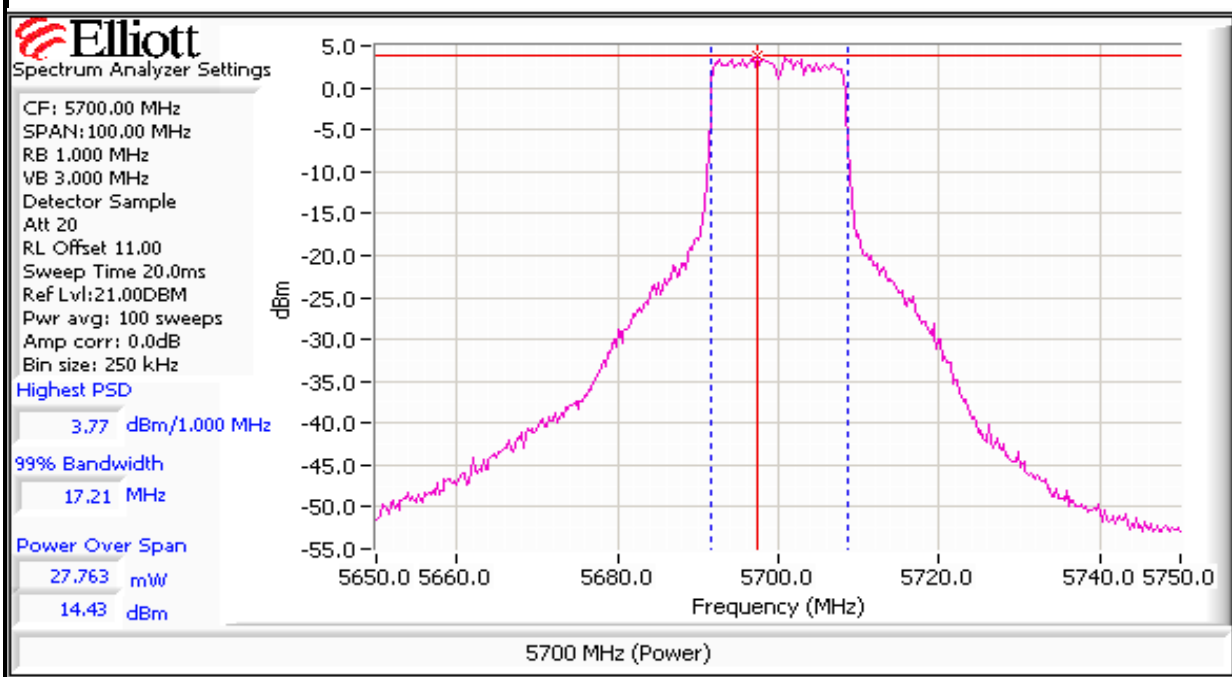
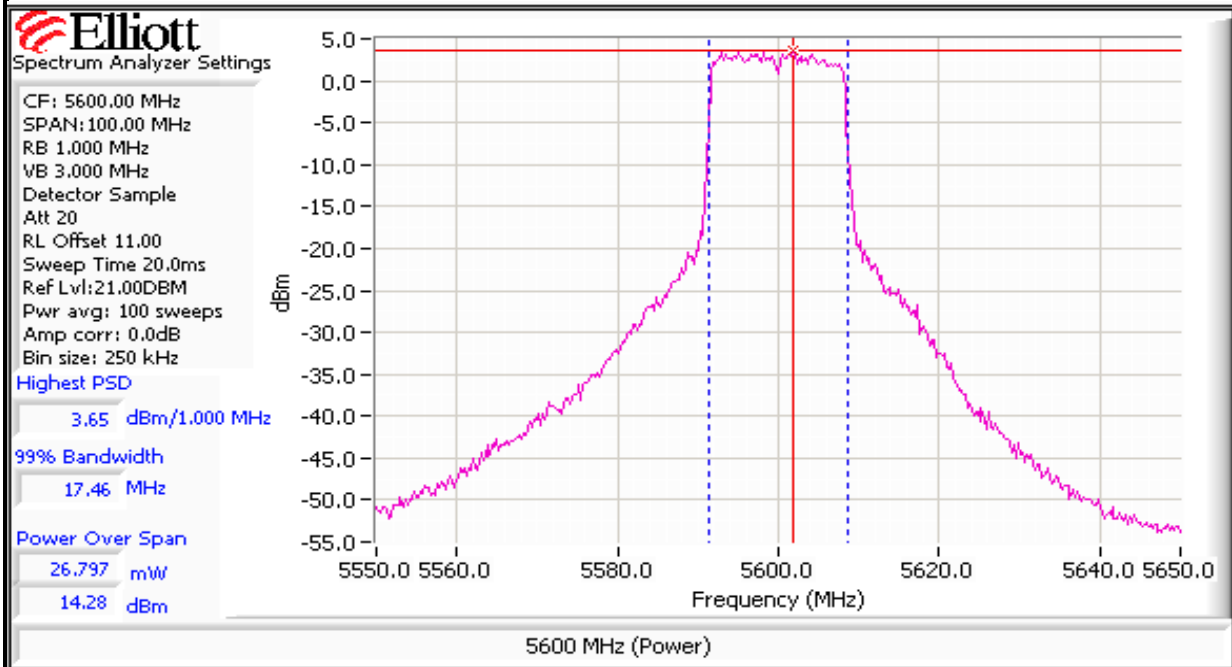

Client: Symbol Technologies	Job Number: J66283
Model: CB3000 Wireless Bridge Adaptor	T-Log Number: T66330
	Account Manager: Sheareen
Contact: Alan Parrish	
Standard: FCC 15.401	Class: N/A

Run #2: Peak Excursion Measurement

Plots Showing Peak Excursion
 Trace A: RBW = 1MHz VBW = 3MHz
 Trace B: Method #1

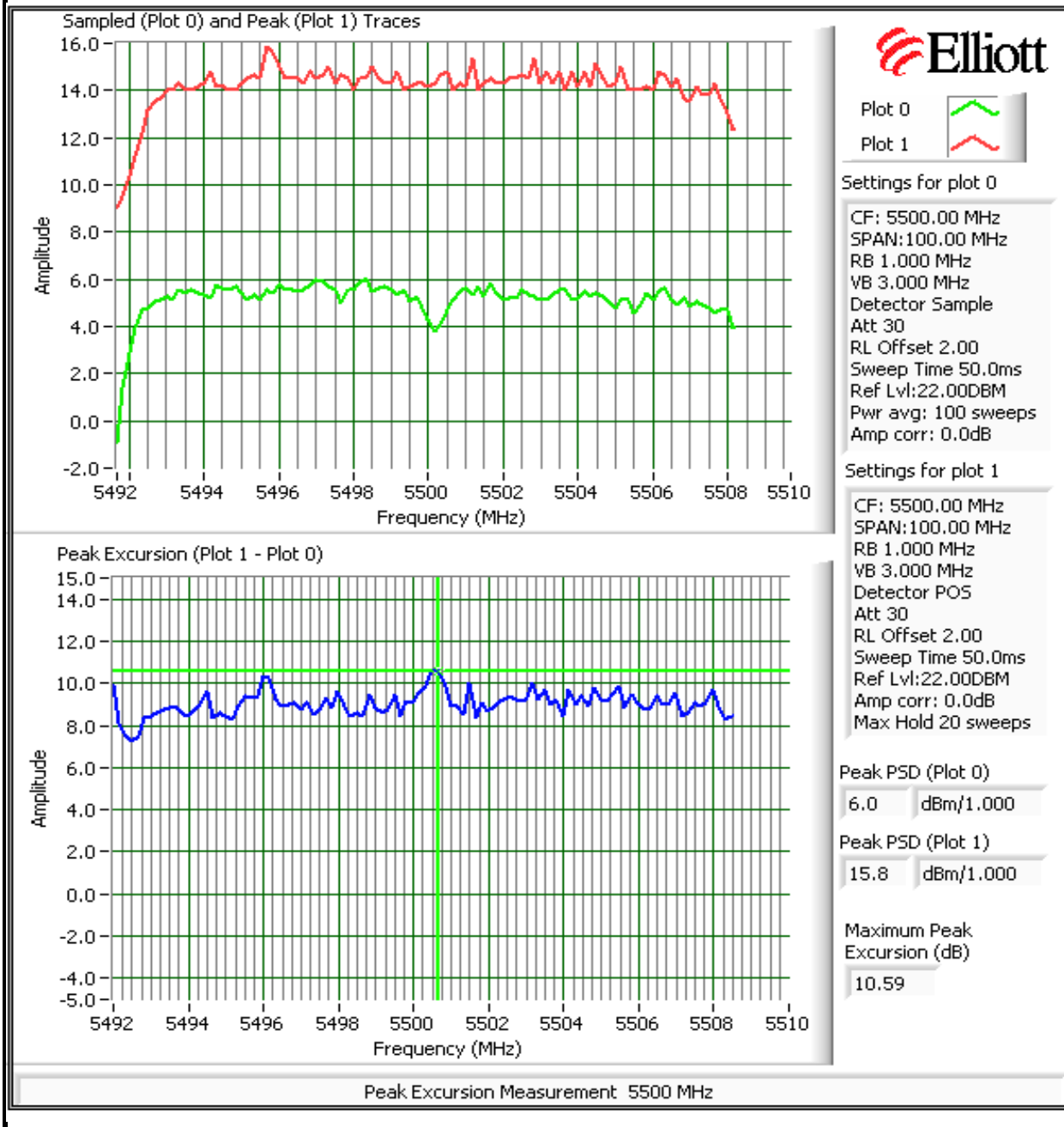

Client: Symbol Technologies	Job Number: J66283
Model: CB3000 Wireless Bridge Adaptor	T-Log Number: T66330
	Account Manager: Sheareen
Contact: Alan Parrish	
Standard: FCC 15.401	Class: N/A

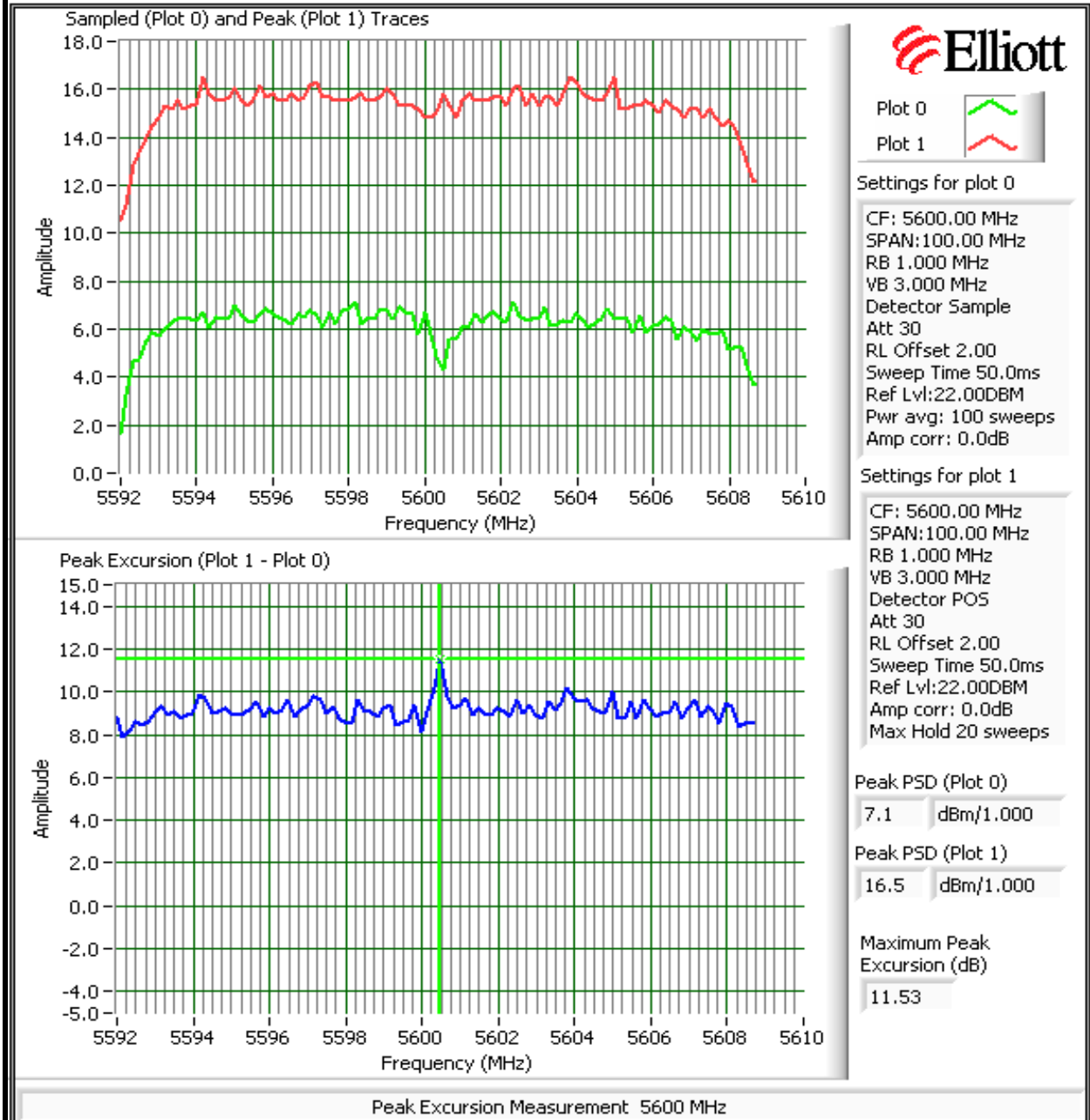

Client: Symbol Technologies	Job Number: J66283
Model: CB3000 Wireless Bridge Adaptor	T-Log Number: T66330
Contact: Alan Parrish	Account Manager: Sheareen
Standard: FCC 15.401	Class: N/A

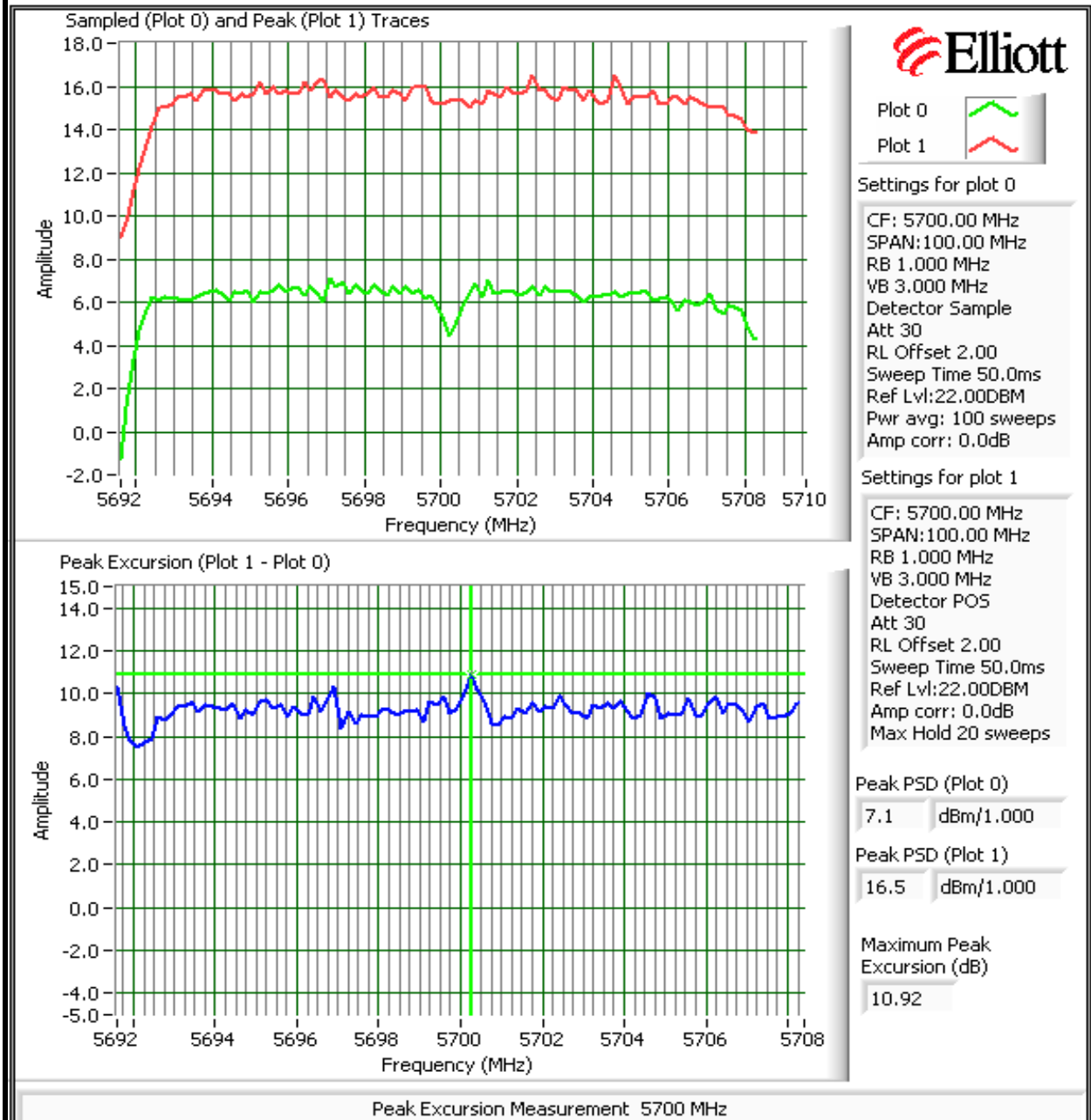

EXHIBIT 3: Photographs of Test Configurations

4 Pages

EXHIBIT 4: Proposed FCC ID Label & Label Location

Note: This item was not provided, as this is a class II change application, so the label remained unchanged.

***EXHIBIT 5: Detailed Photographs
of Symbol Technologies, Inc. Model CB3000 Wireless Bridge Adaptor
Construction***

Unchanged

**EXHIBIT 6: Operator's Manual
for Symbol Technologies, Inc. Model CB3000 Wireless Bridge Adaptor**

Unchanged

**EXHIBIT 7: Block Diagram
of Symbol Technologies, Inc. Model CB3000 Wireless Bridge Adaptor**

Unchanged

***EXHIBIT 8: Schematic Diagrams
for Symbol Technologies, Inc. Model CB3000 Wireless Bridge Adaptor***

Unchanged

***EXHIBIT 9: Theory of Operation
for Symbol Technologies, Inc. Model CB3000 Wireless Bridge Adaptor***

Unchanged

EXHIBIT 10: Advertising Literature

Unchanged

EXHIBIT 11: RF Exposure Information

Unchanged