



**DFS PORTION of FCC 47 CFR PART 15 SUBPART E
DFS PORTION of INDUSTRY CANADA RSS-210 ISSUE 8**

CERTIFICATION TEST REPORT

FOR

802.11a/b/g/n/ac 3x3 ACCESS POINT

MODEL NUMBER: AP-7562

FCC ID: H9PAP7562

IC: 1549D-AP7562

REPORT NUMBER: 15U19776-4

ISSUE DATE: FEBRUARY 23, 2015

Prepared for
**ZEBRA TECHNOLOGIES CORP.
6480 VIA DEL ORO DR.
SAN JOSE
CA., 95119, U.S.A.**

Prepared by
**UL VERIFICATION SERVICES INC.
47173 BENICIA STREET
FREMONT, CA 94538, U.S.A.
TEL: (510) 771-1000
FAX: (510) 661-0888**



NVLAP LAB CODE 200065-0

Revision History

<u>Rev.</u>	<u>Issue Date</u>	<u>Revisions</u>	<u>Revised By</u>
--	02/23/15	Initial Issue	C. Cheung

TABLE OF CONTENTS

1. ATTESTATION OF TEST RESULTS	4
2. TEST METHODOLOGY	5
3. FACILITIES AND ACCREDITATION	5
4. CALIBRATION AND UNCERTAINTY	5
4.1. <i>MEASURING INSTRUMENT CALIBRATION</i>	<i>5</i>
4.2. <i>SAMPLE CALCULATION</i>	<i>5</i>
4.3. <i>MEASUREMENT UNCERTAINTY</i>	<i>5</i>
5. DYNAMIC FREQUENCY SELECTION.....	6
5.1. <i>OVERVIEW</i>	<i>6</i>
5.1.1. <i>LIMITS.....</i>	<i>6</i>
5.1.2. <i>TEST AND MEASUREMENT SYSTEM.....</i>	<i>10</i>
5.1.3. <i>SETUP OF EUT.....</i>	<i>13</i>
5.1.4. <i>DESCRIPTION OF EUT</i>	<i>14</i>
5.2. <i>RESULTS FOR 20 MHz BANDWIDTH.....</i>	<i>16</i>
5.2.1. <i>TEST CHANNEL</i>	<i>16</i>
5.2.2. <i>RADAR WAVEFORMS AND TRAFFIC.....</i>	<i>16</i>
5.2.3. <i>CHANNEL AVAILABILITY CHECK TIME.....</i>	<i>24</i>
5.2.4. <i>OVERLAPPING CHANNEL TESTS.....</i>	<i>33</i>
5.2.5. <i>MOVE AND CLOSING TIME</i>	<i>33</i>
5.2.6. <i>DETECTION BANDWIDTH.....</i>	<i>38</i>
5.2.7. <i>IN-SERVICE MONITORING</i>	<i>40</i>
5.3. <i>RESULTS FOR 40 MHz BANDWIDTH.....</i>	<i>47</i>
5.3.1. <i>TEST CHANNEL</i>	<i>47</i>
5.3.2. <i>RADAR WAVEFORMS AND TRAFFIC.....</i>	<i>47</i>
5.3.3. <i>CHANNEL AVAILABILITY CHECK TIME.....</i>	<i>55</i>
5.3.1. <i>OVERLAPPING CHANNEL TESTS.....</i>	<i>64</i>
5.3.2. <i>MOVE AND CLOSING TIME</i>	<i>64</i>
5.3.3. <i>DETECTION BANDWIDTH.....</i>	<i>69</i>
5.3.4. <i>IN-SERVICE MONITORING</i>	<i>71</i>
5.4. <i>RESULTS FOR 80 MHz BANDWIDTH.....</i>	<i>79</i>
5.4.1. <i>TEST CHANNEL</i>	<i>79</i>
5.4.2. <i>RADAR WAVEFORMS AND TRAFFIC.....</i>	<i>79</i>
5.4.3. <i>CHANNEL AVAILABILITY CHECK TIME.....</i>	<i>87</i>
5.4.4. <i>OVERLAPPING CHANNEL TESTS.....</i>	<i>96</i>
5.4.5. <i>MOVE AND CLOSING TIME</i>	<i>96</i>
5.4.6. <i>NON-OCCUPANCY PERIOD</i>	<i>101</i>
5.4.7. <i>DETECTION BANDWIDTH.....</i>	<i>102</i>
5.4.8. <i>IN-SERVICE MONITORING</i>	<i>104</i>
6. BRIDGE MODE RESULTS.....	113
7. SETUP PHOTOS.....	114

1. ATTESTATION OF TEST RESULTS

COMPANY NAME: ZEBRA TECHNOLOGIES CORP.
6480 VIA DEL ORO DR.
SAN JOSE, CA., 95119, U.S.A.

EUT DESCRIPTION: 802.11a/b/g/n/ac 3x3 MIMO ACCESS POINT

MODEL: AP-7562

SERIAL NUMBER: 14300522400383

DATE TESTED: FEBRUARY 09 and 10, 2015

APPLICABLE STANDARDS	
STANDARD	TEST RESULTS
DFS Portion of CFR 47 Part 15 Subpart E	Pass
INDUSTRY CANADA RSS-GEN Issue 8	Pass

UL Verification Services Inc. tested the above equipment in accordance with the requirements set forth in the above standards. All indications of Pass/Fail in this report are opinions expressed by UL Verification Services Inc. based on interpretations and/or observations of test results. Measurement Uncertainties were not taken into account and are published for informational purposes only. The test results show that the equipment tested is capable of demonstrating compliance with the requirements as documented in this report.

Note: The results documented in this report apply only to the tested sample, under the conditions and modes of operation as described herein. This document may not be altered or revised in any way unless done so by UL Verification Services Inc. and all revisions are duly noted in the revisions section. Any alteration of this document not carried out by UL Verification Services Inc. will constitute fraud and shall nullify the document. This report must not be used by the client to claim product certification, approval, or endorsement by NVLAP, NIST, any agency of the Federal Government, or any agency of any government.

Approved & Released For
UL Verification Services Inc. By:



CONAN CHEUNG
PROJECT LEAD
UL Verification Services Inc.

Tested By:



DOUG ANDERSON
EMC ENGINEER
UL Verification Services Inc.

2. TEST METHODOLOGY

The tests documented in this report were performed in accordance with the DFS portion of FCC CFR 47 Part 2, FCC CFR 47 Part 15, FCC 06-96, FCC KDB 789033, KDB 905462 D02 and D03, ANSI C63.10-2009, RSS-GEN Issue 8.

3. FACILITIES AND ACCREDITATION

The test sites and measurement facilities used to collect data are located at 47173 Benicia Street, Fremont, California, USA.

UL Verification Services, Inc. is accredited by NVLAP, Laboratory Code 200065-0. The full scope of accreditation can be viewed at <http://ts.nist.gov/standards/scopes/2000650.htm>.

4. CALIBRATION AND UNCERTAINTY

4.1. MEASURING INSTRUMENT CALIBRATION

The measuring equipment utilized to perform the tests documented in this report has been calibrated in accordance with the manufacturer's recommendations, and is traceable to recognized national standards.

4.2. SAMPLE CALCULATION

Where relevant, the following sample calculation is provided:

$$\begin{aligned} \text{Field Strength (dBuV/m)} &= \text{Measured Voltage (dBuV)} + \text{Antenna Factor (dB/m)} + \\ &\text{Cable Loss (dB)} - \text{Preamp Gain (dB)} \\ 36.5 \text{ dBuV} + 18.7 \text{ dB/m} + 0.6 \text{ dB} - 26.9 \text{ dB} &= 28.9 \text{ dBuV/m} \end{aligned}$$

4.3. MEASUREMENT UNCERTAINTY

Where relevant, the following measurement uncertainty levels have been estimated for tests performed on the apparatus:

PARAMETER	UNCERTAINTY
Conducted Disturbance, 0.15 to 30 MHz	± 3.52 dB
Radiated Disturbance, 30 to 1000 MHz	± 4.94 dB
Radiated Disturbance, 1 to 6 GHz	± 3.86 dB
Radiated Disturbance, 6 to 18 GHz	± 4.23 dB
Radiated Disturbance, 18 to 26 GHz	± 5.30 dB
Radiated Disturbance, 26 to 40 GHz	± 5.23 dB

Uncertainty figures are valid to a confidence level of 95%.

5. DYNAMIC FREQUENCY SELECTION

5.1. OVERVIEW

5.1.1. LIMITS

INDUSTRY CANADA

IC RSS-210 is closely harmonized with FCC Part 15 DFS rules. The deviations are as follows:

RSS-210 Issue 8 A9.3

Note: For the band 5600–5650 MHz, no operation is permitted.

Until further notice, devices subject to this annex shall not be capable of transmitting in the band 5600–5650 MHz. This restriction is for the protection of Environment Canada weather radars operating in this band.

FCC

§15.407 (h), FCC KDB 905462 D02 “COMPLIANCE MEASUREMENT PROCEDURES FOR UNLICENSED-NATIONAL INFORMATION INFRASTRUCTURE DEVICES OPERATING IN THE 5250-5350 MHz AND 5470-5725 MHz BANDS INCORPORATING DYNAMIC FREQUENCY SELECTION” and KDB 905462 D03 “U-NII CLIENT DEVICES WITHOUT RADAR DETECTION CAPABILITY”.

Table 1: Applicability of DFS requirements prior to use of a channel

Requirement	Operational Mode		
	Master	Client (without radar detection)	Client (with radar detection)
Non-Occupancy Period	Yes	Not required	Yes
DFS Detection Threshold	Yes	Not required	Yes
Channel Availability Check Time	Yes	Not required	Not required
U-NII Detection Bandwidth	Yes	Not required	Yes

Table 2: Applicability of DFS requirements during normal operation

Requirement	Operational Mode		
	Master	Client (without DFS)	Client (with DFS)
DFS Detection Threshold	Yes	Not required	Yes
Channel Closing Transmission Time	Yes	Yes	Yes
Channel Move Time	Yes	Yes	Yes
U-NII Detection Bandwidth	Yes	Not required	Yes

Additional requirements for devices with multiple bandwidth modes	Master Device or Client with Radar DFS	Client (without DFS)
<i>U-NII Detection Bandwidth and Statistical Performance Check</i>	All BW modes must be tested	Not required
<i>Channel Move Time and Channel Closing Transmission Time</i>	Test using widest BW mode available	Test using the widest BW mode available for the link
<i>All other tests</i>	Any single BW mode	Not required
Note: Frequencies selected for statistical performance check (Section 7.8.4) should include several frequencies within the radar detection bandwidth and frequencies near the edge of the radar detection bandwidth. For 802.11 devices it is suggested to select frequencies in all 20 MHz channel blocks and a null frequency between the bonded 20 MHz channel blocks.		

Table 3: Interference Threshold values, Master or Client incorporating In-Service Monitoring

Maximum Transmit Power	Value (see notes)
E.I.R.P. \geq 200 mill watt	-64 dBm
E.I.R.P. < 200 mill watt and power spectral density < 10 dBm/MHz	-62 dBm
E.I.R.P. < 200 mill watt that do not meet power spectral density requirement	-64 dBm
<p>Note 1: This is the level at the input of the receiver assuming a 0 dBi receive antenna Note 2: Throughout these test procedures an additional 1 dB has been added to the amplitude of the test transmission waveforms to account for variations in measurement equipment. This will ensure that the test signal is at or above the detection threshold level to trigger a DFS response. Note 3: E.I.R.P. is based on the highest antenna gain. For MIMO devices refer to KDB publication 662911 D01.</p>	

Table 4: DFS Response requirement values

Parameter	Value
<i>Non-occupancy period</i>	30 minutes
<i>Channel Availability Check Time</i>	60 seconds
<i>Channel Move Time</i>	10 seconds (See Note 1)
<i>Channel Closing Transmission Time</i>	200 milliseconds + approx. 60 milliseconds over remaining 10 second period. (See Notes 1 and 2)
<i>U-NII Detection Bandwidth</i>	Minimum 100% of the U-NII 99% transmission power bandwidth. (See Note 3)
<p>Note 1: <i>Channel Move Time</i> and the <i>Channel Closing Transmission Time</i> should be performed with Radar Type 0. The measurement timing begins at the end of the Radar Type 0 burst. Note 2: The <i>Channel Closing Transmission Time</i> is comprised of 200 milliseconds starting at the beginning of the <i>Channel Move Time</i> plus any additional intermittent control signals required to facilitate a <i>Channel</i> move (an aggregate of 60 milliseconds) during the remainder of the 10 second period. The aggregate duration of control signals will not count quiet periods in between transmissions. Note 3: During the <i>U-NII Detection Bandwidth</i> detection test, radar type 0 should be used. For each frequency step the minimum percentage of detection is 90 percent. Measurements are performed with no data traffic.</p>	

Table 5 – Short Pulse Radar Test Waveforms

Radar Type	Pulse Width (usec)	PRI (usec)	Pulses	Minimum Percentage of Successful Detection	Minimum Trials
0	1	1428	18	See Note 1	See Note 1
1	1	Test A: 15 unique PRI values randomly selected from the list of 23 PRI values in table 5a	Roundup: $\{(1/360) \times (19 \times 10^6 \text{ PRI}_{\text{usec}})\}$	60%	30
		Test B: 15 unique PRI values randomly selected within the range of 518-3066 usec. With a minimum increment of 1 usec, excluding PRI values selected in Test A			
2	1-5	150-230	23-29	60%	30
3	6-10	200-500	16-18	60%	30
4	11-20	200-500	12-16	60%	30
Aggregate (Radar Types 1-4)				80%	120
Note 1: Short Pulse Radar Type 0 should be used for the <i>Detection Bandwidth</i> test, <i>Channel Move Time</i> , and <i>Channel Closing Time</i> tests.					

Table 6 – Long Pulse Radar Test Signal

Radar Waveform Type	Pulse Width (µsec)	Chirp Width (MHz)	PRI (µsec)	Pulses per Burst	Number of Bursts	Minimum Percentage of Successful Detection	Minimum Trials
5	50-100	5-20	1000-2000	1-3	8-20	80%	30

Table 7 – Frequency Hopping Radar Test Signal

Radar Waveform Type	Pulse Width (µsec)	PRI (µsec)	Pulses per Hop	Hopping Rate (kHz)	Hopping Sequence Length (msec)	Minimum Percentage of Successful Detection	Minimum Trials
6	1	333	9	0.333	300	70%	30

5.1.2. TEST AND MEASUREMENT SYSTEM

RADIATED METHOD SYSTEM BLOCK DIAGRAM

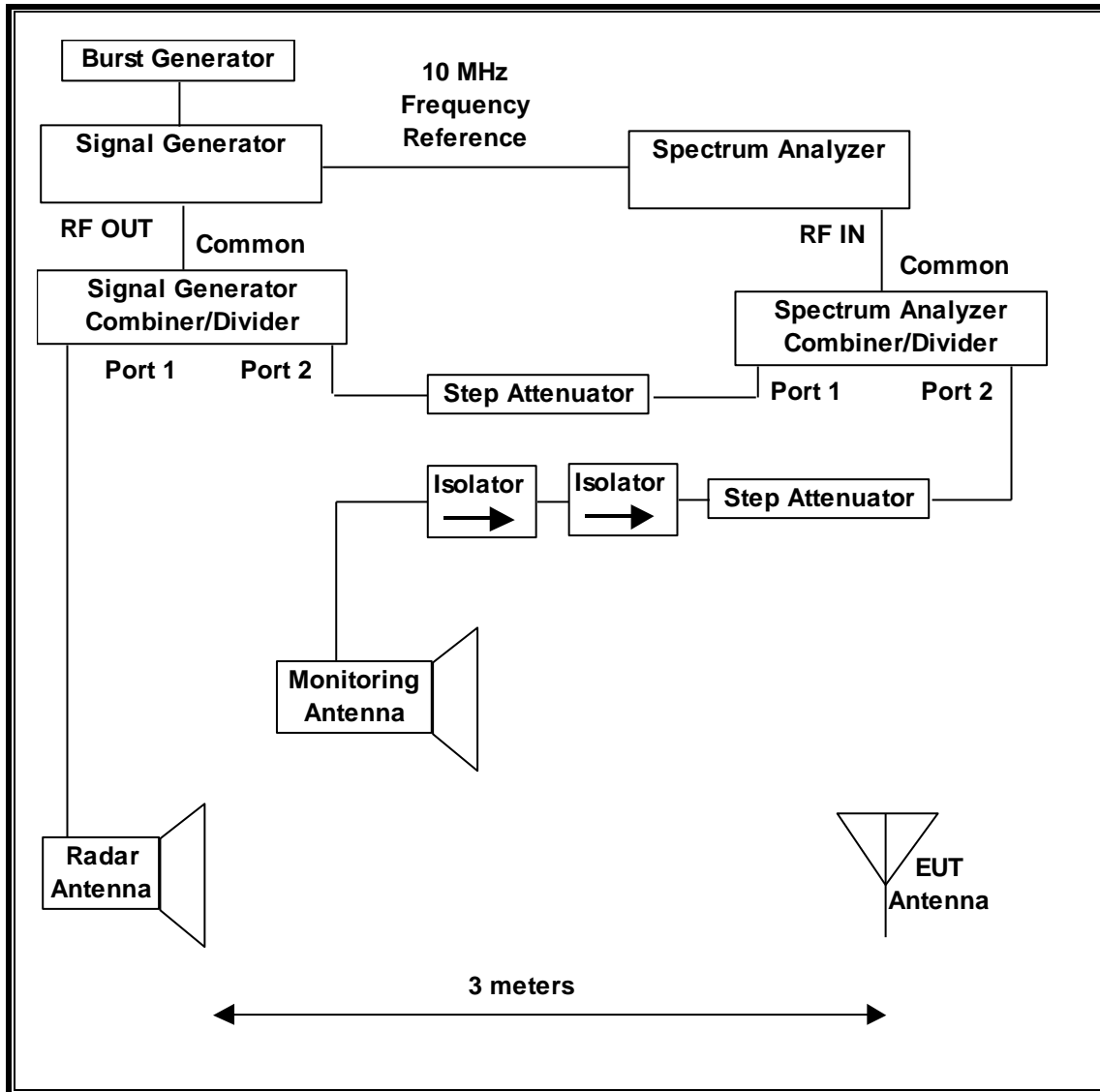

SYSTEM OVERVIEW

The short pulse and long pulse signal generating system utilizes the NTIA software. The Vector Signal Generator has been validated by the NTIA. The hopping signal generating system utilizes the CCS simulated hopping method and system, which has been validated by the DoD, FCC and NTIA. The software selects waveform parameters from within the bounds of the signal type on a random basis using uniform distribution.

The short pulse types 1, 2, 3 and 4, and the long pulse type 5 parameters are randomized at run-time.

The hopping type 6 pulse parameters are fixed while the hopping sequence is based on the August 2005 NTIA Hopping Frequency List. The initial starting point randomized at run-time and each subsequent starting point is incremented by 475. Each frequency in the 100-length segment is compared to the boundaries of the EUT Detection Bandwidth and the software creates a hopping burst pattern in accordance with Section 7.4.1.3 Method #2 Simulated Frequency Hopping Radar Waveform Generating Subsystem of KDB 905462 D02. The frequency of the signal generator is incremented in 1 MHz steps from F_L to F_H for each successive trial. This incremental sequence is repeated as required to generate a minimum of 30 total trials and to maintain a uniform frequency distribution over the entire Detection Bandwidth.

The signal monitoring equipment consists of a spectrum analyzer. The aggregate ON time is calculated by multiplying the number of bins above a threshold during a particular observation period by the dwell time per bin, with the analyzer set to peak detection and max hold.

SYSTEM CALIBRATION

A 50-ohm load is connected in place of the spectrum analyzer, and the spectrum analyzer is connected to a horn antenna via a coaxial cable, with the reference level offset set to (horn antenna gain – coaxial cable loss). The signal generator is set to CW mode. The amplitude of the signal generator is adjusted to yield a level of –64 dBm as measured on the spectrum analyzer.

Without changing any of the instrument settings, the spectrum analyzer is reconnected to the Common port of the Spectrum Analyzer Combiner/Divider. The Reference Level Offset of the spectrum analyzer is adjusted so that the displayed amplitude of the signal is –64 dBm.

The spectrum analyzer displays the level of the signal generator as received at the antenna ports of the Master Device. The interference detection threshold may be varied from the calibrated value of –64 dBm and the spectrum analyzer will still indicate the level as received by the Master Device.

ADJUSTMENT OF DISPLAYED TRAFFIC LEVEL

A link is established between the Master and Slave and the distance between the units is adjusted as needed to provide a suitable received level at the Master and Slave devices. The video test file is streamed to generate WLAN traffic. The monitoring antenna is adjusted so that the WLAN traffic level, as displayed on the spectrum analyzer, is at lower amplitude than the radar detection threshold.

TEST AND MEASUREMENT EQUIPMENT

The following test and measurement equipment was utilized for the DFS tests documented in this report:

TEST EQUIPMENT LIST				
Description	Manufacturer	Model	Asset Number	Cal Due
Spectrum Analyzer, 26.5 GHz	Agilent / HP	E4440A	C01178	09/05/15
Vector Signal Generator, 20GHz	Agilent / HP	E8267C	C01066	09/03/15
Arbitrary Waveform Generator	Agilent / HP	33220A	C01146	04/03/15

5.1.3. SETUP OF EUT

RADIATED METHOD EUT TEST SETUP

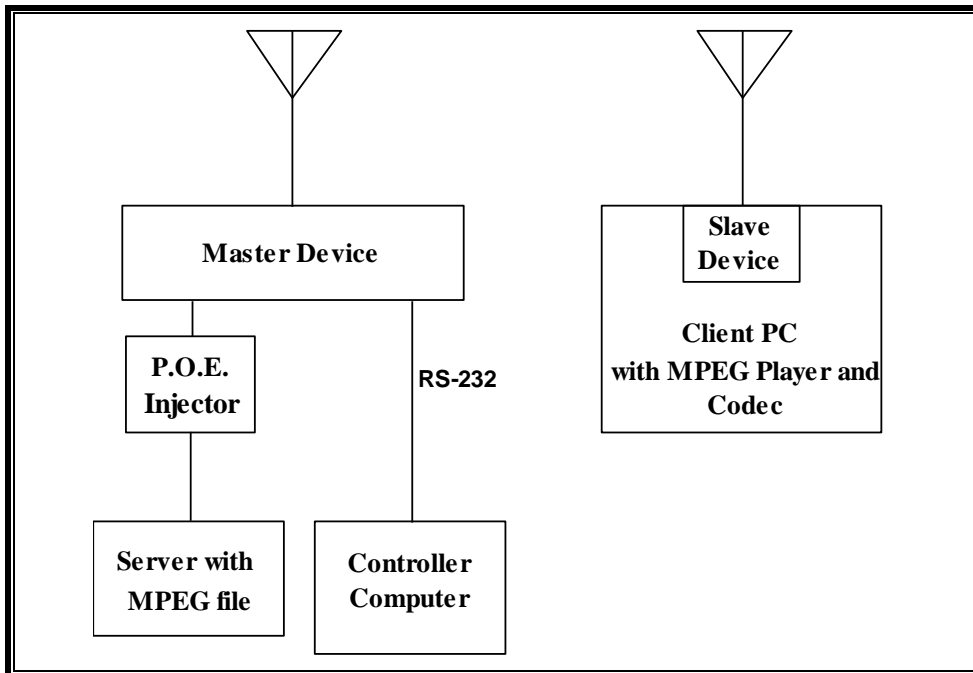

SUPPORT EQUIPMENT

The following support equipment was utilized for the DFS tests documented in this report:

PERIPHERAL SUPPORT EQUIPMENT LIST				
Description	Manufacturer	Model	Serial Number	FCC ID
P.O.E. Injector 1 (EUT)	PowerDsine	7001G	D073264400000049E	DoC
Notebook PC (Controller)	HP	EliteBook 8460p	CNU2032CKJ	DoC
AC Adapter (Controller PC)	Lite On Technology	PA-1650-32HJ	WCNXA0C1R3R8DW	DoC
Notebook PC (Server)	HP	EliteBook 8470p	CNU25193B6	DoC
AC Adapter (Server PC)	Lite On Technology	PA-1650-32HJ	WCNXA0C4L3QDDL	DoC
Notebook PC (Client)	HP	EliteBook 8470p	CNU25193C2	DoC
AC Adapter (Client PC)	Lite On Technology	PA-1900-18HX	WACMBOGBMXFCUE	DoC
802.11ac USB Converter (Slave Radio)	Cisco	AE6000	12R10602307395	Q87-AE6000

5.1.4. DESCRIPTION OF EUT

For FCC the EUT operates over the 5250-5350 MHz and 5470-5725 MHz ranges.

For IC the EUT operates over the 5250-5350 MHz and 5470-5725 MHz ranges, excluding the 5600-5650 MHz range.

The EUT is 3 x 3 MIMO Commercial/Industrial Access Point, designed to be used Outdoor or Indoor. The EUT is professionally Installed (not intended for consumer use), and it supports both Master and Client DFS, compliance to Client DFS is demonstrated in a separate report (15U19776-1).

The highest power level within these bands is 29.97 dBm (993 mW) EIRP in the 5250-5350 MHz band and 29.97 dBm (993 mW) EIRP in the 5470-5725 MHz band.

The highest gain antenna assembly (Model Number: ML-2452-PNL3M3-1) utilized with the EUT has a peak gain of 9.2 dBi in the 5250-5350 MHz band and the 5470-5725 MHz band. The lowest gain antenna assembly (Model Number: ML-5299-HPA5-01) utilized with the EUT has a peak gain of 5.6 dBi (typical gain of 4.4 dBi) in the 5250-5350 MHz band and 5.6 dBi (typical gain of 4.4 dBi) in the 5470-5725 MHz band.

Three identical dipole antennas (Model Number: ML-5299-HPA5-01) are utilized to meet the diversity and MIMO operational requirements.

The rated output power of the Master unit is > 23dBm (EIRP). Therefore the required interference threshold level is -64 dBm. After correction for procedural adjustments, the required radiated threshold at the antenna port is $-64 + 1 = -63$ dBm.

The calibrated radiated DFS Detection Threshold level is set to -64 dBm. The tested level is lower than the required level hence it provides a margin to the limit.

The EUT uses three transmitter/receiver chains, each connected to an antenna to perform radiated tests.

The Slave device associated with the EUT during these tests does not have radar detection capability.

WLAN traffic is generated by streaming the video file TestFile.mp2 "6 ½ Magic Hours" from the Master to the Slave in full motion video mode using the media player with the V2.61 Codec package.

TPC is required since the maximum EIRP is greater than 500 mW (27 dBm).

The EUT utilizes the 802.11ac architecture. Three nominal channel bandwidths are implemented: 20 MHz, 40 MHz and 80 MHz.

The software installed in the EUT is revision 5.7.1.0-212410X.

UNIFORM CHANNEL SPREADING

This function is not required per KDB 905462.

5.2. RESULTS FOR 20 MHz BANDWIDTH

5.2.1. TEST CHANNEL

All tests were performed at a channel center frequency of 5500 MHz.

5.2.2. RADAR WAVEFORMS AND TRAFFIC

RADAR WAVEFORMS

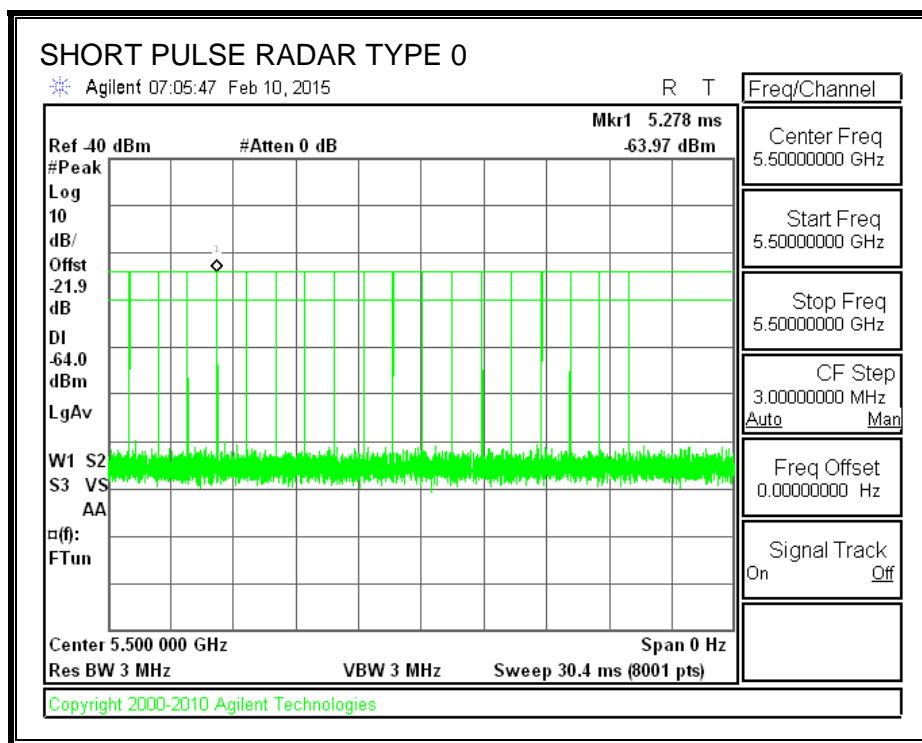

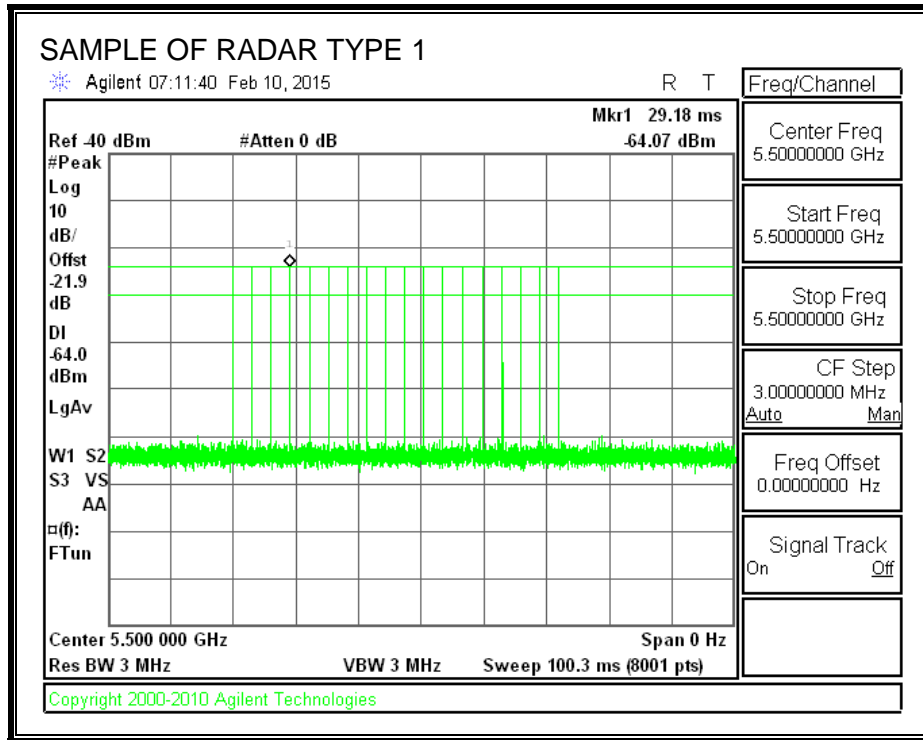

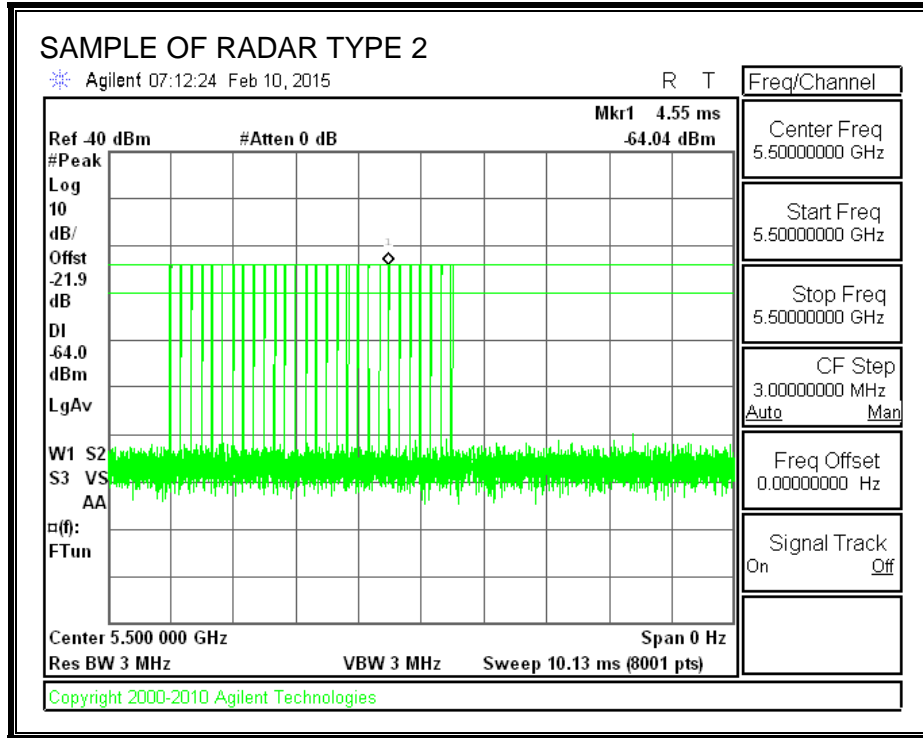

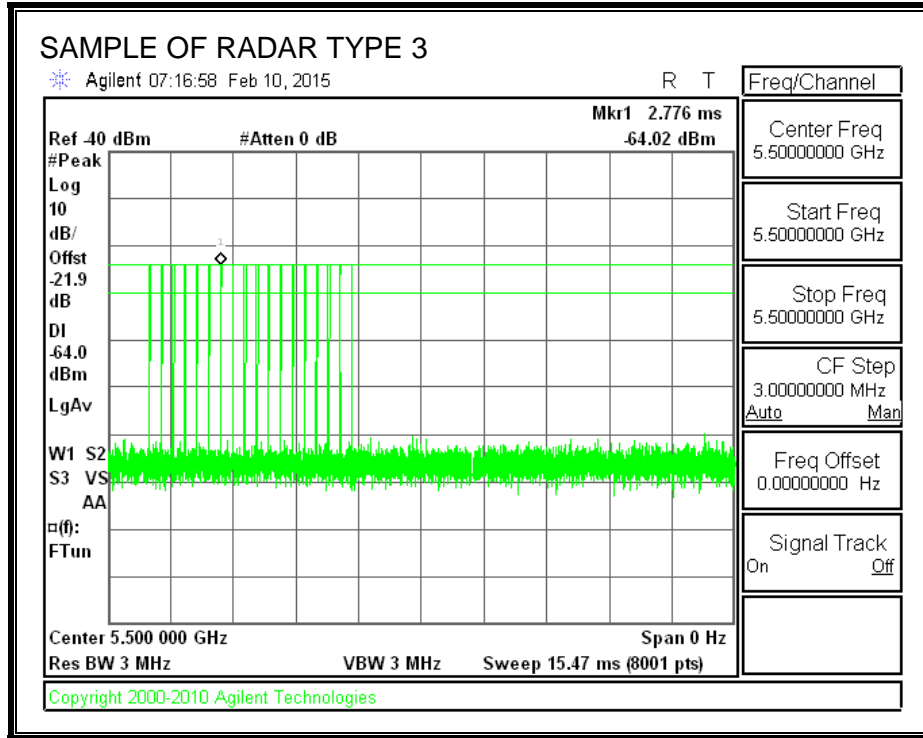

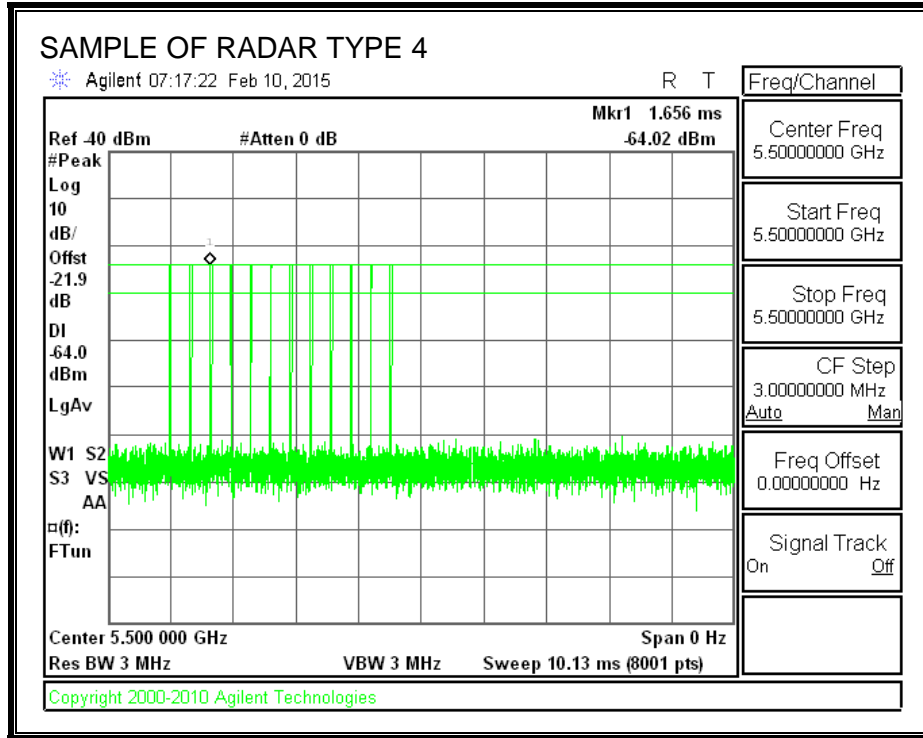

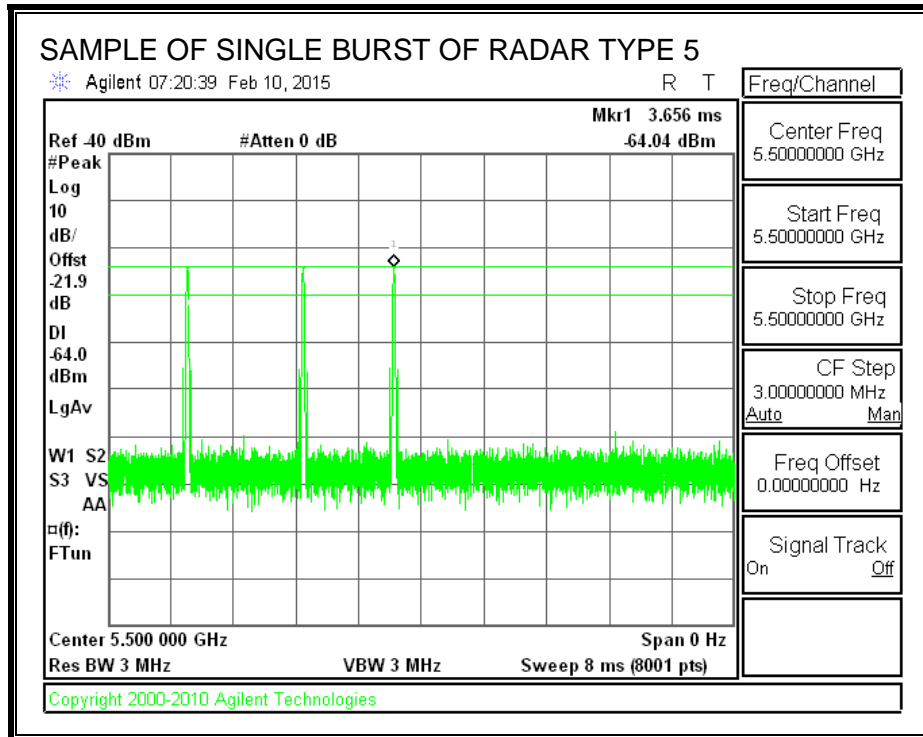

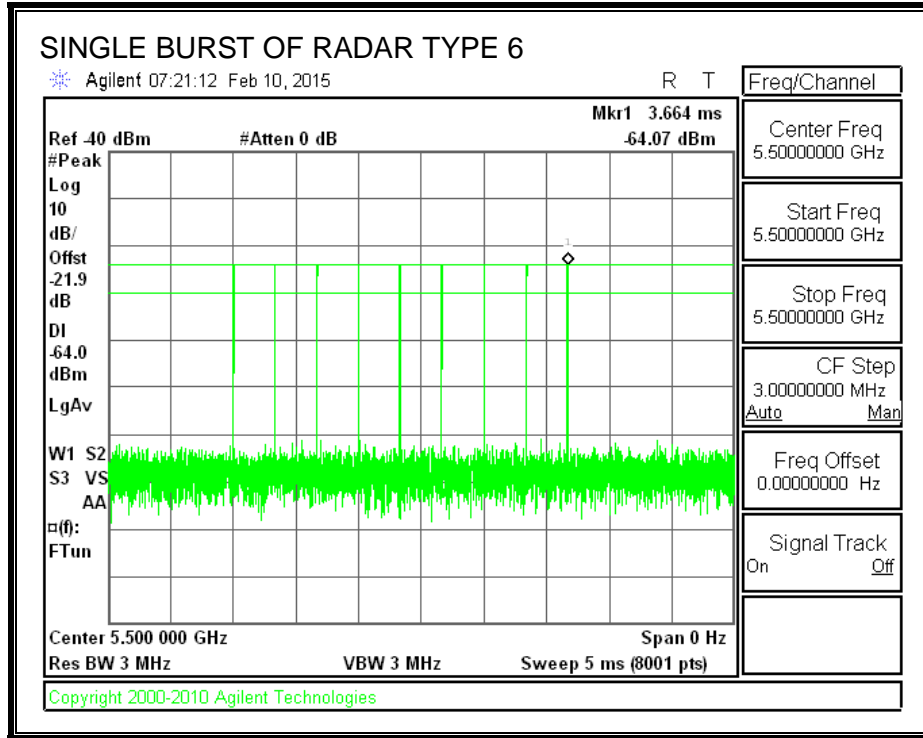

TRAFFIC

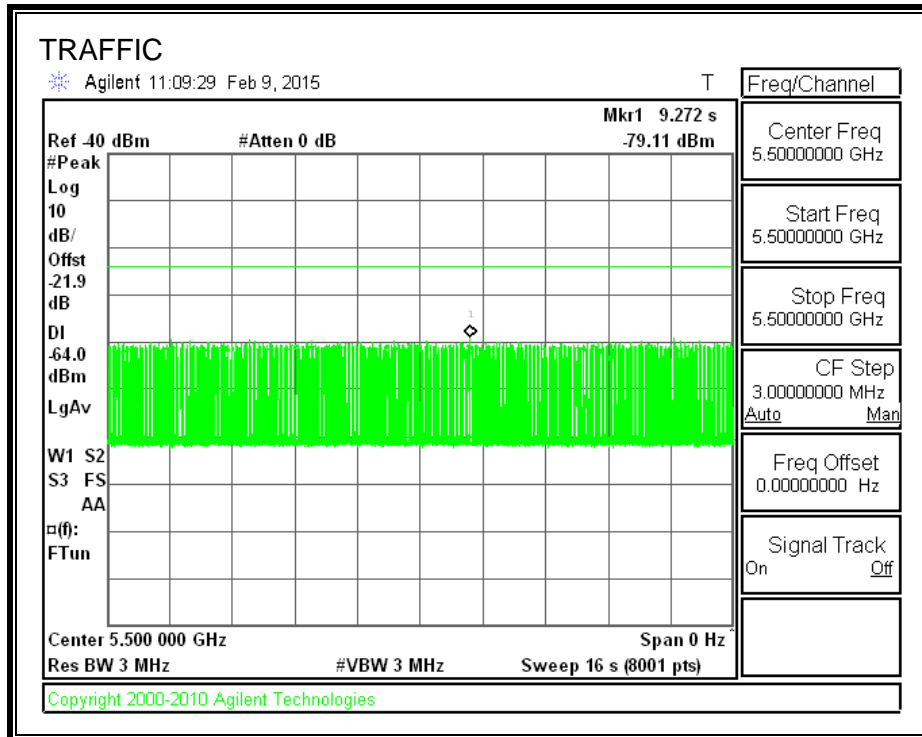

5.2.3. CHANNEL AVAILABILITY CHECK TIME

PROCEDURE TO DETERMINE INITIAL POWER-UP CYCLE TIME

A sweep was started on the spectrum analyzer when a software command was issued to the EUT to change to 5500 MHz and commence a CAC period. The time to the re-initialization of traffic was measured as the time required for the EUT to complete the CAC period.

PROCEDURE FOR TIMING OF RADAR BURST

A sweep was started on the spectrum analyzer when a software command was issued to the EUT to change to 5500 MHz and commence a CAC period. A radar signal was triggered within 0 to 6 seconds after the beginning of the CAC period and transmissions on the channel were monitored on the spectrum analyzer.

The Non-Occupancy list was cleared. A sweep was started on the spectrum analyzer when a software command was issued to the EUT to change to 5500 MHz and commence a CAC period. A radar signal was triggered within 54 to 60 seconds after the beginning of the CAC period and transmissions on the channel were monitored on the spectrum analyzer.

QUANTITATIVE RESULTS BASED UPON SPECTRUM ANALYZER PLOTS

No Radar Triggered

Beginning of CAC (sec)	Timing of Start of Traffic (sec)	CAC Period Time (sec)
0	59.33	59.33

Radar Near Beginning of CAC

Beginning of CAC (sec)	Timing of Radar Burst (sec)	Radar Relative to Start of CAC (sec)
0	0.375	0.375

Radar Near End of CAC

Beginning of CAC (sec)	Timing of Radar Burst (sec)	Radar Relative to Start of CAC (sec)
0	56.95	56.95

TIMING DIFFERENTIAL BETWEEN SPECTRUM ANALYZER PLOTS AND LOG FILE TIME STAMPS

A timing difference of up to one second occurred between the quantitative results based upon the captured spectrum analyzer plots and the log file time stamps can be attributed to the delay between the actual beginning of the EUT CAC period, reporting of the event and the initialization of the spectrum analyzer sweep. A CAC period of 60 seconds is confirmed by the time stamps provided by the log files.

QUANTITATIVE RESULTS BASED ON LOG FILE TIME STAMPS

No Radar Triggered

Beginning of CAC (hh:mm:ss)	End of CAC (hh:mm:ss)	CAC Time (hh:mm:ss)
10:36:53	10:37:53	0:01:00

Radar Near Beginning of CAC

Beginning of CAC (hh:mm:ss)	Radar Detected (hh:mm:ss)	Radar Relative to Start of CAC (hh:mm:ss)
10:46:13	10:46:14	0:00:01

Radar Near End of CAC

Beginning of CAC (hh:mm:ss)	Radar Detected (hh:mm:ss)	Radar Relative to Start of CAC (hh:mm:ss)
10:52:32	10:53:30	0:00:58

QUALITATIVE RESULTS

Timing of Radar Burst	Display on Control Computer	Spectrum Analyzer Display
No Radar Triggered	EUT marks Channel as active	Transmissions begin on channel after completion of the initial power-up cycle and the CAC
Within 0 to 6 second window	EUT indicates radar detected	No transmissions on channel
Within 54 to 60 second window	EUT indicates radar detected	No transmissions on channel

TIMING WITHOUT RADAR DURING CAC

Command to
 Switch Channels
 Start of CAC

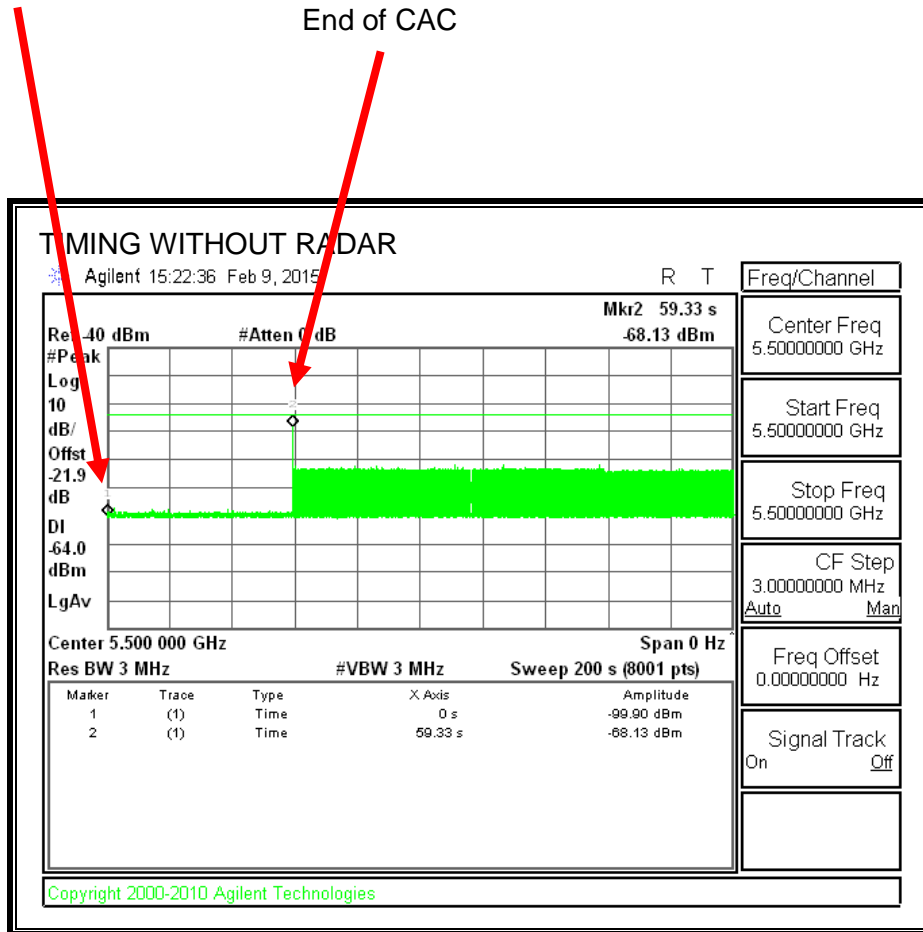

Transmissions begin on channel after completion of the CAC period.

Log File of CAC Timing Without Radar

Jan 06 10:36:53 2015: DOT11: %%%>dfs:DFS event 'channel avail check',
channel 100, recvd by rim:R1, channel 100, state 'chan

Jan 06 10:37:53 2015: DOT11: %%%>dfs:DFS event 'in service monitor

TIMING WITH RADAR NEAR BEGINNING OF CAC

Command to
Switch Channels
Start of CAC

Radar Signal Applied

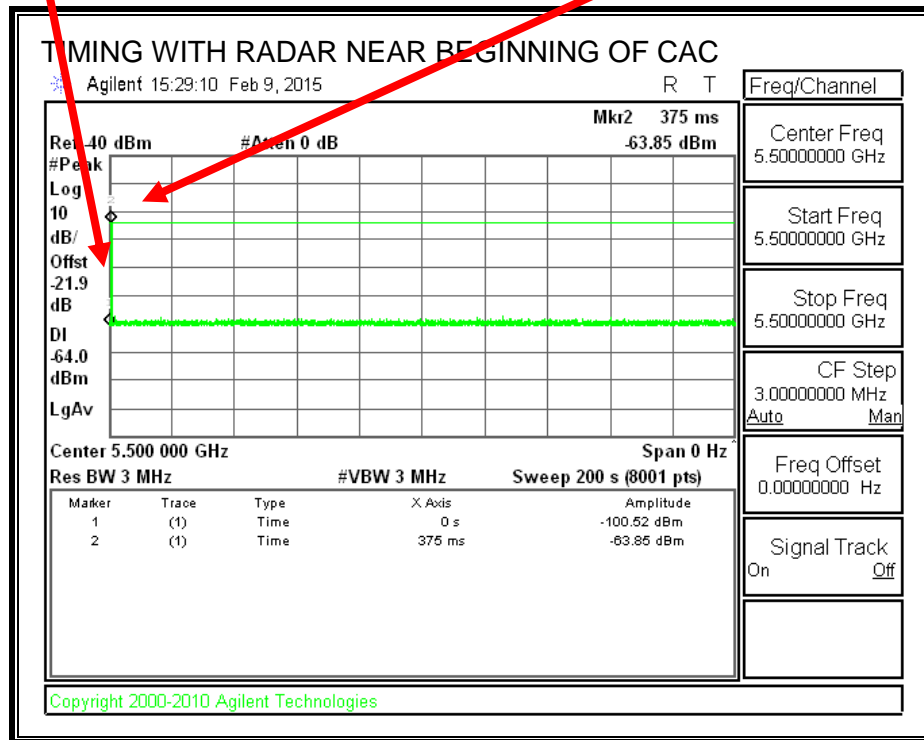

No EUT transmissions were observed after the radar signal.

Log File of Radar at the Beginning of CAC

Jan 06 10:46:13 2015: DOT11: %%%>dfs:DFS event 'channel avail check',
channel 100, recvd by rim:R1, channel 100, state 'channel avail check'

Jan 06 10:46:14 2015: ap7562-1B7004 : %RADIO-4-RADAR_DETECTED: Radar found on
channel 100 freq 5500 MHz

TIMING WITH RADAR NEAR END OF CAC

Command to
Switch Channels
Start of CAC

Radar Signal Applied

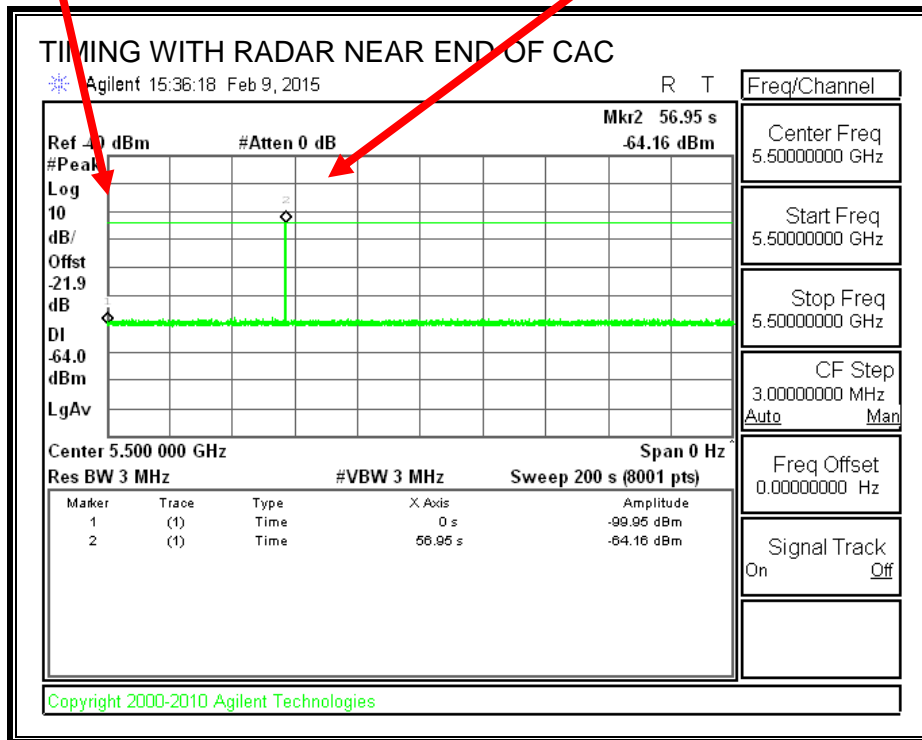

No EUT transmissions were observed after the radar signal.

Log File of Radar at the End of CAC

Jan 06 10:52:32 2015: DOT11: %%%>dfs:DFS event 'channel avail check',
channel 100, recvd by rim:R1, channel 100, state 'dfs :

Jan 06 10:53:30 2015: KERN: w11: dfs : state PRE-ISM Channel Availability
Check, detected radar in channel 100.

5.2.4. OVERLAPPING CHANNEL TESTS

RESULTS

The channel spacing is not less than the channel bandwidth therefore the EUT does not have an overlapping channel plan.

5.2.5. MOVE AND CLOSING TIME

REPORTING NOTES

The reference marker is set at the end of last radar pulse.

The delta marker is set at the end of the last WLAN transmission following the radar pulse. This delta is the channel move time.

The aggregate channel closing transmission time is calculated as follows:

Aggregate Transmission Time =
(Number of analyzer bins showing transmission) * (dwell time per bin)

The observation period over which the aggregate time is calculated begins at (Reference Marker + 200 msec) and ends no earlier than (Reference Marker + 10 sec).

RESULTS

Channel Move Time (sec)	Limit (sec)
0.438	10

Aggregate Channel Closing Transmission Time (msec)	Limit (msec)
10.0	60

MOVE TIME

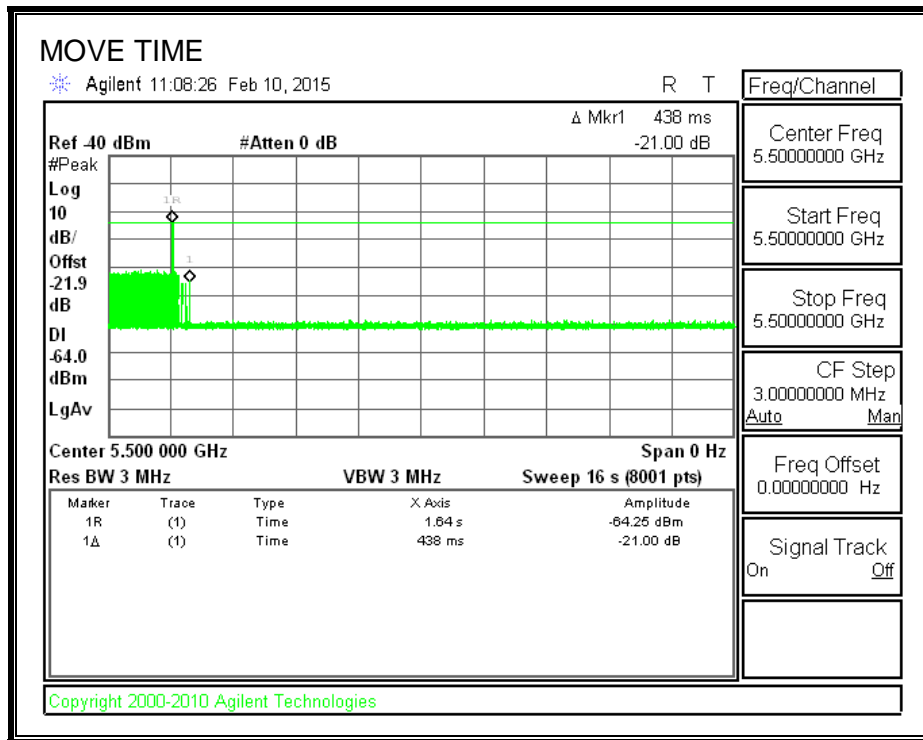

CHANNEL CLOSING TIME

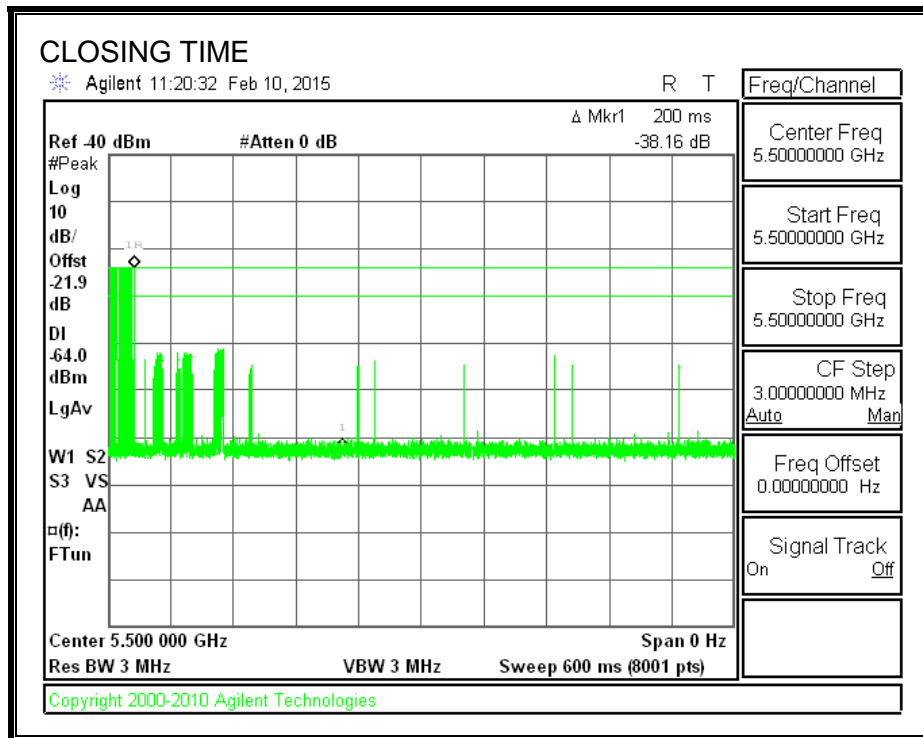

AGGREGATE CHANNEL CLOSING TRANSMISSION TIME

Only intermittent transmissions are observed during the aggregate monitoring period.

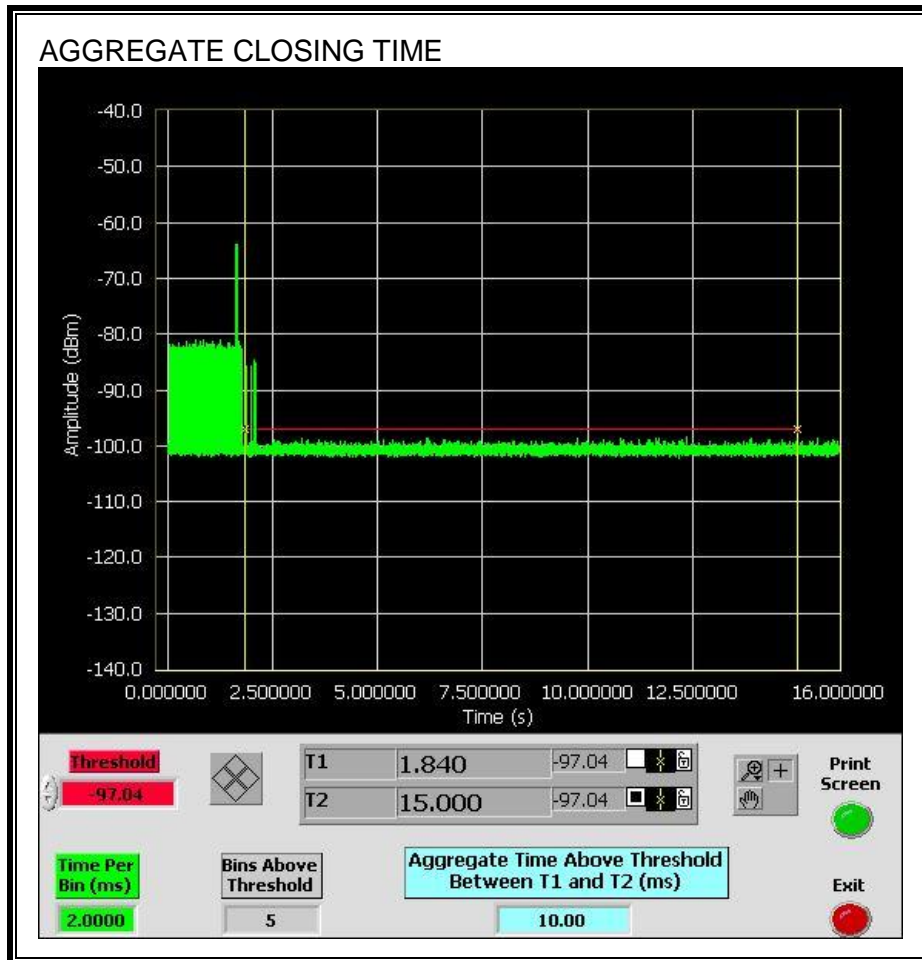

LONG PULSE CHANNEL MOVE TIME

The traffic ceases prior to 10 seconds after the end of the radar waveform.

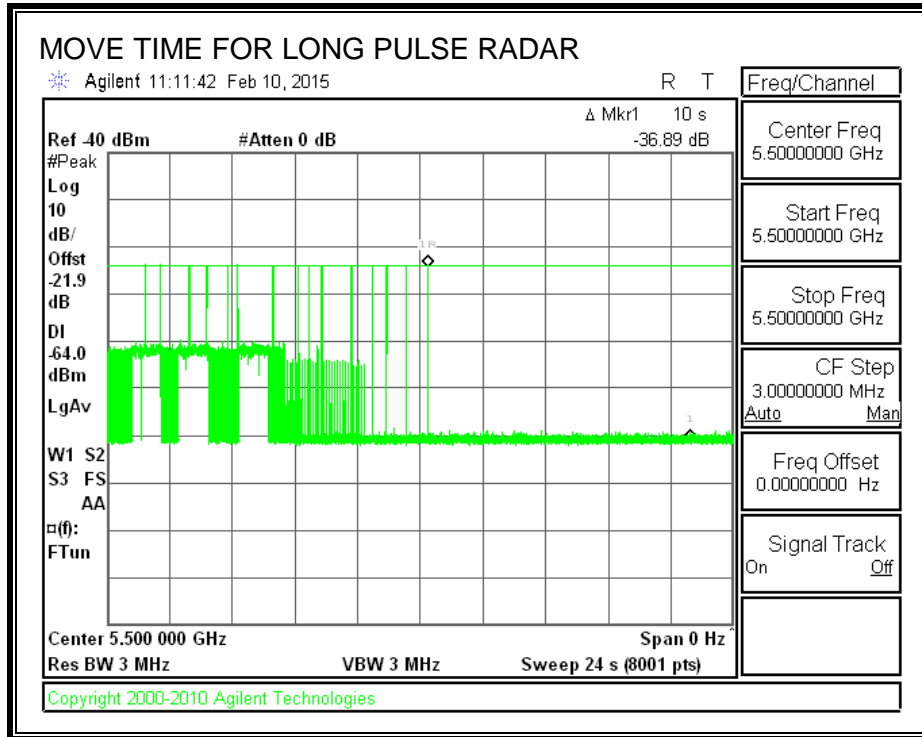

5.2.6. DETECTION BANDWIDTH

REFERENCE PLOT OF 99% POWER BANDWIDTH

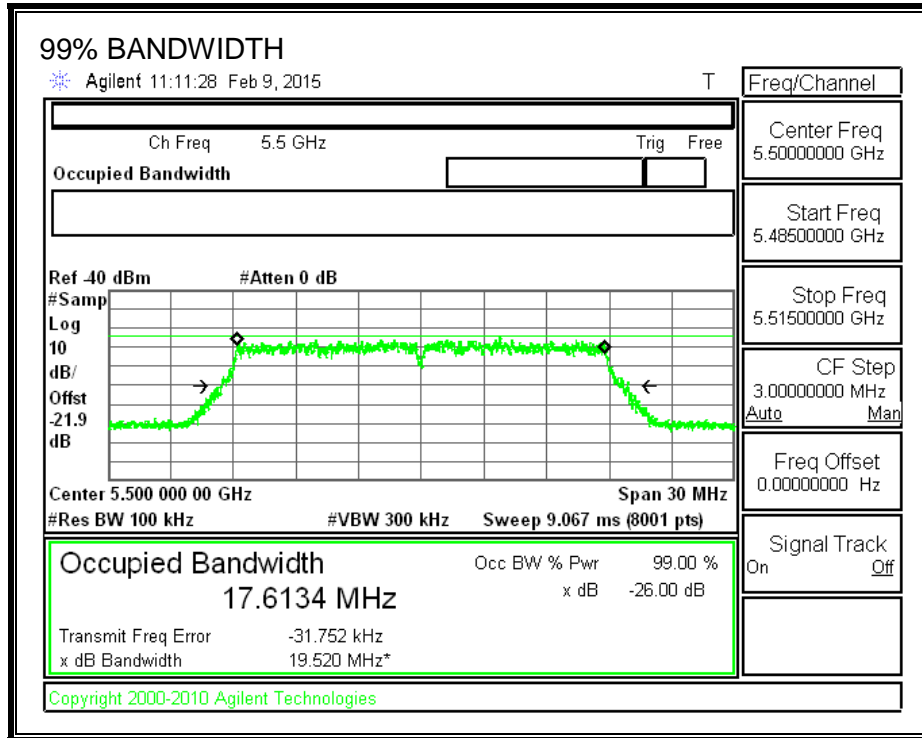

RESULTS

FL	FH	Detection Bandwidth	99% Power Bandwidth	Ratio of Detection BW to 99% Power BW	Minimum Limit
(MHz)	(MHz)	(MHz)	(MHz)	(%)	(%)
5480	5519	39	17.613	221.4	100

DETECTION BANDWIDTH PROBABILITY

Detection Bandwidth Test Results				
FCC Type 0 Waveform: 1 us Pulse Width, 1428 us PRI, 18 Pulses per Burst				
Frequency (MHz)	Number of Trials	Number Detected	Detection (%)	Mark
5479	10	3	30	
5480	10	10	100	FL
5485	10	10	100	
5490	10	10	100	
5495	10	10	100	
5500	10	10	100	
5505	10	10	100	
5510	10	10	100	
5515	10	10	100	
5516	10	10	100	
5517	10	10	100	
5518	10	10	100	
5519	10	10	100	FH
5520	20	14	70	

5.2.7. IN-SERVICE MONITORING

RESULTS

FCC Radar Test Summary				
Signal Type	Number of Trials	Detection (%)	Limit (%)	Pass/Fail
FCC Short Pulse Type 1	30	100.00	60	Pass
FCC Short Pulse Type 2	30	90.00	60	Pass
FCC Short Pulse Type 3	30	90.00	60	Pass
FCC Short Pulse Type 4	30	86.67	60	Pass
Aggregate		91.67	80	Pass
FCC Long Pulse Type 5	30	90.00	80	Pass
FCC Hopping Type 6	40	100.00	70	Pass

TYPE 1 DETECTION PROBABILITY

Data Sheet for FCC Short Pulse Radar Type 1				
1 us Pulse Width				
Waveform	PRI (us)	Pulses Per Burst	Test (A/B)	Successful Detection (Yes/No)
1001	3066	18	A	Yes
1002	738	72	A	Yes
1003	798	67	A	Yes
1004	638	83	A	Yes
1005	858	62	A	Yes
1006	778	68	A	Yes
1007	818	65	A	Yes
1008	698	76	A	Yes
1009	918	58	A	Yes
1010	538	99	A	Yes
1011	618	86	A	Yes
1012	938	57	A	Yes
1013	678	78	A	Yes
1014	578	92	A	Yes
1015	598	89	A	Yes
1016	838	63	B	Yes
1017	2778	19	B	Yes
1018	2512	22	B	Yes
1019	889	60	B	Yes
1020	1755	31	B	Yes
1021	2980	18	B	Yes
1022	1984	27	B	Yes
1023	1595	34	B	Yes
1024	974	55	B	Yes
1025	1393	38	B	Yes
1026	1120	48	B	Yes
1027	1149	46	B	Yes
1028	711	75	B	Yes
1029	2236	24	B	Yes
1030	1963	27	B	Yes

TYPE 2 DETECTION PROBABILITY

Data Sheet for FCC Short Pulse Radar Type 2				
Waveform	Pulse Width (us)	PRI (us)	Pulses Per Burst	Successful Detection (Yes/No)
2001	3.4	169.00	28	Yes
2002	2.3	208.00	25	Yes
2003	2	179.00	27	Yes
2004	4.8	193.00	25	Yes
2005	1	187.00	23	Yes
2006	3.7	154.00	27	Yes
2007	1.7	153.00	24	Yes
2008	4.5	196.00	25	Yes
2009	4.9	151.00	26	Yes
2010	4.2	195.00	24	Yes
2011	3.5	180.00	27	Yes
2012	3.2	187.00	27	Yes
2013	4.9	158.00	29	Yes
2014	4.2	223.00	24	Yes
2015	2.5	172.00	23	Yes
2016	2.9	166.00	25	No
2017	4.5	177.00	25	No
2018	1.6	170.00	24	No
2019	2.4	217.00	26	Yes
2020	2.6	195.00	27	Yes
2021	1.6	167.00	28	Yes
2022	5	173.00	28	Yes
2023	4	157.00	29	Yes
2024	1.4	171.00	26	Yes
2025	3.8	224.00	24	Yes
2026	3.3	210.00	25	Yes
2027	2.2	199.00	25	Yes
2028	3.8	218.00	28	Yes
2029	2.2	166.00	26	Yes
2030	3.7	215.00	27	Yes

TYPE 3 DETECTION PROBABILITY

Data Sheet for FCC Short Pulse Radar Type 3				
Waveform	Pulse Width (us)	PRI (us)	Pulses Per Burst	Successful Detection (Yes/No)
3001	8.7	296.00	18	Yes
3002	8	432.00	18	Yes
3003	6	440.00	16	Yes
3004	9.8	482.00	17	Yes
3005	5.6	296.00	18	Yes
3006	8.8	278.00	17	No
3007	7.6	483.00	16	Yes
3008	6.5	463.00	17	No
3009	8	345.00	17	No
3010	9.5	455.00	18	Yes
3011	8.9	369.00	16	Yes
3012	5.8	258.00	18	Yes
3013	8.2	328.00	17	Yes
3014	7.6	443.00	16	Yes
3015	5.4	289.00	18	Yes
3016	7.6	263.00	17	Yes
3017	6.6	439.00	18	Yes
3018	5.3	331.00	16	Yes
3019	6.8	331.00	17	Yes
3020	8	460.00	16	Yes
3021	6.2	428.00	18	Yes
3022	7.2	488.00	18	Yes
3023	9.3	439.00	16	Yes
3024	8.4	378.00	17	Yes
3025	7.5	432.00	16	Yes
3026	5	289.00	16	Yes
3027	9.4	287.00	18	Yes
3028	6.9	311.00	18	Yes
3029	9.9	487	17	Yes
3030	9.1	403	16	Yes

TYPE 4 DETECTION PROBABILITY

Data Sheet for FCC Short Pulse Radar Type 4				
Waveform	Pulse Width (us)	PRI (us)	Pulses Per Burst	Successful Detection (Yes/No)
4001	14.1	325.00	12	Yes
4002	18.3	473.00	15	Yes
4003	15	355.00	12	Yes
4004	13.3	251.00	16	Yes
4005	15	308.00	12	Yes
4006	11.2	363.00	15	Yes
4007	14.9	271.00	12	No
4008	18.3	291.00	13	Yes
4009	15	434.00	12	Yes
4010	15.6	269.00	16	Yes
4011	18.8	363.00	12	Yes
4012	15.1	488.00	14	Yes
4013	11.5	476.00	13	Yes
4014	15.1	413.00	14	No
4015	15	495.00	14	Yes
4016	16.9	466.00	13	Yes
4017	19.1	319.00	16	Yes
4018	10.3	337.00	13	Yes
4019	16.1	382.00	16	Yes
4020	17	316.00	12	Yes
4021	19.3	376.00	13	Yes
4022	16.3	435.00	12	Yes
4023	12.3	407.00	13	No
4024	13.1	332.00	16	Yes
4025	12.3	448.00	16	Yes
4026	12.9	362.00	13	Yes
4027	11.6	449.00	14	Yes
4028	17.1	343.00	13	Yes
4029	14.6	314.00	14	Yes
4030	17.8	410.00	12	No

TYPE 5 DETECTION PROBABILITY

Data Sheet for FCC Long Pulse Radar Type 5	
Trial	Successful Detection (Yes/No)
1	Yes
2	Yes
3	Yes
4	No
5	Yes
6	Yes
7	Yes
8	Yes
9	Yes
10	Yes
11	Yes
12	Yes
13	Yes
14	Yes
15	Yes
16	Yes
17	Yes
18	Yes
19	Yes
20	Yes
21	No
22	Yes
23	Yes
24	Yes
25	Yes
26	Yes
27	Yes
28	Yes
29	No
30	Yes

Note: The Type 5 randomized parameters are shown in a separate document.

TYPE 6 DETECTION PROBABILITY

Data Sheet for FCC Hopping Radar Type 6				
1 us Pulse Width, 333 us PRI, 9 Pulses per Burst, 1 Burst per Hop				
NTIA August 2005 Hopping Sequence				
Trial	Starting Index Within Sequence	Signal Generator Frequency (MHz)	Hops within Detection BW	Successful Detection (Yes/No)
1	115	5480	4	Yes
2	590	5481	10	Yes
3	1065	5482	6	Yes
4	1540	5483	7	Yes
5	2015	5484	7	Yes
6	2490	5485	10	Yes
7	2965	5486	7	Yes
8	3440	5487	10	Yes
9	3915	5488	7	Yes
10	4390	5489	10	Yes
11	4865	5490	10	Yes
12	5340	5491	8	Yes
13	5815	5492	9	Yes
14	6290	5493	9	Yes
15	6765	5494	7	Yes
16	7240	5495	9	Yes
17	7715	5496	11	Yes
18	8190	5497	8	Yes
19	8665	5498	8	Yes
20	9140	5499	15	Yes
21	9615	5500	9	Yes
22	10090	5501	10	Yes
23	10565	5502	7	Yes
24	11040	5503	10	Yes
25	11515	5504	9	Yes
26	11990	5505	12	Yes
27	12465	5506	10	Yes
28	12940	5507	15	Yes
29	13415	5508	13	Yes
30	13890	5509	6	Yes
31	14365	5510	10	Yes
32	14840	5511	10	Yes
33	15315	5512	11	Yes
34	15790	5513	7	Yes
35	16265	5514	2	Yes
36	16740	5515	5	Yes
37	17215	5516	10	Yes
38	17690	5517	7	Yes
39	18165	5518	11	Yes
40	18640	5519	12	Yes

5.3. RESULTS FOR 40 MHz BANDWIDTH

5.3.1. TEST CHANNEL

All tests were performed at a channel center frequency of 5510 MHz.

5.3.2. RADAR WAVEFORMS AND TRAFFIC

RADAR WAVEFORMS

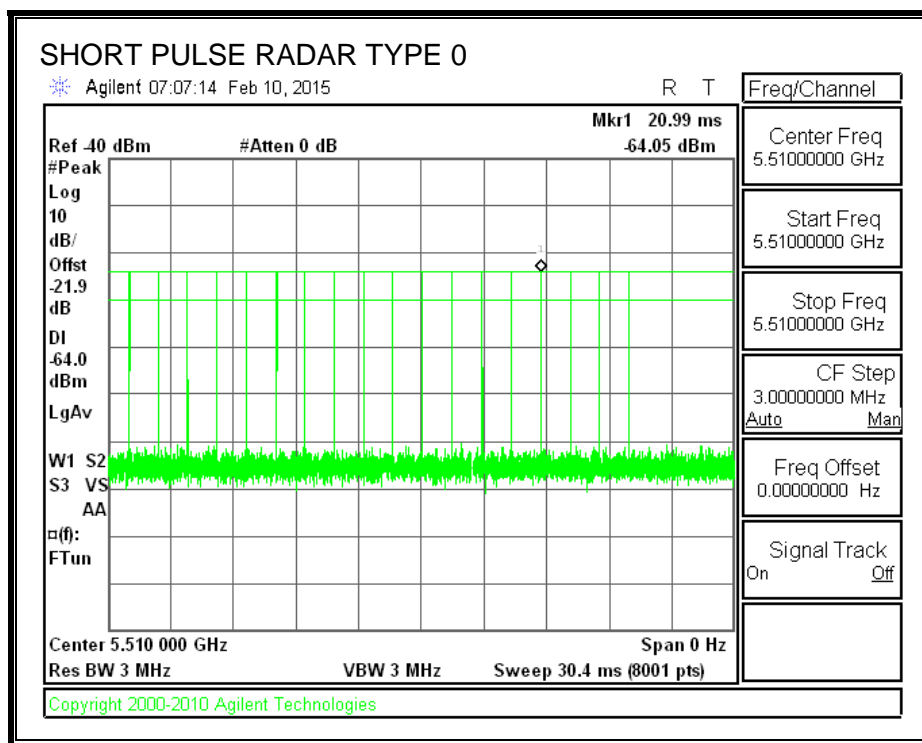

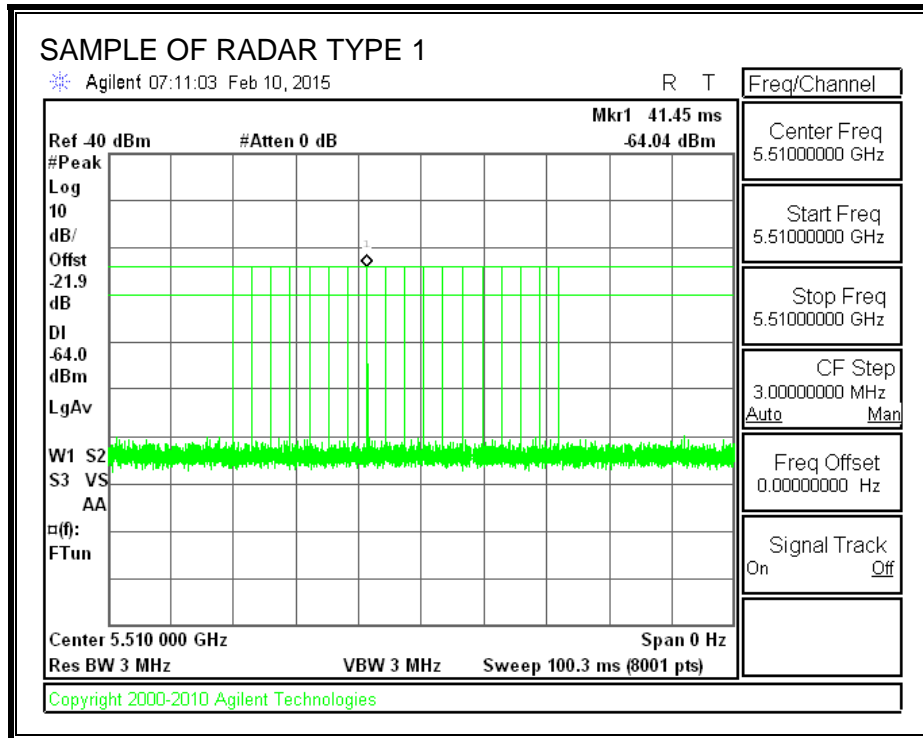

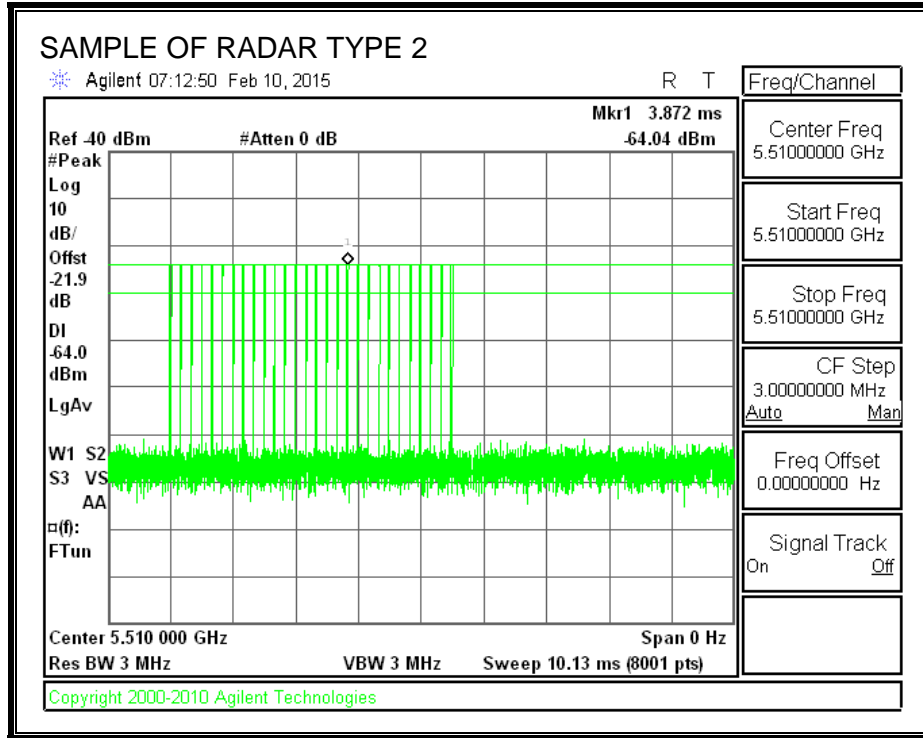

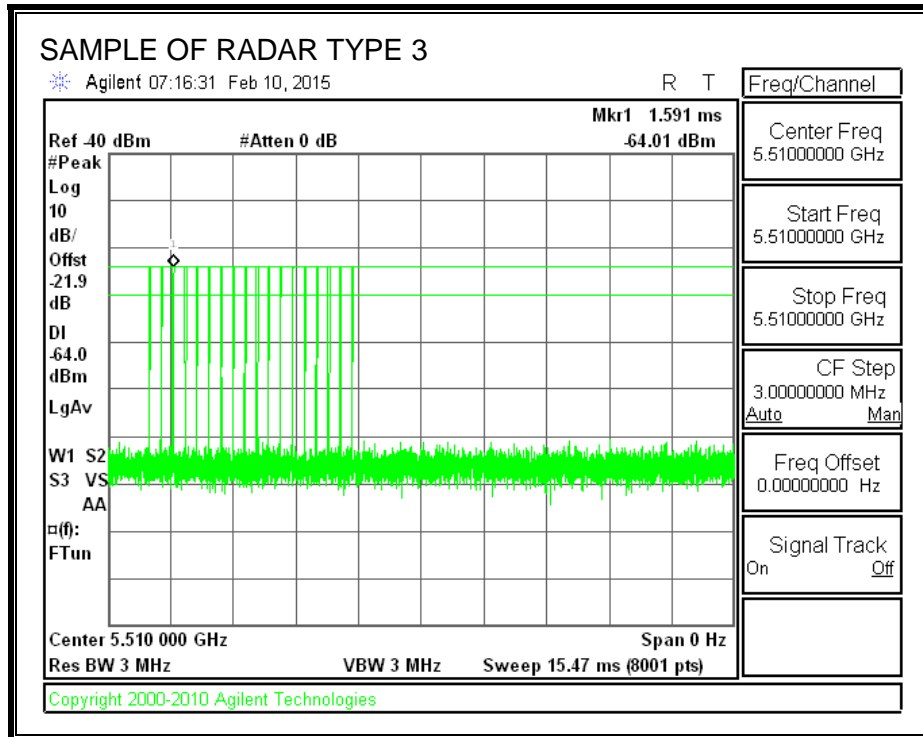

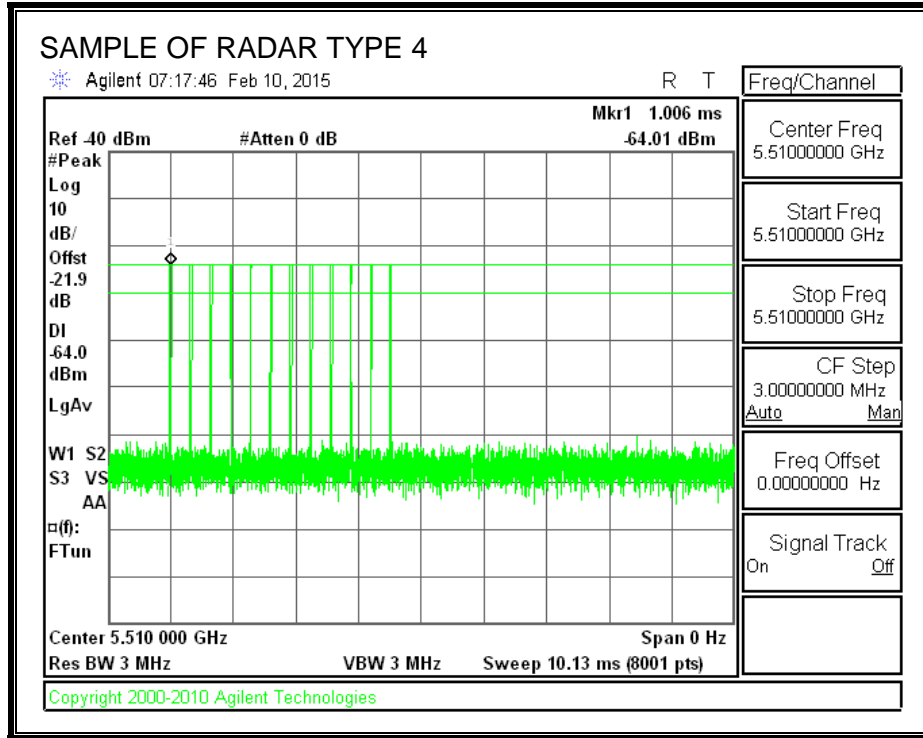

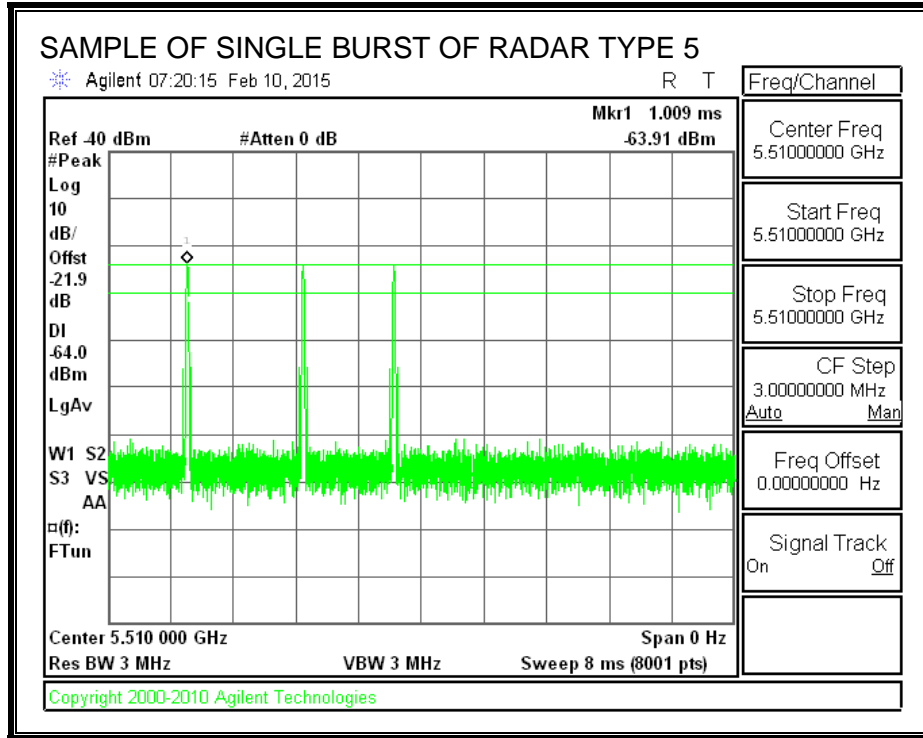

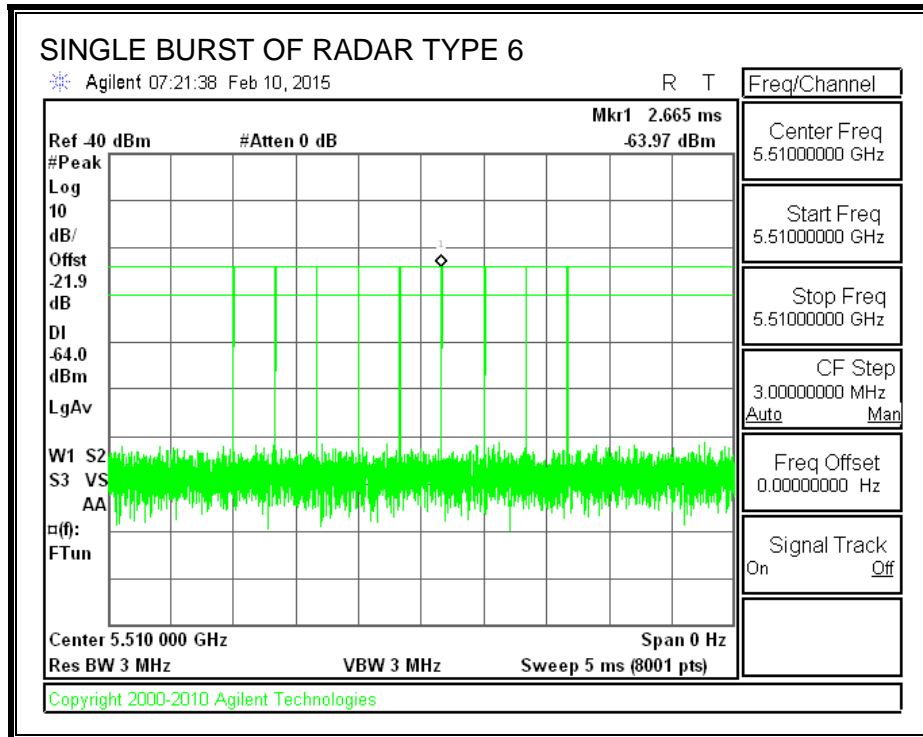

TRAFFIC

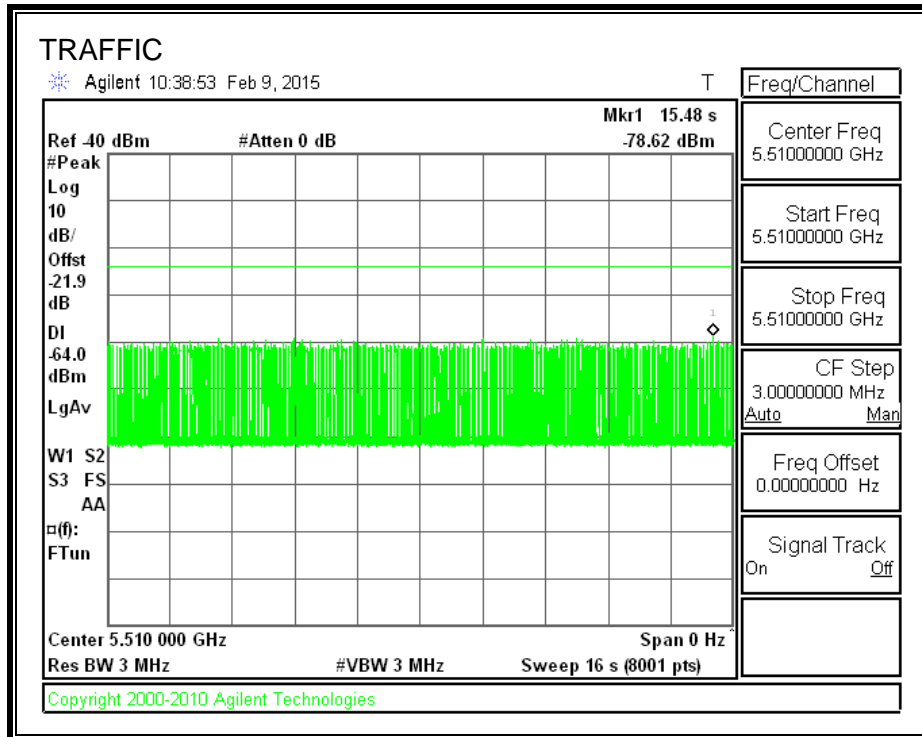

5.3.3. CHANNEL AVAILABILITY CHECK TIME

PROCEDURE TO DETERMINE INITIAL POWER-UP CYCLE TIME

A sweep was started on the spectrum analyzer when a software command was issued to the EUT to change to 5510 MHz and commence a CAC period. The time to the re-initialization of traffic was measured as the time required for the EUT to complete the CAC period.

PROCEDURE FOR TIMING OF RADAR BURST

A sweep was started on the spectrum analyzer when a software command was issued to the EUT to change to 5510 MHz and commence a CAC period. A radar signal was triggered within 0 to 6 seconds after the beginning of the CAC period and transmissions on the channel were monitored on the spectrum analyzer.

The Non-Occupancy list was cleared. A sweep was started on the spectrum analyzer when a software command was issued to the EUT to change to 5510 MHz and commence a CAC period. A radar signal was triggered within 54 to 60 seconds after the beginning of the CAC period and transmissions on the channel were monitored on the spectrum analyzer.

QUANTITATIVE RESULTS BASED UPON SPECTRUM ANALYZER PLOTS

No Radar Triggered

Beginning of CAC (sec)	Timing of Start of Traffic (sec)	CAC Period Time (sec)
0	59.35	59.35

Radar Near Beginning of CAC

Beginning of CAC (sec)	Timing of Radar Burst (sec)	Radar Relative to Start of CAC (sec)
0	2.425	2.425

Radar Near End of CAC

Beginning of CAC (sec)	Timing of Radar Burst (sec)	Radar Relative to Start of CAC (sec)
0	56.95	56.95

TIMING DIFFERENTIAL BETWEEN SPECTRUM ANALYZER PLOTS AND LOG FILE TIME STAMPS

A timing difference of up to one second occurred between the quantitative results based upon the captured spectrum analyzer plots and the log file time stamps can be attributed to the delay between the actual beginning of the EUT CAC period, reporting of the event and the initialization of the spectrum analyzer sweep. A CAC period of 60 seconds is confirmed by the time stamps provided by the log files.

QUANTITATIVE RESULTS BASED ON LOG FILE TIME STAMPS

No Radar Triggered

Beginning of CAC (hh:mm:ss)	End of CAC (hh:mm:ss)	CAC Time (hh:mm:ss)
11:00:22	11:01:22	0:01:00

Radar Near Beginning of CAC

Beginning of CAC (hh:mm:ss)	Radar Detected (hh:mm:ss)	Radar Relative to Start of CAC (hh:mm:ss)
11:07:59	11:08:02	0:00:03

Radar Near End of CAC

Beginning of CAC (hh:mm:ss)	Radar Detected (hh:mm:ss)	Radar Relative to Start of CAC (hh:mm:ss)
11:14:14	11:15:12	0:00:58

QUALITATIVE RESULTS

Timing of Radar Burst	Display on Control Computer	Spectrum Analyzer Display
No Radar Triggered	EUT marks Channel as active	Transmissions begin on channel after completion of the initial power-up cycle and the CAC
Within 0 to 6 second window	EUT indicates radar detected	No transmissions on channel
Within 54 to 60 second window	EUT indicates radar detected	No transmissions on channel

TIMING WITHOUT RADAR DURING CAC

Command to
Switch Channels
Start of CAC

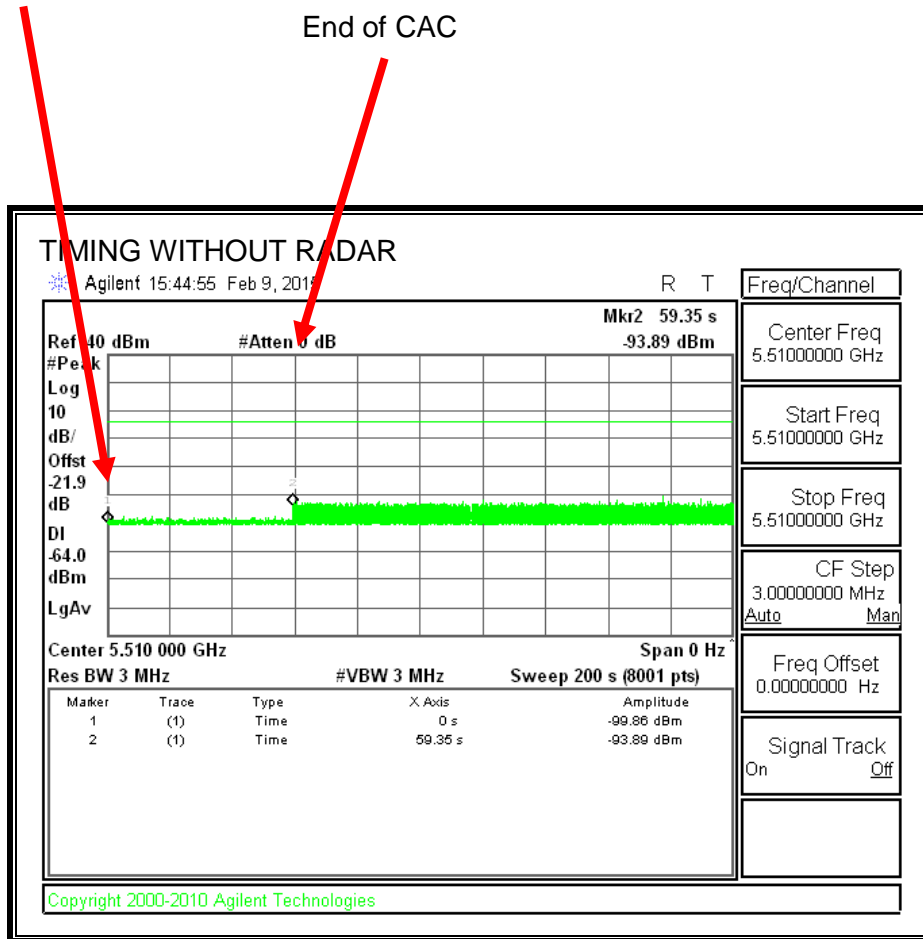

Transmissions begin on channel after completion of the CAC period.

Log File of CAC Timing Without Radar

Jan 06 11:00:22 2015: DOT11: %%%>dfs:DFS event 'channel avail check',
channel 100, recvd by rim:R1, channel 100, state 'channel avail check'

Jan 06 11:01:22 2015: DOT11: %%%>dfs:DFS event 'in service monitoring',
channel 100, recvd by rim:R1, channel 100

TIMING WITH RADAR NEAR BEGINNING OF CAC

Command to
Switch Channels
Start of CAC

Radar Signal Applied

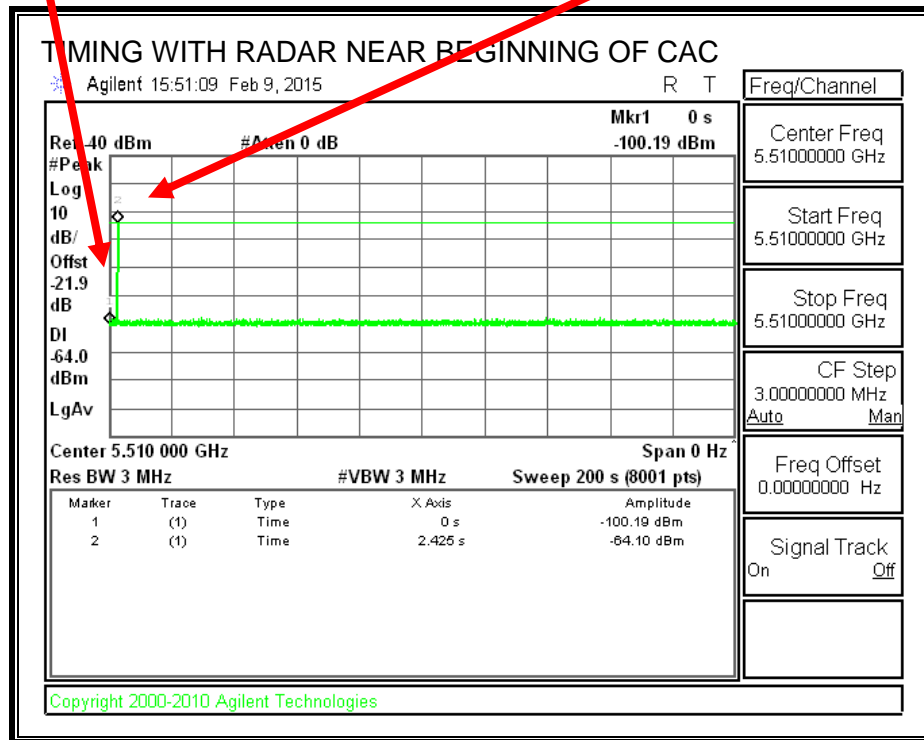

No EUT transmissions were observed after the radar signal.

Log File of Radar at the Beginning of CAC

Jan 06 11:07:59 2015: DOT11: %%%>dfs:DFS event 'channel avail check',
channel 100, recvd by rim:R1, channel 100, state 'dfs 3

Jan 06 11:08:02 2015: KERN: w11: dfs : state PRE-ISM Channel Availability
Check, detected radar in channel 102.

TIMING WITH RADAR NEAR END OF CAC

Command to
 Switch Channels
 Start of CAC

Radar Signal Applied

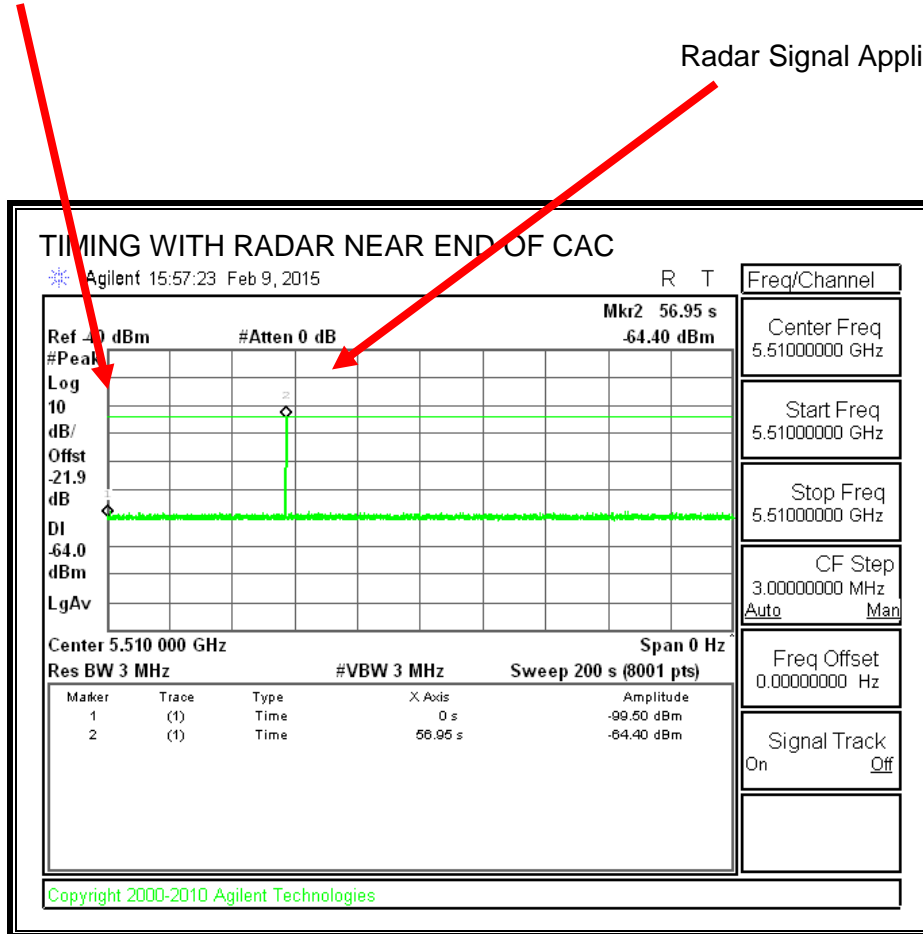

No EUT transmissions were observed after the radar signal.

Log File of Radar at the End of CAC

Jan 06 11:14:14 2015: DOT11: %%%>dfs:DFS event 'channel avail check',
channel 100, recvd by rim:R1, channel 100, state 'dfs :

Jan 06 11:15:12 2015: ap7562-1B7004 : %RADIO-4-RADAR_DETECTED: Radar found on
channel 100 freq 5500 MHz

5.3.1. OVERLAPPING CHANNEL TESTS

RESULTS

The channel spacing is not less than the channel bandwidth therefore the EUT does not have an overlapping channel plan.

5.3.2. MOVE AND CLOSING TIME

REPORTING NOTES

The reference marker is set at the end of last radar pulse.

The delta marker is set at the end of the last WLAN transmission following the radar pulse. This delta is the channel move time.

The aggregate channel closing transmission time is calculated as follows:

Aggregate Transmission Time =
(Number of analyzer bins showing transmission) * (dwell time per bin)

The observation period over which the aggregate time is calculated begins at (Reference Marker + 200 msec) and ends no earlier than (Reference Marker + 10 sec).

RESULTS

Channel Move Time (sec)	Limit (sec)
0.714	10

Aggregate Channel Closing Transmission Time (msec)	Limit (msec)
24.0	60

MOVE TIME

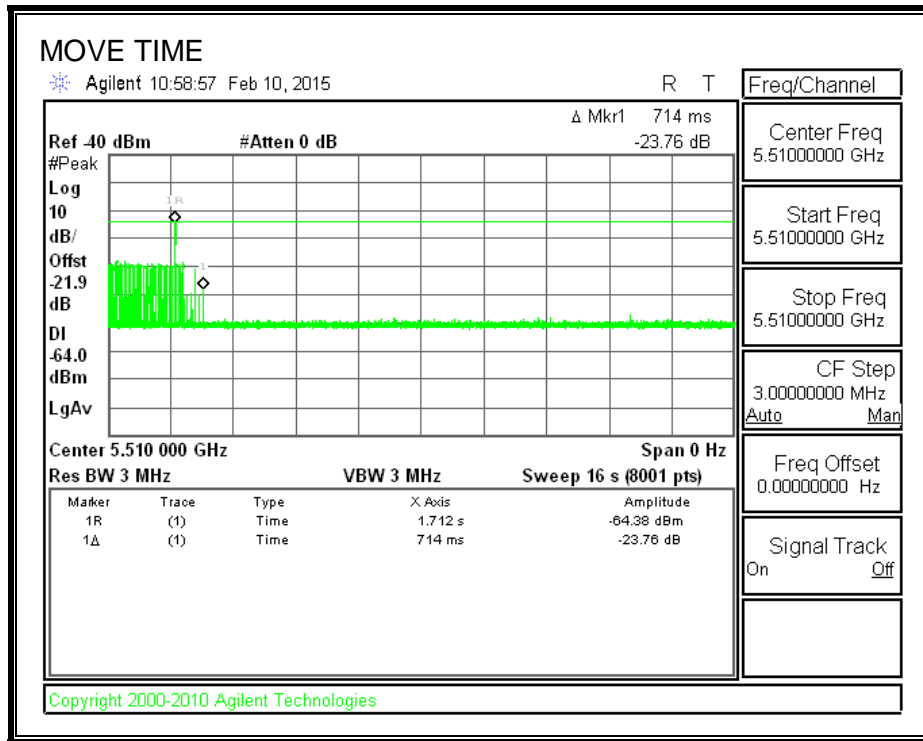

CHANNEL CLOSING TIME

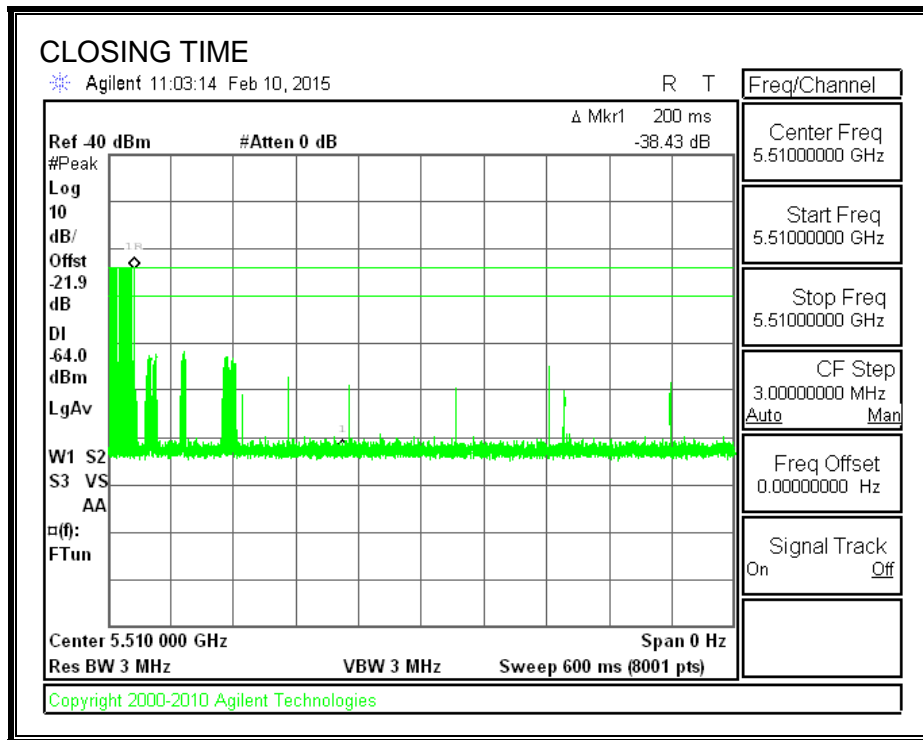

AGGREGATE CHANNEL CLOSING TRANSMISSION TIME

Only intermittent transmissions are observed during the aggregate monitoring period.

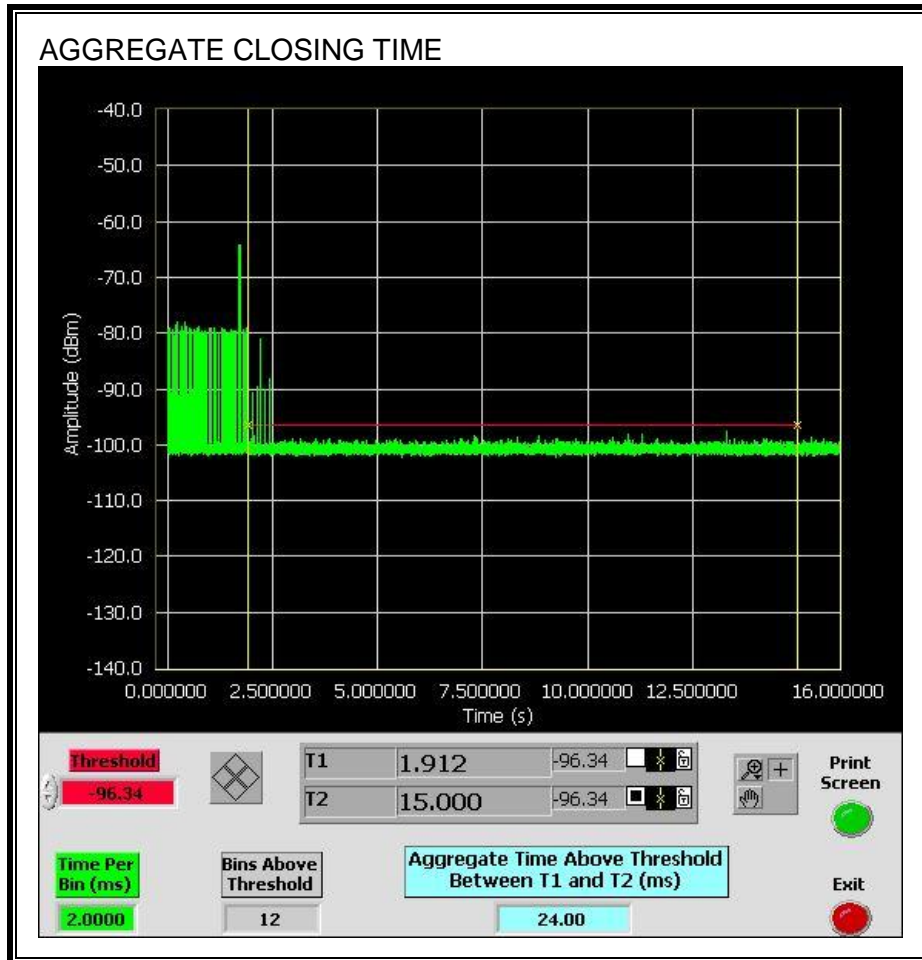

LONG PULSE CHANNEL MOVE TIME

The traffic ceases prior to 10 seconds after the end of the radar waveform.

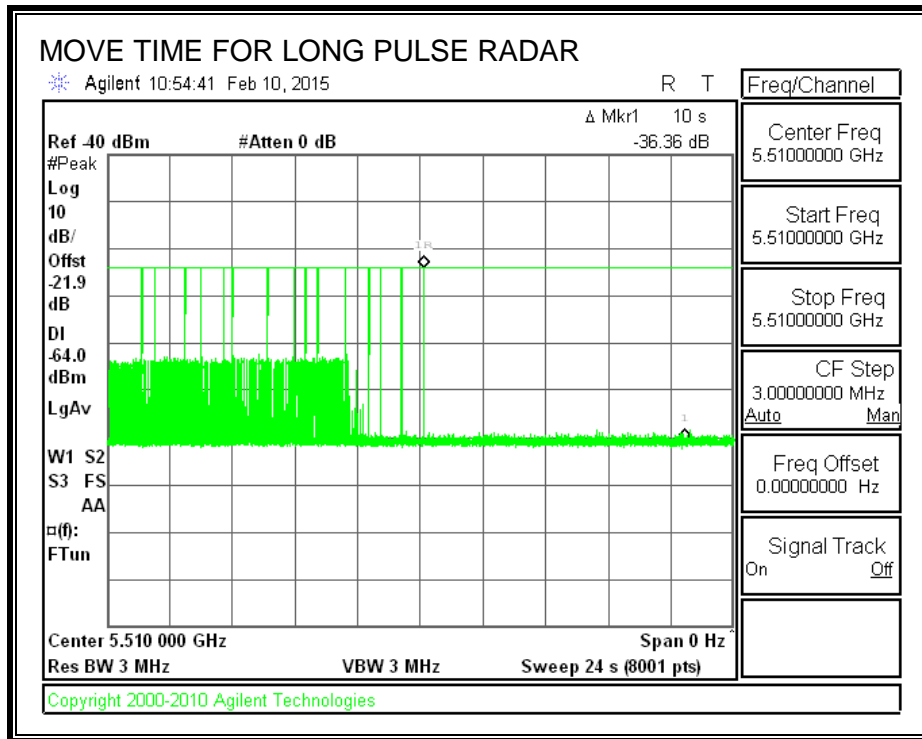

5.3.3. DETECTION BANDWIDTH

REFERENCE PLOT OF 99% POWER BANDWIDTH

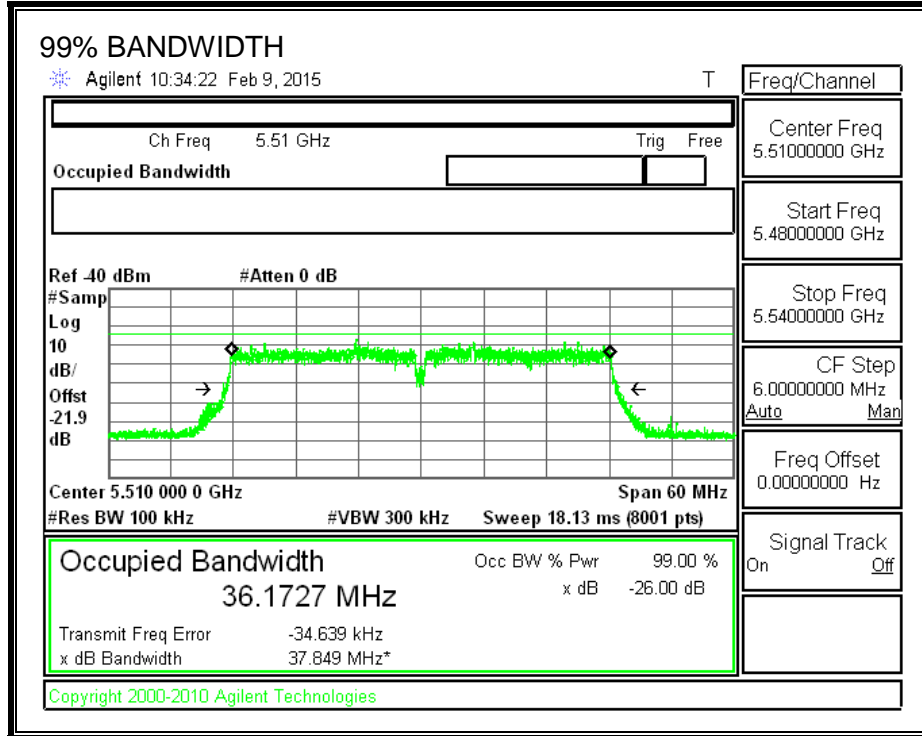

RESULTS

FL	FH	Detection Bandwidth	99% Power Bandwidth	Ratio of Detection BW to 99% Power BW	Minimum Limit
(MHz)	(MHz)	(MHz)	(MHz)	(%)	(%)
5485	5535	50	36.173	138.2	100

DETECTION BANDWIDTH PROBABILITY

Detection Bandwidth Test Results				
FCC Type 0 Waveform: 1 us Pulse Width, 1428 us PRI, 18 Pulses per Burst				
Frequency (MHz)	Number of Trials	Number Detected	Detection (%)	Mark
5484	10	0	0	
5485	10	10	100	FL
5490	10	10	100	
5495	10	10	100	
5500	10	9	90	
5505	10	10	100	
5510	10	10	100	
5515	10	10	100	
5520	10	10	100	
5525	10	10	100	
5530	10	10	100	
5535	10	10	100	FH
5536	10	0	0	

5.3.4. IN-SERVICE MONITORING

RESULTS

FCC Radar Test Summary				
Signal Type	Number of Trials	Detection (%)	Limit (%)	Pass/Fail
FCC Short Pulse Type 1	30	96.67	60	Pass
FCC Short Pulse Type 2	30	90.00	60	Pass
FCC Short Pulse Type 3	30	100.00	60	Pass
FCC Short Pulse Type 4	30	86.67	60	Pass
Aggregate		93.33	80	Pass
FCC Long Pulse Type 5	30	86.67	80	Pass
FCC Hopping Type 6	51	100.00	70	Pass

TYPE 1 DETECTION PROBABILITY

Data Sheet for FCC Short Pulse Radar Type 1				
1 us Pulse Width				
Waveform	PRI (us)	Pulses Per Burst	Test (A/B)	Successful Detection (Yes/No)
1001	3066	18	A	No
1002	738	72	A	Yes
1003	798	67	A	Yes
1004	638	83	A	Yes
1005	858	62	A	Yes
1006	778	68	A	Yes
1007	818	65	A	Yes
1008	698	76	A	Yes
1009	918	58	A	Yes
1010	538	99	A	Yes
1011	618	86	A	Yes
1012	938	57	A	Yes
1013	678	78	A	Yes
1014	578	92	A	Yes
1015	598	89	A	Yes
1016	838	63	B	Yes
1017	2778	19	B	Yes
1018	2512	22	B	Yes
1019	889	60	B	Yes
1020	1755	31	B	Yes
1021	2980	18	B	Yes
1022	1984	27	B	Yes
1023	1595	34	B	Yes
1024	974	55	B	Yes
1025	1393	38	B	Yes
1026	1120	48	B	Yes
1027	1149	46	B	Yes
1028	711	75	B	Yes
1029	2236	24	B	Yes
1030	1963	27	B	Yes

TYPE 2 DETECTION PROBABILITY

Data Sheet for FCC Short Pulse Radar Type 2				
Waveform	Pulse Width (us)	PRI (us)	Pulses Per Burst	Successful Detection (Yes/No)
2001	3.4	169.00	28	Yes
2002	2.3	208.00	25	Yes
2003	2	179.00	27	Yes
2004	4.8	193.00	25	Yes
2005	1	187.00	23	Yes
2006	3.7	154.00	27	Yes
2007	1.7	153.00	24	Yes
2008	4.5	196.00	25	Yes
2009	4.9	151.00	26	Yes
2010	4.2	195.00	24	Yes
2011	3.5	180.00	27	No
2012	3.2	187.00	27	Yes
2013	4.9	158.00	29	Yes
2014	4.2	223.00	24	Yes
2015	2.5	172.00	23	Yes
2016	2.9	166.00	25	Yes
2017	4.5	177.00	25	Yes
2018	1.6	170.00	24	Yes
2019	2.4	217.00	26	Yes
2020	2.6	195.00	27	Yes
2021	1.6	167.00	28	Yes
2022	5	173.00	28	Yes
2023	4	157.00	29	No
2024	1.4	171.00	26	No
2025	3.8	224.00	24	Yes
2026	3.3	210.00	25	Yes
2027	2.2	199.00	25	Yes
2028	3.8	218.00	28	Yes
2029	2.2	166.00	26	Yes
2030	3.7	215.00	27	Yes

TYPE 3 DETECTION PROBABILITY

Data Sheet for FCC Short Pulse Radar Type 3				
Waveform	Pulse Width (us)	PRI (us)	Pulses Per Burst	Successful Detection (Yes/No)
3001	8.7	296.00	18	Yes
3002	8	432.00	18	Yes
3003	6	440.00	16	Yes
3004	9.8	482.00	17	Yes
3005	5.6	296.00	18	Yes
3006	8.8	278.00	17	Yes
3007	7.6	483.00	16	Yes
3008	6.5	463.00	17	Yes
3009	8	345.00	17	Yes
3010	9.5	455.00	18	Yes
3011	8.9	369.00	16	Yes
3012	5.8	258.00	18	Yes
3013	8.2	328.00	17	Yes
3014	7.6	443.00	16	Yes
3015	5.4	289.00	18	Yes
3016	7.6	263.00	17	Yes
3017	6.6	439.00	18	Yes
3018	5.3	331.00	16	Yes
3019	6.8	331.00	17	Yes
3020	8	460.00	16	Yes
3021	6.2	428.00	18	Yes
3022	7.2	488.00	18	Yes
3023	9.3	439.00	16	Yes
3024	8.4	378.00	17	Yes
3025	7.5	432.00	16	Yes
3026	5	289.00	16	Yes
3027	9.4	287.00	18	Yes
3028	6.9	311.00	18	Yes
3029	9.9	487	17	Yes
3030	9.1	403	16	Yes

TYPE 4 DETECTION PROBABILITY

Data Sheet for FCC Short Pulse Radar Type 4				
Waveform	Pulse Width (us)	PRI (us)	Pulses Per Burst	Successful Detection (Yes/No)
4001	14.1	325.00	12	No
4002	18.3	473.00	15	No
4003	15	355.00	12	Yes
4004	13.3	251.00	16	Yes
4005	15	308.00	12	Yes
4006	11.2	363.00	15	Yes
4007	14.9	271.00	12	Yes
4008	18.3	291.00	13	Yes
4009	15	434.00	12	Yes
4010	15.6	269.00	16	Yes
4011	18.8	363.00	12	Yes
4012	15.1	488.00	14	Yes
4013	11.5	476.00	13	Yes
4014	15.1	413.00	14	Yes
4015	15	495.00	14	Yes
4016	16.9	466.00	13	Yes
4017	19.1	319.00	16	Yes
4018	10.3	337.00	13	Yes
4019	16.1	382.00	16	Yes
4020	17	316.00	12	Yes
4021	19.3	376.00	13	No
4022	16.3	435.00	12	Yes
4023	12.3	407.00	13	Yes
4024	13.1	332.00	16	Yes
4025	12.3	448.00	16	Yes
4026	12.9	362.00	13	Yes
4027	11.6	449.00	14	No
4028	17.1	343.00	13	Yes
4029	14.6	314.00	14	Yes
4030	17.8	410.00	12	Yes

TYPE 5 DETECTION PROBABILITY

Data Sheet for FCC Long Pulse Radar Type 5	
Trial	Successful Detection (Yes/No)
1	Yes
2	No
3	Yes
4	Yes
5	Yes
6	No
7	Yes
8	Yes
9	Yes
10	Yes
11	Yes
12	No
13	Yes
14	Yes
15	No
16	Yes
17	Yes
18	Yes
19	Yes
20	Yes
21	Yes
22	Yes
23	Yes
24	Yes
25	Yes
26	Yes
27	Yes
28	Yes
29	Yes
30	Yes

Note: The Type 5 randomized parameters are shown in a separate document.

TYPE 6 DETECTION PROBABILITY

Data Sheet for FCC Hopping Radar Type 6				
1 us Pulse Width, 333 us PRI, 9 Pulses per Burst, 1 Burst per Hop				
NTIA August 2005 Hopping Sequence				
Trial	Starting Index Within Sequence	Signal Generator Frequency (MHz)	Hops within Detection BW	Successful Detection (Yes/No)
1	4	5485	14	Yes
2	479	5486	12	Yes
3	954	5487	10	Yes
4	1429	5488	13	Yes
5	1904	5489	14	Yes
6	2379	5490	12	Yes
7	2854	5491	14	Yes
8	3329	5492	13	Yes
9	3804	5493	14	Yes
10	4279	5494	10	Yes
11	4754	5495	12	Yes
12	5229	5496	8	Yes
13	5704	5497	8	Yes
14	6179	5498	13	Yes
15	6654	5499	9	Yes
16	7129	5500	15	Yes
17	7604	5501	12	Yes
18	8079	5502	8	Yes
19	8554	5503	11	Yes
20	9029	5504	7	Yes
21	9504	5505	12	Yes
22	9979	5506	11	Yes
23	10454	5507	9	Yes
24	10929	5508	11	Yes
25	11404	5509	12	Yes

TYPE 6 DETECTION PROBABILITY (CONT.)

26	11879	5510	8	Yes
27	12354	5511	12	Yes
28	12829	5512	10	Yes
29	13304	5513	12	Yes
30	13779	5514	8	Yes
31	14254	5515	10	Yes
32	14729	5516	18	Yes
33	15204	5517	10	Yes
34	15679	5518	13	Yes
35	16154	5519	13	Yes
36	16629	5520	9	Yes
37	17104	5521	10	Yes
38	17579	5522	13	Yes
39	18054	5523	10	Yes
40	18529	5524	13	Yes
41	19004	5525	6	Yes
42	19479	5526	11	Yes
43	19954	5527	9	Yes
44	20429	5528	9	Yes
45	20904	5529	11	Yes
46	21379	5530	11	Yes
47	21854	5531	12	Yes
48	22329	5532	9	Yes
49	22804	5533	9	Yes
50	23279	5534	12	Yes
51	23754	5535	14	Yes

5.4. RESULTS FOR 80 MHz BANDWIDTH

5.4.1. TEST CHANNEL

All tests were performed at a channel center frequency of 5530 MHz.

5.4.2. RADAR WAVEFORMS AND TRAFFIC

RADAR WAVEFORMS

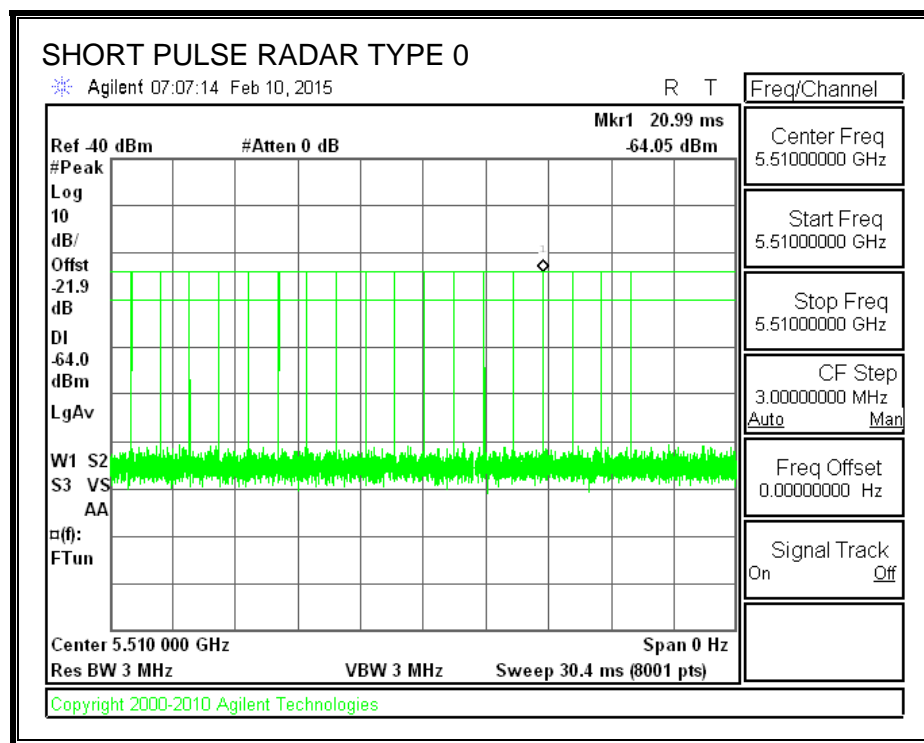

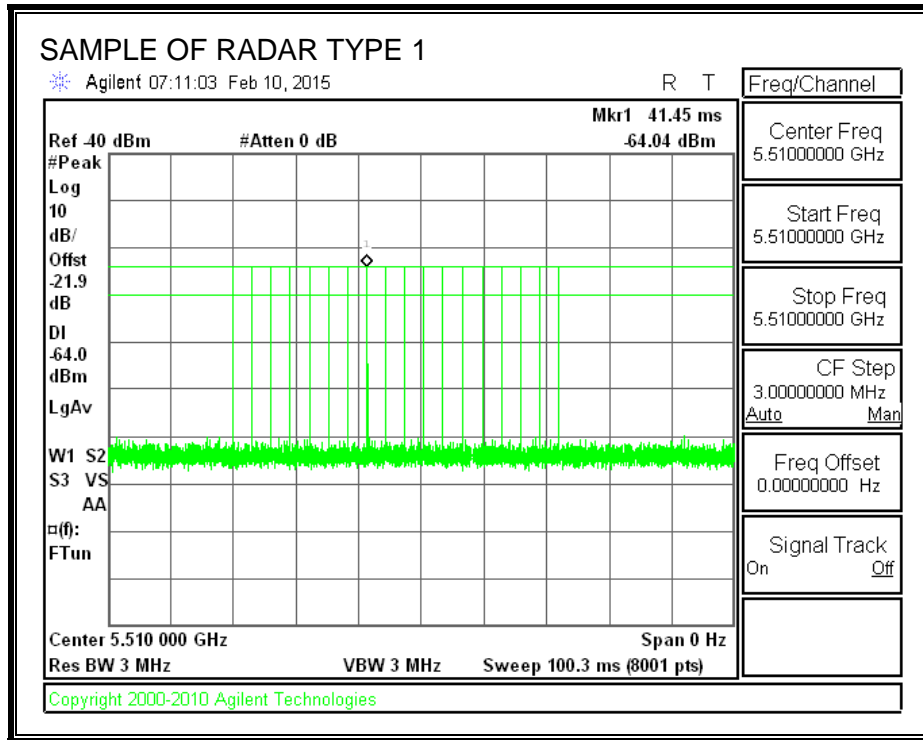

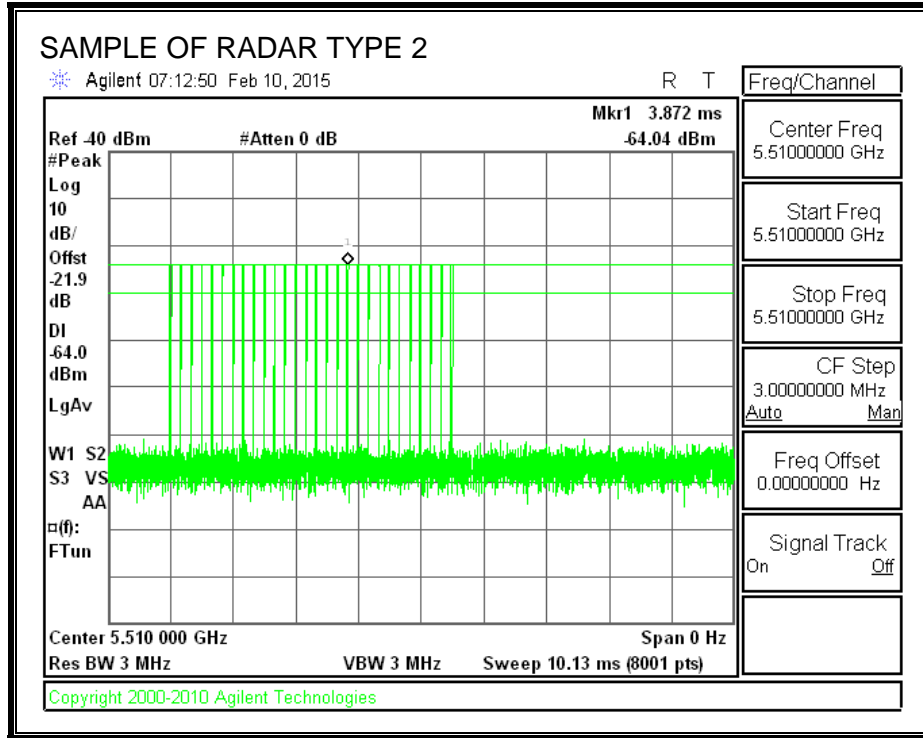

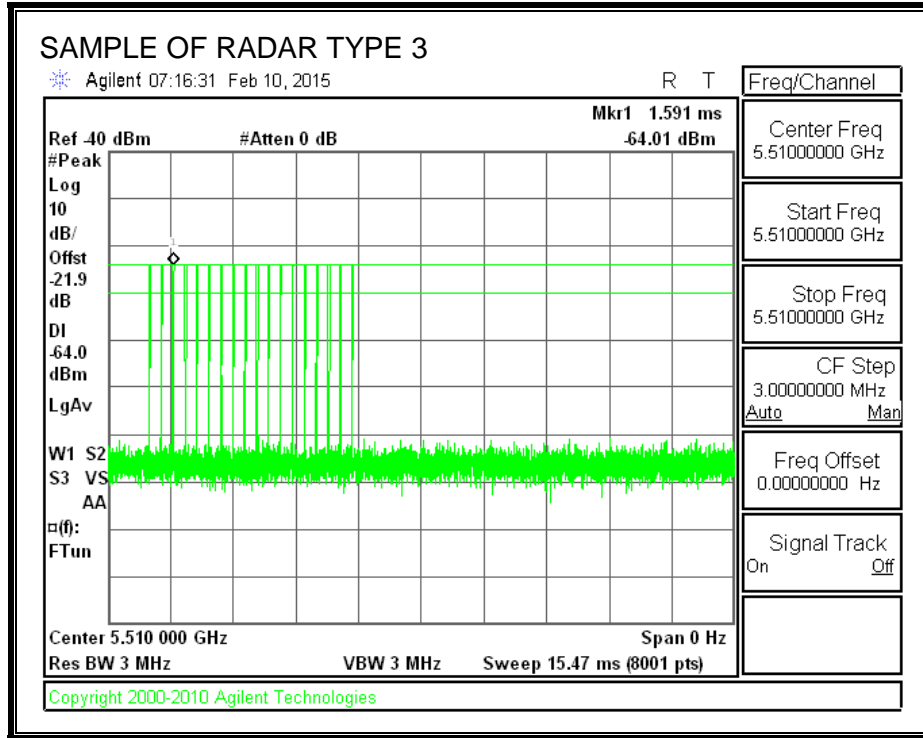

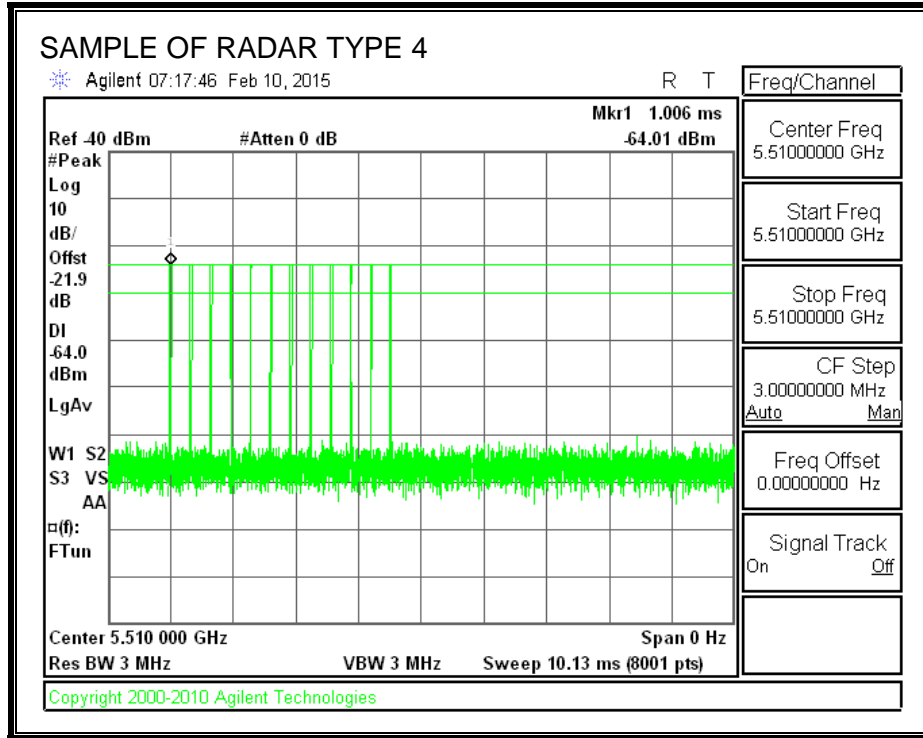

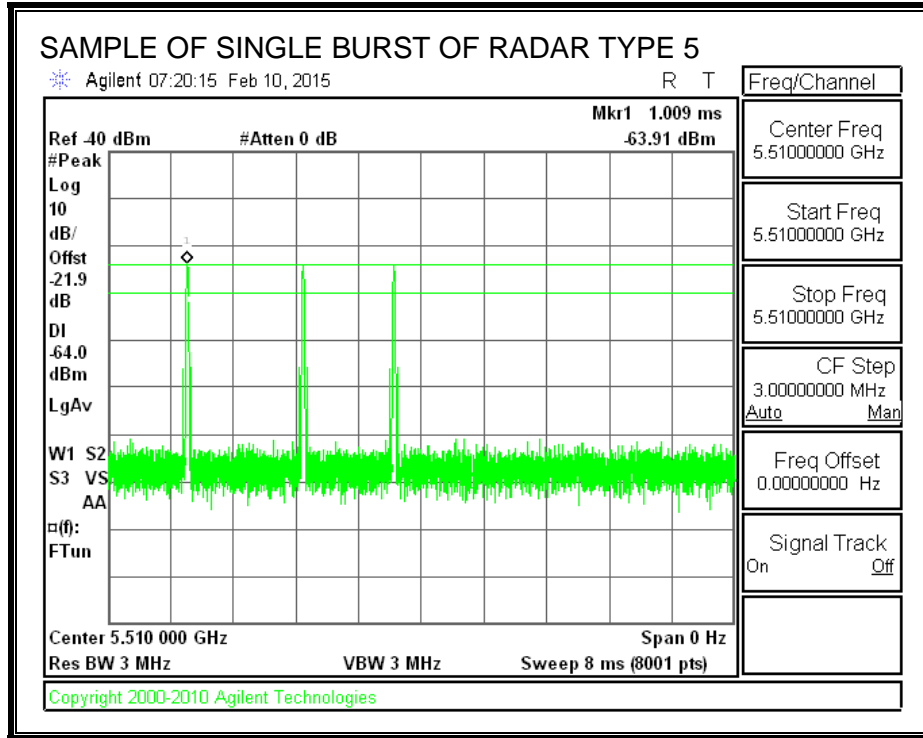

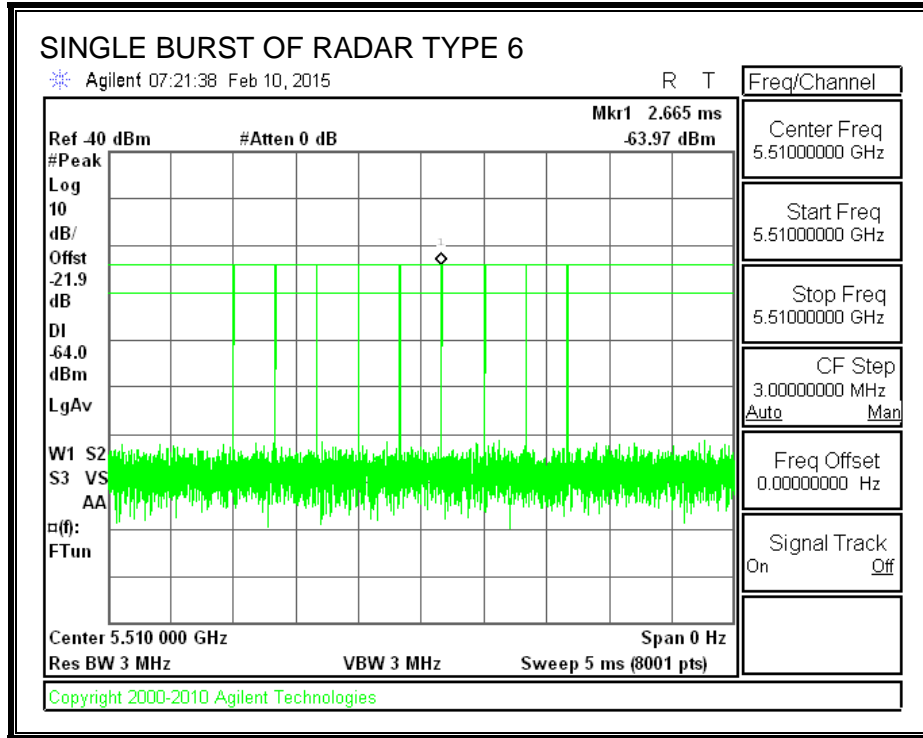

TRAFFIC

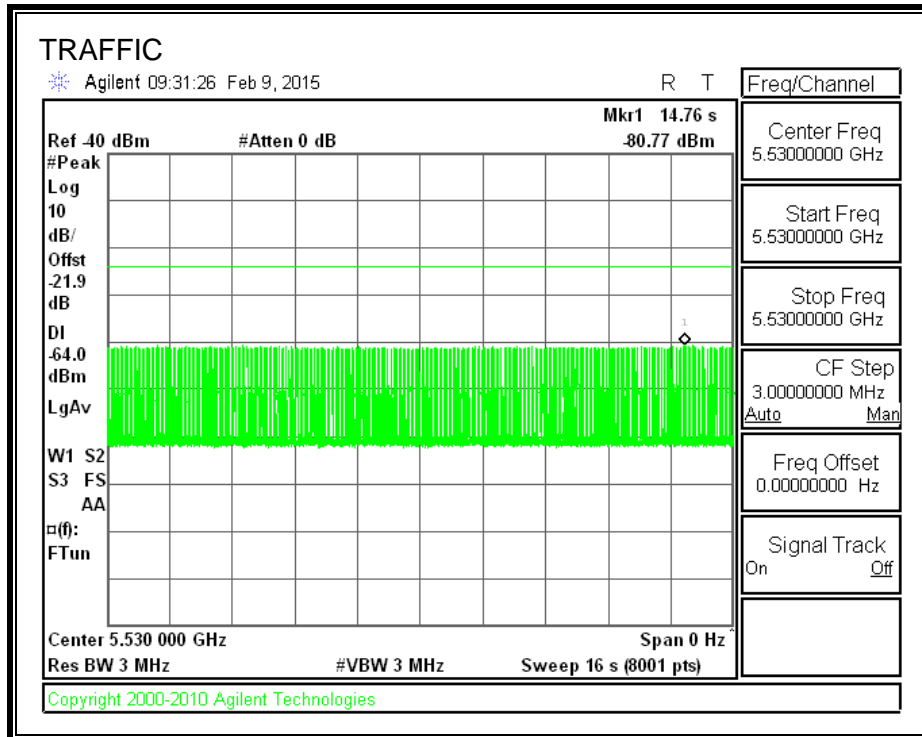

5.4.3. CHANNEL AVAILABILITY CHECK TIME

PROCEDURE TO DETERMINE INITIAL POWER-UP CYCLE TIME

A sweep was started on the spectrum analyzer when a software command was issued to the EUT to change to 5530 MHz and commence a CAC period. The time to the re-initialization of traffic was measured as the time required for the EUT to complete the CAC period.

PROCEDURE FOR TIMING OF RADAR BURST

A sweep was started on the spectrum analyzer when a software command was issued to the EUT to change to 5530 MHz and commence a CAC period. A radar signal was triggered within 0 to 6 seconds after the beginning of the CAC period and transmissions on the channel were monitored on the spectrum analyzer.

The Non-Occupancy list was cleared. A sweep was started on the spectrum analyzer when a software command was issued to the EUT to change to 5530 MHz and commence a CAC period. A radar signal was triggered within 54 to 60 seconds after the beginning of the CAC period and transmissions on the channel were monitored on the spectrum analyzer.

QUANTITATIVE RESULTS BASED UPON SPECTRUM ANALYZER PLOTS

No Radar Triggered

Beginning of CAC (sec)	Timing of Start of Traffic (sec)	CAC Period Time (sec)
0	59.45	59.45

Radar Near Beginning of CAC

Beginning of CAC (sec)	Timing of Radar Burst (sec)	Radar Relative to Start of CAC (sec)
0	2.475	2.475

Radar Near End of CAC

Beginning of CAC (sec)	Timing of Radar Burst (sec)	Radar Relative to Start of CAC (sec)
0	56.98	56.98

TIMING DIFFERENTIAL BETWEEN SPECTRUM ANALYZER PLOTS AND LOG FILE TIME STAMPS

A timing difference of up to one second occurred between the quantitative results based upon the captured spectrum analyzer plots and the log file time stamps can be attributed to the delay between the actual beginning of the EUT CAC period, reporting of the event and the initialization of the spectrum analyzer sweep. A CAC period of 60 seconds is confirmed by the time stamps provided by the log files.

QUANTITATIVE RESULTS BASED ON LOG FILE TIME STAMPS

No Radar Triggered

Beginning of CAC (hh:mm:ss)	End of CAC (hh:mm:ss)	CAC Time (hh:mm:ss)
11:22:27	11:23:27	0:01:00

Radar Near Beginning of CAC

Beginning of CAC (hh:mm:ss)	Radar Detected (hh:mm:ss)	Radar Relative to Start of CAC (hh:mm:ss)
11:29:00	11:29:03	0:00:03

Radar Near End of CAC

Beginning of CAC (hh:mm:ss)	Radar Detected (hh:mm:ss)	Radar Relative to Start of CAC (hh:mm:ss)
11:33:59	11:34:57	0:00:58

QUALITATIVE RESULTS

Timing of Radar Burst	Display on Control Computer	Spectrum Analyzer Display
No Radar Triggered	EUT marks Channel as active	Transmissions begin on channel after completion of the initial power-up cycle and the CAC
Within 0 to 6 second window	EUT indicates radar detected	No transmissions on channel
Within 54 to 60 second window	EUT indicates radar detected	No transmissions on channel

TIMING WITHOUT RADAR DURING CAC

Command to
Switch Channels
Start of CAC

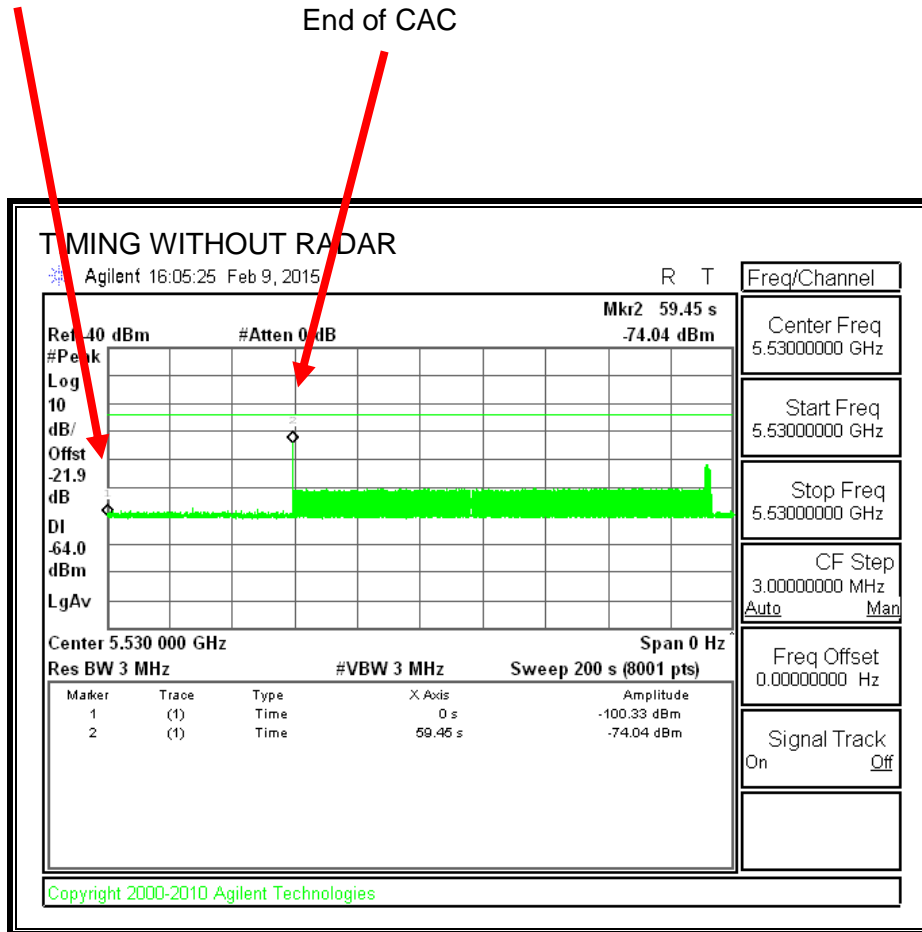

Transmissions begin on channel after completion of the CAC period.

Log File of CAC Timing Without Radar

Jan 06 11:22:27 2015: DOT11: %%%>dfs:DFS event 'channel avail check',
channel 100, recvd by rim:R1, channel 100, state 'chan

Jan 06 11:23:27 2015: DOT11: %%%>dfs:DFS event 'in service monitoring',
channel 100, recvd by rim:R1, channel k

TIMING WITH RADAR NEAR BEGINNING OF CAC

Command to
Switch Channels
Start of CAC

Radar Signal Applied

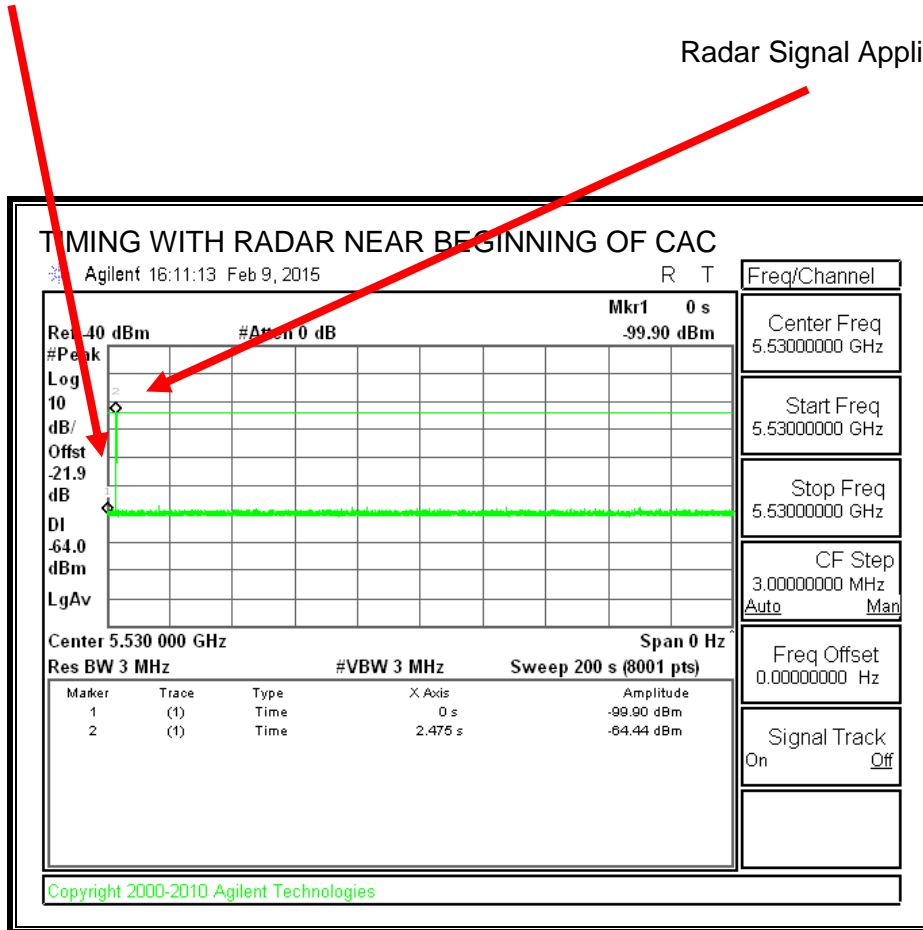

No EUT transmissions were observed after the radar signal.

Log File of Radar at the Beginning of CAC

Jan 06 11:29:00 2015: DOT11: %%%>dfs:DFS event 'channel avail check',
channel 100, recvd by rim:R1, channel 100, state 'chan

Jan 06 11:29:03 2015: KERN: w11: dfs : state PRE-ISM Channel Availability
Check, detected radar in channel 106.

TIMING WITH RADAR NEAR END OF CAC

Command to
Switch Channels
Start of CAC

Radar Signal Applied

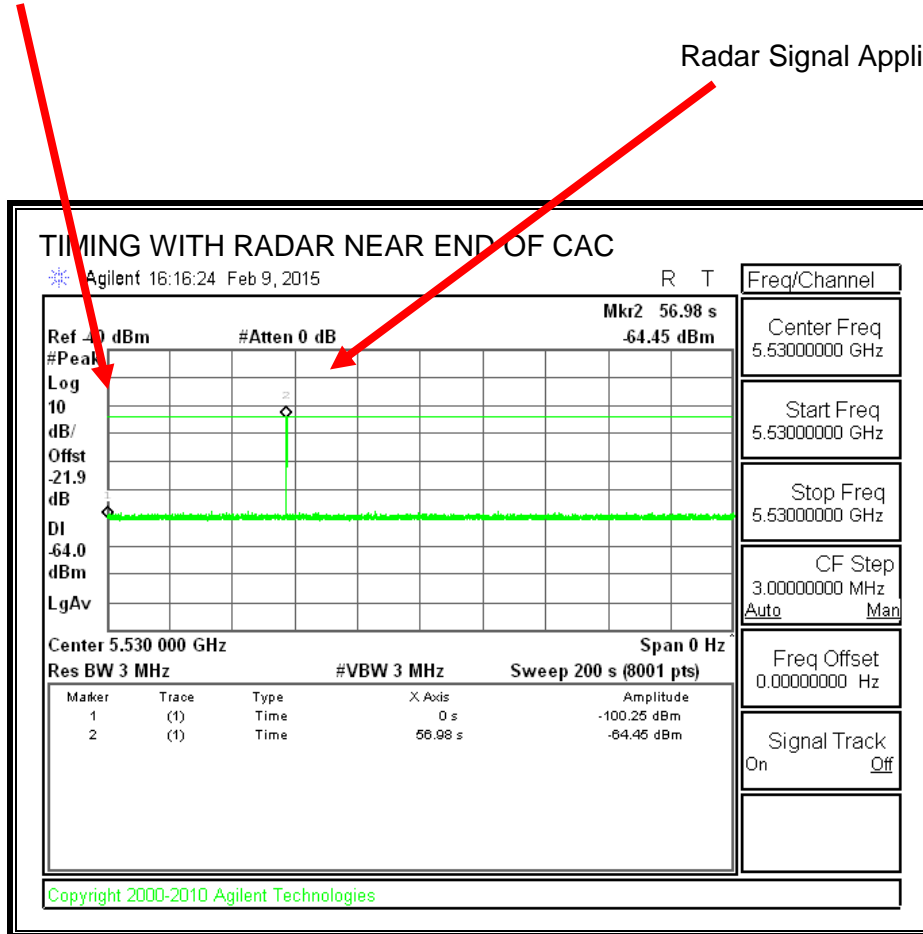

No EUT transmissions were observed after the radar signal.

Log File of Radar at the End of CAC

Jan 06 11:33:59 2015: DOT11: %%%>dfs:DFS event 'channel avail check',
channel 100, recvd by rim:R1, channel 100, state 'chan

Jan 06 11:34:57 2015: KERN: WL1: DFS: UNCLASSIFIED ##### radar detected
on channel 100/80 ##### Intv=28560, min_pw=.

5.4.4. OVERLAPPING CHANNEL TESTS

RESULTS

The channel spacing is not less than the channel bandwidth therefore the EUT does not have an overlapping channel plan.

5.4.5. MOVE AND CLOSING TIME

REPORTING NOTES

The reference marker is set at the end of last radar pulse.

The delta marker is set at the end of the last WLAN transmission following the radar pulse. This delta is the channel move time.

The aggregate channel closing transmission time is calculated as follows:

Aggregate Transmission Time =
(Number of analyzer bins showing transmission) * (dwell time per bin)

The observation period over which the aggregate time is calculated begins at (Reference Marker + 200 msec) and ends no earlier than (Reference Marker + 10 sec).

RESULTS

Channel Move Time (sec)	Limit (sec)
0.480	10

Aggregate Channel Closing Transmission Time (msec)	Limit (msec)
2.0	60

MOVE TIME

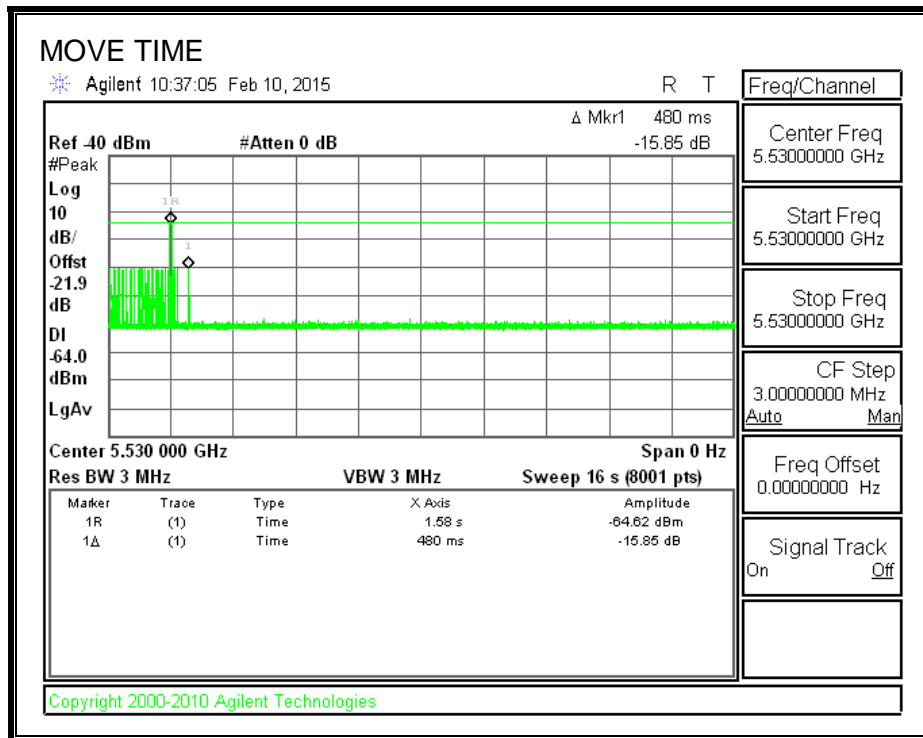

CHANNEL CLOSING TIME

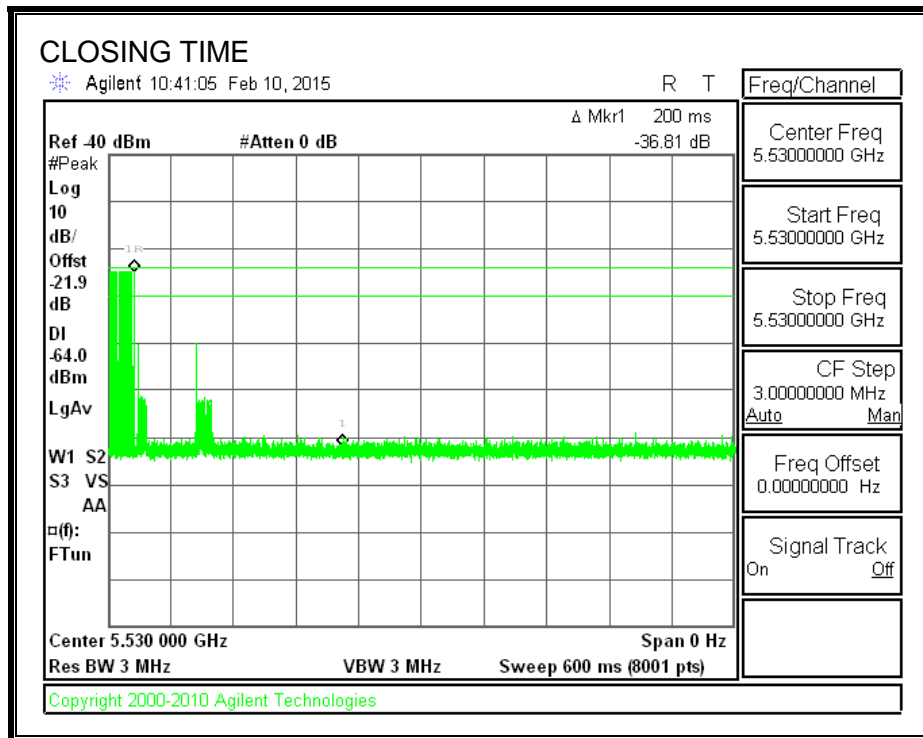

AGGREGATE CHANNEL CLOSING TRANSMISSION TIME

Only intermittent transmissions are observed during the aggregate monitoring period.

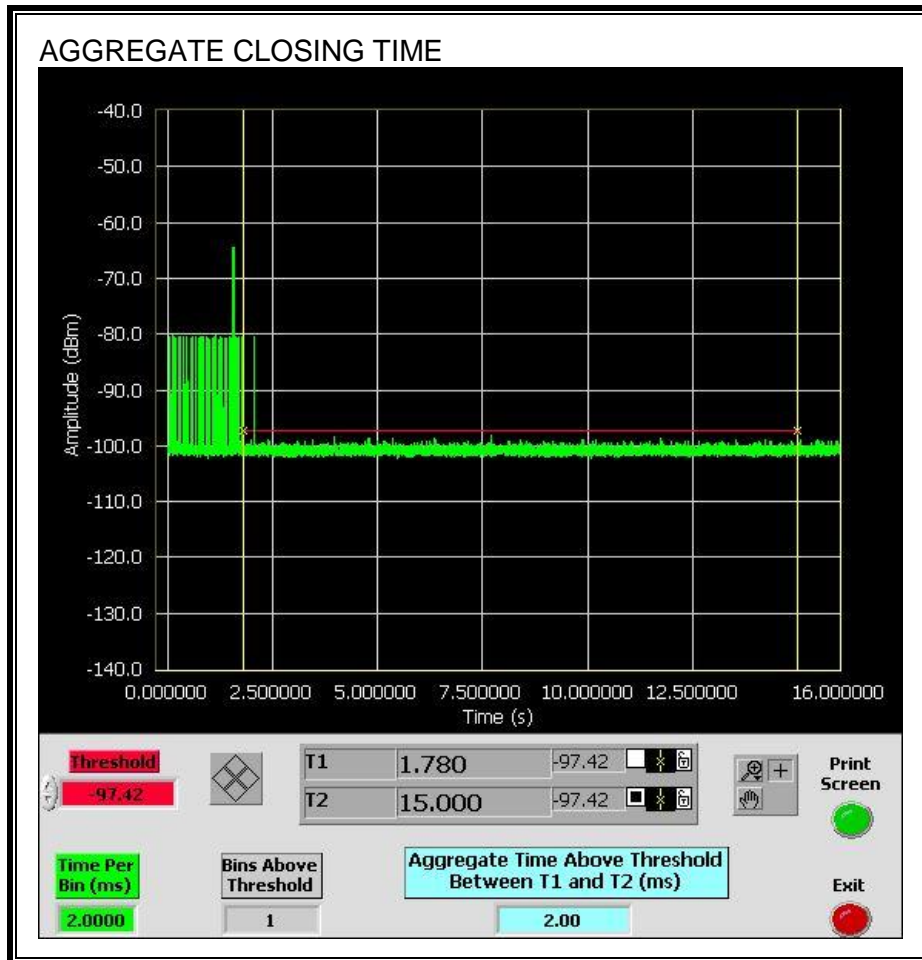

LONG PULSE CHANNEL MOVE TIME

The traffic ceases prior to 10 seconds after the end of the radar waveform.

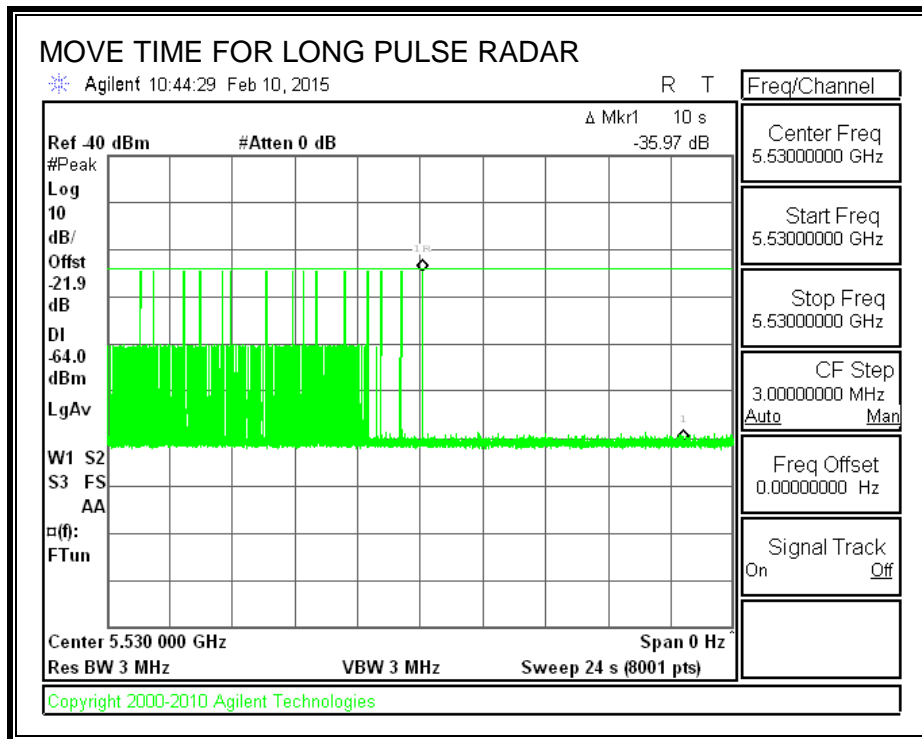

5.4.6. NON-OCCUPANCY PERIOD

RESULTS

No EUT transmissions were observed on the test channel during the 30-minute observation time.

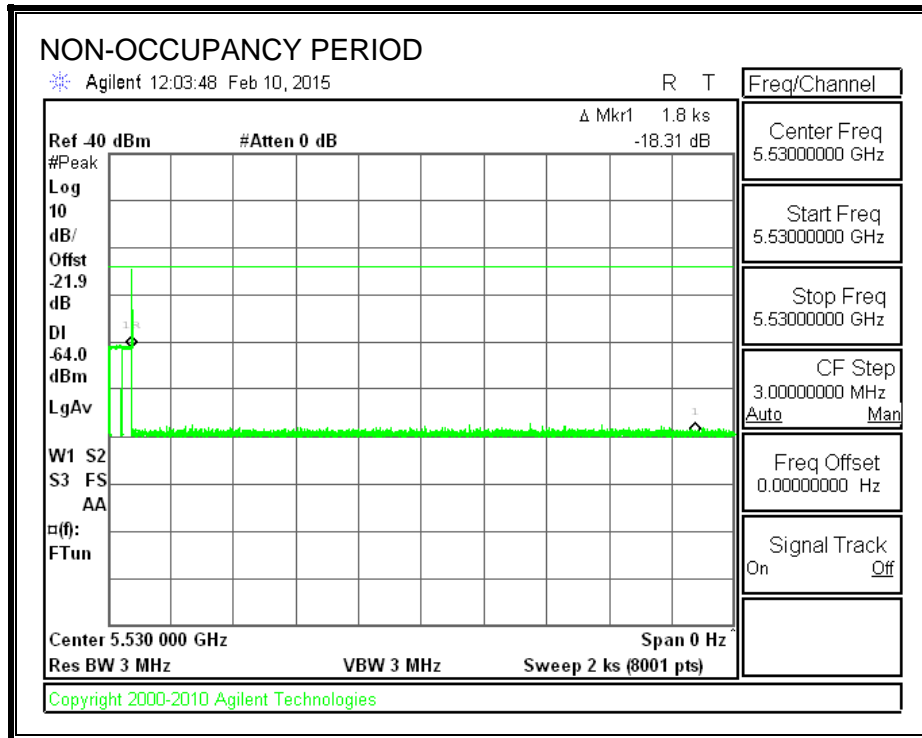

5.4.7. DETECTION BANDWIDTH

REFERENCE PLOT OF 99% POWER BANDWIDTH

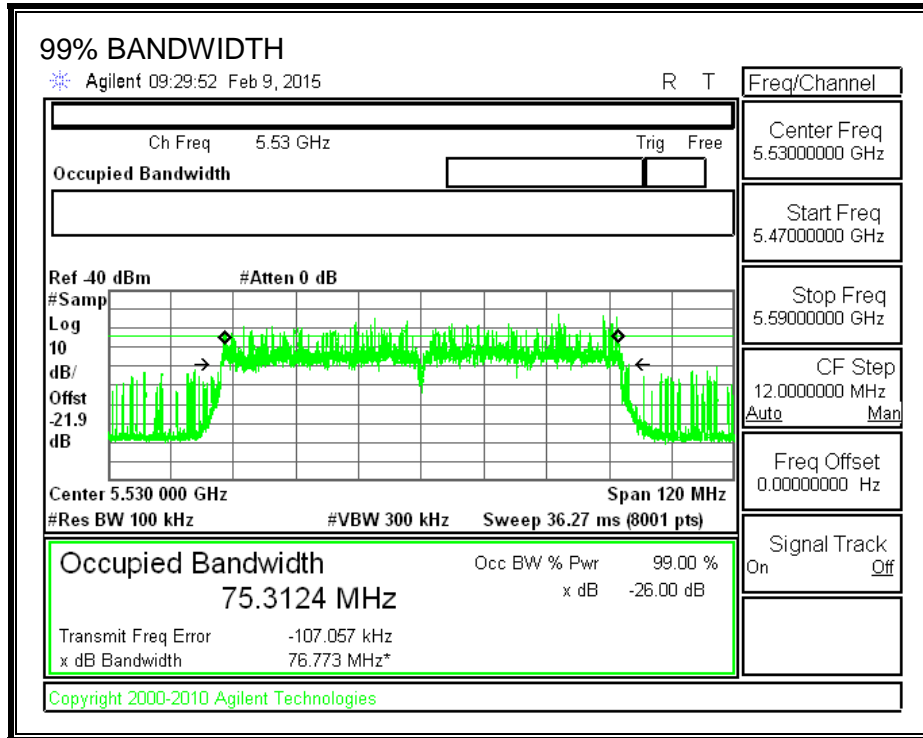

RESULTS

FL	FH	Detection Bandwidth	99% Power Bandwidth	Ratio of Detection BW to 99% Power BW	Minimum Limit
(MHz)	(MHz)	(MHz)	(MHz)	(%)	(%)
5484	5574	90	75.312	119.5	100

DETECTION BANDWIDTH PROBABILITY

Detection Bandwidth Test Results				
FCC Type 0 Waveform: 1 us Pulse Width, 1428 us PRI, 18 Pulses per Burst				
Frequency (MHz)	Number of Trials	Number Detected	Detection (%)	Mark
5483	10	0	0	
5484	10	10	100	FL
5485	10	10	100	
5490	10	10	100	
5495	10	10	100	
5500	10	9	90	
5505	10	10	100	
5510	10	10	100	
5515	10	10	100	
5520	10	10	100	
5525	10	10	100	
5530	10	10	100	
5535	10	10	100	
5540	10	10	100	
5545	10	10	100	
5550	10	10	100	
5555	10	10	100	
5560	10	10	100	
5565	10	10	100	
5570	10	10	100	
5571	10	10	100	
5572	10	10	100	
5573	10	10	100	
5574	10	10	100	FH
5575	10	4	40	

5.4.8. IN-SERVICE MONITORING

RESULTS

FCC Radar Test Summary				
Signal Type	Number of Trials	Detection (%)	Limit (%)	Pass/Fail
FCC Short Pulse Type 1	30	100.00	60	Pass
FCC Short Pulse Type 2	30	93.33	60	Pass
FCC Short Pulse Type 3	30	83.33	60	Pass
FCC Short Pulse Type 4	30	73.33	60	Pass
Aggregate		87.50	80	Pass
FCC Long Pulse Type 5	30	90.00	80	Pass
FCC Hopping Type 6	91	100.00	70	Pass

TYPE 1 DETECTION PROBABILITY

Data Sheet for FCC Short Pulse Radar Type 1				
1 us Pulse Width				
Waveform	PRI (us)	Pulses Per Burst	Test (A/B)	Successful Detection (Yes/No)
1001	3066	18	A	Yes
1002	738	72	A	Yes
1003	798	67	A	Yes
1004	638	83	A	Yes
1005	858	62	A	Yes
1006	778	68	A	Yes
1007	818	65	A	Yes
1008	698	76	A	Yes
1009	918	58	A	Yes
1010	538	99	A	Yes
1011	618	86	A	Yes
1012	938	57	A	Yes
1013	678	78	A	Yes
1014	578	92	A	Yes
1015	598	89	A	Yes
1016	838	63	B	Yes
1017	2778	19	B	Yes
1018	2512	22	B	Yes
1019	889	60	B	Yes
1020	1755	31	B	Yes
1021	2980	18	B	Yes
1022	1984	27	B	Yes
1023	1595	34	B	Yes
1024	974	55	B	Yes
1025	1393	38	B	Yes
1026	1120	48	B	Yes
1027	1149	46	B	Yes
1028	711	75	B	Yes
1029	2236	24	B	Yes
1030	1963	27	B	Yes

TYPE 2 DETECTION PROBABILITY

Data Sheet for FCC Short Pulse Radar Type 2				
Waveform	Pulse Width (us)	PRI (us)	Pulses Per Burst	Successful Detection (Yes/No)
2001	3.4	169.00	28	Yes
2002	2.3	208.00	25	Yes
2003	2	179.00	27	Yes
2004	4.8	193.00	25	Yes
2005	1	187.00	23	Yes
2006	3.7	154.00	27	Yes
2007	1.7	153.00	24	Yes
2008	4.5	196.00	25	Yes
2009	4.9	151.00	26	No
2010	4.2	195.00	24	Yes
2011	3.5	180.00	27	Yes
2012	3.2	187.00	27	Yes
2013	4.9	158.00	29	Yes
2014	4.2	223.00	24	Yes
2015	2.5	172.00	23	Yes
2016	2.9	166.00	25	Yes
2017	4.5	177.00	25	Yes
2018	1.6	170.00	24	No
2019	2.4	217.00	26	Yes
2020	2.6	195.00	27	Yes
2021	1.6	167.00	28	Yes
2022	5	173.00	28	Yes
2023	4	157.00	29	Yes
2024	1.4	171.00	26	Yes
2025	3.8	224.00	24	Yes
2026	3.3	210.00	25	Yes
2027	2.2	199.00	25	Yes
2028	3.8	218.00	28	Yes
2029	2.2	166.00	26	Yes
2030	3.7	215.00	27	Yes

TYPE 3 DETECTION PROBABILITY

Data Sheet for FCC Short Pulse Radar Type 3				
Waveform	Pulse Width (us)	PRI (us)	Pulses Per Burst	Successful Detection (Yes/No)
3001	8.7	296.00	18	Yes
3002	8	432.00	18	Yes
3003	6	440.00	16	Yes
3004	9.8	482.00	17	Yes
3005	5.6	296.00	18	Yes
3006	8.8	278.00	17	No
3007	7.6	483.00	16	No
3008	6.5	463.00	17	No
3009	8	345.00	17	No
3010	9.5	455.00	18	No
3011	8.9	369.00	16	Yes
3012	5.8	258.00	18	Yes
3013	8.2	328.00	17	Yes
3014	7.6	443.00	16	Yes
3015	5.4	289.00	18	Yes
3016	7.6	263.00	17	Yes
3017	6.6	439.00	18	Yes
3018	5.3	331.00	16	Yes
3019	6.8	331.00	17	Yes
3020	8	460.00	16	Yes
3021	6.2	428.00	18	Yes
3022	7.2	488.00	18	Yes
3023	9.3	439.00	16	Yes
3024	8.4	378.00	17	Yes
3025	7.5	432.00	16	Yes
3026	5	289.00	16	Yes
3027	9.4	287.00	18	Yes
3028	6.9	311.00	18	Yes
3029	9.9	487	17	Yes
3030	9.1	403	16	Yes

TYPE 4 DETECTION PROBABILITY

Data Sheet for FCC Short Pulse Radar Type 4				
Waveform	Pulse Width (us)	PRI (us)	Pulses Per Burst	Successful Detection (Yes/No)
4001	14.1	325.00	12	No
4002	18.3	473.00	15	Yes
4003	15	355.00	12	Yes
4004	13.3	251.00	16	Yes
4005	15	308.00	12	Yes
4006	11.2	363.00	15	Yes
4007	14.9	271.00	12	Yes
4008	18.3	291.00	13	Yes
4009	15	434.00	12	Yes
4010	15.6	269.00	16	Yes
4011	18.8	363.00	12	Yes
4012	15.1	488.00	14	Yes
4013	11.5	476.00	13	Yes
4014	15.1	413.00	14	Yes
4015	15	495.00	14	Yes
4016	16.9	466.00	13	No
4017	19.1	319.00	16	No
4018	10.3	337.00	13	No
4019	16.1	382.00	16	No
4020	17	316.00	12	No
4021	19.3	376.00	13	No
4022	16.3	435.00	12	No
4023	12.3	407.00	13	Yes
4024	13.1	332.00	16	Yes
4025	12.3	448.00	16	Yes
4026	12.9	362.00	13	Yes
4027	11.6	449.00	14	Yes
4028	17.1	343.00	13	Yes
4029	14.6	314.00	14	Yes
4030	17.8	410.00	12	Yes

TYPE 5 DETECTION PROBABILITY

Data Sheet for FCC Long Pulse Radar Type 5	
Trial	Successful Detection (Yes/No)
1	Yes
2	Yes
3	No
4	Yes
5	Yes
6	Yes
7	Yes
8	Yes
9	Yes
10	Yes
11	Yes
12	Yes
13	Yes
14	No
15	Yes
16	Yes
17	Yes
18	Yes
19	Yes
20	Yes
21	No
22	Yes
23	Yes
24	Yes
25	Yes
26	Yes
27	Yes
28	Yes
29	Yes
30	Yes

Note: The Type 5 randomized parameters are shown in a separate document.

TYPE 6 DETECTION PROBABILITY

Data Sheet for FCC Hopping Radar Type 6				
1 us Pulse Width, 333 us PRI, 9 Pulses per Burst, 1 Burst per Hop				
NTIA August 2005 Hopping Sequence				
Trial	Starting Index Within Sequence	Signal Generator Frequency (MHz)	Hops within Detection BW	Successful Detection (Yes/No)
1	53	5484	18	Yes
2	528	5485	22	Yes
3	1003	5486	20	Yes
4	1478	5487	21	Yes
5	1953	5488	27	Yes
6	2428	5489	19	Yes
7	2903	5490	18	Yes
8	3378	5491	22	Yes
9	3853	5492	22	Yes
10	4328	5493	14	Yes
11	4803	5494	21	Yes
12	5278	5495	21	Yes
13	5753	5496	26	Yes
14	6228	5497	23	Yes
15	6703	5498	13	Yes
16	7178	5499	19	Yes
17	7653	5500	17	Yes
18	8128	5501	19	Yes
19	8603	5502	14	Yes
20	9078	5503	19	Yes
21	9553	5504	21	Yes
22	10028	5505	22	Yes
23	10503	5506	15	Yes
24	10978	5507	17	Yes
25	11453	5508	18	Yes
26	11928	5509	20	Yes
27	12403	5510	17	Yes
28	12878	5511	22	Yes
29	13353	5512	26	Yes
30	13828	5513	19	Yes
31	14303	5514	16	Yes
32	14778	5515	14	Yes
33	15253	5516	21	Yes
34	15728	5517	21	Yes
35	16203	5518	18	Yes
36	16678	5519	17	Yes
37	17153	5520	22	Yes

TYPE 6 DETECTION PROBABILITY (CONTINUED)

38	17628	5521	21	Yes
39	18103	5522	17	Yes
40	18578	5523	21	Yes
41	19053	5524	13	Yes
42	19528	5525	21	Yes
43	20003	5526	16	Yes
44	20478	5527	25	Yes
45	20953	5528	21	Yes
46	21428	5529	23	Yes
47	21903	5530	24	Yes
48	22378	5531	14	Yes
49	22853	5532	20	Yes
50	23328	5533	21	Yes
51	23803	5534	23	Yes
52	24278	5535	26	Yes
53	24753	5536	22	Yes
54	25228	5537	15	Yes
55	25703	5538	15	Yes
56	26178	5539	17	Yes
57	26653	5540	18	Yes
58	27128	5541	19	Yes
59	27603	5542	18	Yes
60	28078	5543	16	Yes
61	28553	5544	17	Yes
62	29028	5545	12	Yes
63	29503	5546	21	Yes
64	29978	5547	16	Yes
65	30453	5548	16	Yes
66	30928	5549	18	Yes
67	31403	5550	25	Yes
68	31878	5551	19	Yes
69	32353	5552	19	Yes
70	-32708	5553	16	Yes
71	-32233	5554	18	Yes
72	-31758	5555	21	Yes
73	-31283	5556	19	Yes
74	-30808	5557	12	Yes
75	-30333	5558	17	Yes
76	-29858	5559	13	Yes

TYPE 6 DETECTION PROBABILITY (CONTINUED)

77	-29383	5560	18	Yes
78	-28908	5561	18	Yes
79	-28433	5562	23	Yes
80	-27958	5563	18	Yes
81	-27483	5564	19	Yes
82	-27008	5565	17	Yes
83	-26533	5566	19	Yes
84	-26058	5567	26	Yes
85	-25583	5568	18	Yes
86	-25108	5569	21	Yes
87	-24633	5570	17	Yes
88	-24158	5571	15	Yes
89	-23683	5572	29	Yes
90	-23208	5573	13	Yes
91	-22733	5574	20	Yes

6. BRIDGE MODE RESULTS

Per KDB 905462, Section 5.1 (footnote 1):

Networks Access Points with Bridge and/or MESH modes of operation are permitted to operate in the DFS bands but must employ a DFS function. The functionality of the Bridge mode as specified in §15.403(a) must be validated in the DFS test report. Devices operating as relays must also employ DFS function. The method used to validate the functionality must be documented and validation data must be documented. Bridge mode can be validated by performing a test statistical performance check (Section 7.8.4) on any one of the radar types. This is an abbreviated test to verify DFS functionality. MESH mode operational methodology must be submitted in the application for certification for evaluation by the FCC.

This device does not support Bridge Mode, therefore this test was not performed.

7. SETUP PHOTOS

DYNAMIC FREQUENCY SELECTION MEASUREMENT SETUP

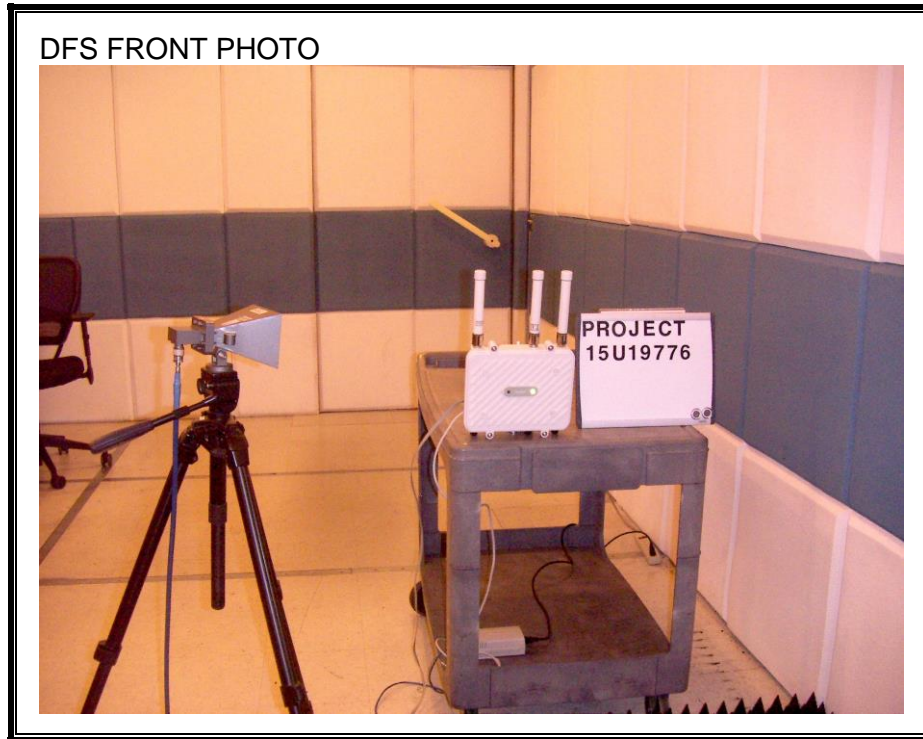



END OF REPORT