



FCC TEST REPORT (15.407)

REPORT NO.: RF940816H02

MODEL NO.: AP-5131

RECEIVED: Aug. 16, 2005

TESTED: Aug. 22 to Sep.25, 2005

ISSUED: Sep. 27, 2005

APPLICANT: Symbol Technologies Inc.

ADDRESS: One Symbol Plaza, Holtsville, NY 11742- 1300
U.S.A.

ISSUED BY: Advance Data Technology Corporation

TEST LOCATION: No. 81-1, Lu Liao Keng, 9 Ling, Wu Lung
Tsuen, Chiung Lin Hsiang, Hsin Chu Hsien,
Taiwan, R.O.C.

This test report consists of 127 pages in total. It may be duplicated completely for legal use with the approval of the applicant. It should not be reproduced except in full, without the written approval of our laboratory. The client should not use it to claim product endorsement by CNLA, A2LA or any government agencies. The test results in the report only apply to the tested sample. The test results in this report are traceable to the national or international standards.



0536

ILAC MRA



No. 2177-01



Table of Contents

1.	CERTIFICATION	5
2.	SUMMARY OF TEST RESULTS	6
3.	GENERAL INFORMATION.....	7
3.1	GENERAL DESCRIPTION OF EUT	7
3.2	DESCRIPTION OF TEST MODES.....	10
3.2.1	Test Mode Applicability AND TESTED CHANNEL DETAIL:.....	11
3.3	GENERAL DESCRIPTION OF APPLIED STANDARDS	13
3.4	DESCRIPTION OF SUPPORT UNITS	14
3.5	CONFIGURATION OF SYSTEM UNDER TEST	15
4.	TEST TYPES AND RESULTS	17
4.1	CONDUCTED EMISSION MEASUREMENT	17
4.1.1	LIMITS OF CONDUCTED EMISSION MEASUREMENT.....	17
4.1.2	TEST INSTRUMENTS	17
4.1.3	TEST PROCEDURES.....	18
4.1.4	DEVIATION FROM TEST STANDARD	18
4.1.5	TEST SETUP	19
4.1.6	EUT OPERATING CONDITIONS.....	19
4.1.7	TEST RESULTS.....	20
4.2	RADIATED EMISSION MEASUREMENT	24
4.2.1	LIMITS OF RADIATED EMISSION MEASUREMENT.....	24
4.2.2	LIMITS OF UNWANTED EMISSION OUT OF THE RESTRICTED BANDS	25
4.2.3	TEST INSTRUMENTS	26
4.2.4	TEST PROCEDURES.....	27
4.2.5	DEVIATION FROM TEST STANDARD	27
4.2.6	TEST SETUP	28
4.2.7	EUT OPERATING CONDITION	28
4.2.8	Test RESULTS (ANTENNA 1)	29
4.2.9	Test RESULTS (ANTENNA 2)	37
4.2.10	Test RESULTS (ANTENNA 3)	45
4.3	PEAK TRANSMIT POWER MEASUREMENT	53
4.3.1	LIMITS OF PEAK TRANSMIT POWER MEASUREMENT.....	53
4.3.2	TEST INSTRUMENTS	53
4.3.3	TEST PROCEDURE	54
4.3.4	DEVIATION FROM TEST STANDARD	54
4.3.5	TEST SETUP	54



4.3.6 EUT OPERATING CONDITIONS54

4.3.7 TEST RESULTS (ANTENNA 1).....55

4.3.8 TEST RESULTS (ANTENNA 2).....62

4.3.9 TEST RESULTS (ANTENNA 3).....69

4.4 PEAK POWER EXCURSION MEASUREMENT76

4.4.1 LIMITS OF PEAK POWER EXCURSION MEASUREMENT76

4.4.2 TEST INSTRUMENTS76

4.4.3 TEST PROCEDURE77

4.4.4 DEVIATION FROM TEST STANDARD77

4.4.5 TEST SETUP77

4.4.6 EUT OPERATING CONDITIONS77

4.4.7 TEST RESULTS (ANTENNA 1).....78

4.4.8 TEST RESULTS (ANTENNA 2).....82

4.4.9 TEST RESULTS (ANTENNA 3).....86

4.5 PEAK POWER SPECTRAL DENSITY MEASUREMENT90

4.5.1 LIMITS OF PEAK POWER SPECTRAL DENSITY MEASUREMENT90

4.5.2 TEST INSTRUMENTS90

4.5.3 TEST PROCEDURES91

4.5.4 DEVIATION FROM TEST STANDARD91

4.5.5 TEST SETUP91

4.5.6 EUT OPERATING CONDITIONS91

4.5.7 TEST RESULTS (ANTENNA 1).....92

4.5.8 TEST RESULTS (ANTENNA 2).....96

4.5.9 TEST RESULTS (ANTENNA 3).....100

4.6 FREQUENCY STABILITY104

4.6.1 LIMITS OF FREQUENCY STABILITY MEASUREMENT104

4.6.2 TEST INSTRUMENTS104

4.6.3 TEST PROCEDURE104

4.6.4 DEVIATION FROM TEST STANDARD105

4.6.5 TEST SETUP105

4.6.6 EUT OPERATING CONDITION105

4.6.7 TEST RESULTS (ANTENNA 1).....106

4.6.8 TEST RESULTS (ANTENNA 2).....107

4.6.9 TEST RESULTS (ANTENNA 3).....108

4.7 BAND EDGES MEASUREMENT109

4.7.1 TEST INSTRUMENTS109

4.7.2 TEST PROCEDURE109

4.7.3 EUT OPERATING CONDITION109

4.7.4 TEST RESULTS (ANTENNA 1)..... 110



4.7.5 TEST RESULTS (ANTENNA 2)..... 115

4.7.6 TEST RESULTS (ANTENNA 3).....120

4.8 ANTENNA REQUIREMENT125

4.8.1 STANDARD APPLICABLE125

4.8.2 ANTENNA CONNECTED CONSTRUCTION125

5. INFORMATION ON THE TESTING LABORATORIES126

APPENDIX-A.....A-1



1. CERTIFICATION

PRODUCT: Symbol WLAN 802.11abg Access Point
BRAND NAME: Symbol
MODEL NO.: AP-5131
PART NO.: AP-5131-44000-WW
TEST SAMPLE: ENGINEERING SAMPLE
TESTED: Aug. 22 to Sep.25, 2005
APPLICANT: Symbol Technologies Inc.
STANDARDS: FCC Part 15, Subpart E (Section 15.407)
 ANSI C63.4-2003

The above equipment (Model: AP-5131) has been tested by **Advance Data Technology Corporation**, and found compliance with the requirement of the above standards. The test record, data evaluation & Equipment Under Test (EUT) configurations represented herein are true and accurate accounts of the measurements of the sample's EMC characteristics under the conditions specified in this report.

PREPARED BY : Midoli Peng , **DATE:** Sep. 27, 2005
 (Midoli Peng)

TECHNICAL ACCEPTANCE : Hank Chung , **DATE:** Sep. 27, 2005
 Responsible for RF (Hank Chung)

APPROVED BY : May Chen , **DATE:** Sep. 27, 2005
 (May Chen, Deputy Manager)

2. SUMMARY OF TEST RESULTS

The EUT has been tested according to the following specifications:

APPLIED STANDARD: FCC Part 15, Subpart E (Section 15.407)			
Standard Section	Test Type	Result	Remark
15.407(b)(5)	AC Power Conducted Emission	PASS	Meet the requirement of limit. Minimum passing margin is -7.30dB at 0.529MHz
15.407(b/1/2/3)(b)(5)	Electric Field Strength Spurious Emissions, 30MHz ~ 40000MHz	PASS	Meet the requirement of limit. Minimum passing margin is -1.5dB at 5350.0MHz
15.407(a/1/2/3)	Peak Transmit Power	PASS	Meet the requirement of limit.
15.407(a)(6)	Peak Power Excursion	PASS	Meet the requirement of limit.
15.407(a/1/2/3)	Peak Power Spectral Density	PASS	Meet the requirement of limit.
15.407(g)	Frequency Stability	PASS	Meet the requirement of limit.

NOTE:

1. The EUT was operating in 2.412 ~ 2.462GHz, 5.150 ~ 5.350GHz and 5.725 ~ 5.850GHz frequencies band. This report was recorded the RF parameters including 5.150 ~ 5.350GHz and 5.725 ~ 5.825GHz. For the 2.412 ~ 2.462GHz and 5.725 ~ 5.850GHz RF parameters was recorded in another test report.

3. GENERAL INFORMATION

3.1 GENERAL DESCRIPTION OF EUT

EUT	Symbol WLAN 802.11abg Access Point
MODEL NO.	AP-5131
POWER SUPPLY	DC 48V from power adapter or POE (Power over Ethernet)
MODULATION TYPE	CCK, DQPSK, DBPSK for DSSS 64QAM, 16QAM, QPSK, BPSK for OFDM
MODULATION TECHNOLOGY	DSSS, OFDM
TRANSFER RATE	802.11b: 11/5.5/2/1Mbps 802.11g: 54/48/36/24/18/12/9/6Mbps 802.11a: 54/48/36/24/18/12/9/6Mbps
FREQUENCY RANGE	802.11b & 802.11g: 2412 ~ 2462MHz 802.11a: 5.15 ~ 5.35GHz and 5.725 ~ 5.850GHz
NUMBER OF CHANNEL	802.11b & 802.11g: 11 802.11a: 13
CHANNEL SPACING	802.11b & 802.11g: 5MHz 802.11a: 20MHz for Normal mode
OUTPUT POWER	Please see note 4 (on next page)
DATA CABLE	NA
ANTENNA TYPE	Please see note 3 (on next page)
I/O PORTS	Console Port x1, LAN Port x1, WAN Port x1
ASSOCIATED DEVICES	NA

NOTE:

1. The EUT operates in both the 5GHz and 2.4GHz Bands and compatibility with 802.11a and 802.11b, 802.11g technology.



2. The EUT was operated with the following power adapter or POE:

ADAPTER	
BRAND:	Symbol
MODEL:	50-24000-050
INPUT:	AC 100-250V, 0.4A max, 47-63Hz 16cm/ shield/ without core
OUTPUT:	DC 48V, 0.25A , 1.5m/ nonshield/ with one core

POE (for test only)	
BRAND:	Symbol
MODEL:	AP-PSBIAS-T-1P-AF
INPUT:	AC100~240V, 0.34~0.17A, 60/50Hz
OUTPUT:	DC 48V

3. There are six antennas provided to this EUT, please refer to the following table:

For 2.4GHz							
No.	Symbol P/N	Gain (dBi)	Cable Loss (dB)	Net Gain (dB)	Antenna Type	Connector	Remark
1	*ML-2452-APA2-01	3.0	0	3.0	Dipole	RP SMA	Omni
2	ML-2499-11PNA2-01	11.2	2.7	8.5	Panel	Reverse BNC	Directional
3	ML-2499-HPA3-01	4.6	1.3	3.3	Dipole	Reverse BNC	Omni
4	**ML-2499-BYGA2-01	14.2	0.3	13.9	Yagi	RP SMA	Directional

For 5GHz							
No.	Symbol P/N	Gain (dBi)	Cable Loss (dB)	Net Gain (dB)	Antenna Type	Connector	Remark
1	*ML-2452-APA2-01	4.0	0	4.0	Dipole	RP SMA	Omni
2	ML-5299-WPNA1-01	14.2	1.2	13.0	Patch	RP SMA	Directional
3	ML-5299-HPA1-01	5.9	0.84	5.0	Omni	RP SMA	Omni

Note:

- All of the above antennas are Indoor Antenna except the Symbol P/N: ML-2499-BYGA2-01.
- “*” is a Dual Band antenna can be used in both 2.4GHz and 5GHz.
- “**” is an Outdoor Antenna it can only be used in point-to-point applications.
- For 2.4GHz Antenna No. 2 and 3 were tested with Extend cable (0.5 dB loss).
- For 2.4GHz Antenna No. 4 was tested with Extend cable (0.5 dB loss) and Arrestor (1.0 dB loss).

4. Peak output power (Unit : dBm) :

No.	Symbol P/N (Antenna)	Operating Frequency (MHz)			
		2412~2462	5150~5250	5250~5350	5725~5850
1	ML-2452-APA2-01	21.88	16.33	23.03	18.93
2	ML-2499-11PNA2-01	21.88	NA	NA	NA
3	ML-2499-HPA3-01	21.88	NA	NA	NA
4	ML-2499-BYGA2-01	21.88	NA	NA	NA
5	ML-5299-WPNA1-01	NA	9.08	11.59	18.93
6	ML-5299-HPA1-01	NA	16.33	23.03	18.93

5. The above EUT information was declared by the manufacturer and for more detailed features description, please refer to the manufacturer's specifications or User's Manual.

3.2 DESCRIPTION OF TEST MODES

Twelve channels are provided to this EUT for normal mode.

Channel	Frequency
1	5180 MHz
2	5200 MHz
3	5220 MHz
4	5240 MHz
5	5260 MHz
6	5280 MHz
7	5300 MHz
8	5320 MHz
9	5745 MHz
10	5765 MHz
11	5785 MHz
12	5805 MHz



3.2.1 TEST MODE APPLICABILITY AND TESTED CHANNEL DETAIL:

EUT configure mode	Applicable to				Description
	PLC	RE<1G	RE≥1G	APCM	
-	X	X	X	X	NA

Where PLC: Power Line Conducted Emission RE<1G RE: Radiated Emission below 1GHz
 RE≥1G: Radiated Emission above 1GHz APCM: Antenna Port Conducted Measurement

Power Line Conducted Emission Test:

- Pre-Scan has been conducted to determine the worst-case mode from all possible combinations between available modulations, data rates and antenna ports (if EUT with antenna diversity architecture).
- Following channel(s) was (were) selected for the final test as listed below.

Mode	Available Channel	Tested Channel	Modulation Technology	Modulation Type	Data Rate (Mbps)
802.11a	1 to 12	12	OFDM	BPSK	6

Radiated Emission Test (Below 1 GHz):

- Pre-Scan has been conducted to determine the worst-case mode from all possible combinations between available modulations, data rates and antenna ports (if EUT with antenna diversity architecture).
- Following channel(s) was (were) selected for the final test as listed below.

Mode	Available Channel	Tested Channel	Modulation Technology	Modulation Type	Data Rate (Mbps)
802.11a	1 to 12	12	OFDM	BPSK	6

Radiated Emission Test (Above 1 GHz):

- Pre-Scan has been conducted to determine the worst-case mode from all possible combinations between available modulations, data rates and antenna ports (if EUT with antenna diversity architecture).
- Following channel(s) was (were) selected for the final test as listed below.

Mode	Available Channel	Tested Channel	Modulation Technology	Modulation Type	Data Rate (Mbps)
802.11a	1 to 12	1, 4, 5, 8, 9, 12	OFDM	BPSK	6



Bandedge Measurement:

- Pre-Scan has been conducted to determine the worst-case mode from all possible combinations between available modulations, data rates and antenna ports (if EUT with antenna diversity architecture).
- Following channel(s) was (were) selected for the final test as listed below.

Mode	Available Channel	Tested Channel	Modulation Technology	Modulation Type	Data Rate (Mbps)
802.11a	1 to 12	1, 4, 5, 8, 9, 12	OFDM	BPSK	6

Antenna Port Conducted Measurement:

- Pre-Scan has been conducted to determine the worst-case mode from all possible combinations between available modulations, data rates and antenna ports (if EUT with antenna diversity architecture).
- Following channel(s) was (were) selected for the final test as listed below.

Mode	Available Channel	Tested Channel	Modulation Technology	Modulation Type	Data Rate (Mbps)
802.11a	1 to 12	1, 4, 5, 8, 9, 12	OFDM	BPSK	6



3.3 GENERAL DESCRIPTION OF APPLIED STANDARDS

The EUT is a Symbol WLAN 802.11abg Access Point. According to the specifications of the manufacturer, it must comply with the requirements of the following standards:

FCC Part 15, Subpart E (15.407)

ANSI C63.4-2003

All test items have been performed and recorded as per the above standards.

NOTE: The EUT is also considered as a kind of computer peripheral, because the connection to computer is necessary for typical use. It has been verified to comply with the requirements of FCC Part 15, Subpart B, Class B (DoC). The test report has been issued separately.



3.4 DESCRIPTION OF SUPPORT UNITS

The EUT has been tested as an independent unit together with other necessary accessories or support units. The following support units or accessories were used to form a representative test configuration during the tests.

NO.	PRODUCT	BRAND	MODEL NO.	SERIAL NO.	FCC ID
1	NOTEBOOK COMPUTER	DELL	PP01L	TW-09c748- 12800-165-3171	FCC DoC
2	NOTEBOOK COMPUTER	DELL	PP01L	TW-0791UH- 12800-0CK-3735	FCC DoC
3	NOTEBOOK COMPUTER	DELL	PP05L	CN-04Y212- 48643-38E-0145	NA

NO.	SIGNAL CABLE DESCRIPTION OF THE ABOVE SUPPORT UNITS
1	NA
2	NA
3	NA

NOTE: All power cords of the above support units are non shielded (1.8m).

3.5 CONFIGURATION OF SYSTEM UNDER TEST

With adapter test mode :

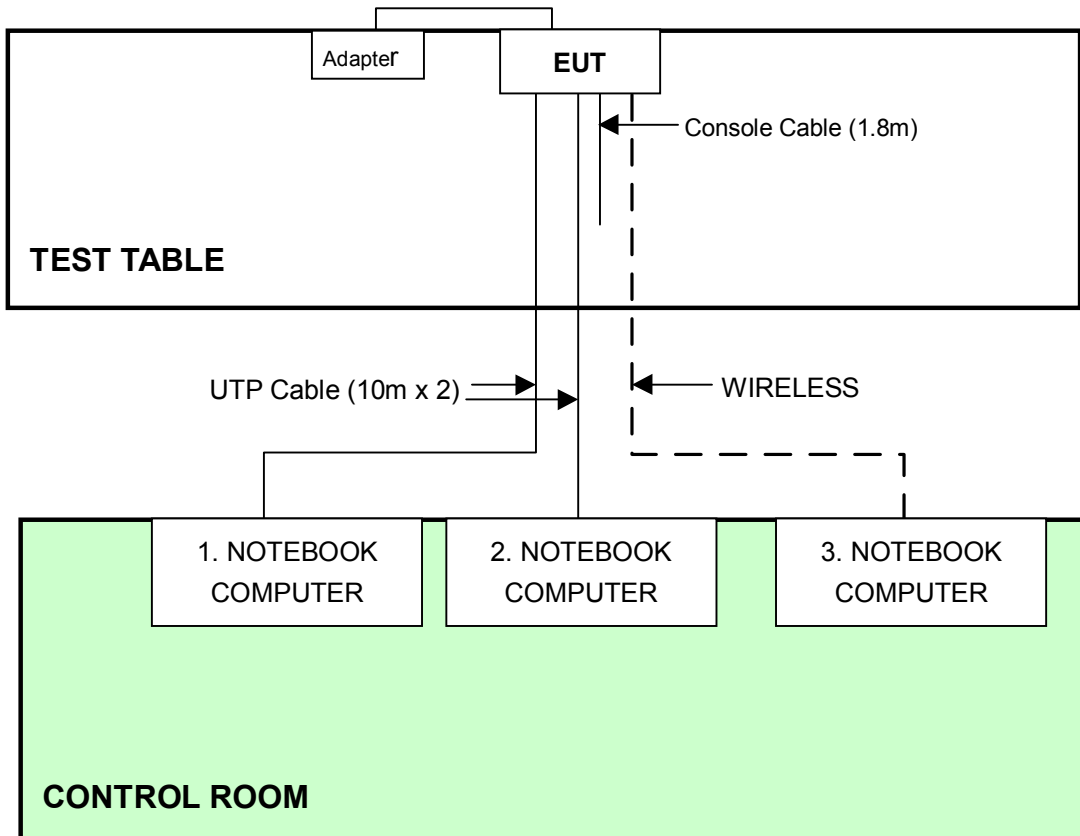

NOTE: 1. Support unit 1~3 were kept in the control room during the test.

With POE test mode :

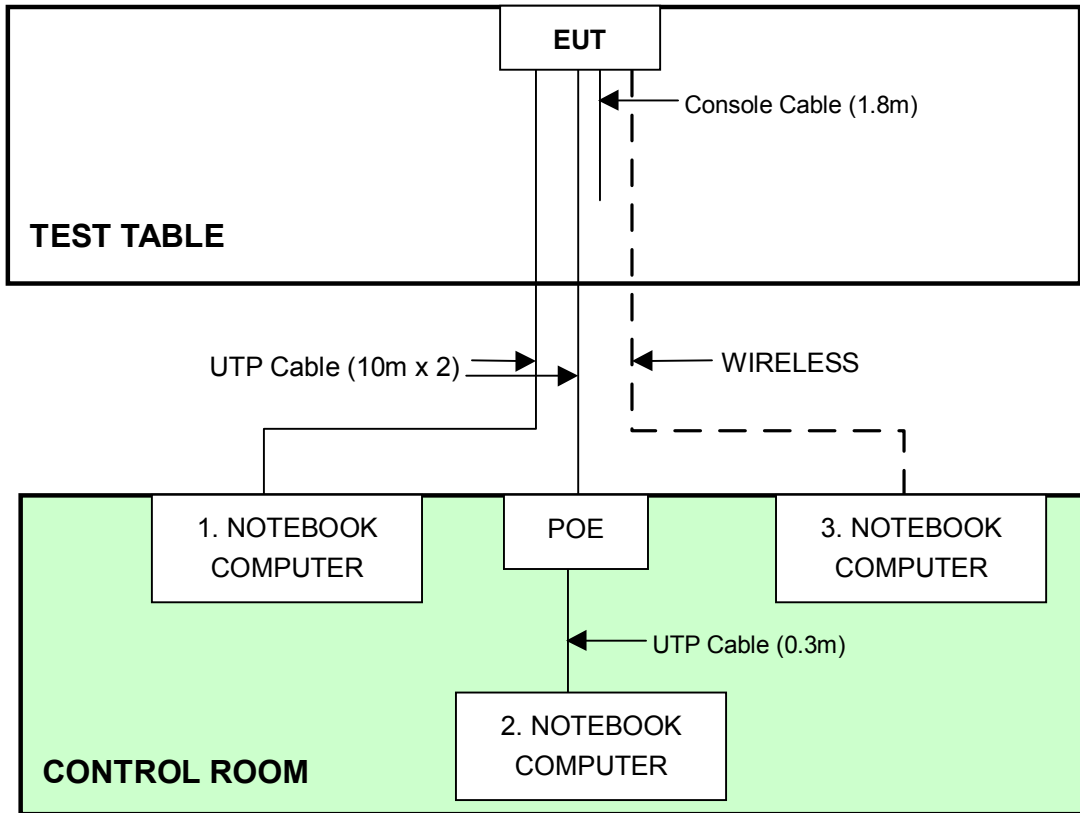

NOTE: 1. Support unit 1~3 were kept in the control room during the test.

4. TEST TYPES AND RESULTS

4.1 CONDUCTED EMISSION MEASUREMENT

4.1.1 LIMITS OF CONDUCTED EMISSION MEASUREMENT

FREQUENCY OF EMISSION (MHz)	CONDUCTED LIMIT (dB μ V)	
	Quasi-peak	Average
0.15-0.5	66 to 56	56 to 46
0.5-5	56	46
5-30	60	50

- NOTE:**
1. The lower limit shall apply at the transition frequencies.
 2. The limit decreases in line with the logarithm of the frequency in the range of 0.15 to 0.50 MHz.
 3. All emanations from a class A/B digital device or system, including any network of conductors and apparatus connected thereto, shall not exceed the level of field strengths specified above.

4.1.2 TEST INSTRUMENTS

DESCRIPTION & MANUFACTURER	MODEL NO.	SERIAL NO.	CALIBRATED UNTIL
ROHDE & SCHWARZ Test Receiver	ESCS 30	847124/029	Dec. 07, 2005
ROHDE & SCHWARZ LISN (for EUT)	ESHS-Z5	848773/004	Nov. 08, 2005
KYORITSU LISN (for peripheral)	KNW-407	8/1395/12	Jul. 19, 2006
RF Cable (JETBAO)	RG233/U	Cable_CA_01	Jul. 19, 2006
Terminator(for KYORITSU)	50	3	Oct. 12, 2005
Software	Cond-V2e	NA	NA

NOTE:

1. The calibration interval of the above test instruments is 12 months and the calibrations are traceable to NML/ROC and NIST/USA.
2. The test was performed in ADT Shielded Room No. A.
3. The VCCI Con A Registration No. is C-817.
4. The measurement uncertainty is 2.53 dB, which is calculated as per the document CISPR 16-4 This uncertainty represents an expanded uncertainty expressed at approximately the 95% confidence level using a coverage factor of k=2.



4.1.3 TEST PROCEDURES

- a. The EUT was placed 0.4 meters from the conducting wall of the shielded room with EUT being connected to the power mains through a line impedance stabilization network (LISN). Other support units were connected to the power mains through another LISN. The two LISNs provide 50 ohm/ 50uH of coupling impedance for the measuring instrument.
- b. Both lines of the power mains connected to the EUT were checked for maximum conducted interference.
- c. The frequency range from 150kHz to 30MHz was searched. Emission levels under (Limit - 20dB) were not recorded.

4.1.4 DEVIATION FROM TEST STANDARD

No deviation

4.1.5 TEST SETUP

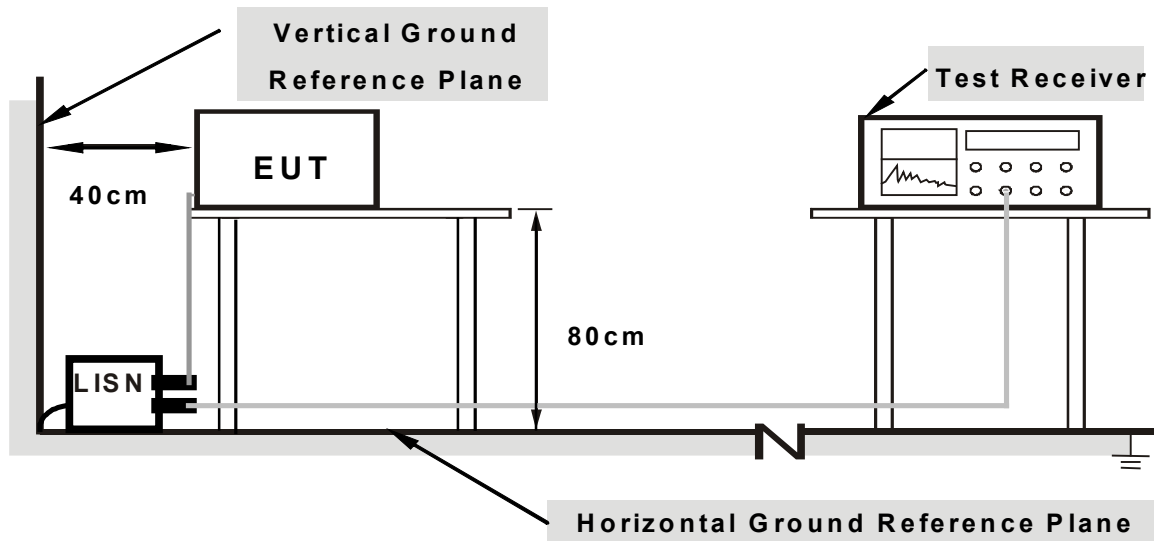

Note: 1. Support units were connected to second LISN.

2. Both of LISNs (AMN) are 80 cm from EUT and at least 80 from other units and other metal planes

For the actual test configuration, please refer to the related item – Photographs of the Test Configuration.

4.1.6 EUT OPERATING CONDITIONS

- a. Placed the EUT on the testing table.
- b. Prepared other computer systems to act as a communication partner and placed them outside of testing area.
- c. The communication partner run test program “Wintrion V00.02” to enable EUT under transmission/receiving condition continuously at specific channel frequency via UTP cable and wireless.



4.1.7 TEST RESULTS

Conducted Worst-Case Data

EUT	Symbol WLAN 802.11abg Access Point	MODEL	AP-5131
TEST MODE	With Adapter	6dB BANDWIDTH	9 kHz
MODULATION TYPE	BPSK	TRANSFER RATE	6Mbps
INPUT POWER (SYSTEM)	120Vac, 60 Hz	PHASE	Line (L)
ENVIRONMENTAL CONDITIONS	26deg. C, 63%RH, 961hPa	TESTED BY	Phoenix Huang

No	Freq. [MHz]	Corr. Factor (dB)	Reading Value		Emission Level		Limit		Margin	
			[dB (uV)]		[dB (uV)]		[dB (uV)]		(dB)	
			Q.P.	AV.	Q.P.	AV.	Q.P.	AV.	Q.P.	AV.
1	0.173	0.14	50.41	-	50.55	-	64.79	54.79	-14.24	-
2	0.209	0.15	47.15	-	47.30	-	63.26	53.26	-15.96	-
3	0.244	0.15	47.90	-	48.05	-	61.97	51.97	-13.91	-
4	2.992	0.35	35.79	-	36.14	-	56.00	46.00	-19.86	-
5	4.976	0.50	37.89	-	38.39	-	56.00	46.00	-17.61	-
6	5.530	0.53	44.74	-	45.27	-	60.00	50.00	-14.73	-
7	7.165	0.61	41.21	-	41.82	-	60.00	50.00	-18.18	-
8	11.901	0.84	34.70	-	35.54	-	60.00	50.00	-24.46	-
9	18.243	1.21	37.83	-	39.04	-	60.00	50.00	-20.96	-

- REMARKS:**
1. Q.P. and AV. are abbreviations of quasi-peak and average individually.
 2. "-": The Quasi-peak reading value also meets average limit and measurement with the average detector is unnecessary.
 3. The emission levels of other frequencies were very low against the limit.
 4. Margin value = Emission level - Limit value
 5. Correction factor = Insertion loss + Cable loss
 6. Emission Level = Correction Factor + Reading Value.

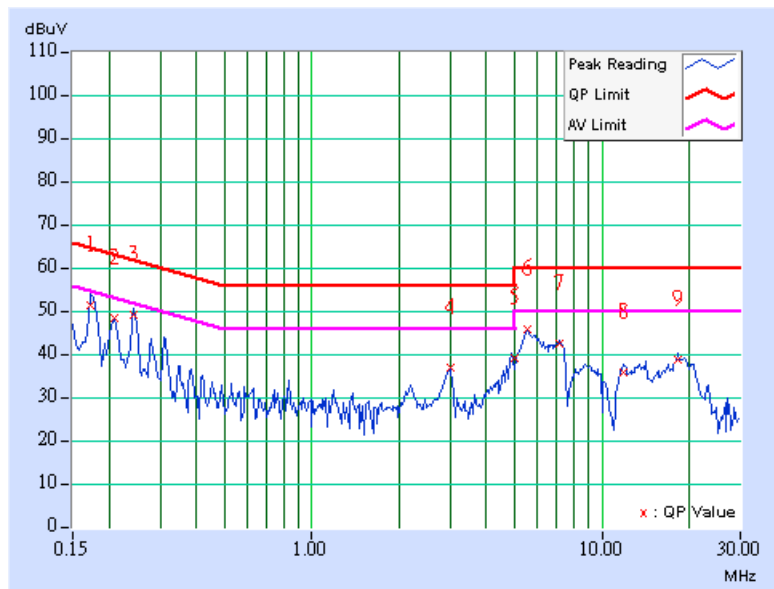



EUT	Symbol WLAN 802.11abg Access Point	MODEL	AP-5131
TEST MODE	With Adapter	6dB BANDWIDTH	9 kHz
MODULATION TYPE	BPSK	TRANSFER RATE	6Mbps
INPUT POWER (SYSTEM)	120Vac, 60 Hz	PHASE	Neutral (N)
ENVIRONMENTAL CONDITIONS	26deg. C, 63%RH, 961hPa	TESTED BY	Phoenix Huang

No	Freq. [MHz]	Corr. Factor (dB)	Reading Value		Emission Level		Limit		Margin	
			[dB (uV)]		[dB (uV)]		[dB (uV)]		(dB)	
			Q.P.	AV.	Q.P.	AV.	Q.P.	AV.	Q.P.	AV.
1	0.173	0.14	52.51	-	52.65	-	64.79	54.79	-12.14	-
2	0.209	0.15	48.87	-	49.02	-	63.26	53.26	-14.24	-
3	0.244	0.15	49.32	-	49.47	-	61.96	51.96	-12.49	-
4	2.998	0.35	33.39	-	33.74	-	56.00	46.00	-22.26	-
5	4.983	0.48	34.99	-	35.47	-	56.00	46.00	-20.53	-
6	5.543	0.50	44.84	-	45.34	-	60.00	50.00	-14.66	-
7	6.207	0.52	42.42	-	42.94	-	60.00	50.00	-17.06	-
8	7.215	0.56	40.50	-	41.06	-	60.00	50.00	-18.94	-
9	18.367	1.05	35.54	-	36.59	-	60.00	50.00	-23.41	-

- REMARKS:**
1. Q.P. and AV. are abbreviations of quasi-peak and average individually.
 2. "-": The Quasi-peak reading value also meets average limit and measurement with the average detector is unnecessary.
 3. The emission levels of other frequencies were very low against the limit.
 4. Margin value = Emission level - Limit value
 5. Correction factor = Insertion loss + Cable loss
 6. Emission Level = Correction Factor + Reading Value.

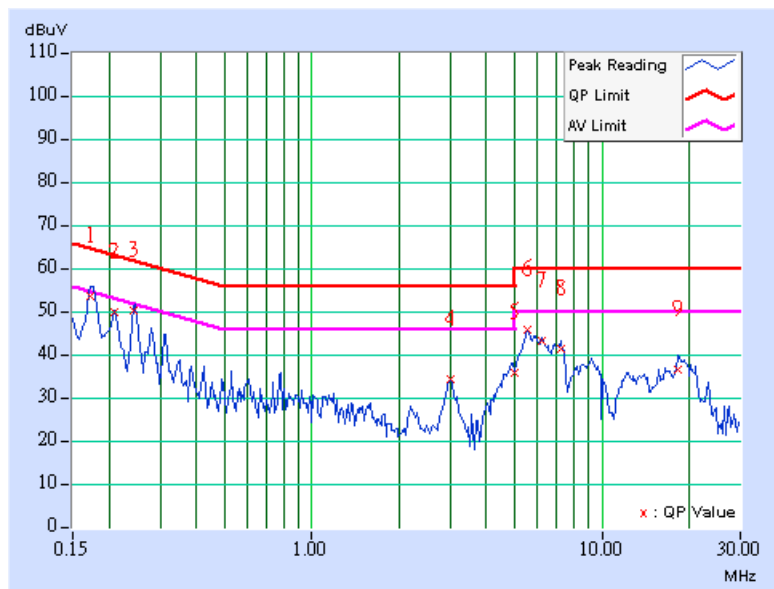



EUT	Symbol WLAN 802.11abg Access Point	MODEL	AP-5131
TEST MODE	With POE	6dB BANDWIDTH	9 kHz
MODULATION TYPE	BPSK	TRANSFER RATE	6Mbps
INPUT POWER (SYSTEM)	120Vac, 60 Hz	PHASE	Line (L)
ENVIRONMENTAL CONDITIONS	26DEG. C, 63%RH, 961hPa	TESTED BY	Phoenix Huang

No	Freq. [MHz]	Corr. Factor (dB)	Reading Value		Emission Level		Limit		Margin	
			[dB (uV)]		[dB (uV)]		[dB (uV)]		(dB)	
			Q.P.	AV.	Q.P.	AV.	Q.P.	AV.	Q.P.	AV.
1	0.262	0.16	45.65	-	45.81	-	61.37	51.37	-15.56	-
2	0.306	0.16	44.92	-	45.08	-	60.07	50.07	-14.99	-
3	0.529	0.18	46.81	38.52	46.99	38.70	56.00	46.00	-9.01	-7.30
4	0.788	0.19	46.54	35.48	46.73	35.67	56.00	46.00	-9.27	-10.33
5	1.199	0.21	46.02	31.64	46.23	31.85	56.00	46.00	-9.77	-14.15
6	1.608	0.23	45.64	-	45.87	-	56.00	46.00	-10.13	-
7	1.861	0.24	47.18	29.05	47.42	29.29	56.00	46.00	-8.58	-16.71
8	8.514	0.68	39.09	-	39.77	-	60.00	50.00	-20.23	-

- REMARKS:**
1. Q.P. and AV. are abbreviations of quasi-peak and average individually.
 2. "-": The Quasi-peak reading value also meets average limit and measurement with the average detector is unnecessary.
 3. The emission levels of other frequencies were very low against the limit.
 4. Margin value = Emission level - Limit value
 5. Correction factor = Insertion loss + Cable loss
 6. Emission Level = Correction Factor + Reading Value.

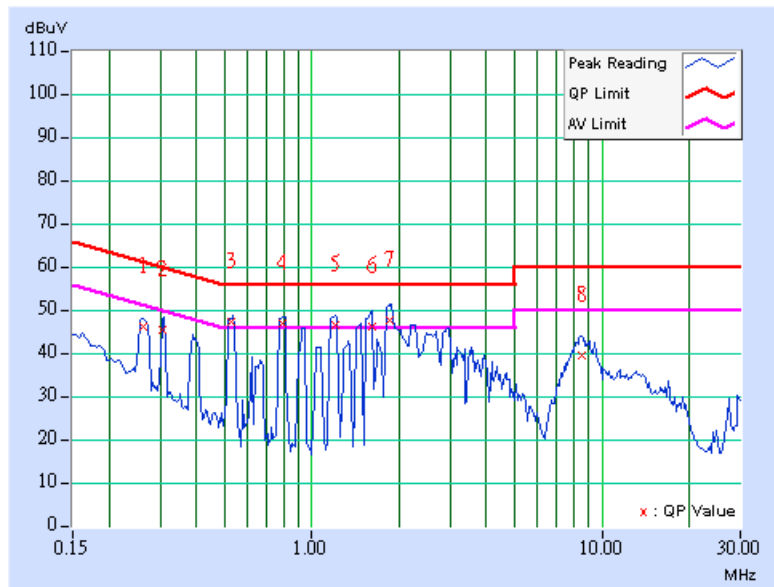



EUT	Symbol WLAN 802.11abg Access Point	MODEL	AP-5131
TEST MODE	With POE	6dB BANDWIDTH	9 kHz
MODULATION TYPE	BPSK	TRANSFER RATE	6Mbps
INPUT POWER (SYSTEM)	120Vac, 60 Hz	PHASE	Neutral (N)
ENVIRONMENTAL CONDITIONS	26deg. C, 63%RH, 961hPa	TESTED BY	Phoenix Huang

No	Freq. [MHz]	Corr. Factor (dB)	Reading Value		Emission Level		Limit		Margin	
			[dB (uV)]		[dB (uV)]		[dB (uV)]		(dB)	
			Q.P.	AV.	Q.P.	AV.	Q.P.	AV.	Q.P.	AV.
1	0.309	0.16	45.56	-	45.72	-	60.00	50.00	-14.28	-
2	0.526	0.18	46.67	38.43	46.85	38.61	56.00	46.00	-9.15	-7.39
3	0.797	0.19	46.52	35.13	46.71	35.32	56.00	46.00	-9.29	-10.68
4	1.200	0.21	45.88	31.55	46.09	31.76	56.00	46.00	-9.91	-14.24
5	1.610	0.23	45.42	-	45.65	-	56.00	46.00	-10.35	-
6	1.848	0.24	46.48	28.96	46.72	29.20	56.00	46.00	-9.28	-16.80
7	2.963	0.35	40.98	-	41.33	-	56.00	46.00	-14.67	-

- REMARKS:**
1. Q.P. and AV. are abbreviations of quasi-peak and average individually.
 2. "-": The Quasi-peak reading value also meets average limit and measurement with the average detector is unnecessary.
 3. The emission levels of other frequencies were very low against the limit.
 4. Margin value = Emission level - Limit value
 5. Correction factor = Insertion loss + Cable loss
 6. Emission Level = Correction Factor + Reading Value.

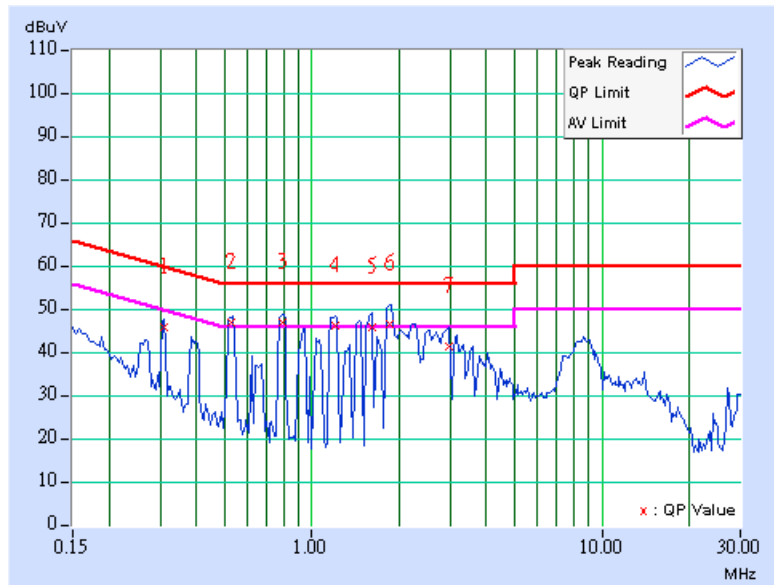



4.2 RADIATED EMISSION MEASUREMENT

4.2.1 LIMITS OF RADIATED EMISSION MEASUREMENT

Emissions radiated outside of the specified bands, shall be according to the general radiated limits in 15.209 as following:

Frequencies (MHz)	Field strength (microvolts/meter)	Measurement distance (meters)
0.009-0.490	2400/F(kHz)	300
0.490-1.705	24000/F(kHz)	30
1.705-30.0	30	30
30-88	100	3
88-216	150	3
216-960	200	3
Above 960	500	3

NOTE:

1. The lower limit shall apply at the transition frequencies.
2. Emission level (dBuV/m) = 20 log Emission level (uV/m).
3. As shown in 15.35(b), for frequencies above 1000MHz, the field strength limits are based on average detector, however, the peak field strength of any emission shall not exceed the maximum permitted average limits, specified above by more than 20dB under any condition of modulation.



4.2.2 LIMITS OF UNWANTED EMISSION OUT OF THE RESTRICTED BANDS

Frequencies (MHz)	EIRP Limit (dBm)	Equivalent Field Strength at 3m (dB μ V/m) *note 3
5150~5250	-27	68.3
5250~5350	-27	68.3
5725~5825	-27 *note 1	68.3
	-17 *note 2	78.3

NOTE:

1. For frequencies 10MHz or greater above or below the band edge.
2. All emissions within the frequency range from the band edge to 10MHz above or below the band edge.
3. The following formula is used to convert the equipment isotropic radiated power (eirp) to field strength

$$E = \frac{1000000\sqrt{30P}}{3} \mu\text{V/m, where P is the eirp (Watts)}$$

4.2.3 TEST INSTRUMENTS

DESCRIPTION & MANUFACTURER	MODEL NO.	SERIAL NO.	CALIBRATED UNTIL
ADVANTEST Spectrum Analyzer	R3271A	85060311	July 07, 2006
HP Pre_Amplifier	8449B	3008A01922	Oct. 13, 2005
ROHDE & SCHWARZ Test Receiver	ESCS30	100287	Dec. 08, 2005
CHASE Broadband Antenna	VULB9168	138	Dec. 21, 2005
Schwarzbeck Horn_Antenna	BBHA9120	D124	Dec. 11, 2005
Schwarzbeck Horn_Antenna	BBHA 9170	BBHA9170153	Jan. 30, 2006
SCHWARZBECK Biconical Antenna	VHBA9123	459	Jun. 26, 2006
SCHWARZBECK Periodic Antenna	UPA6108	1148	Jun. 26, 2006
RF Switches (ARNITSU)	CS-201	1565157	NA
RF CABLE (Chaintek) 1GHz-20GHz	SF102	22054-2	Nov. 15. 2005
RF Cable(RICHTEC)	9913-30M	STCCAB-30M- 1GHz-021	Jul. 16, 2006
Software	ADT_Radiated_V 5.14	NA	NA
CHANCE MOST Antenna Tower	AT-100	0203	NA
CHANCE MOST Turn Table	TT-100	0203	NA

- Note: 1. The calibration interval of the above test instruments is 12 months (36 months for Tunable Periodic Antenna) and the calibrations are traceable to NML/ROC and NIST/USA.
2. The horn antenna and HP preamplifier (model: 8449B) are used only for the measurement of emission frequency above 1GHz if tested.
3. The test was performed in ADT Open Site No. C.
4. The FCC Site Registration No. is 656396.
5. The VCCI Site Registration No. is R-1626.
6. The CANADA Site Registration No. is IC 4824-3.
7. The following table is for the measurement uncertainty, which is calculated as per the document CISPR 16-4. This uncertainty represents an expanded uncertainty expressed at approximately the 95% confidence level using a coverage factor of k=2.

Measurement	Value
Radiated emissions (30MHz-1GHz)	2.98 dB
Radiated emissions (1GHz ~18GHz)	2.21 dB
Radiated emissions (18GHz ~20GHz)	1.88 dB



4.2.4 TEST PROCEDURES

- a. The EUT was placed on the top of a rotating table 0.8 meters above the ground at a 3 meter semi-anechoic chamber. The table was rotated 360 degrees to determine the position of the highest radiation.
- b. The EUT was set 3 meters away from the interference-receiving antenna, which was mounted on the top of a variable-height antenna tower.
- c. The antenna is a broadband antenna, and its height is varied from one meter to four meters above the ground to determine the maximum value of the field strength. Both horizontal and vertical polarizations of the antenna are set to make the measurement.
- d. For each suspected emission, the EUT was arranged to its worst case and then the antenna was tuned to heights from 1 meter to 4 meters and the rotatable table was turned from 0 degrees to 360 degrees to find the maximum reading.
- e. The test-receiver system was set to Peak Detect Function and Specified Bandwidth with Maximum Hold Mode.
- f. If the emission level of the EUT in peak mode was 10dB lower than the limit specified, then testing could be stopped and the peak values of the EUT would be reported. Otherwise the emissions that did not have 10dB margin would be re-tested one by one using peak, quasi-peak or average method as specified and then reported in a data sheet.

NOTE:

1. The resolution bandwidth and video bandwidth of test receiver/spectrum analyzer is 120kHz for Peak detection (PK) and Quasi-peak detection (QP) at frequency below 1GHz.
2. The resolution bandwidth and video bandwidth of test receiver/spectrum analyzer is 1 MHz for Peak detection at frequency above 1GHz.
3. The resolution bandwidth of test receiver/spectrum analyzer is 1 MHz and the video bandwidth is 10 Hz for Average detection (AV) at frequency above 1GHz.

4.2.5 DEVIATION FROM TEST STANDARD

No deviation

4.2.6 TEST SETUP

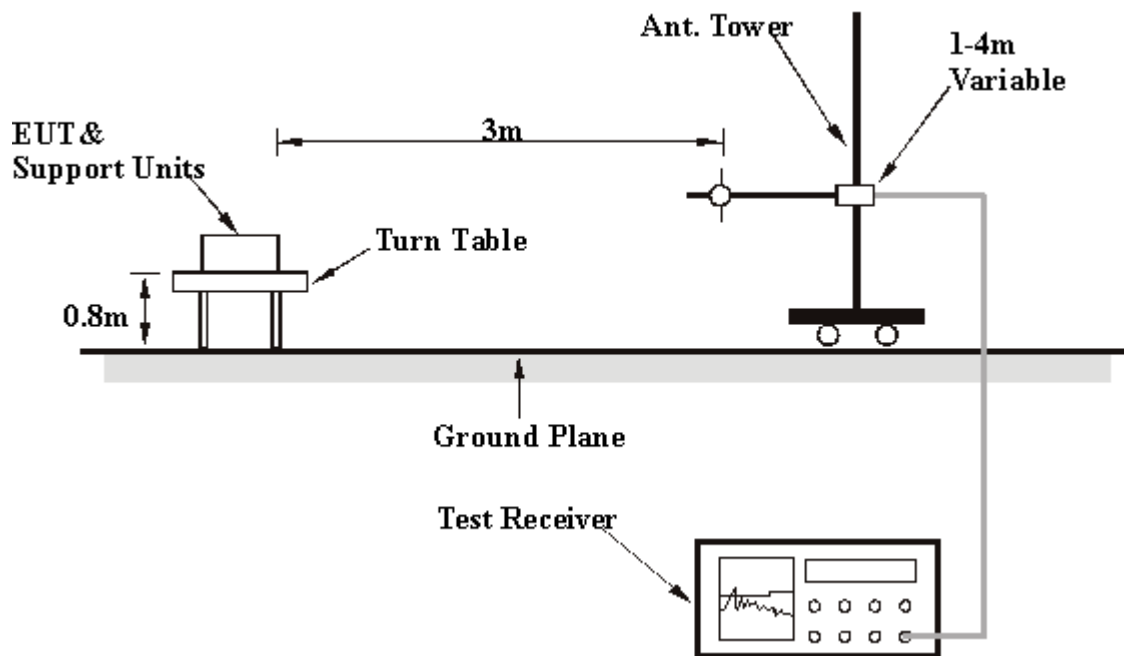

For the actual test configuration, please refer to the related item – Photographs of the Test Configuration.

4.2.7 EUT OPERATING CONDITION

Same as 4.1.6

4.2.8 TEST RESULTS (ANTENNA 1)

Below 1GHz Worst-Case Data

EUT	Symbol WLAN 802.11abg Access Point	MODEL	AP-5131
TEST MODE	With Adapter	FREQUENCY RANGE	Below 1000MHz
MODULATION TYPE	BPSK	TRANSFER RATE	6Mbps
INPUT POWER (SYSTEM)	120Vac, 60 Hz	DETECTOR FUNCTION	Quasi-Peak
ENVIRONMENTAL CONDITIONS	27deg. C, 70%RH, 961hPa	TESTED BY	Jerry Fan

ANTENNA POLARITY & TEST DISTANCE: HORIZONTAL AT 3 M

No.	Freq. (MHz)	Emission Level (dBuV/m)	Limit (dBuV/m)	Margin (dB)	Antenna Height (m)	Table Angle (Degree)	Raw Value (dBuV)	Correction Factor (dB/m)
1	118.58	29.40 QP	43.50	-14.10	1.93 H	60	17.40	12.00
2	231.65	28.90 QP	46.00	-17.10	1.83 H	123	15.90	13.00
3	312.98	32.70 QP	46.00	-13.30	1.73 H	200	16.20	16.50
4	428.93	32.20 QP	46.00	-13.80	1.67 H	280	12.60	19.60
5	517.48	35.50 QP	46.00	-10.50	1.51 H	227	13.70	21.90
6	582.43	37.00 QP	46.00	-9.00	1.44 H	233	13.90	23.20
7	625.08	34.70 QP	46.00	-11.30	1.24 H	173	10.90	23.80
8	726.03	32.30 QP	46.00	-13.70	1.19 H	267	6.90	25.40
9	817.07	32.60 QP	46.00	-13.40	1.16 H	223	5.60	27.00
10	925.00	34.70 QP	46.00	-11.30	1.00 H	163	6.10	28.60

ANTENNA POLARITY & TEST DISTANCE: VERTICAL AT 3 M

No.	Freq. (MHz)	Emission Level (dBuV/m)	Limit (dBuV/m)	Margin (dB)	Antenna Height (m)	Table Angle (Degree)	Raw Value (dBuV)	Correction Factor (dB/m)
1	61.05	26.60 QP	40.00	-13.40	1.00 V	87	19.00	7.60
2	155.38	31.40 QP	43.50	-12.10	1.00 V	135	19.50	11.90
3	268.35	32.10 QP	46.00	-13.90	1.00 V	184	16.70	15.40
4	382.68	36.80 QP	46.00	-9.20	1.00 V	239	18.20	18.60
5	440.88	34.60 QP	46.00	-11.40	1.00 V	185	14.90	19.70
6	527.25	33.10 QP	46.00	-12.90	1.00 V	232	11.00	22.10
7	633.73	35.40 QP	46.00	-10.60	1.76 V	288	11.40	24.00
8	717.28	34.50 QP	46.00	-11.50	1.62 V	223	9.50	25.00
9	831.55	33.00 QP	46.00	-13.00	1.57 V	137	5.50	27.50
10	936.12	36.90 QP	46.00	-9.10	1.00 V	211	7.80	29.00

- REMARKS:**
1. Emission level(dBuV/m)=Raw Value(dBuV) + Correction Factor(dB/m)
 2. Correction Factor(dB/m) = Antenna Factor (dB/m) + Cable Factor (dB)
 3. The other emission levels were very low against the limit.
 4. Margin value = Emission level – Limit value



Below 1GHz Worst-Case Data

EUT	Symbol WLAN 802.11abg Access Point	MODEL	AP-5131
TEST MODE	With POE	FREQUENCY RANGE	Below 1000MHz
MODULATION TYPE	BPSK	TRANSFER RATE	6Mbps
INPUT POWER (SYSTEM)	120Vac, 60 Hz	DETECTOR FUNCTION	Quasi-Peak
ENVIRONMENTAL CONDITIONS	27deg. C, 70%RH, 961hPa	TESTED BY	Jerry Fan

ANTENNA POLARITY & TEST DISTANCE: HORIZONTAL AT 3 M								
No.	Freq. (MHz)	Emission Level (dBuV/m)	Limit (dBuV/m)	Margin (dB)	Antenna Height (m)	Table Angle (Degree)	Raw Value (dBuV)	Correction Factor (dB/m)
1	129.80	30.40 QP	43.50	-13.10	1.99 H	155	17.70	12.70
2	169.05	28.80 QP	43.50	-14.70	1.92 H	66	17.80	11.00
3	235.53	33.70 QP	46.00	-12.30	1.86 H	125	20.40	13.30
4	365.55	34.40 QP	46.00	-11.60	1.82 H	174	16.50	17.90
5	425.45	35.20 QP	46.00	-10.80	1.72 H	97	15.70	19.60
6	582.83	33.20 QP	46.00	-12.80	1.60 H	161	10.10	23.20
7	637.08	35.70 QP	46.00	-10.30	1.52 H	216	11.70	24.00
8	757.88	36.10 QP	46.00	-9.90	1.27 H	105	9.60	26.40
9	822.27	34.20 QP	46.00	-11.80	1.00 H	135	7.00	27.20
10	935.67	36.00 QP	46.00	-10.00	1.00 H	185	6.90	29.00

ANTENNA POLARITY & TEST DISTANCE: VERTICAL AT 3 M								
No.	Freq. (MHz)	Emission Level (dBuV/m)	Limit (dBuV/m)	Margin (dB)	Antenna Height (m)	Table Angle (Degree)	Raw Value (dBuV)	Correction Factor (dB/m)
1	51.85	27.40 QP	40.00	-12.60	1.00 V	48	17.50	10.00
2	111.50	31.20 QP	43.50	-12.30	1.00 V	86	19.30	11.80
3	265.98	33.90 QP	46.00	-12.10	1.00 V	177	18.50	15.40
4	369.13	33.70 QP	46.00	-12.30	1.00 V	266	15.60	18.00
5	412.33	35.00 QP	46.00	-11.00	1.00 V	204	15.50	19.50
6	530.55	37.00 QP	46.00	-9.00	1.74 V	114	14.80	22.10
7	618.20	35.80 QP	46.00	-10.20	1.64 V	49	12.00	23.70
8	743.70	34.70 QP	46.00	-11.30	1.56 V	109	8.60	26.20
9	804.22	36.20 QP	46.00	-9.80	1.39 V	198	9.70	26.50
10	965.95	41.70 QP	54.00	-12.30	1.15 V	141	12.50	29.20

- REMARKS:**
1. Emission level(dBuV/m)=Raw Value(dBuV) + Correction Factor(dB/m)
 2. Correction Factor(dB/m) = Antenna Factor (dB/m) + Cable Factor (dB)
 3. The other emission levels were very low against the limit.
 4. Margin value = Emission level – Limit value



802.11a OFDM modulation

EUT	Symbol WLAN 802.11abg Access Point	MODEL	AP-5131
CHANNEL	Channel 1	FREQUENCY RANGE	1 ~ 40 GHz
MODULATION TYPE	BPSK	TRANSFER RATE	6Mbps
INPUT POWER (SYSTEM)	120Vac, 60 Hz	DETECTOR FUNCTION	Peak(PK) Average (AV)
ENVIRONMENTAL CONDITIONS	27deg. C, 53%RH, 961hPa	TESTED BY	Tony Chen

ANTENNA POLARITY & TEST DISTANCE: HORIZONTAL AT 3 M

No.	Freq. (MHz)	Emission Level (dBuV/m)	Limit (dBuV/m)	Margin (dB)	Antenna Height (m)	Table Angle (Degree)	Raw Value (dBuV)	Correction Factor (dB/m)
1	#5143.00	43.50 PK	74.00	-30.50	1.57 H	235	7.70	35.80
1	#5143.00	35.10 AV	54.00	-18.90	1.57 H	235	-0.70	35.80
2	#5150.00	43.30 PK	74.00	-30.70	1.57 H	235	7.50	35.80
2	#5150.00	30.80 AV	54.00	-23.20	1.57 H	235	-5.00	35.80
3	*5180.00	90.20 PK			1.57 H	235	54.40	35.80
3	*5180.00	81.80 AV			1.57 H	235	46.00	35.80
4	10360.00	51.30 PK	68.30	-17.00	1.06 H	77	7.10	44.10

ANTENNA POLARITY & TEST DISTANCE: VERTICAL AT 3 M

No.	Freq. (MHz)	Emission Level (dBuV/m)	Limit (dBuV/m)	Margin (dB)	Antenna Height (m)	Table Angle (Degree)	Raw Value (dBuV)	Correction Factor (dB/m)
1	#5143.00	57.80 PK	74.00	-16.20	1.02 V	32	22.00	35.80
1	#5143.00	46.30 AV	54.00	-7.70	1.02 V	32	10.50	35.80
2	#5150.00	57.60 PK	74.00	-16.40	1.02 V	32	21.80	35.80
2	#5150.00	45.00 AV	54.00	-9.00	1.02 V	32	9.20	35.80
3	*5180.00	104.50 PK			1.02 V	32	68.70	35.80
3	*5180.00	96.40 AV			1.02 V	32	60.60	35.80
4	10360.00	52.70 PK	68.30	-15.60	1.03 V	181	8.50	44.10

- NOTE:**
1. Emission level(dBuV/m)=Raw Value(dBuV) + Correction Factor(dB/m)
 2. Correction Factor(dB/m) = Antenna Factor (dB/m) + Cable Factor (dB)
 3. The other emission levels were very low against the limit.
 4. Margin value = Emission level – Limit value
 5. "*" : Fundamental frequency
 6. "#"The radiated frequency falling in the restricted band.



EUT	Symbol WLAN 802.11abg Access Point	MODEL	AP-5131
CHANNEL	Channel 4	FREQUENCY RANGE	1 ~ 40 GHz
MODULATION TYPE	BPSK	TRANSFER RATE	6Mbps
INPUT POWER (SYSTEM)	120Vac, 60 Hz	DETECTOR FUNCTION	Peak(PK) Average (AV)
ENVIRONMENTAL CONDITIONS	27deg. C, 53%RH, 961hPa	TESTED BY	Tony Chen

ANTENNA POLARITY & TEST DISTANCE: HORIZONTAL AT 3 M

No.	Freq. (MHz)	Emission Level (dBuV/m)	Limit (dBuV/m)	Margin (dB)	Antenna Height (m)	Table Angle (Degree)	Raw Value (dBuV)	Correction Factor (dB/m)
1	*5240.00	92.20 PK			1.23 H	235	56.40	35.80
1	*5240.00	83.50 AV			1.23 H	235	47.70	35.80
2	#10480.00	51.10 PK	68.30	-17.20	1.11 H	74	6.60	44.40

ANTENNA POLARITY & TEST DISTANCE: VERTICAL AT 3 M

No.	Freq. (MHz)	Emission Level (dBuV/m)	Limit (dBuV/m)	Margin (dB)	Antenna Height (m)	Table Angle (Degree)	Raw Value (dBuV)	Correction Factor (dB/m)
1	*5240.00	104.70 PK			1.00 V	342	68.90	35.80
1	*5240.00	96.40 AV			1.00 V	342	60.60	35.80
2	#10480.00	52.50 PK	68.30	-15.80	1.02 V	180	8.00	44.40

- NOTE:**
1. Emission level(dBuV/m)=Raw Value(dBuV) + Correction Factor(dB/m)
 2. Correction Factor(dB/m) = Antenna Factor (dB/m) + Cable Factor (dB)
 3. The other emission levels were very low against the limit.
 4. Margin value = Emission level – Limit value
 5. "*" : Fundamental frequency
 6. "#" The radiated frequency falling in the restricted band.



EUT	Symbol WLAN 802.11abg Access Point	MODEL	AP-5131
CHANNEL	Channel 5	FREQUENCY RANGE	1 ~ 40 GHz
MODULATION TYPE	BPSK	TRANSFER RATE	6Mbps
INPUT POWER (SYSTEM)	120Vac, 60 Hz	DETECTOR FUNCTION	Peak(PK) Average (AV)
ENVIRONMENTAL CONDITIONS	27deg. C, 53%RH, 961hPa	TESTED BY	Tony Chen

ANTENNA POLARITY & TEST DISTANCE: HORIZONTAL AT 3 M

No.	Freq. (MHz)	Emission Level (dBuV/m)	Limit (dBuV/m)	Margin (dB)	Antenna Height (m)	Table Angle (Degree)	Raw Value (dBuV)	Correction Factor (dB/m)
1	*5260.00	98.10 PK			1.24 H	234	62.30	35.80
1	*5260.00	89.60 AV			1.24 H	234	53.80	35.80
2	10520.00	57.20 PK	68.30	-11.10	1.00 H	60	12.50	44.70

ANTENNA POLARITY & TEST DISTANCE: VERTICAL AT 3 M

No.	Freq. (MHz)	Emission Level (dBuV/m)	Limit (dBuV/m)	Margin (dB)	Antenna Height (m)	Table Angle (Degree)	Raw Value (dBuV)	Correction Factor (dB/m)
1	*5260.00	113.10 PK			1.33 V	204	77.30	35.80
1	*5260.00	104.70 AV			1.33 V	204	68.90	35.80
2	10520.00	57.80 PK	68.30	-10.50	1.01 V	19	13.10	44.70

- NOTE:**
1. Emission level(dBuV/m)=Raw Value(dBuV) + Correction Factor(dB/m)
 2. Correction Factor(dB/m) = Antenna Factor (dB/m) + Cable Factor (dB)
 3. The other emission levels were very low against the limit.
 4. Margin value = Emission level – Limit value
 5. "*" : Fundamental frequency
 6. "#" The radiated frequency falling in the restricted band.



EUT	Symbol WLAN 802.11abg Access Point	MODEL	AP-5131
CHANNEL	Channel 8	FREQUENCY RANGE	1 ~ 40 GHz
MODULATION TYPE	BPSK	TRANSFER RATE	6Mbps
INPUT POWER (SYSTEM)	120Vac, 60 Hz	DETECTOR FUNCTION	Peak(PK) Average (AV)
ENVIRONMENTAL CONDITIONS	27deg. C, 53%RH, 961hPa	TESTED BY	Tony Chen

ANTENNA POLARITY & TEST DISTANCE: HORIZONTAL AT 3 M

No.	Freq. (MHz)	Emission Level (dBuV/m)	Limit (dBuV/m)	Margin (dB)	Antenna Height (m)	Table Angle (Degree)	Raw Value (dBuV)	Correction Factor (dB/m)
1	*5320.00	96.30 PK			1.50 H	232	60.50	35.80
1	*5320.00	87.30 AV			1.50 H	232	51.50	35.80
2	#5350.00	48.70 PK	74.00	-25.30	1.50 H	232	13.00	35.80
2	#5350.00	35.70 AV	54.00	-18.30	1.50 H	232	-0.10	35.80
3	#5356.00	46.80 PK	74.00	-27.20	1.50 H	232	11.00	35.80
3	#5356.00	36.00 AV	54.00	-18.00	1.50 H	232	0.20	35.80
4	#10640.00	56.70 PK	74.00	-17.30	1.01 H	55	10.80	45.90
4	#10640.00	46.10 AV	54.00	-7.90	1.01 H	55	0.20	45.90

ANTENNA POLARITY & TEST DISTANCE: VERTICAL AT 3 M

No.	Freq. (MHz)	Emission Level (dBuV/m)	Limit (dBuV/m)	Margin (dB)	Antenna Height (m)	Table Angle (Degree)	Raw Value (dBuV)	Correction Factor (dB/m)
1	*5320.00	110.20 PK			1.02 V	7	74.40	35.80
1	*5320.00	101.90 AV			1.02 V	7	66.10	35.80
2	#5350.00	62.60 PK	74.00	-11.40	1.02 V	7	26.90	35.80
2	#5350.00	50.30 AV	54.00	-3.70	1.02 V	7	14.50	35.80
3	#5356.00	60.70 PK	74.00	-13.30	1.02 V	7	24.90	35.80
3	#5356.00	50.60 AV	54.00	-3.40	1.02 V	7	14.80	35.80
4	#10640.00	58.10 PK	74.00	-15.90	1.17 V	20	12.20	45.90
4	#10640.00	46.90 AV	54.00	-7.10	1.17 V	20	1.00	45.90

- NOTE:**
1. Emission level(dBuV/m)=Raw Value(dBuV) + Correction Factor(dB/m)
 2. Correction Factor(dB/m) = Antenna Factor (dB/m) + Cable Factor (dB)
 3. The other emission levels were very low against the limit.
 4. Margin value = Emission level – Limit value
 5. "*" : Fundamental frequency
 6. "#"The radiated frequency falling in the restricted band.



EUT	Symbol WLAN 802.11abg Access Point	MODEL	AP-5131
CHANNEL	Channel 9	FREQUENCY RANGE	1 ~ 40 GHz
MODULATION TYPE	BPSK	TRANSFER RATE	6Mbps
INPUT POWER (SYSTEM)	120Vac, 60 Hz	DETECTOR FUNCTION	Peak(PK) Average (AV)
ENVIRONMENTAL CONDITIONS	27deg. C, 53%RH, 961hPa	TESTED BY	Tony Chen

ANTENNA POLARITY & TEST DISTANCE: HORIZONTAL AT 3 M

No.	Freq. (MHz)	Emission Level (dBuV/m)	Limit (dBuV/m)	Margin (dB)	Antenna Height (m)	Table Angle (Degree)	Raw Value (dBuV)	Correction Factor (dB/m)
1	5715.00	63.50 PK	68.30	-4.80	1.59 H	25	27.20	36.30
2	5725.00	70.10 PK	78.30	-8.20	1.61 H	24	33.80	36.30
3	*5745.00	97.10 PK			1.65 H	19	60.70	36.40
3	*5745.00	88.50 AV			1.65 H	19	52.10	36.40
4	#11490.00	57.80 PK	74.00	-16.20	1.32 H	303	6.70	51.10
4	#11490.00	46.50 AV	54.00	-7.50	1.32 H	303	-4.60	51.10

ANTENNA POLARITY & TEST DISTANCE: VERTICAL AT 3 M

No.	Freq. (MHz)	Emission Level (dBuV/m)	Limit (dBuV/m)	Margin (dB)	Antenna Height (m)	Table Angle (Degree)	Raw Value (dBuV)	Correction Factor (dB/m)
1	5715.00	65.70 PK	68.30	-2.60	1.27 V	34	29.40	36.30
2	5725.00	74.50 PK	78.30	-3.80	1.26 V	34	38.20	36.30
3	*5745.00	107.60 PK			1.24 V	32	71.20	36.40
3	*5745.00	98.70 AV			1.24 V	32	62.30	36.40
4	#11490.00	58.40 PK	74.00	-15.60	1.34 V	17	7.30	51.10
4	#11490.00	47.00 AV	54.00	-7.00	1.34 V	17	-4.10	51.10

- NOTE:**
1. Emission level(dBuV/m)=Raw Value(dBuV) + Correction Factor(dB/m)
 2. Correction Factor(dB/m) = Antenna Factor (dB/m) + Cable Factor (dB)
 3. The other emission levels were very low against the limit.
 4. Margin value = Emission level – Limit value
 5. "*" : Fundamental frequency
 6. "#":The radiated frequency falling in the restricted band.



EUT	Symbol WLAN 802.11abg Access Point	MODEL	AP-5131
CHANNEL	Channel 12	FREQUENCY RANGE	1 ~ 40 GHz
MODULATION TYPE	BPSK	TRANSFER RATE	6Mbps
INPUT POWER (SYSTEM)	120Vac, 60 Hz	DETECTOR FUNCTION	Peak(PK) Average (AV)
ENVIRONMENTAL CONDITIONS	27deg. C, 53%RH, 961hPa	TESTED BY	Tony Chen

ANTENNA POLARITY & TEST DISTANCE: HORIZONTAL AT 3 M

No.	Freq. (MHz)	Emission Level (dBuV/m)	Limit (dBuV/m)	Margin (dB)	Antenna Height (m)	Table Angle (Degree)	Raw Value (dBuV)	Correction Factor (dB/m)
1	*5805.00	97.70 PK			1.62 H	24	61.10	36.60
1	*5805.00	89.00 AV			1.62 H	24	52.40	36.60
2	5825.00	70.20 PK	78.30	-8.10	1.61 H	27	33.60	36.60
3	5835.00	63.70 PK	68.30	-4.60	1.61 H	29	27.10	36.60
4	#11610.00	57.60 PK	74.00	-16.40	1.43 H	329	6.90	50.80
4	#11610.00	46.10 AV	54.00	-7.90	1.43 H	329	-4.60	50.80

ANTENNA POLARITY & TEST DISTANCE: VERTICAL AT 3 M

No.	Freq. (MHz)	Emission Level (dBuV/m)	Limit (dBuV/m)	Margin (dB)	Antenna Height (m)	Table Angle (Degree)	Raw Value (dBuV)	Correction Factor (dB/m)
1	*5805.00	108.30 PK			1.33 V	326	71.70	36.60
1	*5805.00	99.40 AV			1.33 V	326	62.80	36.60
2	5825.00	74.70 PK	78.30	-3.60	1.17 V	315	38.10	36.60
3	5835.00	64.10 PK	68.30	-4.20	1.17 V	318	27.50	36.60
4	#11610.00	58.10 PK	74.00	-15.90	1.28 V	23	7.40	50.80
4	#11610.00	46.50 AV	54.00	-7.50	1.28 V	23	-4.20	50.80

- NOTE:**
1. Emission level(dBuV/m)=Raw Value(dBuV) + Correction Factor(dB/m)
 2. Correction Factor(dB/m) = Antenna Factor (dB/m) + Cable Factor (dB)
 3. The other emission levels were very low against the limit.
 4. Margin value = Emission level – Limit value
 5. "*" : Fundamental frequency
 6. "#"The radiated frequency falling in the restricted band.

4.2.9 TEST RESULTS (ANTENNA 2)

Below 1GHz Worst-Case Data

EUT	Symbol WLAN 802.11abg Access Point	MODEL	AP-5131
TEST MODE	With Adapter	FREQUENCY RANGE	Below 1000MHz
MODULATION TYPE	BPSK	TRANSFER RATE	6Mbps
INPUT POWER (SYSTEM)	120Vac, 60 Hz	DETECTOR FUNCTION	Quasi-Peak
ENVIRONMENTAL CONDITIONS	27deg. C, 70%RH, 961hPa	TESTED BY	Jerry Fan

ANTENNA POLARITY & TEST DISTANCE: HORIZONTAL AT 3 M

No.	Freq. (MHz)	Emission Level (dBuV/m)	Limit (dBuV/m)	Margin (dB)	Antenna Height (m)	Table Angle (Degree)	Raw Value (dBuV)	Correction Factor (dB/m)
1	165.98	28.80 QP	43.50	-14.70	2.03 H	18	17.60	11.20
2	193.90	26.70 QP	43.50	-16.80	1.92 H	32	15.90	10.80
3	290.23	32.90 QP	46.00	-13.10	1.83 H	114	16.90	15.90
4	367.15	32.20 QP	46.00	-13.80	1.42 H	165	14.20	18.00
5	448.03	34.00 QP	46.00	-12.00	1.35 H	253	14.30	19.70
6	533.63	33.40 QP	46.00	-12.60	1.28 H	225	11.20	22.20
7	677.70	35.20 QP	46.00	-10.80	1.19 H	130	11.00	24.20
8	749.58	36.60 QP	46.00	-9.40	1.02 H	101	10.20	26.40
9	832.27	36.00 QP	46.00	-10.00	1.08 H	184	8.50	27.50
10	909.15	36.10 QP	46.00	-9.90	1.00 H	237	8.10	28.00

ANTENNA POLARITY & TEST DISTANCE: VERTICAL AT 3 M

No.	Freq. (MHz)	Emission Level (dBuV/m)	Limit (dBuV/m)	Margin (dB)	Antenna Height (m)	Table Angle (Degree)	Raw Value (dBuV)	Correction Factor (dB/m)
1	49.65	26.30 QP	40.00	-13.70	1.00 V	178	15.60	10.70
2	150.53	29.20 QP	43.50	-14.30	1.04 V	135	16.80	12.40
3	215.55	29.50 QP	43.50	-14.00	1.06 V	64	17.50	12.00
4	307.80	30.60 QP	46.00	-15.40	1.00 V	36	14.20	16.40
5	463.38	35.00 QP	46.00	-11.00	1.00 V	79	14.80	20.20
6	580.95	33.80 QP	46.00	-12.20	1.83 V	175	10.60	23.10
7	618.28	33.20 QP	46.00	-12.80	1.69 V	277	9.40	23.70
8	725.78	36.10 QP	46.00	-9.90	1.45 V	288	10.70	25.40
9	830.87	34.10 QP	46.00	-11.90	1.33 V	171	6.60	27.50
10	917.22	35.10 QP	46.00	-10.90	1.21 V	197	6.80	28.30

- REMARKS:**
1. Emission level(dBuV/m)=Raw Value(dBuV) + Correction Factor(dB/m)
 2. Correction Factor(dB/m) = Antenna Factor (dB/m) + Cable Factor (dB)
 3. The other emission levels were very low against the limit.
 4. Margin value = Emission level – Limit value



Below 1GHz Worst-Case Data

EUT	Symbol WLAN 802.11abg Access Point	MODEL	AP-5131
TEST MODE	With POE	FREQUENCY RANGE	Below 1000MHz
MODULATION TYPE	BPSK	TRANSFER RATE	6Mbps
INPUT POWER (SYSTEM)	120Vac, 60 Hz	DETECTOR FUNCTION	Quasi-Peak
ENVIRONMENTAL CONDITIONS	27deg. C, 70%RH, 961hPa	TESTED BY	Jerry Fan

ANTENNA POLARITY & TEST DISTANCE: HORIZONTAL AT 3 M

No.	Freq. (MHz)	Emission Level (dBuV/m)	Limit (dBuV/m)	Margin (dB)	Antenna Height (m)	Table Angle (Degree)	Raw Value (dBuV)	Correction Factor (dB/m)
1	121.25	27.90 QP	43.50	-15.60	1.84 H	161	15.80	12.20
2	189.13	28.10 QP	43.50	-15.40	1.73 H	222	17.50	10.70
3	227.13	32.20 QP	46.00	-13.80	1.69 H	121	19.40	12.70
4	389.65	33.80 QP	46.00	-12.20	1.52 H	108	14.90	18.90
5	466.75	37.00 QP	46.00	-9.00	1.25 H	118	16.70	20.30
6	517.53	33.70 QP	46.00	-12.30	1.34 H	23	11.90	21.90
7	635.70	32.60 QP	46.00	-13.40	1.26 H	180	8.60	24.00
8	714.25	33.40 QP	46.00	-12.60	1.18 H	58	8.50	24.90
9	877.12	35.30 QP	46.00	-10.70	1.00 H	257	7.40	27.90
10	923.27	36.20 QP	46.00	-9.80	1.06 H	181	7.70	28.60

ANTENNA POLARITY & TEST DISTANCE: VERTICAL AT 3 M

No.	Freq. (MHz)	Emission Level (dBuV/m)	Limit (dBuV/m)	Margin (dB)	Antenna Height (m)	Table Angle (Degree)	Raw Value (dBuV)	Correction Factor (dB/m)
1	111.08	28.10 QP	43.50	-15.40	1.00 V	127	16.30	11.80
2	170.05	26.90 QP	43.50	-16.60	1.05 V	210	15.90	10.90
3	218.85	30.80 QP	46.00	-15.20	1.02 V	130	18.60	12.20
4	328.13	33.10 QP	46.00	-12.90	1.09 V	76	16.30	16.80
5	469.28	33.20 QP	46.00	-12.80	1.00 V	151	12.80	20.40
6	534.98	35.90 QP	46.00	-10.10	1.77 V	62	13.70	22.20
7	619.58	34.10 QP	46.00	-11.90	1.65 V	156	10.30	23.80
8	720.23	33.80 QP	46.00	-12.20	1.55 V	205	8.70	25.10
9	836.90	36.30 QP	46.00	-9.70	1.43 V	128	8.50	27.70
10	960.55	43.00 QP	54.00	-11.00	1.26 V	46	13.60	29.30

- REMARKS:**
1. Emission level(dBuV/m)=Raw Value(dBuV) + Correction Factor(dB/m)
 2. Correction Factor(dB/m) = Antenna Factor (dB/m) + Cable Factor (dB)
 3. The other emission levels were very low against the limit.
 4. Margin value = Emission level – Limit value

**802.11a OFDM modulation**

EUT	Symbol WLAN 802.11abg Access Point	MODEL	AP-5131
CHANNEL	Channel 1	FREQUENCY RANGE	1 ~ 40 GHz
MODULATION TYPE	BPSK	TRANSFER RATE	6Mbps
INPUT POWER (SYSTEM)	120Vac, 60 Hz	DETECTOR FUNCTION	Peak(PK) Average (AV)
ENVIRONMENTAL CONDITIONS	27deg. C, 53%RH, 961hPa	TESTED BY	Tony Chen

ANTENNA POLARITY & TEST DISTANCE: HORIZONTAL AT 3 M

No.	Freq. (MHz)	Emission Level (dBuV/m)	Limit (dBuV/m)	Margin (dB)	Antenna Height (m)	Table Angle (Degree)	Raw Value (dBuV)	Correction Factor (dB/m)
1	#5150.00	49.30 PK	74.00	-24.70	1.00 H	345	13.50	35.80
1	#5150.00	36.60 AV	54.00	-17.40	1.00 H	345	0.80	35.80
2	*5180.00	90.60 PK			1.00 H	345	54.80	35.80
2	*5180.00	81.60 AV			1.00 H	345	45.80	35.80
3	10360.00	51.00 PK	68.30	-17.30	1.36 H	23	6.80	44.10

ANTENNA POLARITY & TEST DISTANCE: VERTICAL AT 3 M

No.	Freq. (MHz)	Emission Level (dBuV/m)	Limit (dBuV/m)	Margin (dB)	Antenna Height (m)	Table Angle (Degree)	Raw Value (dBuV)	Correction Factor (dB/m)
1	#5150.00	63.90 PK	74.00	-10.10	1.22 V	359	28.10	35.80
1	#5150.00	51.10 AV	54.00	-2.90	1.22 V	359	15.30	35.80
2	*5180.00	105.20 PK			1.22 V	359	69.40	35.80
2	*5180.00	96.10 AV			1.22 V	359	60.30	35.80
3	10360.00	51.50 PK	68.30	-16.80	1.04 V	26	7.30	44.10

- NOTE:**
1. Emission level(dBuV/m)=Raw Value(dBuV) + Correction Factor(dB/m)
 2. Correction Factor(dB/m) = Antenna Factor (dB/m) + Cable Factor (dB)
 3. The other emission levels were very low against the limit.
 4. Margin value = Emission level – Limit value
 5. "*" : Fundamental frequency
 6. "#" The radiated frequency falling in the restricted band.



EUT	Symbol WLAN 802.11abg Access Point	MODEL	AP-5131
CHANNEL	Channel 4	FREQUENCY RANGE	1 ~ 40 GHz
MODULATION TYPE	BPSK	TRANSFER RATE	6Mbps
INPUT POWER (SYSTEM)	120Vac, 60 Hz	DETECTOR FUNCTION	Peak(PK) Average (AV)
ENVIRONMENTAL CONDITIONS	27deg. C, 53%RH, 961hPa	TESTED BY	Tony Chen

ANTENNA POLARITY & TEST DISTANCE: HORIZONTAL AT 3 M

No.	Freq. (MHz)	Emission Level (dBuV/m)	Limit (dBuV/m)	Margin (dB)	Antenna Height (m)	Table Angle (Degree)	Raw Value (dBuV)	Correction Factor (dB/m)
1	*5240.00	90.90 PK			1.01 H	346	55.10	35.80
1	*5240.00	81.90 AV			1.01 H	346	46.10	35.80
2	10480.00	51.90 PK	68.30	-16.40	1.34 H	27	7.40	44.40

ANTENNA POLARITY & TEST DISTANCE: VERTICAL AT 3 M

No.	Freq. (MHz)	Emission Level (dBuV/m)	Limit (dBuV/m)	Margin (dB)	Antenna Height (m)	Table Angle (Degree)	Raw Value (dBuV)	Correction Factor (dB/m)
1	*5240.00	105.60 PK			1.23 V	358	69.80	35.80
1	*5240.00	96.70 AV			1.23 V	358	60.90	35.80
2	10480.00	52.20 PK	68.30	-16.10	1.11 V	32	7.70	44.40

- NOTE:**
1. Emission level(dBuV/m)=Raw Value(dBuV) + Correction Factor(dB/m)
 2. Correction Factor(dB/m) = Antenna Factor (dB/m) + Cable Factor (dB)
 3. The other emission levels were very low against the limit.
 4. Margin value = Emission level – Limit value
 5. "*" : Fundamental frequency
 6. "#" The radiated frequency falling in the restricted band.



EUT	Symbol WLAN 802.11abg Access Point	MODEL	AP-5131
CHANNEL	Channel 5	FREQUENCY RANGE	1 ~ 40 GHz
MODULATION TYPE	BPSK	TRANSFER RATE	6Mbps
INPUT POWER (SYSTEM)	120Vac, 60 Hz	DETECTOR FUNCTION	Peak(PK) Average (AV)
ENVIRONMENTAL CONDITIONS	27deg. C, 53%RH, 961hPa	TESTED BY	Tony Chen

ANTENNA POLARITY & TEST DISTANCE: HORIZONTAL AT 3 M

No.	Freq. (MHz)	Emission Level (dBuV/m)	Limit (dBuV/m)	Margin (dB)	Antenna Height (m)	Table Angle (Degree)	Raw Value (dBuV)	Correction Factor (dB/m)
1	*5260.00	98.90 PK			1.00 H	347	63.10	35.80
1	*5260.00	90.20 AV			1.00 H	347	54.40	35.80
2	10520.00	52.70 PK	68.30	-15.60	1.27 H	48	8.00	44.70

ANTENNA POLARITY & TEST DISTANCE: VERTICAL AT 3 M

No.	Freq. (MHz)	Emission Level (dBuV/m)	Limit (dBuV/m)	Margin (dB)	Antenna Height (m)	Table Angle (Degree)	Raw Value (dBuV)	Correction Factor (dB/m)
1	*5260.00	112.80 PK			1.22 V	1	77.00	35.80
1	*5260.00	103.90 AV			1.22 V	1	68.10	35.80
2	10520.00	53.30 PK	68.30	-15.00	1.12 V	35	8.60	44.70

- NOTE:**
1. Emission level(dBuV/m)=Raw Value(dBuV) + Correction Factor(dB/m)
 2. Correction Factor(dB/m) = Antenna Factor (dB/m) + Cable Factor (dB)
 3. The other emission levels were very low against the limit.
 4. Margin value = Emission level – Limit value
 5. "*" : Fundamental frequency
 6. "#": The radiated frequency falling in the restricted band.



EUT	Symbol WLAN 802.11abg Access Point	MODEL	AP-5131
CHANNEL	Channel 8	FREQUENCY RANGE	1 ~ 40 GHz
MODULATION TYPE	BPSK	TRANSFER RATE	6Mbps
INPUT POWER (SYSTEM)	120Vac, 60 Hz	DETECTOR FUNCTION	Peak(PK) Average (AV)
ENVIRONMENTAL CONDITIONS	27deg. C, 53%RH, 961hPa	TESTED BY	Tony Chen

ANTENNA POLARITY & TEST DISTANCE: HORIZONTAL AT 3 M

No.	Freq. (MHz)	Emission Level (dBuV/m)	Limit (dBuV/m)	Margin (dB)	Antenna Height (m)	Table Angle (Degree)	Raw Value (dBuV)	Correction Factor (dB/m)
1	*5320.00	94.10 PK			1.06 H	347	58.30	35.80
1	*5320.00	85.40 AV			1.06 H	347	49.60	35.80
2	#5350.00	51.00 PK	74.00	-23.00	1.06 H	347	15.20	35.80
2	#5350.00	39.40 AV	54.00	-14.60	1.06 H	347	3.60	35.80
3	#10640.00	53.30 PK	74.00	-20.70	1.25 H	52	7.40	45.90
3	#10640.00	42.60 AV	54.00	-11.40	1.25 H	52	-3.30	45.90

ANTENNA POLARITY & TEST DISTANCE: VERTICAL AT 3 M

No.	Freq. (MHz)	Emission Level (dBuV/m)	Limit (dBuV/m)	Margin (dB)	Antenna Height (m)	Table Angle (Degree)	Raw Value (dBuV)	Correction Factor (dB/m)
1	*5320.00	107.60 PK			1.21 V	4	71.80	35.80
1	*5320.00	98.50 AV			1.21 V	4	62.70	35.80
2	#5350.00	64.50 PK	74.00	-9.50	1.21 V	4	28.70	35.80
2	#5350.00	52.50 AV	54.00	-1.50	1.21 V	4	16.70	35.80
3	#10640.00	54.20 PK	74.00	-19.80	1.07 V	25	8.30	45.90
3	#10640.00	43.30 AV	54.00	-10.70	1.07 V	25	-2.60	45.90

- NOTE:**
1. Emission level(dBuV/m)=Raw Value(dBuV) + Correction Factor(dB/m)
 2. Correction Factor(dB/m) = Antenna Factor (dB/m) + Cable Factor (dB)
 3. The other emission levels were very low against the limit.
 4. Margin value = Emission level – Limit value
 5. "*" : Fundamental frequency
 6. "#"The radiated frequency falling in the restricted band.

EUT	Symbol WLAN 802.11abg Access Point	MODEL	AP-5131
CHANNEL	Channel 9	FREQUENCY RANGE	1 ~ 40 GHz
MODULATION TYPE	BPSK	TRANSFER RATE	6Mbps
INPUT POWER (SYSTEM)	120Vac, 60 Hz	DETECTOR FUNCTION	Peak(PK) Average (AV)
ENVIRONMENTAL CONDITIONS	27deg. C, 53%RH, 961hPa	TESTED BY	Tony Chen

ANTENNA POLARITY & TEST DISTANCE: HORIZONTAL AT 3 M

No.	Freq. (MHz)	Emission Level (dBuV/m)	Limit (dBuV/m)	Margin (dB)	Antenna Height (m)	Table Angle (Degree)	Raw Value (dBuV)	Correction Factor (dB/m)
1	5715.00	64.60 PK	68.30	-3.70	1.16 H	352	28.30	36.30
2	5725.00	66.40 PK	78.30	-11.90	1.16 H	325	30.10	36.30
3	*5745.00	99.70 PK			1.17 H	352	63.30	36.40
3	*5745.00	90.90 AV			1.17 H	352	54.50	36.40
4	#11490.00	57.90 PK	74.00	-16.10	1.27 H	341	6.80	51.10
4	#11490.00	46.90 AV	54.00	-7.10	1.27 H	341	-4.20	51.10

ANTENNA POLARITY & TEST DISTANCE: VERTICAL AT 3 M

No.	Freq. (MHz)	Emission Level (dBuV/m)	Limit (dBuV/m)	Margin (dB)	Antenna Height (m)	Table Angle (Degree)	Raw Value (dBuV)	Correction Factor (dB/m)
1	5715.00	65.20 PK	68.30	-3.10	1.19 V	357	28.90	36.30
2	5725.00	75.40 PK	78.30	-2.90	1.19 V	358	39.10	36.30
3	*5745.00	112.70 PK			1.18 V	359	76.30	36.40
3	*5745.00	104.00 AV			1.18 V	359	67.60	36.40
4	#11490.00	58.30 PK	74.00	-15.70	1.32 V	23	7.20	51.10
4	#11490.00	47.20 AV	54.00	-6.80	1.32 V	23	-3.90	51.10

- NOTE:**
1. Emission level(dBuV/m)=Raw Value(dBuV) + Correction Factor(dB/m)
 2. Correction Factor(dB/m) = Antenna Factor (dB/m) + Cable Factor (dB)
 3. The other emission levels were very low against the limit.
 4. Margin value = Emission level – Limit value
 5. "*" : Fundamental frequency
 6. "#"The radiated frequency falling in the restricted band.



EUT	Symbol WLAN 802.11abg Access Point	MODEL	AP-5131
CHANNEL	Channel 12	FREQUENCY RANGE	1 ~ 40 GHz
MODULATION TYPE	BPSK	TRANSFER RATE	6Mbps
INPUT POWER (SYSTEM)	120Vac, 60 Hz	DETECTOR FUNCTION	Peak(PK) Average (AV)
ENVIRONMENTAL CONDITIONS	27deg. C, 53%RH, 961hPa	TESTED BY	Tony Chen

ANTENNA POLARITY & TEST DISTANCE: HORIZONTAL AT 3 M

No.	Freq. (MHz)	Emission Level (dBuV/m)	Limit (dBuV/m)	Margin (dB)	Antenna Height (m)	Table Angle (Degree)	Raw Value (dBuV)	Correction Factor (dB/m)
1	*5805.00	100.00 PK			1.16 H	343	63.40	36.60
1	*5805.00	91.40 AV			1.16 H	343	54.80	36.60
2	5825.00	66.40 PK	78.30	-11.90	1.17 H	344	29.80	36.60
3	5835.00	64.80 PK	68.30	-3.50	1.19 H	343	28.20	36.60
4	#11610.00	57.60 PK	74.00	-16.40	1.28 H	354	6.90	50.80
4	#11610.00	46.40 AV	54.00	-7.60	1.28 H	354	-4.30	50.80

ANTENNA POLARITY & TEST DISTANCE: VERTICAL AT 3 M

No.	Freq. (MHz)	Emission Level (dBuV/m)	Limit (dBuV/m)	Margin (dB)	Antenna Height (m)	Table Angle (Degree)	Raw Value (dBuV)	Correction Factor (dB/m)
1	*5805.00	113.30 PK			1.18 V	358	76.70	36.60
1	*5805.00	104.50 AV			1.18 V	358	67.90	36.60
2	5825.00	76.10 PK	78.30	-2.20	1.18 V	358	39.50	36.60
3	5835.00	65.40 PK	68.30	-2.90	1.18 V	357	28.80	36.60
4	#11610.00	57.80 PK	74.00	-16.20	1.36 V	31	7.10	50.80
4	#11610.00	46.60 AV	54.00	-7.40	1.36 V	31	-4.10	50.80

- NOTE:**
1. Emission level(dBuV/m)=Raw Value(dBuV) + Correction Factor(dB/m)
 2. Correction Factor(dB/m) = Antenna Factor (dB/m) + Cable Factor (dB)
 3. The other emission levels were very low against the limit.
 4. Margin value = Emission level – Limit value
 5. "*" : Fundamental frequency
 6. "#"The radiated frequency falling in the restricted band.

4.2.10 TEST RESULTS (ANTENNA 3)

Below 1GHz Worst-Case Data

EUT	Symbol WLAN 802.11abg Access Point	MODEL	AP-5131
TEST MODE	With Adapter	FREQUENCY RANGE	Below 1000MHz
MODULATION TYPE	BPSK	TRANSFER RATE	6Mbps
INPUT POWER (SYSTEM)	120Vac, 60 Hz	DETECTOR FUNCTION	Quasi-Peak
ENVIRONMENTAL CONDITIONS	27deg. C, 70%RH, 961hPa	TESTED BY	Jerry Fan

ANTENNA POLARITY & TEST DISTANCE: HORIZONTAL AT 3 M

No.	Freq. (MHz)	Emission Level (dBuV/m)	Limit (dBuV/m)	Margin (dB)	Antenna Height (m)	Table Angle (Degree)	Raw Value (dBuV)	Correction Factor (dB/m)
1	129.60	29.90 QP	43.50	-13.60	1.88 H	296	17.20	12.70
2	188.93	26.70 QP	43.50	-16.80	1.70 H	213	16.10	10.70
3	221.40	34.00 QP	46.00	-12.00	1.74 H	147	21.60	12.40
4	364.33	34.70 QP	46.00	-11.30	1.50 H	230	16.90	17.80
5	420.88	35.10 QP	46.00	-10.90	1.36 H	259	15.60	19.50
6	562.80	33.30 QP	46.00	-12.70	1.23 H	172	10.50	22.80
7	681.33	33.80 QP	46.00	-12.20	1.19 H	48	9.50	24.20
8	731.70	34.50 QP	46.00	-11.50	1.05 H	135	8.80	25.60
9	820.75	35.80 QP	46.00	-10.20	1.00 H	210	8.70	27.10
10	923.47	35.40 QP	46.00	-10.60	1.00 H	279	6.80	28.60

ANTENNA POLARITY & TEST DISTANCE: VERTICAL AT 3 M

No.	Freq. (MHz)	Emission Level (dBuV/m)	Limit (dBuV/m)	Margin (dB)	Antenna Height (m)	Table Angle (Degree)	Raw Value (dBuV)	Correction Factor (dB/m)
1	134.55	31.30 QP	43.50	-12.20	1.00 V	280	18.30	13.00
2	167.33	27.60 QP	43.50	-15.90	1.00 V	202	16.50	11.10
3	258.50	32.50 QP	46.00	-13.50	1.00 V	131	17.20	15.30
4	327.95	35.90 QP	46.00	-10.10	1.04 V	203	19.10	16.80
5	421.55	33.30 QP	46.00	-12.70	1.08 V	163	13.70	19.50
6	529.85	34.00 QP	46.00	-12.00	1.65 V	309	11.80	22.10
7	606.45	34.70 QP	46.00	-11.30	1.49 V	180	11.20	23.60
8	716.95	33.00 QP	46.00	-13.00	1.37 V	189	8.00	25.00
9	835.72	35.50 QP	46.00	-10.50	1.21 V	249	7.90	27.70
10	947.57	36.80 QP	46.00	-9.20	1.11 V	199	7.40	29.40

- REMARKS:**
1. Emission level(dBuV/m)=Raw Value(dBuV) + Correction Factor(dB/m)
 2. Correction Factor(dB/m) = Antenna Factor (dB/m) + Cable Factor (dB)
 3. The other emission levels were very low against the limit.
 4. Margin value = Emission level – Limit value

**Below 1GHz Worst-Case Data**

EUT	Symbol WLAN 802.11abg Access Point	MODEL	AP-5131
TEST MODE	With POE	FREQUENCY RANGE	Below 1000MHz
MODULATION TYPE	BPSK	TRANSFER RATE	6Mbps
INPUT POWER (SYSTEM)	120Vac, 60 Hz	DETECTOR FUNCTION	Quasi-Peak
ENVIRONMENTAL CONDITIONS	27deg. C, 70%RH, 961hPa	TESTED BY	Jerry Fan

ANTENNA POLARITY & TEST DISTANCE: HORIZONTAL AT 3 M

No.	Freq. (MHz)	Emission Level (dBuV/m)	Limit (dBuV/m)	Margin (dB)	Antenna Height (m)	Table Angle (Degree)	Raw Value (dBuV)	Correction Factor (dB/m)
1	134.90	30.80 QP	43.50	-12.70	1.79 H	72	17.80	13.00
2	168.05	26.60 QP	43.50	-16.90	1.77 H	35	15.60	11.00
3	239.03	30.80 QP	46.00	-15.20	1.67 H	110	17.30	13.50
4	365.43	35.40 QP	46.00	-10.60	1.58 H	137	17.50	17.90
5	468.15	34.10 QP	46.00	-11.90	1.50 H	223	13.70	20.40
6	526.05	35.40 QP	46.00	-10.60	1.34 H	232	13.40	22.00
7	632.25	34.80 QP	46.00	-11.20	1.18 H	314	10.80	23.90
8	766.98	36.80 QP	46.00	-9.20	1.06 H	212	10.40	26.40
9	830.17	34.00 QP	46.00	-12.00	1.00 H	186	6.50	27.50
10	929.52	36.00 QP	46.00	-10.00	1.00 H	260	7.20	28.80

ANTENNA POLARITY & TEST DISTANCE: VERTICAL AT 3 M

No.	Freq. (MHz)	Emission Level (dBuV/m)	Limit (dBuV/m)	Margin (dB)	Antenna Height (m)	Table Angle (Degree)	Raw Value (dBuV)	Correction Factor (dB/m)
1	112.98	28.10 QP	43.50	-15.40	1.02 V	270	16.20	11.90
2	189.98	29.50 QP	43.50	-14.00	1.06 V	196	18.80	10.70
3	255.35	31.00 QP	46.00	-15.00	1.00 V	280	16.10	14.90
4	368.35	35.10 QP	46.00	-10.90	1.07 V	179	17.10	18.00
5	429.98	34.30 QP	46.00	-11.70	1.00 V	177	14.70	19.60
6	588.90	34.80 QP	46.00	-11.20	1.90 V	79	11.50	23.30
7	632.60	34.00 QP	46.00	-12.00	1.77 V	98	10.00	23.90
8	726.10	35.80 QP	46.00	-10.20	1.66 V	124	10.40	25.40
9	814.25	36.40 QP	46.00	-9.60	1.48 V	202	9.50	26.90
10	933.50	35.80 QP	46.00	-10.20	1.52 V	268	6.90	28.90

- REMARKS:**
1. Emission level(dBuV/m)=Raw Value(dBuV) + Correction Factor(dB/m)
 2. Correction Factor(dB/m) = Antenna Factor (dB/m) + Cable Factor (dB)
 3. The other emission levels were very low against the limit.
 4. Margin value = Emission level – Limit value

802.11a OFDM modulation

EUT	Symbol WLAN 802.11abg Access Point	MODEL	AP-5131
CHANNEL	Channel 1	FREQUENCY RANGE	1 ~ 40 GHz
MODULATION TYPE	BPSK	TRANSFER RATE	6Mbps
INPUT POWER (SYSTEM)	120Vac, 60 Hz	DETECTOR FUNCTION	Peak(PK) Average (AV)
ENVIRONMENTAL CONDITIONS	27deg. C, 53%RH, 961hPa	TESTED BY	Tony Chen

ANTENNA POLARITY & TEST DISTANCE: HORIZONTAL AT 3 M

No.	Freq. (MHz)	Emission Level (dBuV/m)	Limit (dBuV/m)	Margin (dB)	Antenna Height (m)	Table Angle (Degree)	Raw Value (dBuV)	Correction Factor (dB/m)
1	#5143.00	46.60 PK	74.00	-27.40	1.11 H	80	10.80	35.80
1	#5143.00	34.90 AV	54.00	-19.10	1.11 H	80	-0.90	35.80
2	#5150.00	46.40 PK	74.00	-27.60	1.11 H	80	10.60	35.80
2	#5150.00	33.60 AV	54.00	-20.40	1.11 H	80	-2.20	35.80
3	*5180.00	93.30 PK			1.11 H	80	57.50	35.80
3	*5180.00	85.00 AV			1.11 H	80	49.20	35.80
4	10360.00	51.50 PK	68.30	-16.80	1.25 H	314	7.30	44.10

ANTENNA POLARITY & TEST DISTANCE: VERTICAL AT 3 M

No.	Freq. (MHz)	Emission Level (dBuV/m)	Limit (dBuV/m)	Margin (dB)	Antenna Height (m)	Table Angle (Degree)	Raw Value (dBuV)	Correction Factor (dB/m)
1	#5143.00	60.50 PK	74.00	-13.50	1.19 V	12	24.70	35.80
1	#5143.00	48.20 AV	54.00	-5.80	1.19 V	12	12.40	35.80
2	#5150.00	60.30 PK	74.00	-13.70	1.19 V	12	24.50	35.80
2	#5150.00	46.90 AV	54.00	-7.10	1.19 V	12	11.10	35.80
3	*5180.00	107.20 PK			1.19 V	12	71.40	35.80
3	*5180.00	98.30 AV			1.19 V	12	62.50	35.80
4	10360.00	52.30 PK	68.30	-16.00	1.34 V	47	8.10	44.10

- NOTE:**
1. Emission level(dBuV/m)=Raw Value(dBuV) + Correction Factor(dB/m)
 2. Correction Factor(dB/m) = Antenna Factor (dB/m) + Cable Factor (dB)
 3. The other emission levels were very low against the limit.
 4. Margin value = Emission level – Limit value
 5. "*" : Fundamental frequency
 6. "#"The radiated frequency falling in the restricted band.



EUT	Symbol WLAN 802.11abg Access Point	MODEL	AP-5131
CHANNEL	Channel 4	FREQUENCY RANGE	1 ~ 40 GHz
MODULATION TYPE	BPSK	TRANSFER RATE	6Mbps
INPUT POWER (SYSTEM)	120Vac, 60 Hz	DETECTOR FUNCTION	Peak(PK) Average (AV)
ENVIRONMENTAL CONDITIONS	27deg. C, 53%RH, 961hPa	TESTED BY	Tony Chen

ANTENNA POLARITY & TEST DISTANCE: HORIZONTAL AT 3 M

No.	Freq. (MHz)	Emission Level (dBuV/m)	Limit (dBuV/m)	Margin (dB)	Antenna Height (m)	Table Angle (Degree)	Raw Value (dBuV)	Correction Factor (dB/m)
1	*5240.00	94.40 PK			1.12 H	84	58.60	35.80
1	*5240.00	86.20 AV			1.12 H	84	50.40	35.80
2	10480.00	51.50 PK	68.30	-16.80	1.21 H	305	7.00	44.40

ANTENNA POLARITY & TEST DISTANCE: VERTICAL AT 3 M

No.	Freq. (MHz)	Emission Level (dBuV/m)	Limit (dBuV/m)	Margin (dB)	Antenna Height (m)	Table Angle (Degree)	Raw Value (dBuV)	Correction Factor (dB/m)
1	*5240.00	108.30 PK			1.19 V	8	72.50	35.80
1	*5240.00	99.60 AV			1.19 V	8	63.80	35.80
2	10480.00	52.70 PK	68.30	-15.60	1.33 V	56	8.20	44.40

- NOTE:**
1. Emission level(dBuV/m)=Raw Value(dBuV) + Correction Factor(dB/m)
 2. Correction Factor(dB/m) = Antenna Factor (dB/m) + Cable Factor (dB)
 3. The other emission levels were very low against the limit.
 4. Margin value = Emission level – Limit value
 5. "*" : Fundamental frequency
 6. "#" The radiated frequency falling in the restricted band.



EUT	Symbol WLAN 802.11abg Access Point	MODEL	AP-5131
CHANNEL	Channel 5	FREQUENCY RANGE	1 ~ 40 GHz
MODULATION TYPE	BPSK	TRANSFER RATE	6Mbps
INPUT POWER (SYSTEM)	120Vac, 60 Hz	DETECTOR FUNCTION	Peak(PK) Average (AV)
ENVIRONMENTAL CONDITIONS	27deg. C, 53%RH, 961hPa	TESTED BY	Tony Chen

ANTENNA POLARITY & TEST DISTANCE: HORIZONTAL AT 3 M

No.	Freq. (MHz)	Emission Level (dBuV/m)	Limit (dBuV/m)	Margin (dB)	Antenna Height (m)	Table Angle (Degree)	Raw Value (dBuV)	Correction Factor (dB/m)
1	*5260.00	101.40 PK			1.11 H	91	65.60	35.80
1	*5260.00	92.90 AV			1.11 H	91	57.10	35.80
2	10520.00	54.70 PK	68.30	-13.60	1.28 H	276	10.00	44.70

ANTENNA POLARITY & TEST DISTANCE: VERTICAL AT 3 M

No.	Freq. (MHz)	Emission Level (dBuV/m)	Limit (dBuV/m)	Margin (dB)	Antenna Height (m)	Table Angle (Degree)	Raw Value (dBuV)	Correction Factor (dB/m)
1	*5260.00	114.10 PK			1.18 V	7	78.30	35.80
1	*5260.00	106.10 AV			1.18 V	7	70.30	35.80
2	10520.00	56.20 PK	68.30	-12.10	1.27 V	64	11.50	44.70

- NOTE:**
1. Emission level(dBuV/m)=Raw Value(dBuV) + Correction Factor(dB/m)
 2. Correction Factor(dB/m) = Antenna Factor (dB/m) + Cable Factor (dB)
 3. The other emission levels were very low against the limit.
 4. Margin value = Emission level – Limit value
 5. "*" : Fundamental frequency
 6. "#": The radiated frequency falling in the restricted band.



EUT	Symbol WLAN 802.11abg Access Point	MODEL	AP-5131
CHANNEL	Channel 8	FREQUENCY RANGE	1 ~ 40 GHz
MODULATION TYPE	BPSK	TRANSFER RATE	6Mbps
INPUT POWER (SYSTEM)	120Vac, 60 Hz	DETECTOR FUNCTION	Peak(PK) Average (AV)
ENVIRONMENTAL CONDITIONS	27deg. C, 53%RH, 961hPa	TESTED BY	Tony Chen

ANTENNA POLARITY & TEST DISTANCE: HORIZONTAL AT 3 M

No.	Freq. (MHz)	Emission Level (dBuV/m)	Limit (dBuV/m)	Margin (dB)	Antenna Height (m)	Table Angle (Degree)	Raw Value (dBuV)	Correction Factor (dB/m)
1	*5320.00	98.20 PK			1.13 H	87	62.40	35.80
1	*5320.00	90.00 AV			1.13 H	87	54.20	35.80
2	#5350.00	49.30 PK	74.00	-24.70	1.13 H	87	13.50	35.80
2	#5350.00	37.80 AV	54.00	-16.20	1.13 H	87	2.00	35.80
3	5356.00	48.50 PK	74.00	-25.50	1.13 H	87	12.70	35.80
4	#10640.00	55.60 PK	74.00	-18.40	1.24 H	331	9.70	45.90
4	#10640.00	45.10 AV	54.00	-8.90	1.24 H	331	-0.80	45.90

ANTENNA POLARITY & TEST DISTANCE: VERTICAL AT 3 M

No.	Freq. (MHz)	Emission Level (dBuV/m)	Limit (dBuV/m)	Margin (dB)	Antenna Height (m)	Table Angle (Degree)	Raw Value (dBuV)	Correction Factor (dB/m)
1	*5320.00	111.30 PK			1.17 V	3	75.50	35.80
1	*5320.00	73.40 AV			1.17 V	3	37.60	35.80
2	#5350.00	62.40 PK	74.00	-11.60	1.17 V	3	26.70	35.80
2	#5350.00	51.20 AV	54.00	-2.80	1.17 V	3	15.40	35.80
3	5356.00	61.60 PK	74.00	-12.40	1.17 V	3	25.80	35.80
4	#10640.00	56.50 PK	74.00	-17.50	1.28 V	26	10.60	45.90
4	#10640.00	45.80 AV	54.00	-8.20	1.28 V	26	-0.10	45.90

- NOTE:**
1. Emission level(dBuV/m)=Raw Value(dBuV) + Correction Factor(dB/m)
 2. Correction Factor(dB/m) = Antenna Factor (dB/m) + Cable Factor (dB)
 3. The other emission levels were very low against the limit.
 4. Margin value = Emission level – Limit value
 5. "*" : Fundamental frequency
 6. "#"The radiated frequency falling in the restricted band.



EUT	Symbol WLAN 802.11abg Access Point	MODEL	AP-5131
CHANNEL	Channel 9	FREQUENCY RANGE	1 ~ 40 GHz
MODULATION TYPE	BPSK	TRANSFER RATE	6Mbps
INPUT POWER (SYSTEM)	120Vac, 60 Hz	DETECTOR FUNCTION	Peak(PK) Average (AV)
ENVIRONMENTAL CONDITIONS	27deg. C, 53%RH, 961hPa	TESTED BY	Tony Chen

ANTENNA POLARITY & TEST DISTANCE: HORIZONTAL AT 3 M

No.	Freq. (MHz)	Emission Level (dBuV/m)	Limit (dBuV/m)	Margin (dB)	Antenna Height (m)	Table Angle (Degree)	Raw Value (dBuV)	Correction Factor (dB/m)
1	5715.00	63.80 PK	68.30	-4.50	1.27 H	98	27.50	36.30
2	5725.00	68.50 PK	78.30	-9.80	1.25 H	96	32.20	36.30
3	*5745.00	97.10 PK			1.24 H	87	60.70	36.40
3	*5745.00	88.80 AV			1.24 H	87	52.40	36.40
4	#11490.00	57.50 PK	74.00	-16.50	1.09 H	43	6.40	51.10
4	#11490.00	46.30 AV	54.00	-7.70	1.09 H	43	-4.80	51.10

ANTENNA POLARITY & TEST DISTANCE: VERTICAL AT 3 M

No.	Freq. (MHz)	Emission Level (dBuV/m)	Limit (dBuV/m)	Margin (dB)	Antenna Height (m)	Table Angle (Degree)	Raw Value (dBuV)	Correction Factor (dB/m)
1	5715.00	64.40 PK	68.30	-3.90	1.10 V	317	28.10	36.30
2	5725.00	75.20 PK	78.30	-3.10	1.09 V	317	38.90	36.30
3	*5745.00	109.10 PK			1.09 V	316	72.70	36.40
3	*5745.00	100.70 AV			1.09 V	316	64.30	36.40
4	#11490.00	58.30 PK	74.00	-15.70	1.46 V	257	7.20	51.10
4	#11490.00	46.70 AV	54.00	-7.30	1.46 V	257	-4.40	51.10

- NOTE:**
1. Emission level(dBuV/m)=Raw Value(dBuV) + Correction Factor(dB/m)
 2. Correction Factor(dB/m) = Antenna Factor (dB/m) + Cable Factor (dB)
 3. The other emission levels were very low against the limit.
 4. Margin value = Emission level – Limit value
 5. "*" : Fundamental frequency
 6. "#"The radiated frequency falling in the restricted band.



EUT	Symbol WLAN 802.11abg Access Point	MODEL	AP-5131
CHANNEL	Channel 12	FREQUENCY RANGE	1 ~ 40 GHz
MODULATION TYPE	BPSK	TRANSFER RATE	6Mbps
INPUT POWER (SYSTEM)	120Vac, 60 Hz	DETECTOR FUNCTION	Peak(PK) Average (AV)
ENVIRONMENTAL CONDITIONS	27deg. C, 53%RH, 961hPa	TESTED BY	Tony Chen

ANTENNA POLARITY & TEST DISTANCE: HORIZONTAL AT 3 M

No.	Freq. (MHz)	Emission Level (dBuV/m)	Limit (dBuV/m)	Margin (dB)	Antenna Height (m)	Table Angle (Degree)	Raw Value (dBuV)	Correction Factor (dB/m)
1	*5805.00	97.70 PK			1.27 H	96	61.10	36.60
1	*5805.00	89.20 AV			1.27 H	96	52.60	36.60
2	5825.00	69.70 PK	78.30	-8.60	1.26 H	96	33.10	36.60
3	5835.00	64.50 PK	68.30	-3.80	1.26 H	98	27.90	36.60
4	#11610.00	57.30 PK	74.00	-16.70	1.12 H	37	6.60	50.80
4	#11610.00	46.00 AV	54.00	-8.00	1.12 H	37	-4.70	50.80

ANTENNA POLARITY & TEST DISTANCE: VERTICAL AT 3 M

No.	Freq. (MHz)	Emission Level (dBuV/m)	Limit (dBuV/m)	Margin (dB)	Antenna Height (m)	Table Angle (Degree)	Raw Value (dBuV)	Correction Factor (dB/m)
1	*5805.00	109.10 PK			1.11 V	323	72.50	36.60
1	*5805.00	100.80 AV			1.11 V	323	64.20	36.60
2	5825.00	75.70 PK	78.30	-2.60	1.12 V	324	39.10	36.60
3	5835.00	65.00 PK	68.30	-3.30	1.11 V	324	28.40	36.60
4	#11610.00	57.90 PK	74.00	-16.10	1.46 V	257	7.20	50.80
4	#11610.00	46.50 AV	54.00	-7.50	1.46 V	257	-4.20	50.80

- NOTE:**
1. Emission level(dBuV/m)=Raw Value(dBuV) + Correction Factor(dB/m)
 2. Correction Factor(dB/m) = Antenna Factor (dB/m) + Cable Factor (dB)
 3. The other emission levels were very low against the limit.
 4. Margin value = Emission level – Limit value
 5. "*" : Fundamental frequency
 6. "#"The radiated frequency falling in the restricted band.



4.3 PEAK TRANSMIT POWER MEASUREMENT

4.3.1 LIMITS OF PEAK TRANSMIT POWER MEASUREMENT

Frequency Band	Limit
5.15 – 5.25GHz	The lesser of 50mW (17dBm) or 4dBm + 10logB
5.25 – 5.35GHz	The lesser of 250mW (24dBm) or 11dBm + 10logB
5.725 – 5.825GHz	The lesser of 1W (30dBm) or 17dBm + 10logB

NOTE: Where B is the 26dB emission bandwidth in MHz.

4.3.2 TEST INSTRUMENTS

Description & Manufacturer	Model No.	Serial No.	Calibrated Until
R&S SPECTRUM ANALYZER	FSP40	100036	Nov. 23, 2005

NOTE:

- 1.The measurement uncertainty is less than +/- 2.6dB, which is calculated as per the NAMAS document NIS81. This uncertainty represents an expanded uncertainty expressed at approximately the 95% confidence level using a coverage factor of k=2.
- 2.The calibration interval of the above test instruments is 12 months and the calibrations are traceable to NML/ROC and NIST/USA.

4.3.3 TEST PROCEDURE

1. The transmitter output was connected to the spectrum analyzer.
2. Set span to encompass the entire emission bandwidth of the signal.
3. Set RBW to 1MHz, VBW to 300kHz.
4. Using the spectrum analyzer's channel power measurement function to measure the output power.

NOTE:

The test is performed in accordance with FCC Public Notice: APPENDIX A Guidelines for Assessing Unlicensed National Information Infrastructure (U-NII) Devices – Part 15, Subpart E, August 2002.

The transmitter output operates continuously therefore Method # 1 is used.

4.3.4 DEVIATION FROM TEST STANDARD

No deviation

4.3.5 TEST SETUP

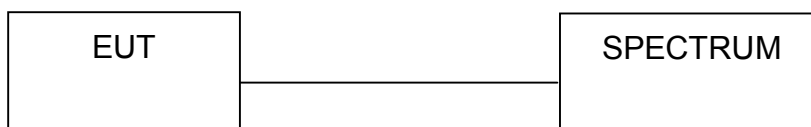

4.3.6 EUT OPERATING CONDITIONS

The software provided by client to enable the EUT under transmission condition continuously at specific channel frequencies individually.

4.3.7 TEST RESULTS (ANTENNA 1)

802.11a OFDM modulation

EUT	Symbol WLAN 802.11abg Access Point	MODEL	AP-5131
MODULATION TYPE	BPSK	TRANSFER RATE	6Mbps
INPUT POWER (SYSTEM)	120Vac, 60 Hz	ENVIRONMENTAL CONDITIONS	26deg.C, 64%RH, 961hPa
TESTED BY	Rex Huang		

Antenna 1 (Gain : 4.0 dBi)

CHANNEL	CHANNEL FREQUENCY (MHz)	PEAK POWER OUTPUT (dBm)	PEAK POWER LIMIT (dBm)	26dBc Occupied Bandwidth (MHz)	PASS/FAIL
1	5180	16.04	17	19.60	PASS
4	5240	16.33	17	19.67	PASS
5	5260	23.03	24	20.18	PASS
8	5320	21.59	24	24.16	PASS
9	5745	18.68	30	20.58	PASS
12	5805	18.79	30	21.28	PASS

NOTE: The 26dBc Occupied Bandwidth plot, please refer to the following pages.



Peak Power Output:
CH1

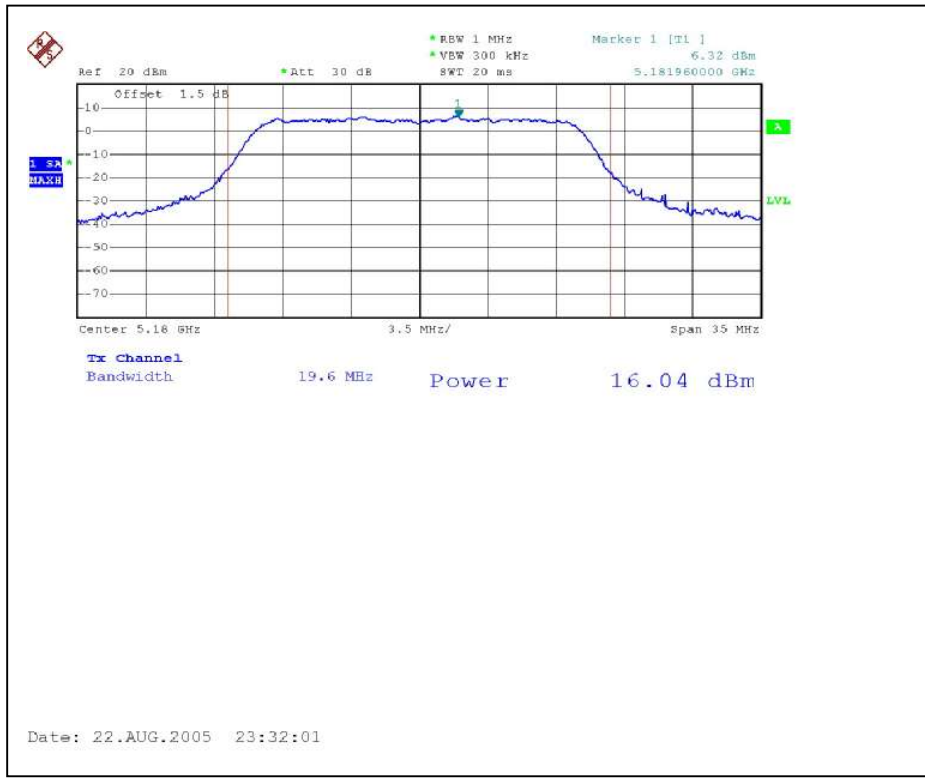

CH4





CH5

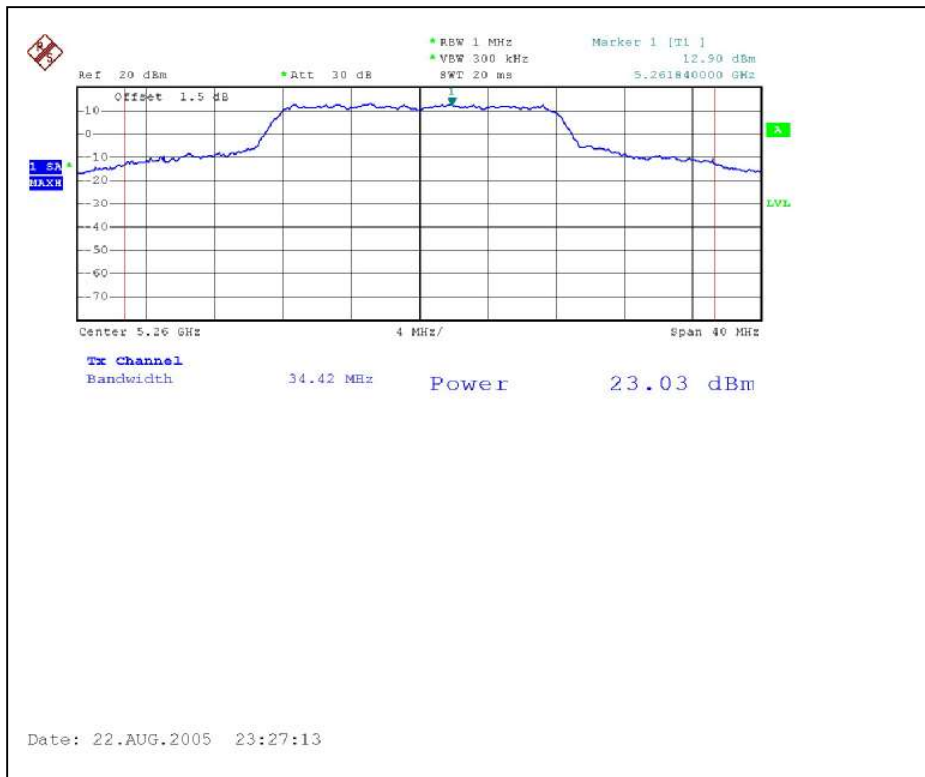

CH8

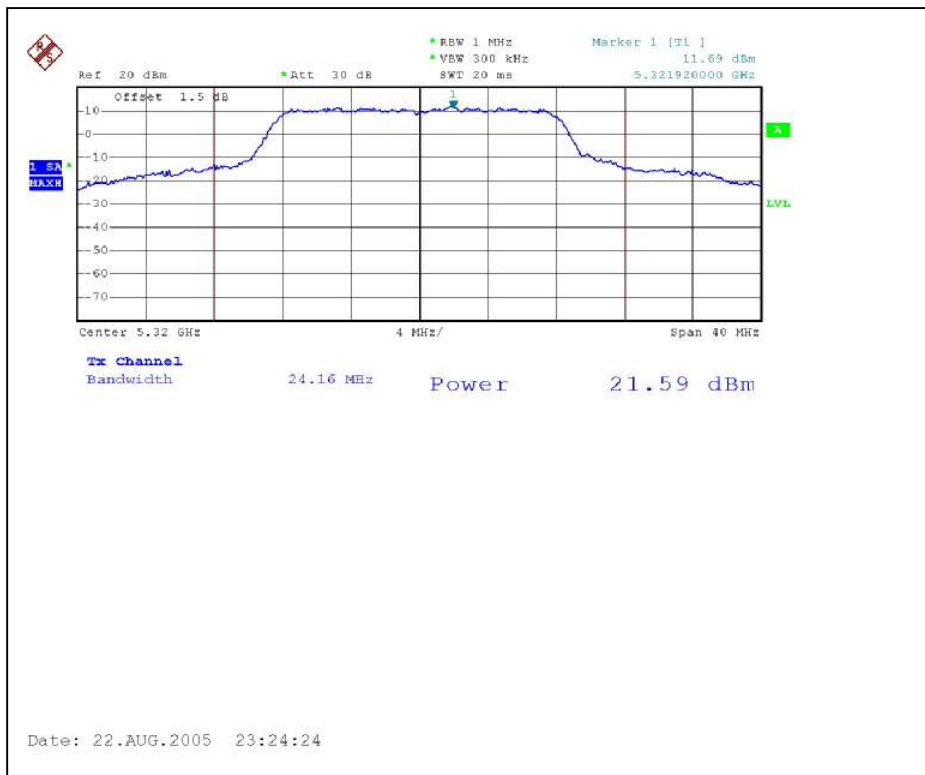



CH9

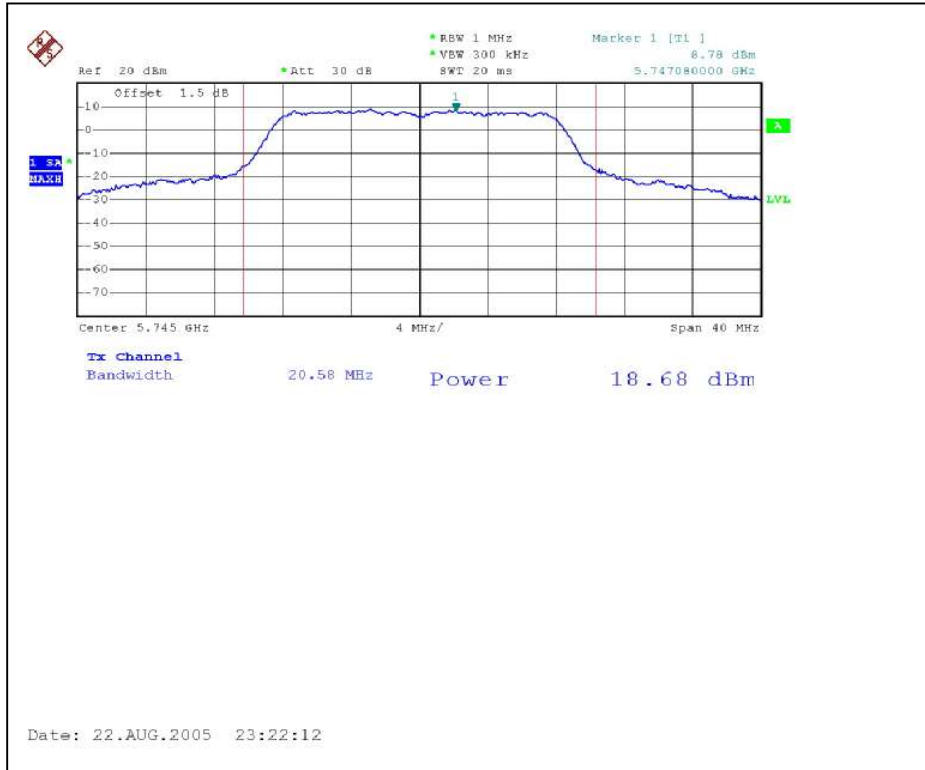

CH12

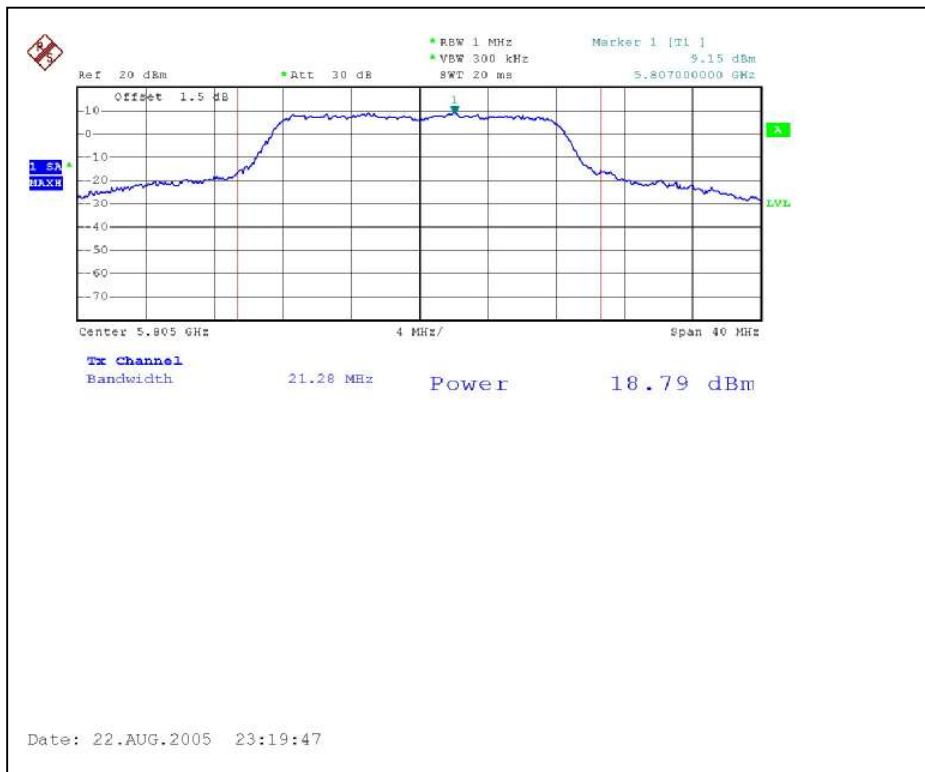



26dB Occupied Bandwidth:
CH1

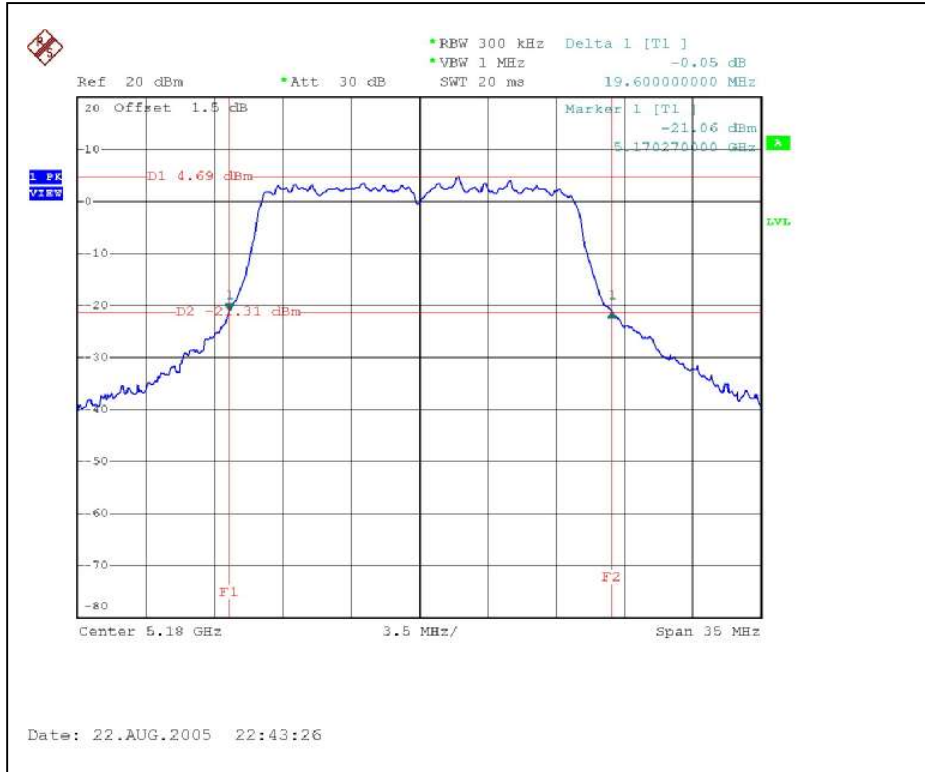

CH4

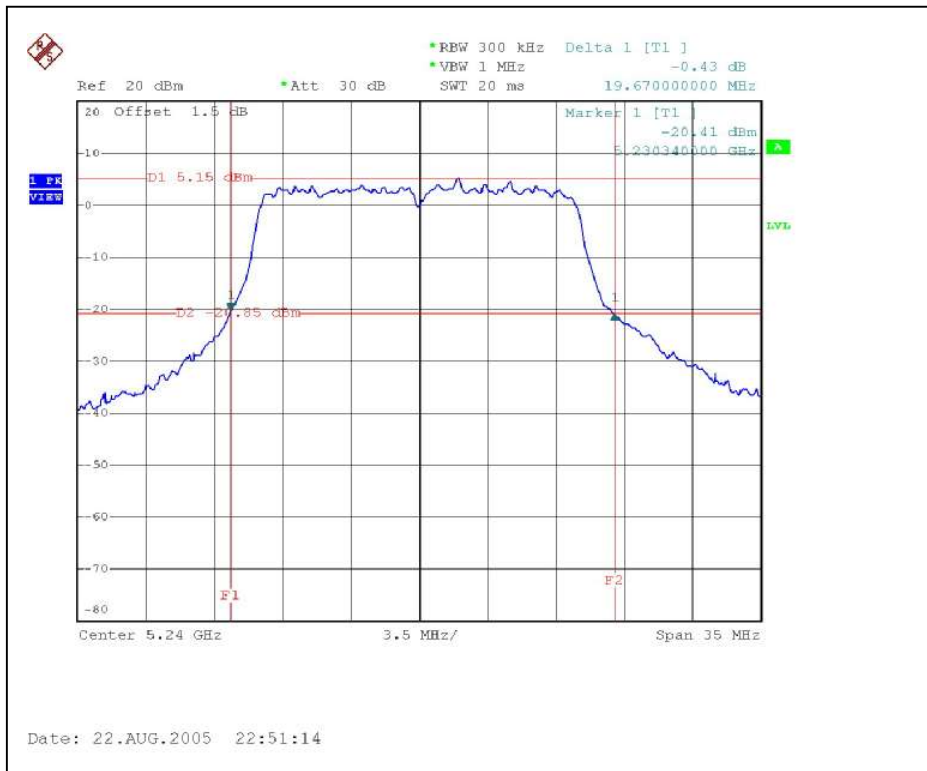



CH5

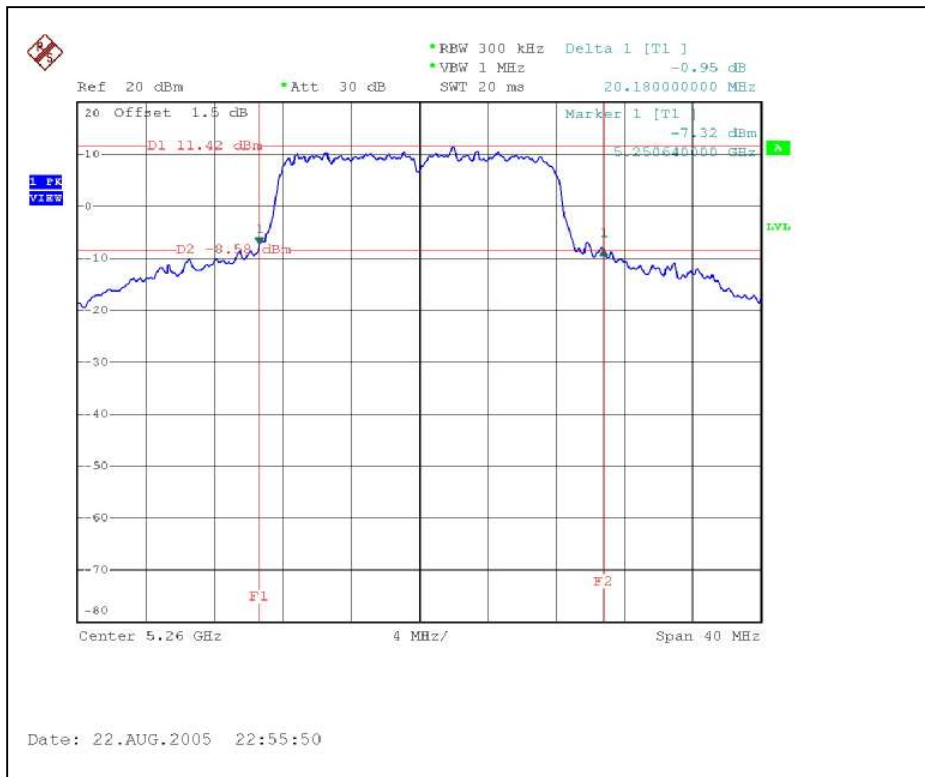

CH8

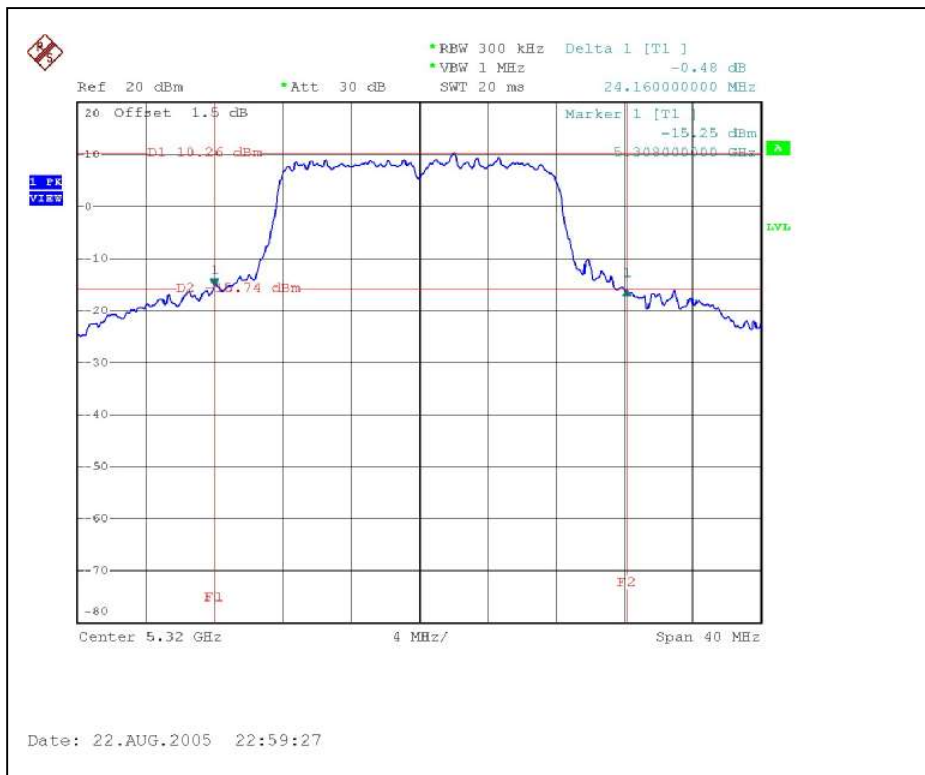



CH9

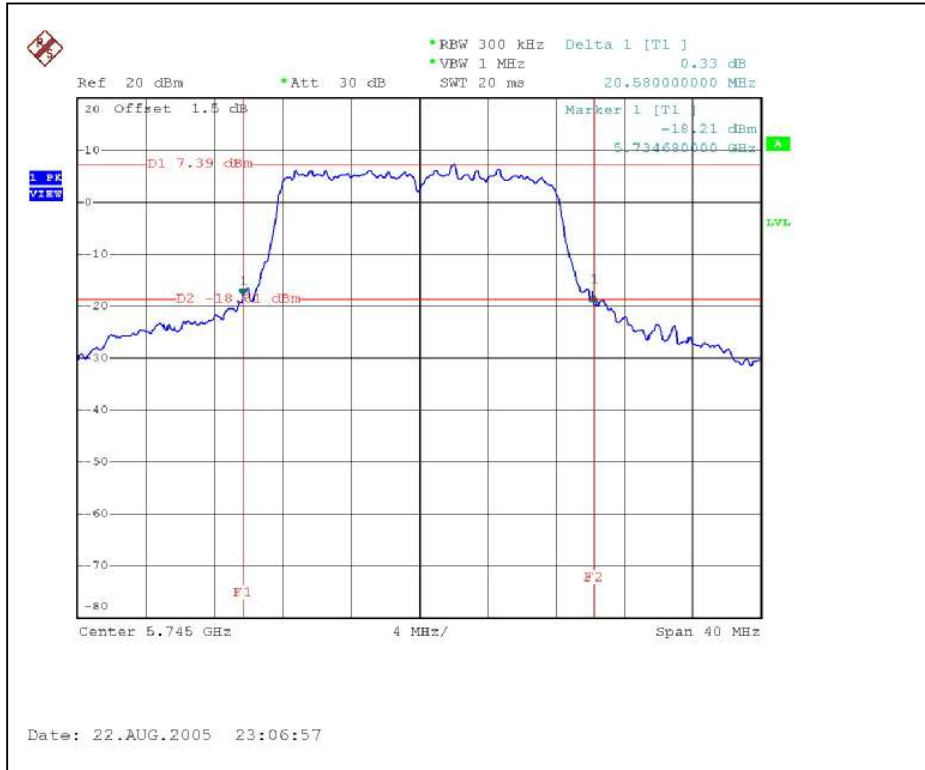

CH12

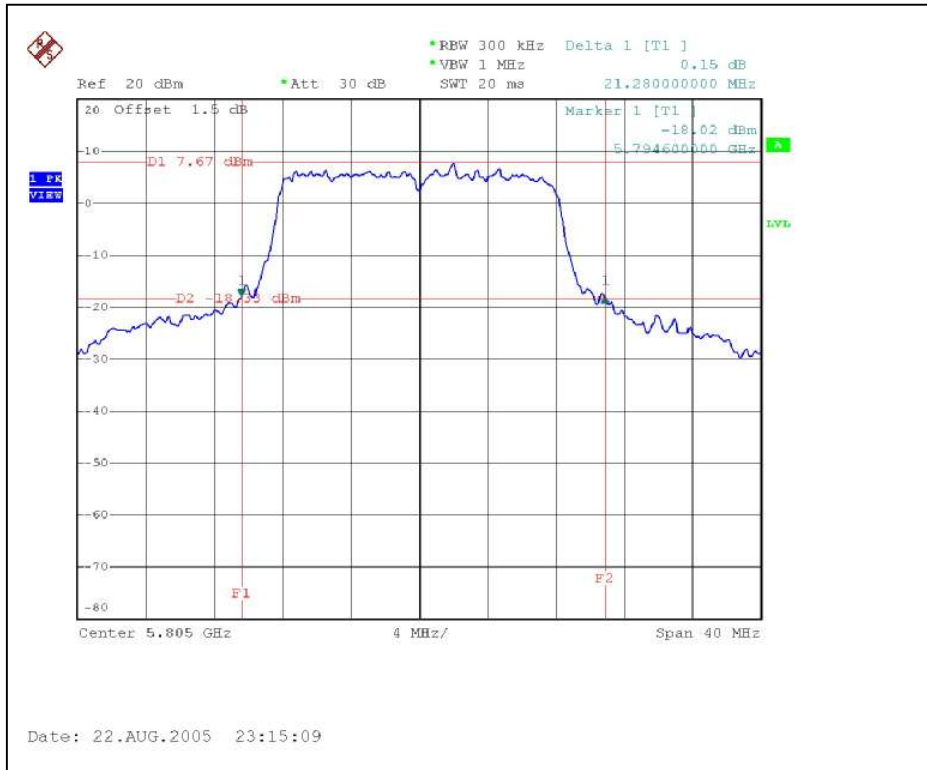

4.3.8 TEST RESULTS (ANTENNA 2)

802.11a OFDM modulation

EUT	Symbol WLAN 802.11abg Access Point	MODEL	AP-5131
MODULATION TYPE	BPSK	TRANSFER RATE	6Mbps
INPUT POWER (SYSTEM)	120Vac, 60 Hz	ENVIRONMENTAL CONDITIONS	26deg.C, 64%RH, 961hPa
TESTED BY	Rex Huang		

Antenna 2 (Gain : 14.2 dBi) +Cable loss (1.2dB)

CHANNEL	CHANNEL FREQUENCY (MHz)	PEAK POWER OUTPUT (dBm)	PEAK POWER LIMIT (dBm)	26dBc Occupied Bandwidth (MHz)	PASS/FAIL
1	5180	8.96	10	19.46	PASS
4	5240	9.08	10	19.39	PASS
5	5260	16.44	17	19.62	PASS
8	5320	11.59	17	19.70	PASS
9	5745	17.65	23	20.42	PASS
12	5805	17.72	23	20.48	PASS

NOTE: The 26dBc Occupied Bandwidth plot, please refer to the following pages.



Peak Power Output:
CH1

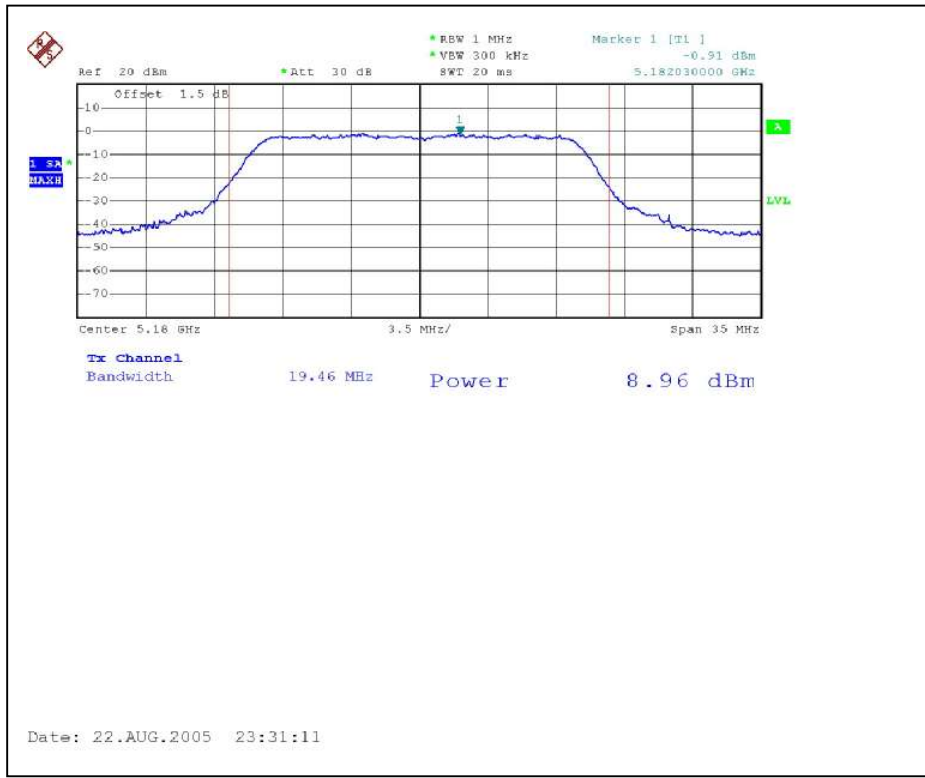

CH4

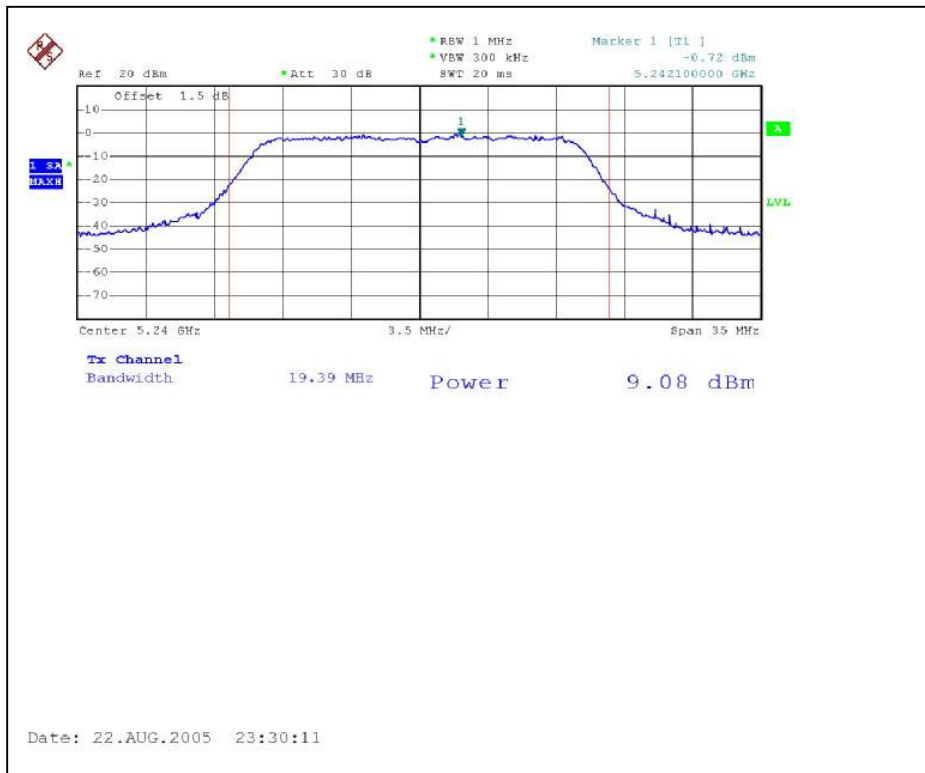



CH5

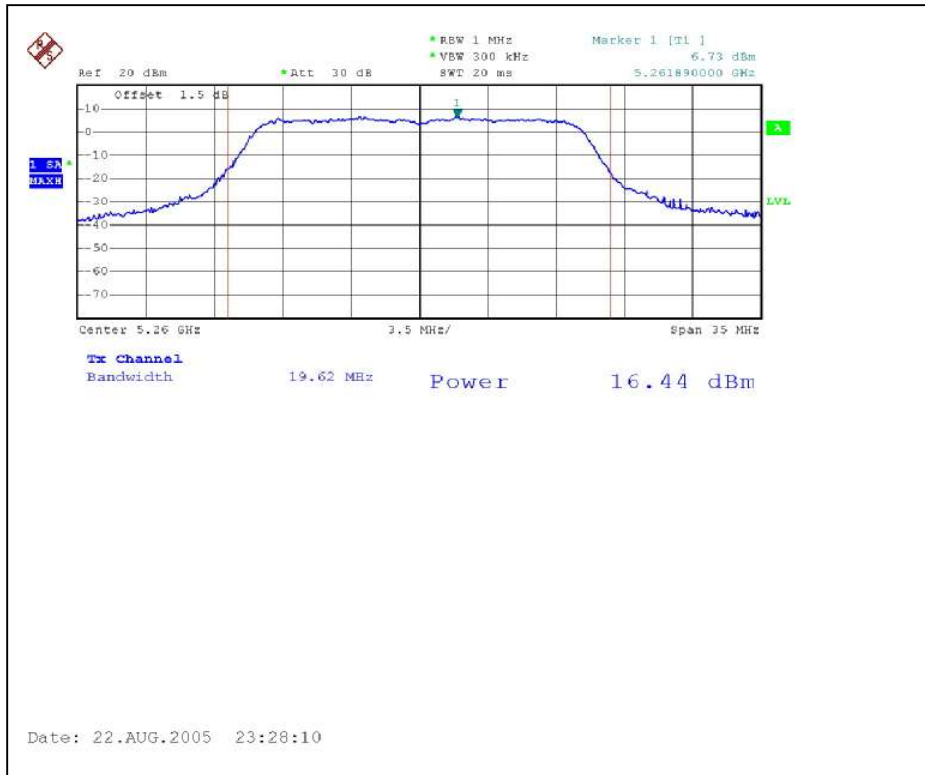

CH8

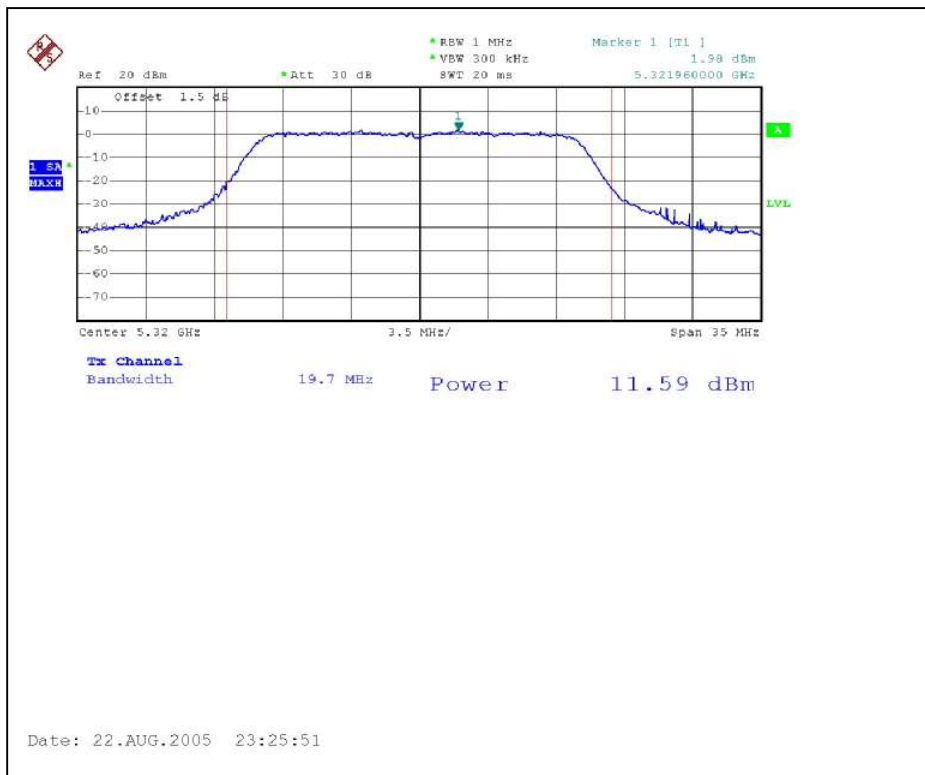



CH9

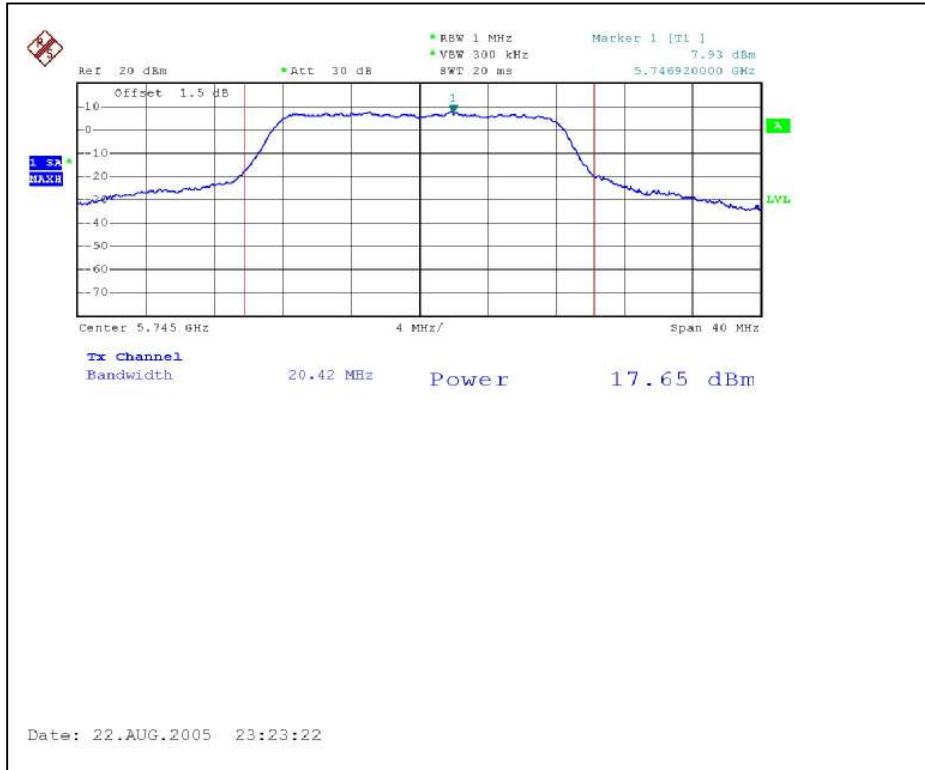

CH12

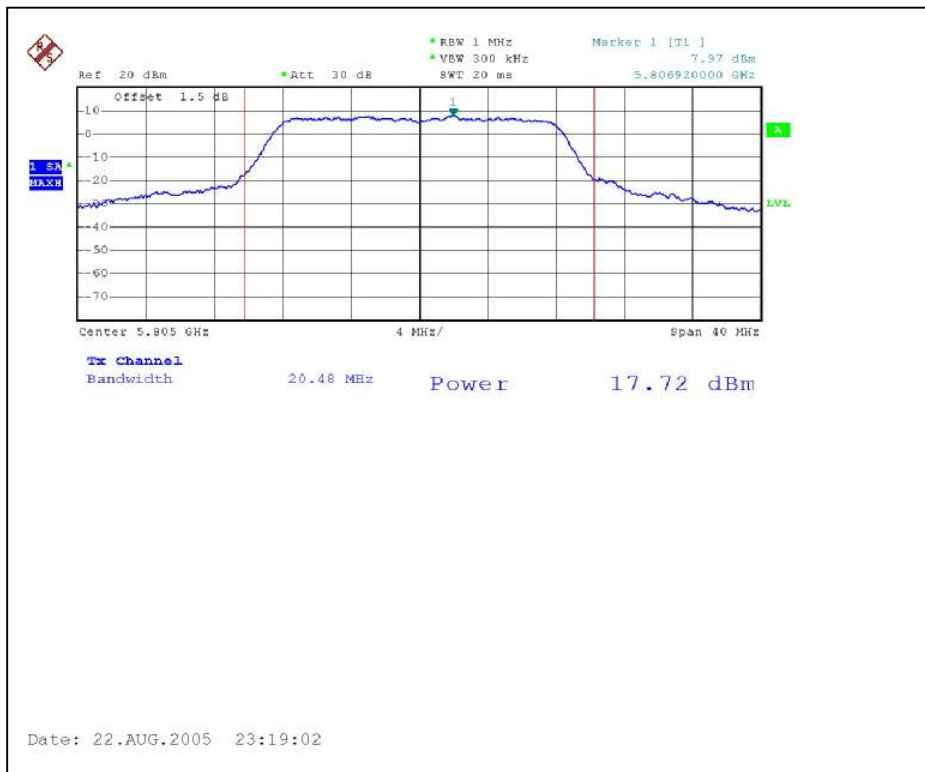



26dB Occupied Bandwidth:
CH1

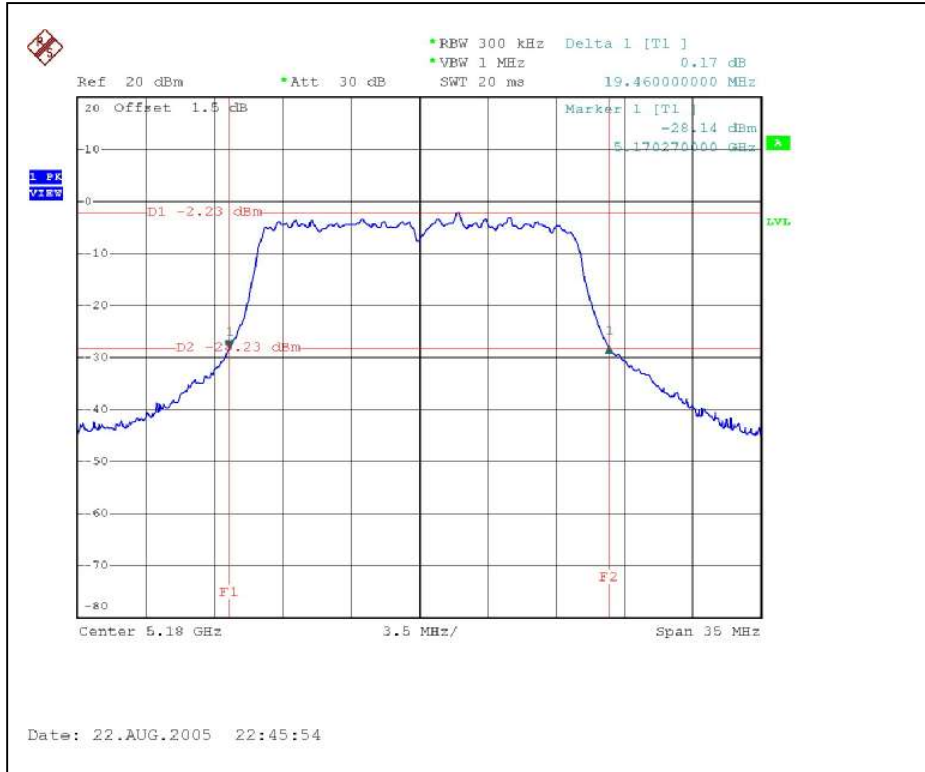

CH4

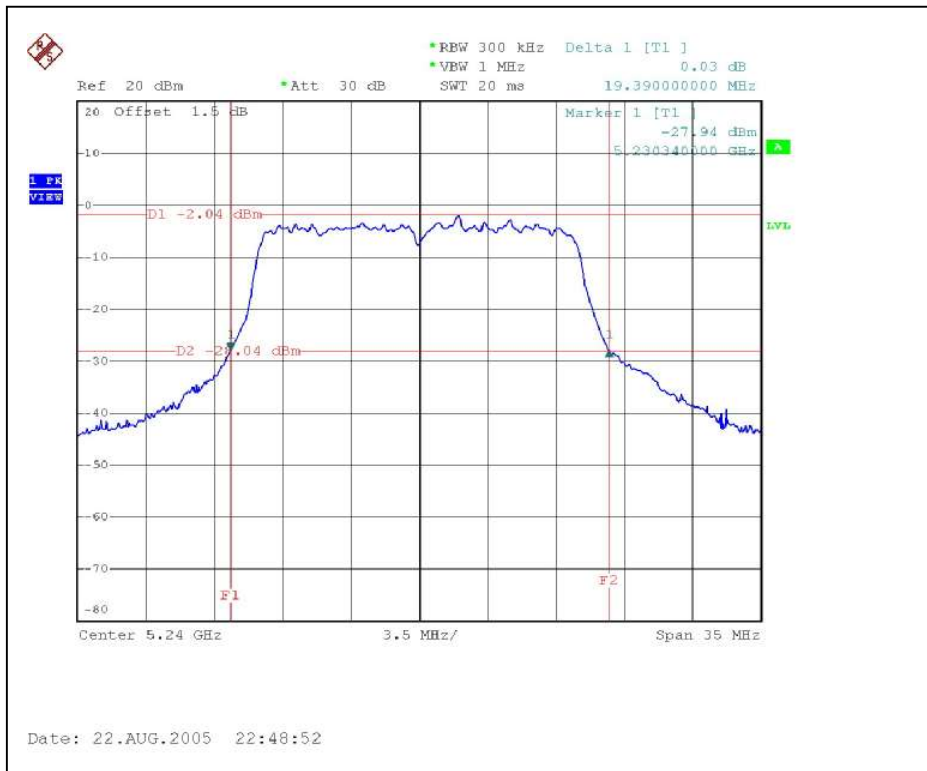



CH5

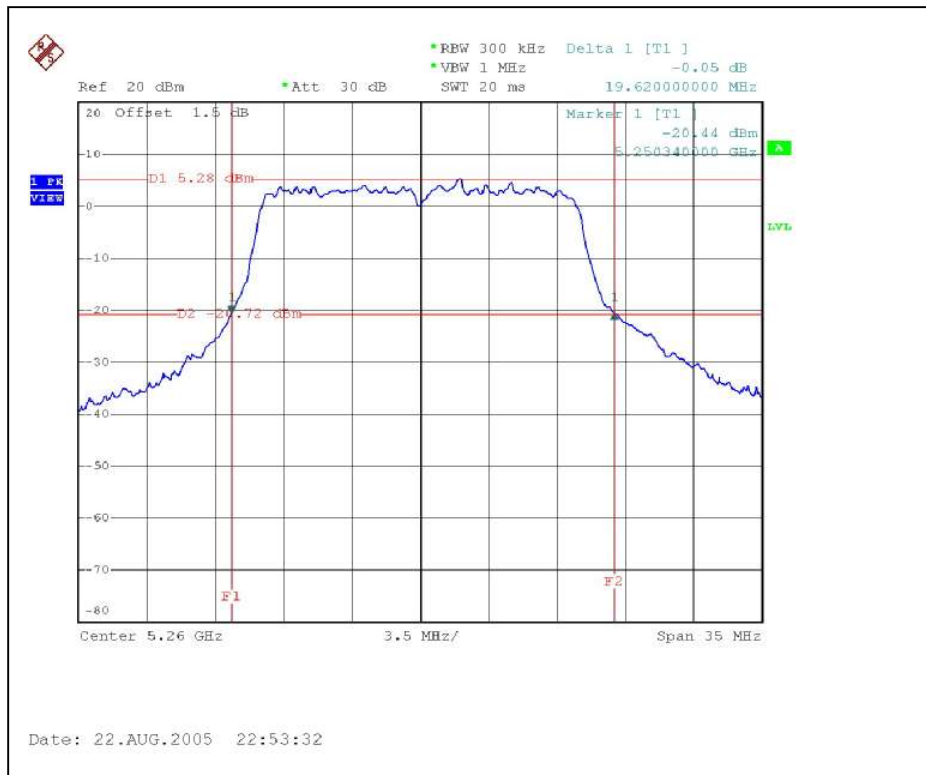

CH8

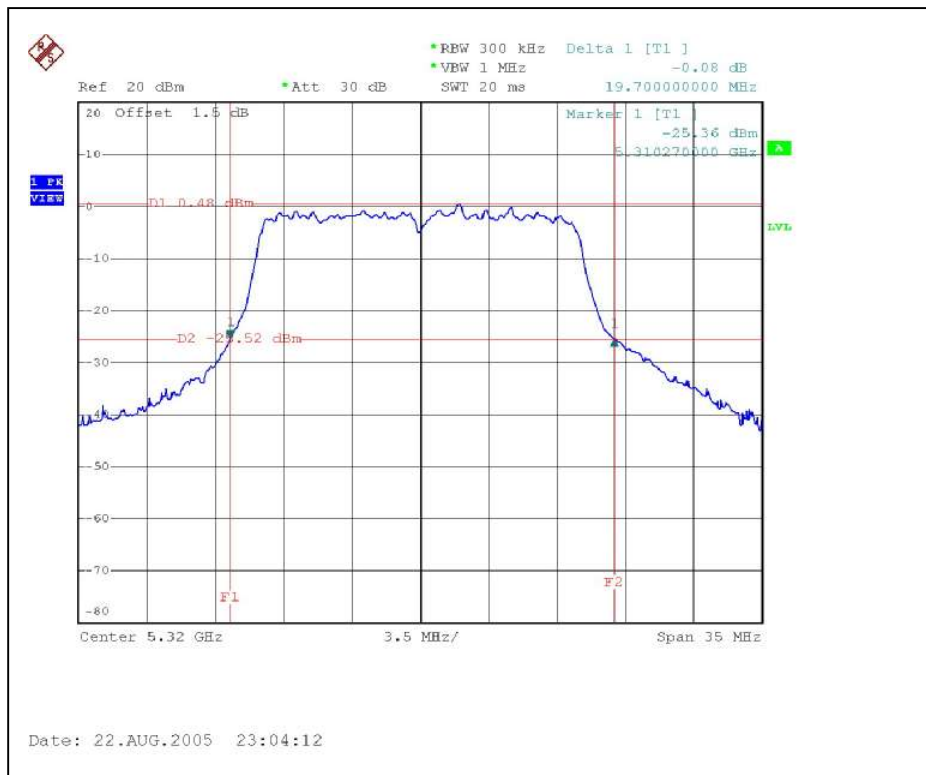



CH9

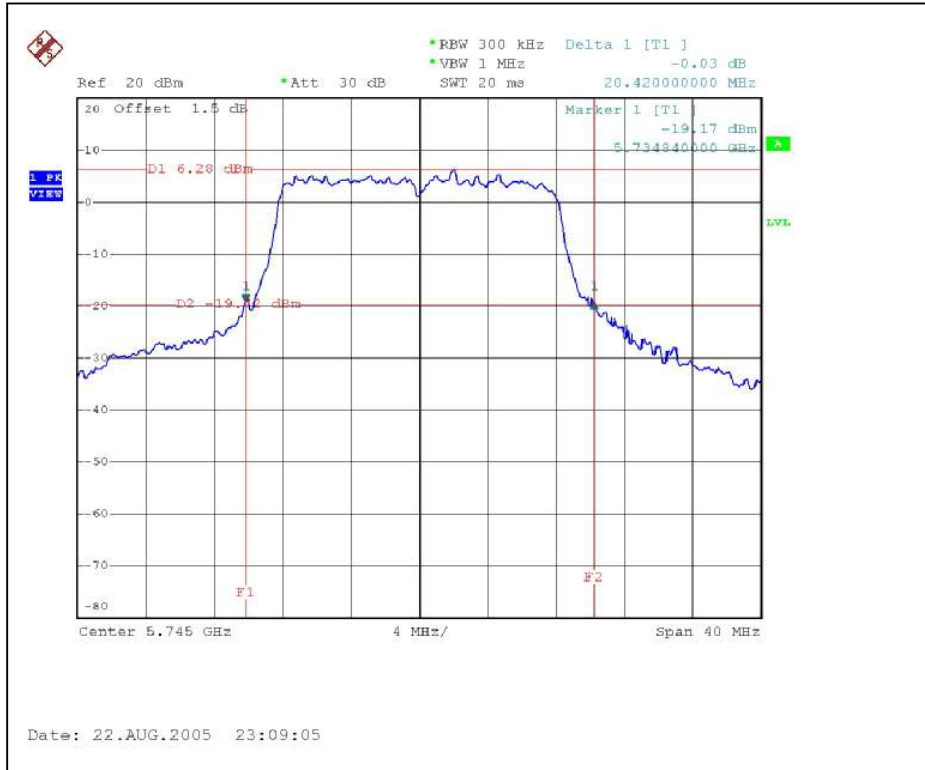

CH12

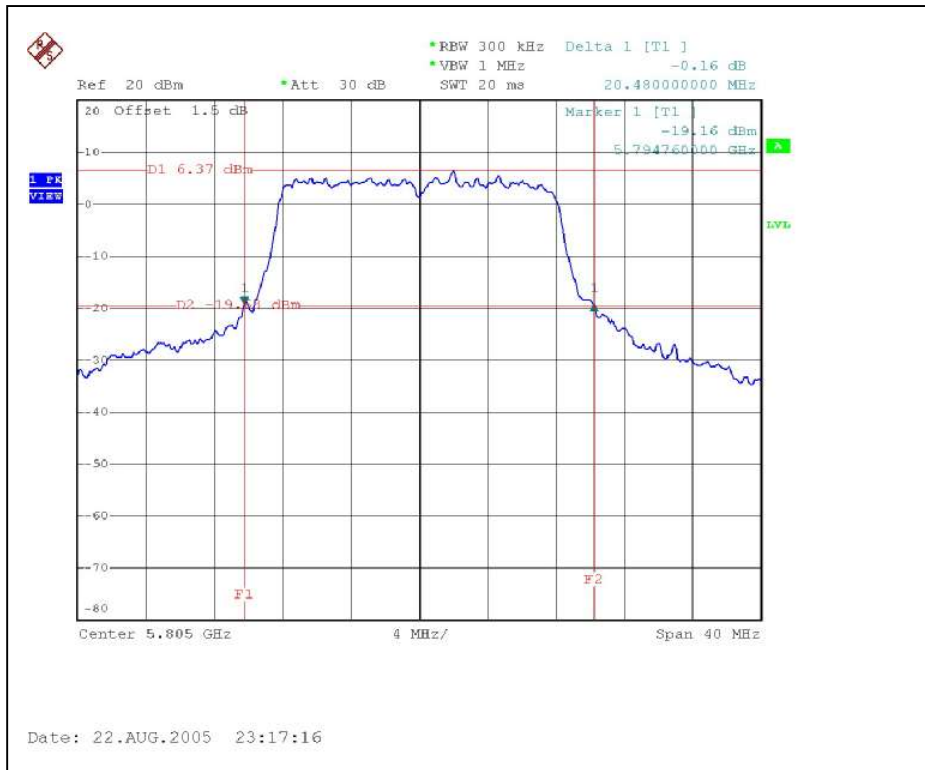



4.3.9 TEST RESULTS (ANTENNA 3)

802.11a OFDM modulation

EUT	Symbol WLAN 802.11abg Access Point	MODEL	AP-5131
MODULATION TYPE	BPSK	TRANSFER RATE	6Mbps
INPUT POWER (SYSTEM)	120Vac, 60 Hz	ENVIRONMENTAL CONDITIONS	27deg.C, 53%RH, 961hPa
TESTED BY	Rex Huang		

Antenna 3 (Gain : 5.9 dBi) +Cable loss (0.84dB)

CHANNEL	CHANNEL FREQUENCY (MHz)	PEAK POWER OUTPUT (dBm)	PEAK POWER LIMIT (dBm)	26dBc Occupied Bandwidth (MHz)	PASS/FAIL
1	5180	16.04	17	19.60	PASS
4	5240	16.33	17	19.67	PASS
5	5260	23.03	24	34.42	PASS
8	5320	20.67	24	20.96	PASS
9	5745	18.68	30	20.58	PASS
12	5805	18.79	30	21.28	PASS

NOTE: The 26dBc Occupied Bandwidth plot, please refer to the following pages.



Peak Power Output:
CH1



CH4

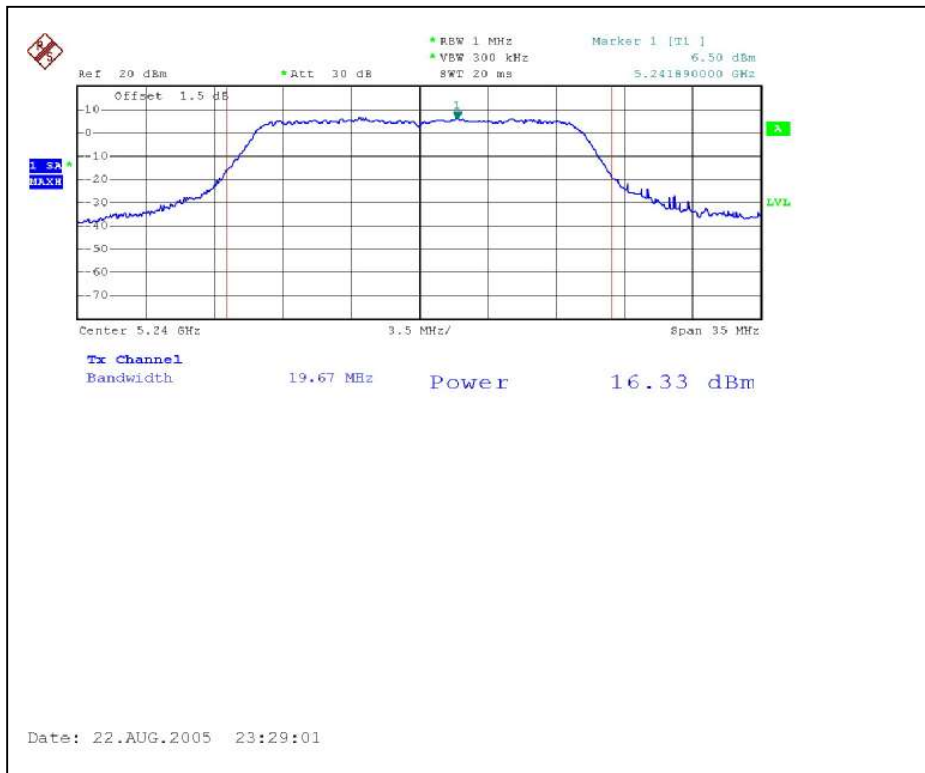



CH5

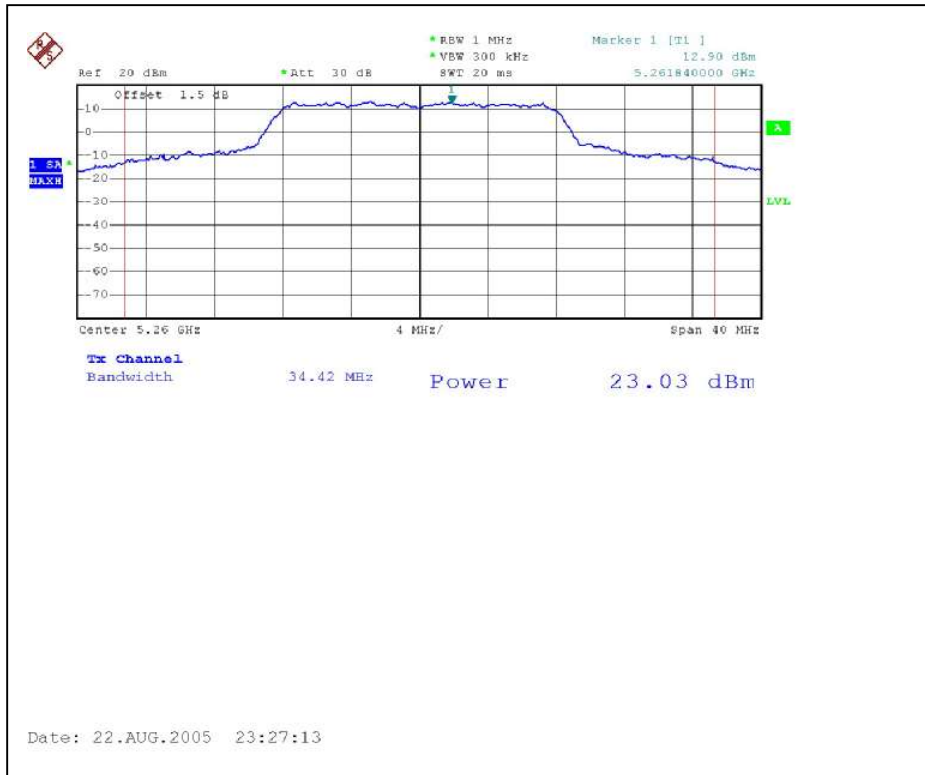

CH8

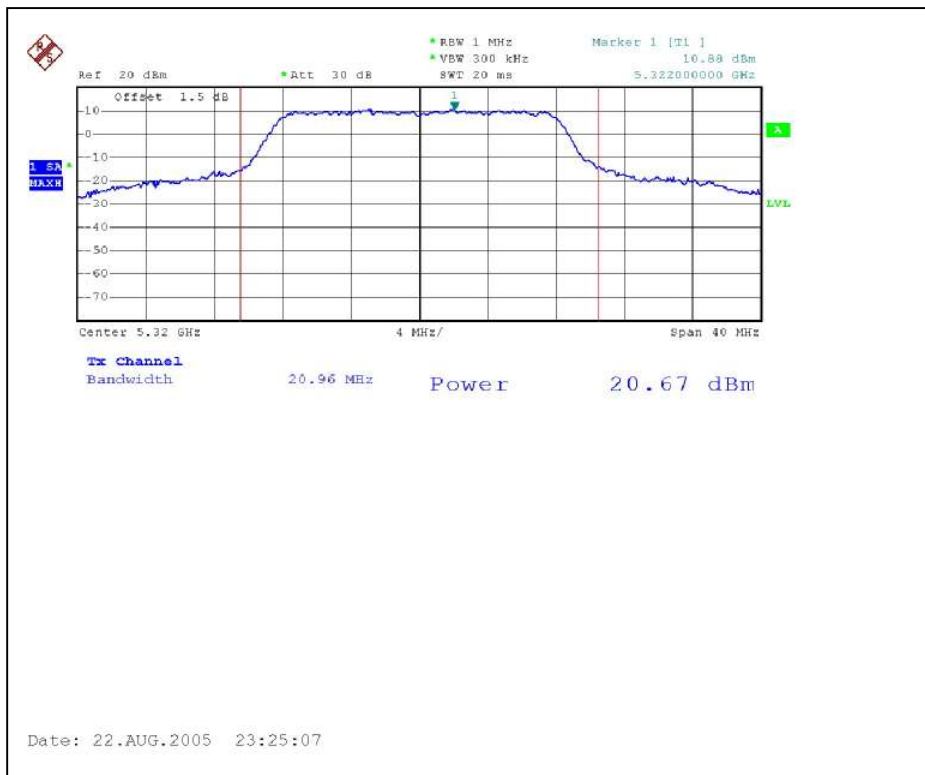



CH9

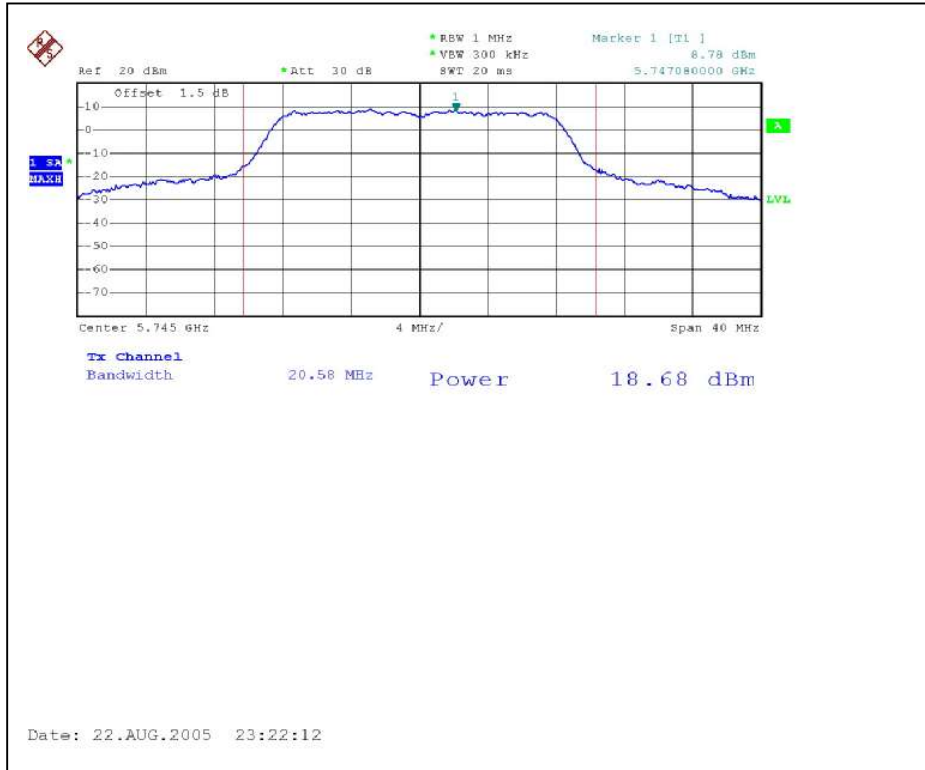

CH12

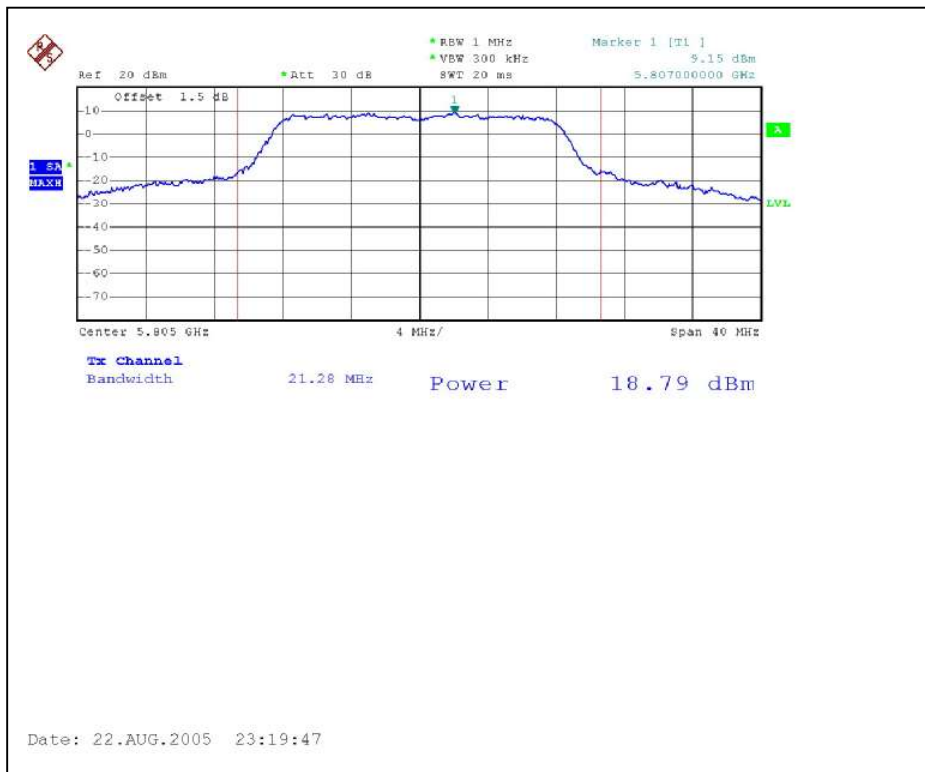



26dB Occupied Bandwidth:
CH1



CH4

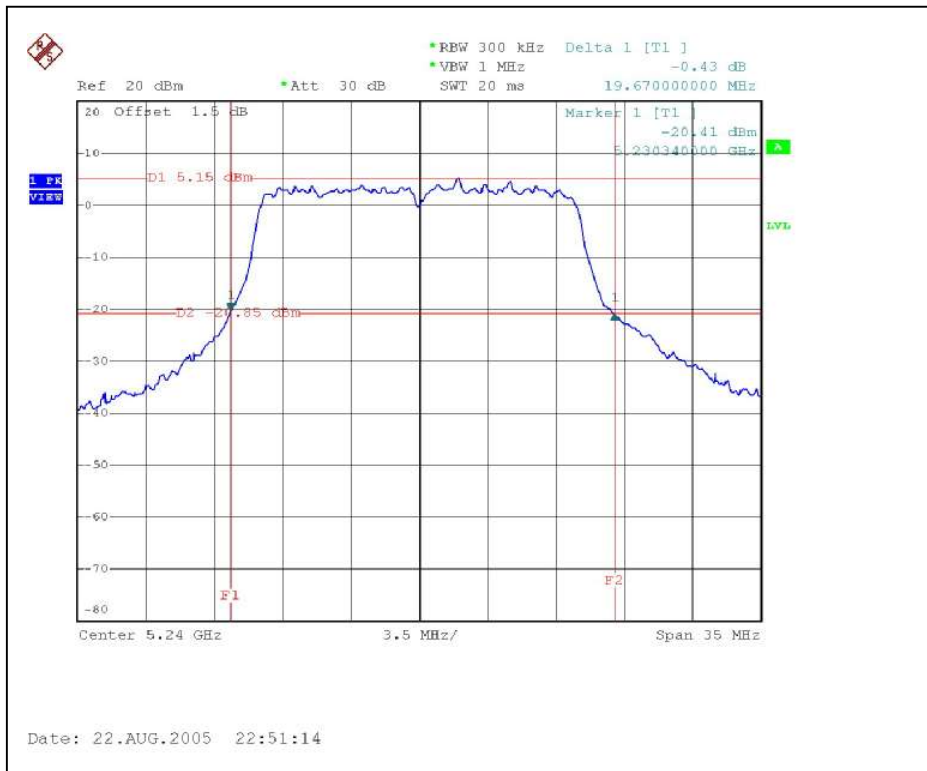



CH5

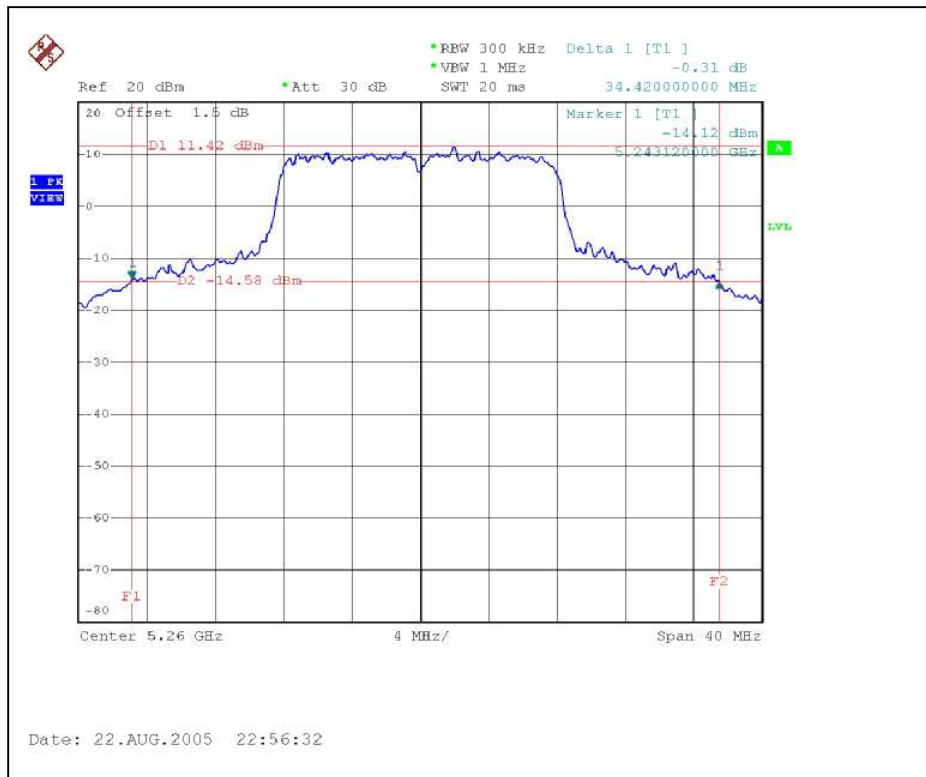

CH8

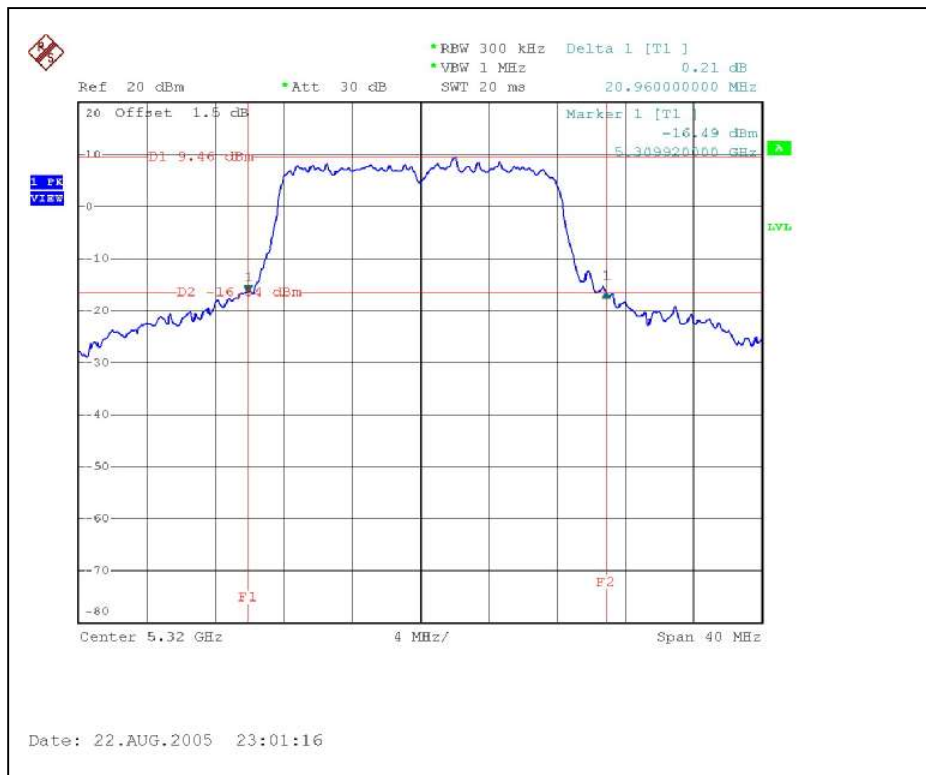



CH9



CH12

