



For the latest version of this guide go to: <http://www.symbol.com/manuals>.

United States	1-800-653-5350	Canada	905-629-7226
Latin America	0800 328 2424	Asia/Pacific	+65-6796-9600
United Kingdom	1-800-672-906	Austria/Osterreich	01-5055794-0
France	01-40-96-52-21	Germany/Deutschland	6074-49020
Netherlands/ Nederland	2-484441	Mexico/México	5-520-1835
Denmark/Danmark	7020-1718	Finland/Suomi	9 5407 580
Italy/Italia	315-271700	Norway/Norge	+47 2232 4375
South Africa	11-809 5311	Spain/España	91 324 40 00
Sweden/Sverige	08 445 29 00	Outside Spain	+34 91 324 40 00
Europe/Mid-East	+1 800-347-0178	Inside US	1-800-347-0178
Sales Support	+1-954-255-2610	Outside US	+1-954-255-2610
Distributor Operations	+44 118 945 7360		

Before using the unit, it must be configured to operate in the facility's network and run your applications. If you have a problem running your unit or using your equipment, contact your facility's Technical or Systems Support. If there is a problem with the equipment, they will contact the Symbol Support Center.

Service Information

Cradle Parts (Front)

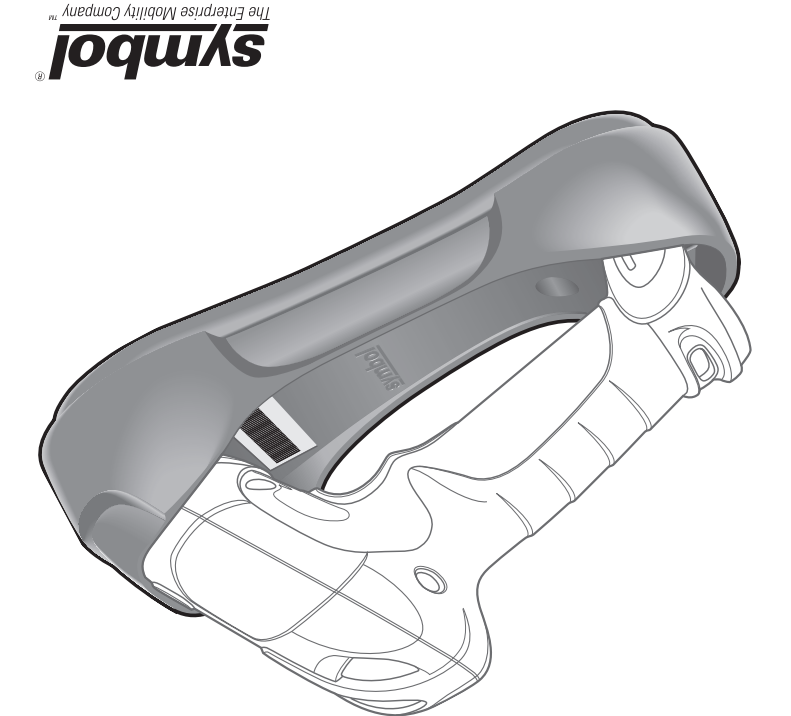
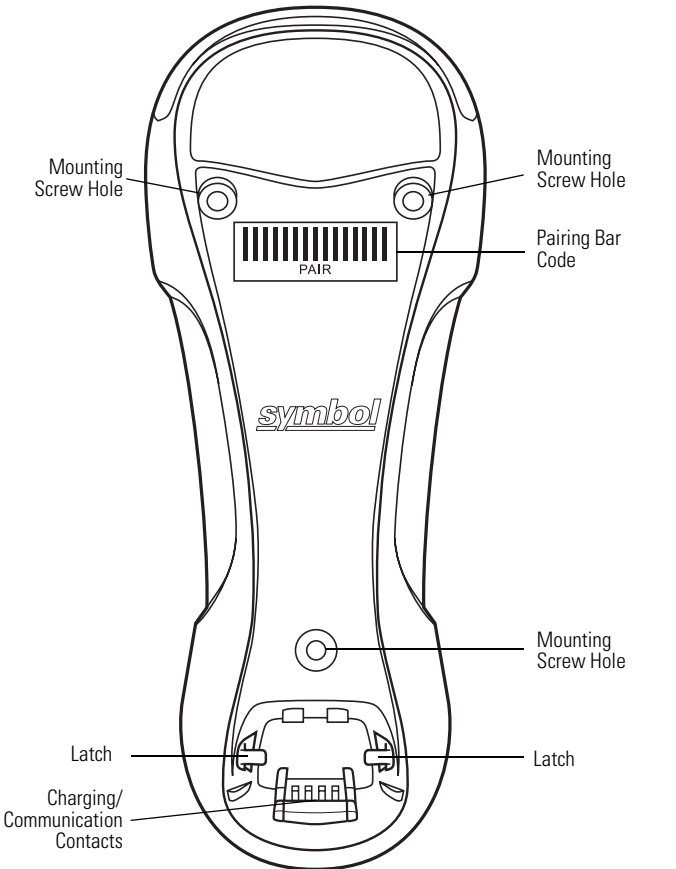

STB3408/3478 Quick Reference Guide

Introduction

The cordless scanner cradle acts as a stand, host communication interface, and charger for the LS 3478 cordless scanner. It can sit on a desktop or be mounted on a wall.

There are two configurations of the cradle:

- STB3478-C0007WW: charging cradle with radio for desk/wall mounting
- STB3408-C0007: charging cradle only for desk/wall mounting.

The STB3478 cradle receives data from the scanner via a Bluetooth radio, and sends that data to the host through an attached cable. The cradle also charges the scanner's internal battery pack when the scanner is inserted. The scanner can be charged from an external power supply or using a USB host cable.

This document provides basic instructions on setting up and using the cradle. Unless otherwise noted, "cradle" refers to both configurations of the cradle. Any discussion of transmission of information refers specifically to the STB3478 cradle.

Equipment Supplied

The cradle package includes:

- Cradle
- Four rubber feet (for desk mounting).

Accessories

The following equipment may be needed:

- Three 1.5" #8 Philips head screws (for wall mounting, if applicable, not available from Symbol)
- Power supply for desk/wall mounting configuration (Symbol p/n 50-14000-101).

Save the shipping container for storing or shipping. Inspect all equipment for damage. If anything is damaged or missing, call an authorized Customer Support Representative immediately.

Related Documentation

LS 3478 Cordless Scanner Product Reference Guide, p/n 72-67139-xx.

LS 3478 Cordless Scanner Quick Start Guide, p/n 72-67137-xx.

This documentation is available at: <http://www.symbol.com/manuals>

© 2004 SYMBOL TECHNOLOGIES, INC. All rights reserved.

Symbol reserves the right to make changes to any product to improve reliability, function, or design.

Symbol does not assume any product liability arising out of, or in connection with, the application or use of any product, circuit, or application described herein.

No license is granted, either expressly or by implication, estoppel, or otherwise under any patent right or patent, covering or relating to any combination, system, apparatus, machine, material, method, or process in which Symbol products might be used. An implied license exists only for equipment, circuits, and subsystems contained in Symbol products. Symbol and the Symbol logo are registered trademarks of Symbol Technologies, Inc. Other product names mentioned in this manual may be trademarks or registered trademarks of their respective companies and are hereby acknowledged.

Symbol Technologies, Inc. One Symbol Plaza
Holtzville, N.Y. 11742-1300
http://www.symbol.com

This product may be covered by one or more U.S. and foreign Patents. For patent information go to: www.symbol.com/patents

Radio Frequency Interference Requirements-FCC Radio Transmitters (Part 15)

This device complies with Part 15 of the FCC Rules. Operation is subject to the following two conditions: (1) this device may not cause harmful interference, and (2) this device must accept any interference received, including interference that may cause undesired operation.

Radio Frequency Interference Requirements-Canada Radio Transmitters

This device complies with RSS 210 of Industry & Science Canada. Operation is subject to the following two conditions: (1) this device may not cause harmful interference and (2) this device must accept any interference received, including interference that may cause undesired operation. Label Marking: The Term "IC:" before the radio certification only signifies that Industry Canada technical specifications were met.

CE Marking and European Economic Area (EEA)

Bluetooth for use through the EEA have the following restrictions:

- Maximum radiated transmit power of 10mW EIRP in the frequency range 2.400-2.4835 GHz
- Belgium outside usage, the equipment is restricted to 2.460 -2.4835 GHz frequency range
- Italy requires a user license for outside usage.

Statement of Compliance

Symbol Technologies, Inc., hereby, declares that this device is in compliance with the essential requirements and other relevant provisions of Directives 1999/5/EC, 89/336/EEC and 73/23/EEC. Declaration of Conformities may be obtained from <http://www2.symbol.com/doc/>.

Other Countries

- Mexico - Restrict Frequency Range to: 2.450 – 2.4835 GHz.
- Israel - Restrict Frequency Range to: 2.418 – 2.457 GHz.
- Sri Lanka - Restrict Frequency Range to: 2.400 – 2.430 GHz.

The stated express warranties are in lieu of all obligations or liabilities on the part of Seller for damages, including but not limited to, special, indirect or consequential damages arising out of or in connection with the use or performance of the Product or service. Seller's liability for damages to Buyer or others resulting from the use of any Product or service furnished hereunder shall in no way exceed the purchase price of said Product or the fair market value of said service, except in instances of injury to persons or property.

EXCEPT FOR THE WARRANTY OF TITLE AND THE EXPRESS WARRANTIES STATED ABOVE, SELLER DISCLAIMS ALL WARRANTIES ON PRODUCTS FINISHED HEREUNDER INCLUDING ALL IMPLIED WARRANTIES OF MERCHANTABILITY AND FITNESS FOR A PARTICULAR USE. ANY IMPLIED WARRANTIES THAT MAY BE IMPOSED BY LAW ARE LIMITED IN DURATION TO THE LIMITED WARRANTY PERIOD. SOME STATES OR COUNTRIES DO NOT ALLOW A LIMITATION ON HOW LONG AN IMPLIED WARRANTY LASTS OR THE EXCLUSION OR LIMITATION OF INCIDENTAL OR CONSEQUENTIAL DAMAGES FOR CONSUMER PRODUCTS. IN SUCH STATES OR COUNTRIES, FOR SUCH PRODUCTS, SOME EXCLUSIONS OR LIMITATIONS OF THIS LIMITED WARRANTY MAY NOT APPLY.

(f) **Warranty Provisions** The above warranty provisions shall not apply to any Product (i) which has been repaired, tampered with, altered or modified, except by Seller's authorized service personnel; (ii) in which the defects or damage to the Product result from normal wear and tear, misuse, negligence, improper storage, water or other liquids, battery leakage, use of parts or accessories not approved or supplied by Symbol, or failure to perform operator handling and scheduled maintenance instructions supplied by Seller; (iii) which has been subjected to unusual physical or electrical stress, abuse, or accident, or forces or exposure beyond normal use within the specified operational and environmental parameters set forth in the applicable Product specification; nor shall the above warranty provisions apply to any expandable or consumable items, such as batteries, supplied with the Product.

(e) **Original Warranty Period** Except for the warranty applying solely to the repaired component arising from a repair service as provided in Section C above, the aforementioned provisions do not extend the original warranty period of any Product that had either been repaired or replaced by Seller.

(b) **Spare Parts** Spare parts (i.e. parts, components, or subassemblies sold by Seller for use in the service and maintenance specification in effect at the time of purchase or in the accompanying software license.

(c) **Repair of Symbol-branded hardware** For repairs on Symbol-branded hardware Products under this agreement, including repairs covered by warranty, the repair services provided are a warranted against defects in workmanship and materials on the repaired component of the Product for a period of thirty (30) days from the shipment date of the repaired Product, or until the end of the original warranty period, whichever is longer.

(a) **Warranty** Symbol Technologies (hereafter "Seller") hardware Products are warranted against defects in workmanship and materials for a period of three (3) months from the date of shipment, unless otherwise provided by Seller in writing, provided the Product remains unmodified and is operated under normal and proper conditions. Warranty provisions and durations on software, integrated installed systems, Product modified or designed to meet specific customer specifications ("Custom Products"), remanufactured products, and reconditioned or upgraded products, shall be as provided in the applicable Product specification.

(b) **Spare Parts** Spare parts (i.e. parts, components, or subassemblies sold by Seller for use in the service and maintenance specification in effect at the time of purchase or in the accompanying software license.

(c) **Repair of Symbol-branded hardware** For repairs on Symbol-branded hardware Products under this agreement, including repairs covered by warranty, the repair services provided are a warranted against defects in workmanship and materials on the repaired component of the Product for a period of thirty (30) days from the shipment date of the repaired Product, or until the end of the original warranty period, whichever is longer.

(a) **Warranty** Symbol Technologies (hereafter "Seller") hardware Products are warranted against defects in workmanship and materials for a period of three (3) months from the date of shipment, unless otherwise provided by Seller in writing, provided the Product remains unmodified and is operated under normal and proper conditions. Warranty provisions and durations on software, integrated installed systems, Product modified or designed to meet specific customer specifications ("Custom Products"), remanufactured products, and reconditioned or upgraded products, shall be as provided in the applicable Product specification.

(b) **Spare Parts** Spare parts (i.e. parts, components, or subassemblies sold by Seller for use in the service and maintenance specification in effect at the time of purchase or in the accompanying software license.

(c) **Repair of Symbol-branded hardware** For repairs on Symbol-branded hardware Products under this agreement, including repairs covered by warranty, the repair services provided are a warranted against defects in workmanship and materials on the repaired component of the Product for a period of thirty (30) days from the shipment date of the repaired Product, or until the end of the original warranty period, whichever is longer.

(a) **Warranty** Symbol Technologies (hereafter "Seller") hardware Products are warranted against defects in workmanship and materials for a period of three (3) months from the date of shipment, unless otherwise provided by Seller in writing, provided the Product remains unmodified and is operated under normal and proper conditions. Warranty provisions and durations on software, integrated installed systems, Product modified or designed to meet specific customer specifications ("Custom Products"), remanufactured products, and reconditioned or upgraded products, shall be as provided in the applicable Product specification.

Regulatory Information

All Symbol devices are designed to be compliant with rules and regulations in locations they are sold and will be labeled as required.

Any changes or modifications to Symbol Technologies equipment, not expressly approved by Symbol Technologies, could void the user's authority to operate the equipment.

Antennas: use only the supplied or an approved replacement antenna. Unauthorized antennas, modifications, or attachments could cause damage and may violate regulations.

Radio Modules

The STB3478 contains an approved radio module. This module is identified below.
Symbol Bluetooth™ Radio, Type: 21-64381.

Bluetooth Devices

The STB3478 is an approved Bluetooth device. Bluetooth ID: **BT01785**.

Health and Safety Recommendations

Ergonomic Recommendations

Caution: In order to avoid or minimize the potential risk of ergonomic injury follow the recommendations below. Consult with your local Health & Safety Manager to ensure that you are adhering to your company's safety programs to prevent employee injury.

- Reduce or eliminate repetitive motion
- Maintain a natural position
- Reduce or eliminate excessive force
- Keep objects that are used frequently within easy reach
- Perform tasks at correct heights
- Reduce or eliminate vibration
- Reduce or eliminate direct pressure
- Provide adjustable workstations
- Provide adequate clearance
- Provide a suitable working environment
- Improve work procedures.

⚠ FCC RF Exposure Guidelines

Safety Information

The device complies with Internationally recognized standards covering Specific Absorption Rate (SAR) related to human exposure to electromagnetic fields from radio devices.

Reducing RF Influence – Use Properly

It is advisable to use the device only in the normal operating position and it is recommended that no part of the human body be allowed to come too close to the antenna during operation of the equipment.

To satisfy FCC RF exposure requirements, a mobile transmitting device must operate with a minimum separation distance of 20 cm or more from a person's body.

Cradle Parts (Back)

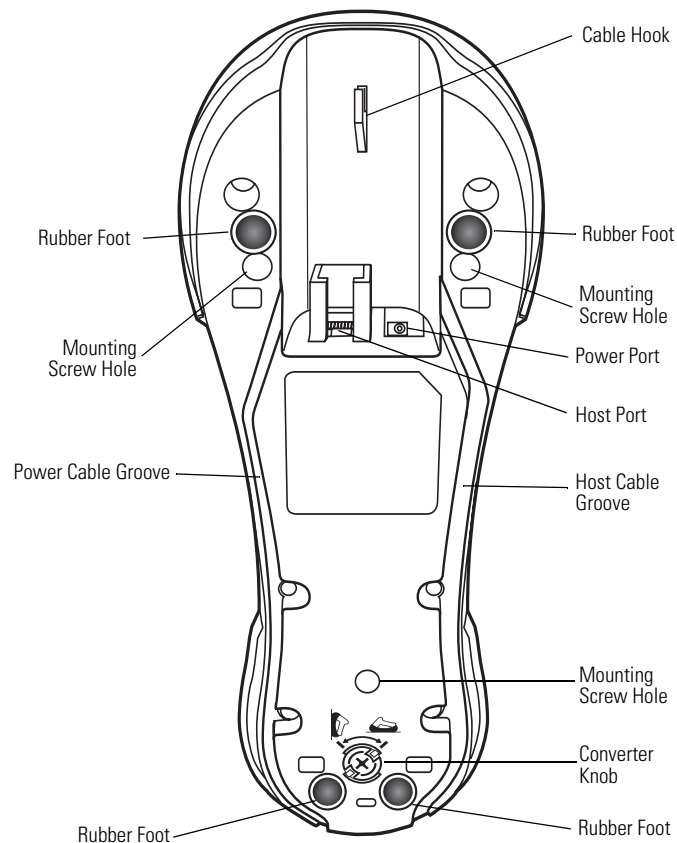

Note: Do not use the rubber feet when mounting in a non-horizontal orientation.

Cradle Connections

Important: Connect the interface cable and power supply in the following order to ensure proper operation of the scanner and cradle:

1. Insert the interface cable into the cradle's host port.
2. Connect the other end of the interface cable to the host.
3. Connect the power supply to the cradle's power port if required by the interface, or to allow fast charging of the scanner.
4. Connect the appropriate cable to the power supply and an AC power source.
5. If applicable, thread the interface cable over the cable hook and run the host and power cables into their respective cable grooves.
6. If necessary, scan the appropriate host bar code (for non-autodetected interfaces). See the *Product Reference Guide*.

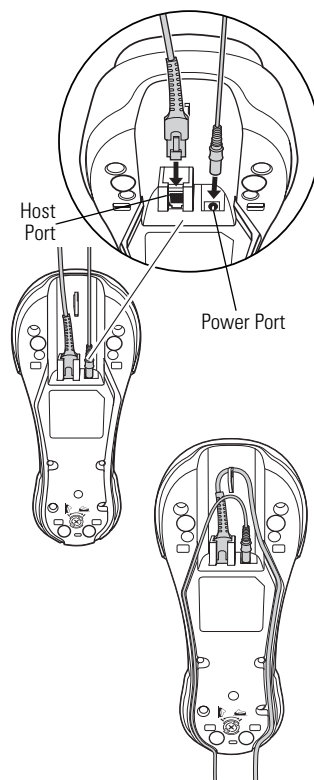

Changing the Host Interface

To connect to a different host, or to the same host through a different cable:

1. Unplug the power supply from the cradle.
2. Unplug the interface cable from the host.
3. Connect the interface cable to the new host, or the new interface cable to the existing host.
4. Reconnect the power supply.
5. If necessary, scan the appropriate host bar code (for non-autodetected interfaces). See the *Product Reference Guide*.

Mounting the Cradle

Horizontal Mount

1. Ensure the converter knob is in the correct position, shown at right.
2. If mounting the cradle horizontally where no fastening is necessary, peel the protective paper from the back of the rubber feet included with the cradle packaging, and attach the feet to the cradle at the indentations in the plastic. These feet provide traction and prevent surface damage.

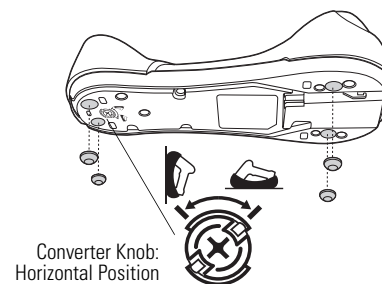

Non-Horizontal Mount

To mount the cradle on a non-horizontal surface:

1. Use a Philips screwdriver to turn the converter knob to the position shown at right. The latches protract to engage the depressions at the base of the scanner's handle.
2. Attach the interface and power cables to the appropriate ports (see [Cradle Connections](#)).
3. Press the cables into the cable grooves.
4. Position the cradle on the mounting surface.
5. Mark the surface through the three holes on the bottom of the cradle, or use the mounting template to determine the location of the screw holes.
6. Pre-drill holes to accommodate three 1.5" #8 Philips head screws.
7. Attach the cradle securely to the surface.
8. Place the scanner in the cradle.

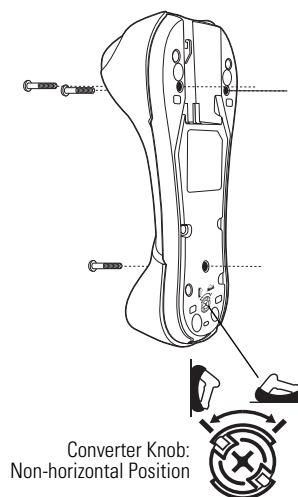

Note: Do not use the rubber feet when mounting in a non-horizontal orientation.

Inserting the Scanner in the Cradle

To insert the scanner in the cradle:

1. Insert the scanner top first.
2. Push the handle until it clicks into place, engaging the contacts in the cradle and scanner.

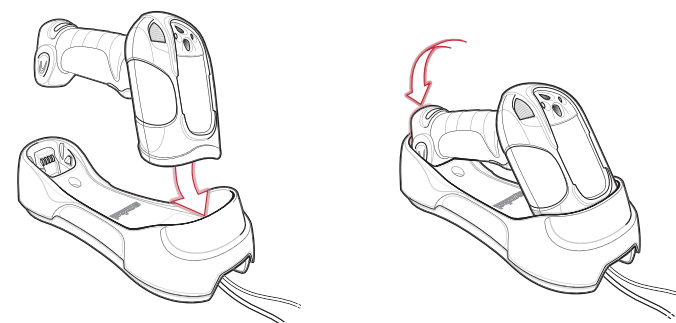

Sending Data to the Host Computer

The cradle receives data from the scanner via a wireless radio connection and transmits it to the host computer via the host cable. The scanner and cradle must be paired for successful wireless communication.

Pairing

Pairing registers a scanner to the cradle. The STB3478 is a multipoint cradle, and can connect to up to four scanners at a time. The cradle includes pairing bar codes on both its front and back.

During pairing, the scanner and the cradle exchange information. A short low-high beep sequence indicates successful pairing. Four low, long beeps indicate failure, or an unsuccessful pairing.

To pair the scanner with the cradle, scan either pairing bar code.

Lost Connection to Host

If scanned data does not transmit to the cradle's host, ensure that all cables are firmly inserted and the power supply is connected to an appropriate AC outlet. If scanned data still does not transmit to the host, reestablish a connection with the host:

1. Disconnect the power supply from the cradle.
2. Disconnect the host interface cable from the cradle.
3. Wait three seconds.
4. Reconnect the host interface cable to the cradle.
5. Reconnect the power supply to the cradle.
6. Reestablish pairing with the cradle by scanning either pairing bar code.

Charging the Scanner Battery in the Cradle

To charge the scanner battery, place the scanner in the cradle (see [Inserting the Scanner in the Cradle](#)). The battery begins charging within five seconds. A complete charge can take up to four hours, depending on the remaining charge in the battery.

LED Charging Indications

The green LED indicates charging activity (see the table below). If the scanner is charging in fast mode (non-bus powered mode), the green LED blinks at a fast rate. If the scanner is charging in slow mode (bus-powered mode), the LED blinks at a slow rate.

If the red LED begins flashing, indicating a charging problem, remove the scanner from the cradle and replace the battery. If the red LED continues flashing, contact a Symbol Support Center.

Standard Use LED Sequences	
Off	No power is applied to the scanner, or the scanner is on and ready to scan.
Green	A bar code was successfully decoded.
Red	A data transmission error or scanner malfunction occurred.

Charging Use LED Sequences	
Green Slow Flash	The scanner is in the cradle and is charging in slow mode (used when the cradle is powered from the USB bus).
Green Fast Flash	The scanner is in the cradle and is charging in rapid mode (used when the cradle is powered from an external power supply).
Red fast flash (two flashes per second)	Overcharge condition. Contact the Symbol Support Center.
Red slow flash (one flash per second)	Low battery voltage. Replace the battery.
Red and green flash	Temperature fault. Move the cradle to a location where the temperature is 0° - 40° C; optimal charging temperature is 5° - 35° C.

For more details about LED indications, refer to the *LS 3478 Product Reference Guide*.

Using the USB Interface to Supply Power

When the cradle is connected to the host via the USB interface, the USB port can power the cradle instead of an external power supply. In this mode, the cradle can only charge the scanner battery in singlepoint mode. To charge a scanner in multipoint mode, an external power supply is required.

Troubleshooting

If the cradle does not work after following the previous procedures:

- Check the system power.
- Check for loose cable connections.
- Check that the scanner is inserted properly in the cradle.
- Check that the host settings are correct and the cradle is connected to the appropriate port on the host.



Do not pour, spray, or spill any liquid on the cradle.

Mounting Template

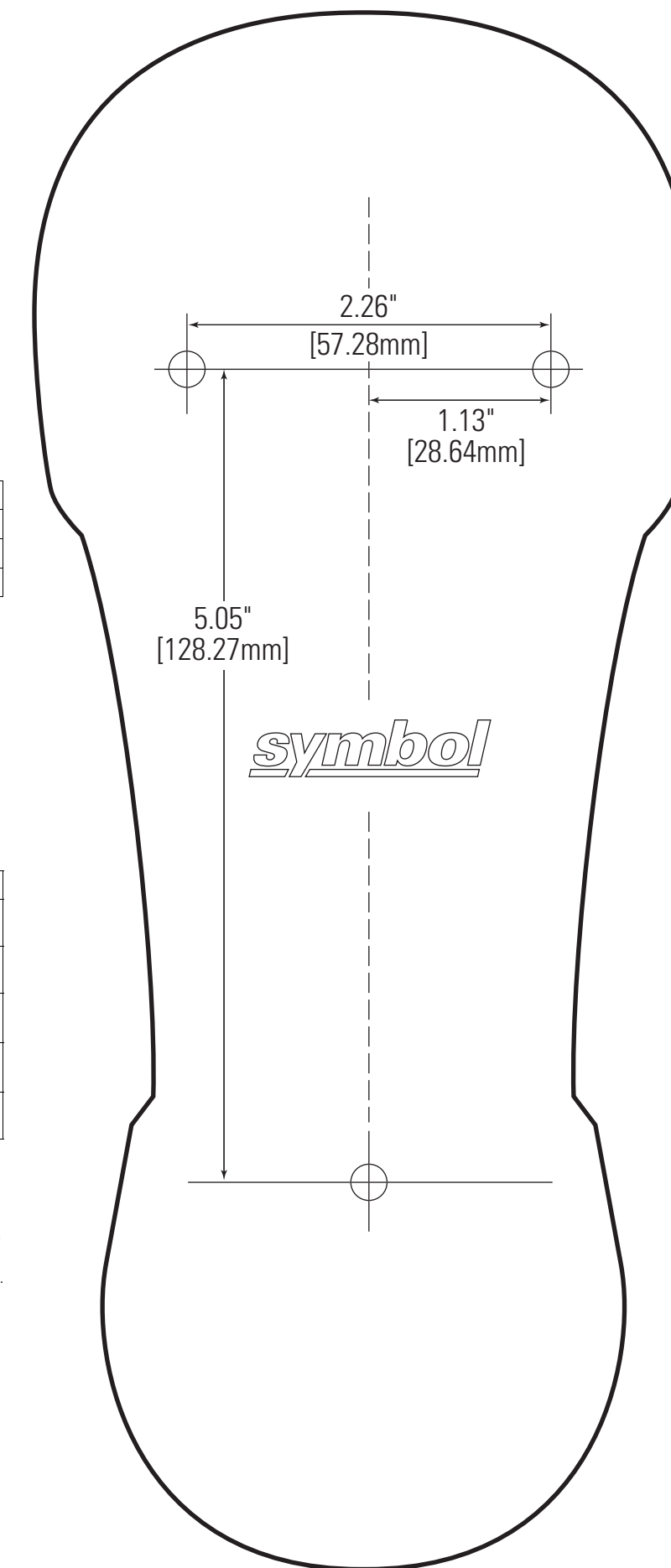

Dimension tolerance = ± 0.01 inch (± 0.25 mm)



If the scanner does not recognize the host, disconnect the power supply, then reconnect after connecting the host cable.