

FCC TEST REPORT

CATEGORY : Module for Portable Host
PRODUCT NAME : 802.11a/b/g RLAN module
FCC ID. : H9P2121160
FILING TYPE : Certification – Class II Permissive Change
BRAND NAME : SYMBOL
TYPE NO. : 21-21160
MODEL OF HOST : MC3090 (with 11a/b/g module)
APPLICANT : **SYMBOL Technologies, Inc.**
One Symbol Plaza Holtsville, New York, 11742-1300 U.S.A
MANUFACTURER : **Universal Scientific Industrial Co., Ltd.**
141, Lane 351, Taiping Road, Sec.1, Tsao Yuen,
Nan-Tou, Taiwan, R.O.C.
ISSUED BY : **SPORTON INTERNATIONAL INC.**
6F, No. 106, Sec. 1, Hsin Tai Wu Rd., His Chih, Taipei Hsien,
Taiwan, R.O.C.

Statements:

Only the test result of 802.11a part is shown in this test report, test result of 802.11b/g is in another separate test report.

The test result in this report refers exclusively to the presented test model / sample.

Without written approval of SPORTON, the test report shall not be reproduced except in full.

Certificate or Test Report could not be used by the applicant to claim the product endorsement by CNLA, NVLAP or any agency of U.S. government.

The test equipment used to perform the test are calibrated and traceable to NML/ROC or NIST/USA.



Dr. Alan Lane
Vice General Manager
Sporton International Inc.



Lab Code: 200079-0



Table of Contents

History of this test report.....	ii
1. General Description of Equipment under Test.....	1
1.1. Applicant.....	1
1.2. Manufacturer	1
1.3. Basic Description of Equipment under Test	1
1.4. Features of Equipment under Test.....	1
1.5. Table for Carrier Frequencies	2
2. Test Configuration of the Equipment under Test.....	3
2.1. Description of the Test	3
2.2. Frequency Range Investigated	3
2.3. Test Modes.....	3
2.4. Description of Test Supporting Units.....	4
2.5. Connection Diagram of Test System	4
2.6. Test Software	5
3. Test Location and Standards	6
3.1. Test Location.....	6
3.2. Test Conditions	6
3.3. Standards for Methods of Measurement.....	6
3.4. DoC Statement.....	6
4. List of Measurements.....	7
4.1. Summary of the Test Results	7
5. Test Result	8
5.1. Test of 26dB Bandwidth	8
5.2. Test of Maximum Peak Transmit Power	15
5.3. Test of Peak Power Spectral Density.....	22
5.4. Test of the Ratio of Peak Excursion	29
5.5. Test of Band Edges of the Operating Frequency.....	36
5.6. Test of Spurious Radiated Emission	40
5.7. Test of Frequency Stability.....	50
5.8. Test of AC Power Line Conducted Emission	53
5.9. Antenna Requirements	57
6. List of Measuring Equipments Used	58
Appendix A. Photographs of EUT.....	A1 ~ A113



History of this test report

- No additional attachment.
 Additional attachment were issued as following record:

Attachment No.	Issue Date	Description



1. General Description of Equipment under Test

1.1. Applicant

SYMBOL Technologies, Inc.
One Symbol Plaza Holtsville, New York, 11742-1300 U.S.A

1.2. Manufacturer

Universal Scientific Industrial Co., Ltd.
141, Lane 351, Taiping, Sec. 1, Tsao Yuen, Nan-Tou, Taiwan, R.O.C.

1.3. Basic Description of Equipment under Test

The device supplied for testing is a 21-21160 RF Module which offers 2.4GHz and 5GHz wireless local area network connectivity employing IEEE 802.11 a/b/g technologies intended to be installed in portable host such as Wireless LAN mobile Computer. The technical data has been listed on section " Features of Equipment under Test ".

1.4. Features of Equipment under Test (802.11a part)

ITEMS	DESCRIPTION
Type of Modulation	OFDM (BPSK / QPSK / 16QAM / 64QAM)
Number of Channels	12
Frequency Band	5150 ~ 5250MHz, 5250 ~ 5350MHz 5725 ~ 5825MHz
Carrier Frequencies	Please reference section 1.5.
Channel Bandwidth	Normal Mode (20MHz)
RF Conducted Output Power	Band 1: 16.84 dBm Band 2: 18.94 dBm Band 3: 18.95 dBm
Antenna Type	PIFA Antenna / 3.1dBi
Function Type	Transceiver
Power Rating (DC/AC, Voltage)	3.3 VDC
Temperature Range (Operating)	-20 ~ +55 °C



1.5. Table for Carrier Frequencies

Normal Mode

Channel	Frequency	Channel	Frequency
36	5180 MHz	149	5745 MHz
40	5200 MHz	153	5765 MHz
44	5220 MHz	157	5785 MHz
48	5240 MHz	161	5805 MHz
52	5260 MHz		
56	5280 MHz		
60	5300 MHz		
64	5320 MHz		



2. Test Configuration of the Equipment under Test

2.1. Description of the Test

- Spurious emission below 1GHz is independent of channel selection, so only normal mode channel 161 was tested.
- The EUT has been programmed to continuously transmit or receive during testing. The used peripherals as well as the configuration fulfill the requirements of ANSI C63.4:2001.
- The configuration is operated in a manner which tends to maximize its emission characteristics in a typical application.

2.2. Frequency Range Investigated

- Conducted power line test: from 150 kHz to 30 MHz
- Radiated emission test: from 30 MHz to 40,000 MHz

2.3. Test Modes

The following are the configuration of host MC3090.

Test Mode	Model 1	Model 2
Mechanical	Straight Shooter - Brick	Straight Shooter - Brick
Processor	Intel Bulverde 520MHz	Intel Bulverde 416MHz
Flash	64MB	32MB
SDRAM	64MB	32MB
LCD Panel	Sharp LQ030B7DD01 (Color)	Sharp LQ030B7DD01 (Color)
Touch Panel	Liyitec TR4-030F-14G	NA
Keypad	48 Key	38 Key
Scanning	Symbol PICO Imager (20-60000-XX)	Symbol SE800hp
WLAN	Symbol Photon 802.11b/g/a (21-21160)	Symbol Photon 802.11b/g/a (21-21160)
Battery	Symbol 55-060112-86 3.7V 4400mAh	Symbol 55-060114-86 3.7V 2600mAh

Test Mode	Model 3	Model 4
Mechanical	Rotating Head – Brick	Rotating Head – Brick
Processor	Intel Bulverde 520MHz	Intel Bulverde 416MHz
Flash	64MB	32MB
SDRAM	64MB	32MB
LCD Panel	EDT ES50512FLWP (Mono)	EDT ES50512FLWP (Mono)
Touch Panel	Liyitec TR4-030F-14G	NA
Keypad	28 Key	38 Key
Scanning	Symbol SE800hp	Symbol SE800hp
WLAN	Symbol Photon 802.11b/g/a (21-21160)	Symbol Photon 802.11b/g/a (21-21160)
Battery	Symbol 55-060112-86 3.7V 4400mAh	Symbol 55-060114-86 3.7V 2600mAh

The above 4 models has been verified. Model 1 with RS232 accessory was found to be the worst case. So, only this model will be shown in this test report.

2.4. Description of Test Supporting Units

Support Unit 1. – Notebook (Dell)

FCC ID : N/A
Model No. : PP10L
Serial No. : SP0031
Remark : This support device was tested to comply with FCC standards and authorized under Declaration of Conformity.

Support Unit 2. – Printer (EPSON)

FCC ID : N/A
Model No. : Stylus Color 680
Serial No. : SP0016
Remark : This support device was tested to comply with FCC standards and authorized under Declaration of Conformity.

2.5. Connection Diagram of Test System

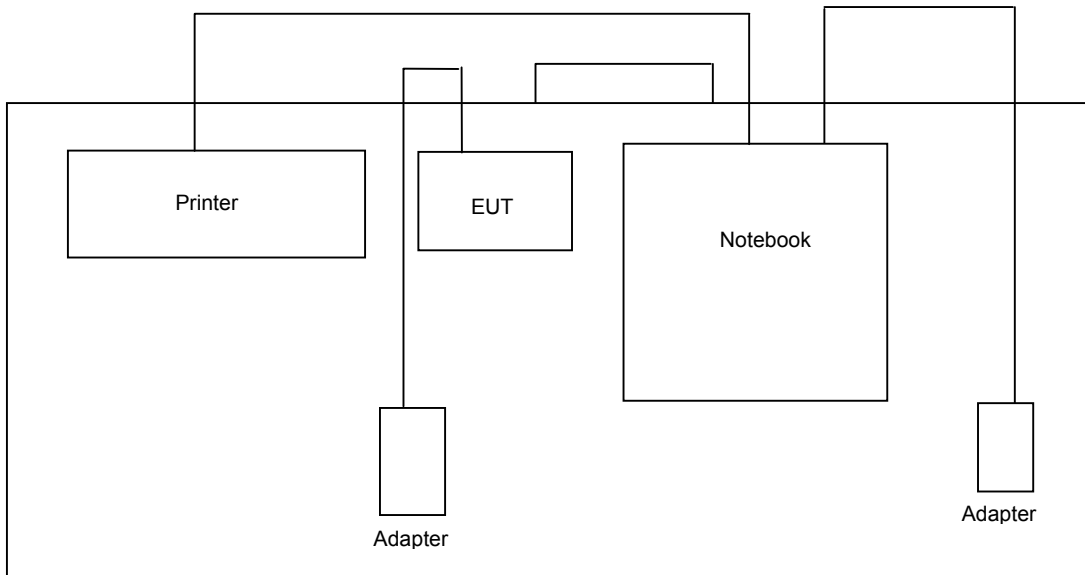



2.6. Test Software

Channel & Power Controlling Software: This was provided by the manufacturer and is able to let the test engineer select the operating channel as well as the RF output power. The parameters for channel selection is trying to offer the test engineer the ability to fix the operating channel for testing, both normal data and continuously transmitting modes are allowed, and that for RF output power selection is for the setting of RF output power expected by the customer and is going to be fixed on the firmware of the final end product.



3. Test Location and Standards

3.1. Test Location

Test Location : Sporton Hwa Ya Testing Building
Address : No. 52, Hwa Ya 1st Rd., Hwa Ya Technology Park, Kwei-Shan Hsiang, Tao Yuan Hsien, Taiwan, R.O.C.
Tel: +886 3 327 3456 Fax: +886 3 318 0055
Test Site No. : CO04-HY, 03CH03-HY

3.2. Test Conditions

Normal Voltage : 120V/60Hz (power adapter of host)
Extreme Voltage : 138V and 102V (power adapter of host)
Normal Temperature : 20 °C
Extreme Temperature : -20 °C and 50 °C

3.3. Standards for Methods of Measurement

Here is the list of the standards followed in this test report.

ANSI C63.4-2001

47 CFR Part 15 Subpart E (Section 15.407)

3.4. DoC Statement

This EUT is also classified as a device of computer peripheral Class B which DoC has to be followed. It has been verified according to the rule of 47 CFR part 15 Subpart B, and found that all the requirements has been fulfilled.



4. List of Measurements

4.1. Summary of the Test Results

Applied Standard: 47 CFR Part 15 and Part 2			
Paragraph	FCC Rule	Description of Test	Result
5.1	15.407(a)	26dB Bandwidth	Pass
5.2	15.407(a)	Maximum Peak Transmit Power	Pass
5.3	15.407(a)	Peak Power Spectral Density	Pass
5.4	15.407(a)	The Ratio of the Peak Excursion	Pass
5.5	15.407(b)	Band Edges of the Operation Frequency	Pass
5.6	15.209/15.407(b)	Spurious Radiated Emission	Pass
5.7	15.407(g)	Frequency Stability	Pass
5.8	15.107/15.207	AC Power Line Conducted Emission	Pass
5.9	15.203/15.407(a)	Antenna Requirement	Pass
5.10	2.1091/2.1093	Maximum Permissible Exposure for the EUT	Pass

5. Test Result

5.1. Test of 26dB Bandwidth

5.1.1. Measuring Instruments

Item 18 of the table on section 6.

5.1.2. Test Procedures

1. The transmitter output was connected to the spectrum analyzer through an attenuator.
2. Set RBW of spectrum analyzer to 300kHz and VBW to 1000kHz.
3. The 6dB bandwidth is defined as the spectrum width with level higher than 26dB below the peak level.
4. Repeat above 1~3 points for the other channel of the EUT.
5. Calculated the power limit.

5.1.3. Test Setup Layout

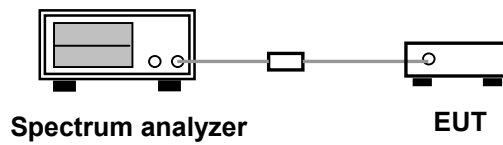



5.1.4. Test Result : See spectrum analyzer plots below

- Normal Mode
- Temperature: 26°C
- Relative Humidity: 64 %
- Duty cycle of the equipment during the test: 100%
- Test Engineer: Bunny Yao

Channel	Frequency (MHz)	26dB Bandwidth (MHz)	Calculated Power Limit dBm	Applied Power Limit dBm
36	5180	28.64	18.26	17
40	5200	27.96	18.10	17
48	5240	25.20	18.10	17
52	5260	23.24	27.38	24
56	5280	22.48	27.34	24
64	5320	26.40	25.47	24
149	5745	33.68	33.02	30
153	5765	33.48	32.86	30
161	5805	33.44	30.94	30



(CH 36) : 5180MHz

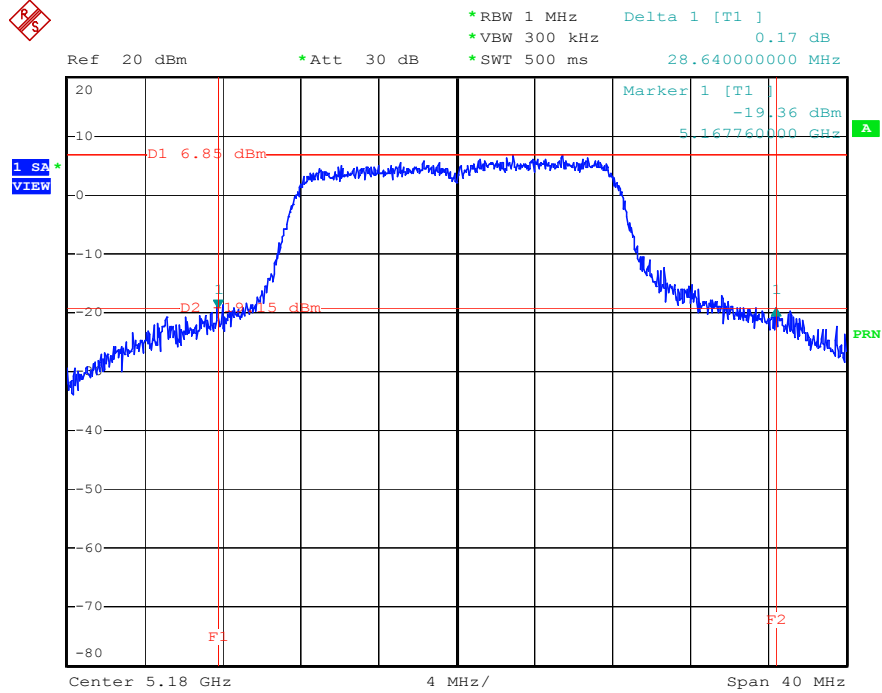

Date: 2.SEP.2004 09:56:26

(CH 40) : 5200MHz

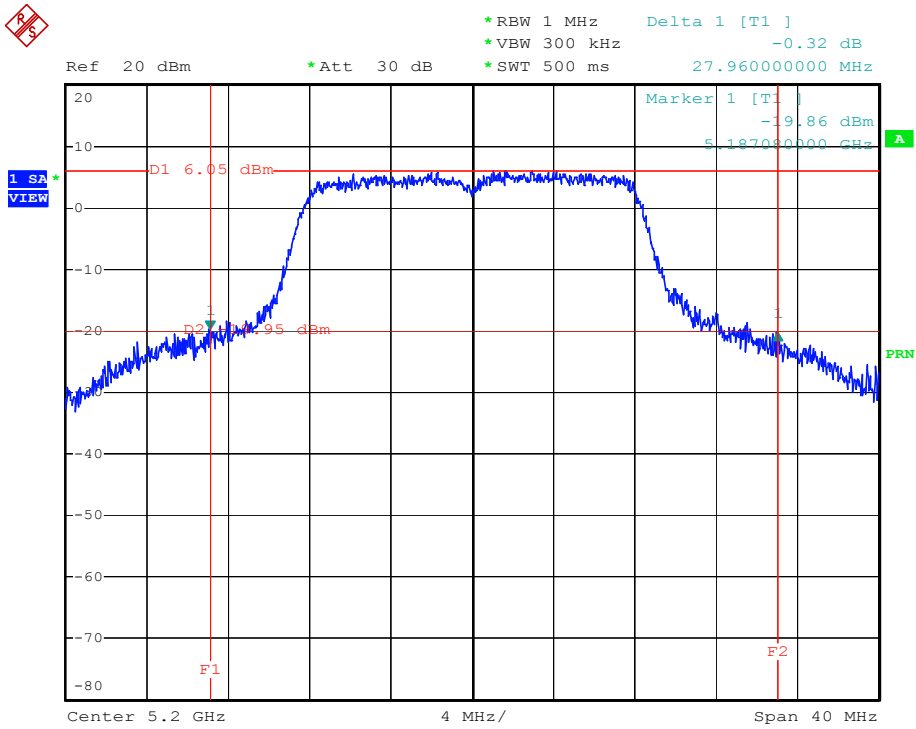

Date: 2.SEP.2004 10:03:01



(CH 48) : 5240MHz

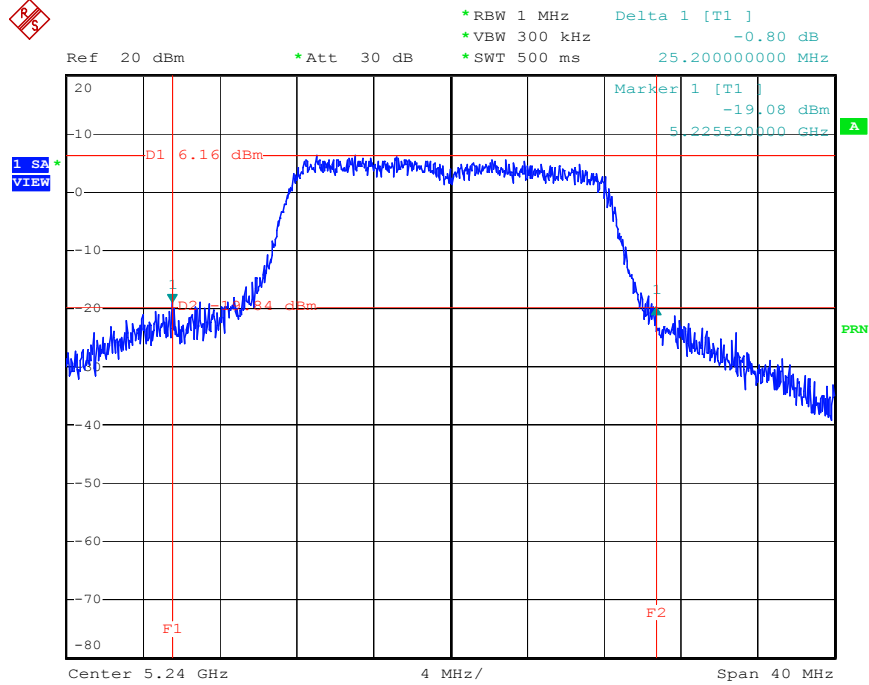

Date: 2.SEP.2004 10:04:50

(CH 52) : 5260MHz

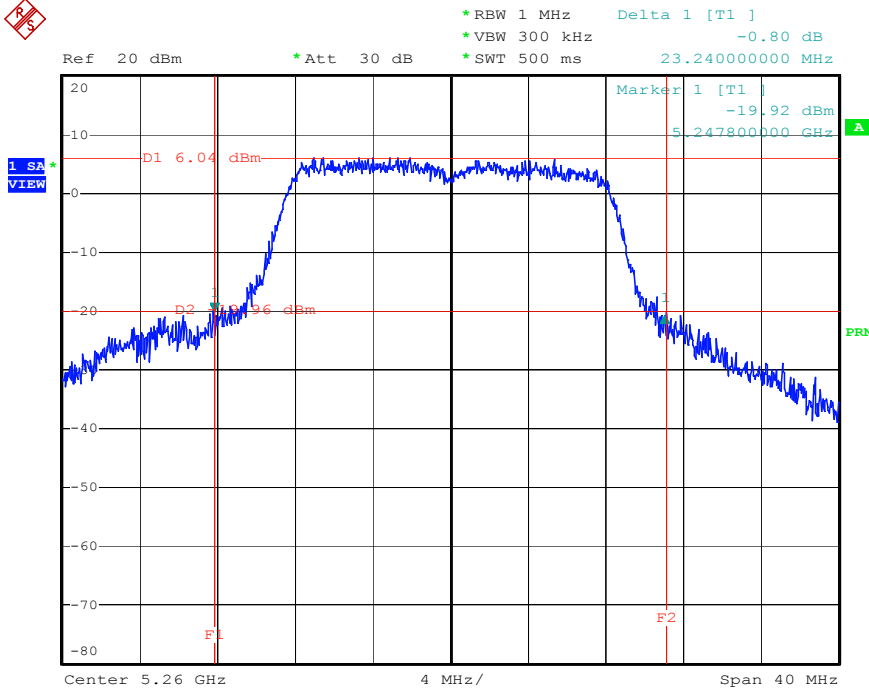

Date: 2.SEP.2004 10:17:20



(CH 56) : 5280MHz

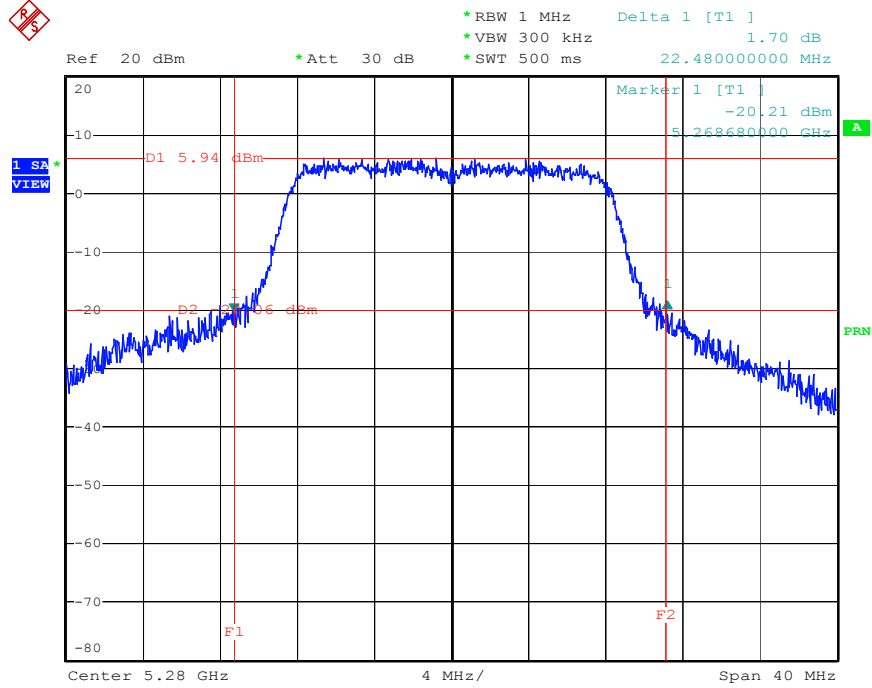

Date: 2.SEP.2004 10:20:19

(CH 64) : 5320MHz

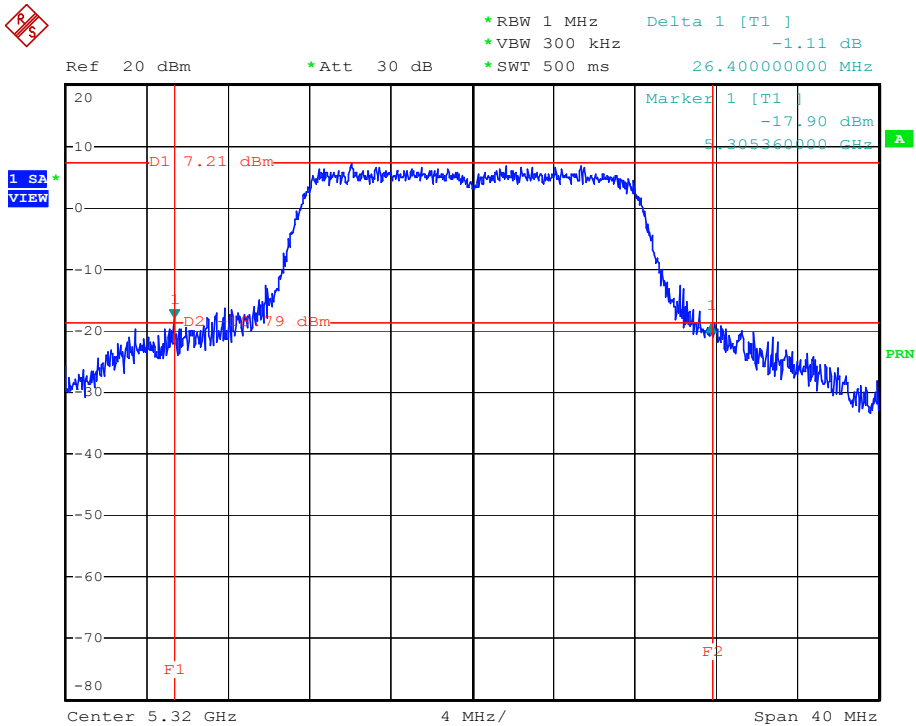

Date: 2.SEP.2004 10:24:46



(CH 149) : 5745MHz

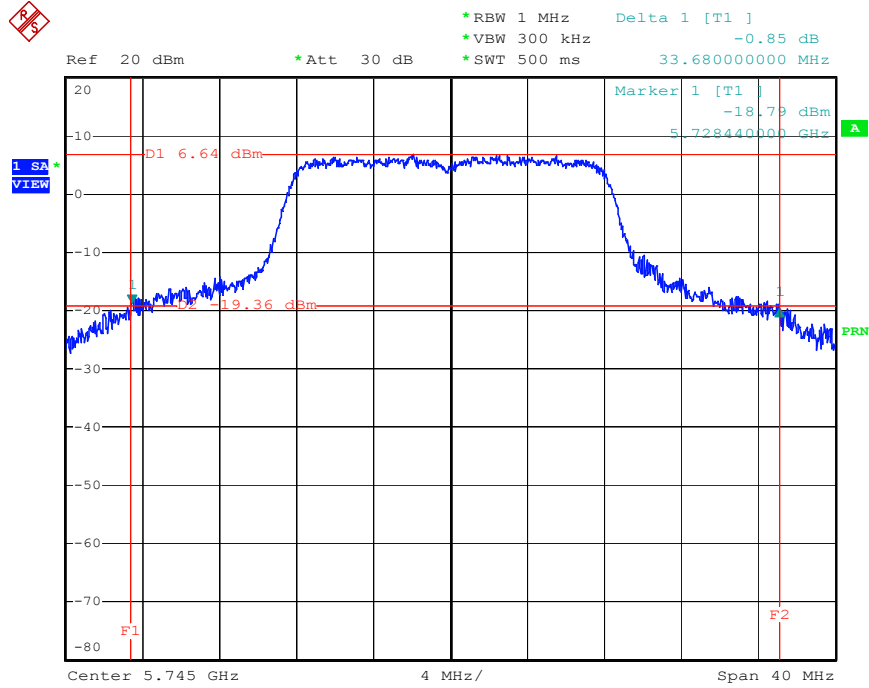

Date: 2.SEP.2004 10:29:41

(CH 153) : 5765MHz

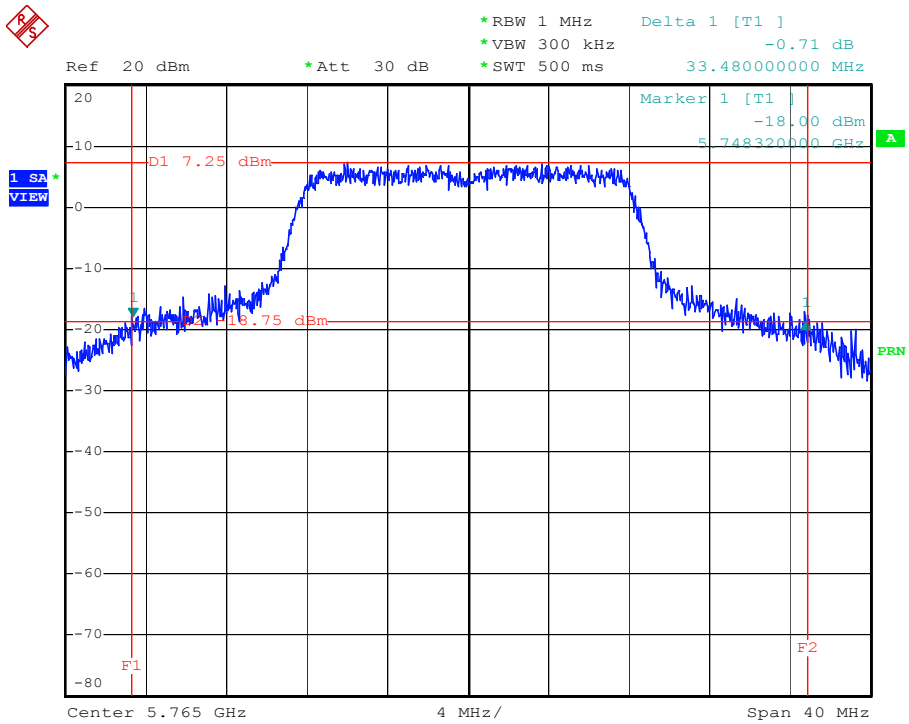

Date: 2.SEP.2004 10:32:29



(CH 161) : 5805MHz

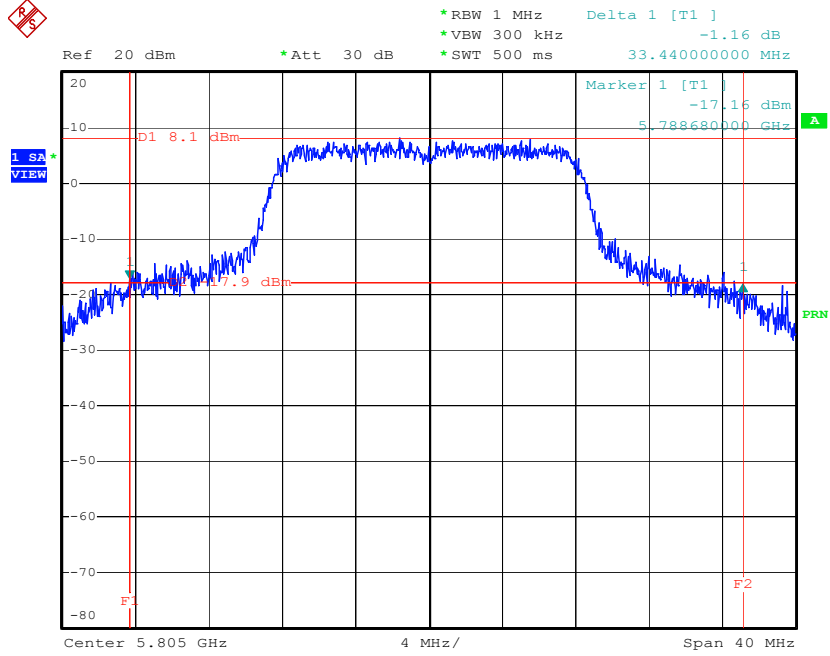

Date: 2.SEP.2004 10:34:52

5.2. Test of Maximum Peak Transmit Power

5.2.1. Measuring Instruments

Item 7 of the table on section 6.

5.2.2. Test Procedures

1. The transmitter output was connected to the Spectrum through an attenuator.
2. Set RBW of spectrum analyzer to 1000kHz and VBW to 3000kHz.
3. Use sample detector mode, span 50MHz and max hold.
4. Use the channel power function of the spectrum analyzer to measure the power.

5.2.3. Test Setup Layout

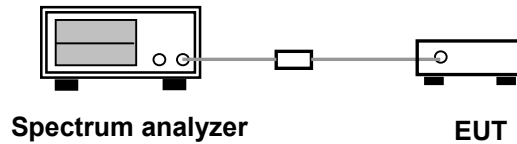



5.2.4. Test Result : See spectrum analyzer plots below

- Normal Mode
- Temperature: 26°C
- Relative Humidity: 64 %
- Duty cycle of the equipment during the test : 100%
- Test Engineer: Bunny Yao

Channel	Frequency (MHz)	Output Power (dBm)	Output Power (mWatt)	Limits (dBm)
36	5180	16.82	48.08	17.00
40	5200	16.84	48.31	17.00
48	5240	16.58	45.50	17.00
52	5260	18.94	78.34	24.00
56	5280	18.60	72.44	24.00
64	5320	18.49	70.63	24.00
149	5745	18.52	71.12	30.00
153	5765	18.42	69.50	30.00
161	5805	18.95	78.52	30.00

Power Limits:

5150MHz~5250MHz is 17dBm or 26dB bandwidth of Power Limits, whichever is less.
5250MHz~5350MHz is 24dBm or 26dB bandwidth of Power Limits, whichever is less.
5725MHz~5825MHz is 30dBm or 26dB bandwidth of Power Limits, whichever is less.



(CH 36) : 5180MHz

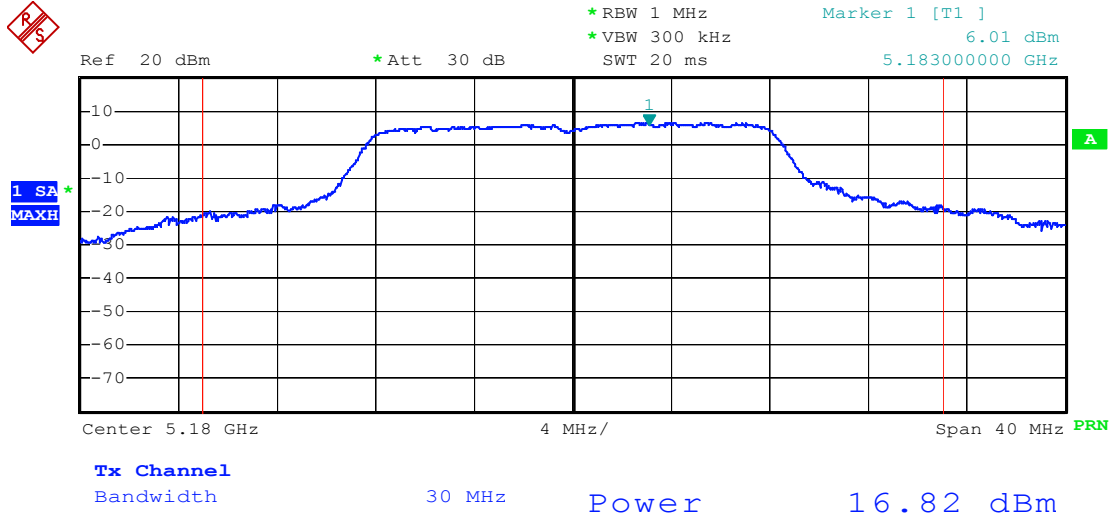

(CH 40) : 5200MHz

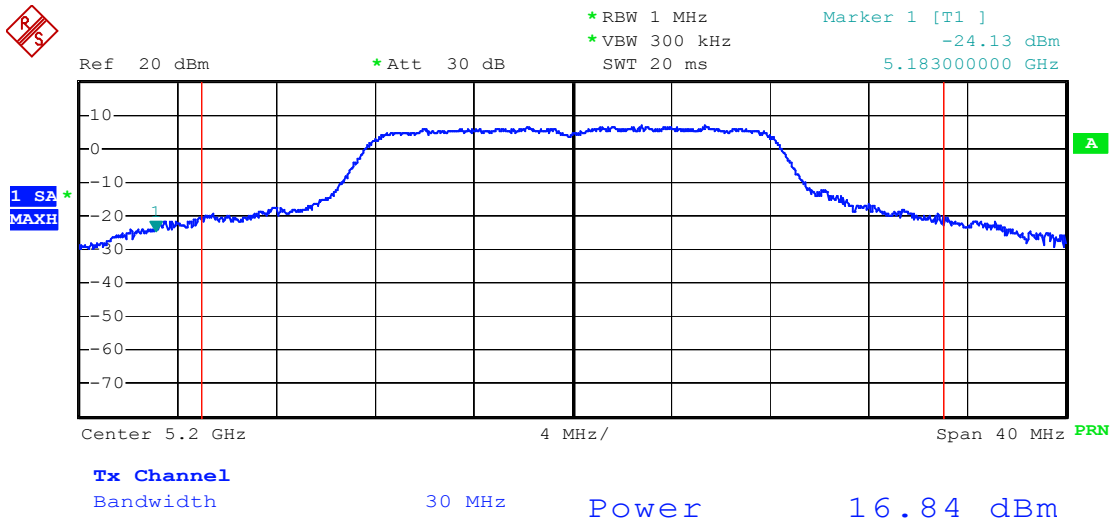



(CH 48) : 5240MHz

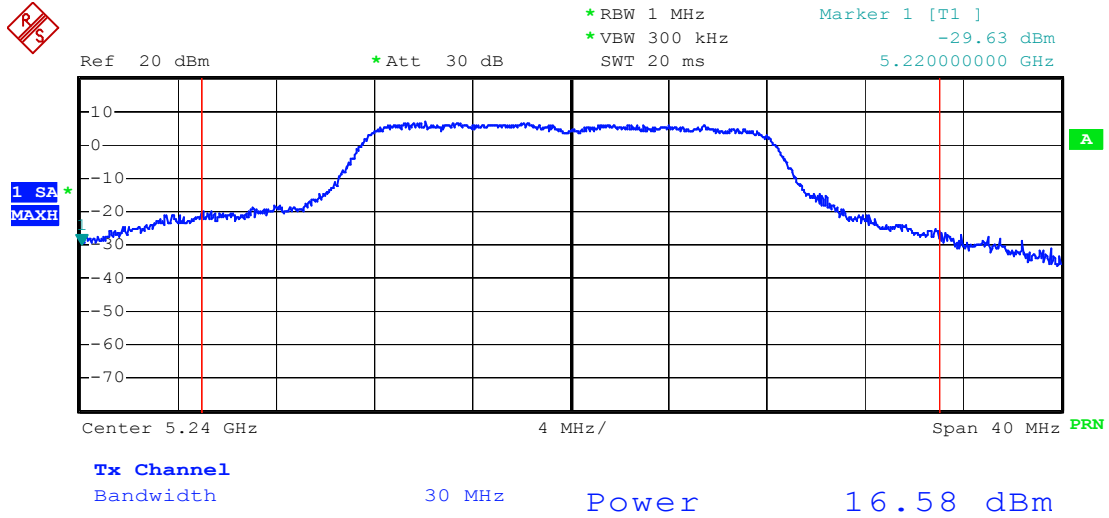

(CH 52) : 5260MHz

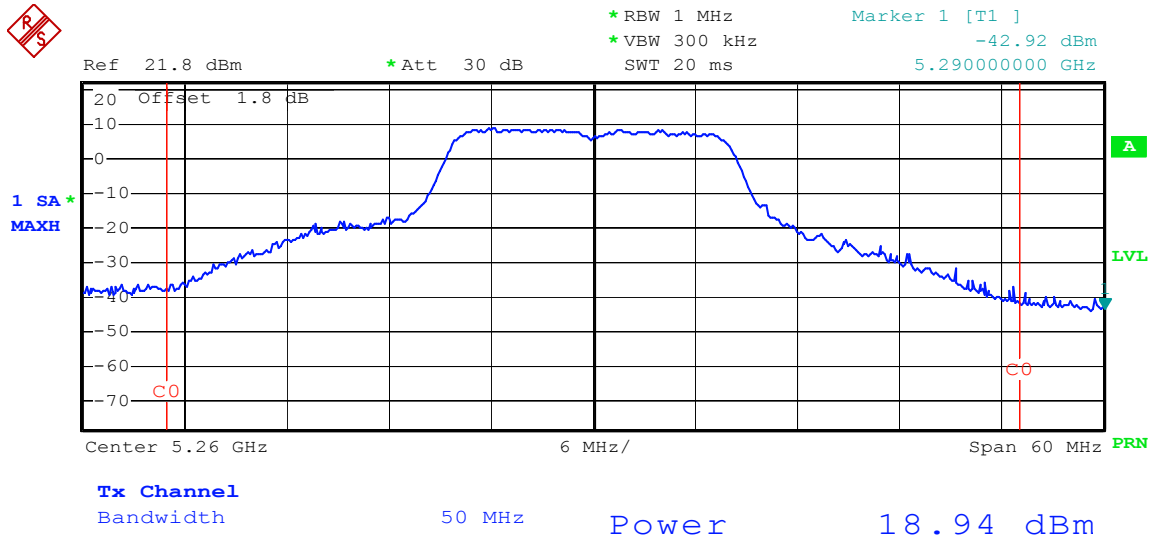



(CH 56) : 5280MHz

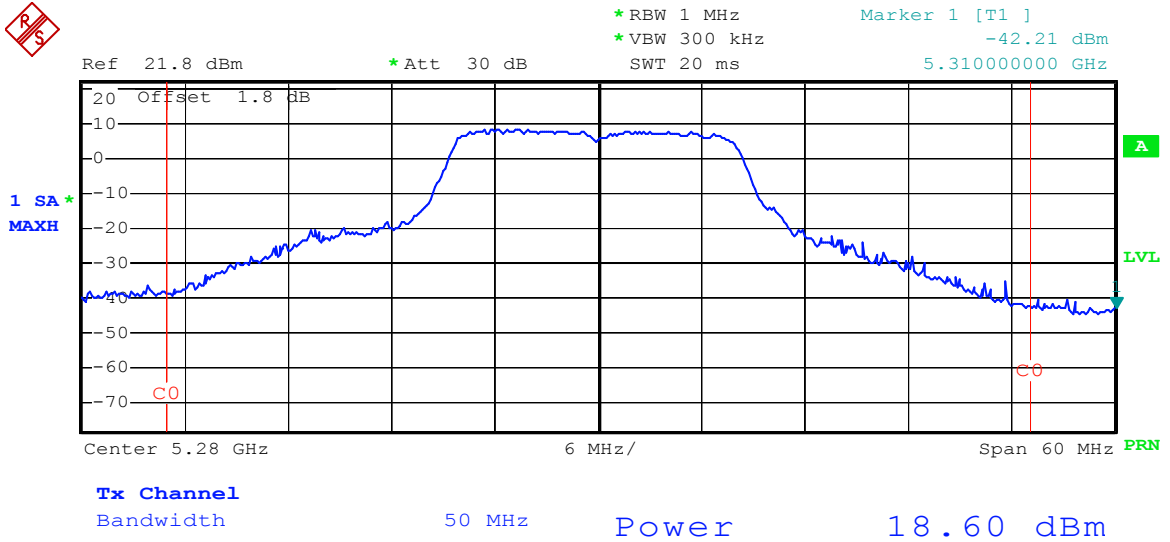

(CH 64) : 5320MHz

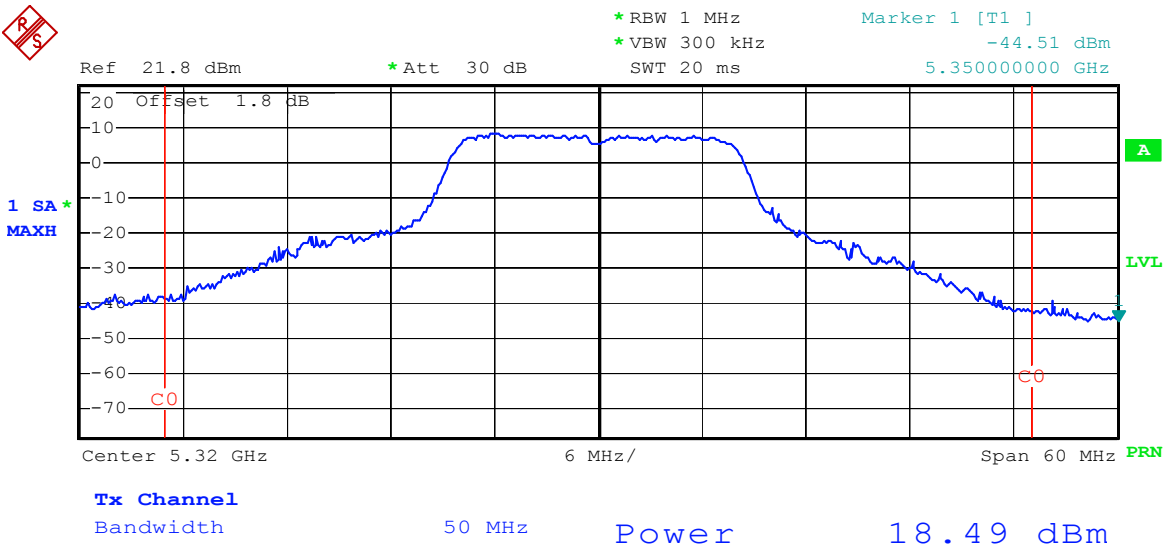



(CH 149) : 5745MHz

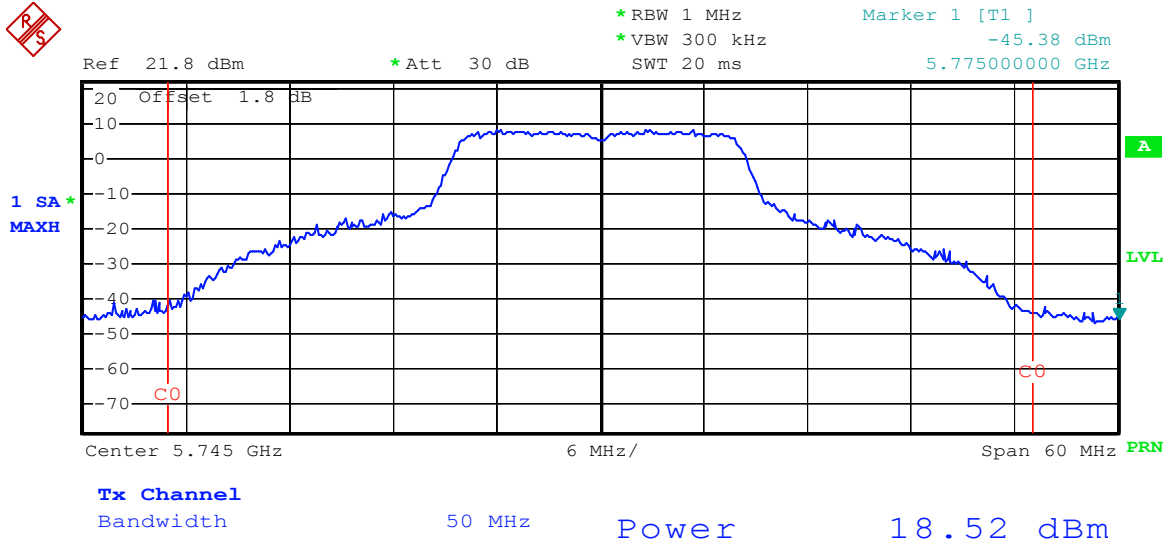

(CH 153) : 5765MHz

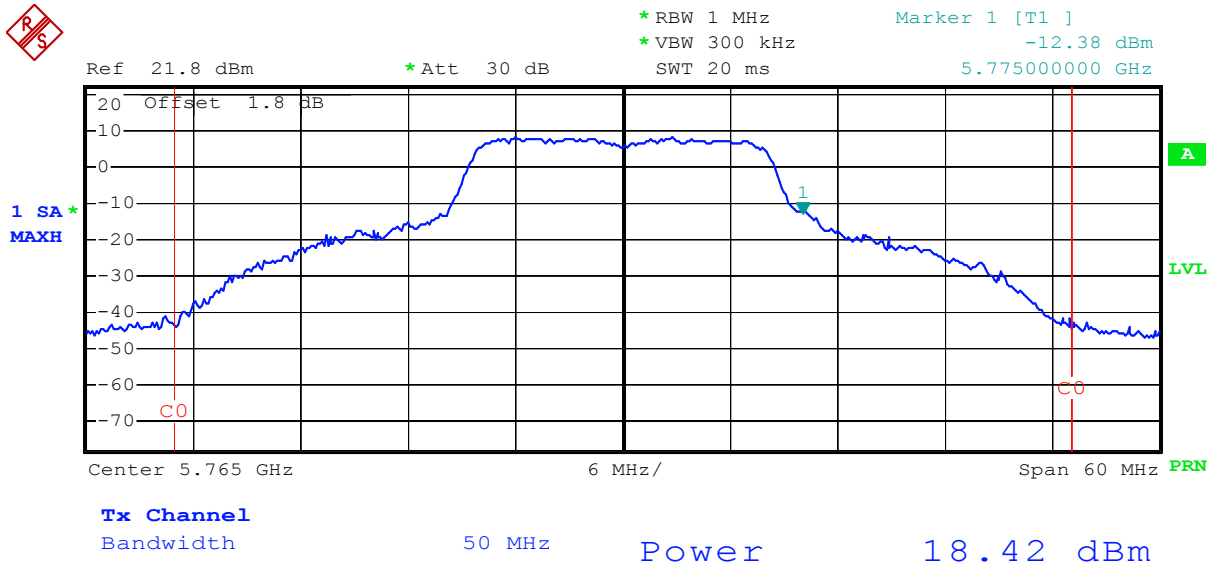



(CH 161) : 5805MHz

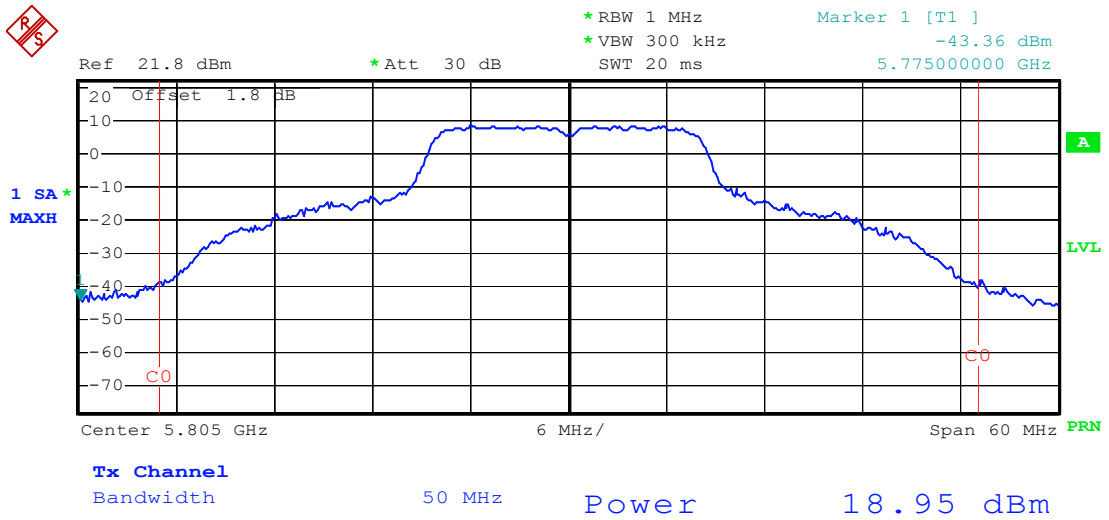

5.3. Test of Peak Power Spectral Density

5.3.1. Measuring Instruments

Item 7 of the table on section 6.

5.3.2. Test Procedures

1. The transmitter output is connected to the spectrum analyzer through an attenuator.
2. Set RBW of spectrum analyzer to 1000kHz and VBW to 3000kHz.
3. Use sample detector mode, span 50MHz and trace average of 100 sweeps time
4. Mark peak power and record the power density.

5.3.3. Test Setup Layout

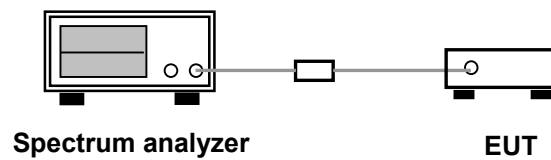



5.3.4. Test Result : See spectrum analyzer plots below

- Normal Mode
- Temperature: 24°C
- Relative Humidity: 64 %
- Duty cycle of the equipment during the test: 100%

Channel	Frequency (MHz)	Density (dBm)	Limits (dBm)
36	5180	0.79	4dBm
40	5200	0.64	4dBm
48	5240	0.57	4dBm
52	5260	2.62	11dBm
56	5280	2.53	11dBm
64	5320	1.99	11dBm
149	5745	2.38	17dBm
153	5765	2.23	17dBm
161	5805	2.70	17dBm



(CH 36) : 5180MHz

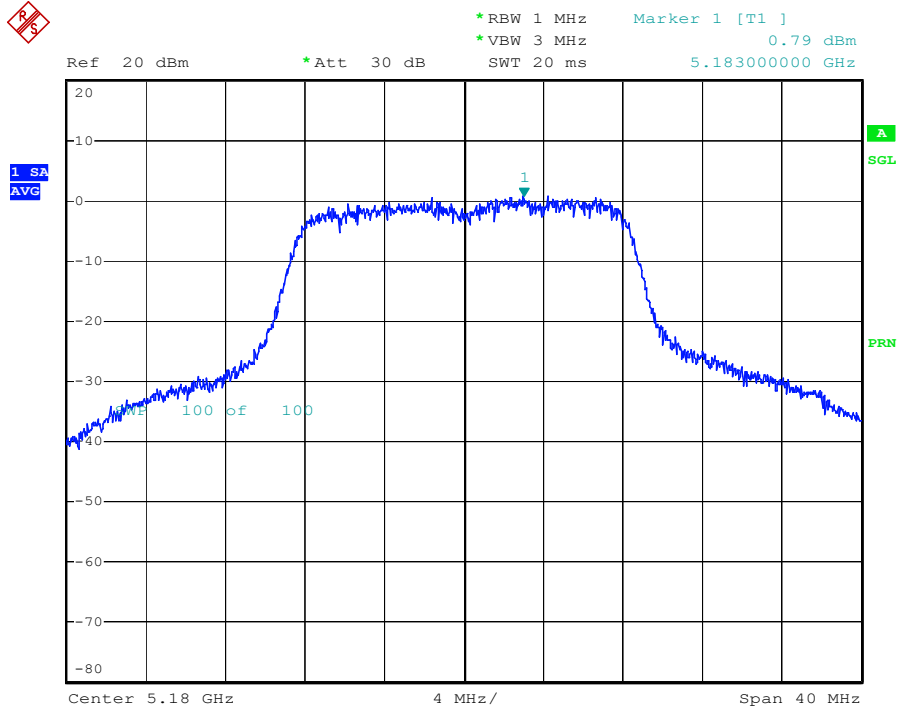

Date: 2.SEP.2004 10:57:53

(CH 40) : 5200MHz

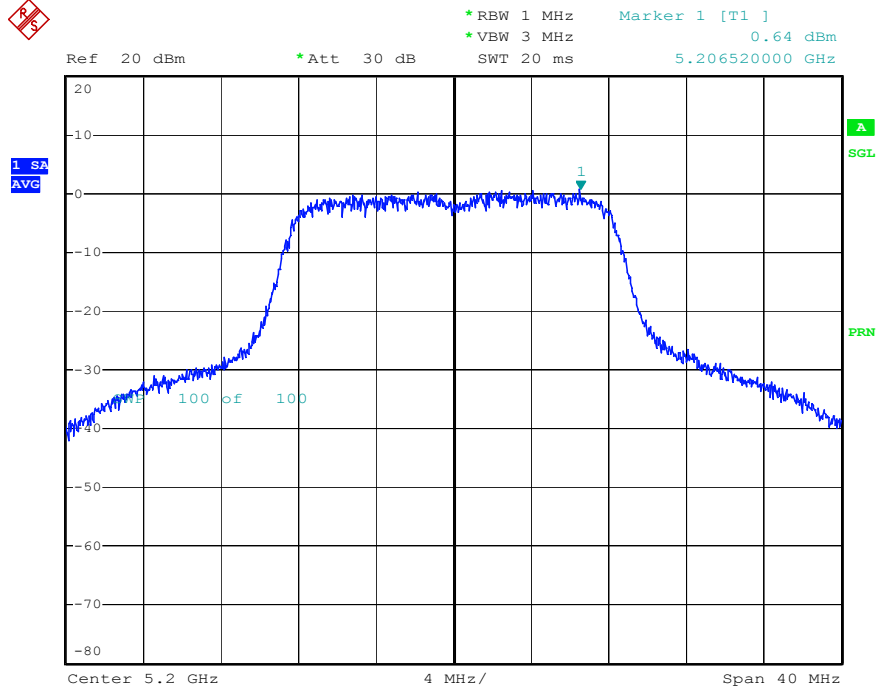

Date: 2.SEP.2004 10:53:19



(CH 48) : 5240MHz

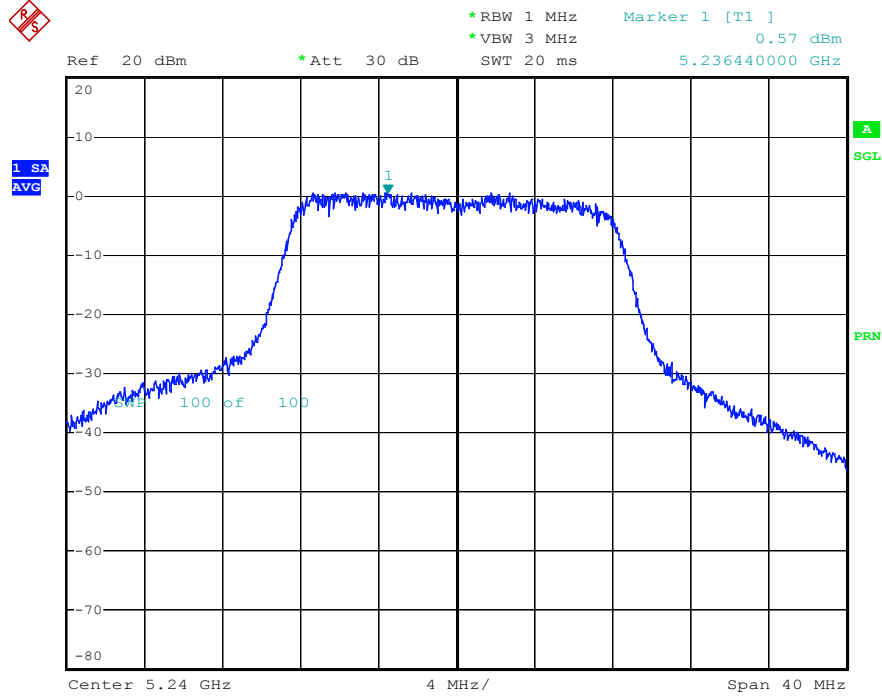

Date: 2.SEP.2004 10:52:24

(CH 52) : 5260MHz

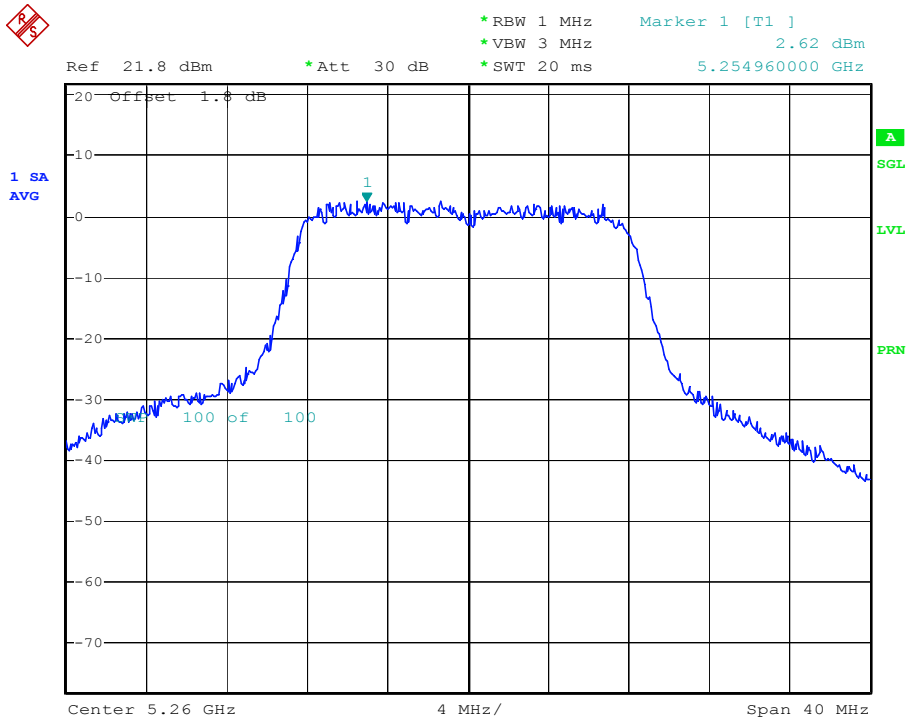

Date: 1.NOV.2004 14:38:35



(CH 56) : 5280MHz

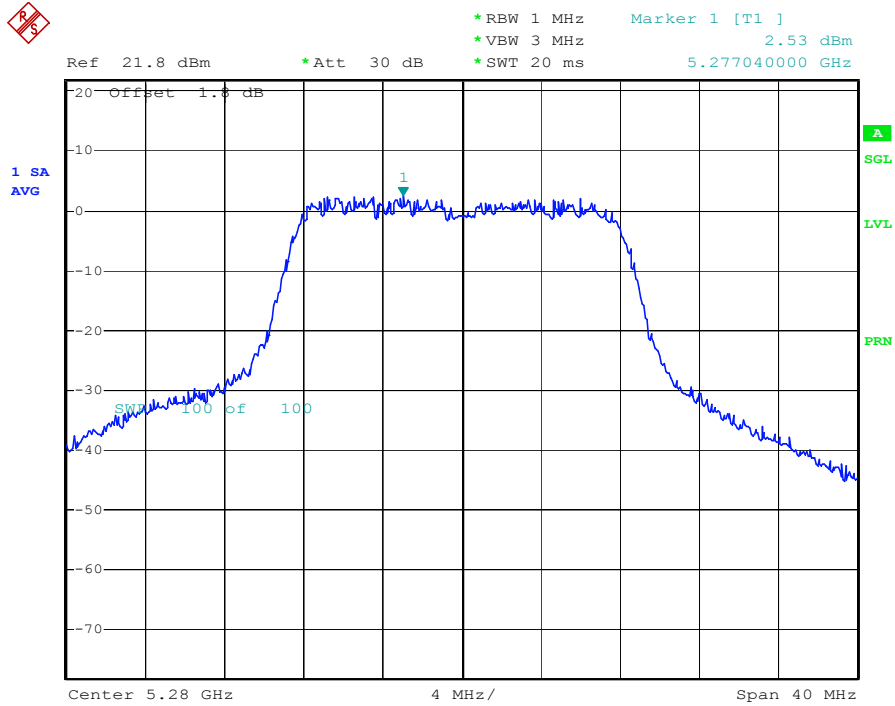

Date: 1.NOV.2004 14:39:23

(CH 64) : 5320MHz

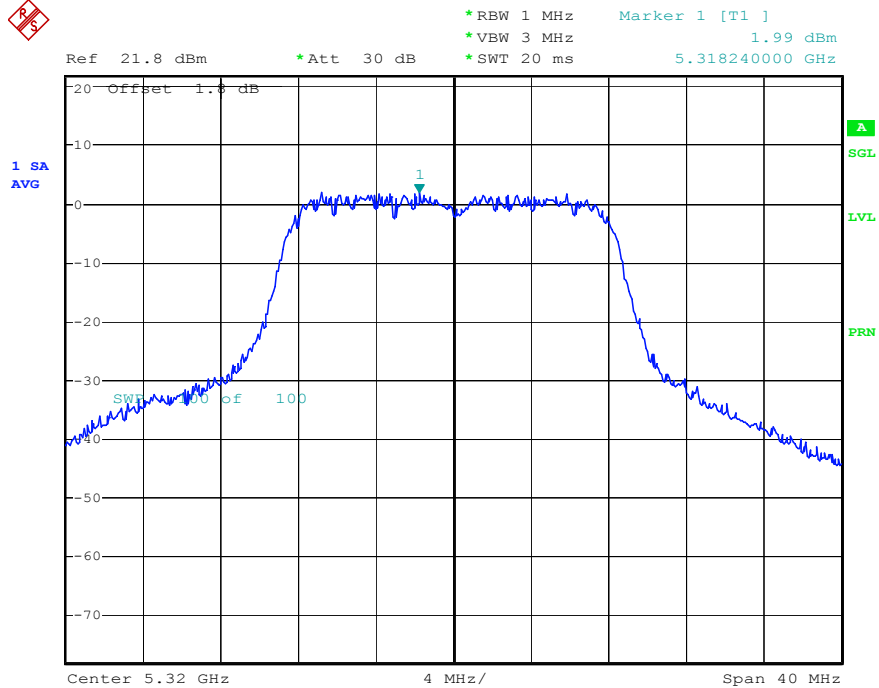

Date: 1.NOV.2004 14:40:03



(CH 149) : 5745MHz

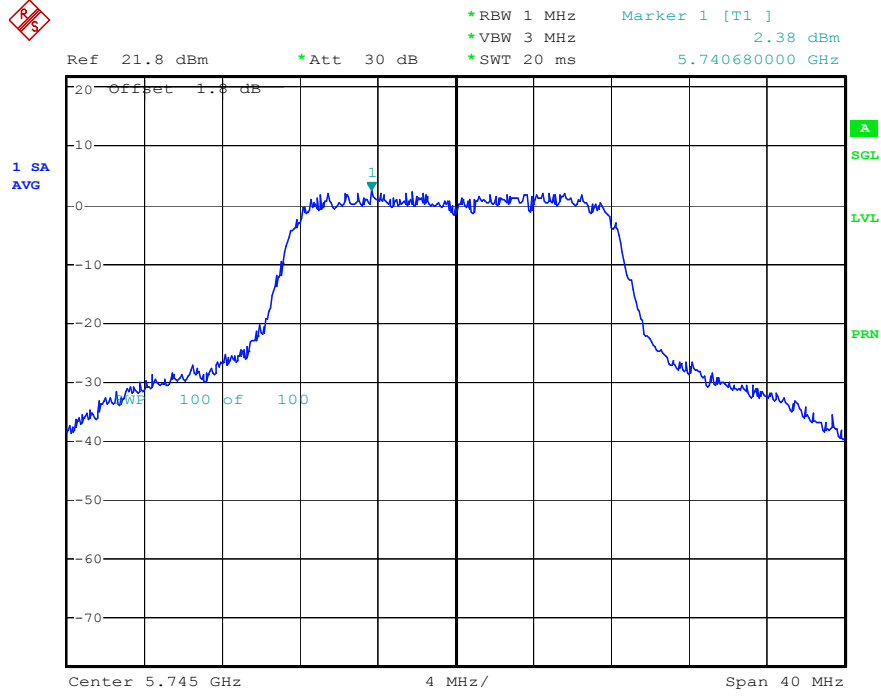

Date: 1.NOV.2004 14:40:38

(CH 153) : 5765MHz

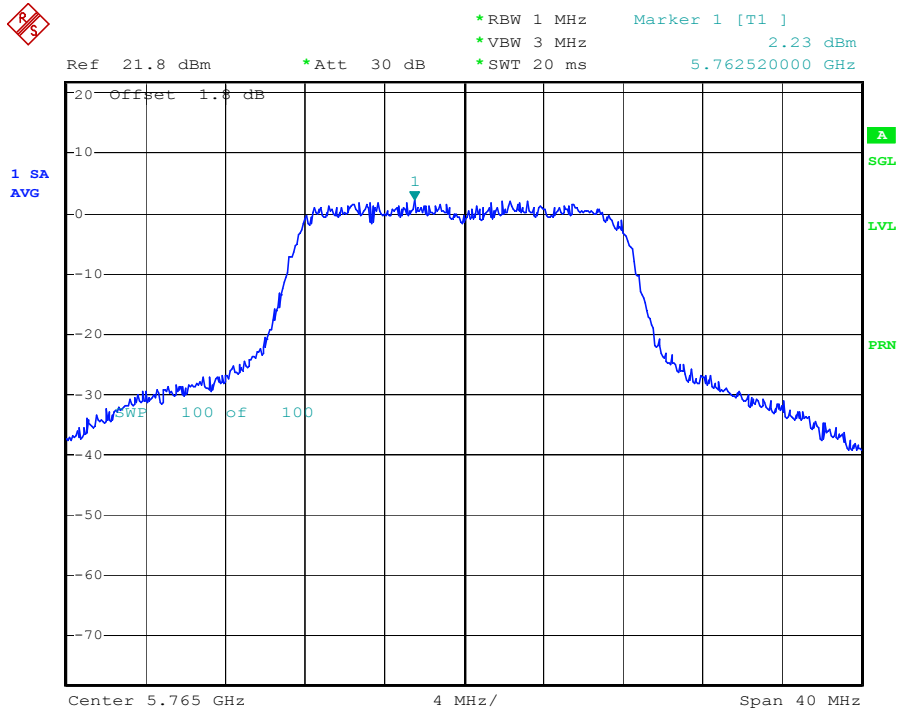

Date: 1.NOV.2004 14:41:08



(CH 161) : 5805MHz

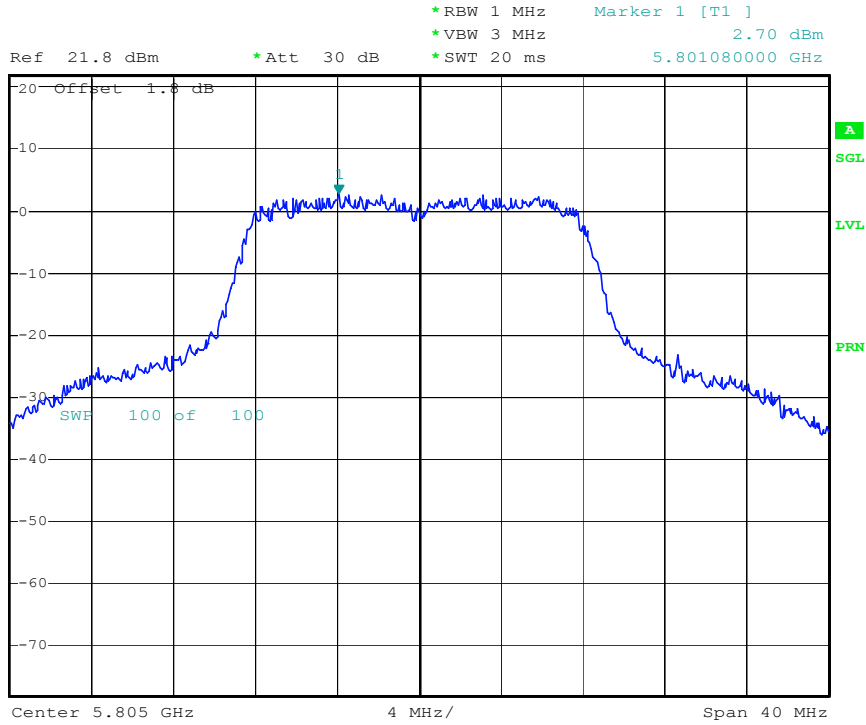

Date: 1.NOV.2004 14:41:53

5.4. Test of the Ratio of Peak Excursion

5.4.1. Measuring Instruments

Item 7 of the table on section 6.

5.4.2. Test Procedures

1. The transmitter output is connected to the spectrum analyzer through an attenuator.
2. Trace 1: Set RBW of spectrum analyzer to 1000kHz and VBW to 3000kHz.
Use peak detector mode, Max-hold and search the peak of trace 1.
3. Trace 2: Set RBW of spectrum analyzer to 1000kHz and VBW to 300kHz.
Use sample detector mode, trace max-hold and search the peak of trace 2
4. The delta limits is 13dB between trace 1 and trace 2 of the peak value.

5.4.3. Test Setup Layout

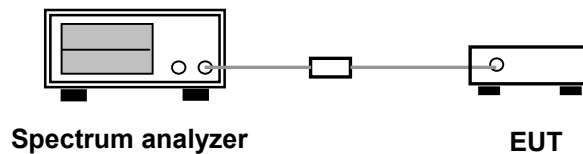



5.4.4. Test Result : See spectrum analyzer plots below

- Normal Mode
- Temperature: 24°C
- Relative Humidity: 64 %
- Duty cycle of the equipment during the test: 100%

Channel	Frequency (MHz)	Peak Excursion (dB)	Limits (dB)
36	5180	4.16	13
40	5200	4.01	13
48	5240	4.08	13
52	5260	4.11	13
56	5280	3.60	13
64	5320	4.03	13
149	5745	3.64	13
153	5765	3.85	13
161	5805	3.51	13



(CH 36) : 5180MHz

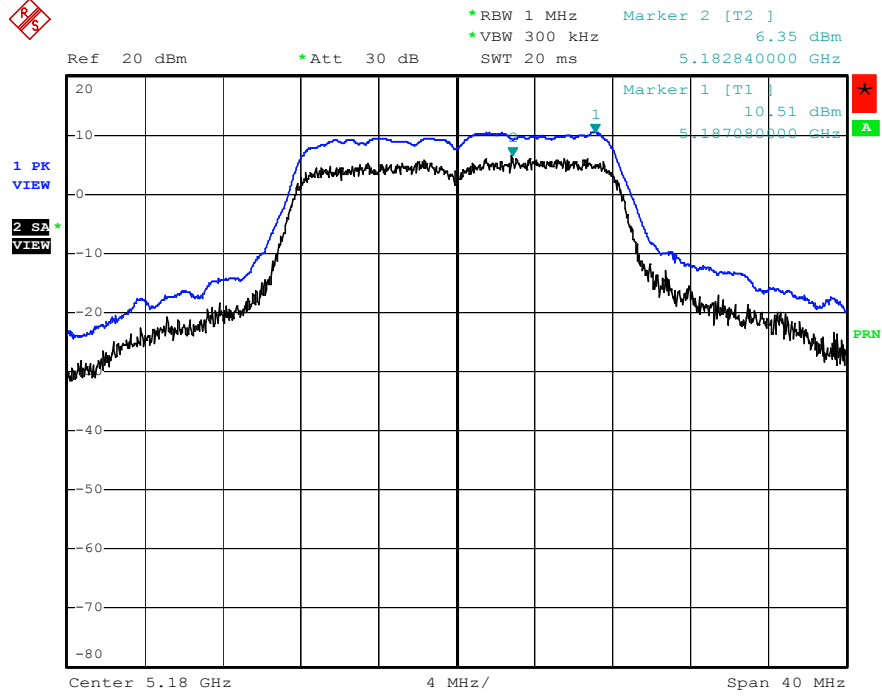

Date: 2.SEP.2004 12:00:07

(CH 40) : 5200MHz

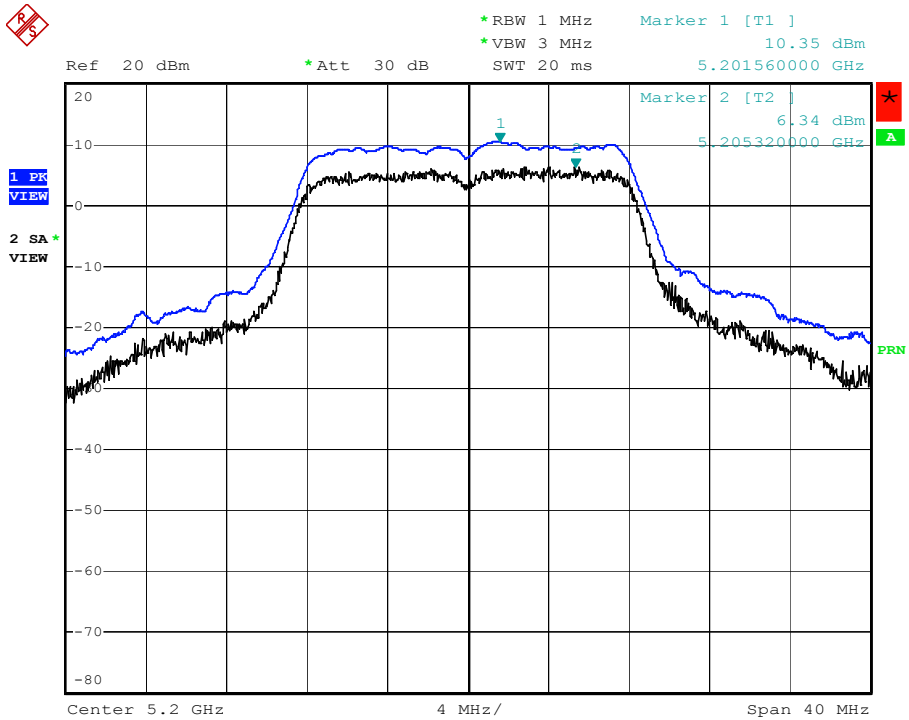

Date: 2.SEP.2004 11:58:53



(CH 48) : 5240MHz

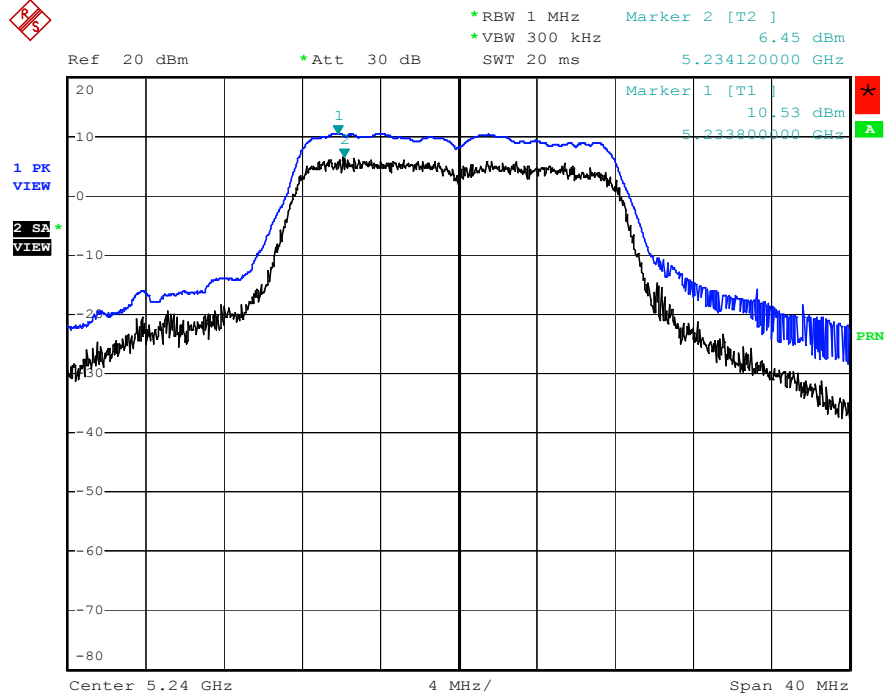

Date: 2.SEP.2004 11:57:04

(CH 52) : 5260MHz

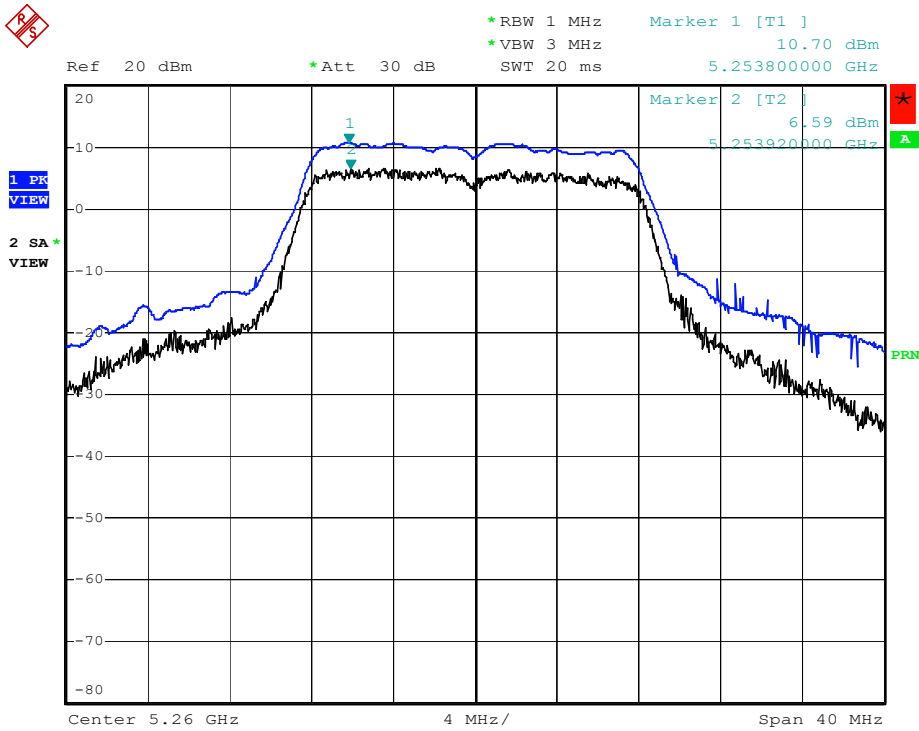

Date: 2.SEP.2004 11:54:51



(CH 56) : 5280MHz

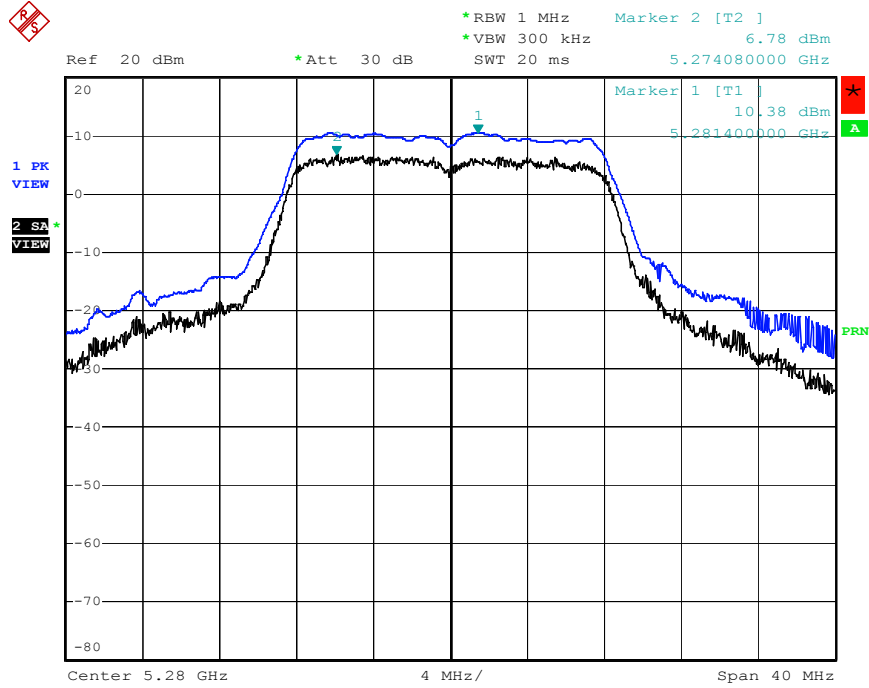

Date: 2.SEP.2004 11:51:57

(CH 64) : 5320MHz

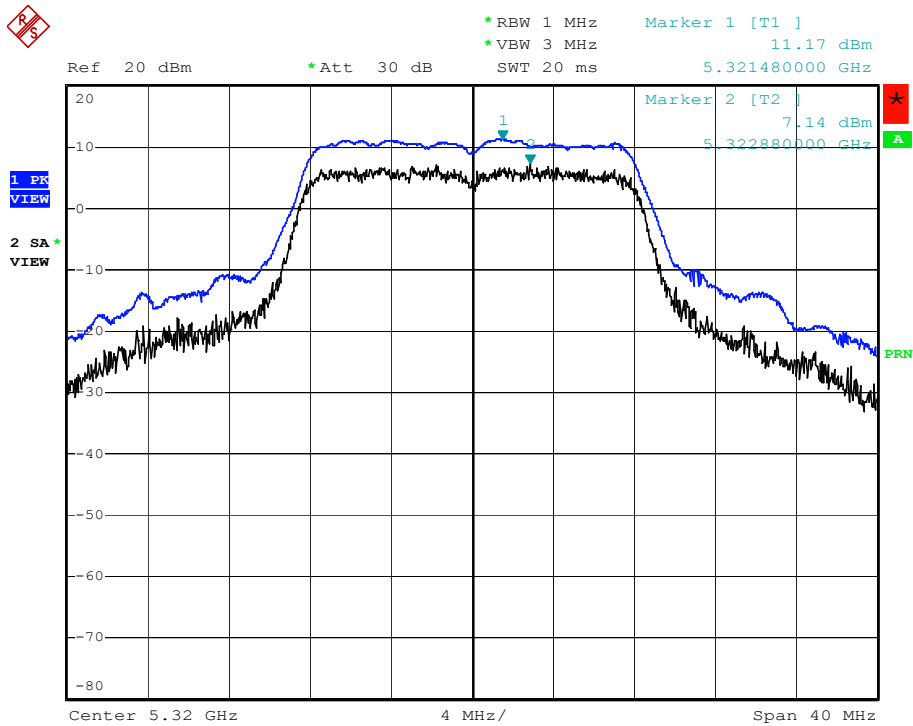

Date: 2.SEP.2004 11:50:35



(CH 149) : 5745MHz

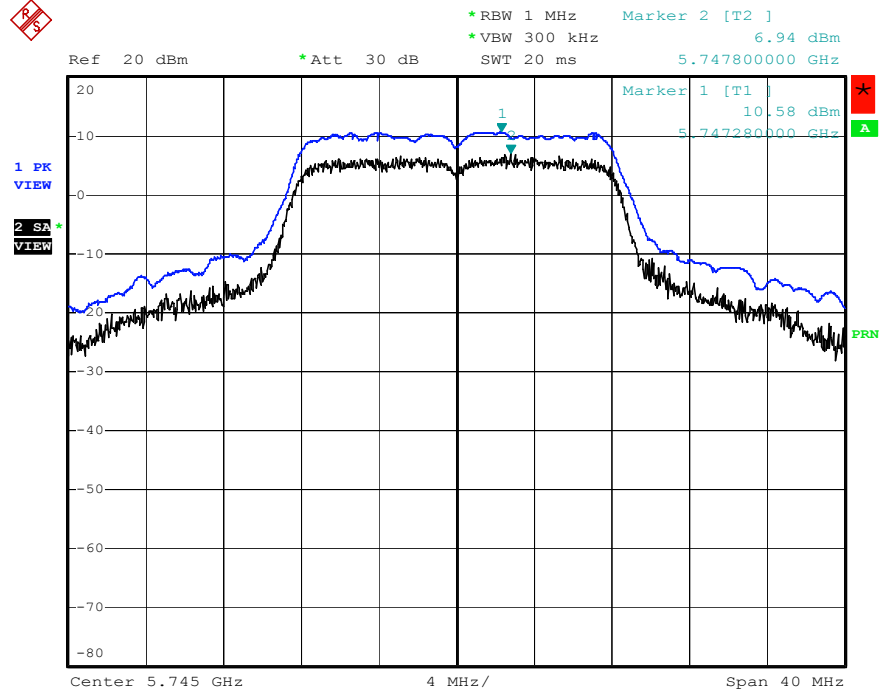

Date: 2.SEP.2004 11:48:38

(CH 153) : 5765MHz

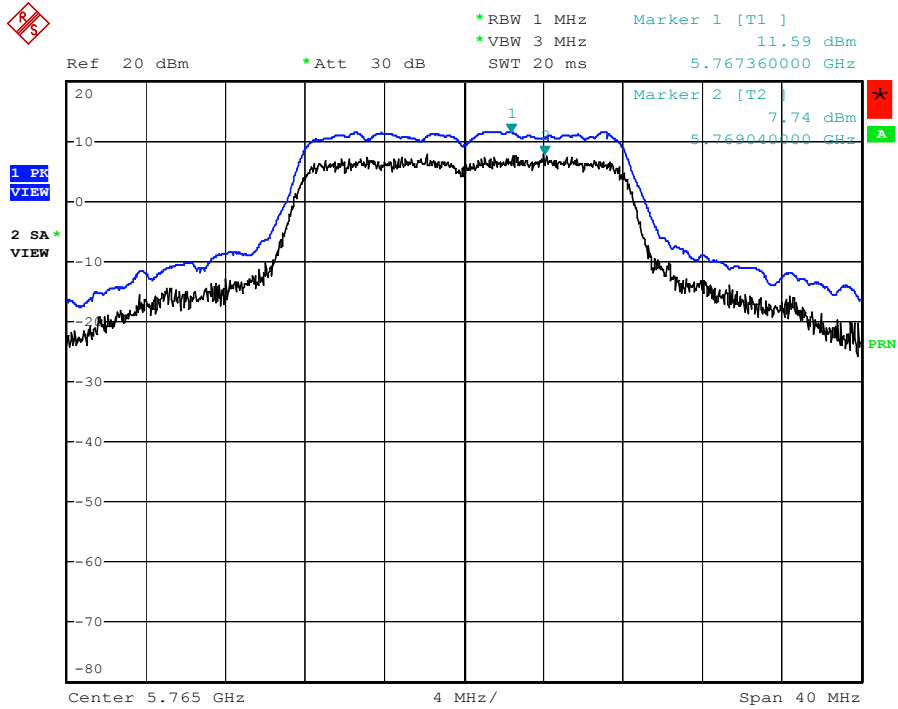

Date: 2.SEP.2004 11:47:10



(CH 161) : 5805MHz

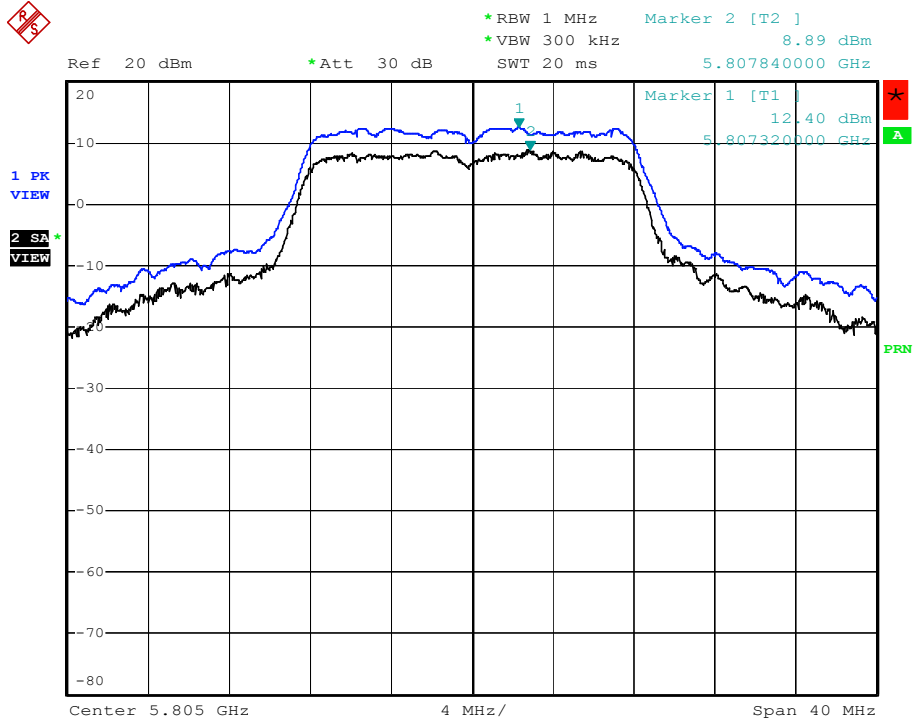

Date: 2.SEP.2004 11:45:31



5.5. Test of Band Edges of the Operating Frequency

5.5.1. Measuring Instruments

Item 9 of the table on section 6.

5.5.2. Test Procedures

1. The transmitter is set to the lowest channel.
2. The transmitter output was connected to the spectrum analyzer via a cable and cable loss is used as the offset of the spectrum analyzer.
3. Set both RBW and VBW of spectrum analyzer to 1000KHz and 300Hz with convenient frequency span including 100MHz bandwidth from lower band edge.
4. The lowest band edges emission was measured and recorded.
5. The transmitter set to the highest channel and repeated 2~4.

5.5.3. Test Result

Test Result in lower band (Channel 01) :	PASS
Test Result in higher band(Channel 11) :	PASS



5.5.4. Note on Band edge Emission

(For Operating Frequency in 5.15~5.35GHz)

(A) Left Edge

The band edge emission plot shows 50.26dB delta between carrier maximum power and local maximum emission in the restricted band.

CH01 Carrier power strength (dB μ V/m)	Delta (dB)	The maximum field strength in restrict band (dB μ V/m)	Limit (dB μ V/m)	Margin (dB)
96.68	50.26	44.27	54.00	-9.73

(B) Right Edge

The band edge emission plot shows 48.97dB delta between carrier maximum power and local maximum emission in the restricted band

CH08 Carrier power strength (dB μ V/m)	Delta (dB)	The maximum field strength in restrict band (dB μ V/m)	Limit (dB μ V/m)	Margin (dB)
91.5	48.97	39.38	54.00	-14.62

* The maximum field strength in restricted band is the emission of carrier power strength subtract to the delta between carrier maximum power and local maximum emission in the restricted band.



(CH 36) : 5180MHz

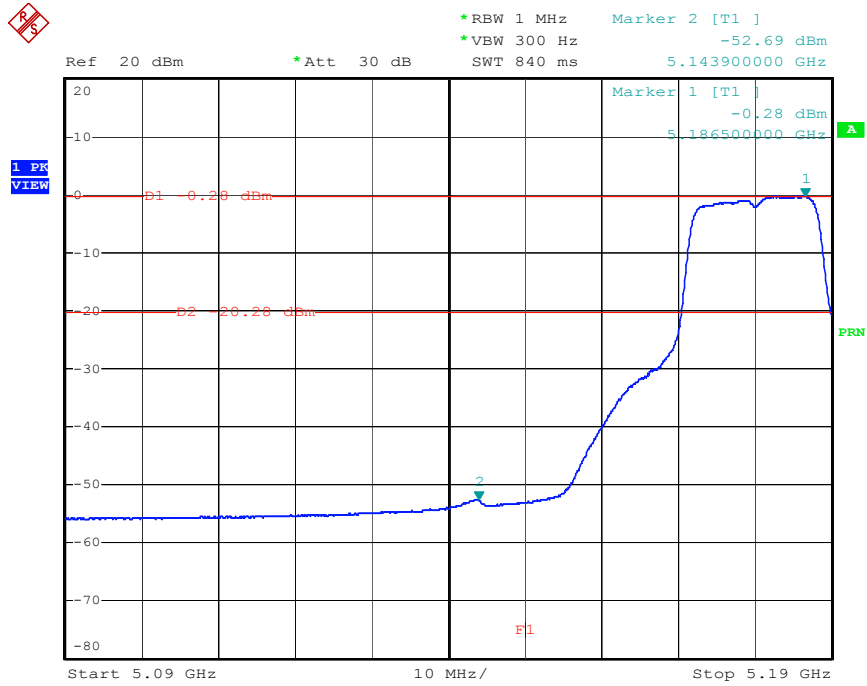

Date: 2.SEP.2004 12:18:00

(CH 64) : 5320MHz

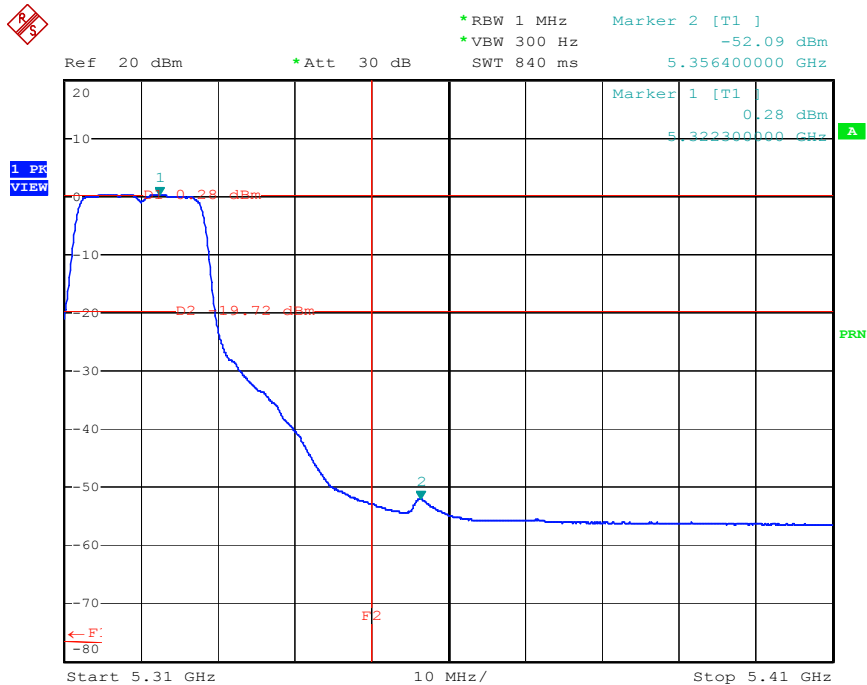

Date: 2.SEP.2004 12:22:48



5.6.

(For Operating Frequency in 5.725~5.825GHz)

(A)Left Edge

Spurious (MHz)	Maximum EIRP outside Band edge (dBm)	Limit (dBm)	Margin (dB)
5724.70	-20.23	-17	-3.23
5714.50	-36.90	-27	-9.90

(B) Right Edge

Spurious (MHz)	Maximum EIRP outside Band edge (dBm)	Limit (dBm)	Margin (dB)
5825.16	-25.85	-17	-8.85
5838.08	-43.25	-27	-16.25



5.7. Test of Spurious Radiated Emission

5.7.1. Measuring Instruments

Please reference item 8~19 in chapter 6 for the instruments used for testing.

5.7.2. Test Procedures

1. Configure the EUT according to ANSI C63.4.
2. The EUT was placed on the top of the turn table 0.8 meter above ground.
3. The phase center of the receiving antenna mounted on the top of a height-variable antenna tower was placed 3 meters far away from the turn table.
4. Power on the EUT and all the supporting units.
5. The turn table was rotated by 360 degrees to determine the position of the highest radiation.
6. The height of the broadband receiving antenna was varied between one meter and four meters above ground to find the maximum emission field strength of both horizontal and vertical polarization.
7. For each suspected emission, the antenna tower was scan (from 1 M to 4 M) and then the turn table was rotated (from 0 degree to 360 degrees) to find the maximum reading.
8. Set the test-receiver system to Peak or CISPR quasi-peak Detect Function with specified bandwidth under Maximum Hold Mode.
9. For emission above 1GHz, use 1MHz VBW and RBW for peak reading. Then 1MHz RBW and 300Hz VBW for average reading in spectrum analyzer.
10. If the emission level of the EUT in peak mode was 3 dB lower than the average limit specified, then testing will be stopped and peak values of EUT will be reported, otherwise, the emissions which do not have 3 dB margin will be repeated one by one using the quasi-peak method for below 1GHz and average method for above the 1GHz. the reported.
11. For testing above 1GHz, the emission level of the EUT in peak mode was 20dB higher than average limit (that means the emission level in peak mode also complies with the limit in average mode), then testing will be stopped and peak values of EUT will be reported, otherwise, the emissions will be measured in average mode again and reported.

5.7.3. Test Setup Layout

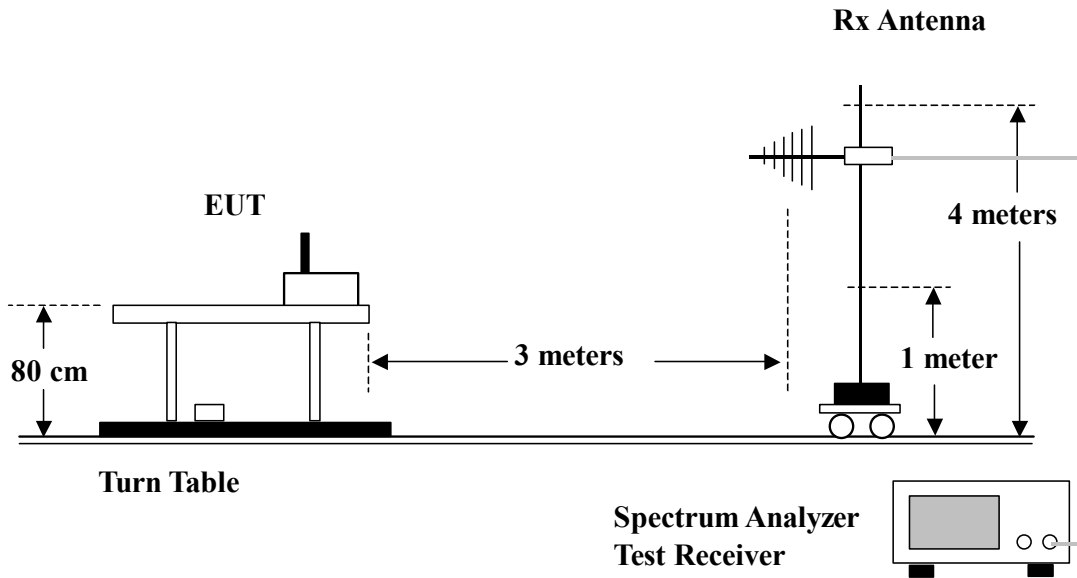



5.7.4. Test Results and Limit

Note:

Emission level (dBuV/m) = 20 log Emission level (uV/m)

Corrected Reading: Probe Factor + Cable Loss + Read Level - Preamp Factor = Level

Test Mode	5805MHz	Temperature	25 deg. C	Tested By	Steve Chen
Freq. Range	30MHz~1GHz	Humidity	63%		

(A) Polarization: Horizontal

	Freq	Level	Over Limit	Limit Line	Read Level	Probe Factor	Cable Loss	Preamp Factor	Remark	Ant Pos	Table Pos
	MHz	dBuV/m	dB	dBuV/m	dBuV	dB	dB	dB		cm	deg
1	106.670	30.45	-13.05	43.50	46.53	9.97	1.84	27.89	Peak	---	---
2	166.340	23.88	-19.62	43.50	36.03	13.29	2.33	27.77	Peak	---	---
3	199.660	27.57	-15.93	43.50	36.93	15.77	2.57	27.70	Peak	---	---
1	265.600	38.10	-7.90	46.00	49.84	12.77	2.93	27.44	Peak	---	---
2	832.800	32.87	-13.13	46.00	34.44	21.83	5.23	28.63	Peak	---	---
3	905.600	34.21	-11.79	46.00	35.31	21.83	5.36	28.29	Peak	---	---

(B) Polarization: Vertical

	Freq	Level	Over Limit	Limit Line	Read Level	Probe Factor	Cable Loss	Preamp Factor	Remark	Ant Pos	Table Pos
	MHz	dBuV/m	dB	dBuV/m	dBuV	dB	dB	dB		cm	deg
1	33.230	32.88	-7.12	40.00	47.64	12.29	0.99	28.04	Peak	127	181
2	99.020	24.30	-19.20	43.50	41.49	8.95	1.76	27.90	Peak	---	---
3	129.790	26.94	-16.56	43.50	40.34	12.33	2.11	27.84	Peak	---	---
1	665.600	32.16	-13.84	46.00	35.64	20.60	4.65	28.73	Peak	---	---
2	832.000	31.94	-14.06	46.00	33.52	21.84	5.22	28.64	Peak	---	---
3	1000.000	30.19	-23.81	54.00	28.80	23.90	5.69	28.20	Peak	---	---



Test Mode	5180MHz	Temperature	25 deg. C	Tested By	Steve Chen
Freq. Range	1GHz~40GHz	Humidity	63%		

(A) Polarization: Horizontal

	Freq	Level	Over Limit	Limit Line	Read Level	Probe Factor	Cable Loss	Preamp Factor	Remark	Ant Pos	Table Pos
	MHz	dBuV/m	dB	dBuV/m	dBuV	dB	dB	dB		cm	deg
1	1000.000	41.26	-12.74	54.00	58.75	23.80	1.11	42.40	Average	---	---
2	1332.000	41.70	-12.30	54.00	58.11	24.77	1.35	42.53	Average	---	---
3	1668.000	38.56	-15.44	54.00	53.77	25.88	1.55	42.64	Average	---	---
1	3604.000	41.30	-12.70	54.00	50.94	31.62	2.08	43.34	Average	---	---
2	4862.000	44.14	-9.86	54.00	52.69	33.32	2.53	44.40	Average	---	---
3	4974.000	45.14	-8.86	54.00	53.55	33.57	2.51	44.49	Average	---	---

(B) Polarization: Vertical

	Freq	Level	Over Limit	Limit Line	Read Level	Probe Factor	Cable Loss	Preamp Factor	Remark	Ant Pos	Table Pos
	MHz	dBuV/m	dB	dBuV/m	dBuV	dB	dB	dB		cm	deg
1	1326.000	40.57	-13.43	54.00	57.00	24.75	1.35	42.53	Average	---	---
2	1998.000	45.57	-8.43	54.00	59.64	27.11	1.52	42.70	Average	102	215
3	2396.000	43.22	-10.78	54.00	55.95	28.16	1.73	42.62	Average	---	---

Remark: Spurious on higher frequency band, the emission emitted by the EUT is too low to be measured.



Test Mode	5240MHz	Temperature	25 deg. C	Tested By	Steve Chen
Freq. Range	1GHz~40GHz	Humidity	63%		

(A) Polarization: Horizontal

	Freq	Level	Over Limit	Limit Line	Read Level	Probe Factor	Cable Loss	Preamp Factor	Remark	Ant Pos	Table Pos
	MHz	dBuV/m	dB	dBuV/m	dBuV	dB	dB	dB		cm	deg
1	1334.000	45.86	-8.14	54.00	62.28	24.77	1.35	42.54	Average	---	---
2	1596.000	38.86	-15.14	54.00	54.36	25.61	1.51	42.62	Average	---	---
3	1662.000	38.69	-15.31	54.00	53.92	25.86	1.54	42.63	Average	---	---
1	3598.000	41.63	-12.37	54.00	51.26	31.60	2.10	43.33	Average	---	---
2	4966.000	46.12	-7.88	54.00	54.58	33.55	2.47	44.48	Average	---	---
1	5134.000	53.02	-20.98	74.00	61.31	33.83	2.50	44.62	Peak	---	---
2	5134.000	40.94	-13.06	54.00	49.23	33.83	2.50	44.62	Average	---	---
3	5172.000	53.42	-20.58	74.00	61.61	33.89	2.57	44.65	Peak	---	---
4	5172.000	41.44	-12.56	54.00	49.63	33.89	2.57	44.65	Average	---	---

(B) Polarization: Vertical

	Freq	Level	Over Limit	Limit Line	Read Level	Probe Factor	Cable Loss	Preamp Factor	Remark	Ant Pos	Table Pos
	MHz	dBuV/m	dB	dBuV/m	dBuV	dB	dB	dB		cm	deg
1	1998.000	44.13	-9.87	54.00	58.20	27.11	1.52	42.70	Average	---	---
2	2334.000	42.97	-11.03	54.00	55.91	27.99	1.70	42.63	Average	---	---
3	2404.000	42.33	-11.67	54.00	55.04	28.18	1.73	42.62	Average	---	---
1	4916.000	47.72	-6.28	54.00	56.24	33.44	2.48	44.44	Average	102	161
1	5142.000	58.62	-15.38	74.00	66.87	33.84	2.53	44.62	Peak	---	---
2	5142.000	46.58	-7.42	54.00	54.83	33.84	2.53	44.62	Average	---	---

Remark: Spurious on higher frequency band, the emission emitted by the EUT is too low to be measured.



Test Mode	5260MHz	Temperature	25 deg. C	Tested By	Steve Chen
Freq. Range	1GHz~40GHz	Humidity	63%		

(A) Polarization: Horizontal

	Freq	Level	Over Limit	Limit Line	Read Level	Probe Factor	Cable Loss	Preamp Factor	Remark	Ant Pos	Table Pos
	MHz	dBuV/m	dB	dBuV/m	dBuV	dB	dB	dB		cm	deg
1	1004.000	38.06	-15.94	54.00	55.52	23.82	1.12	42.40	Average	---	---
2	1326.000	46.09	-7.91	54.00	62.52	24.75	1.35	42.53	Average	---	---
3	1662.000	38.00	-16.00	54.00	53.23	25.86	1.54	42.63	Average	---	---
1	4908.000	46.06	-7.94	54.00	54.58	33.42	2.49	44.43	Average	---	---
1	5166.000	53.78	-20.22	74.00	61.97	33.88	2.57	44.64	Peak	---	---
2	5166.000	41.94	-12.06	54.00	50.13	33.88	2.57	44.64	Average	---	---

(B) Polarization: Vertical

	Freq	Level	Over Limit	Limit Line	Read Level	Probe Factor	Cable Loss	Preamp Factor	Remark	Ant Pos	Table Pos
	MHz	dBuV/m	dB	dBuV/m	dBuV	dB	dB	dB		cm	deg
1	1996.000	44.42	-9.58	54.00	58.51	27.10	1.51	42.70	Average	---	---
2	2332.000	40.84	-13.16	54.00	53.77	27.99	1.71	42.63	Average	---	---
3	2390.000	42.94	-11.06	54.00	55.70	28.14	1.72	42.62	Average	---	---
1	5166.000	59.06	-14.94	74.00	67.25	33.88	2.57	44.64	Peak	---	---
2	5166.000	46.69	-7.31	54.00	54.88	33.88	2.57	44.64	Average	105	168

Remark: Spurious on higher frequency band, the emission emitted by the EUT is too low to be measured.



Test Mode	5320MHz	Temperature	25 deg. C	Tested By	Steve Chen
Freq. Range	1GHz~40GHz	Humidity	63%		

(A) Polarization: Horizontal

	Freq	Level	Over Limit	Limit Line	Read Level	Probe Factor	Cable Loss	Preamp Factor	Remark	Ant Pos	Table Pos
	MHz	dBuV/m	dB	dBuV/m	dBuV	dB	dB	dB		cm	deg
1	1000.000	43.98	-10.02	54.00	61.47	23.80	1.11	42.40	Average	---	---
2	1332.000	42.35	-11.65	54.00	58.76	24.77	1.35	42.53	Average	---	---
3	1660.000	38.99	-15.01	54.00	54.23	25.85	1.54	42.63	Average	---	---
1	3590.000	41.71	-12.29	54.00	51.33	31.58	2.12	43.32	Average	---	---
2	4948.000	46.59	-7.41	54.00	55.10	33.51	2.45	44.47	Average	---	---
1	5164.000	54.75	-19.25	74.00	62.94	33.88	2.57	44.64	Peak	---	---
2	5164.000	44.47	-9.53	54.00	52.66	33.88	2.57	44.64	Average	---	---

(B) Polarization: Vertical

	Freq	Level	Over Limit	Limit Line	Read Level	Probe Factor	Cable Loss	Preamp Factor	Remark	Ant Pos	Table Pos
	MHz	dBuV/m	dB	dBuV/m	dBuV	dB	dB	dB		cm	deg
1	1000.000	46.35	-7.65	54.00	63.84	23.80	1.11	42.40	Average	---	---
2	1998.000	44.34	-9.66	54.00	58.41	27.11	1.52	42.70	Average	---	---
3	2326.000	42.17	-11.83	54.00	55.11	27.97	1.72	42.63	Average	---	---
1	3598.000	41.18	-12.82	54.00	50.81	31.60	2.10	43.33	Average	---	---
1	5158.000	59.22	-14.78	74.00	67.43	33.87	2.56	44.64	Peak	---	---
2	5158.000	47.42	-6.58	54.00	55.63	33.87	2.56	44.64	Average	109	333
3	6782.000	45.57	-8.43	54.00	52.73	35.11	2.87	45.14	Average	---	---

Remark: Spurious on higher frequency band, the emission emitted by the EUT is too low to be measured.



Test Mode	5745MHz	Temperature	25 deg. C	Tested By	Steve Chen
Freq. Range	1GHz~40GHz	Humidity	63%		

(A) Polarization: Horizontal

	Freq	Level	Over Limit	Limit Line	Read Level	Probe Factor	Cable Loss	Preamp Factor	Remark	Ant Pos	Table Pos
	MHz	dBuV/m	dB	dBuV/m	dBuV	dB	dB	dB		cm	deg
1	1000.000	44.73	-9.27	54.00	62.22	23.80	1.11	42.40	Peak	---	---
2	1000.000	30.63	-23.37	54.00	48.12	23.80	1.11	42.40	Average	---	---
3	1326.000	48.09	-25.91	74.00	64.52	24.75	1.35	42.53	Peak	---	---
4	1326.000	41.99	-12.01	54.00	58.42	24.75	1.35	42.53	Average	---	---
5	1668.000	38.39	-15.61	54.00	53.60	25.88	1.55	42.64	Average	---	---
1	4852.000	46.05	-7.95	54.00	54.60	33.30	2.54	44.39	Average	---	---
1	5172.000	53.95	-20.05	74.00	62.14	33.89	2.57	44.65	Peak	---	---
2	5172.000	42.08	-11.92	54.00	50.27	33.89	2.57	44.65	Average	---	---

(B) Polarization: Vertical

	Freq	Level	Over Limit	Limit Line	Read Level	Probe Factor	Cable Loss	Preamp Factor	Remark	Ant Pos	Table Pos
	MHz	dBuV/m	dB	dBuV/m	dBuV	dB	dB	dB		cm	deg
1	1326.000	42.71	-11.29	54.00	59.14	24.75	1.35	42.53	Average	---	---
2	1996.000	44.84	-9.16	54.00	58.93	27.10	1.51	42.70	Average	---	---
3	2396.000	44.68	-9.32	54.00	57.41	28.16	1.73	42.62	Average	---	---
1	4862.000	46.52	-7.48	54.00	55.07	33.32	2.53	44.40	Average	---	---
2	4942.000	46.78	-7.22	54.00	55.29	33.50	2.45	44.46	Average	---	---
1	5166.000	59.01	-14.99	74.00	67.20	33.88	2.57	44.64	Peak	---	---
2	5166.000	47.00	-7.00	54.00	55.19	33.88	2.57	44.64	Average	108	91

Remark: Spurious on higher frequency band, the emission emitted by the EUT is too low to be measured.



Test Mode	5805MHz	Temperature	25 deg. C	Tested By	Steve Chen
Freq. Range	1GHz~40GHz	Humidity	63%		

(A) Polarization: Horizontal

	Freq	Level	Over Limit	Limit Line	Read Level	Probe Factor	Cable Loss	Preamp Factor	Remark	Ant Pos	Table Pos
	MHz	dBuV/m	dB	dBuV/m	dBuV	dB	dB	dB		cm	deg
1	1000.000	42.48	-11.52	54.00	59.97	23.80	1.11	42.40	Average	---	---
2	1332.000	45.11	-8.89	54.00	61.52	24.77	1.35	42.53	Average	---	---
3	1668.000	38.49	-15.51	54.00	53.70	25.88	1.55	42.64	Average	---	---
1	5174.000	55.29	-18.71	74.00	63.48	33.89	2.57	44.65	Peak	---	---
2	5174.000	43.42	-10.58	54.00	51.61	33.89	2.57	44.65	Average	---	---

(A) Polarization: Vertical

	Freq	Level	Over Limit	Limit Line	Read Level	Probe Factor	Cable Loss	Preamp Factor	Remark	Ant Pos	Table Pos
	MHz	dBuV/m	dB	dBuV/m	dBuV	dB	dB	dB		cm	deg
1	1000.000	41.90	-12.10	54.00	59.39	23.80	1.11	42.40	Average	---	---
2	1998.000	44.98	-9.02	54.00	59.05	27.11	1.52	42.70	Average	---	---
3	2670.000	44.41	-9.59	54.00	56.10	29.04	1.98	42.71	Average	---	---
1	5164.000	58.14	-15.86	74.00	66.33	33.88	2.57	44.64	Peak	---	---
2	5164.000	46.72	-7.28	54.00	54.91	33.88	2.57	44.64	Average	105	169

Remark: Spurious on higher frequency band, the emission emitted by the EUT is too low to be measured.

5.7.5. Photographs of Radiated Emission Test Configuration

- The photographs show the configuration that generates the maximum emission.

FRONT VIEW



REAR VIEW

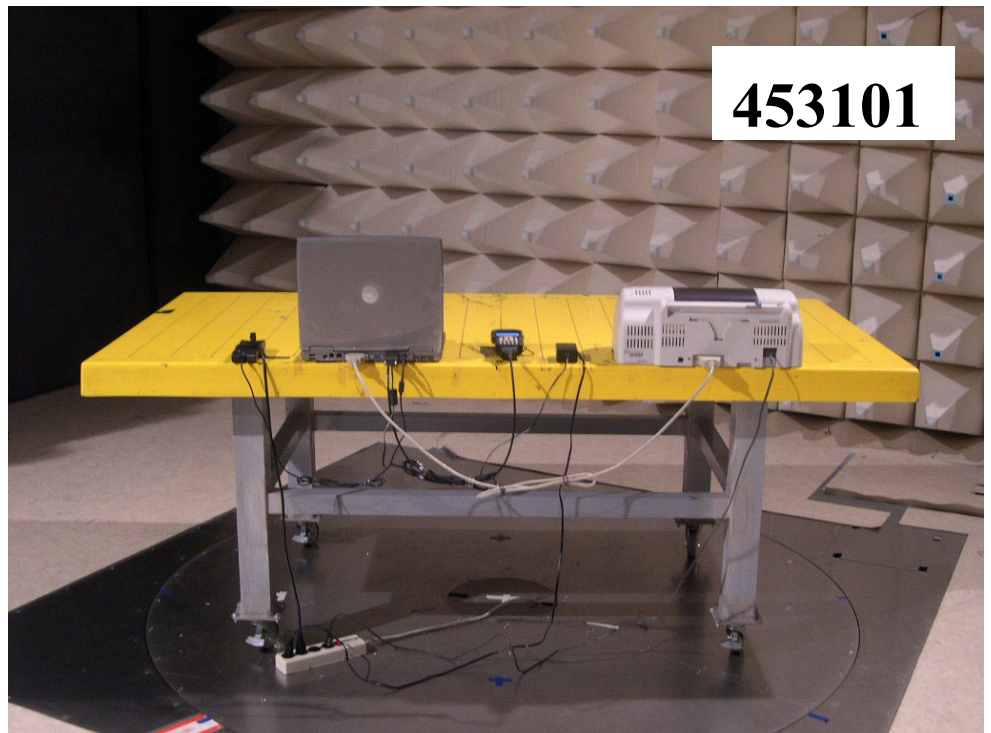

5.8. Test of Frequency Stability

5.8.1. Measuring Instruments

Item 9 of the table on section 6.

5.8.2. Test Procedures

1. The transmitter output is connected to the spectrum analyzer through an attenuator.
2. Set RBW of spectrum analyzer to 10kHz and VBW to 10kHz.
3. Use peak detector mode, Max-hold and search the peak of trace 1.
4. The test extreme voltage is, according to 2.1055(d)(1), is to change the primary supply voltage from 85 to 115 percent of the nominal value
5. Extreme temperature rule is, according to 2.1055(a)(1), $-30^{\circ}\text{C} \sim 50^{\circ}\text{C}$.

5.8.3. Test Setup Layout

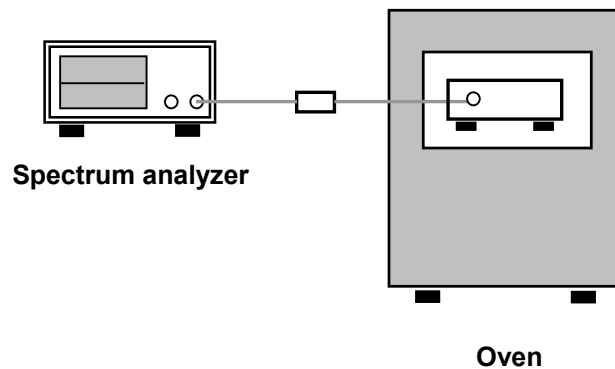



5.8.4. Test Result : See spectrum analyzer plots below

- Modulation Type: Un-Modulated Carrier (CW)
- Temperature: 26°C
- Relative Humidity: 64 %
- Duty cycle of the equipment during the test: 100%

Temperature vs. Frequency Stability

Temperature (°C)	Measurement Frequency (MHz)		
	5240.00	5320.00	5805
-30	5239.9690	5319.9690	5804.9670
-20	5239.9660	5319.9670	5804.9660
-10	5239.9630	5319.9620	5804.9630
0	5239.9560	5319.9540	5804.9530
10	5236.9480	5319.9510	5804.9470
20	5239.9410	5319.9430	5804.9460
30	5239.9470	5319.9480	5804.9480
40	5239.9550	5319.9530	5804.9540
50	5239.9580	5319.9580	5804.9580
Max. Deviation (KHz)	-31.0	-31.0	-33.0
Max. Deviation (ppm)	-5.92	-5.83	-5.68



Voltage vs. Frequency Stability

Voltage (V)	Measurement Frequency (MHz)		
	5240.00	5320.00	5805
126.50	5239.9560	5319.9540	5804.9530
110.00	5239.9410	5319.9430	5804.9460
93.50	5239.9550	5319.9530	5804.9540
Max. Deviation (MHz)	-44.0	-46.0	-46.0
Max. Deviation (ppm)	-8.40	-8.65	-7.92



5.9. Test of AC Power Line Conducted Emission

5.9.1. Measuring Instruments

Please reference item 1~7 in chapter 6 for the instruments used for testing.

5.9.2. Test Procedures

1. Configure the EUT according to ANSI C63.4.
2. The EUT has to be placed 0.4 meter far from the conducting wall of the shielding room and at least 80 centimeters from any other grounded conducting surface.
3. Connect EUT to the power mains through a line impedance stabilization network (LISN).
4. All the support units are connected to the other LISNs. The LISN should provides 50uH/50ohms coupling impedance.
5. The frequency range from 150 KHz to 30 MHz was searched.
6. Use the Channel & Power Controlling software to make the EUT working on selected channel and expected output power, then use the "H" Patter Generator software to make the supporting equipments stay on working condition.
7. Set the test-receiver system to Peak Detect Function and Specified Bandwidth with Maximum Hold Mode.
8. The measurement has to be done between each power line and ground at the power terminal for each RF channel. Only one RF channel has to be investigated since this test is independent with the RF channel selection.



5.9.3. Test Result of Conducted Emission

Test Mode	Mode 1	Tested By	Brian Lin
Temperature / Humidity	27 deg. C / 44%		

Line to Ground

	Freq	Level	Over Limit	Limit Line	Read Level	LISN Factor	Cable Loss	Remark
	MHz	dBuV	dB	dBuV	dBuV	dB	dB	
1	@0.1500000	45.46	-20.54	66.00	45.35	0.10	0.01	QP
2	0.1500000	19.52	-36.48	56.00	19.41	0.10	0.01	Average
3	@0.1648210	43.26	-21.96	65.22	43.15	0.10	0.01	QP
4	0.1648210	15.47	-39.75	55.22	15.36	0.10	0.01	Average
5	@0.1891660	45.68	-18.39	64.07	45.57	0.10	0.01	QP
6	@0.1891660	33.77	-20.30	54.07	33.66	0.10	0.01	Average
7	@0.2272570	38.13	-24.42	62.55	38.02	0.10	0.01	QP
8	0.2272570	14.30	-38.25	52.55	14.19	0.10	0.01	Average
9	@0.2498060	37.31	-24.45	61.76	37.20	0.10	0.01	QP
10	@0.2498060	27.45	-24.31	51.76	27.34	0.10	0.01	Average
11	@ 3.010	30.08	-25.92	56.00	29.87	0.16	0.05	QP
12	3.010	7.25	-38.75	46.00	7.04	0.16	0.05	Average

Neutral to Ground

	Freq	Level	Over Limit	Limit Line	Read Level	LISN Factor	Cable Loss	Remark
	MHz	dBuV	dB	dBuV	dBuV	dB	dB	
1	0.1564950	16.62	-39.03	55.65	16.51	0.10	0.01	Average
2	@0.1564950	44.51	-21.14	65.65	44.40	0.10	0.01	QP
3	@0.1894460	46.44	-17.62	64.06	46.33	0.10	0.01	QP
4	@0.1894460	34.21	-19.85	54.06	34.10	0.10	0.01	Average
5	@0.1899130	33.10	-20.94	54.04	32.99	0.10	0.01	Average
6	@0.1899130	46.52	-17.52	64.04	46.41	0.10	0.01	QP
7	@0.2165530	38.98	-23.97	62.95	38.87	0.10	0.01	QP
8	0.2165530	12.20	-40.75	52.95	12.09	0.10	0.01	Average
9	@0.2496500	37.87	-23.90	61.77	37.76	0.10	0.01	QP
10	@0.2496500	27.45	-24.32	51.77	27.34	0.10	0.01	Average
11	@ 2.788	30.39	-25.61	56.00	30.25	0.10	0.04	QP
12	2.788	6.62	-39.38	46.00	6.48	0.10	0.04	Average

5.9.4. Photographs of Radiated Emission Test Configuration

- The photographs show the configuration that generates the maximum emission.

Mode 1

FRONT VIEW



REAR VIEW



SIDE VIEW

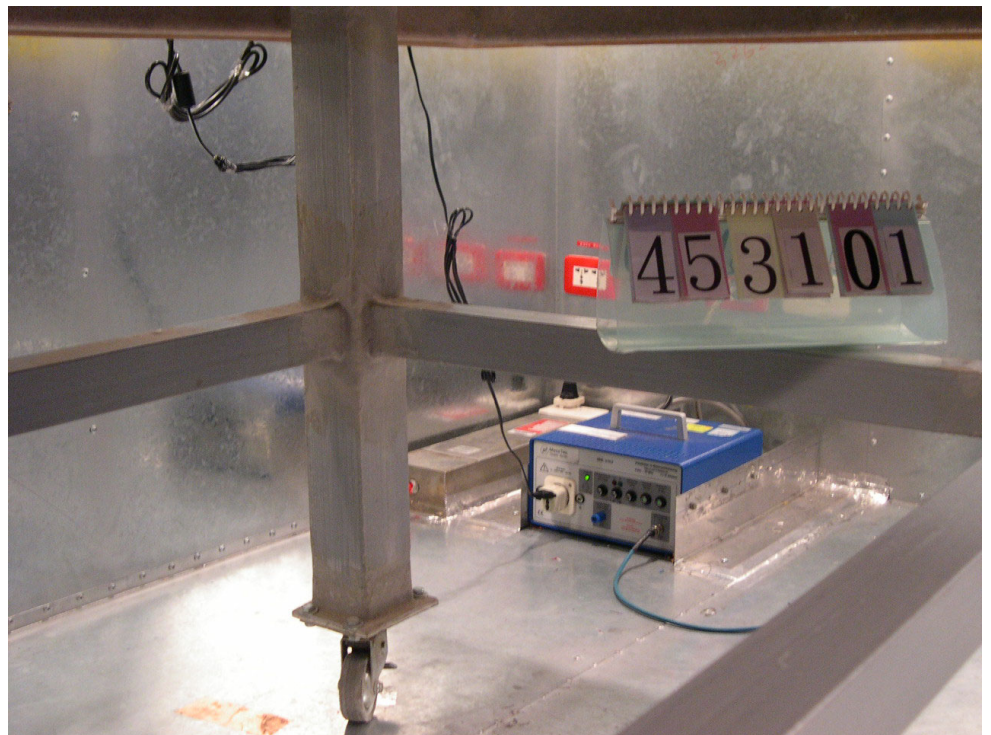



5.10. Antenna Requirements

5.10.1. Standard Applicable

47 CFR Part15 Section 15.203:

An intentional radiator shall be designed to ensure that no antenna other than that furnished by the responsible party shall be used with the device.

47 CFR Part15 Section 15.407 (a):

For 5150MHz~5250MHz : If transmitting antennas of directional gain greater than 6 dBi are used, both the peak transmit power and the peak power spectral density shall be reduced by the amount in dB that the directional gain of the antenna exceeds 6 dBi. Device shall use a transmitting antenna that is an integral part of the device.

For 5250MHz~5350MHz / 5470MHz~5725MHz : If transmitting antennas of directional gain greater than 6 dBi are used, both the peak transmit power and the peak power spectral density shall be reduced by the amount in dB that the directional gain of the antenna exceeds 6 dBi.

For 5725MHz~5825MHz : If transmitting antennas of directional gain greater than 6 dBi are used, both the peak transmit power and the peak power spectral density shall be reduced by the amount in dB that the directional gain of the antenna exceeds 6 dBi. However, fixed point-to-point U-NII devices operating in this band may employ transmitting antennas with directional gain up to 23 dBi without any corresponding reduction in the transmitter peak output power or peak power spectral density. For fixed, point-to-point U-NII transmitters that employ a directional antenna gain greater than 23 dBi, a 1 dB reduction in peak transmitter power and peak power spectral density for each 1 dB of antenna gain in excess of 23 dBi would be required. Fixed, point-to-point operations exclude the use of point-to-multipoint systems, omnidirectional applications, and multiple collocated transmitters transmitting the same information. The operator of the U-NII device, or if the equipment is professionally installed, the installer, is responsible for ensuring that systems employing

high gain directional antennas are used exclusively for fixed, point-to-point operations.

5.10.2. Antenna Connected Construction

The antenna connector is U.FL.



6. List of Measuring Equipments Used

Items	Instrument	Manufacturer	Model No.	Serial No.	Characteristics	Calibration Date	Remark
1	EMC Receiver	R&S	ESCS 30	100174	9 KHz – 2.75 GHz	Feb. 16, 2004	Conduction (CO04-HY)
2	LISN	MessTec	NNB-2/16Z	2001/004	9 KHz – 30 MHz	Jun. 09, 2004	Conduction (CO04-HY)
3	LISN (Support Unit)	MessTec	NNB-2/16Z	99041	9 KHz – 30 MHz	Apr. 27, 2004	Conduction (CO04-HY)
4	EMI Filter	LINDGREN	LRE-2030	2651	< 450 Hz	N/A	Conduction (CO04-HY)
5	RF Cable-CON	UTIFLEX	3102-26886-4	CB044	9KHz~30MHz	Apr. 21, 2004	Conduction (CO04-HY)
6	3m Semi Anechoic Chamber	SIDT FRANKONIA	SAC-3M	03CH03-HY	30MHz~1GHz 3m	Jun. 21, 2004	Radiation (03CH03-HY)
7	Spectrum analyzer	R&S	FSP30	100023	9KHZ~30GHz	Aug. 02, 2004	Radiation (03CH03-HY)
8	Amplifier	HP	8447D	2944A09072	100KHz – 1.3GHz	Nov. 05, 2003	Radiation (03CH03-HY)
9	Biconical Antenna	SCHWARZBECK	VHBB 9124	301	30MHz – 200MHz	Jul. 28, 2004	Radiation (03CH03-HY)
10	Log Antenna	SCHWARZBECK	VUSLP 9111	221	200MHz -1GHz	Jul. 28, 2004	Radiation (03CH03-HY)
11	RF Cable-R03m	Jye Bao	RG142	CB021	30MHz~1GHz	Dec. 03, 2003	Radiation (03CH03-HY)
12	Amplifier	MITEQ	AFS44	849984	100MHz~26.5GHz	Mar. 26, 2004	Radiation (03CH03-HY)
13	Horn Antenna	EMCO	3115	6821	1GHz – 18GHz	Apr. 19, 2004	Radiation (03CH03-HY)
14	Turn Table	HD	DS 420	420/650/00	0 ~ 360 degree	N/A	Radiation (03CH03-HY)
15	Antenna Mast	HD	MA 240	240/560/00	1 m - 4 m	N/A	Radiation (03CH03-HY)
16	Horn Antenna	Schwarzbeck	BBHA9170	154	18GHz~40GHz	Jun. 09, 2004	Radiation (03CH03-HY)
17	RF Cable-HIGH	Jye Bao	RG142	CB030-HIGH	1GHz~29.5GHz	Dec. 05, 2003	Radiation (03CH03-HY)

※ Calibration Interval of instruments listed above is one year.



Items	Instrument	Manufacturer	Model No.	Serial No.	Characteristics	Calibration Date	Remark
18	Spectrum analyzer	R&S	FSP7	838858/014	9KHZ~7GHZ	Sep. 02, 2004	Conducted (TH01-HY)
19	Power meter	R&S	NRVS	100444	DC~40GHz	Jun. 15, 2004	Conducted (TH01-HY)
20	Power sensor	R&S	NRV-Z55	100049	DC~40GHz	Jun. 15, 2004	Conducted (TH01-HY)
21	Power Sensor	R&S	NRV-Z32	100057	30MHz-6GHz	Jun. 15, 2004	Conducted (TH01-HY)
22	AC power source	HPC	HPA-500W	HPA-9100024	AC 0~300V	Jun. 16, 2004	Conducted (TH01-HY)
23	AC power source	G.W.	GPC-6030D	C671845	DC 1V~60V	Nov. 06, 2003	Conducted (TH01-HY)
24	Temp. and Humidity Chamber	KSON	THS-C3L	612	N/A	Oct. 01, 2003	Conducted (TH01-HY)
25	RF CABLE-1m	Jye Bao	RG142	CB034-1m	20MHz~7GHz	Jan. 01, 2004	Conducted (TH01-HY)
26	RF CABLE-2m	Jye Bao	RG142	CB035-2m	20MHz~1GHz	Jan. 01, 2004	Conducted (TH01-HY)

※ Calibration Interval of instruments listed above is one year.