



1190
ILAC MRA

Specific Absorption Rate (SAR) Test Report
for
Symbol Technologies, Inc.
on the
Mobile Computer

Report No. : O453101-3-2-01
Trade Name : SYMBOL
Model Name : MC3090
Type number of RF module : 21-21160
FCC ID : H9P2121160
Date of Testing : Sep. 02, 2004
Date of Report : Sep. 16, 2004
Date of Review : Sep. 16, 2004

- The test results refer exclusively to the presented test model / sample only.
- Without written approval of SPORTON International Inc., the test report shall not be reproduced except in full.

SPORTON International Inc.

6F, No.106, Sec. 1, Hsin Tai Wu Rd., Hsi Chih, Taipei Hsien, Taiwan, R.O.C.



Table of Contents

1. Statement of Compliance	1
2. Administration Data	2
2.1. Testing Laboratory	2
2.2. Detail of Applicant	2
2.3. Detail of Manufacturer	2
2.4. Application Detail	2
3. Scope	3
3.1. Description of Device Under Test (DUT)	3
3.2. Product Photo	4
3.3. Applied Standards:	6
3.4. Device Category and SAR Limits	7
3.5. Test Conditions	7
3.5.1. Ambient Condition:	7
3.5.2. Test Configuration:	7
4. Specific Absorption Rate (SAR)	8
4.1. Introduction	8
4.2. SAR Definition	8
5. SAR Measurement Setup	9
5.1. DASY4 E-Field Probe System	10
5.1.1. EX3DV3 E-Field Probe Specification	11
5.1.2. EX3DV3 E-Field Probe Calibration	11
5.2. DATA Acquisition Electronics (DAE)	12
5.3. Robot	13
5.4. Measurement Server	13
5.5. SAM Twin Phantom	13
5.6. Data Storage and Evaluation	15
5.6.1. Data Storage	15
5.6.2. Data Evaluation	15
5.7. Test Equipment List	18
6. Tissue Simulating Liquids	19
7. Uncertainty Assessment	20
8. SAR Measurement Evaluation	22
8.1. Purpose of System Performance check	22
8.2. System Setup	22
8.3. Validation Results	23
9. Description for DUT Testing Position	24
10. Measurement Procedures	26
10.1. Spatial Peak SAR Evaluation	26
10.2. Scan Procedures	27
10.3. SAR Averaged Methods	27
11. SAR Test Results	28
11.1. Component Combination	28
11.2. Face Touched Keypad Up and Keypad Down	28



11.3. EUT in Holster with Keypad Up and Keypad Down28
11.4. Threrhold SAR Value.....28
12. References29

- Appendix A – System Performance Check Data
- Appendix B – SAR Measurement Data
- Appendix C – Calibration Data

FCC SAR Test Report

Test Report No : 0453101-3-2-01

1. Statement of Compliance

The Specific Absorption Rate (SAR) maximum result found during testing for the **Symbol Technologies, Inc. Mobile Computer MC3090** is less than the system threshold **0.00431 W/Kg** on the **WLAN band body SAR** with expanded uncertainty 20.6%. It is in compliance with Specific Absorption Rate (SAR) for general population/uncontrolled exposure limits specified in FCC 47 CFR part 2 (2.1093) and ANSI/IEEE C95.1-1999 and had been tested in accordance with the measurement methods and procedures specified in OET Bulletin 65 Supplement C (Edition 01-01).

Tested by

Approved by

Nilson She

Nilson She
Test Engineer

Daniel Lee 10/4/2004

Dr. C.H. Daniel Lee
SAR Lab. Manager



2. Administration Data

2.1. Testing Laboratory

Company Name : Sporton International Inc.
Department : Antenna Design/SAR
Address : No.52, Hwa-Ya 1st RD., Hwa Ya Technology Park, Kwei-Shan Hsiang, TaoYuan Hsien, Taiwan, R.O.C.
Telephone Number : 886-3-327-3456
Fax Number : 886-3-327-0973

2.2. Detail of Applicant

Company Name : Symbol Technologies, Inc.
Address : One Symbol Plaza Holtsville, New York, 11742-1300 U.S.A.

2.3. Detail of Manufacturer

Company Name : Universal Scientific Industrial Co., Ltd.
Address : 141, Lane 351, Taiping Road, Sec. 1, Tsao Tuen, Nan-Tou, Taiwan
Telephone Number : 886-49-2261876
Fax Number : 886-49-2254838
Contact Person : te1126@ms.usi.com.tw

2.4. Application Detail

Date of reception of application: Aug. 23, 2004
Start of test : Sep. 02, 2004
End of test : Sep. 02, 2004



3. Scope

3.1. Description of Device Under Test (DUT)

DUT Type :	Mobile Computer
Trade Name :	SYMBOL
Model Name :	MC3090
FCC ID :	H9P2121160
Type of Modulation :	802.11a: OFDM
Frequency Band :	5150~5350 MHz
Antenna Connector :	Hirose (U.FL-R-SMT)
Antenna Type :	PIFA
Antenna Gain :	3.1 dBi
Maximum Output Power to Antenna :	802.11a: 18.94 dBm
Power Rating (DC/AC Voltage) :	AC Input 100-240V, 50-60Hz, 0.4A DC Output 5.4V, 3A
DUT Stage :	Production Unit
Application Type :	Certification



3.2. Product Photo



Top View of DUT for 28 Key



Top View of DUT for 38 Key



Top View of DUT for 48 Key

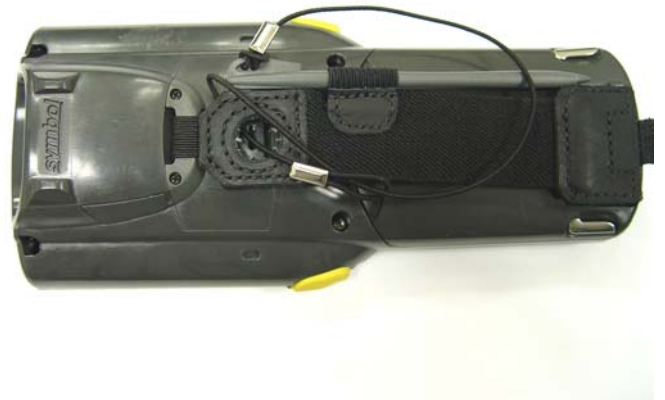

Bottom View of DUT



Top View of 1 x Battery



Bottom View of 1 x Battery



Top View of 2 x Battery



Bottom View of 2 x Battery



3.3. Applied Standards:

The Specific Absorption Rate (SAR) testing specification, method and procedure for this Mobile Computer is in accordance with the following standards:

47 CFR Part 2 (2.1093),
IEEE C95.1-1999,
IEEE C95.3-2002,
IEEE P1528 -2003, and
OET Bulletin 65 Supplement C (Edition 01-01)



3.4. Device Category and SAR Limits

This device belongs to portable device category because its radiating structure is allowed to be used within 20 centimeters of the body of the user. Limit for General Population/Uncontrolled exposure should be applied for this device, it is 1.6 W/kg as averaged over any 1 gram of tissue.

3.5. Test Conditons

3.5.1. Ambient Condition:

Item	802.11a
Ambient Temperature (°C)	20 ~ 24°C
Tissue simulating liquid temperature (°C)	22.2°C
Humidity (%)	< 60%

3.5.2. Test Configuration:

Engineering testing software installed on EUT can provide continuous transmitting RF signal. This RF signal utilized in SAR measurement is continuous wave (CW) and its crest factor is 1.

This EUT has lots of optional components as the following table.

Display	1) Color W/Touch Panel 2) Mono W/Touch Panel 3) Color W/O Touch Panel 4) Mono W/O Touch Panel
Keypad	1) 28 2) 38 3) 48
Scanner	1) SE800hP 2) PICO Imager
Battery	1) 1X (SAMSUNG) 3.7V 2600mAh 2) 2X (SANYO) 3.7V 4400mAh

The EUT was fixed at “Keypad Up” and “Keypad Down” testing position and was fixed at 802.11b channel 6 to search for the worst case component combinations. The tested combinations are (1) Mono/48/PICO/2X (2) Color/48/PICO/2X (3) Mono/28/PICO/2X (4) Mono/38/PICO/2X (5) Mono/38/SE800hp/2X and (6) Mono/38/SE800hp/1X.

Refer to test report No: O453103-2-2-01, the worst combination is combination (5) with keypad up. The worst combination was performed on the lowest, middle and highest channel of 802.11a, i.e. channel 36, channel 48 channel 52 and channel 64.



4. Specific Absorption Rate (SAR)

4.1. Introduction

SAR is related to the rate at which energy is absorbed per unit mass in an object exposed to a radio field. The SAR distribution in a biological body is complicated and is usually carried out by experimental techniques or numerical modeling. The FCC recommends limits for two tiers of groups, occupational/controlled and general population/uncontrolled, based on a person’s awareness and ability to exercise control over his or her exposure. In general, occupational/controlled exposure limits are higher than the limits for general population/uncontrolled.

4.2. SAR Definition

The SAR definition is the time derivative (rate) of the incremental energy (dW) absorbed by (dissipated in) an incremental mass (dm) contained in a volume element (dv) of a given density. ρ). The equation description is as below:

$$\mathbf{SAR} = \frac{d}{dt} \left(\frac{dW}{dm} \right) = \frac{d}{dt} \left(\frac{dW}{\rho dv} \right)$$

SAR is expressed in units of Watts per kilogram (W/kg)

SAR measurement can be either related to the temperature elevation in tissue by

$$\mathbf{SAR} = C \frac{\delta T}{\delta t}$$

, where C is the specific head capacity, δT is the temperature rise and δt the exposure duration,

or related to the electrical field in the tissue by

$$\mathbf{SAR} = \frac{\sigma |E|^2}{\rho}$$

, where σ is the conductivity of the tissue, ρ is the mass density of the tissue and E is the rms electrical field strength.

However for evaluating SAR of low power transmitter, electrical field measurement is typically applied.

5. SAR Measurement Setup

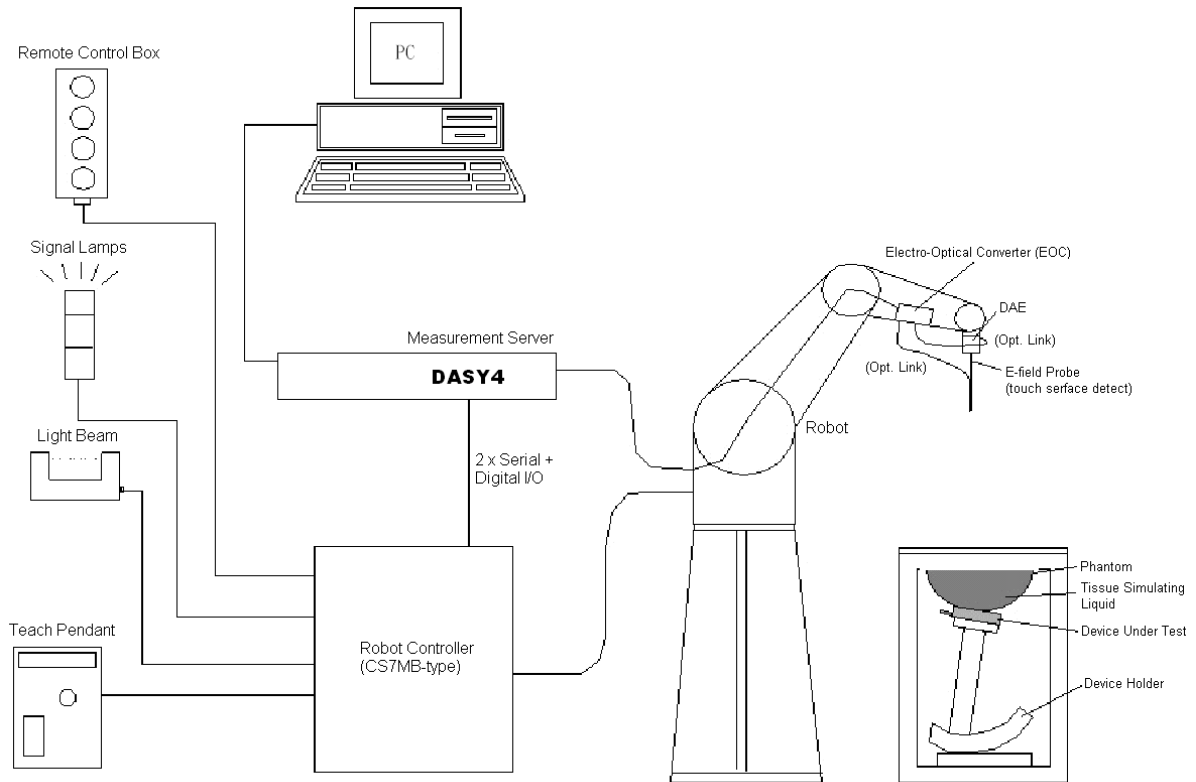

Fig. 5.1 DASY4 system



The DASY4 system for performance compliance tests is illustrated above graphically. This system consists of the following items:

- A standard high precision 6-axis robot with controller, a teach pendant and software
- A data acquisition electronic (DAE) attached to the robot arm extension
- A dosimetric probe equipped with an optical surface detector system
- The electro-optical converter (ECO) performs the conversion between optical and electrical signals
- A measurement server performs the time critical tasks such as signal filtering, control of the robot operation and fast movement interrupts.
- A probe alignment unit which improves the accuracy of the probe positioning
- A computer operating Windows XP
- DASY4 software
- Remove control with teach pendant and additional circuitry for robot safety such as warning lamps, etc.
- The SAM twin phantom
- A device holder
- Tissue simulating liquid
- Dipole for evaluating the proper functioning of the system

Some of the components are described in details in the following sub-sections.

5.1. DASY4 E-Field Probe System

The SAR measurement is conducted with the dosimetric probe EX3DV3 (manufactured by SPEAG). The probe is specially designed and calibrated for use in liquid with high permittivity. The dosimetric probe has special calibration in liquid at different frequency.



5.1.1. EX3DV3 E-Field Probe Specification

Construction	Symmetrical design with triangular core Built-in shielding against static charges PEEK enclosure material (resistant to organic solvents)
Calibration	Basic Broad Band Calibration in air: 10-3000 MHz Conversion Factors (CF) for HSL 900 and HSL 1800 Additional CF for other liquids and frequencies upon request
Frequency	10 MHz to > 6 GHz; Linearity: ± 0.2 dB (30 MHz to 3 GHz)
Directivity	± 0.3 dB in HSL (rotation around probe axis) ± 0.5 dB in tissue material (rotation normal to probe axis)
Dynamic Range	10 μ W/g to > 100 mW/g; Linearity: ± 0.2 dB (noise: typically < 1 μ W/g)
Dimensions	Overall length: 330 mm (Tip: 20 mm) Tip diameter: 2.5 mm (Body: 12 mm) Typical distance from probe tip to dipole centers: 1 mm
Application	High precision dosimetric measurements in any exposure scenario (e.g., very strong gradient fields). Only probe which enables compliance testing for frequencies up to 6 GHz with precision of better 30%.



Fig. 5.2 EX3DV3 E-field Probe

5.1.2. EX3DV3 E-Field Probe Calibration

Each probe needs to be calibrated according to a dosimetric assessment procedure with accuracy better than $\pm 10\%$. The spherical isotropy shall be evaluated and within ± 0.25 dB. The sensitivity parameters (NormX, NormY, and NormZ), the diode compression parameter (DCP) and the conversion factor (ConvF) of the probe are tested. The calibration data are as below:



Sensitivity	X axis : 0.66 μ V	Y axis : 0.67 μ V	Z axis : 0.60 μ V	
Diode compression point	X axis : 97 mV	Y axis : 97 mV	Z axis : 97 mV	
Conversion factor (Head/Body)	Frequency (MHz)	X axis	Y axis	Z axis
	4940~5460	4.88/4.14	4.88/4.14	4.88/4.14
Boundary effect (Head/Body)	Frequency (MHz)	Alpha	Depth	
	4940~5460	0.42/0.45	1.8/1.9	

NOTE:

1. The probe parameters have been calibrated by the SPEAG.
2. For the detailed calibration data is shown in Appendix C.

5.2. DATA Acquisition Electronics (DAE)

The data acquisition electronics (DAE4) consists of a highly sensitive electrometer-grade preamplifier with auto-zeroing, a channel and gain-switching multiplexer, a fast 16 bit AD-converter and a command decoder and control logic unit. Transmission to the measurement server is accomplished through an optical downlink for data and status information as well as an optical uplink for commands and the clock.

The mechanical probe mounting device includes two different sensor systems for frontal and sideways probe contacts. They are used for mechanical surface detection and probe collision detection.

The input impedance of the DAE4 is 200M Ohm; the inputs are symmetrical and floating. Common mode rejection is above 80dB.

Calibration data is attached in Appendix C.



5.3. Robot

The DASY4 system uses the high precision robots RX90BL type out of the newer series from Stäubli SA (France). For the 6-axis controller DASYS system, the CS7MB robot controller version from Stäubli is used. The RX robot series have many features that are important for our application:

- High precision (repeatability 0.02 mm)
- High reliability (industrial design)
- Jerk-free straight movements
- Low ELF interference (the closed metallic construction shields against motor control fields)
- 6-axis controller

5.4. Measurement Server

The DASY4 measurement server is based on a PC/104 CPU board with
166 MHz CPU
32 MB chipset and
64 MB RAM.

Communication with
the DAE4 electronic box
the 16-bit AD-converter system for optical detection and digital I/O interface.

The measurement server performs all the real-time data evaluation for field measurements and surface detection, controls robot movements and handles safety operations.

5.5. SAM Twin Phantom

The SAM twin phantom is a fiberglass shell phantom with 2mm shell thickness (except the ear region where shell thickness increases to 6mm). It has three measurement areas:

- Left head
- Right head
- Flat phantom

The bottom plate contains three pair of bolts for locking the device holder. The device holder positions are adjusted to the standard measurement positions in the three sections.

A white cover is provided to tap the phantom during off-periods to prevent water evaporation and changes in the liquid parameters.

On the phantom top, three reference markers are provided to identify the phantom position with respect to the robot.

The phantom can be used with the following tissue simulating liquids:

- *Water-sugar based liquid
- *Glycol based liquids

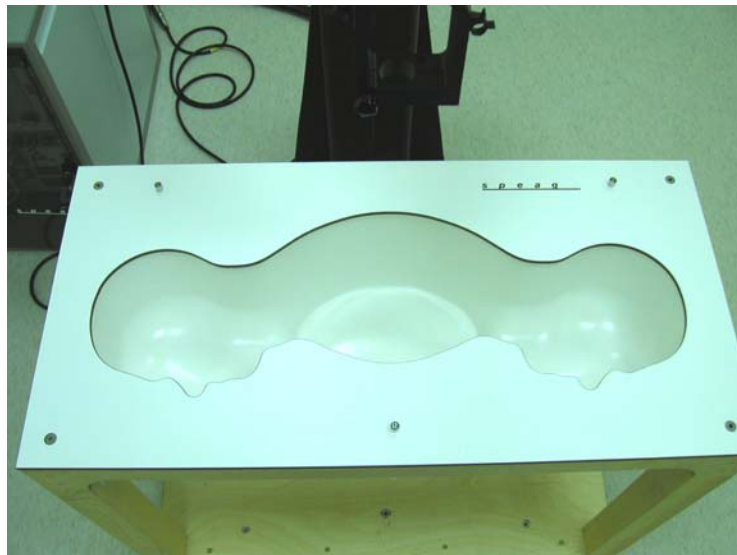

Fig. 5.3 Top view of twin phantom



Fig. 5.4 Bottom view of twin phantom



5.6. Data Storage and Evaluation

5.6.1. Data Storage

The DASY4 software stores the assessed data from the data acquisition electronics as raw data (in microvolt readings from the probe sensors), together with all the necessary software parameters for the data evaluation (probe calibration data, liquid parameters and device frequency and modulation data) in measurement files with the extension .DA4. The postprocessing software evaluates the desired unit and format for output each time the data is visualized or exported. This allows verification of the complete software setup even after the measurement and allows correction of erroneous parameter settings. For example, if a measurement has been performed with an incorrect crest factor parameter in the device setup, the parameter can be corrected afterwards and the data can be reevaluated.

The measured data can be visualized or exported in different units or formats, depending on the selected probe type (e.g., [V/m], [A/m], [mW/g]). Some of these units are not available in certain situations or give meaningless results, e.g., a SAR-output in a loseless media, will always be zero. Raw data can also be exported to perform the evaluation with other software packages.

5.6.2. Data Evaluation

The DASY4 postprocessing software (SEMCAD) automatically executes the following procedures to calculate the field units from the microvolt readings at the probe connector. The parameters used in the evaluation are stored in the configuration modules of the software :

Probe parameters :	- Sensitivity	Norm _i , a _{i0} , a _{i1} , a _{i2}
	- Conversion factor	ConvF _i
	- Diode compression point	dcp _i
Device parameters :	- Frequency	f
	- Crest factor	cf
Media parameters :	- Conductivity	σ
	- Density	ρ

These parameters must be set correctly in the software. They can be found in the component documents or they can be imported into the software from the configuration files issued for the DASY components. In the direct measuring mode of the multimeter option, the parameters of the actual system setup are used. In the scan visualization and export modes, the parameters stored in the corresponding document files are used.

The first step of the evaluation is a linearization of the filtered input signal to account for the compression characteristics of the detector diode. The compensation depends on the input signal, the diode type and the DC-transmission factor from the diode to the evaluation electronics. If the exciting field is pulsed, the crest factor of the signal must be known to correctly compensate for peak power. The formula for each channel



can be given as :

$$V_i = U_i + U_i^2 \cdot \frac{cf}{dcp_i}$$

with V_i = compensated signal of channel i ($i = x, y, z$)
 U_i = input signal of channel i ($i = x, y, z$)
 cf = crest factor of exciting field (DASY parameter)
 dcp_i = diode compression point (DASY parameter)

From the compensated input signals, the primary field data for each channel can be evaluated :

$$\text{E-field probes : } E_i = \sqrt{\frac{V_i}{Norm_i ConvF}}$$

$$\text{H-field probes : } H_i = \sqrt{V_i \frac{a_{i0} + a_{i1}f + a_{i2}f^2}{f}}$$

with V_i = compensated signal of channel i ($i = x, y, z$)
 $Norm_i$ = sensor sensitivity of channel i ($i = x, y, z$)
 $\mu V/(V/m)^2$ for E-field Probes
 $ConvF$ = sensitivity enhancement in solution
 a_{ij} = sensor sensitivity factors for H-field probes
 f = carrier frequency [GHz]
 E_i = electric field strength of channel i in V/m
 H_i = magnetic field strength of channel i in A/m

The RSS value of the field components gives the total field strength (Hermitian magnitude) :

$$E_{tot} = \sqrt{E_x^2 + E_y^2 + E_z^2}$$

The primary field data are used to calculate the derived field units.

$$SAR = E_{tot}^2 \cdot \frac{\sigma}{\rho \cdot 1000}$$

with SAR = local specific absorption rate in mW/g
 E_{tot} = total field strength in V/m
 σ = conductivity in [mho/m] or [Siemens/m]
 ρ = equivalent tissue density in g/ cm³



* Note that the density is set to 1, to account for actual head tissue density rather than the density of the tissue simulating liquid.

The power flow density is calculated assuming the excitation field to be a free space field.

$$P_{pwe} = \frac{E_{tot}^2}{3770} \quad \text{or} \quad P_{pwe} = H_{tot}^2 \cdot 37.7$$

with P_{pwe} = equivalent power density of a plane wave in mW/cm²
 E_{tot} = total electric field strength in V/m
 H_{tot} = total magnetic field strength in A/m



5.7. Test Equipment List

Manufacture	Name of Equipment	Type/Model	Serial Number	Calibration	
				Last Cal.	Due Date
SPEAG	Dosimetric E-Filed Probe	EX3DV3	3514	Jan. 23, 2004	Jan. 23, 2005
SPEAG	835MHz System Validation Kit	D835V2	499	Feb. 12, 2004	Feb. 12, 2006
SPEAG	900MHz System Validation Kit	D900V2	190	July 17, 2003	July 17, 2005
SPEAG	1800MHz System Validation Kit	D1800V2	2d076	July 16, 2003	July 16, 2005
SPEAG	1900MHz System Validation Kit	D1900V2	5d041	Feb. 17, 2004	Feb. 17, 2006
SPEAG	2450MHz System Validation Kit	D2450V2	736	Aug. 26, 2003	Aug. 26, 2005
SPEAG	5200MHz System Validation Kit	D5GHzV2	1006	Jan. 22, 2004	Jan. 22, 2005
SPEAG	Data Acquisition Electronics	DAE3	577	Nov. 21, 2003	Nov. 21, 2004
SPEAG	Device Holder	N/A	N/A	NCR	NCR
SPEAG	Phantom	QD 000 P40 C	TP-1150	NCR	NCR
SPEAG	Robot	Staubli RX90BL	F03/5W15A1/A/01	NCR	NCR
SPEAG	Software	DASY4 V4.3Build 16	N/A	NCR	NCR
SPEAG	Software	SEMCAD V1.8 Build 123	N/A	NCR	NCR
SPEAG	Measurement Server	SE UMS 001 BA	1021	NCR	NCR
Agilent	S-Parameter Network Analyzer (PNA)	E8358A	US40260131	Oct. 17, 2003	Oct. 17, 2004
Agilent	Dielectric Probe Kit	85070D	US01440205	NCR	NCR
Agilent	Dual Directional Coupler	778D	50422	NCR	NCR
Agilent	Power Amplifier	8449B	3008A01917	NCR	NCR
R & S	Radio Communication Tester	CMU200	103937	Oct. 20, 2003	Oct. 20, 2004
Agilent	Power Meter	E4416A	GB41292344	Feb. 12, 2004	Feb. 12, 2005
Agilent	Signal Generator	E8247C	MY43320596	Feb. 10, 2004	Feb. 10, 2005
Agilent	Base Station Emulator	E5515C	GB43460754	Jan. 12, 2004	Jan. 12, 2005

Table 5.1 Test Equipment List



6. Tissue Simulating Liquids

For the measurement of the field distribution inside the SAM phantom with DASY4, the phantom must be filled with around 25 liters of homogeneous body tissue simulating liquid. The liquid height from the bottom of the phantom body is 15.2 centimeters.

The dielectric parameters of the liquids were verified prior to the SAR evaluation using an Agilent 85070D Dielectric Probe Kit and an Agilent E8358A Network Analyzer.

Table 6.2 shows the measuring results for muscle simulating liquid.

Bands	Frequency(MHz)	Permittivity (ϵ_r)	Conductivity (σ)	Measurement date
5150-5350 MHz	5180	47.6	5.28	Sep. 02, 2004
	5240	47.1	5.36	
	5260	47.4	5.38	
	5320	47.3	5.47	

Table 6.2

The measuring data are consistent with $\epsilon_r = 49.0 \pm 5\%$ and $\sigma = 5.30 \pm 5\%$.



7. Uncertainty Assessment

The component of uncertainty may generally be categorized according to the methods used to evaluate them. The evaluation of uncertainty by the statistical analysis of a series of observations is termed a Type A evaluation of uncertainty. The evaluation of uncertainty by means other than the statistical analysis of a series of observation is termed a Type B evaluation of uncertainty. Each component of uncertainty, however evaluated, is represented by an estimated standard deviation, termed standard uncertainty, which is determined by the positive square root of the estimated variance.

A Type A evaluation of standard uncertainty may be based on any valid statistical method for treating data. This includes calculating the standard deviation of the mean of a series of independent observations; using the method of least squares to fit a curve to the data in order to estimate the parameter of the curve and their standard deviations; or carrying out an analysis of variance in order to identify and quantify random effects in certain kinds of measurement.

A type B evaluation of standard uncertainty is typically based on scientific judgment using all of the relevant information available. These may include previous measurement data, experience and knowledge of the behavior and properties of relevant materials and instruments, manufacture’s specification, data provided in calibration reports and uncertainties assigned to reference data taken from handbooks. Broadly speaking, the uncertainty is either obtained from an outdoor source or obtained from an assumed distribution, such as the normal distribution, rectangular or triangular distributions indicated in Table 7.1

Uncertainty Distributions	Normal	Rectangular	Triangular	U-shape
Multiplying factor ^(a)	1/k ^(b)	1/√3	1/√6	1/√2

(a) standard uncertainty is determined as the product of the multiplying factor and the estimated range of variations in the measured quantity
(b) k is the coverage factor

Table 7.1

The combined standard uncertainty of the measurement result represents the estimated standard deviation of the result. It is obtained by combining the individual standard uncertainties of both Type A and Type B evaluation using the usual “root-sum-squares” (RSS) methods of combining standard deviations by taking the positive square root of the estimated variances.

Expanded uncertainty is a measure of uncertainty that defines an interval about the measurement result within which the measured value is confidently believed to lie. It is obtained by multiplying the combined standard uncertainty by a coverage factor. Typically, the coverage factor ranges from 2 to 3. Using a coverage factor allows the true value of a measured quantity to be specified with a defined probability within the specified uncertainty range. For purpose of this document, a coverage factor two is used, which corresponds to confidence interval of about 95 %. The DASY4 uncertainty Budget is showed in Table 7.2.



Error Description	Uncertainty Value \pm %	Probability Distribution	Divisor	C_i $1g$	Standard Unc. (1-g)	v_i or V_{eff}
Measurement System						
Probe Calibration	± 4.8	Normal	1	1	± 4.8	∞
Axial Isotropy	± 4.7	Rectangular	$\sqrt{3}$	0.7	± 1.9	∞
Hemispherical Isotropy	± 9.6	Rectangular	$\sqrt{3}$	0.7	± 3.9	∞
Boundary Effect	± 1.0	Rectangular	$\sqrt{3}$	1	± 0.6	∞
Linearity	± 4.7	Rectangular	$\sqrt{3}$	1	± 2.7	∞
System Detection Limit	± 1.0	Rectangular	$\sqrt{3}$	1	± 0.6	∞
Readout Electronics	± 1.0	Normal	1	1	± 1.0	∞
Response Time	± 0.8	Rectangular	$\sqrt{3}$	1	± 0.5	∞
Integration time	± 2.6	Rectangular	$\sqrt{3}$	1	± 1.5	∞
RF Ambient Conditions	± 3.0	Rectangular	$\sqrt{3}$	1	± 1.7	∞
Probe Positioner Mech. Tolerance	± 0.4	Rectangular	$\sqrt{3}$	1	± 0.2	∞
Probe Positioning with respect to Phantom Shell	± 2.9	Rectangular	$\sqrt{3}$	1	± 1.7	∞
Extrapolation and Interpolation Algorithms for Max. SAR Evaluation	± 1.0	Rectangular	$\sqrt{3}$	1	± 0.6	∞
Test sample Related						
Test sample Positioning	± 2.9	Normal	1	1	± 2.9	145
Device Holder Uncertainty	± 3.6	Normal	1	1	± 3.6	5
Output Power Variation-SAR drift measurement	± 5.0	Rectangular	$\sqrt{3}$	1	± 2.9	∞
Phantom and Setup						
Phantom uncertainty(Including shape and thickness tolerances)	± 4.0	Rectangular	$\sqrt{3}$	1	± 2.3	∞
Liquid Conductivity Target tolerance	± 5.0	Rectangular	$\sqrt{3}$	0.64	± 1.8	∞
Liquid Conductivity measurement uncertainty	± 2.5	Normal	1	0.64	± 1.6	∞
Liquid Permittivity Target tolerance	± 5.0	Rectangular	$\sqrt{3}$	0.6	± 1.7	∞
Liquid Permittivity measurement uncertainty	± 2.5	Normal	1	0.6	± 1.5	∞
Combined standard uncertainty					± 10.3	330
Coverage Factor for 95 %		<u>K=2</u>				
Expanded uncertainty (Coverage factor = 2)			Normal (k=2) 27		± 20.6	

Table 7.2. Uncertainty Budget of DASY

8. SAR Measurement Evaluation

Each DASY system is equipped with one or more system validation kits. These units, together with the predefined measurement procedures within the DASY software, enable the user to conduct the system performance check and system validation. System validation kit includes a dipole, tripod holder to fix it underneath the flat phantom and a corresponding distance holder.

8.1. Purpose of System Performance check

The system performance check verifies that the system operates within its specifications. System and operator errors can be detected and corrected. It is recommended that the system performance check be performed prior to any usage of the system in order to guarantee reproducible results. The system performance check uses normal SAR measurements in a simplified setup with a well characterized source. This setup was selected to give a high sensitivity to all parameters that might fail or vary over time. The system check does not intend to replace the calibration of the components, but indicates situations where the system uncertainty is exceeded due to drift or failure.

8.2. System Setup

In the simplified setup for system evaluation, the DUT is replaced by a calibrated dipole and the power source is replaced by a continuous wave which comes from a signal generator at frequency 5200 MHz. The calibrated dipole must be placed beneath the flat phantom section of the SAM twin phantom with the correct distance holder. The distance holder should touch the phantom surface with a light pressure at the reference marking and be oriented parallel to the long side of the phantom. The equipment setup is shown below:

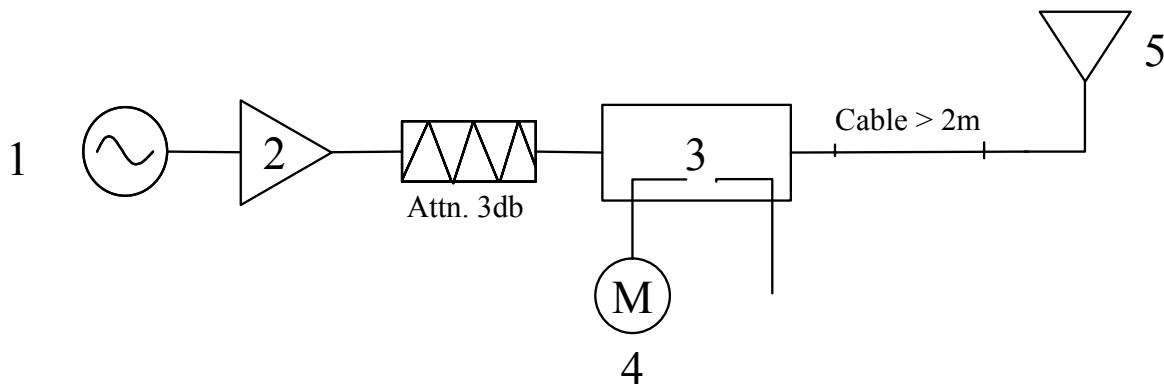

Fig. 8.1



1. Signal Generator
2. Amplifier
3. Directional Coupler
4. Power Meter
5. 5200 MHz Dipole

The output power on dipole port must be calibrated to 100 mW (20 dBm) before dipole is connected.

8.3. Validation Results

Comparing to the original SAR value provided by Speag, the validation data should within its specification of 10 %. Table 8.1 shows the target SAR and measured SAR after normalized to 1W input power.

Band		Target (W/kg)	Measurement data (W/kg)	Variation	Measurement date
ISM band (5200 MHz)	SAR (1g)	78	78.5	0.6 %	Sep. 02, 2004
	SAR (10g)	22	22	0 %	

Table 8.1

The table above indicates the system performance check can meet the variation criterion.

9. Description for DUT Testing Position

This DUT was tested in 2 different positions. This first one is “Face Touched with Keypad Up” and the second one is “Face Touched with Keypad Down”. In addition, EUT in holster for keypad up and down also were tested. The distance between EUT or holster and the phantom is 0 cm for all testing positions.



Fig. 9.1 Face Touched with Keypad Up



Fig. 9.2 Face Touched with Keypad Down



Fig. 9.3 EUT in Holster with Keypad Up



Fig. 9.4 EUT in Holster with Keypad Down



10. Measurement Procedures

The measurement procedures are as follows:

- Plugging DUT into the notebook
- Using engineering software to transmit RF power continuously (continuous Tx) in the low channel
- Placing the DUT in the positions described in the last section
- Setting scan area, grid size and other setting on the DASY4 software
- Taking data for the low channel
- Repeat the previous steps for the middle and high channels.

According to the IEEE P1528 draft standard, the recommended procedure for assessing the peak spatial-average SAR value consists of the following steps:

- Power reference measurement
- Area scan
- Zoom scan
- Power reference measurement

10.1. Spatial Peak SAR Evaluation

The procedure for spatial peak SAR evaluation has been implemented according to the IEEE1528-2003 standard. It can be conducted for 1g and 10g, as well as for user-specific masses. The DASY4 software includes all numerical procedures necessary to evaluate the spatial peak SAR value.

Base on the Draft: SCC-34, SC-2, WG-2-Computational Dosimetry, P1528/D1.2 (Recommended Practice for Determining the Peak Spatial-Average Specific Absorption Rate (SAR) in the Human Head from Wireless Communications Devices: Measurement Techniques), a new algorithm has been implemented. The spatial-peak SAR can be computed over any required mass.

The base for the evaluation is a "cube" measurement. The measured volume must include the 1g and 10g cubes with the highest averaged SAR values. For that purpose, the center of the measured volume is aligned to the interpolated peak SAR value of a previously performed area scan.



The entire evaluation of the spatial peak values is performed within the postprocessing engine (SEMCAD). The system always gives the maximum values for the 1g and 10g cubes. The algorithm to find the cube with highest averaged SAR is divided into the following stages:

- extraction of the measured data (grid and values) from the Zoom Scan
- calculation of the SAR value at every measurement point based on all stored data (A/D values and measurement parameters)
- generation of a high-resolution mesh within the measured volume
- interpolation of all measured values from the measurement grid to the high-resolution grid
- extrapolation of the entire 3-D field distribution to the phantom surface over the distance from sensor to surface
- calculation of the averaged SAR within masses of 1g and 10g

10.2. Scan Procedures

First **Area Scan** is used to locate the approximate location(s) of the local peak SAR value(s). The measurement grid within an **Area Scan** is defined by the grid extent, grid step size and grid offset. Next, in order to determine the EM field distribution in a three-dimensional spatial extension, **Zoom Scan** is required. The **Zoom Scan** measures 8x8x8 points with step size 4.3, 4.3 and 3 mm. The **Zoom Scan** is performed around the highest E-field value to determine the averaged SAR-distribution over 1 g.

10.3. SAR Averaged Methods

In DASY4, the interpolation and extrapolation are both based on the modified Quadratic Shepard's method. The interpolation scheme combines a least-square fitted function method and a weighted average method which are the two basic types of computational interpolation and approximation.

Extrapolation routines are used to obtain SAR values between the lowest measurement points and the inner phantom surface. The extrapolation distance is determined by the surface detection distance and the probe sensor offset. The uncertainty increases with the extrapolation distance. To keep the uncertainty within 1% for the 1 g and 10 g cubes, the extrapolation distance should not be larger than 5 mm.



11. SAR Test Results

11.1. Component Combination

- The EUT was fixed at “Keypad Up” and “Keypad Down” testing position and was fixed at 802.11b channel 6 to search for the worst case component combinations. The tested combinations are (1) Mono/48/PICO/2X (2) Color/48/PICO/2X (3) Mono/28/PICO/2X (4) Mono/38/PICO/2X (5) Mono/38/SE800hp/2X and (6) Mono/38/SE800hp/1X. Refer to test report No: O453103-2-2-01, the worst combination is combination (5) with keypad up. This combination is used for the following tests.

11.2. Face Touched Keypad Up and Keypad Down

- The output power for channel 36, 48, 52, and 64 are 16.82 dBm, 16.58 dBm, 18.94 dBm and 18.49 dBm, respectively. The SAR value is too low to be measured for these testing modes. The reasons are (1) the distance between the EUT transmitting antenna and the phantom is large (about 2cm) and (2) the 5GHz EM wave decays very quickly, especially in 5GHz simulating tissue because we found SAR value can be measured for area scan we (X-Y plane), but not for zoom scan(z-axis).

11.3. EUT in Holster with Keypad Up and Keypad Down

- The output power for channel 36, 48, 52, and 64 are 16.82 dBm, 16.58 dBm, 18.94 dBm and 18.49 dBm, respectively. The SAR value is too low to be measured for these testing modes. The reasons are (1) the distance between the EUT transmitting antenna and the phantom is large (about 2cm) and (2) the 5GHz EM wave decays very quickly, especially in 5GHz simulating tissue because we found SAR value can be measured for area scan we (X-Y plane), but not for zoom scan(z-axis).

11.4. Threrhold SAR Value

- The system threshold for 5GHz SAR is below 0.00431 W/Kg. The threshold plotting is attached in Appendix B, which was taken by EUT side-touched position.



12. References

- [1] FCC 47 CFR Part 2 “Frequency Allocations and Radio Treaty Matters; General Rules and Regulations”
- [2] IEEE Std. P1528-2003, “Recommended Practice for Determining the Peak Spatial-Average Specific Absorption Rate (SAR) in the Human Head from Wireless Communications Devices: Measurement Techniques”, April 21,2003.
- [3] Supplement C (Edition 01-01) to OET Bulletin 65 (Edition 97-01), “Additional Information for Evaluating Compliance of Mobile and Portable Devices with FCC Limits for Human Exposure to RF Emissions”, June 2001
- [4] IEEE Std. C95.3-2002, “IEEE Recommended Practice for the Measurement of Potentially Hazardous Electromagnetic Fields-RF and Microwave”, 2002
- [5] IEEE Std. C95.1-1999, “IEEE Standard for Safety Levels with Respect to Human Exposure to Radio Frequency Electromagnetic Fields, 3 kHz to 300 GHz”, 1999
- [6] Robert J. Renka, “Multivariate Interpolation Of Large Sets Of Scattered Data”, University of North Texas ACM Transactions on Mathematical Software, vol. 14, no. 2, June 1988, pp. 139-148
- [7] DAYS4 System Handbook



Appendix A - System Performance Check Data

Test Laboratory: Sporton International Inc. SAR Testing Lab

Date/Time: 09/02/04 08:40:54

System Check_Body_5200MHz_20040902

DUT: Dipole 5GHz; Type: D5GHzV2; Serial: D5GHzV2 - SN:1006

Communication System: CW; Frequency: 5200 MHz;Duty Cycle: 1:1

Medium: MSL_5GHz Medium parameters used: f = 5200 MHz; $\sigma = 5.3$ mho/m; $\epsilon_r = 47.5$; $\rho = 1000$ kg/m³

Ambient Temperature : 22.9 °C ; Liquid Temperature : 23.1 °C

DASY4 Configuration:

- Probe: EX3DV3 - SN3514; ConvF(4.14, 4.14, 4.14); Calibrated: 2004/1/23
- Sensor-Surface: 2mm (Mechanical Surface Detection)
- Electronics: DAE3 Sn577; Calibrated: 2003/11/21
- Phantom: SAM 12; Type: QD 000 P40 C; Serial: TP-1150
- Measurement SW: DASY4, V4.3 Build 16; Postprocessing SW: SEMCAD, V1.8 Build 123

Pin=100mW/Area Scan (91x91x1): Measurement grid: dx=10mm, dy=10mm

Maximum value of SAR (interpolated) = 16 mW/g

Pin=100mW/Zoom Scan (8x8x8)/Cube 0: Measurement grid: dx=4.3mm, dy=4.3mm, dz=3mm

Reference Value = 42.9 V/m; Power Drift = -0.1 dB

Peak SAR (extrapolated) = 31 W/kg

SAR(1 g) = 7.85 mW/g; SAR(10 g) = 2.2 mW/g

Maximum value of SAR (measured) = 15.2 mW/g

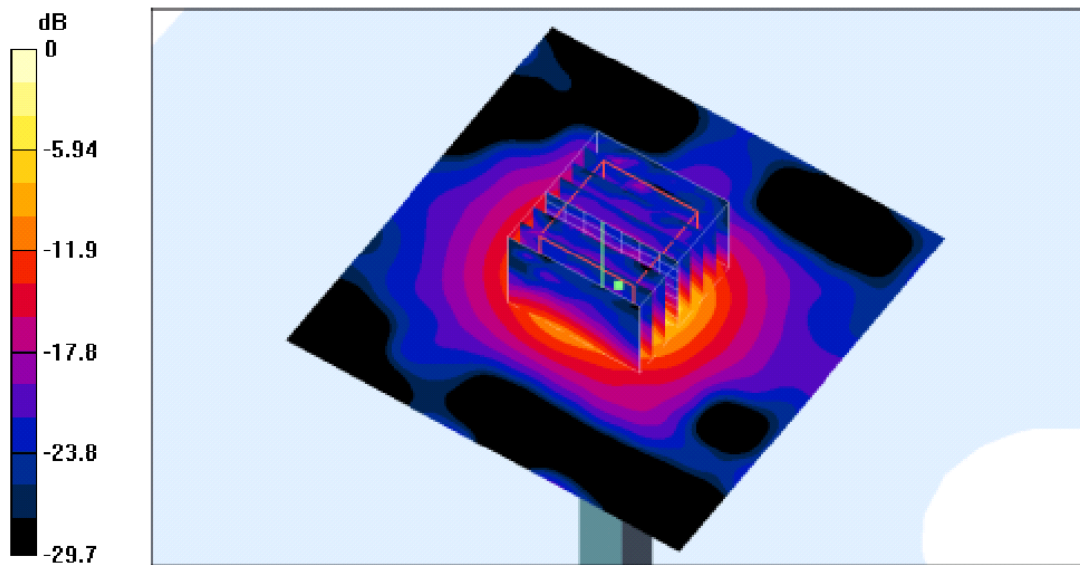

0 dB = 15.2mW/g



Appendix B - SAR Measurement Data

Test Laboratory: Sporton International Inc. SAR Testing Lab

Date/Time: 09/02/04 15:45:39

Body_802.11a Ch48_Side Touch_20040902

Mono_38 Key_SE800hP_2x Battery

DUT: SYMBOL MC3090 project; Type: Mobile Computer

Communication System: 802.11a; Frequency: 5240 MHz;Duty Cycle: 1:1

Medium: MSL_5GHz Medium parameters used: f = 5240 MHz; σ = 5.36 mho/m; ε_r = 47.1; ρ = 1000 kg/m³

Ambient Temperature : 21.9 °C; Liquid Temperature : 22.1 °C

DASY4 Configuration:

- Probe: EX3DV3 - SN3514; ConvF(4.14, 4.14, 4.14); Calibrated: 2004/1/23
- Sensor-Surface: 2mm (Mechanical Surface Detection)
- Electronics: DAE3 Sn577; Calibrated: 2003/11/21
- Phantom: SAM 12; Type: QD 000 P40 C; Serial: TP-1150
- Measurement SW: DASY4, V4.3 Build 16; Postprocessing SW: SEMCAD, V1.8 Build 123

Ch48/Area Scan (61x221x1): Measurement grid: dx=10mm, dy=10mm
Maximum value of SAR (interpolated) = 1.27 mW/g

Ch48/Zoom Scan (8x8x8)/Cube 0: Measurement grid: dx=4.3mm, dy=4.3mm, dz=3mm
Reference Value = 1.53 V/m; Power Drift = 0.1 dB
Peak SAR (extrapolated) = 0.302 W/kg
SAR(1 g) = 0.00431 mW/g; SAR(10 g) = 0.000807 mW/g
Maximum value of SAR (measured) = 0.175 mW/g

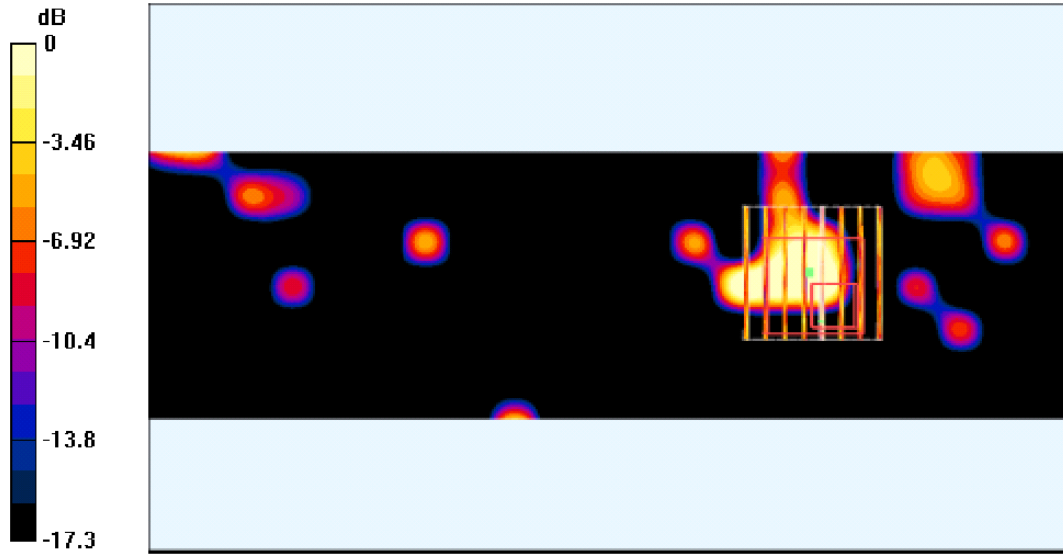

0 dB = 0.175mW/g



Appendix C – Calibration Data

Calibration Laboratory of
Schmid & Partner
Engineering AG
Zeughausstrasse 43, 8004 Zurich, Switzerland

Client Sporton (Auden)

CALIBRATION CERTIFICATE
Object(s) D5GHzV2 - SN:1006
Calibration procedure(s) QA CAL-05.v2
Calibration procedure for dipole validation kits
Calibration date: January 22, 2004
Condition of the calibrated item In Tolerance (according to the specific calibration document)
This calibration statement documents traceability of M&TE used in the calibration procedures and conformity of the procedures with the ISO/IEC 17025 International standard.
All calibrations have been conducted in the closed laboratory facility: environment temperature 22 +/- 2 degrees Celsius and humidity < 75%.
Calibration Equipment used (M&TE critical for calibration)
Table with columns: Model Type, ID #, Cal Date (Calibrated by, Certificate No.), Scheduled Calibration
Calibrated by: Name, Function, Signature
Approved by: Name, Function, Signature
Date issued: January 26, 2004
This calibration certificate is issued as an intermediate solution until the accreditation process (based on ISO/IEC 17025 International Standard) for Calibration Laboratory of Schmid & Partner Engineering AG is completed.



Schmid & Partner Engineering AG

s p e a g

Zeughausstrasse 43, 8004 Zurich, Switzerland
Phone +41 1 245 9700, Fax +41 1 245 9779
info@speag.com, <http://www.speag.com>

DASY

Dipole Validation Kit

Type: D5GHzV2

Serial: 1006

Manufactured: August 28, 2003
Calibrated: January 22, 2004



1. Measurement Conditions

The measurements were performed in the flat section of the SAM twin phantom filled with **head simulating solution** of the following electrical parameters:

Frequency:	5200 MHz	
Relative Dielectricity	36.3	± 5%
Conductivity	4.57 mho/m	± 5%
Frequency:	5800 MHz	
Relative Dielectricity	35.4	± 5%
Conductivity	5.20 mho/m	± 5%

The DASY4 System with a dosimetric E-field probe EX3DV3 - SN:3503 was used for the measurements. The dipole was mounted on the small tripod so that the dipole feedpoint was positioned below the center marking of the flat phantom section and the dipole was oriented parallel to the body axis (the long side of the phantom). The standard measuring distance was 10mm from dipole center to the solution surface. Lossless spacer was used during measurements for accurate distance positioning.

The coarse grid with a grid spacing of 10mm was aligned with the dipole. Special 8x8x8 fine cube was chosen for cube integration (dx=dy=4.3mm, dz=3mm). Distance between probe sensors and phantom surface was set to 2.5 mm. The dipole input power (forward power) was 250mW ± 3 %. The results are normalized to 1W input power.

2. SAR Measurement with DASY System

Standard SAR-measurements were performed according to the measurement conditions described in section 1. The results (see figures supplied) have been normalized to a dipole input power of 1W (forward power). The resulting averaged SAR-values measured at **5200 MHz (Head Tissue)** with the dosimetric probe EX3DV3 SN:3503 and applying the advanced extrapolation are:

averaged over 1 cm ³ (1 g) of tissue:	84.0 mW/g ± 20.3 % (k=2)¹
averaged over 10 cm ³ (10 g) of tissue:	23.4 mW/g ± 19.8 % (k=2)¹

The resulting averaged SAR-values measured at **5800 MHz (Head Tissue)** with the dosimetric probe EX3DV3 SN:3503 and applying the advanced extrapolation are:

averaged over 1 cm ³ (1 g) of tissue:	84.0 mW/g ± 20.3 % (k=2)²
averaged over 10 cm ³ (10 g) of tissue:	23.5 mW/g ± 19.8 % (k=2)²

¹ Target dipole values determined by FDTD (feedpoint impedance set to 50 Ohm). The values are SAR_1g=76.5 mW/g, SAR_10g=21.6 mW/g and SAR_peak=310.3 mW/g.

² Target dipole values determined by FDTD (feedpoint impedance set to 50 Ohm). The values are SAR_1g=78.0 mW/g, SAR_10g=21.9 mW/g and SAR_peak=340.9 mW/g.



3. Dipole Transformation Parameters

The impedance was measured at the SMA-connector with a network analyzer and numerically transformed to the dipole feedpoint (please refer to the graphics attached to this document). The transformation parameters from the SMA-connector to the dipole feedpoint are:

Electrical delay: **1.201ns** (one direction)
Transmission factor: **0.974** (voltage transmission, one direction)

4. Measurement Conditions

The measurements were performed in the flat section of the SAM twin phantom filled with **body simulating solution** of the following electrical parameters:

Frequency:	5200 MHz	
Relative Dielectricity	49.7	± 5%
Conductivity	5.18 mho/m	± 5%
Frequency:	5800 MHz	
Relative Dielectricity	48.5	± 5%
Conductivity	6.01 mho/m	± 5%

The DASY3 System with a dosimetric E-field probe EX3DV3 - SN:3503 was used for the measurements. The dipole was mounted on the small tripod so that the dipole feedpoint was positioned below the center marking of the flat phantom section and the dipole was oriented parallel to the body axis (the long side of the phantom). The standard measuring distance was 10mm from dipole center to the solution surface. Lossless spacer was used during measurements for accurate distance positioning.

The coarse grid with a grid spacing of 10mm was aligned with the dipole. The 8x8x8 fine cube was chosen for cube integration (dx=dy=4.3mm, dz=3mm). Distance between probe sensors and phantom surface was set to 2.5 mm. The dipole input power (forward power) was 250mW ± 3%. The results are normalized to 1W input power.



5. SAR Measurement with DASY System

Standard SAR-measurements were performed according to the measurement conditions described in section 4. The results (see figures supplied) have been normalized to a dipole input power of 1W (forward power). The resulting averaged SAR-values measured at **5200 MHz (Body Tissue)** with the dosimetric probe EX3DV3 SN:3503 and applying the advanced extrapolation are:

averaged over 1 cm³ (1 g) of tissue: **78.0 mW/g ± 20.3 % (k=2)³**

averaged over 10 cm³ (10 g) of tissue: **22.0 mW/g ± 19.8 % (k=2)³**

The resulting averaged SAR-values measured at **5800 MHz (Body Tissue)** with the dosimetric probe EX3DV3 SN:3503 and applying the advanced extrapolation are:

averaged over 1 cm³ (1 g) of tissue: **76.6 mW/g ± 20.3 % (k=2)⁴**

averaged over 10 cm³ (10 g) of tissue: **21.1 mW/g ± 19.8 % (k=2)⁴**

6. Handling

Do not apply excessive force to the dipole arms, because they might bend. Bending of the dipole arms stresses the soldered connections near the feedpoint leading to a damage of the dipole.

7. Design

The dipole is made of standard semirigid coaxial cable. The center conductor of the feeding line is directly connected to the second arm of the dipole. The antenna is therefore short-circuited for DC-signals.

Small end caps have been added to the dipole arms in order to increase frequency bandwidth at the position as explained in Sections 1 and 4.

8. Power Test

After long term use with 40W radiated power, only a slight warming of the dipole near the feedpoint can be measured.

³ Target dipole values determined by FDTD (feedpoint impedance set to 50 Ohm). The values are SAR_1g=71.8 mW/g, SAR_10g=20.1 mW/g and SAR_peak=284.7 mW/g.

⁴ Target dipole values determined by FDTD (feedpoint impedance set to 50 Ohm). The values are SAR_1g=74.1 mW/g, SAR_10g=20.5 mW/g and SAR_peak=324.7 mW/g.



Test Laboratory: SPEAG, Zurich, Switzerland

DUT: Dipole 5GHz; Serial: D5GHZV2 - SN:1006

Communication System: CW-5GHz;Duty Cycle: 1:1;Medium: HSL5800

Medium parameters used: $f = 5200$ MHz; $\sigma = 4.57$ mho/m; $\epsilon_r = 36.3$; $\rho = 1000$ kg/m³

Medium parameters used: $f = 5800$ MHz; $\sigma = 5.2$ mho/m; $\epsilon_r = 35.4$; $\rho = 1000$ kg/m³

DASY4 Configuration:

- Probe: EX3DV3 - SN3503; ConvF(5.7, 5.7, 5.7)
ConvF(5, 5, 5); Calibrated: 6/27/2003
- Sensor-Surface: 2.5mm (Mechanical Surface Detection)
- Electronics: DAE4 600; Calibrated: 9/30/2003
- Phantom: SAM with CRP - TP:1312; Phantom section: Flat Section
- Measurement SW: DASY4, V4.2 Build 21; Postprocessing SW: SEMCAD, V2.0 Build 14

d=10mm, Pin=250mW, f=5200 MHz/Area Scan (91x91x1): Measurement grid: dx=10mm, dy=10mm

Reference Value = 95.1 V/m

Power Drift = -0.1 dB

Maximum value of SAR = 39 mW/g

d=10mm, Pin=250mW, f=5800 MHz/Zoom Scan (8x8x8), dist=2.5mm (7x7x8)/Cube 0:

Measurement grid: dx=4.3mm, dy=4.3mm, dz=3mm

Peak SAR (extrapolated) = 86.5 W/kg

SAR(1 g) = 21 mW/g; SAR(10 g) = 5.88 mW/g

d=10mm, Pin=250mW, f=5200 MHz/Zoom Scan (8x8x8), dist=2.5mm (7x7x8)/Cube 0:

Measurement grid: dx=4.3mm, dy=4.3mm, dz=3mm

Peak SAR (extrapolated) = 81.9 W/kg

SAR(1 g) = 21 mW/g; SAR(10 g) = 5.84 mW/g

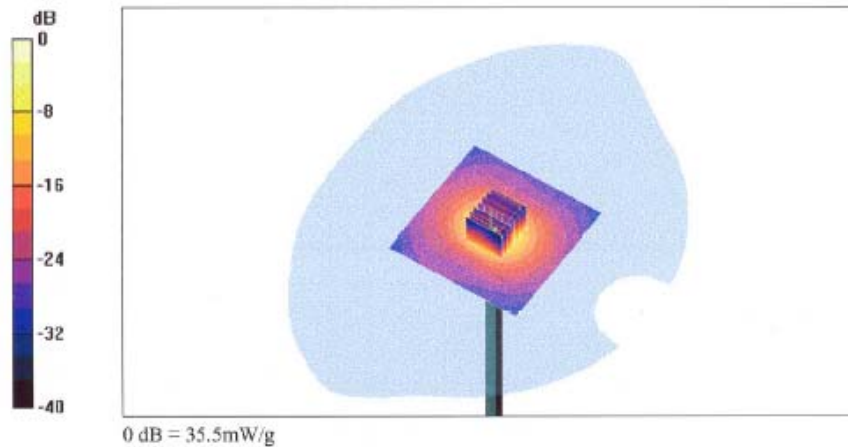



Test Laboratory: SPEAG, Zurich, Switzerland

DUT: Dipole 5GHz; Serial: D5GHZV2 - SN:1006

Communication System: CW-5GHz;Duty Cycle: 1:1;Medium: MSL5800

Medium parameters used: $f = 5200$ MHz; $\sigma = 5.18$ mho/m; $\epsilon_r = 49.7$; $\rho = 1000$ kg/m³

Medium parameters used: $f = 5800$ MHz; $\sigma = 6.01$ mho/m; $\epsilon_r = 48.5$; $\rho = 1000$ kg/m³

DASY4 Configuration:

- Probe: ESX3DV3 - SN3503; ConvF(5, 5, 5)
ConvF(4.6, 4.6, 4.6); Calibrated: 6/27/2003
- Sensor-Surface: 2.5mm (Mechanical Surface Detection)
- Electronics: DAE4 600; Calibrated: 9/30/2003
- Phantom: SAM with CRP - TP.1312; Phantom section: Flat Section
- Measurement SW: DASY4, V4.2 Build 21; Postprocessing SW: SEMCAD, V2.0 Build 14

d=10mm, Pin=250mW, f=5200 MHz/Area Scan (91x91x1): Measurement grid: dx=10mm, dy=10mm

Reference Value = 80.2 V/m

Power Drift = -0.007 dB

Maximum value of SAR = 36.8 mW/g

d=10mm, Pin=250mW, f=5800 MHz/Zoom Scan (8x8x8), dist=2.5mm (7x7x8)/Cube 0:

Measurement grid: dx=4.3mm, dy=4.3mm, dz=3mm

Peak SAR (extrapolated) = 78.4 W/kg

SAR(1 g) = 19.2 mW/g; SAR(10 g) = 5.28 mW/g

d=10mm, Pin=250mW, f=5200 MHz/Zoom Scan (8x8x8), dist=2.5mm (7x7x8)/Cube 0:

Measurement grid: dx=4.3mm, dy=4.3mm, dz=3mm

Peak SAR (extrapolated) = 69.7 W/kg

SAR(1 g) = 19.5 mW/g; SAR(10 g) = 5.49 mW/g

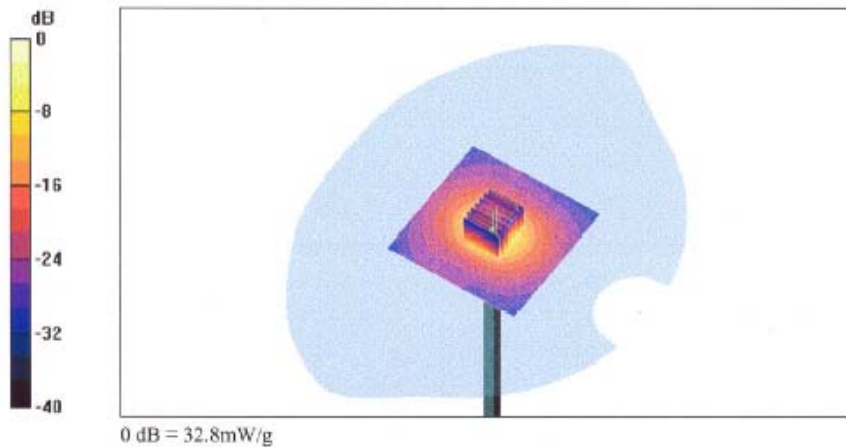



100G
Head

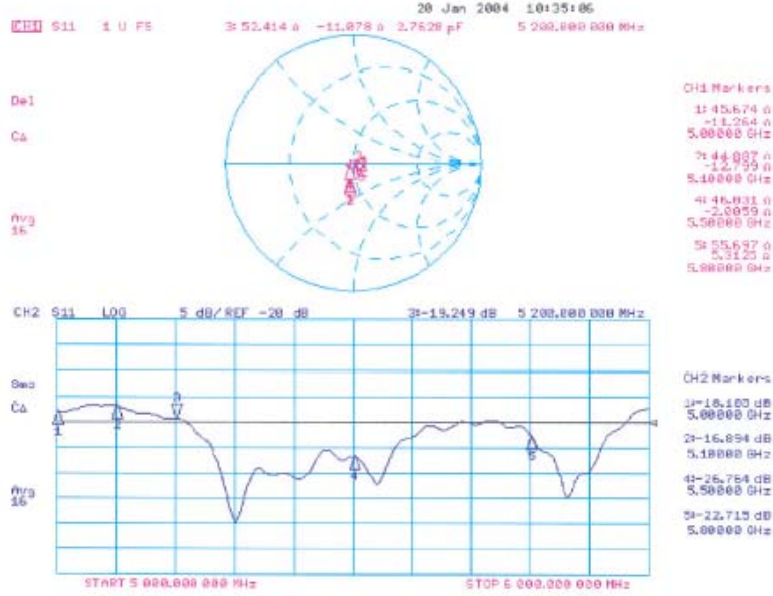



100G
Body

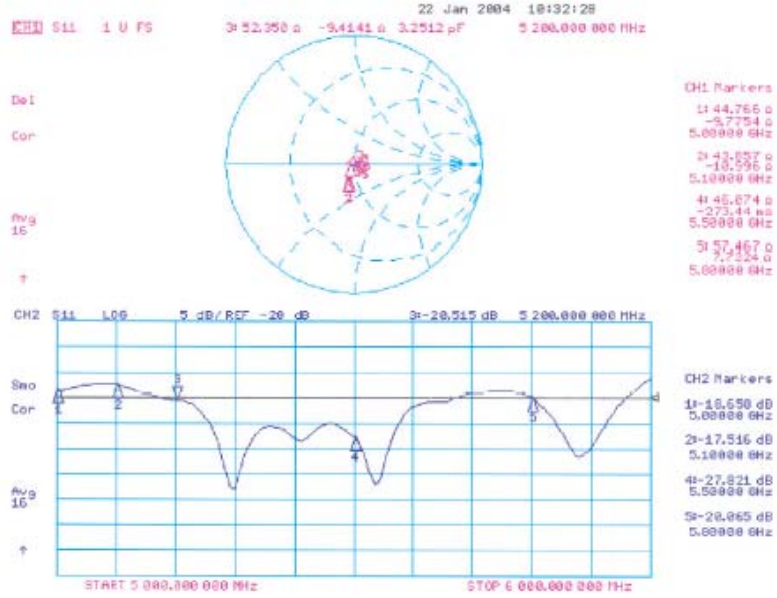



Calibration Laboratory of
Schmid & Partner
Engineering AG
Zeughausstrasse 43, 8004 Zurich, Switzerland

Client Sporton International Inc. (Auden)

CALIBRATION CERTIFICATE
Object(s) EX3DV3 - SN:3514
Calibration procedure(s) QA CAL-01.v2
Calibration date: January 23, 2004
Condition of the calibrated item In Tolerance (according to the specific calibration document)
This calibration certificate documents the traceability to national standards...
All calibrations have been conducted in the closed laboratory facility...
Calibration Equipment used (M&TE critical for calibration)
Table with columns: Model Type, ID #, Cal Date (Calibrated by, Certificate No.), Scheduled Calibration
Calibrated by: Nico Vetterli, Technician
Approved by: Katja Pekovic, Laboratory Director
Date issued: January 25, 2004
This calibration certificate is issued as an intermediate solution until the accreditation process... is completed.



Probe EX3DV3

SN:3514

Manufactured: December 15, 2003
Last calibrated: January 23, 2004

Calibrated for DASY Systems

(Note: non-compatible with DASY2 system!)



EX3DV3 SN:3514

January 23, 2004

DASY - Parameters of Probe: EX3DV3 SN:3514

Sensitivity in Free Space

NormX	0.66 $\mu\text{V}/(\text{V}/\text{m})^2$
NormY	0.67 $\mu\text{V}/(\text{V}/\text{m})^2$
NormZ	0.60 $\mu\text{V}/(\text{V}/\text{m})^2$

Diode Compression^A

DCP X	97	mV
DCP Y	97	mV
DCP Z	97	mV

Sensitivity in Tissue Simulating Liquid (Conversion Factors)

Please see Page 7.

Boundary Effect

Head 900 MHz Typical SAR gradient: 5 % per mm

Sensor Center to Phantom Surface Distance		2.0 mm	3.0 mm
SAR _{be} [%]	Without Correction Algorithm	3.2	1.2
SAR _{be} [%]	With Correction Algorithm	0.6	0.1

Head 1800 MHz Typical SAR gradient: 10 % per mm

Sensor to Surface Distance		2.0 mm	3.0 mm
SAR _{be} [%]	Without Correction Algorithm	4.9	3.1
SAR _{be} [%]	With Correction Algorithm	1.7	0.5

Sensor Offset

Probe Tip to Sensor Center 1.0 mm

The reported uncertainty of measurement is stated as the standard uncertainty of measurement multiplied by the coverage factor k=2, which for a normal distribution corresponds to a coverage probability of approximately 95%.

^A numerical linearization parameter: uncertainty not required



EX3DV3 SN:3514

January 23, 2004

Frequency Response of E-Field

(TEM-Cell:ifi110, Waveguide R22)

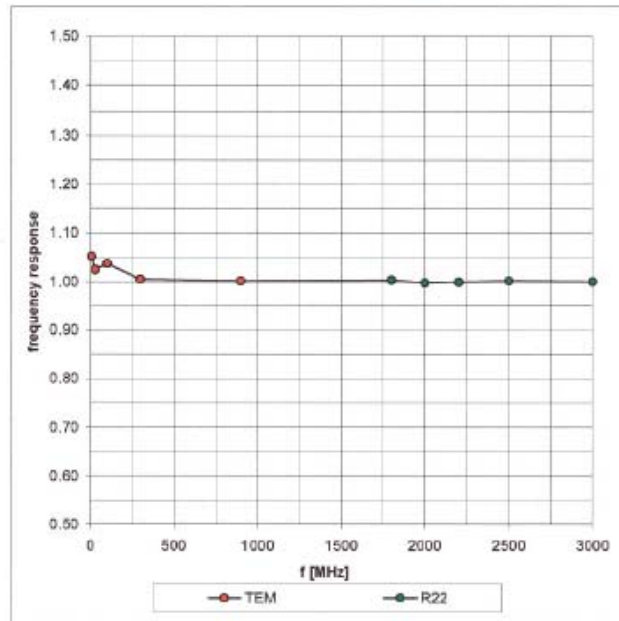



EX3DV3 SN:3514

January 23, 2004

Receiving Pattern (ϕ), $\theta = 0^\circ$

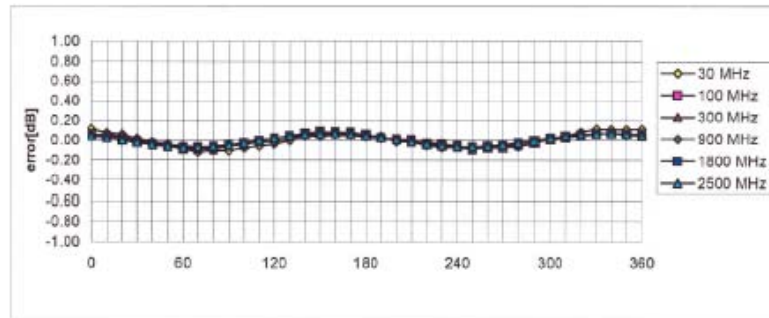
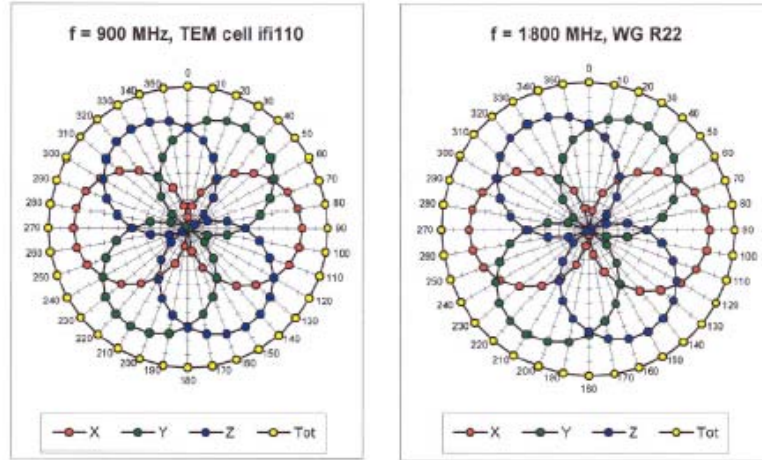

Axial Isotropy Error $< \pm 0.2$ dB



EX3DV3 SN:3514

January 23, 2004

Dynamic Range f(SAR_{head}) (Waveguide R22)

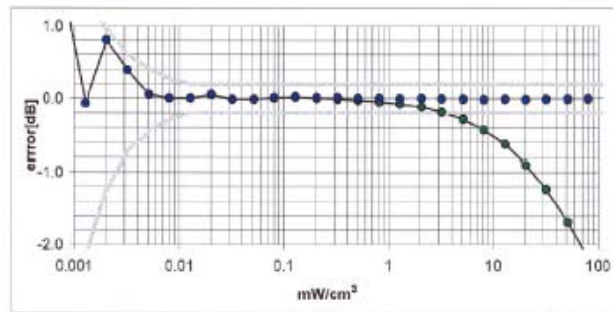
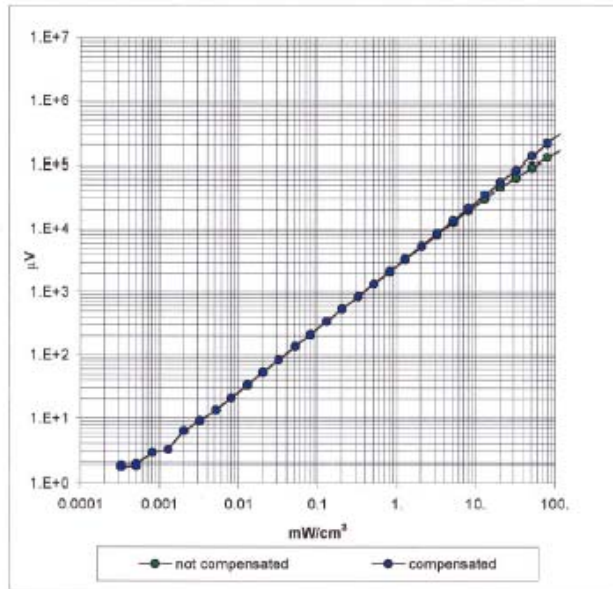

Probe Linearity ± 0.2 dB



EX3DV3 SN:3514

January 23, 2004

Conversion Factor Assessment

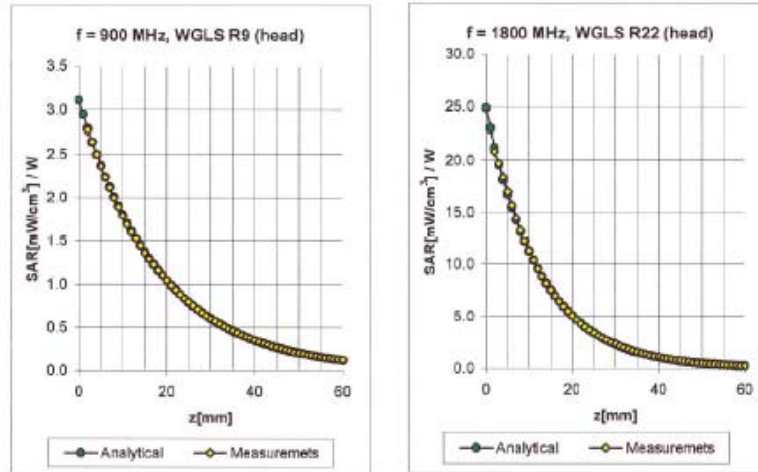

f [MHz]	Validity [MHz] ^a	Tissue	Permittivity	Conductivity	Alpha	Depth	ConvF Uncertainty
900	800-1000	Head	41.5 ± 5%	0.97 ± 5%	0.45	0.80	9.59 ± 11.3% (k=2)
1800	1710-1910	Head	40.0 ± 5%	1.40 ± 5%	0.39	1.10	8.30 ± 11.7% (k=2)
5200	4940-5460	Head	36.0 ± 5%	4.66 ± 5%	0.42	1.80	4.88 ± 21.8% (k=2)
5800	5510-6090	Head	35.3 ± 5%	5.27 ± 5%	0.42	1.80	4.38 ± 23.4% (k=2)
5200	4940-5460	Body	49.0 ± 5%	5.30 ± 5%	0.45	1.90	4.14 ± 21.8% (k=2)
5800	5510-6090	Body	48.2 ± 5%	6.00 ± 5%	0.43	1.90	3.85 ± 23.4% (k=2)

^a The total standard uncertainty is calculated as root-sum-square of standard uncertainty of the Conversion Factor at calibration frequency and the standard uncertainty for the indicated frequency band.



EX3DV3 SN:3514

January 23, 2004

Deviation from Isotropy in HSL
Error (θ, ϕ), $f = 900$ MHz

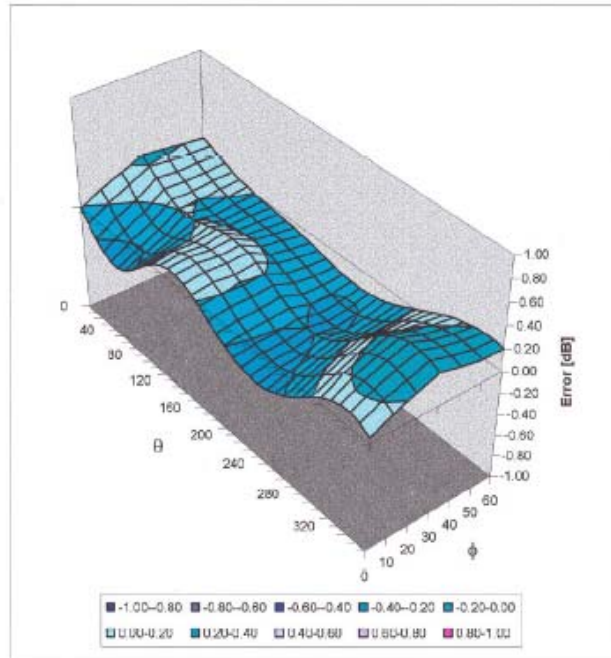

Spherical Isotropy Error < ± 0.4 dB



Calibration Laboratory of
Schmid & Partner
Engineering AG
Zeughausstrasse 43, 8004 Zurich, Switzerland

Client Sporton (Auden)

CALIBRATION CERTIFICATE			
Object(s)	DAE3 – SD 000 D03 AA – SN:577		
Calibration procedure(s)	QA CAL-06.v4 Calibration procedure for the data acquisition unit (DAE)		
Calibration date:	21.11.2003		
Condition of the calibrated item	In Tolerance (according to the specific calibration document)		
This calibration statement documents traceability of M&TE used in the calibration procedures and conformity of the procedures with the ISO/IEC 17025 international standard			
All calibrations have been conducted in the closed laboratory facility environment temperature 22 +/- 2 degrees Celsius and humidity < 75%.			
Calibration Equipment used (M&TE critical for calibration)			
Model Type	ID #	Cal Date	Scheduled Calibration
Fluke Process Calibrator Type 702	SN: 6295803	8-Sep-03	Sep-05
Calibrated by:	Name Philipp Storchenegger	Function Technician	Signature
Approved by:	Name Fin Bomholt	Function R&D Director	Signature
Date issued: 21.11.2003			
This calibration certificate is issued as an intermediate solution until the accreditation process (based on ISO/IEC 17025 International Standard) for Calibration Laboratory of Schmid & Partner Engineering AG is completed.			



DAE3 SN: 577

DATE: 21.11.2003

1. Cal Lab. Incoming Inspection & Pre Test

Modification Status	Note Status here → → → →	BC
Visual Inspection	Note anomalies.....	None
Pre Test	Indication	Yes/No
Probe Touch	Function	Yes
Probe Collision	Function	Yes
Probe Touch&Collision	Function	Yes

2. DC Voltage Measurement

A/D - Converter Resolution nominal

High Range: 1LSB = 6.1μV , full range = 400 mV
 Low Range: 1LSB = 61nV , full range = 4 mV

DASY measurement parameters: Auto Zero Time: 3 sec; Measuring time: 3 sec

Calibration Factors	X	Y	Z
High Range	404.434	403.889	404.352
Low Range	3.94303	3.94784	3.9501
Connector Angle to be used in DASY System	127 °		

High Range	Input	Reading in μV	% Error
Channel X + Input	200mV	200000.6	0.00
	20mV	20000.9	0.00
Channel X - Input	20mV	-19992.7	-0.04
Channel Y + Input	200mV	200000.6	0.00
	20mV	19999.1	0.00
Channel Y - Input	20mV	-19994.7	-0.03
Channel Z + Input	200mV	199999.8	0.00
	20mV	19998.1	-0.01
Channel Z - Input	20mV	-19999.2	0.00

Low Range	Input	Reading in μV	% Error
Channel X + Input	2mV	1999.94	0.00
	0.2mV	199.08	-0.46
Channel X - Input	0.2mV	-200.24	0.12
Channel Y + Input	2mV	1999.98	0.00
	0.2mV	199.50	-0.25
Channel Y - Input	0.2mV	-200.80	0.40
Channel Z + Input	2mV	1999.98	0.00
	0.2mV	199.11	-0.44
Channel Z - Input	0.2mV	-201.12	0.56



DAE3 SN: 577

DATE: 21.11.2003

3. Common mode sensitivity

DASY measurement parameters:

Auto Zero Time: 3 sec,

Measuring time: 3 sec

High/Low Range

in μ V	Common mode Input Voltage	High Range Reading	Low Range Reading
Channel X	200mV	12.00	11.9
	- 200mV	-10.76	-12.44
Channel Y	200mV	-8.55	-8.51
	- 200mV	7.58	6.67
Channel Z	200mV	-0.86	-0.58
	- 200mV	-0.85	-0.77

4. Channel separation

DASY measurement parameters:

Auto Zero Time: 3 sec,

Measuring time: 3 sec

High Range

in μ V	Input Voltage	Channel X	Channel Y	Channel Z
Channel X	200mV	-	1.96	0.28
Channel Y	200mV	0.66	-	3.59
Channel Z	200mV	-0.89	-0.11	-

5.1 AD-Converter Values with Input Voltage set to 2.0 VDC

in Zero Low	Low Range Max - Min	Max.	Min
Channel X	17	16137	16120
Channel Y	27	16767	16740
Channel Z	8	15103	15077

5.2 AD-Converter Values with inputs shorted

in LSB	Low Range	High Range
Channel X	16134	15955
Channel Y	16740	15960
Channel Z	15093	16252

6. Input Offset Measurement



DAE3 SN: 577

DATE: 21.11.2003

DASY measurement parameters:

Auto Zero Time: 3 sec, Measuring time: 3 sec
Number of measurements: 100, Low Range

Input 10MΩ

in μV	Average	min. Offset	max. Offset	Std. Deviation
Channel X	-0.64	-1.84	0.71	0.49
Channel Y	-1.77	-3.93	0.94	0.58
Channel Z	-2.21	-3.14	-0.81	0.34

Input shorted

in μV	Average	min. Offset	max. Offset	Std. Deviation
Channel X	0.12	-1.34	1.45	0.69
Channel Y	-0.69	-1.39	0.30	0.26
Channel Z	-0.94	-1.58	-0.30	0.23

7. Input Offset Current

Nominal Input circuitry offset current on all channels: <25fA

8. Input Resistance

In MOhm	Calibrating	Measuring
Channel X	0.2000	197.1
Channel Y	0.1999	200.3
Channel Z	0.2001	198.3

9. Low Battery Alarm Voltage

in V	Alarm Level
Supply (+ Vcc)	7.58
Supply (- Vcc)	-7.65

10. Power Consumption

in mA	Switched off	Stand by	Transmitting
Supply (+ Vcc)	0.00	5.65	13.7
Supply (- Vcc)	-0.01	-7.69	-8.97