



FCC TEST REPORT (15.407)

REPORT NO.: RF960308H04

MODEL NO.: 21-92955

RECEIVED: March 09, 2007

TESTED: March 20 to 29, 2007

ISSUED: March 29, 2007

APPLICANT: Symbol Technologies Inc.

ADDRESS: One Symbol Plaza, Holtsville, NY 11742- 1300
U.S.A.

ISSUED BY: Advance Data Technology Corporation

TEST LOCATION: No. 81-1, Lu Liao Keng, 9 Ling, Wu Lung
Tsuen, Chiung Lin Hsiang, Hsin Chu Hsien,
Taiwan, R.O.C.

This test report consists of 70 pages in total. It may be duplicated completely for legal use with the approval of the applicant. It should not be reproduced except in full, without the written approval of our laboratory. The client should not use it to claim product endorsement by CNLA, A2LA or any government agencies. The test results in the report only apply to the tested sample.



No. 2177-01

Table of Contents

1.	CERTIFICATION	4
2.	SUMMARY OF TEST RESULTS	5
2.1	MEASUREMENT UNCERTAINTY.....	6
3.	GENERAL INFORMATION.....	7
3.1	GENERAL DESCRIPTION OF EUT	7
3.2	DESCRIPTION OF TEST MODES	9
3.2.1	TEST MODE APPLICABILITY AND TESTED CHANNEL DETAIL:	10
3.3	GENERAL DESCRIPTION OF APPLIED STANDARDS	12
3.4	DESCRIPTION OF SUPPORT UNITS.....	13
3.5	CONFIGURATION OF SYSTEM UNDER TEST.....	13
4.	TEST TYPES AND RESULTS	14
4.1	CONDUCTED EMISSION MEASUREMENT	14
4.1.1	LIMITS OF CONDUCTED EMISSION MEASUREMENT.....	14
4.1.2	TEST INSTRUMENTS.....	14
4.1.3	TEST PROCEDURES	15
4.1.4	DEVIATION FROM TEST STANDARD.....	15
4.1.5	TEST SETUP	16
4.1.6	EUT OPERATING CONDITIONS	16
4.1.7	TEST RESULTS	17
4.2	RADIATED EMISSION MEASUREMENT	19
4.2.1	LIMITS OF RADIATED EMISSION MEASUREMENT.....	19
4.2.2	LIMITS OF UNWANTED EMISSION OUT OF THE RESTRICTED BANDS.....	20
4.2.3	TEST INSTRUMENTS.....	21
4.2.4	TEST PROCEDURES	22
4.2.5	DEVIATION FROM TEST STANDARD.....	22
4.2.6	TEST SETUP	23
4.2.7	EUT OPERATING CONDITION.....	23
4.2.8	TEST RESULTS	24
4.3	PEAK TRANSMIT POWER MEASUREMENT	32
4.3.1	LIMITS OF PEAK TRANSMIT POWER MEASUREMENT	32
4.3.2	TEST INSTRUMENTS.....	32
4.3.3	TEST PROCEDURE.....	33
4.3.4	DEVIATION FROM TEST STANDARD.....	33
4.3.5	TEST SETUP	33



4.3.6	EUT OPERATING CONDITIONS	33
4.3.7	TEST RESULTS	34
4.4	PEAK POWER EXCURSION MEASUREMENT	43
4.4.1	LIMITS OF PEAK POWER EXCURSION MEASUREMENT	43
4.4.2	TEST INSTRUMENTS.....	43
4.4.3	TEST PROCEDURE.....	44
4.4.4	DEVIATION FROM TEST STANDARD	44
4.4.5	TEST SETUP	44
4.4.6	EUT OPERATING CONDITIONS	44
4.4.7	TEST RESULTS	45
4.5	PEAK POWER SPECTRAL DENSITY MEASUREMENT	49
4.5.1	LIMITS OF PEAK POWER SPECTRAL DENSITY MEASUREMENT	49
4.5.2	TEST INSTRUMENTS.....	49
4.5.3	TEST PROCEDURES	50
4.5.4	DEVIATION FROM TEST STANDARD	50
4.5.5	TEST SETUP	50
4.5.6	EUT OPERATING CONDITIONS	50
4.5.7	TEST RESULTS	51
4.6	FREQUENCY STABILITY.....	55
4.6.1	LIMITS OF FREQUENCY STABILITY MEASUREMENT	55
4.6.2	TEST INSTRUMENTS.....	55
4.6.3	TEST PROCEDURE.....	55
4.6.4	DEVIATION FROM TEST STANDARD	56
4.6.5	TEST SETUP	56
4.6.6	EUT OPERATING CONDITION.....	56
4.6.7	TEST RESULTS	57
4.7	BAND EDGES MEASUREMENT.....	58
4.7.1	TEST INSTRUMENTS.....	58
4.7.2	TEST PROCEDURE.....	58
4.7.3	EUT OPERATING CONDITION.....	58
4.7.4	TEST RESULTS	59
4.8	ANTENNA REQUIREMENT	68
4.8.1	STANDARD APPLICABLE.....	68
4.8.2	ANTENNA CONNECTED CONSTRUCTION.....	68
5.	INFORMATION ON THE TESTING LABORATORIES	69
	APPENDIX-A.....	A-1



1. CERTIFICATION

PRODUCT: 802.11a/b/g WLAN SDIO Radio Module
BRAND NAME: Symbol Technologies Inc.
MODEL NO.: 21-92955
TEST SAMPLE: ENGINEERING SAMPLE
TESTED: March 20 to 29, 2007
APPLICANT: Symbol Technologies Inc.
STANDARDS: FCC Part 15, Subpart E (Section 15.407)
ANSI C63.4-2003

The above equipment (Model: 21-92955) has been tested by **Advance Data Technology Corporation**, and found compliance with the requirement of the above standards. The test record, data evaluation & Equipment Under Test (EUT) configurations represented herein are true and accurate accounts of the measurements of the sample's EMC characteristics under the conditions specified in this report.

PREPARED BY : Carol Liao , **DATE:** March 29, 2007
(Carol Liao)

TECHNICAL ACCEPTANCE : Moris Lin , **DATE:** March 29, 2007
Responsible for RF (Moris Lin)

APPROVED BY : Hank Chung , **DATE:** March 29, 2007
(Hank Chung, Deputy Manager)

2. SUMMARY OF TEST RESULTS

The EUT has been tested according to the following specifications:

APPLIED STANDARD: FCC Part 15, Subpart E (Section 15.407)			
Standard Section	Test Type	Result	Remark
15.407(b)(5)	AC Power Conducted Emission	PASS	Meet the requirement of limit. Minimum passing margin is -11.8dB at 16.630MHz
15.407(b/1/2/3) (b)(5)	Electric Field Strength Spurious Emissions, 30MHz ~ 40000MHz	PASS	Meet the requirement of limit. Minimum passing margin is -0.3dB at 5150.00MHz, 5350.00MHz, 10640.00MHz and 11200.00MHz
15.407(a/1/2/3)	Peak Transmit Power	PASS	Meet the requirement of limit.
15.407(a)(6)	Peak Power Excursion	PASS	Meet the requirement of limit.
15.407(a/1/2/3)	Peak Power Spectral Density	PASS	Meet the requirement of limit.
15.407(g)	Frequency Stability	PASS	Meet the requirement of limit.

NOTE:

1. The EUT was operating in 2.412 ~ 2.462GHz, 5.15~5.35GHz, 5.47~5.725GHz and 5.725~5.850GHz frequencies band. This report was recorded the RF parameters including 5.15~5.35GHz and 5.47~5.725GHz. For the 2.412 ~ 2.462GHz and 5.725 ~ 5.850GHz RF parameters was recorded in another test report.

2.1 MEASUREMENT UNCERTAINTY

Where relevant, the following measurement uncertainty levels have been estimated for tests performed on the EUT as specified in CISPR 16-4:

This uncertainty represents an expanded uncertainty expressed at approximately the 95% confidence level using a coverage factor of $k=2$.

Measurement	Value
Conducted emissions	2.41 dB
Radiated emissions (30MHz-1GHz)	3.89 dB
Radiated emissions (1GHz -18GHz)	2.21 dB
Radiated emissions (18GHz -40GHz)	1.88 dB



3. GENERAL INFORMATION

3.1 GENERAL DESCRIPTION OF EUT

EUT	802.11a/b/g WLAN SDIO Radio Module
MODEL NO.	21-92955
FCC ID	H9P2192955
POWER SUPPLY	DC 3.3V +/-5% from host equipment
MODULATION TYPE	CCK, DQPSK, DBPSK for DSSS 64QAM, 16QAM, QPSK, BPSK for OFDM
MODULATION TECHNOLOGY	DSSS, OFDM
TRANSFER RATE	802.11b: 11/5.5/2/1Mbps 802.11g: 54/48/36/24/18/12/9/6Mbps 802.11a: 54/48/36/24/18/12/9/6Mbps
FREQUENCY RANGE	For 15.407 802.11a: 5.15 ~ 5.35GHz and 5.47 ~ 5.725GHz
	For 15.247 802.11b & 802.11g: 2412 ~ 2462MHz 802.11a: 5.725 ~ 5.850GHz
NUMBER OF CHANNEL	For 15.407 802.11a (5.15 ~ 5.35GHz): 8 802.11a (5.47 ~ 5.725GHz): 15
	For 15.247 802.11b & 802.11g: 11 802.11a (5.725 ~ 5.850GHz): 5
CHANNEL SPACING	802.11b & 802.11g: 5MHz 802.11a: 20MHz
OUTPUT POWER	For 802.11b: 44.668mW For 802.11g: 107.152mW For 802.11a (FCC15.247): 104.713mW For 802.11a (FCC15.407): 34.834mW
DATA CABLE	NA
ANTENNA TYPE	Please see note 3 (on next page)
I/O PORTS	NA
ASSOCIATED DEVICES	NA

NOTE:

1. The EUT operates in both the 5GHz and 2.4GHz Bands and compatibility with 802.11a and 802.11b, 802.11g technology.
2. There are two crystals have been pre-tested in our facility as following:

Mode	Frequency
A	Crystal 1: Brand : RIVER, Model : FCXO-05-40MJ61185
B	Crystal 2: Brand : SWIRD, Model : OSC913200JLS

The function and circuit of above crystals are identical to each other except for the brand.

The worse case was found in mode A. The final test data was recorded in this report.

3. There is one antenna provided to this EUT, please refer to the following table:

Model No.	Symbol P/N	Frequency Range	Gain (dBi)	Cable Loss (dB)	Net Gain (dBi)	Antenna Type	Connector
C802-5100 01-A	ML-2452-A	2.4GHz	3	0.5	2.5	Dipole	RP-SMA MALE
	PA2-01	5GHz	4	1.2	2.8		

4. The above EUT information was declared by the manufacturer and for more detailed features description, please refer to the manufacturer's specifications or User's Manual.

3.2 DESCRIPTION OF TEST MODES

Operated in 5150MHz ~ 5350MHz bands:

Eight channels are provided to this EUT.

Channel	Frequency
1	5180 MHz
2	5200 MHz
3	5220 MHz
4	5240 MHz
5	5260 MHz
6	5280 MHz
7	5300 MHz
8	5320 MHz

Operated in 5470MHz ~ 5725MHz bands:

Eleven channels are provided to this EUT.

Channel	Frequency
9	5500 MHz
10	5520 MHz
11	5540 MHz
12	5560 MHz
13	5580 MHz
14	5600 MHz
15	5620 MHz
16	5640 MHz
17	5660 MHz
18	5680 MHz
19	5700 MHz

3.2.1 TEST MODE APPLICABILITY AND TESTED CHANNEL DETAIL:

EUT configure mode	Applicable to				Description
	PLC	RE<1G	RE≥1G	APCM	
-	√	√	√	√	NA

Where PLC: Power Line Conducted Emission RE<1G RE: Radiated Emission below 1GHz
 RE≥1G: Radiated Emission above 1GHz APCM: Antenna Port Conducted Measurement

Power Line Conducted Emission Test:

- Pre-Scan has been conducted to determine the worst-case mode from all possible combinations between available modulations, data rates and antenna ports (if EUT with antenna diversity architecture).
- Following channel(s) was (were) selected for the final test as listed below.

Mode	Available Channel	Tested Channel	Modulation Technology	Modulation Type	Data Rate (Mbps)
802.11a	1 to 19	1	OFDM	BPSK	6

Radiated Emission Test (Below 1 GHz):

- Pre-Scan has been conducted to determine the worst-case mode from all possible combinations between available modulations, data rates and antenna ports (if EUT with antenna diversity architecture).
- Following channel(s) was (were) selected for the final test as listed below.

Mode	Available Channel	Tested Channel	Modulation Technology	Modulation Type	Data Rate (Mbps)
802.11a	1 to 19	1	OFDM	BPSK	6

Radiated Emission Test (Above 1 GHz):

- Pre-Scan has been conducted to determine the worst-case mode from all possible combinations between available modulations, data rates and antenna ports (if EUT with antenna diversity architecture).
- Following channel(s) was (were) selected for the final test as listed below.

Mode	Available Channel	Tested Channel	Modulation Technology	Modulation Type	Data Rate (Mbps)
802.11a	1 to 19	1, 4, 5, 8, 9, 14, 19	OFDM	BPSK	6

Bandedge Measurement:

- Pre-Scan has been conducted to determine the worst-case mode from all possible combinations between available modulations, data rates and antenna ports (if EUT with antenna diversity architecture).
- Following channel(s) was (were) selected for the final test as listed below.

Mode	Available Channel	Tested Channel	Modulation Technology	Modulation Type	Data Rate (Mbps)
802.11a	1 to 19	1, 8, 9, 19	OFDM	BPSK	6

Antenna Port Conducted Measurement:

- Pre-Scan has been conducted to determine the worst-case mode from all possible combinations between available modulations, data rates and antenna ports (if EUT with antenna diversity architecture).
- Following channel(s) was (were) selected for the final test as listed below.

Mode	Available Channel	Tested Channel	Modulation Technology	Modulation Type	Data Rate (Mbps)
802.11a	1 to 19	1, 4, 5, 8, 9, 14, 19	OFDM	BPSK	6



3.3 GENERAL DESCRIPTION OF APPLIED STANDARDS

The EUT is an 802.11a/b/g WLAN SDIO Radio Module and 802.11a/b/g WLAN SDIO Radio Module. According to the specifications of the manufacturer, it must comply with the requirements of the following standards:

FCC Part 15, Subpart E (15.407)

ANSI C63.4-2003

All test items have been performed and recorded as per the above standards.

3.4 DESCRIPTION OF SUPPORT UNITS

The EUT has been tested as an independent unit together with other necessary accessories or support units. The following support units or accessories were used to form a representative test configuration during the tests.

NO.	PRODUCT	BRAND	MODEL NO.	SERIAL NO.	FCC ID
1	NOTEBOOK COMPUTER	IBM	2672	9949APL	FCC DoC
2	DC POWER SUPPLY	GW	GPC-30600	7715073	FCC DoC
3	Extend Card	USI	JEDI ADAPTOR BOARD_DVT Rev1.4	NA	NA

NO.	SIGNAL CABLE DESCRIPTION OF THE ABOVE SUPPORT UNITS
1	NA
2	NA
3	NA

NOTE: All power cords of the above support units are non shielded (1.8m).

3.5 CONFIGURATION OF SYSTEM UNDER TEST

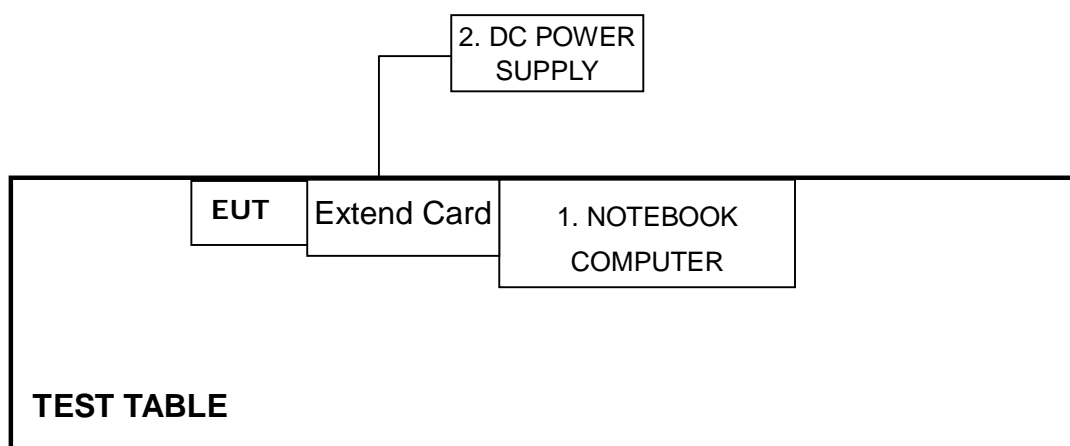

NOTE: 1. Please refer to the photos of test configuration.

4. TEST TYPES AND RESULTS

4.1 CONDUCTED EMISSION MEASUREMENT

4.1.1 LIMITS OF CONDUCTED EMISSION MEASUREMENT

FREQUENCY OF EMISSION (MHz)	CONDUCTED LIMIT (dB μ V)	
	Quasi-peak	Average
0.15-0.5	66 to 56	56 to 46
0.5-5	56	46
5-30	60	50

- NOTE:**
1. The lower limit shall apply at the transition frequencies.
 2. The limit decreases in line with the logarithm of the frequency in the range of 0.15 to 0.50 MHz.
 3. All emanations from a class A/B digital device or system, including any network of conductors and apparatus connected thereto, shall not exceed the level of field strengths specified above.

4.1.2 TEST INSTRUMENTS

DESCRIPTION & MANUFACTURER	MODEL NO.	SERIAL NO.	CALIBRATED UNTIL
Test Receiver	ESCS 30	847124/029	Mar. 01, 2008
Line-Impedance Stabilization Network(for EUT)	ENV-216	100071	Nov. 26, 2007
Line-Impedance Stabilization Network(for Peripheral)	ESH3-Z5	848773/004	Oct. 26, 2007
RF Cable (JETBAO)	RG233/U	Cable_CB_01	Dec. 09, 2007
Terminator	50	2	Oct. 30, 2007
Software	ADT_Cond_V7.3.2	NA	NA

- NOTE:**
1. The calibration interval of the above test instruments is 12 months and the calibrations are traceable to NML/ROC and NIST/USA.
 2. The test was performed in ADT Shielded Room No. B.
 3. The VCCI Con B Registration No. is C-2193.

4.1.3 TEST PROCEDURES

- a. The EUT was placed 0.4 meters from the conducting wall of the shielded room with EUT being connected to the power mains through a line impedance stabilization network (LISN). Other support units were connected to the power mains through another LISN. The two LISNs
- b. provide 50 ohm/ 50uH of coupling impedance for the measuring instrument.
- c. Both lines of the power mains connected to the EUT were checked for maximum conducted interference.
- d. The frequency range from 150kHz to 30MHz was searched. Emission level under (Limit – 20dB) was not recorded.

4.1.4 DEVIATION FROM TEST STANDARD

No deviation

4.1.5 TEST SETUP

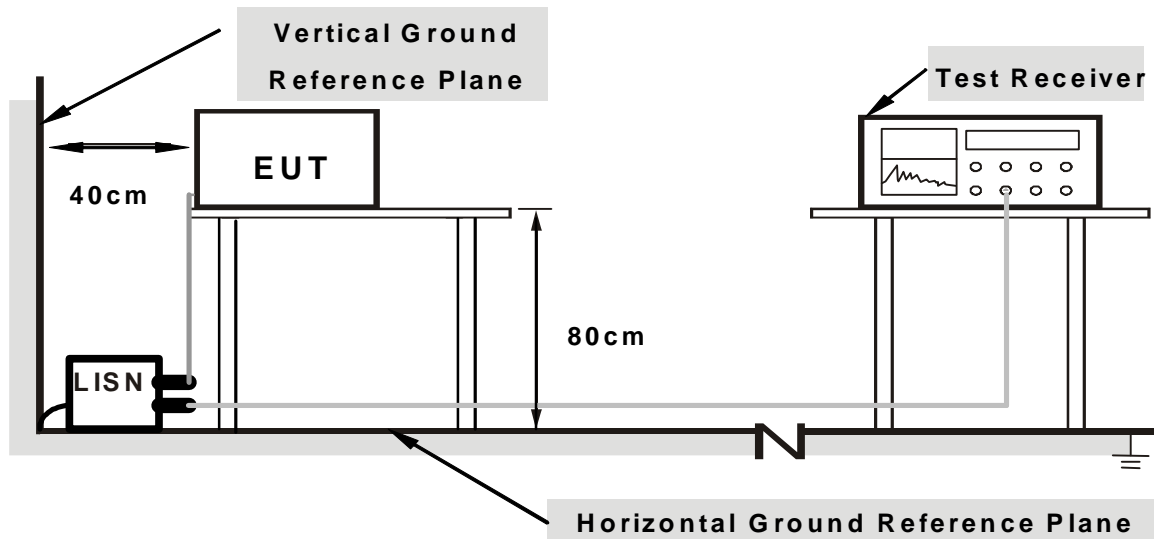

Note: 1. Support units were connected to second LISN.

2. Both of LISNs (AMN) are 80 cm from EUT and at least 80 from other units and other metal planes

For the actual test configuration, please refer to the related item – Photographs of the Test Configuration.

4.1.6 EUT OPERATING CONDITIONS

- a. Connect the EUT with the support unit 1 (Notebook computer) which placed on a testing table.
- b. The support unit 1 (Notebook computer) ran a test program “Prism Engineering” to enable EUT under transmission condition continuously.

4.1.7 TEST RESULTS

Conducted Worst-Case Data

MODULATION TYPE	BPSK	6dB BANDWIDTH	9 kHz
INPUT POWER	DC 3.3V	TRANSFER RATE	6Mbps
ENVIRONMENTAL CONDITIONS	22deg. C, 56%RH, 972hPa	PHASE	Positive
TESTED BY	Eric Lee		

No	Freq. [MHz]	Corr. Factor (dB)	Reading Value [dB (uV)]		Emission Level [dB (uV)]		Limit [dB (uV)]		Margin (dB)	
			Q.P.	AV.	Q.P.	AV.	Q.P.	AV.	Q.P.	AV.
			1	0.173	9.60	32.81	-	42.41	-	64.79
2	0.175	9.60	33.46	-	43.06	-	64.72	54.72	-21.66	-
3	0.875	9.60	32.49	-	42.09	-	56.00	46.00	-13.91	-
4	2.105	9.70	34.41	-	44.11	-	56.00	46.00	-11.89	-
5	16.630	10.03	37.46	-	47.49	-	60.00	50.00	-12.51	-
6	20.685	10.10	25.12	-	35.22	-	60.00	50.00	-24.78	-

- REMARKS:**
1. Q.P. and AV. are abbreviations of quasi-peak and average individually.
 2. "-": The Quasi-peak reading value also meets average limit and measurement with the average detector is unnecessary.
 3. The emission levels of other frequencies were very low against the limit.
 4. Margin value = Emission level - Limit value
 5. Correction factor = Insertion loss + Cable loss
 6. Emission Level = Correction Factor + Reading Value.

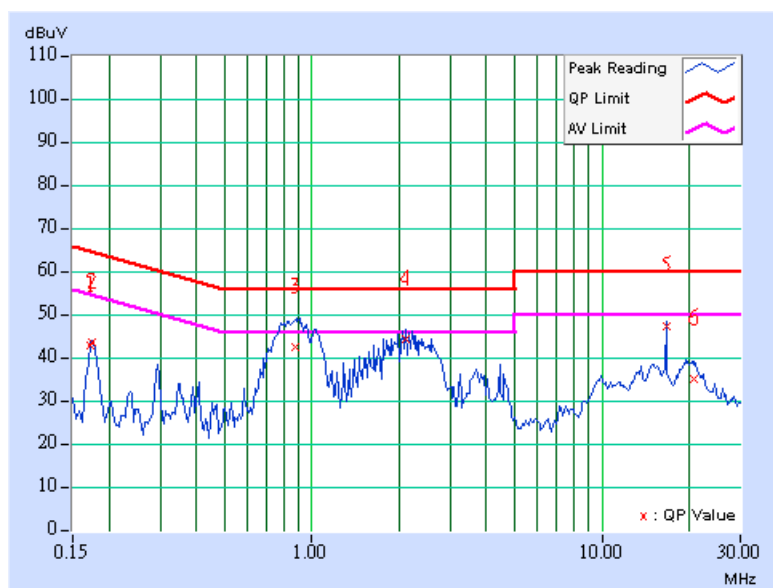

MODULATION TYPE	BPSK	6dB BANDWIDTH	9 kHz
INPUT POWER	DC 3.3V	TRANSFER RATE	6Mbps
ENVIRONMENTAL CONDITIONS	22deg. C, 56%RH, 972hPa	PHASE	Negative
TESTED BY	Eric Lee		

No	Freq. [MHz]	Corr. Factor (dB)	Reading Value [dB (uV)]		Emission Level [dB (uV)]		Limit [dB (uV)]		Margin (dB)	
			Q.P.	AV.	Q.P.	AV.	Q.P.	AV.	Q.P.	AV.
			1	0.174	9.60	33.30	-	42.90	-	64.77
2	0.295	9.60	26.06	-	35.66	-	60.40	50.40	-24.74	-
3	0.845	9.60	32.41	-	42.01	-	56.00	46.00	-13.99	-
4	0.994	9.60	28.71	-	38.31	-	56.00	46.00	-17.69	-
5	2.224	9.70	33.57	-	43.27	-	56.00	46.00	-12.73	-
6	16.630	10.10	38.10	-	48.20	-	60.00	50.00	-11.80	-

- REMARKS:**
1. Q.P. and AV. are abbreviations of quasi-peak and average individually.
 2. "-": The Quasi-peak reading value also meets average limit and measurement with the average detector is unnecessary.
 3. The emission levels of other frequencies were very low against the limit.
 4. Margin value = Emission level - Limit value
 5. Correction factor = Insertion loss + Cable loss
 6. Emission Level = Correction Factor + Reading Value.

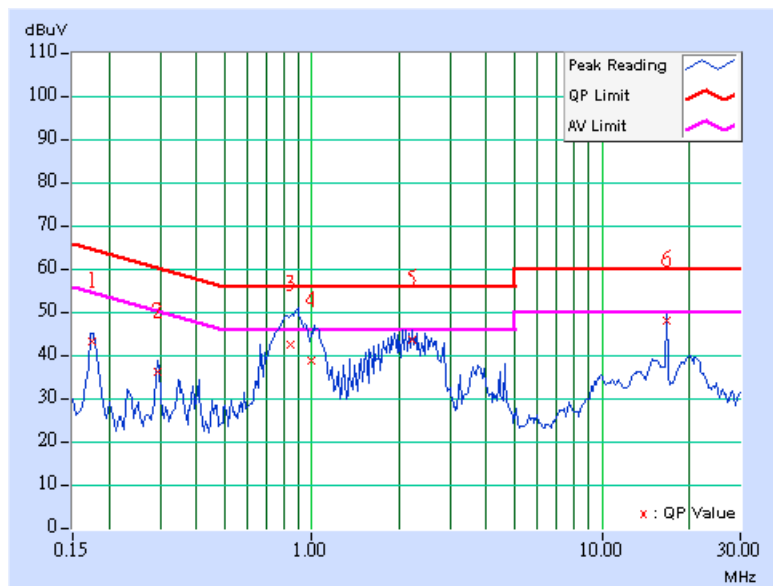

4.2 RADIATED EMISSION MEASUREMENT

4.2.1 LIMITS OF RADIATED EMISSION MEASUREMENT

Emissions radiated outside of the specified bands, shall be according to the general radiated limits in 15.209 as following:

Frequencies (MHz)	Field strength (microvolts/meter)	Measurement distance (meters)
0.009-0.490	2400/F(kHz)	300
0.490-1.705	24000/F(kHz)	30
1.705-30.0	30	30
30-88	100	3
88-216	150	3
216-960	200	3
Above 960	500	3

NOTE:

1. The lower limit shall apply at the transition frequencies.
2. Emission level (dBuV/m) = 20 log Emission level (uV/m).
3. As shown in 15.35(b), for frequencies above 1000MHz, the field strength limits are based on average detector, however, the peak field strength of any emission shall not exceed the maximum permitted average limits, specified above by more than 20dB under any condition of modulation.

4.2.2 LIMITS OF UNWANTED EMISSION OUT OF THE RESTRICTED BANDS

Frequencies (MHz)	EIRP Limit (dBm)	Equivalent Field Strength at 3m (dBμV/m) *note 3
5150~5250	-27	68.3
5250~5350	-27	68.3
5470~5725	-27	68.3
5725~5825	-27 *note 1	68.3
	-17 *note 2	78.3

NOTE:

1. For frequencies 10MHz or greater above or below the band edge.
2. All emissions within the frequency range from the band edge to 10MHz above or below the band edge.
3. The following formula is used to convert the equipment isotropic radiated power (eirp) to field strength

$$E = \frac{1000000\sqrt{30P}}{3} \mu\text{V/m, where P is the eirp (Watts)}$$



4.2.3 TEST INSTRUMENTS

DESCRIPTION & MANUFACTURER	MODEL NO.	SERIAL NO.	CALIBRATED UNTIL
ADVANTEST Spectrum Analyzer	R3271A	85060311	July 03, 2007
HP Pre_Amplifier	8449B	3008A01922	Sep. 18, 2007
ROHDE & SCHWARZ Test Receiver	ESCS30	100375	Sep. 20, 2007
CHASE Broadband Antenna	VULB9168	138	Dec. 10, 2007
Schwarzbeck Horn_Antenna	BBHA9120	D124	Jan. 01, 2008
Schwarzbeck Horn_Antenna	BBHA 9170	BBHA9170153	Jan. 04, 2008
SCHWARZBECK Biconical Antenna	VHBA9123	459	Jun. 08, 2009
SCHWARZBECK Periodic Antenna	UPA6108	1148	Jun. 08, 2009
R&S Loop Antenna	HFH2-Z2	881058/15	Nov. 29, 2007
RF Switches (ARNITSU)	CS-201	1565157	NA
RF CABLE (Chaintek)	SF102	22054-2	Nov. 14. 2007
RF Cable(RICHTEC)	9913-30M N-N Cable	STCCAB-30M-1 GHz	Jul. 15, 2007
Software	ADT_Radiated_V 5.14	NA	NA
CHANCE MOST Antenna Tower	AT-100	0203	NA
CHANCE MOST Turn Table	TT-100	0203	NA

- Note: 1. The calibration interval of the above test instruments is 12 months (36 months for Biconical and Periodic Antenna) and the calibrations are traceable to NML/ROC and NIST/USA.
2. The horn antenna, HP preamplifier (model: 8449B) and Spectrum Analyzer (model: R3271A) are used only for the measurement of emission frequency above 1GHz if tested.
3. The test was performed in ADT Open Site No. C.
4. The FCC Site Registration No. is 656396.
5. The VCCI Site Registration No. is R-1626.
6. The CANADA Site Registration No. is IC 4824A-3.
7. Loop antenna was used for all emissions below 30 MHz.

4.2.4 TEST PROCEDURES

- a. The EUT was placed on the top of a rotating table 0.8 meters above the ground at a 3 meter semi-anechoic chamber. The table was rotated 360 degrees to determine the position of the highest radiation.
- b. The EUT was set 3 meters away from the interference-receiving antenna, which was mounted on the top of a variable-height antenna tower.
- c. The antenna is a broadband antenna, and its height is varied from one meter to four meters above the ground to determine the maximum value of the field strength. Both horizontal and vertical polarizations of the antenna are set to make the measurement.
- d. For each suspected emission, the EUT was arranged to its worst case and then the antenna was tuned to heights from 1 meter to 4 meters and the rotatable table was turned from 0 degrees to 360 degrees to find the maximum reading.
- e. The test-receiver system was set to Peak Detect Function and Specified Bandwidth with Maximum Hold Mode.
- f. If the emission level of the EUT in peak mode was 10dB lower than the limit specified, then testing could be stopped and the peak values of the EUT would be reported. Otherwise the emissions that did not have 10dB margin would be re-tested one by one using peak, quasi-peak or average method as specified and then reported in a data sheet.

NOTE:

1. The resolution bandwidth and video bandwidth of test receiver/spectrum analyzer is 120kHz for Peak detection (PK) and Quasi-peak detection (QP) at frequency below 1GHz.
2. The resolution bandwidth of test receiver/spectrum analyzer is 1 MHz and the video bandwidth is 3 MHz for Peak detection (PK) at frequency above 1GHz.
3. The resolution bandwidth of test receiver/spectrum analyzer is 1 MHz and the video bandwidth is 10 Hz for Average detection (AV) at frequency above 1GHz.

4.2.5 DEVIATION FROM TEST STANDARD

No deviation

4.2.6 TEST SETUP

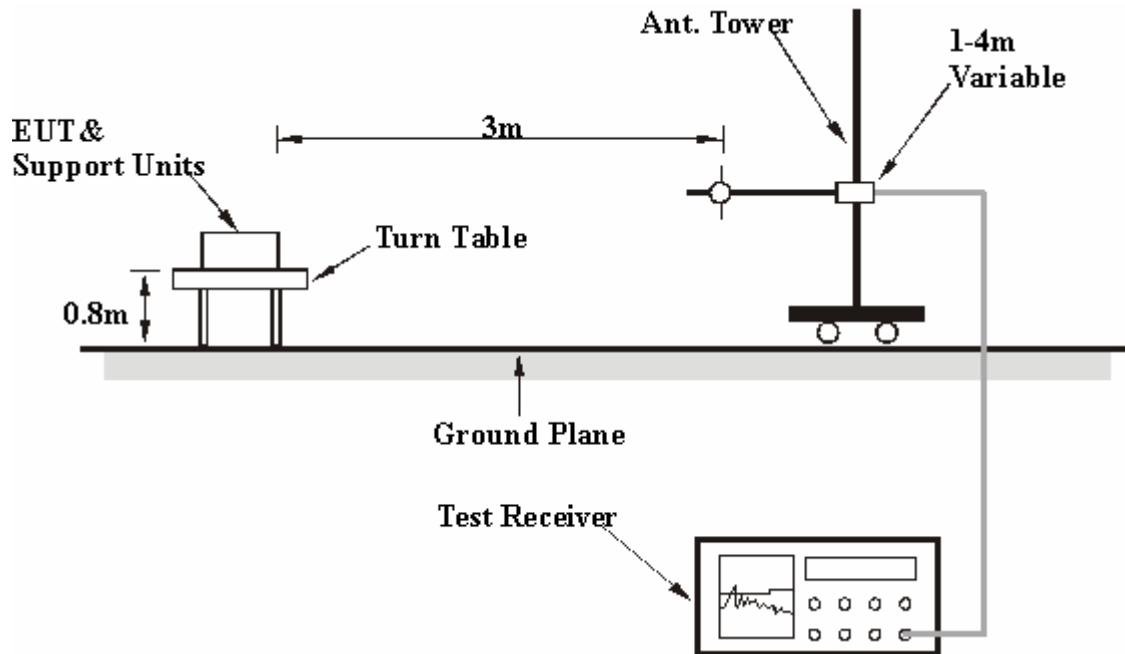

For the actual test configuration, please refer to the related item – Photographs of the Test Configuration.

4.2.7 EUT OPERATING CONDITION

Same as 4.1.6

4.2.8 TEST RESULTS

Below 1GHz Worst-Case Data

MODE	Channel 1	FREQUENCY RANGE	Below 1000MHz
MODULATION TYPE	BPSK	TRANSFER RATE	6Mbps
INPUT POWER (SYSTEM)	120Vac, 60 Hz	DETECTOR FUNCTION	Quasi-Peak
ENVIRONMENTAL CONDITIONS	23deg. C, 67%RH, 972hPa	TESTED BY	Rex Huang

ANTENNA POLARITY & TEST DISTANCE: HORIZONTAL AT 3 M

No.	Freq. (MHz)	Emission Level (dBuV/m)	Limit (dBuV/m)	Margin (dB)	Antenna Height (m)	Table Angle (Degree)	Raw Value (dBuV)	Correction Factor (dB/m)
1	133.51	27.32 QP	43.50	-16.18	1.97 H	325	14.41	12.91
2	200.08	30.74 QP	43.50	-12.76	1.76 H	338	19.14	11.60
3	233.46	40.03 QP	46.00	-5.97	1.44 H	357	26.97	13.06
4	366.60	41.61 QP	46.00	-4.39	1.00 H	357	23.69	17.92
5	433.18	39.36 QP	46.00	-6.64	1.00 H	337	19.37	19.99
6	533.23	39.77 QP	46.00	-6.23	1.69 H	264	17.03	22.74
7	633.46	37.02 QP	46.00	-8.98	1.55 H	236	12.17	24.85
8	800.00	40.59 QP	46.00	-5.41	1.03 H	241	13.03	27.56
9	933.28	37.98 QP	46.00	-8.02	1.27 H	320	8.44	29.54

ANTENNA POLARITY & TEST DISTANCE: VERTICAL AT 3 M

No.	Freq. (MHz)	Emission Level (dBuV/m)	Limit (dBuV/m)	Margin (dB)	Antenna Height (m)	Table Angle (Degree)	Raw Value (dBuV)	Correction Factor (dB/m)
1	69.11	27.09 QP	40.00	-12.91	1.00 V	302	14.42	12.67
2	133.48	31.07 QP	43.50	-12.43	1.00 V	346	18.16	12.91
3	200.24	28.80 QP	43.50	-14.70	1.00 V	277	17.19	11.61
4	233.21	31.09 QP	46.00	-14.91	1.00 V	278	18.04	13.05
5	366.48	34.65 QP	46.00	-11.35	1.00 V	255	16.73	17.92
6	433.38	36.72 QP	46.00	-9.28	1.00 V	236	16.73	19.99
7	533.37	38.70 QP	46.00	-7.30	1.26 V	282	15.95	22.75
8	633.27	34.02 QP	46.00	-11.98	1.74 V	268	9.17	24.85
9	800.00	38.93 QP	46.00	-7.07	1.59 V	274	11.37	27.56
10	933.20	38.48 QP	46.00	-7.52	1.33 V	296	8.95	29.53

- REMARKS:**
1. Emission level(dBuV/m)=Raw Value(dBuV) + Correction Factor(dB/m)
 2. Correction Factor(dB/m) = Antenna Factor (dB/m) + Cable Factor (dB)
 3. The other emission levels were very low against the limit.
 4. Margin value = Emission level – Limit value



802.11a OFDM modulation

MODE	Channel 1	FREQUENCY RANGE	1 ~ 40 GHz
MODULATION TYPE	BPSK	TRANSFER RATE	6Mbps
INPUT POWER (SYSTEM)	120Vac, 60 Hz	DETECTOR FUNCTION	Peak(PK) Average (AV)
ENVIRONMENTAL CONDITIONS	15deg. C, 60%RH, 972hPa	TESTED BY	Wen Yu

ANTENNA POLARITY & TEST DISTANCE: HORIZONTAL AT 3 M

No.	Freq. (MHz)	Emission Level (dBuV/m)	Limit (dBuV/m)	Margin (dB)	Antenna Height (m)	Table Angle (Degree)	Raw Value (dBuV)	Correction Factor (dB/m)
1	#5150.00	50.50 PK	74.00	-23.50	1.75 H	160	13.90	36.60
1	#5150.00	36.60 AV	54.00	-17.40	1.75 H	160	0.00	36.60
2	*5180.00	97.60 PK			1.75 H	160	61.00	36.60
2	*5180.00	86.10 AV			1.75 H	160	49.50	36.60
3	10360.00	59.40 PK	68.30	-8.90	1.71 H	287	13.50	45.90

ANTENNA POLARITY & TEST DISTANCE: VERTICAL AT 3 M

No.	Freq. (MHz)	Emission Level (dBuV/m)	Limit (dBuV/m)	Margin (dB)	Antenna Height (m)	Table Angle (Degree)	Raw Value (dBuV)	Correction Factor (dB/m)
1	#5150.00	66.70 PK	74.00	-7.30	1.23 V	85	30.10	36.60
1	#5150.00	53.70 AV	54.00	-0.30	1.23 V	85	17.10	36.60
2	*5180.00	113.80 PK			1.23 V	85	77.20	36.60
2	*5180.00	103.20 AV			1.23 V	85	66.60	36.60
3	10360.00	62.80 PK	68.30	-5.50	1.59 V	354	16.90	45.90

- NOTE:**
1. Emission level(dBuV/m)=Raw Value(dBuV) + Correction Factor(dB/m)
 2. Correction Factor(dB/m) = Antenna Factor (dB/m) + Cable Factor (dB)
 3. The other emission levels were very low against the limit.
 4. Margin value = Emission level – Limit value
 5. "*" : Fundamental frequency
 6. "#"The radiated frequency falling in the restricted band.



MODE	Channel 4	FREQUENCY RANGE	1 ~ 40 GHz
MODULATION TYPE	BPSK	TRANSFER RATE	6Mbps
INPUT POWER (SYSTEM)	120Vac, 60 Hz	DETECTOR FUNCTION	Peak(PK) Average (AV)
ENVIRONMENTAL CONDITIONS	15deg. C, 60%RH, 972hPa	TESTED BY	Wen Yu

ANTENNA POLARITY & TEST DISTANCE: HORIZONTAL AT 3 M								
No.	Freq. (MHz)	Emission Level (dBuV/m)	Limit (dBuV/m)	Margin (dB)	Antenna Height (m)	Table Angle (Degree)	Raw Value (dBuV)	Correction Factor (dB/m)
1	*5240.00	100.90 PK			1.74 H	160	64.20	36.70
1	*5240.00	90.00 AV			1.74 H	160	53.30	36.70
2	10480.00	61.80 PK	68.30	-6.50	1.73 H	73	15.60	46.10

ANTENNA POLARITY & TEST DISTANCE: VERTICAL AT 3 M								
No.	Freq. (MHz)	Emission Level (dBuV/m)	Limit (dBuV/m)	Margin (dB)	Antenna Height (m)	Table Angle (Degree)	Raw Value (dBuV)	Correction Factor (dB/m)
1	*5240.00	117.10 PK			1.23 V	280	80.40	36.70
1	*5240.00	106.80 AV			1.23 V	280	70.10	36.70
2	10480.00	66.40 PK	68.30	-1.90	1.63 V	347	20.30	46.10

- NOTE:**
1. Emission level(dBuV/m)=Raw Value(dBuV) + Correction Factor(dB/m)
 2. Correction Factor(dB/m) = Antenna Factor (dB/m) + Cable Factor (dB)
 3. The other emission levels were very low against the limit.
 4. Margin value = Emission level – Limit value
 5. "*" : Fundamental frequency
 6. "#"The radiated frequency falling in the restricted band.



MODE	Channel 5	FREQUENCY RANGE	1 ~ 40 GHz
MODULATION TYPE	BPSK	TRANSFER RATE	6Mbps
INPUT POWER (SYSTEM)	120Vac, 60 Hz	DETECTOR FUNCTION	Peak(PK) Average (AV)
ENVIRONMENTAL CONDITIONS	15deg. C, 60%RH, 972hPa	TESTED BY	Wen Yu

ANTENNA POLARITY & TEST DISTANCE: HORIZONTAL AT 3 M								
No.	Freq. (MHz)	Emission Level (dBuV/m)	Limit (dBuV/m)	Margin (dB)	Antenna Height (m)	Table Angle (Degree)	Raw Value (dBuV)	Correction Factor (dB/m)
1	*5260.00	101.10 PK			1.84 H	175	64.40	36.70
1	*5260.00	90.60 AV			1.84 H	175	53.90	36.70
2	10520.00	61.90 PK	68.30	-6.40	1.72 H	258	15.70	46.20

ANTENNA POLARITY & TEST DISTANCE: VERTICAL AT 3 M								
No.	Freq. (MHz)	Emission Level (dBuV/m)	Limit (dBuV/m)	Margin (dB)	Antenna Height (m)	Table Angle (Degree)	Raw Value (dBuV)	Correction Factor (dB/m)
1	*5260.00	117.30 PK			1.23 V	281	80.60	36.70
1	*5260.00	106.60 AV			1.23 V	281	69.90	36.70
2	10520.00	66.50 PK	68.30	-1.80	1.53 V	358	20.30	46.20

- NOTE:**
1. Emission level(dBuV/m)=Raw Value(dBuV) + Correction Factor(dB/m)
 2. Correction Factor(dB/m) = Antenna Factor (dB/m) + Cable Factor (dB)
 3. The other emission levels were very low against the limit.
 4. Margin value = Emission level – Limit value
 5. "*" : Fundamental frequency
 6. "#"The radiated frequency falling in the restricted band.



MODE	Channel 8	FREQUENCY RANGE	1 ~ 40 GHz
MODULATION TYPE	BPSK	TRANSFER RATE	6Mbps
INPUT POWER (SYSTEM)	120Vac, 60 Hz	DETECTOR FUNCTION	Peak(PK) Average (AV)
ENVIRONMENTAL CONDITIONS	15deg. C, 60%RH, 972hPa	TESTED BY	Wen Yu

ANTENNA POLARITY & TEST DISTANCE: HORIZONTAL AT 3 M								
No.	Freq. (MHz)	Emission Level (dBuV/m)	Limit (dBuV/m)	Margin (dB)	Antenna Height (m)	Table Angle (Degree)	Raw Value (dBuV)	Correction Factor (dB/m)
1	*5320.00	97.10 PK			1.56 H	173	60.30	36.80
1	*5320.00	86.10 AV			1.56 H	173	49.30	36.80
2	#5350.00	54.40 PK	74.00	-19.60	1.56 H	173	17.60	36.80
2	#5350.00	37.00 AV	54.00	-17.00	1.56 H	173	0.20	36.80
3	#10640.00	61.10 PK	74.00	-12.90	1.63 H	290	14.80	46.30
3	#10640.00	46.70 AV	54.00	-7.30	1.63 H	290	0.40	46.30

ANTENNA POLARITY & TEST DISTANCE: VERTICAL AT 3 M								
No.	Freq. (MHz)	Emission Level (dBuV/m)	Limit (dBuV/m)	Margin (dB)	Antenna Height (m)	Table Angle (Degree)	Raw Value (dBuV)	Correction Factor (dB/m)
1	*5320.00	115.80 PK			1.21 V	252	79.00	36.80
1	*5320.00	102.80 AV			1.21 V	252	66.00	36.80
2	#5350.00	73.00 PK	74.00	-1.00	1.21 V	252	36.20	36.80
2	#5350.00	53.70 AV	54.00	-0.30	1.21 V	252	16.90	36.80
3	#10640.00	67.60 PK	74.00	-6.40	1.60 V	350	21.30	46.30
3	#10640.00	53.70 AV	54.00	-0.30	1.60 V	350	7.40	46.30

- NOTE:**
1. Emission level(dBuV/m)=Raw Value(dBuV) + Correction Factor(dB/m)
 2. Correction Factor(dB/m) = Antenna Factor (dB/m) + Cable Factor (dB)
 3. The other emission levels were very low against the limit.
 4. Margin value = Emission level – Limit value
 5. "*" : Fundamental frequency
 6. "#" The radiated frequency falling in the restricted band.



MODE	Channel 9	FREQUENCY RANGE	1 ~ 40 GHz
MODULATION TYPE	BPSK	TRANSFER RATE	6Mbps
INPUT POWER (SYSTEM)	120Vac, 60 Hz	DETECTOR FUNCTION	Peak(PK) Average (AV)
ENVIRONMENTAL CONDITIONS	15deg. C, 60%RH, 972hPa	TESTED BY	Wen Yu

ANTENNA POLARITY & TEST DISTANCE: HORIZONTAL AT 3 M

No.	Freq. (MHz)	Emission Level (dBuV/m)	Limit (dBuV/m)	Margin (dB)	Antenna Height (m)	Table Angle (Degree)	Raw Value (dBuV)	Correction Factor (dB/m)
1	#5460.00	44.00 PK	74.00	-30.00	1.78 H	282	7.02	36.98
1	#5460.00	35.80 AV	54.00	-18.20	1.78 H	282	-1.18	36.98
2	5470.00	55.40 PK	68.30	-12.90	1.78 H	282	18.41	36.99
3	*5500.00	96.70 PK			1.78 H	282	59.67	37.03
3	*5500.00	86.10 AV			1.78 H	282	49.07	37.03
4	#11000.00	61.11 PK	74.00	-12.89	1.78 H	336	14.46	46.65
4	#11000.00	48.01 AV	54.00	-5.99	1.78 H	336	1.36	46.65

ANTENNA POLARITY & TEST DISTANCE: VERTICAL AT 3 M

No.	Freq. (MHz)	Emission Level (dBuV/m)	Limit (dBuV/m)	Margin (dB)	Antenna Height (m)	Table Angle (Degree)	Raw Value (dBuV)	Correction Factor (dB/m)
1	#5460.00	59.90 PK	74.00	-14.10	1.23 V	281	22.92	36.98
1	#5460.00	51.50 AV	54.00	-2.50	1.23 V	281	14.52	36.98
2	5470.00	67.80 PK	68.30	-0.50	1.23 V	281	30.81	36.99
3	*5500.00	112.60 PK			1.23 V	281	75.57	37.03
3	*5500.00	101.80 AV			1.23 V	281	64.77	37.03
4	#11000.00	66.70 PK	74.00	-7.30	1.44 V	77	20.05	46.65
4	#11000.00	53.25 AV	54.00	-0.75	1.44 V	77	6.60	46.65

- NOTE:**
1. Emission level(dBuV/m)=Raw Value(dBuV) + Correction Factor(dB/m)
 2. Correction Factor(dB/m) = Antenna Factor (dB/m) + Cable Factor (dB)
 3. The other emission levels were very low against the limit.
 4. Margin value = Emission level – Limit value
 5. "*" : Fundamental frequency
 6. "#"The radiated frequency falling in the restricted band.

MODE	Channel 14	FREQUENCY RANGE	1 ~ 40 GHz
MODULATION TYPE	BPSK	TRANSFER RATE	6Mbps
INPUT POWER (SYSTEM)	120Vac, 60 Hz	DETECTOR FUNCTION	Peak(PK) Average (AV)
ENVIRONMENTAL CONDITIONS	15deg. C, 60%RH, 972hPa	TESTED BY	Wen Yu

ANTENNA POLARITY & TEST DISTANCE: HORIZONTAL AT 3 M

No.	Freq. (MHz)	Emission Level (dBuV/m)	Limit (dBuV/m)	Margin (dB)	Antenna Height (m)	Table Angle (Degree)	Raw Value (dBuV)	Correction Factor (dB/m)
1	*5600.00	99.10 PK			1.78 H	281	61.80	37.30
1	*5600.00	88.20 AV			1.78 H	281	50.90	37.30
2	#11200.00	61.20 PK	74.00	-12.80	1.61 H	329	14.40	46.80
2	#11200.00	47.80 AV	54.00	-6.20	1.61 H	329	1.00	46.80

ANTENNA POLARITY & TEST DISTANCE: VERTICAL AT 3 M

No.	Freq. (MHz)	Emission Level (dBuV/m)	Limit (dBuV/m)	Margin (dB)	Antenna Height (m)	Table Angle (Degree)	Raw Value (dBuV)	Correction Factor (dB/m)
1	*5600.00	116.60 PK			1.22 V	270	79.30	37.30
1	*5600.00	106.20 AV			1.22 V	270	68.90	37.30
2	#11200.00	66.90 PK	74.00	-7.10	1.40 V	99	20.10	46.80
2	#11200.00	53.70 AV	54.00	-0.30	1.40 V	99	6.90	46.80

- NOTE:**
1. Emission level(dBuV/m)=Raw Value(dBuV) + Correction Factor(dB/m)
 2. Correction Factor(dB/m) = Antenna Factor (dB/m) + Cable Factor (dB)
 3. The other emission levels were very low against the limit.
 4. Margin value = Emission level – Limit value
 5. "*" : Fundamental frequency
 6. "#"The radiated frequency falling in the restricted band.



MODE	Channel 19	FREQUENCY RANGE	1 ~ 40 GHz
MODULATION TYPE	BPSK	TRANSFER RATE	6Mbps
INPUT POWER (SYSTEM)	120Vac, 60 Hz	DETECTOR FUNCTION	Peak(PK) Average (AV)
ENVIRONMENTAL CONDITIONS	15deg. C, 60%RH, 972hPa	TESTED BY	Wen Yu

ANTENNA POLARITY & TEST DISTANCE: HORIZONTAL AT 3 M

No.	Freq. (MHz)	Emission Level (dBuV/m)	Limit (dBuV/m)	Margin (dB)	Antenna Height (m)	Table Angle (Degree)	Raw Value (dBuV)	Correction Factor (dB/m)
1	*5700.00	95.40 PK			1.77 H	252	57.87	37.53
1	*5700.00	84.20 AV			1.77 H	252	46.67	37.53
2	5725.00	54.70 PK	68.30	-13.60	1.77 H	252	17.11	37.59
3	#11400.00	58.55 PK	74.00	-15.45	1.77 H	305	11.60	46.95
3	#11400.00	45.55 AV	54.00	-8.45	1.77 H	305	-1.40	46.95

ANTENNA POLARITY & TEST DISTANCE: VERTICAL AT 3 M

No.	Freq. (MHz)	Emission Level (dBuV/m)	Limit (dBuV/m)	Margin (dB)	Antenna Height (m)	Table Angle (Degree)	Raw Value (dBuV)	Correction Factor (dB/m)
1	*5700.00	110.90 PK			1.20 V	269	73.37	37.53
1	*5700.00	100.50 AV			1.20 V	269	62.97	37.53
2	5725.00	67.90 PK	68.30	-0.40	1.20 V	269	30.31	37.59
3	#11400.00	64.10 PK	74.00	-9.90	1.36 V	93	17.15	46.95
3	#11400.00	51.80 AV	54.00	-2.20	1.36 V	93	4.85	46.95

- NOTE:**
1. Emission level(dBuV/m)=Raw Value(dBuV) + Correction Factor(dB/m)
 2. Correction Factor(dB/m) = Antenna Factor (dB/m) + Cable Factor (dB)
 3. The other emission levels were very low against the limit.
 4. Margin value = Emission level – Limit value
 5. "*" : Fundamental frequency
 6. "#"The radiated frequency falling in the restricted band.



4.3 PEAK TRANSMIT POWER MEASUREMENT

4.3.1 LIMITS OF PEAK TRANSMIT POWER MEASUREMENT

Frequency Band	Limit
5.15 – 5.25GHz	The lesser of 50mW (17dBm) or 4dBm + 10logB
5.25 – 5.35GHz	The lesser of 250mW (24dBm) or 11dBm + 10logB
5.47 – 5.725GHz	The lesser of 250mW (24dBm) or 11dBm + 10logB
5.725 – 5.825GHz	The lesser of 1W (30dBm) or 17dBm + 10logB

NOTE: Where B is the 26dB emission bandwidth in MHz.

4.3.2 TEST INSTRUMENTS

Description & Manufacturer	Model No.	Serial No.	Calibrated Until
ADVANTEST SPECTRUM ANALYZER	U3772	160100280	April. 10.2007

NOTE:

- 1.The measurement uncertainty is less than +/- 2.6dB, which is calculated as per the NAMAS document NIS81.
- 2.The calibration interval of the above test instruments is 12 months and the calibrations are traceable to NML/ROC and NIST/USA.

4.3.3 TEST PROCEDURE

1. The transmitter output was connected to the spectrum analyzer.
2. Set span to encompass the entire emission bandwidth of the signal.
3. Set RBW to 1MHz, VBW to 300kHz.
4. Using the spectrum analyzer's channel power measurement function to measure the output power.

NOTE:

The test is performed in accordance with FCC Public Notice: APPENDIX A Guidelines for Assessing Unlicensed National Information Infrastructure (U-NII) Devices – Part 15, Subpart E, August 2002.

The transmitter output operates continuously therefore Method # 1 is used.

4.3.4 DEVIATION FROM TEST STANDARD

No deviation

4.3.5 TEST SETUP

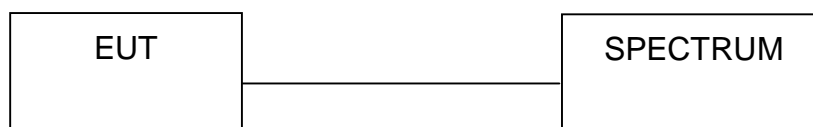

4.3.6 EUT OPERATING CONDITIONS

The software provided by client to enable the EUT under transmission condition continuously at specific channel frequencies individually.



4.3.7 TEST RESULTS

802.11a OFDM modulation

MODULATION TYPE	BPSK	TRANSFER RATE	6Mbps
INPUT POWER (SYSTEM)	120Vac, 60 Hz	ENVIRONMENTAL CONDITIONS	15deg.C, 65%RH, 972hPa
TESTED BY	Wen Yu		

CHANNEL	CHANNEL FREQUENCY (MHz)	PEAK POWER OUTPUT (dBm)	PEAK POWER OUTPUT (mW)	PEAK POWER LIMIT (dBm)	26dBc Occupied Bandwidth (MHz)	PASS/FAIL
1	5180	11.91	15.524	17	21.35	PASS
4	5240	14.32	27.040	17	23.03	PASS
5	5260	15.42	34.834	24	25.83	PASS
8	5320	12.18	16.520	24	20.82	PASS
9	5500	12.4	17.378	24	20.75	PASS
14	5600	14.04	25.351	24	23.55	PASS
19	5700	8.2	6.607	24	20.79	PASS

NOTE: The 26dBc Occupied Bandwidth plot, please refer to the following pages.

Peak Power Output:
CH1



CH4



CH5

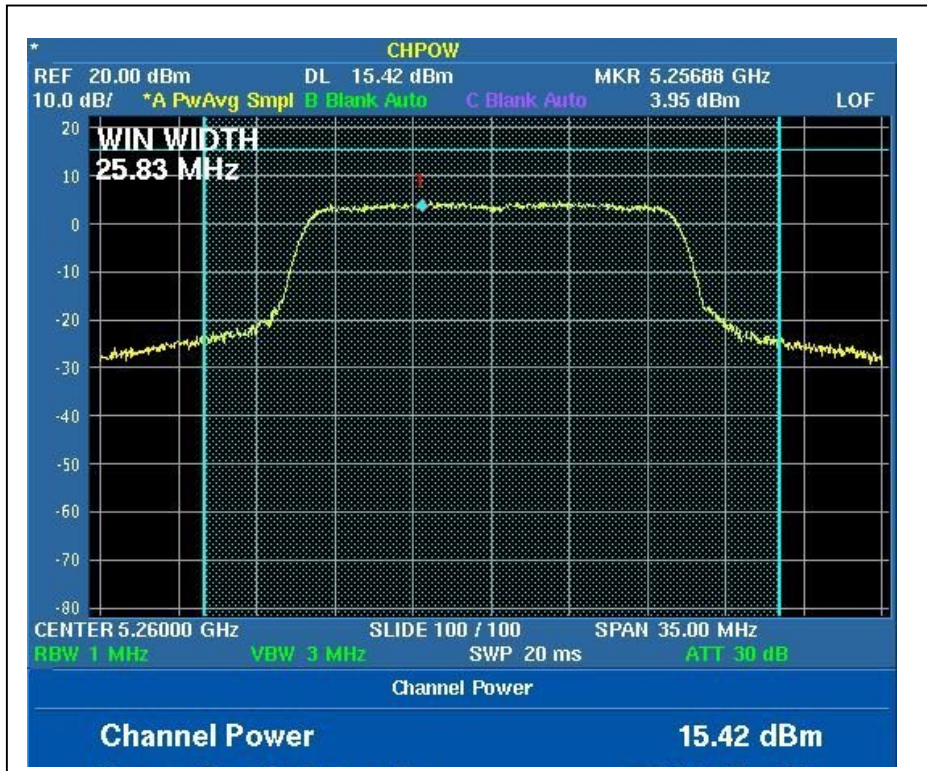

CH8



CH9

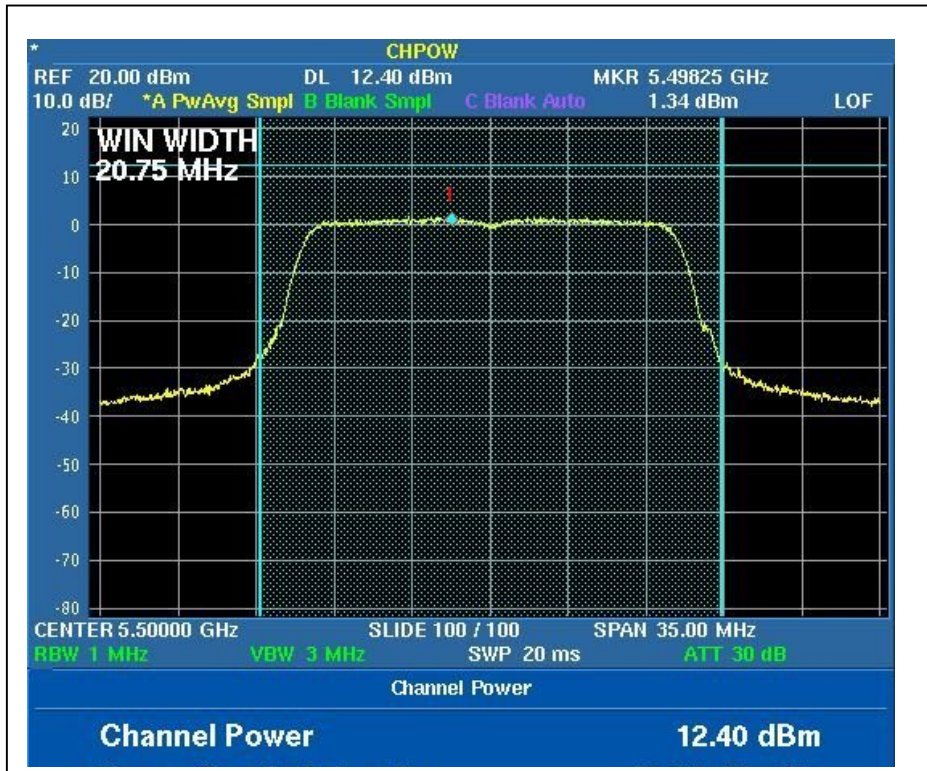

CH14



CH19

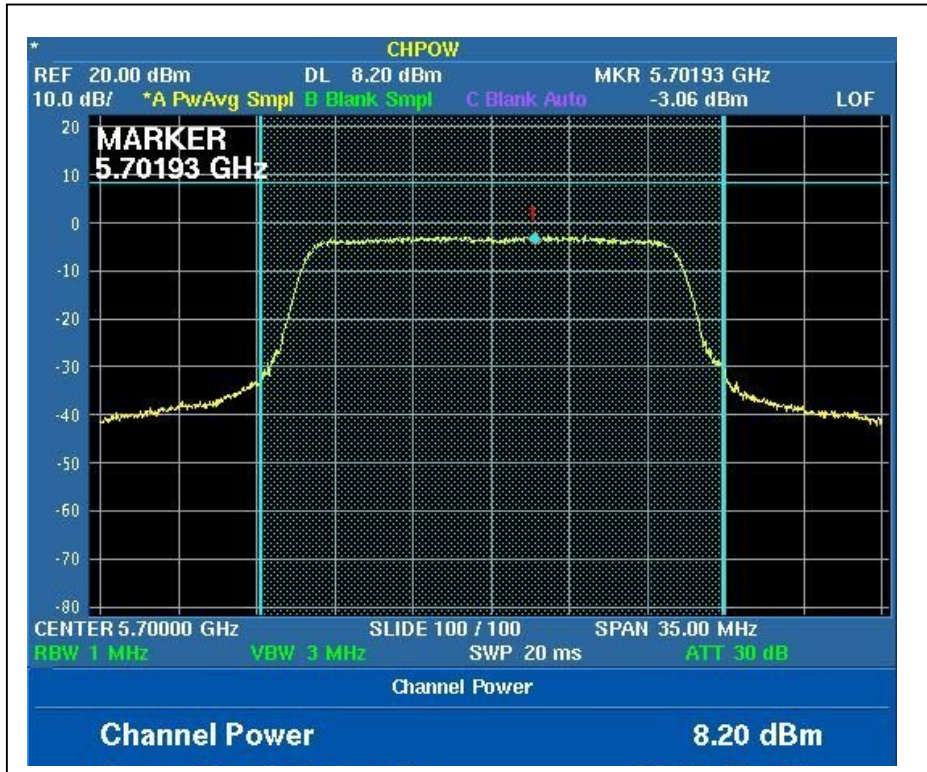

26dB Occupied Bandwidth:
CH1

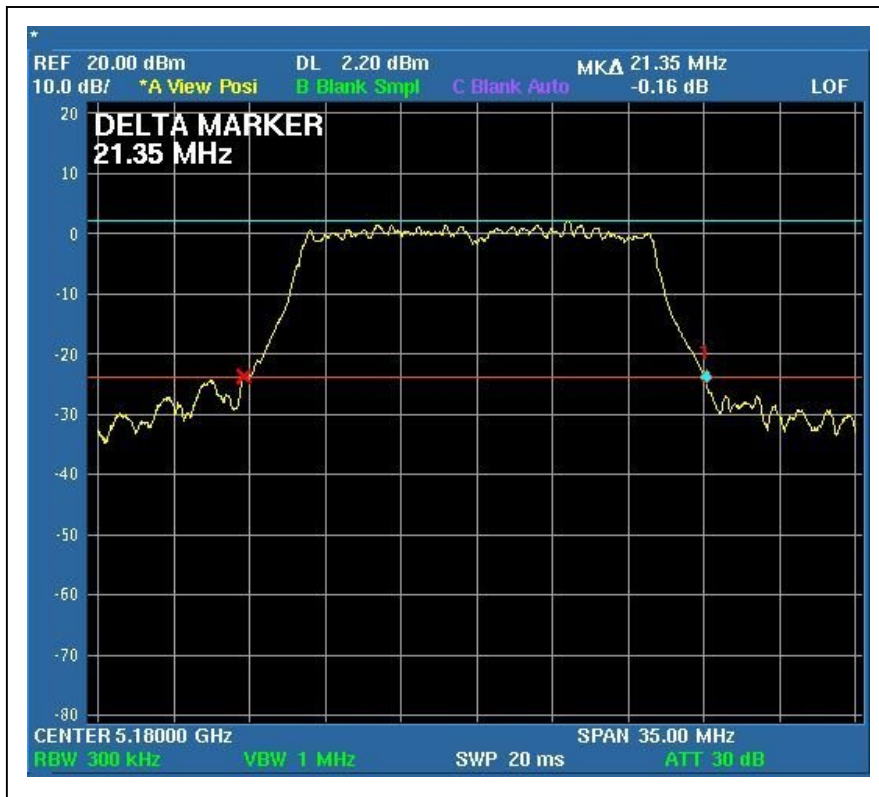

CH4

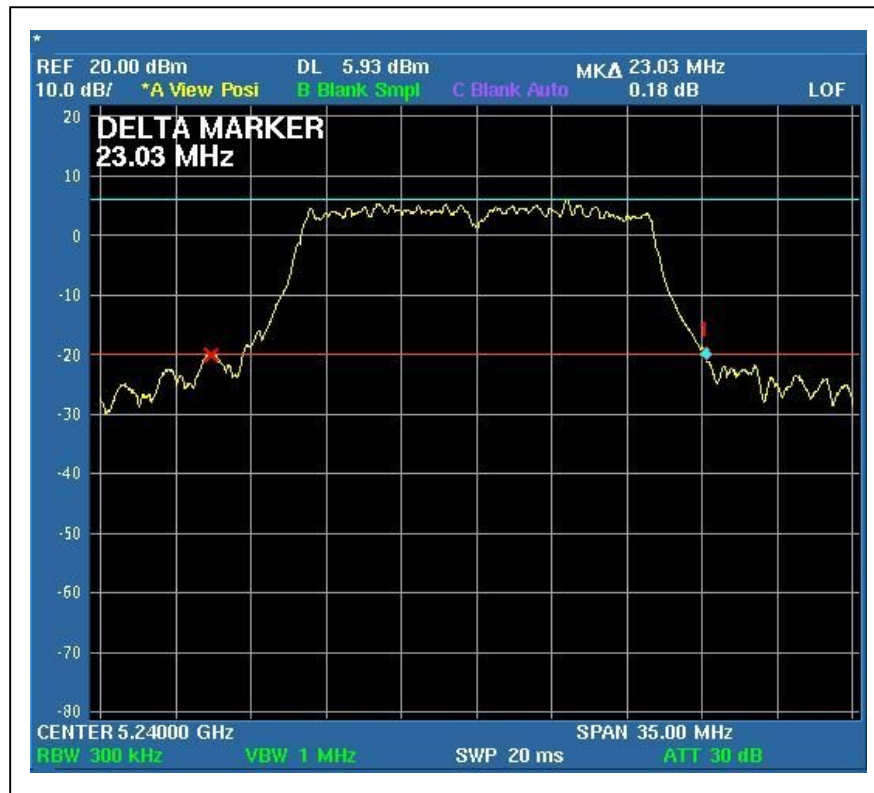

CH5

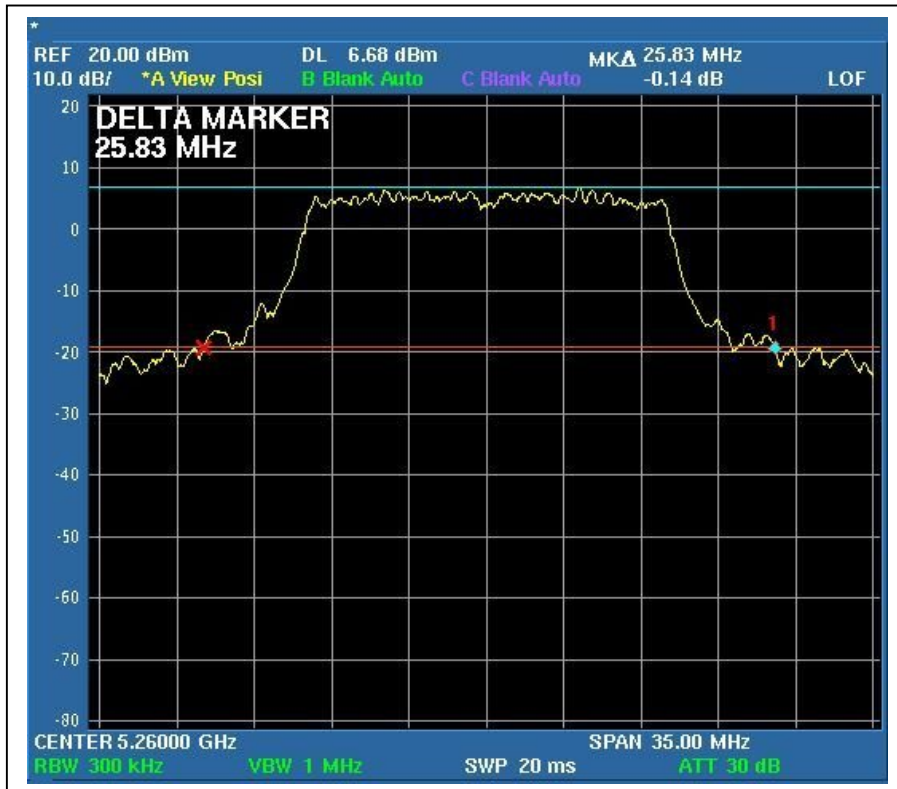

CH8

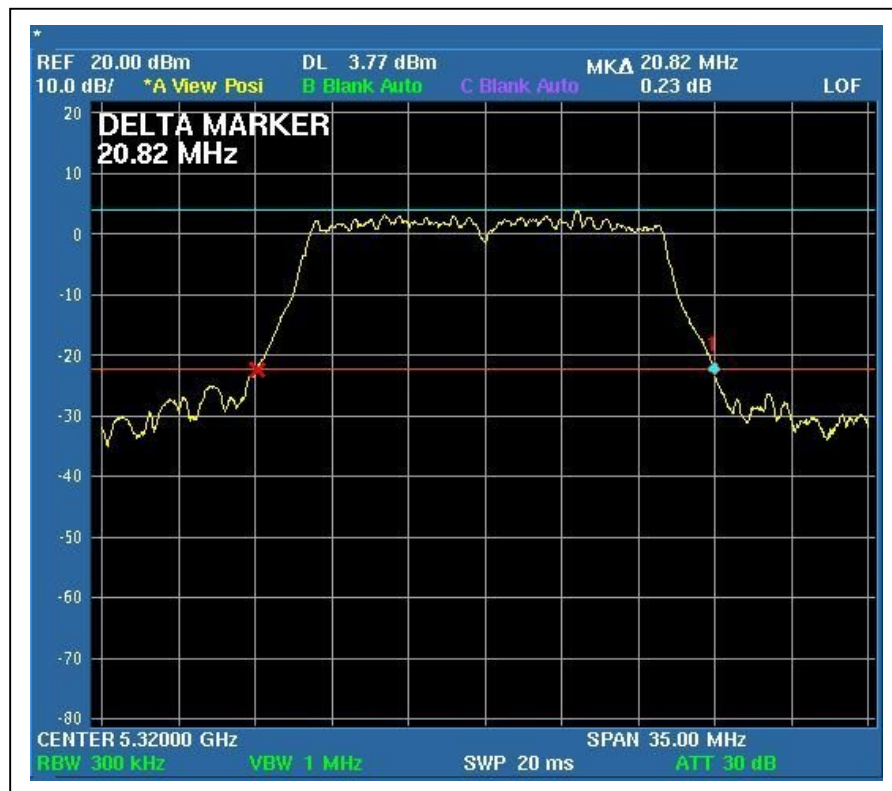

CH9

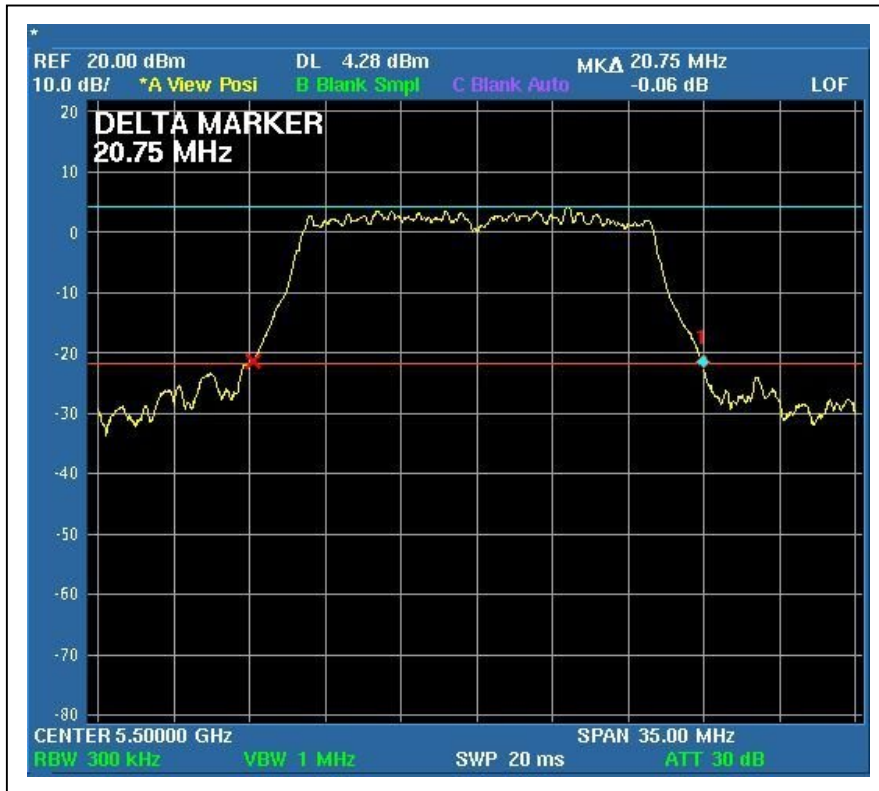

CH14

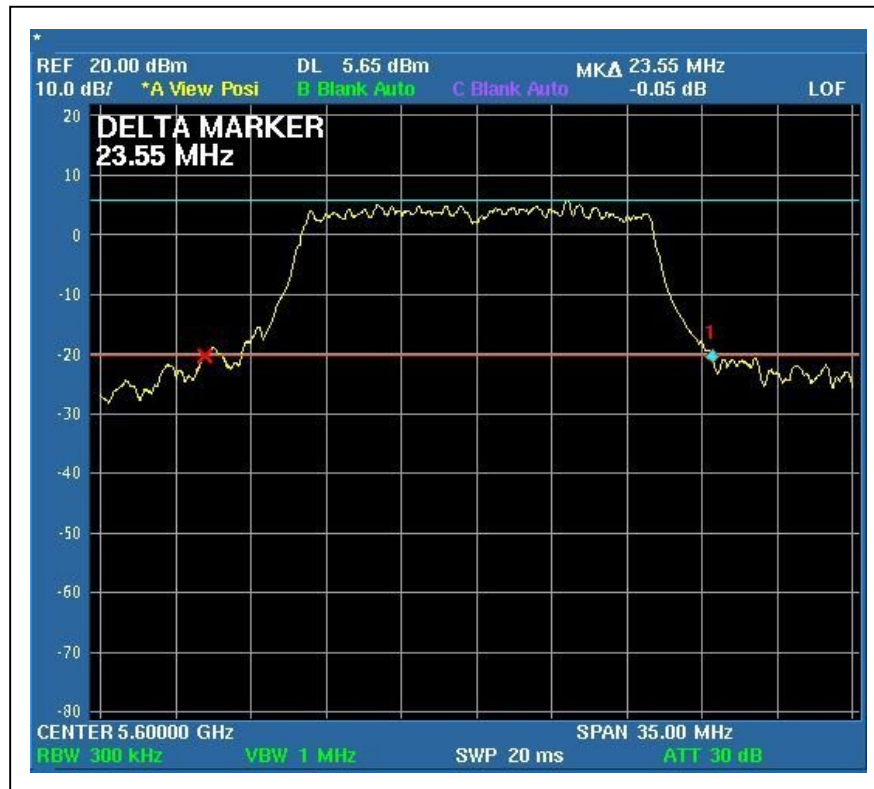

CH19

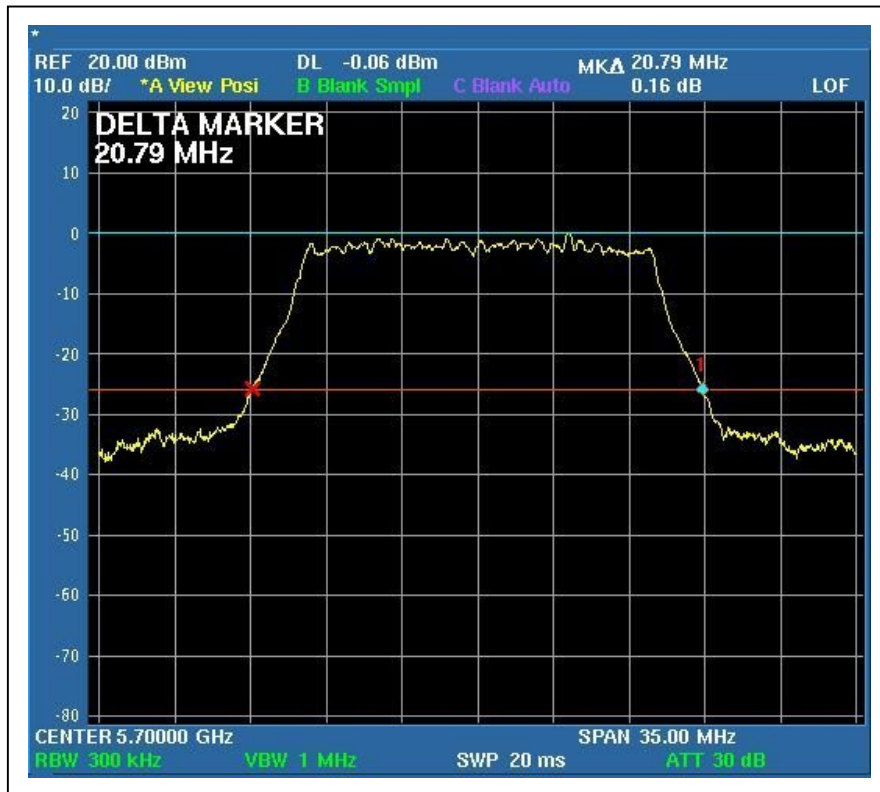

4.4 PEAK POWER EXCURSION MEASUREMENT

4.4.1 LIMITS OF PEAK POWER EXCURSION MEASUREMENT

Frequency Band	Limit
5.15 – 5.25 GHz	13dB
5.25 – 5.35 GHz	13dB
5.47 – 5.725GHz	13dB
5.725 – 5.825 GHz	13dB

4.4.2 TEST INSTRUMENTS

Description & Manufacturer	Model No.	Serial No.	Calibrated Until
ADVANTEST SPECTRUM ANALYZER	U3772	160100280	April. 10.2007

NOTE:

- 1.The measurement uncertainty is less than +/- 2.6dB, which is calculated as per the NAMAS document NIS81.
- 2.The calibration interval of the above test instruments is 12 months and the calibrations are traceable to NML/ROC and NIST/USA.

4.4.3 TEST PROCEDURE

1. The transmitter output was connected to the spectrum analyzer.
2. Set the spectrum bandwidth span to view the entire spectrum.
3. Using peak detector and Max-hold function for Trace 1 (RB=1MHz, VB=3MHz) and 2 (RB=1MHz, VB=300KHz).
4. The largest difference between Trace 1 and Trace 2 in any 1MHz band on any frequency was recorded.

4.4.4 DEVIATION FROM TEST STANDARD

No deviation

4.4.5 TEST SETUP

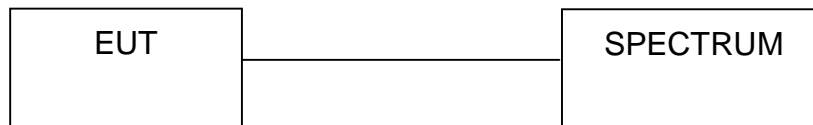

4.4.6 EUT OPERATING CONDITIONS

The software provided by client to enable the EUT under transmission condition continuously at specific channel frequencies individually.



4.4.7 TEST RESULTS

802.11a OFDM modulation

MODULATION TYPE	BPSK	TRANSFER RATE	6Mbps
INPUT POWER (SYSTEM)	120Vac, 60 Hz	ENVIRONMENTAL CONDITIONS	15deg.C, 65%RH, 972hPa
TESTED BY	Wen Yu		

CHANNEL	CHANNEL FREQUENCY (MHz)	PEAK POWER EXCURSION (dB)	PEAK to AVERAGE EXCURSION LIMIT (dB)	PASS/FAIL
1	5180	9.61	13	PASS
4	5240	9.51	13	PASS
5	5260	9.24	13	PASS
8	5320	9.37	13	PASS
9	5500	9.76	13	PASS
14	5600	9.75	13	PASS
19	5700	8.81	13	PASS

CH1

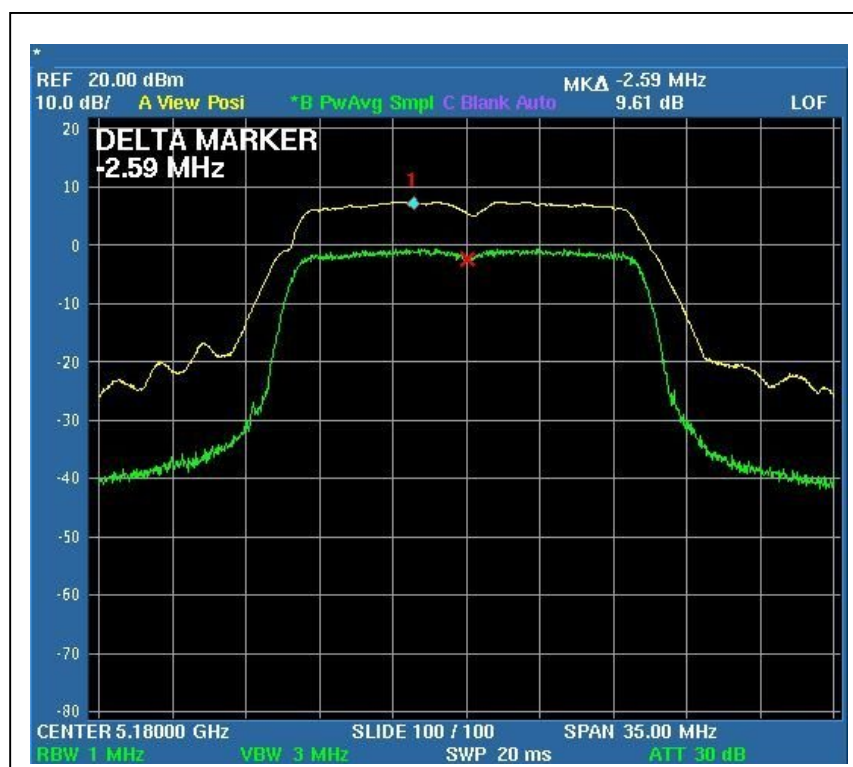

CH4

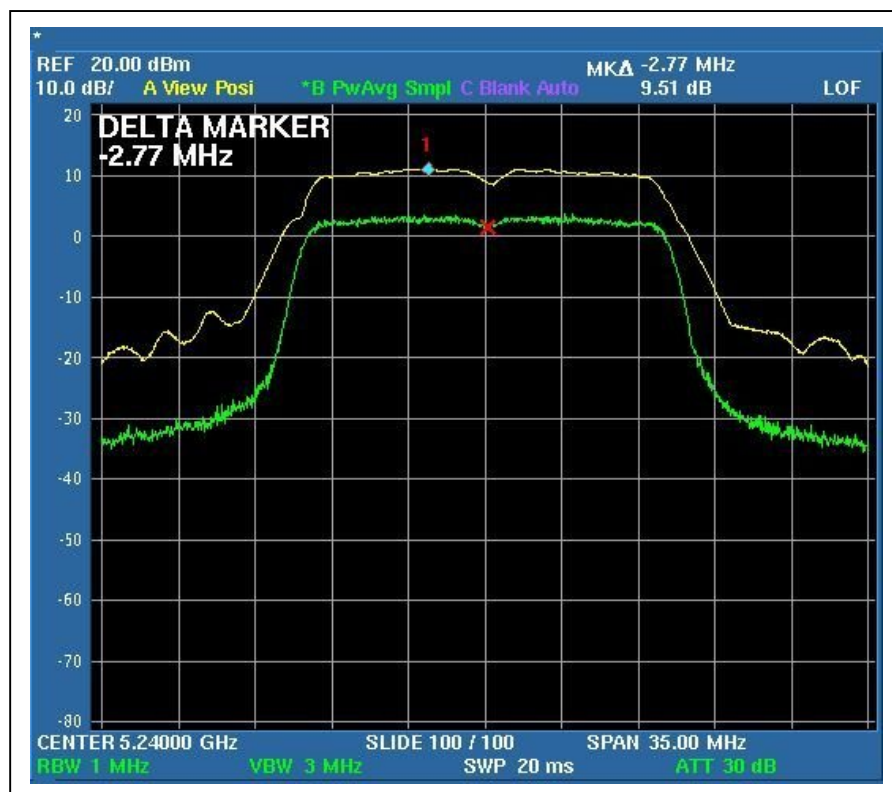

CH5

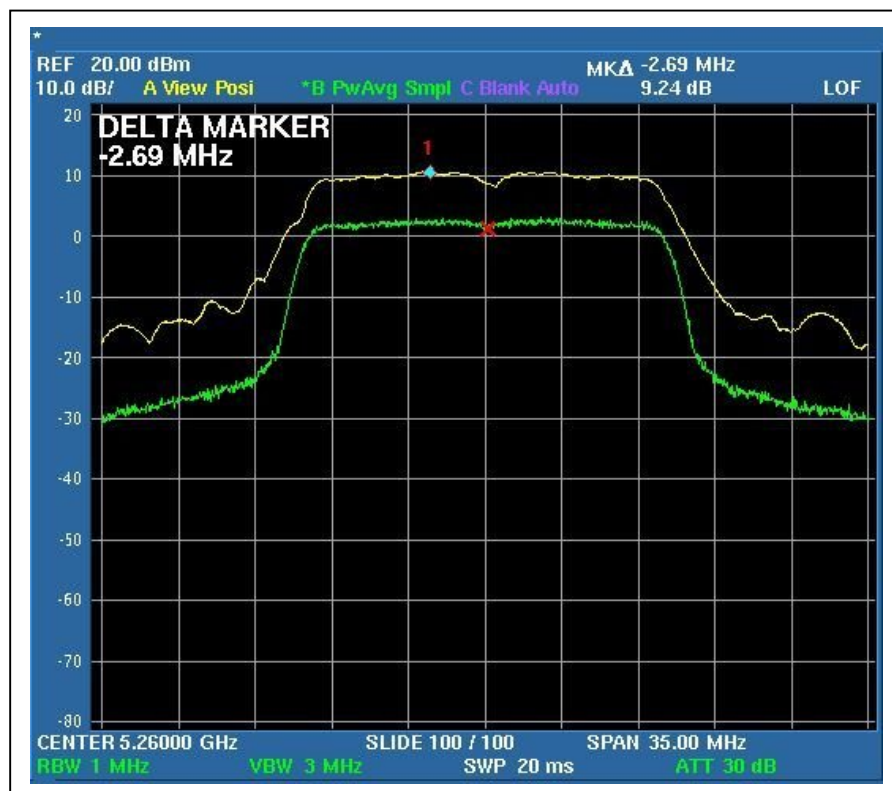

CH8

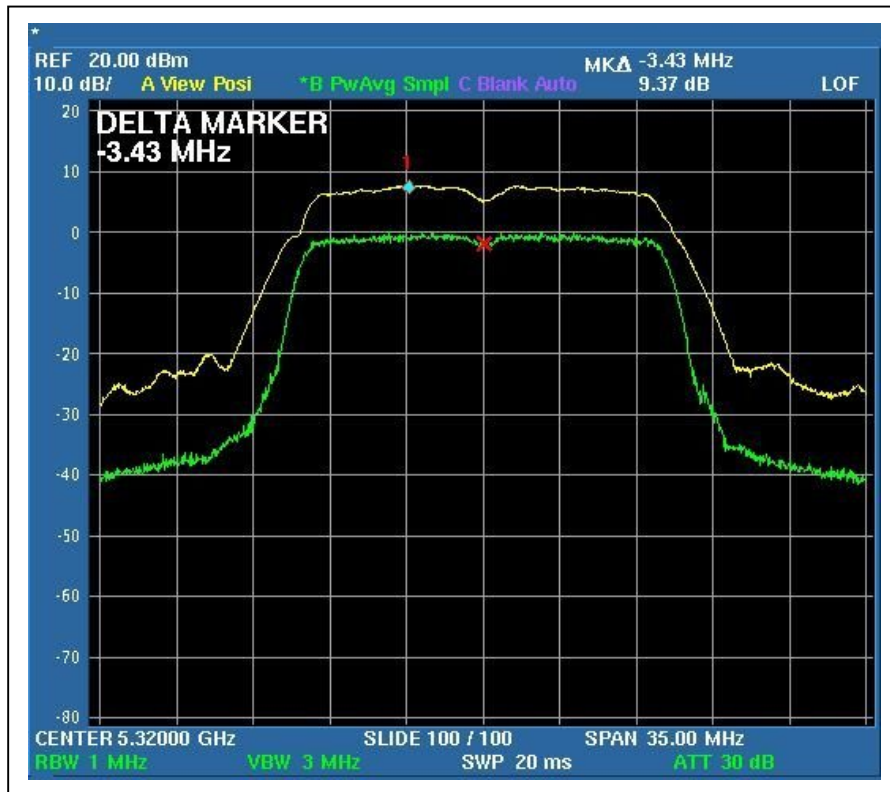

CH9

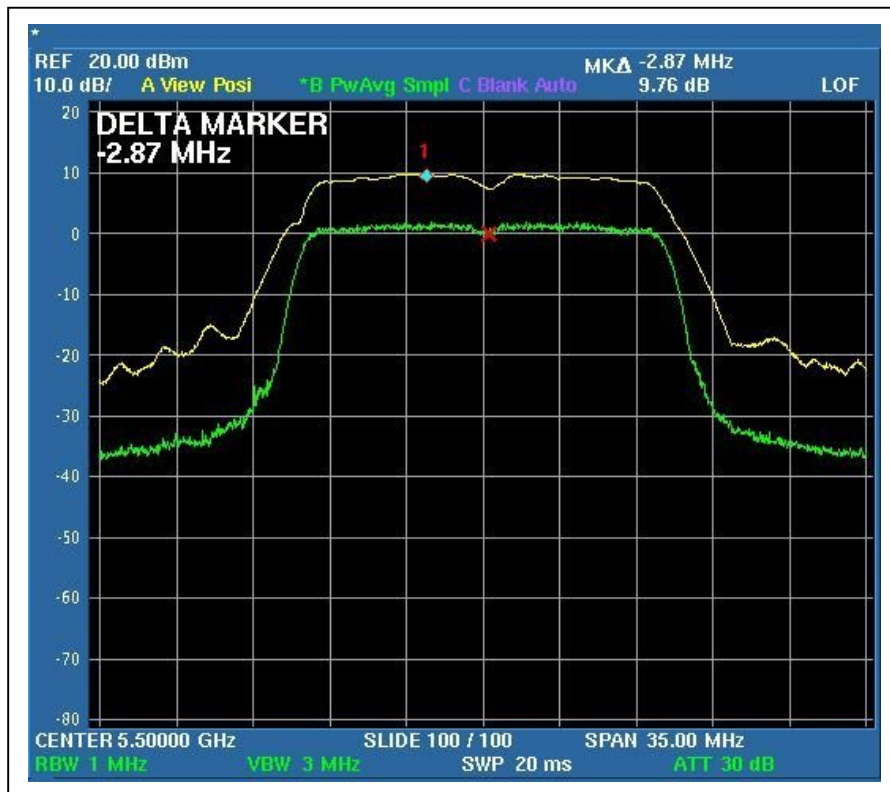

CH14

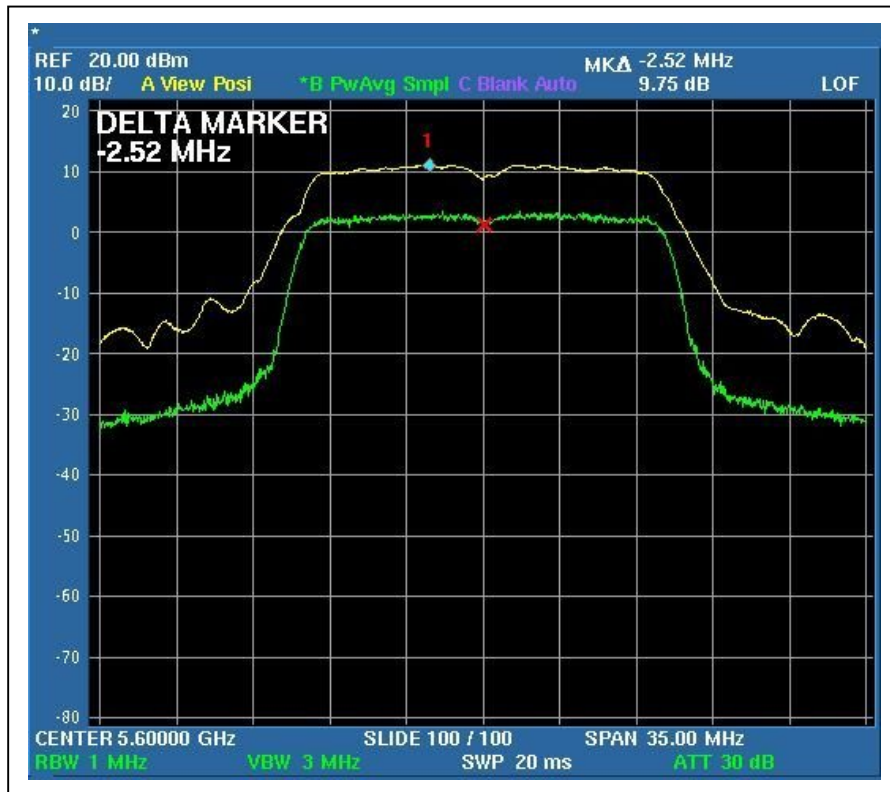

CH19

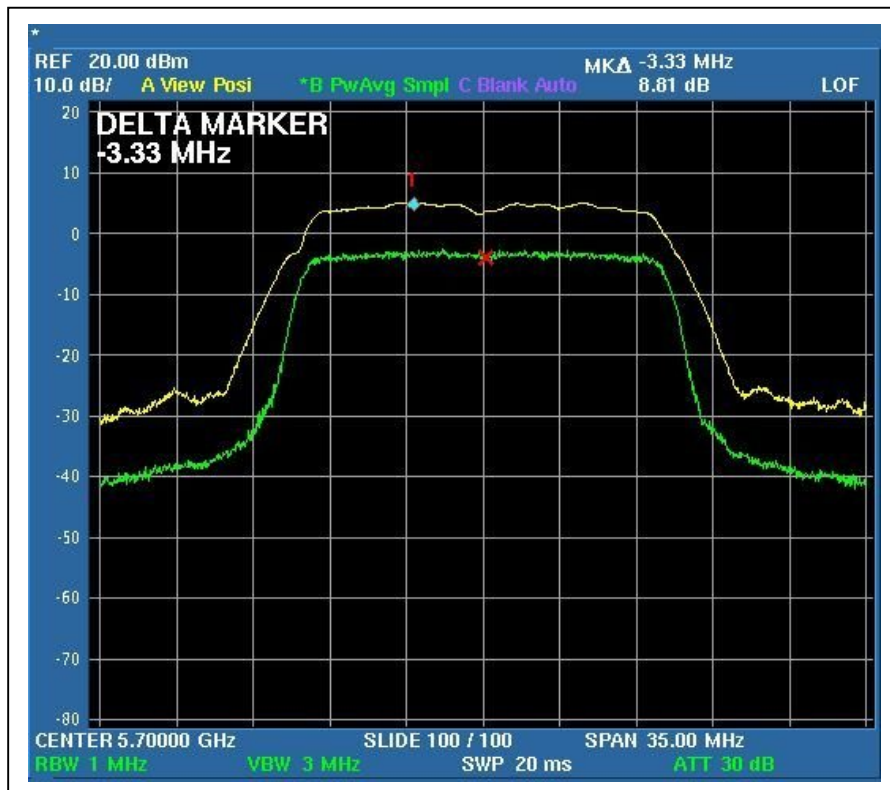

4.5 PEAK POWER SPECTRAL DENSITY MEASUREMENT

4.5.1 LIMITS OF PEAK POWER SPECTRAL DENSITY MEASUREMENT

Frequency Band	Limit
5.15 ~ 5.25GHz	4dBm
5.25 ~ 5.35GHz	11dBm
5.47 – 5.725GHz	11dBm
5.725 ~ 5.825GHz	17dBm

4.5.2 TEST INSTRUMENTS

Description & Manufacturer	Model No.	Serial No.	Calibrated Until
ADVANTEST SPECTRUM ANALYZER	U3772	160100280	April. 10.2007

NOTE:

- 1.The measurement uncertainty is less than +/- 2.6dB, which is calculated as per the NAMAS document NIS81.
- 2.The calibration interval of the above test instruments is 12 months and the calibrations are traceable to NML/ROC and NIST/USA.

4.5.3 TEST PROCEDURES

1. The transmitter output was connected to the spectrum analyzer.
2. Set RBW=1MHz, VBW=3MHz. The PPSD is the highest level found across the emission in any 1MHz band.

4.5.4 DEVIATION FROM TEST STANDARD

No deviation

4.5.5 TEST SETUP

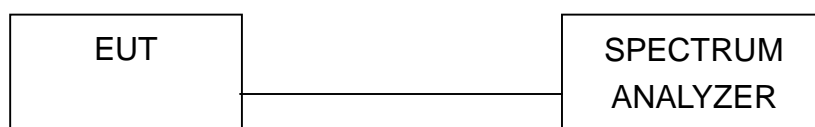

4.5.6 EUT OPERATING CONDITIONS

Same as 4.3.6

4.5.7 TEST RESULTS

802.11a OFDM modulation

MODULATION TYPE	BPSK	TRANSFER RATE	6Mbps
INPUT POWER (SYSTEM)	120Vac, 60 Hz	ENVIRONMENTAL CONDITIONS	15deg.C, 65%RH, 972hPa
TESTED BY	Wen Yu		

CHANNEL	CHANNEL FREQUENCY (MHz)	RF POWER LEVEL IN 1MHz BW (dBm)	MAXIMUM LIMIT (dBm)	PASS/FAIL
1	5180	2.12	4	PASS
4	5240	3.61	4	PASS
5	5260	5.31	11	PASS
8	5320	1.66	11	PASS
9	5500	1.56	11	PASS
14	5600	3.54	11	PASS
19	5700	-2.54	11	PASS

CH1

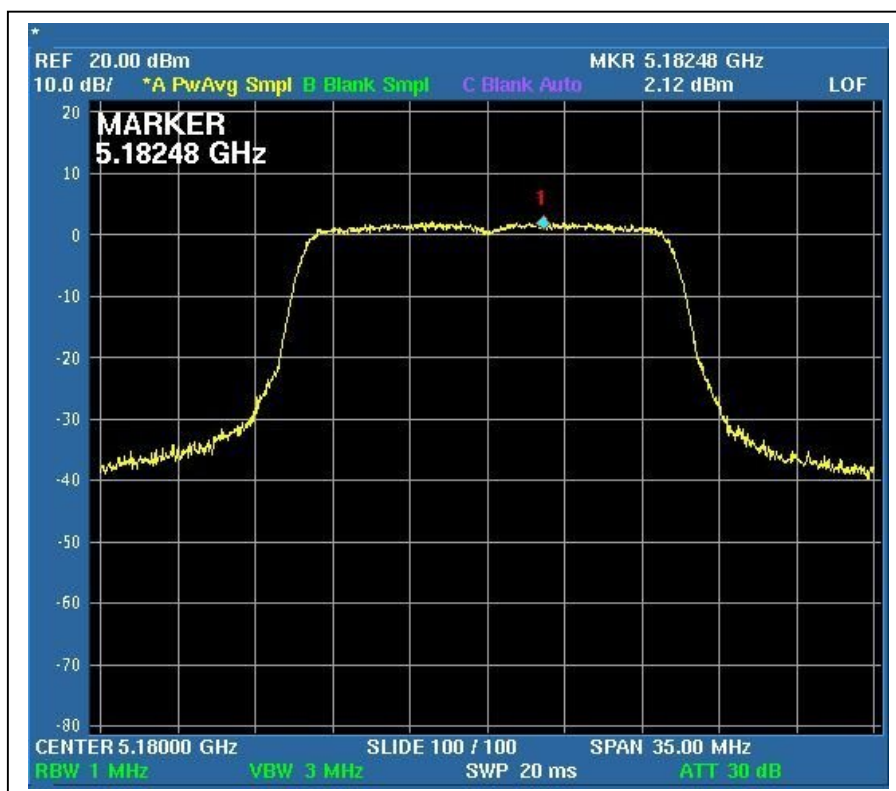

CH4

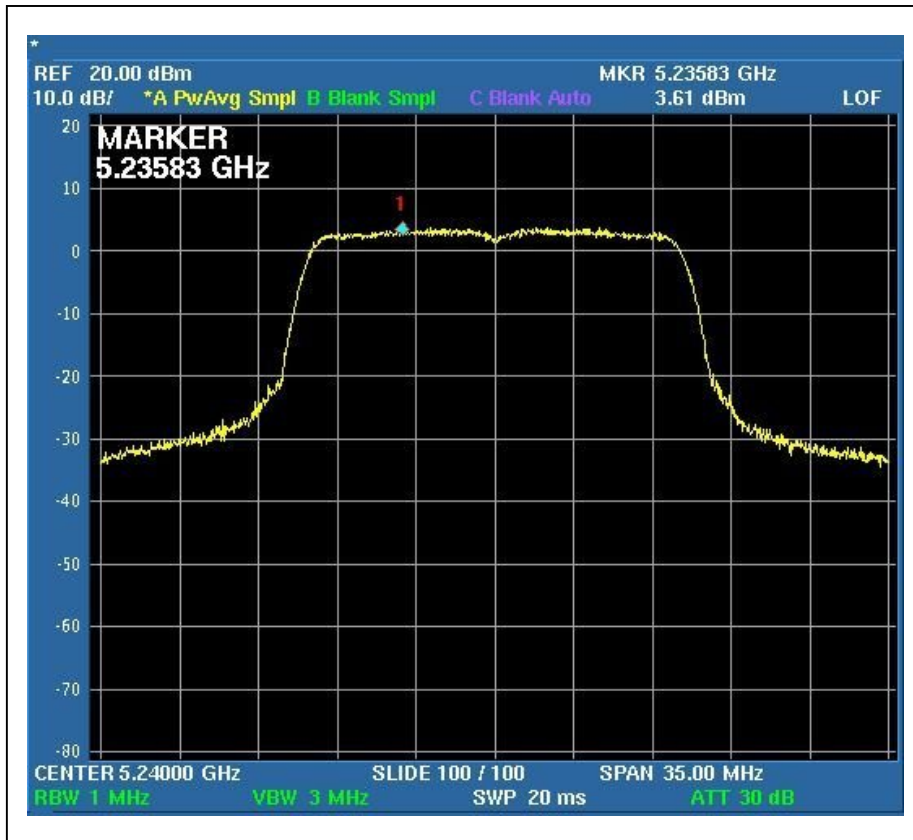

CH5

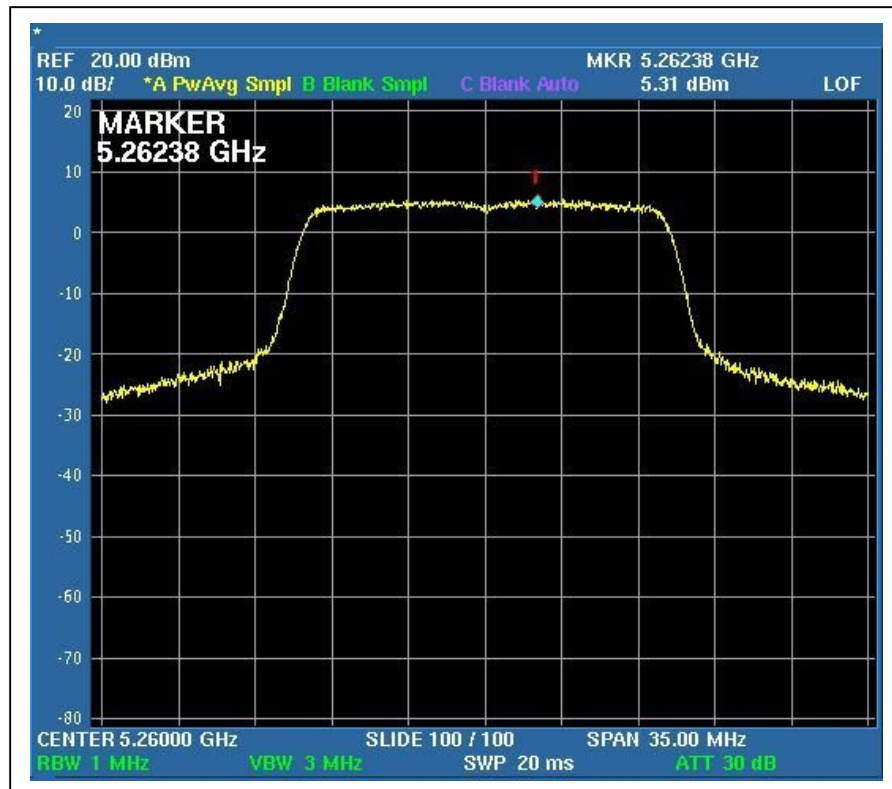

CH8

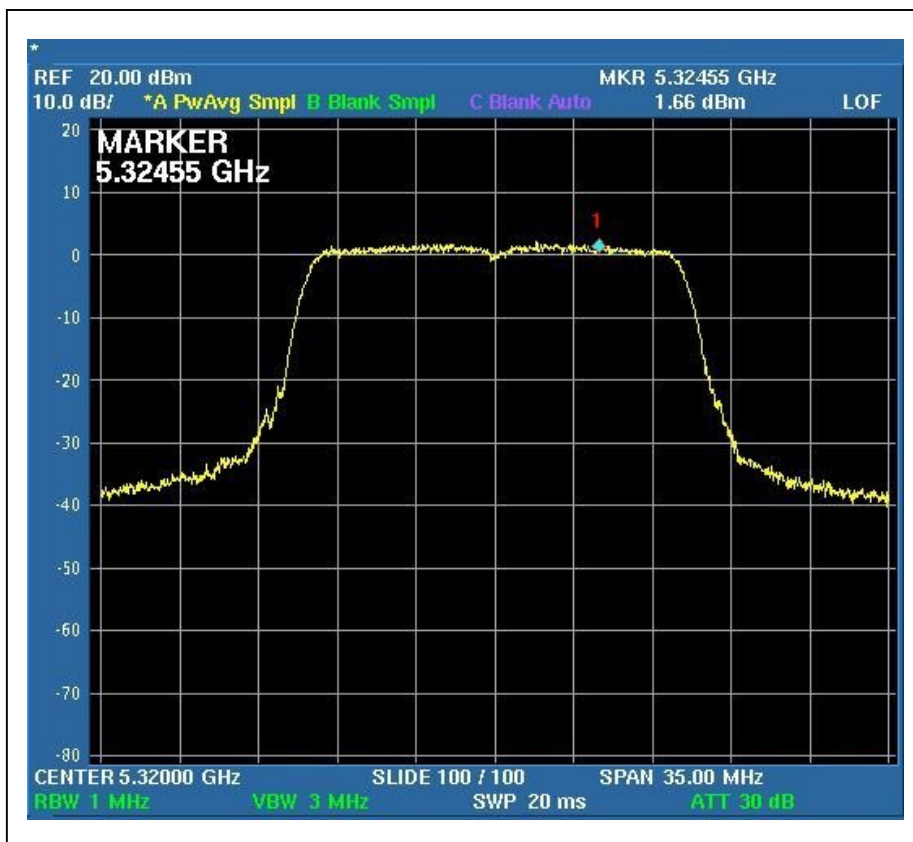

CH9

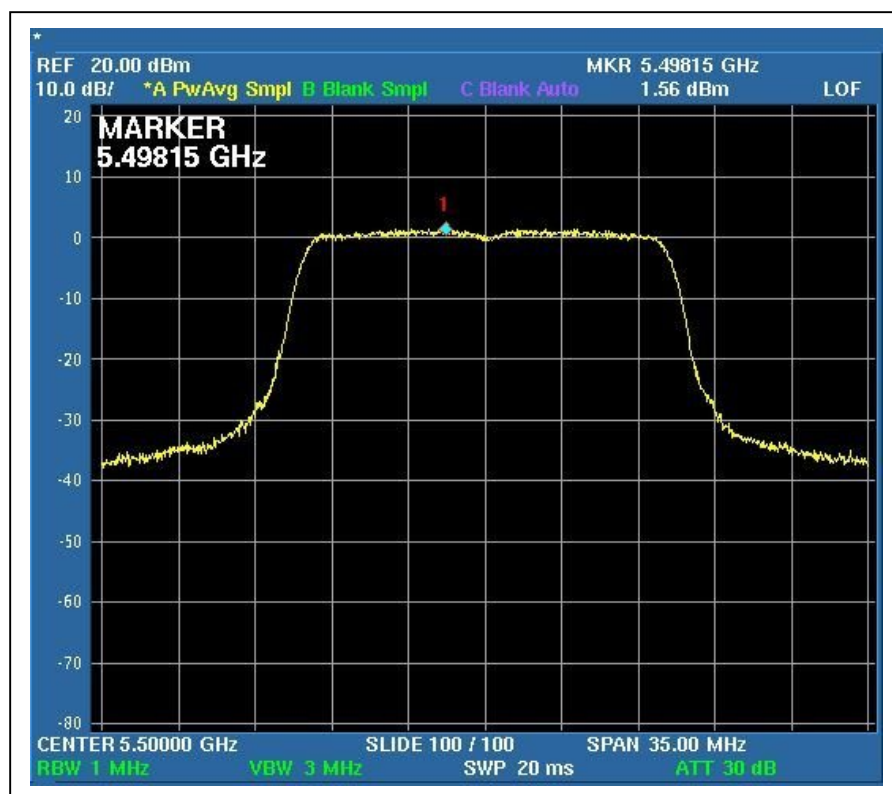

CH14

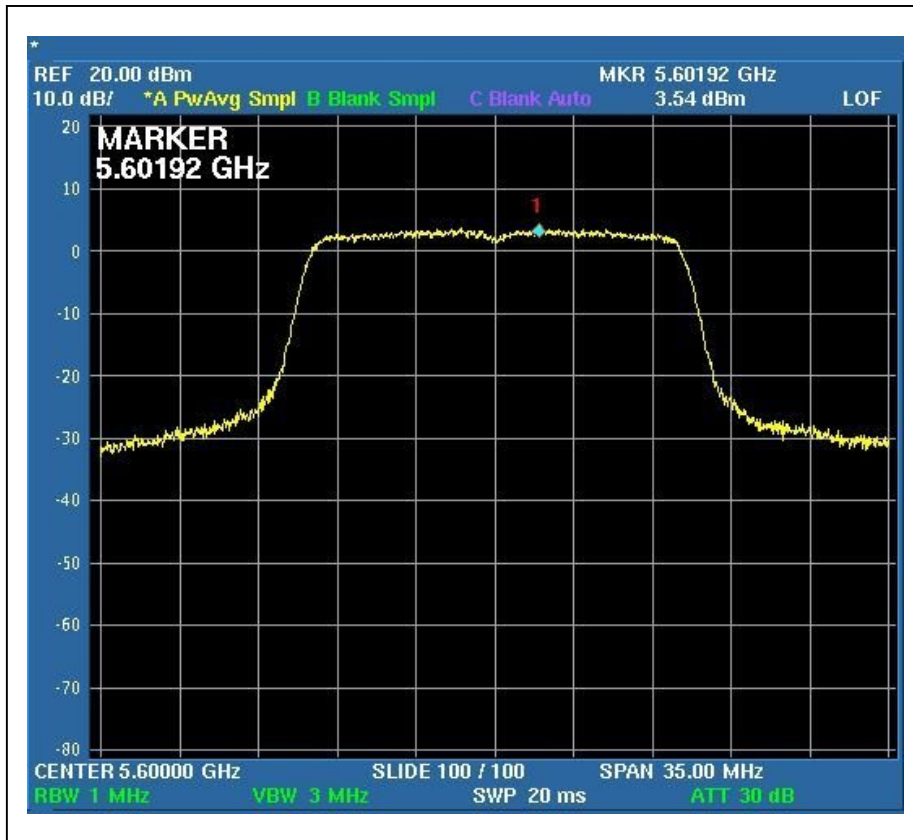

CH19

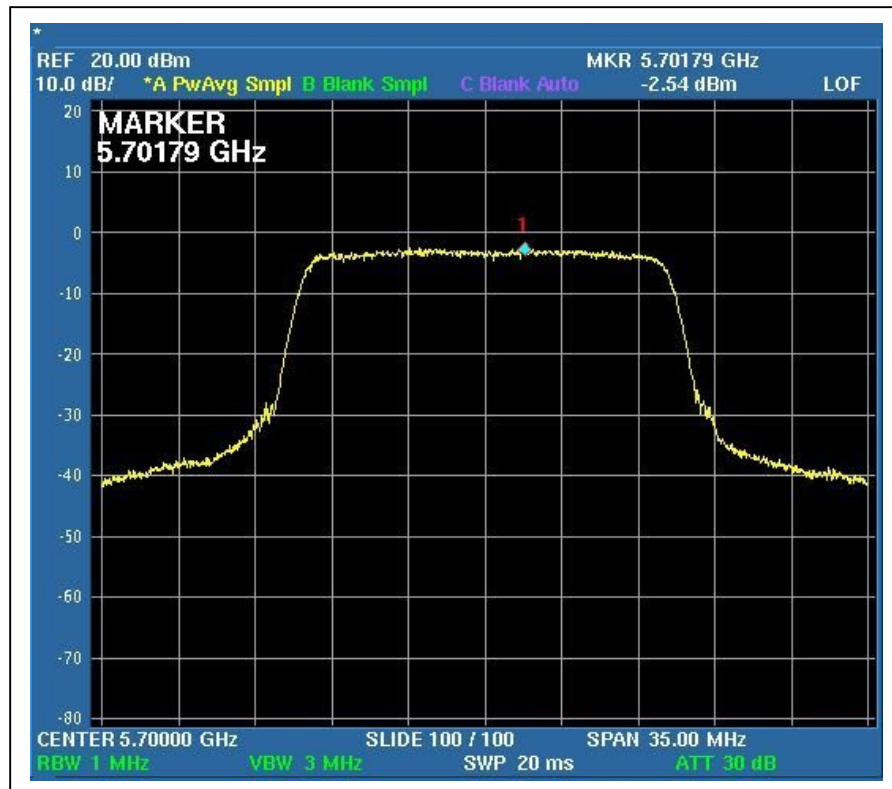

4.6 FREQUENCY STABILITY

4.6.1 LIMITS OF FREQUENCY STABILITY MEASUREMENT

The frequency tolerance of the carrier signal shall be maintained within +/- 0.02% of the operating frequency over a temperature variation of -30 degrees to 50 degrees C at normal supply voltage, and for a variation in the primary supply voltage from 85% to 115% of the rated supply voltage at a temperature of 20 degrees C.

4.6.2 TEST INSTRUMENTS

Description & Manufacturer	Model No.	Serial No.	Calibrated Until
R&S SPECTRUM ANALYZER	FSP40	100037	Aug. 15, 2007

NOTE:

1. The measurement uncertainty is less than +/- 2.6dB, which is calculated as per the NAMAS document NIS81. This uncertainty represents an expanded uncertainty expressed at approximately the 95% confidence level using a coverage factor of k=2.
2. The calibration interval of the above test instruments is 12 months and the calibrations are traceable to NML/ROC and NIST/USA.

4.6.3 TEST PROCEDURE

1. The EUT was placed inside the environmental test chamber and powered by nominal DC voltage.
2. Turn the EUT on and couple its output to a spectrum analyzer.
3. Turn the EUT off and set the chamber to the highest temperature specified.
4. Allow sufficient time (approximately 30 min) for the temperature of the chamber to stabilize, turn the EUT on and measure the operating frequency after 2, 5, and 10 minutes.
5. Repeat step 2 and 3 with the temperature chamber set to the lowest temperature.
6. The test chamber was allowed to stabilize at +20 degree C for a minimum of 30 minutes. The supply voltage was then adjusted on the EUT from 85% to 115% and the frequency record.

4.6.4 DEVIATION FROM TEST STANDARD

No deviation

4.6.5 TEST SETUP

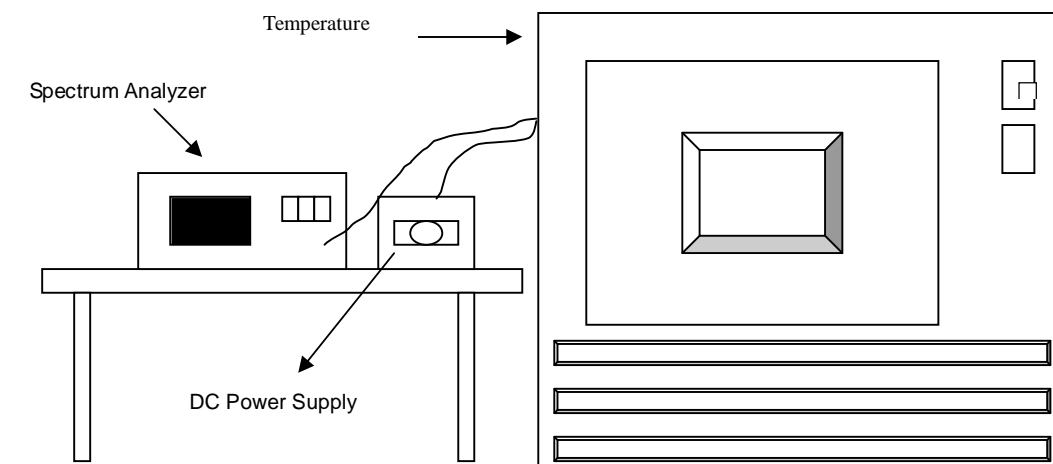

4.6.6 EUT OPERATING CONDITION

The software provided by client to enable the EUT under transmission condition continuously at specific channel frequencies individually.



4.6.7 TEST RESULTS

		Operating frequency: 5320MHz				Limit : $\pm 0.01\%$	
Temp. (°C)	Power supply (VAC)	2 minute		5 minute		10 minute	
		(MHz)	(%)	(MHz)	(%)	(MHz)	(%)
50	3.795	5319.9882	0.000222	5319.9905	0.000179	5319.9946	0.000102
	3.3	5319.9885	0.000216	5319.9912	0.000165	5319.9952	0.000090
	2.805	5319.9886	0.000214	5319.9915	0.000160	5319.9943	0.000107
40	3.795	5319.9881	0.000224	5319.9902	0.000184	5319.9953	0.000088
	3.3	5319.9882	0.000222	5319.9901	0.000186	5319.9955	0.000085
	2.805	5319.9981	0.000036	5319.9903	0.000182	5319.9952	0.000090
30	3.795	5319.9982	0.000034	5319.9996	0.000008	5319.9997	0.000006
	3.3	5319.9983	0.000032	5319.9992	0.000015	5319.9996	0.000008
	2.805	5319.9984	0.000030	5319.9994	0.000011	5319.9995	0.000009
20	3.795	5320.0091	0.000171	5320.0032	0.000060	5320.0017	0.000032
	3.3	5320.0092	0.000173	5320.0022	0.000041	5320.0014	0.000026
	2.805	5320.0093	0.000175	5320.0021	0.000039	5320.0016	0.000030
10	3.795	5320.0114	0.000214	5320.0082	0.001541	5320.0065	0.000122
	3.3	5320.0104	0.000195	5320.0085	0.001598	5320.0068	0.000128
	2.805	5320.0125	0.000235	5320.0086	0.000162	5320.0068	0.001278
0	3.795	5320.0232	0.000436	5320.0185	0.000348	5320.0156	0.000293
	3.3	5320.0233	0.000438	5320.0211	0.000397	5320.0163	0.000306
	2.805	5320.0218	0.000410	5320.0186	0.000350	5320.0145	0.000273
-10	3.795	5320.0266	0.000500	5320.0225	0.000423	5320.0182	0.000342
	3.3	5320.0284	0.000534	5320.0235	0.000442	5320.0185	0.000348
	2.805	5320.0284	0.000534	5320.0248	0.000466	5320.0187	0.000352
-20	3.795	5320.0312	0.000586	5320.0256	0.000481	5320.0216	0.000406
	3.3	5320.0311	0.000585	5320.0287	0.000539	5320.0214	0.000402
	2.805	5320.0321	0.000603	5320.0274	0.000515	5320.0212	0.000398

4.7 BAND EDGES MEASUREMENT

4.7.1 TEST INSTRUMENTS

Description & Manufacturer	Model No.	Serial No.	Calibrated Until
R&S SPECTRUM ANALYZER	FSP40	100037	Aug. 15, 2007

NOTE:

- 1.The measurement uncertainty is less than +/- 2.6dB, which is calculated as per the NAMAS document NIS81. This uncertainty represents an expanded uncertainty expressed at approximately the 95% confidence level using a coverage factor of k=2.
- 2.The calibration interval of the above test instruments is 12 months and the calibrations are traceable to NML/ROC and NIST/USA.

4.7.2 TEST PROCEDURE

The transmitter output was connected to the spectrum analyzer via a low lose cable. Set both RBW and VBW of spectrum analyzer to 1MHz with suitable frequency span including 100 MHz bandwidth from band edge. The band edges was measured and recorded.

4.7.3 EUT OPERATING CONDITION

The software provided by client to enable the EUT under transmission condition continuously at specific channel frequencies individually.

4.7.4 TEST RESULTS

For signals in the restricted bands above and below the 5.15 to 5.35GHz allocated band a measurement was made of the amplitude of the spurious emissions with respect to the intentional signals. The relative amplitude, in dBc, was applied to the average and peak field strength of the intentional signal made on the OATS to calculate the field strength of the unintentional signals.

The spectrum plots (Peak RBW=VBW=1MHz; Average RBW=1MHz, VBW=10Hz) are attached on the following pages.

802.11a OFDM modulation

NOTE (Peak):

The band edge emission plot on the following first page shows 47.06dBc between carrier maximum power and local maximum emission in restrict band. The emission of carrier strength list in the test result of channel 1 is 113.8dBuV/m (Peak), so the maximum field strength in restrict band is $113.8-47.06=66.74$ dBuV/m which is under 74dBuV/m limit.

The band edge emission plot on the following first page shows 42.73dBc between carrier maximum power and local maximum emission in restrict band. The emission of carrier strength list in the test result of channel 8 is 115.8dBuV/m (Peak), so the maximum field strength in restrict band is $115.8-42.73=73.07$ dBuV/m which is under 74dBuV/m limit.

NOTE (Average):

The band edge emission plot on the following second page shows 49.49dBc between carrier maximum power and local maximum emission in restrict band. The emission of carrier strength list in the test result of channel 1 is 103.2dBuV/m (Average), so the maximum field strength in restrict band is $103.2-49.49=53.71$ dBuV/m which is under 54dBuV/m limit.

The band edge emission plot on the following second page shows 49.11dBc between carrier maximum power and local maximum emission in restrict band. The emission of carrier strength list in the test result of channel 8 is 102.8dBuV/m (Average), so the maximum field strength in restrict band is $102.8-49.11=53.69$ dBuV/m which is under 54dBuV/m limit.

802.11a OFDM modulation(CH 1: 5180MHz)

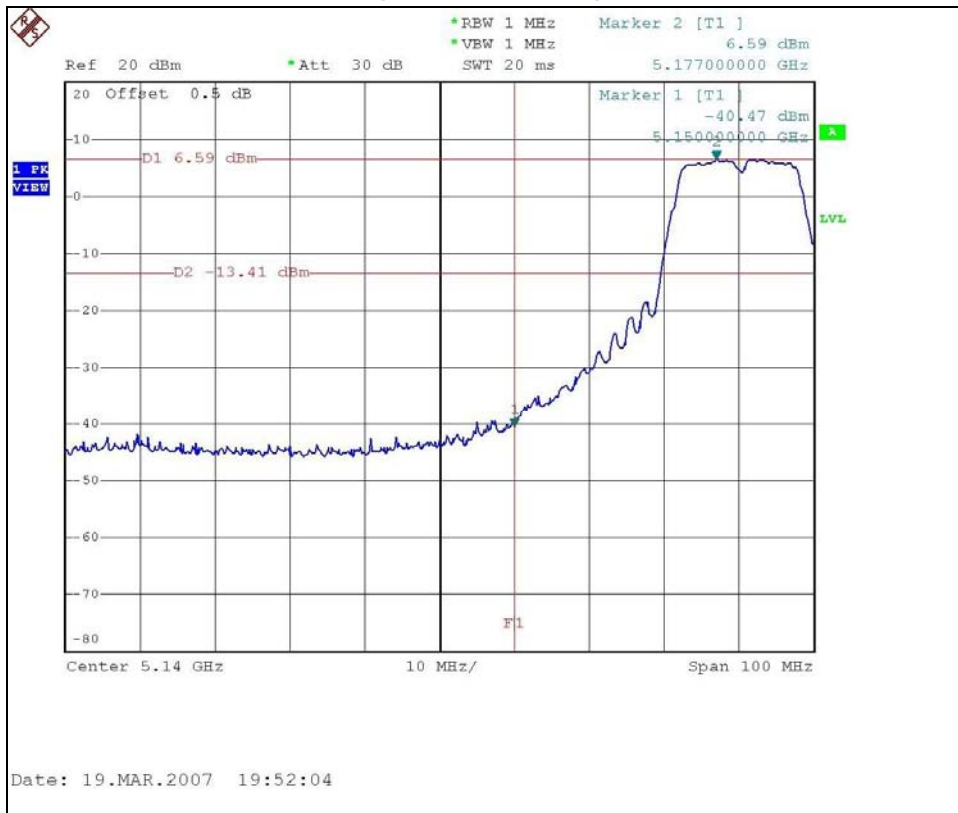

802.11a 10th conducted Harmonic

CH 1

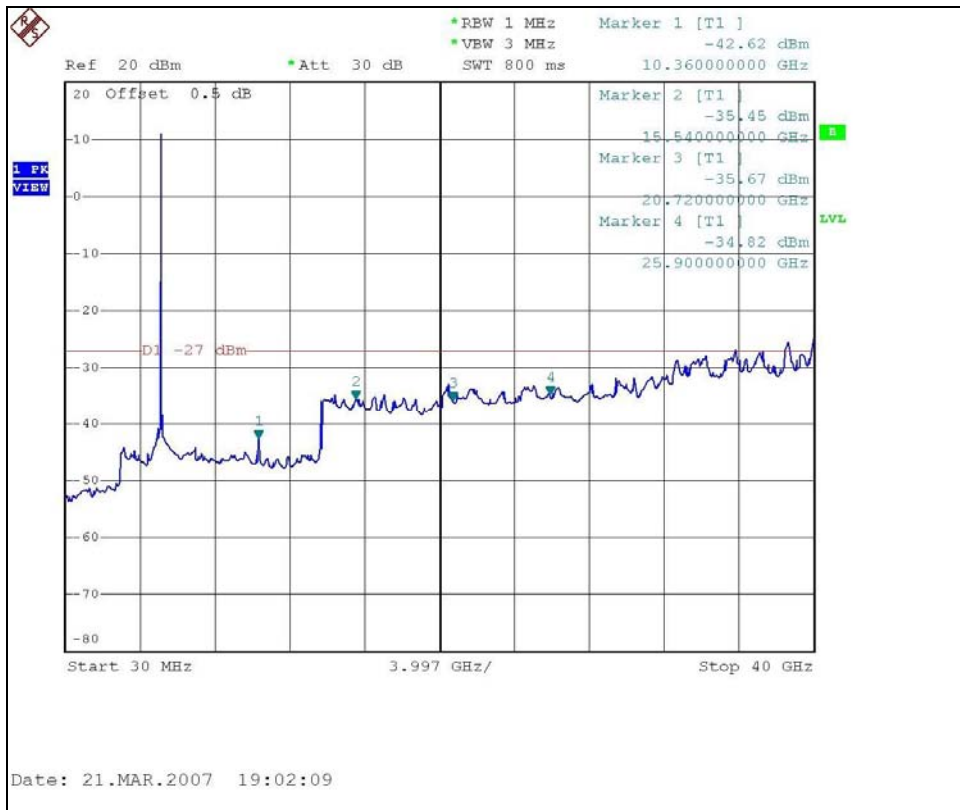

CH 8

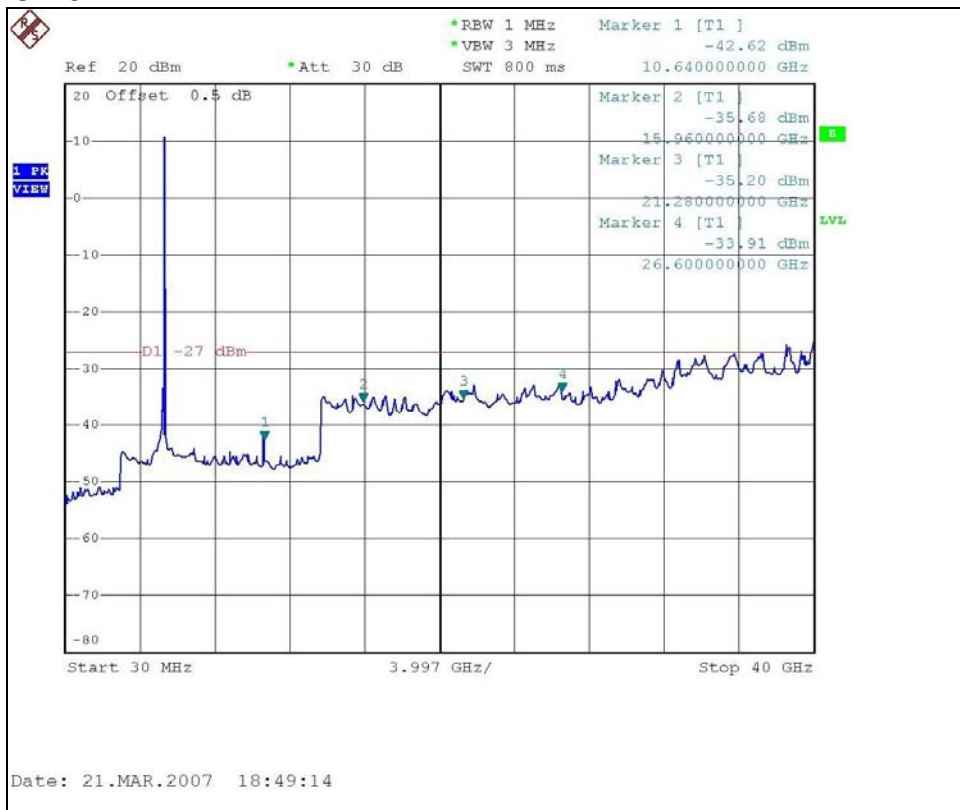

For signals in the restricted bands above and below the 5.47 to 5.725GHz allocated band a measurement was made of the amplitude of the spurious emissions with respect to the intentional signals. The relative amplitude, in dBc, was applied to the average and peak field strength of the intentional signal made on the OATS to calculate the field strength of the unintentional signals.

The spectrum plots (Peak RBW=1MHz, VBW=3MHz; Average RBW=1MHz, VBW=10Hz) are attached on the following pages.

802.11a OFDM modulation

NOTE (Peak):

The band edge emission plot on the following first page shows 50.25dBc between carrier maximum power and local maximum emission in restrict band. The emission of carrier strength list in the test result of channel 9 is 112.6dBuV/m (Peak), so the maximum field strength in restrict band is $112.6 - 50.25 = 62.35$ dBuV/m which is under 74dBuV/m limit.

NOTE (Average):

The band edge emission plot on the following second page shows 52.66dBc between carrier maximum power and local maximum emission in restrict band. The emission of carrier strength list in the test result of channel 9 is 101.8dBuV/m (Average), so the maximum field strength in restrict band is $101.8 - 52.66 = 49.14$ dBuV/m which is under 54dBuV/m limit.

802.11a OFDM modulation(CH 9: 5500MHz)

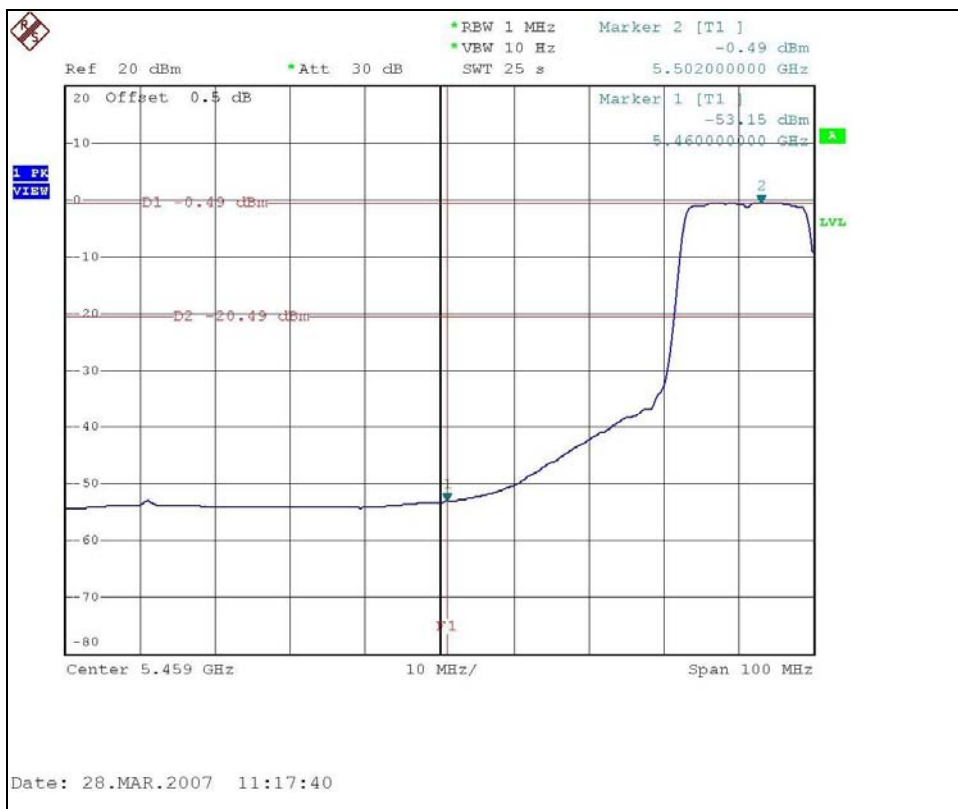
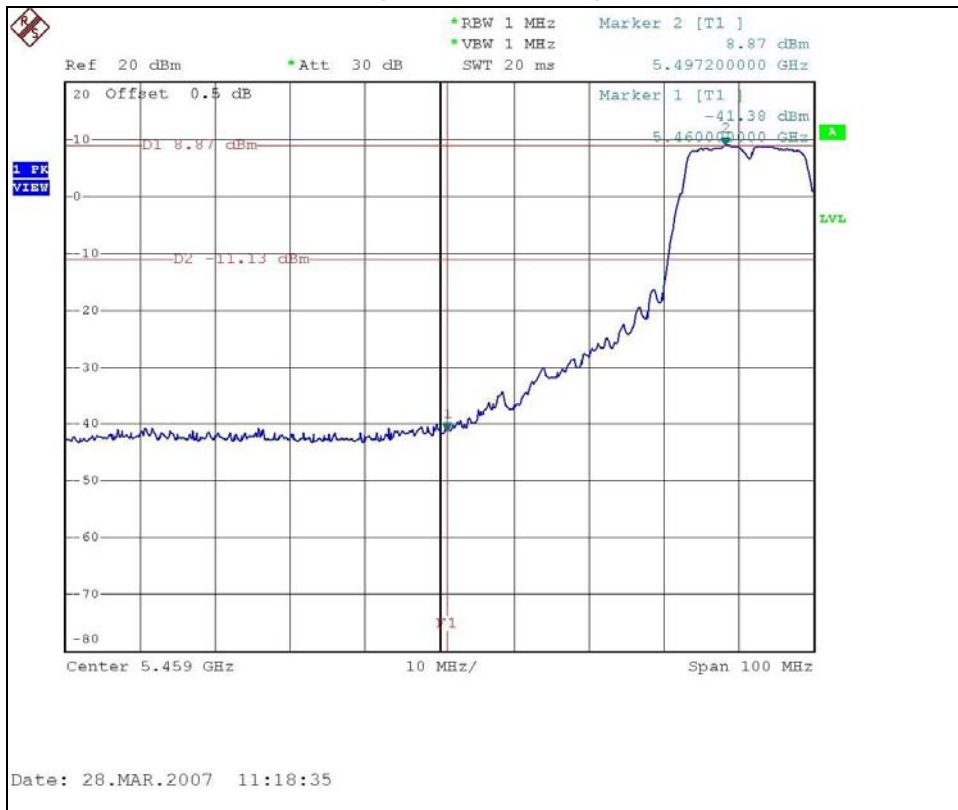

802.11a 10th conducted Harmonic

CH 9

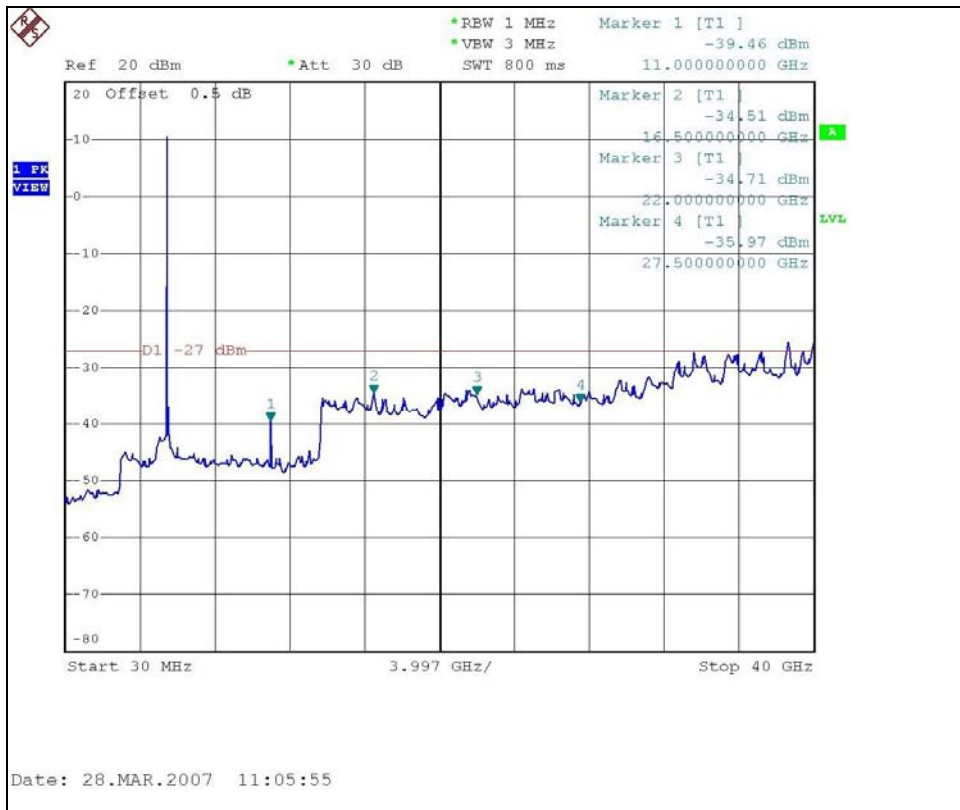

CH 19

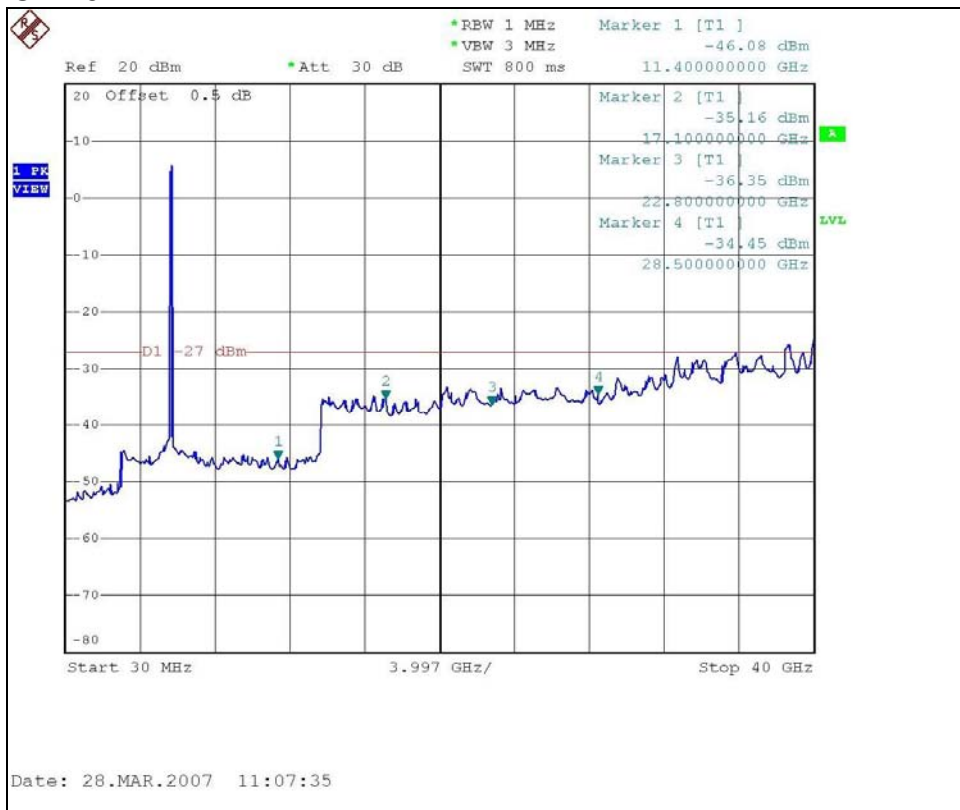



4.8 ANTENNA REQUIREMENT

4.8.1 STANDARD APPLICABLE

For intentional device, according to FCC 47 CFR Section 15.203, an intentional radiator shall be designed to ensure that no antenna other than that furnished by the responsible party shall be used with the device.

And according to FCC 47 CFR Section 15.407(a), if transmitting antennas of directional gain greater than 6dBi are used, the power shall be reduced by the amount in dB that the directional gain of the antenna exceeds 6dBi.

4.8.2 ANTENNA CONNECTED CONSTRUCTION

The antenna used in this product is one dipole antenna with RP-SMA MALE connector. The maximum Gain of the antenna is 2.8dBi.



5. INFORMATION ON THE TESTING LABORATORIES

We, ADT Corp., were founded in 1988 to provide our best service in EMC, Radio, Telecom and Safety consultation. Our laboratories are accredited and approved by the following approval agencies according to ISO/IEC 17025:

USA	FCC, UL, A2LA
Germany	TUV Rheinland
Japan	VCCI
Norway	NEMKO
Canada	INDUSTRY CANADA , CSA
R.O.C.	CNLA, BSMI, NCC
Netherlands	Telefication
Singapore	PSB , GOST-ASIA(MOU)
Russia	CERTIS(MOU)

Copies of accreditation certificates of our laboratories obtained from approval agencies can be downloaded from our web site:

www.adt.com.tw/index.5/phtml. If you have any comments, please feel free to contact us at the following:

Linko EMC/RF Lab:

Tel: 886-2-26052180

Fax: 886-2-26052943

Hsin Chu EMC/RF Lab:

Tel: 886-3-5935343

Fax: 886-3-5935342

Hwa Ya EMC/RF/Safety Telecom Lab:

Tel: 886-3-3183232

Fax: 886-3-3185050

Web Site: www.adt.com.tw

The address and road map of all our labs can be found in our web site also



APPENDIX-A

MODIFICATIONS RECORDERS FOR ENGINEERING CHANGES TO THE EUT BY THE LAB

No any modifications are made to the EUT by the lab during the test.