



Washington Laboratories, Ltd.

7560 Lindbergh Drive Gaithersburg, Maryland 20879 (301) 216-1500 Fax (301) 216-1590

website: <http://www.wll.com> email: info@wll.com

FCC & Industry Canada Certification Test Report

For the

Symbol Technologies

(a division of Motorola Inc.)

BCM2046 Bluetooth Module

FCC ID: H9P2070

IC ID: 1549D-2070

WLL JOB# 10814

June 6, 2009

Prepared for:

Symbol Technologies

(a division of Motorola Inc.)

One Motorola Plaza

Holtsville, NY 11742

Prepared By:

Washington Laboratories, Ltd.

7560 Lindbergh Drive

Gaithersburg, Maryland 20879



Testing Certificate 2675.01

**FCC & Industry Canada Certification Test Report
for the
Symbol Technologies (a division of Motorola Inc.)
BCM2046 Bluetooth Module**

FCC ID: H9P2070

IC ID: 1549D-2070

June 6, 2009

WLL JOB# 10814



Prepared by: James Ritter
EMC Compliance Engineer



Reviewed by: Steven D. Koster
EMC Operations Manager

Abstract

This report has been prepared on behalf of Symbol Technologies (a division of Motorola Inc.) to support the attached Application for Equipment Authorization. The test report and application are submitted for a Frequency Hopping Spread Spectrum Transmitter under Part 15.247 (10/2008) of the FCC Rules and Regulations and Spectrum Management and Telecommunications Policy RSS-210 of Industry Canada. This Certification Test Report documents the test configuration and test results for a Symbol Technologies (a division of Motorola Inc.) BCM2046 Bluetooth Module. Testing was performed on an Open Area Test Site (OATS) of Washington Laboratories, Ltd, 7560 Lindbergh Drive, Gaithersburg, MD 20879. Site description and site attenuation data have been placed on file with the FCC's Sampling and Measurements Branch at the FCC laboratory in Columbia, MD. The Industry Canada OATS numbers are 3035A-1 and 3035A-2 for Washington Laboratories, Ltd. Site 1 and Site 2, respectively. Washington Laboratories, Ltd. has been accepted by the FCC and approved by the American Association for Laboratory Accreditation (A2LA) under Certificate 2675.01 as an independent FCC test laboratory.

The Symbol Technologies (a division of Motorola Inc.)BCM2046 Bluetooth Module complies with the limits for a Frequency Hopping Spread Spectrum Transmitter device under FCC Part 15.247 and Industry Canada RSS-210.

Table of Contents

Abstract.....	ii
1 Introduction.....	1
1.1 Compliance Statement	1
1.2 Test Scope.....	1
1.3 Test Dates	1
1.4 Test and Support Personnel	1
1.5 Abbreviations.....	2
2 Equipment Under Test.....	3
2.1 EUT Identification & Description	3
2.2 Test Configuration	3
2.3 Testing Algorithm.....	4
2.4 Test Location	4
2.5 Measurements	5
2.5.1 References.....	5
2.6 Measurement Uncertainty.....	5
3 Test Equipment.....	6
4 Test Summary	7
5 Test Results.....	7
5.1 Time of Occupancy.....	7
5.2 RF Power Output: (FCC Part §2.1046)	14
5.3 Occupied Bandwidth: (FCC Part §2.1049).....	21
5.4 Channel Spacing and Number of Hop Channels (FCC Part §15247(a)(1)).....	24
5.5 Conducted Spurious Emissions at Antenna Terminals (FCC Part §2.1051)	26
5.6 Radiated Spurious Emissions: (FCC Part §2.1053).....	83
5.6.1 Test Procedure	83
5.7 Receiver Radiated Spurious Emissions: (RSS-Gen [7.2.3.2]).....	90
5.7.1 Test Procedure	90
5.7.2 Test Summary	91
5.8 AC Conducted Emissions	93
5.8.1 Requirements	93
5.8.2 Test Procedure	93
5.8.3 Conducted Data Reduction and Reporting	93
5.8.4 Test Data.....	94

List of Tables

Table 1. Device Summary.....	3
Table 2: Test Equipment List.....	6
Table 3: Test Summary Table.....	7
Table 4. RF Power Output (In MT2070 Host).....	14
Table 5. RF Power Output (In STB2078 Host)	14
Table 6. Occupied Bandwidth Results.....	23
Table 7 Channel spacing and number of hopping channels summary.....	24

Table 8: Radiated Emission Test Data (Restricted Bands), Transmit @2402MHz (In MT2070 Scanner with 1.88dBi Monopole antenna).....	84
Table 9: Radiated Emission Test Data (Restricted Bands), Transmit @2441MHz (In MT2070 Scanner with 1.88dBi Monopole antenna).....	85
Table 10: Radiated Emission Test Data (Restricted Bands), Transmit @2480MHz (In MT2070 Scanner with 1.88dBi Monopole antenna).....	86
Table 11: Radiated Emission Test Data (Restricted Bands), Transmit @2402MHz (In STB2078 Cradle with 2.5dBi Omni antenna).....	87
Table 12: Radiated Emission Test Data (Restricted Bands), Transmit @2441MHz (In STB2078 Cradle with 2.5dBi Omni antenna).....	88
Table 13: Radiated Emission Test Data (Restricted Bands), Transmit @2480MHz (In STB2078 Cradle with 2.5dBi Omni antenna).....	89
Table 14: Radiated Emission Test Data (Receiver) (In MT2070 scanner with 1.88dBi Omni antenna).....	91
Table 15: Radiated Emission Test Data (Receiver) (In STB2078 Cradle with 2.5dBi Omni antenna).....	92
Table 16 AC Power line Conducted Emissions.....	94

List of Figures

Figure 1 Test Configuration.....	4
Figure 2. Single Hop Dwell Time DH1 Mode.....	8
Figure 3. Single Hop Dwell Time DH3 Mode.....	9
Figure 4. Single Hop Dwell Time DH5 Mode.....	10
Figure 5. Dwell time per channel over 31.6 Seconds, DH1 Mode.....	11
Figure 6. Dwell time per channel over 31.6 Seconds, DH3 Mode.....	12
Figure 7. Dwell time per channel over 31.6 Seconds, DH5 Mode.....	13
Figure 8. RF Peak Power, Low Channel (In MT2070 Host).....	15
Figure 9. RF Peak Power, Mid Channel (In MT2070 Host).....	16
Figure 10. RF Peak Power, High Channel (In MT2070 Host).....	17
Figure 11. RF Peak Power, Low Channel (In STB2078 Host).....	18
Figure 12. RF Peak Power, Mid Channel (In STB2078 Host).....	19
Figure 13. RF Peak Power, High Channel (In STB2078 Host).....	20
Figure 14. Occupied Bandwidth, Low Channel.....	21
Figure 15. Occupied Bandwidth, Mid Channel.....	22
Figure 16. Occupied Bandwidth, High Channel.....	23
Figure 17, Channel Spacing.....	25
Figure 18, Number of Channels.....	26
Figure 19 Lower Band Edge Plot, Low Channel (in MT2070 Host).....	27
Figure 20 Lower Band Edge Plot, Hopping Mode (in MT2070 Host).....	28
Figure 21 Upper Band Edge Plot, High Channel (in MT2070 Host).....	29
Figure 22 Upper Band Edge Plot, Hopping Mode (in MT2070 Host).....	30
Figure 23. Conducted Spurious Emissions, Low Channel 30 - 1000MHz (in MT2070 Host)	31
Figure 24. Conducted Spurious Emissions, Low Channel 1 – 2.395GHz (in MT2070 Host)	32

Figure 25. Conducted Spurious Emissions, Low Channel 2.395 – 2.488GHz (in MT2070 Host) 33

Figure 26. Conducted Spurious Emissions, Low Channel 2.488 - 5GHz (in MT2070 Host) 34

Figure 27. Conducted Spurious Emissions, Low Channel 5-10GHz (in MT2070 Host) 35

Figure 28. Conducted Spurious Emissions, Low Channel 10-15GHz (in MT2070 Host) 36

Figure 29. Conducted Spurious Emissions, Low Channel 15-20GHz (in MT2070 Host) 37

Figure 30. Conducted Spurious Emissions, Low Channel 20-25GHz (in MT2070 Host) 38

Figure 31. Conducted Spurious Emissions, Mid Channel 30 - 1000MHz (in MT2070 Host) 39

Figure 32. Conducted Spurious Emissions, Mid Channel 1 – 2.395GHz (in MT2070 Host) 40

Figure 33. Conducted Spurious Emissions, Mid Channel 2.395 – 2.488GHz (in MT2070 Host) 41

Figure 34. Conducted Spurious Emissions, Mid Channel 2.488 - 5GHz (in MT2070 Host) 42

Figure 35. Conducted Spurious Emissions, Mid Channel 5 - 10GHz (in MT2070 Host) 43

Figure 36. Conducted Spurious Emissions, Mid Channel 10-15GHz (in MT2070 Host) 44

Figure 37. Conducted Spurious Emissions, Mid Channel 15-20GHz (in MT2070 Host) 45

Figure 38. Conducted Spurious Emissions, Mid Channel 20-25GHz (in MT2070 Host) 46

Figure 39. Conducted Spurious Emissions, High Channel 30 - 1000MHz (in MT2070 Host) 47

Figure 40. Conducted Spurious Emissions, High Channel 1 – 2.395GHz (in MT2070 Host) 48

Figure 41. Conducted Spurious Emissions, High Channel 2.395 – 2.488GHz (in MT2070 Host) 49

Figure 42. Conducted Spurious Emissions, High Channel 2.488 - 5GHz (in MT2070 Host) 50

Figure 43. Conducted Spurious Emissions, High Channel 5 - 10GHz (in MT2070 Host) 51

Figure 44. Conducted Spurious Emissions, High Channel 10 - 15GHz (in MT2070 Host) 52

Figure 45. Conducted Spurious Emissions, High Channel 15-20GHz (in MT2070 Host) 53

Figure 46. Conducted Spurious Emissions, High Channel 20-25GHz (in MT2070 Host) 54

Figure 47. Lower Band Edge Plot, Low Channel (in STB2078 Host) 55

Figure 48. Lower Band Edge Plot, Hopping Mode (in STB2078 Host) 56

Figure 49. Upper Band Edge Plot, High Channel (in STB2078 Host) 57

Figure 50. Upper Band Edge Plot, Hopping Mode (in STB2078 Host) 58

Figure 51. Conducted Spurious Emissions, Low Channel 30 - 1000MHz (in STB2078 Host) ... 59

Figure 52. Conducted Spurious Emissions, Low Channel 1 – 2.395GHz (in STB2078 Host) 60

Figure 53. Conducted Spurious Emissions, Low Channel 2.395- 2.488GHz (in STB2078 Host) 61

Figure 54. Conducted Spurious Emissions, Low Channel 2.488 – 5 GHz (in STB2078 Host) ... 62

Figure 55. Conducted Spurious Emissions, Low Channel 5-10GHz (in STB2078 Host) 63

Figure 56. Conducted Spurious Emissions, Low Channel 10- 15GHz (in STB2078 Host) 64

Figure 57. Conducted Spurious Emissions, Low Channel 15- 20GHz (in STB2078 Host) 65

Figure 58. Conducted Spurious Emissions, Low Channel 20-25GHz (in STB2078 Host) 66

Figure 59. Conducted Spurious Emissions, Mid Channel 30 - 1000MHz (in STB2078 Host) 67

Figure 60. Conducted Spurious Emissions, Mid Channel 1 – 2.395GHz (in STB2078 Host) 68

Figure 61. Conducted Spurious Emissions, Mid Channel 2.395- 2.488GHz (in STB2078 Host) 69

Figure 62. Conducted Spurious Emissions, Mid Channel 2.488 – 5 GHz (in STB2078 Host) 70

Figure 63. Conducted Spurious Emissions, Mid Channel 5-10GHz (in STB2078 Host) 71

Figure 64. Conducted Spurious Emissions, Mid Channel 10- 15GHz (in STB2078 Host) 72

Figure 65. Conducted Spurious Emissions, Mid Channel 15- 20GHz (in STB2078 Host) 73

Figure 66. Conducted Spurious Emissions, Mid Channel 20-25GHz (in STB2078 Host) 74

Figure 67. Conducted Spurious Emissions, High Channel 30 - 1000MHz (in STB2078 Host) ... 75

Figure 68. Conducted Spurious Emissions, High Channel 1 – 2.395GHz (in STB2078 Host) ... 76
Figure 69. Conducted Spurious Emissions, High Channel 2.395- 2.488GHz (in STB2078 Host)
..... 77
Figure 70. Conducted Spurious Emissions, High Channel 2.488 – 5 GHz (in STB2078 Host) .. 78
Figure 71. Conducted Spurious Emissions, High Channel 5-10GHz (in STB2078 Host) 79
Figure 72. Conducted Spurious Emissions, High Channel 10- 15GHz (in STB2078 Host) 80
Figure 73. Conducted Spurious Emissions, High Channel 15- 20GHz (in STB2078 Host) 81
Figure 74. Conducted Spurious Emissions, High Channel 20-25GHz (in STB2078 Host) 82

1 Introduction

1.1 Compliance Statement

The Symbol Technologies (a division of Motorola Inc.) BCM2046 Bluetooth Module complies with the limits for a Frequency Hopping Spread Spectrum Transmitter Module under FCC Part 15.247 (10/2008) and Industry Canada RSS-210e issue 7. The module unit fulfills the requirements of 15.212 for use as a limited module.

1.2 Test Scope

Tests for radiated and conducted (at antenna terminal) emissions were performed. All measurements were performed in accordance with “FCC Public Notice DA 00-705, Filing and Measurement Guidelines for Frequency Hopping Spread Spectrum Systems”.

Contract Information

Customer: Symbol Technologies
(a division of Motorola Inc.)
One Motorola Plaza
Holtsville, NY 11742

Purchase Order Number NP4519577

Quotation Number 64092

1.3 Test Dates

Testing was performed on the following date(s): 4/29/2009-5/29/2009

1.4 Test and Support Personnel

Washington Laboratories, LTD James Ritter, John Reidell, Thuan Ta

Client Representative Mark S. Luksich

1.5 Abbreviations

A	Ampere
ac	alternating current
AM	Amplitude Modulation
Amps	Amperes
b/s	bits per second
BW	BandWidth
CE	Conducted Emission
cm	Centimeter
CW	Continuous Wave
dB	decibel
dc	direct current
EMI	Electromagnetic Interference
EUT	Equipment Under Test
FM	Frequency Modulation
G	giga - prefix for 10⁹ multiplier
Hz	Hertz
IF	Intermediate Frequency
k	kilo - prefix for 10³ multiplier
LISN	Line Impedance Stabilization Network
M	Mega - prefix for 10⁶ multiplier
m	Meter
μ	micro - prefix for 10⁻⁶ multiplier
NB	Narrowband
QP	Quasi-Peak
RE	Radiated Emissions
RF	Radio Frequency
rms	root-mean-square
SN	Serial Number
S/A	Spectrum Analyzer
V	Volt

2 Equipment Under Test

2.1 EUT Identification & Description

The Symbol Technologies (a division of Motorola Inc.) BCM2046 Bluetooth Module is a low power Bluetooth (FHSS) radio operating in the 2402-2480MHz band.

Table 1. Device Summary

ITEM	DESCRIPTION
Manufacturer:	Symbol Technologies (a division of Motorola Inc.)
FCC ID:	H9P2070
IC:	1549D-2070
Model:	BCM2046 Bluetooth Module
FCC Rule Parts:	§15.247
Industry Canada:	RSS210
Frequency Range:	2402-2480MHz
Maximum Output Power:	In MT2070 Host 7.59mW (8.8dBm) Conducted at antenna port In STB2078 Host 2.4mW(3.8dBm) Conducted at antenna port
Modulation:	GFSK
Occupied Bandwidth:	1.025MHz
Keying:	Automatic
Type of Information:	Data
Number of Channels:	79
Power Output Level	Fixed
Antenna Connector	Integral Antenna
Antenna Type	1.88dBi Monopole (MT2070 Host) & 2.7 dBi Omni (STB2078 Host)
Interface Cables:	None
Power Source & Voltage:	(MT2078 Host) 3.7VDC Battery (rechargeable via USB connection or cradle) (STB2078 Host) 120VAC
Emission Designator	1M03FXD
Receiver Spurious (worst case)	-5.0 μ V/m @ 3 meters
Transmitter Spurious (worst case)	-6.8 μ V/m @ 3 meters

2.2 Test Configuration

The Symbol Technologies (a division of Motorola Inc.) BCM2046 Bluetooth Module had the Bluetooth antenna replaced by a temporary antenna port that was used to connect to test measurement devices. Radiated emissions had the Normal antenna installed terminated. An Ethernet to USB cable was connected to a support laptop PC to control the transmitters.

The BCM2046 Bluetooth Module was tested for conducted and radiated emissions in a host MT2070 Scanner unit with an internal 1.88 dBi Monopole Antenna. The BCM2046 Bluetooth Module was also tested for Conducted Power, conducted spurious and radiated emissions in a STB2078 scanner cradle unit with an integral 2.5dBi Omni antenna.

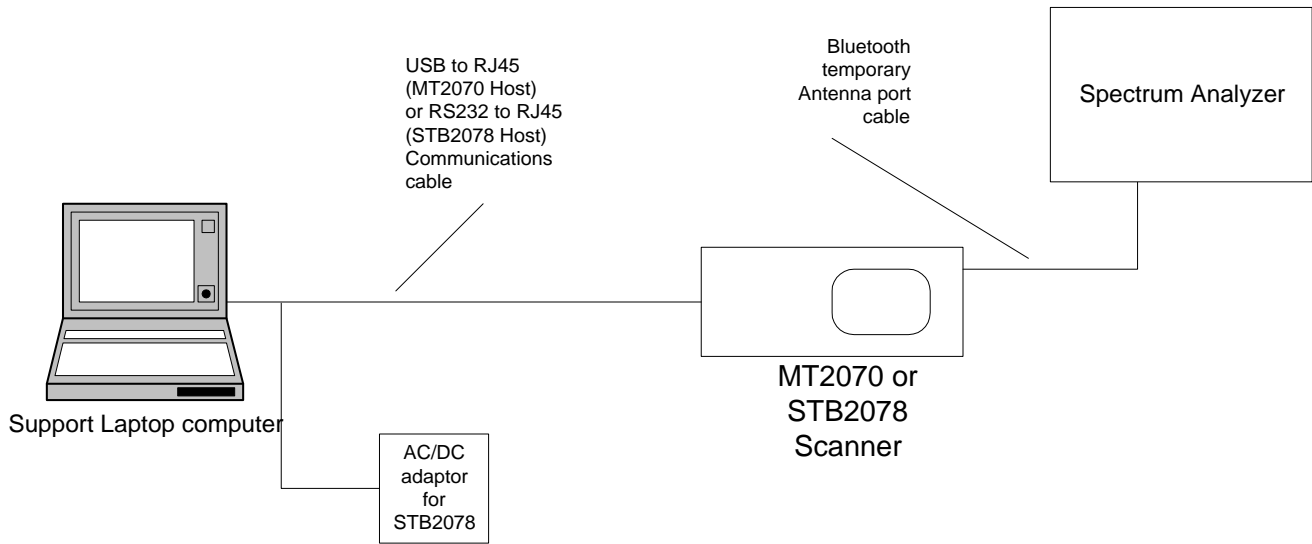

Figure 1 Test Configuration

2.3 Testing Algorithm

The Model MT2070 Scanner was connected via a communications cable. Microsoft Active Sync and remote display were installed on the laptop PC in order to remotely control the MT2070. A program (BTRegTest.exe for Bluetooth radio) was pre-installed on the MT2070 unit. This program allowed setting the desired modes of operation required in this standard.

For the Model STB2078 cradle was connected via a RS232 communications cable. A custom program (STB2078 Regulatory Test app 1.6) was loaded onto the support laptop. This program allowed setting the desired modes of operation required in this standard. The STB2078 was tested for power, conducted spurious and radiated emissions.

Worst case emission levels are provided in the test results data.

2.4 Test Location

All measurements herein were performed at Washington Laboratories, Ltd. test center in Gaithersburg, MD. Site description and site attenuation data have been placed on file with the FCC's Sampling and Measurements Branch at the FCC laboratory in Columbia, MD. The Industry Canada OATS numbers are 3035A-1 and 3035A-2 for Washington Laboratories, Ltd. Site 1 and Site 2, respectively. Washington Laboratories, Ltd. has been accepted by the FCC and approved by the American Association for Laboratory Accreditation (A2LA) under Certificate 2675.01 as an independent FCC test laboratory.

2.5 Measurements

2.5.1 References

FCC Public Notice DA 00-705, Filing and Measurement Guidelines for Frequency Hopping Spread Spectrum Systems

ANSI C63.2 Specifications for Electromagnetic Noise and Field Strength Instrumentation

2.6 Measurement Uncertainty

All results reported herein relate only to the equipment tested. For the purposes of the measurements performed by Washington Laboratories, the measurement uncertainty is ± 2.3 dB. This has been calculated for a *worst-case situation* (radiated emissions measurements performed on an open area test site).

The following measurement uncertainty calculation is provided:

$$\text{Total Uncertainty} = (A^2 + B^2 + C^2)^{1/2}/(n-1)$$

where:

A = Antenna calibration uncertainty, in dB = 2 dB

B = Spectrum Analyzer uncertainty, in dB = 1 dB

C = Site uncertainty, in dB = 4 dB

n = number of factors in uncertainty calculation = 3

Thus, Total Uncertainty = $0.5 (2^2 + 1^2 + 4^2)^{1/2} = \pm 4.55$ dB.

3 Test Equipment

Table 2 shows a list of the test equipment used for measurements along with the calibration information.

Table 2: Test Equipment List

Typical Equipment List

Test Name: Radiated Emissions		Test Date: 05/29/2009	
Asset #	Manufacturer/Model	Description	Cal. Due
71	HP, 85685A	Preselector, RF	07/09/2009
73	HP, 8568B	Analyzer, Spectrum	07/08/2009
69	HP, 85650A	Adapter, QP	07/09/2009
644	Sunol Science JB1	BiConalog Antenna	12/29/2009
4	ARA, DRG-118/A	Antenna, DRG, 1-18GHz	02/06/2011
667	MegaPhase, LLC EM18-S1NK5-600	Test cable for OATS testing DC to 18 GHz SMA male	04/23/2010
66	HP, 8449B	Pre-Amplifier, RF. 1-26.5GHz	07/15/2009
288	IWI, SPS-3051-790-SPS	Cable, HF, B	09/29/2009
474	HP, 8563E	Analyzer, Spectrum	02/03/2011
Test Name: Bench Emissions		:	
Asset #	Manufacturer/Model	Description	Cal. Due
00618	HP 8563A	Analyzer, Spectrum	4/10/2010

4 Test Summary

The Table Below shows the results of testing for compliance with a Frequency Hopping System in accordance with FCC Part 15.247:2008 and RSS210e issue 7. Full results are shown in section 5.

Table 3: Test Summary Table

TX Test Summary (Frequency Hopping Spread Spectrum)			
FCC Rule Part	IC Rule Part	Description	Result
15.247 (a)(1)(iii)	RSS-210 [A8. 1]	20dB Bandwidth	Pass
15.247 (b)(1)	RSS-210 [A8.4 (2)]	Transmit Output Power	Pass
15.247 (a)(1)	RSS-210 [A8.1 (2)]	Channel Separation	Pass
15.247 (a)(1)(iii)	RSS-210 [A8. 1 (4)]	Number of Channels >15	Pass
15.247 (a)(1)(iii)	RSS-210 [A8. 1 (4)]	Time of Occupancy	Pass
15.247 (d)	RSS-210 [A8. 5]	Occupied BW / Out-of-Band Emissions (Band Edge @ 20dB below)	Pass
15.205 15.209	RSS-210 [A8. 5]	General Field Strength Limits (Restricted Bands & RE Limits)	Pass
RX/Digital Test Summary (Frequency Hopping Spread Spectrum)			
FCC Rule Part	IC Rule Part	Description	Result
15.207	RSS-Gen [7.2.2]	AC Conducted Emissions	Pass
15.209	RSS-Gen [7.2.3.2]	General Field Strength Limits (Restricted Bands & RE Limits)	Pass

5 Test Results

5.1 Time of Occupancy

Frequency hopping systems in the 2400-2483.5 MHz band shall use at least 15 channels. The average time of occupancy on any channel shall not be greater than 0.4 seconds within a period of 0.4 seconds multiplied by the number of hopping channels employed. Frequency hopping systems may avoid or suppress transmissions on a particular hopping frequency provided that a minimum of 15 channels are used.

The following plots show the time of Occupancy for DH1, DH3, and DH5 Modes.

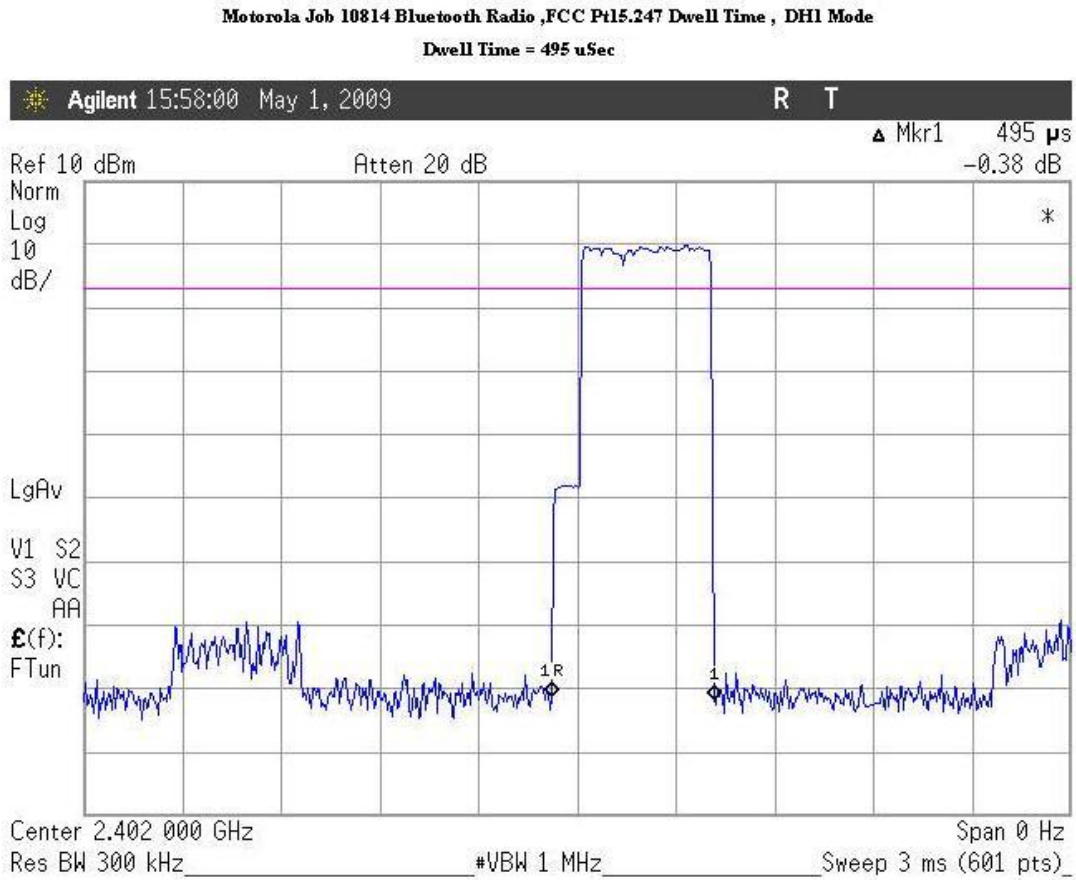

Figure 2. Single Hop Dwell Time DH1 Mode

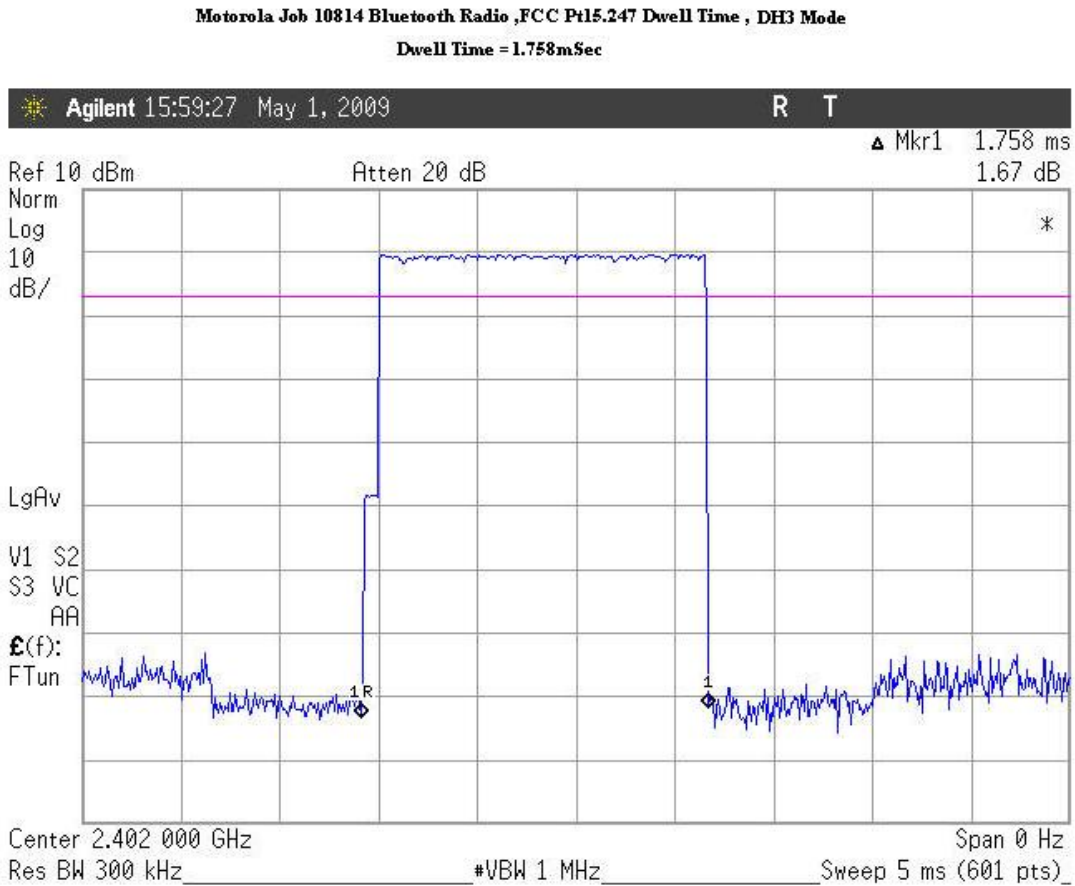

Figure 3. Single Hop Dwell Time DH3 Mode

Motorola Job 10814 Bluetooth Radio ,FCC Pt15.247 Dwell Time , DH5 Mode
Dwell Time = 3.067mSec

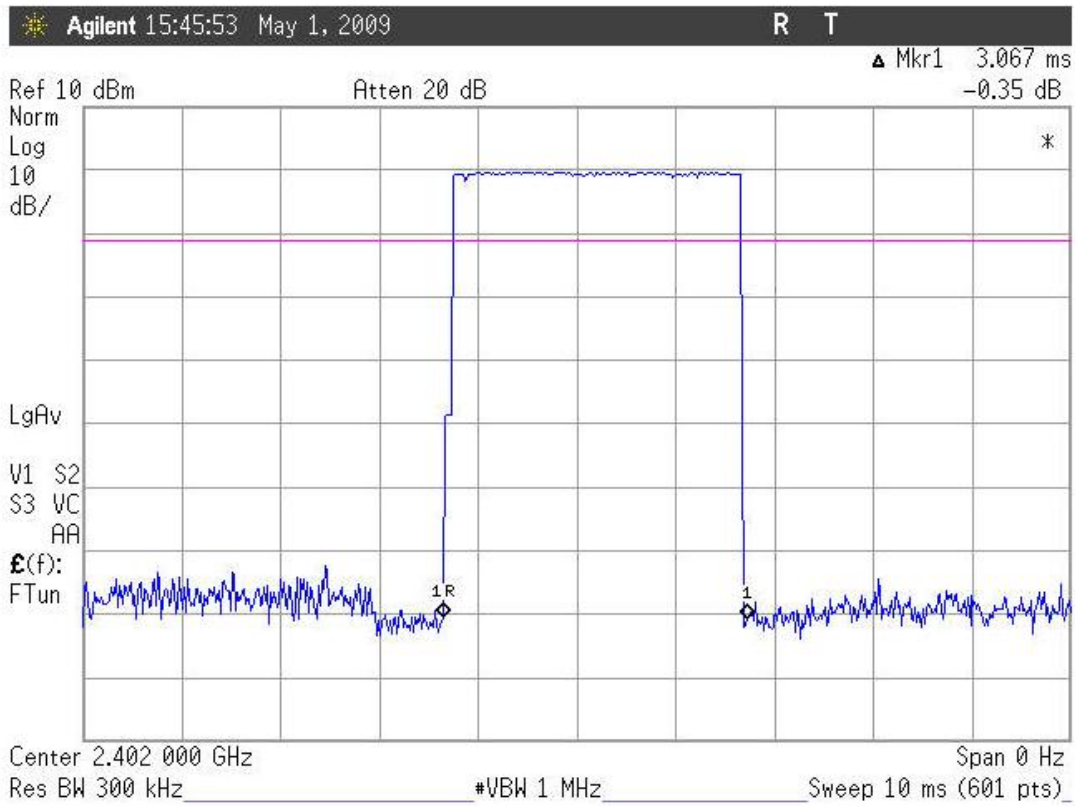

Figure 4. Single Hop Dwell Time DH5 Mode

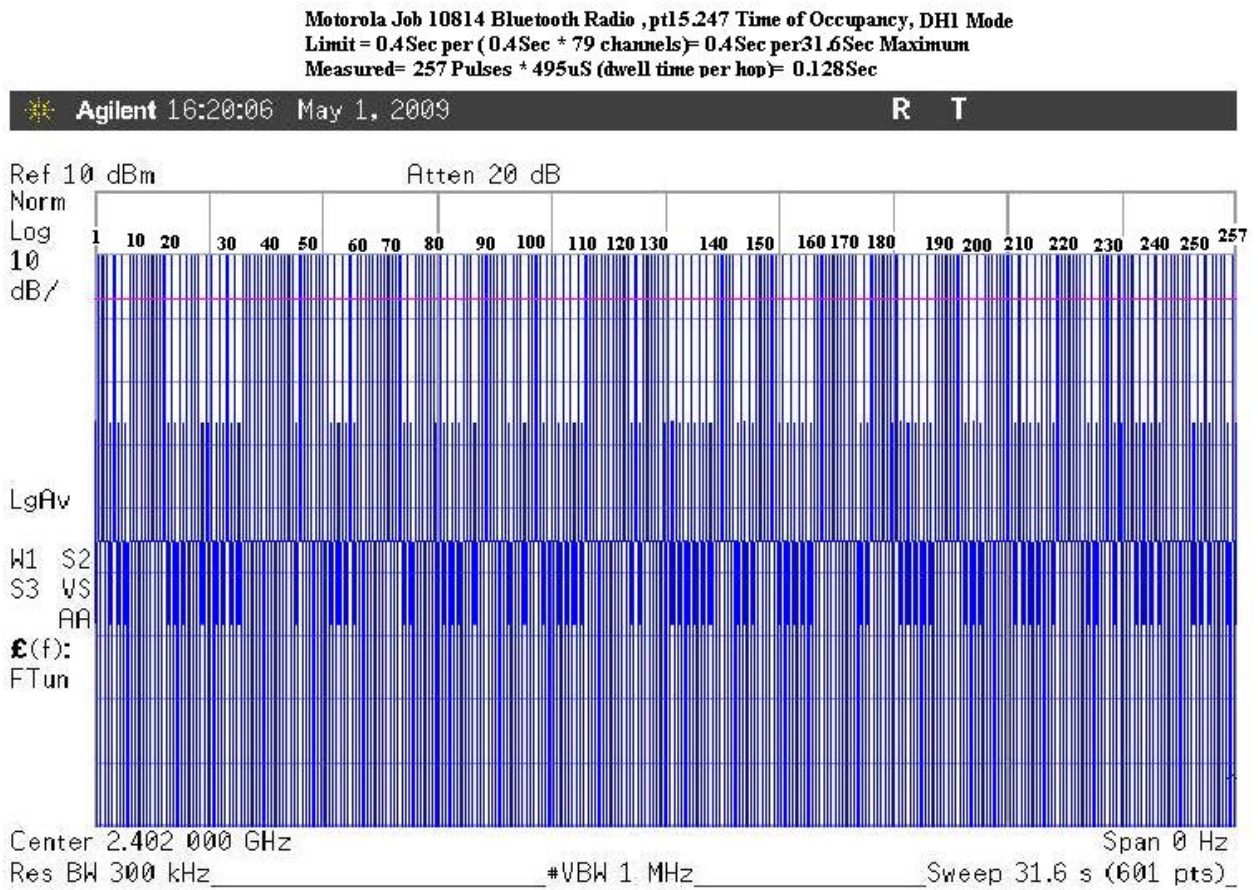

Figure 5. Dwell time per channel over 31.6 Seconds, DH1 Mode

Motorola Job 10814 Bluetooth Radio , pt15.247 Time of Occupancy, DH3 Mode
Limit = 0.4Sec per (0.4Sec * 79 channels)= 0.4Sec per31.6Sec Maximum
Measured= 156 Pulses * 1.758mS (dwell time per hop)= 0.275Sec

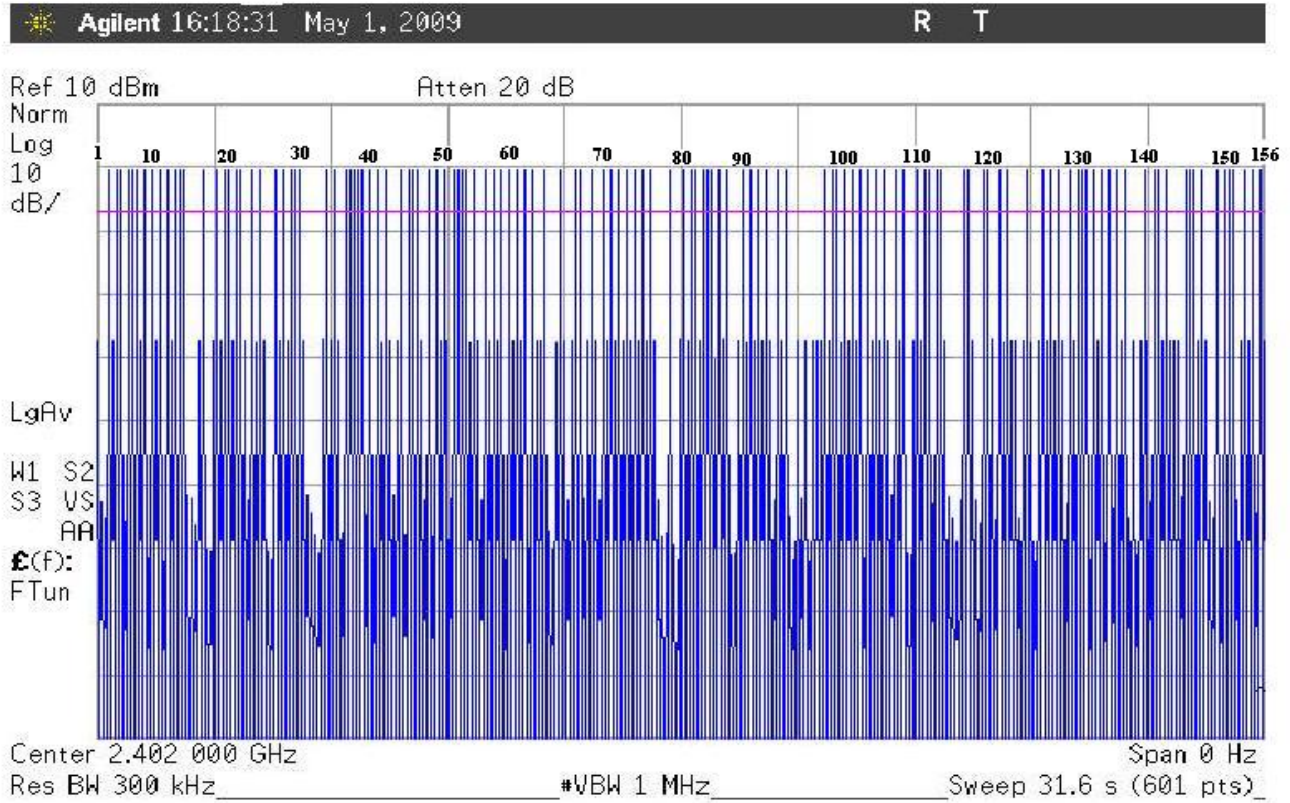

Figure 6. Dwell time per channel over 31.6 Seconds, DH3 Mode

Motorola Job 10814 Bluetooth Radio ,pt15.247 Time of Occupancy, DH5 Mode
Limit = 0.4Sec per (0.4Sec * 79 channels)= 0.4Sec per31.6Sec Maximum
Measured= 118 Pulses * 3.067mS (dwell time per hop)=0.362Sec

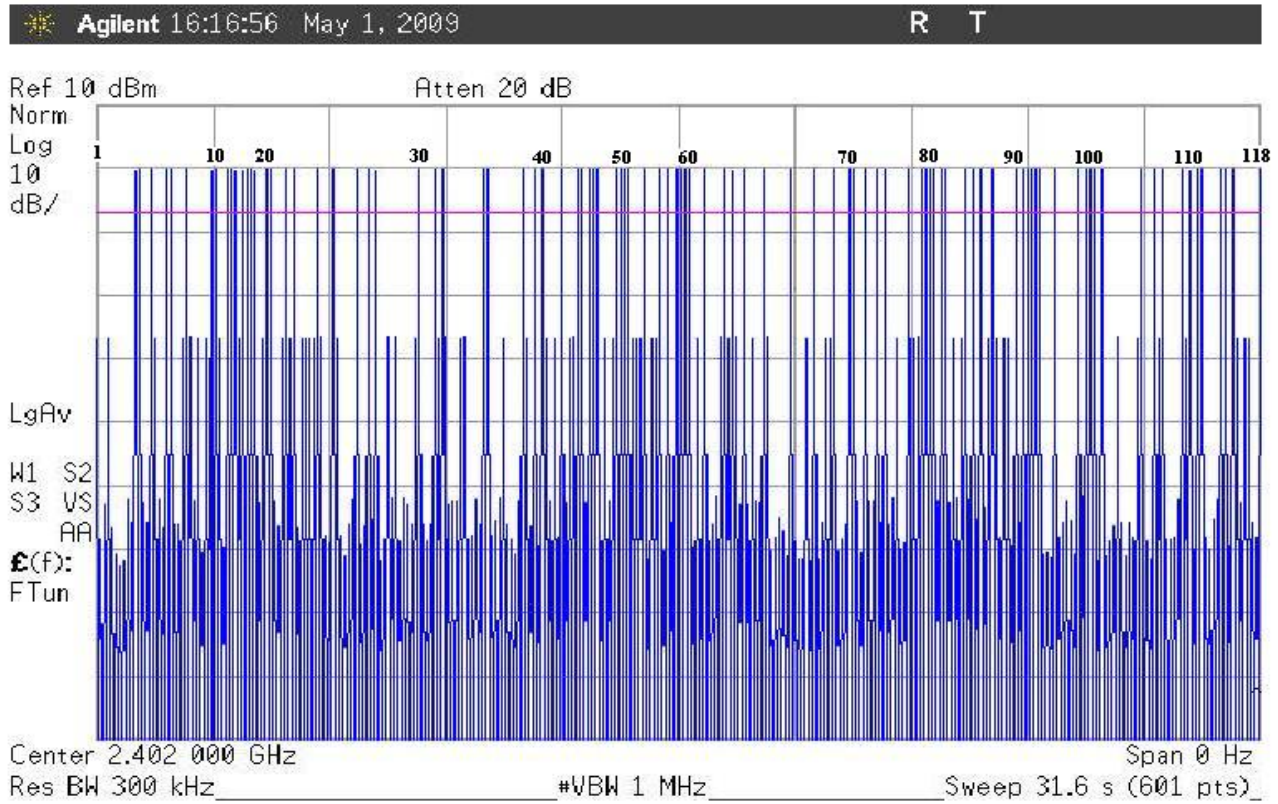

Figure 7. Dwell time per channel over 31.6 Seconds, DH5 Mode

5.2 RF Power Output: (FCC Part §2.1046)

To measure the output power the hopping sequence was stopped while the frequency dwelled on a low, high and middle channel. The output from the transmitter was connected to an attenuator and then to the input of the RF Spectrum Analyzer. The analyzer offset was adjusted to compensate for the attenuator and other losses in the system.

Table 4. RF Power Output (In MT2070 Host)

Frequency	Level	Limit	Pass/Fail
Low Channel: 2402MHz	8.8 dBm	30 dBm	Pass
Mid Channel: 2441MHz	8.2 dBm	30 dBm	Pass
High Channel: 2480MHz	7.7 dBm	30 dBm	Pass

Table 5. RF Power Output (In STB2078 Host)

Frequency	Level	Limit	Pass/Fail
Low Channel: 2402MHz	3.8 dBm	30 dBm	Pass
Mid Channel: 2441MHz	3.6 dBm	30 dBm	Pass
High Channel: 2480MHz	3.0 dBm	30 dBm	Pass

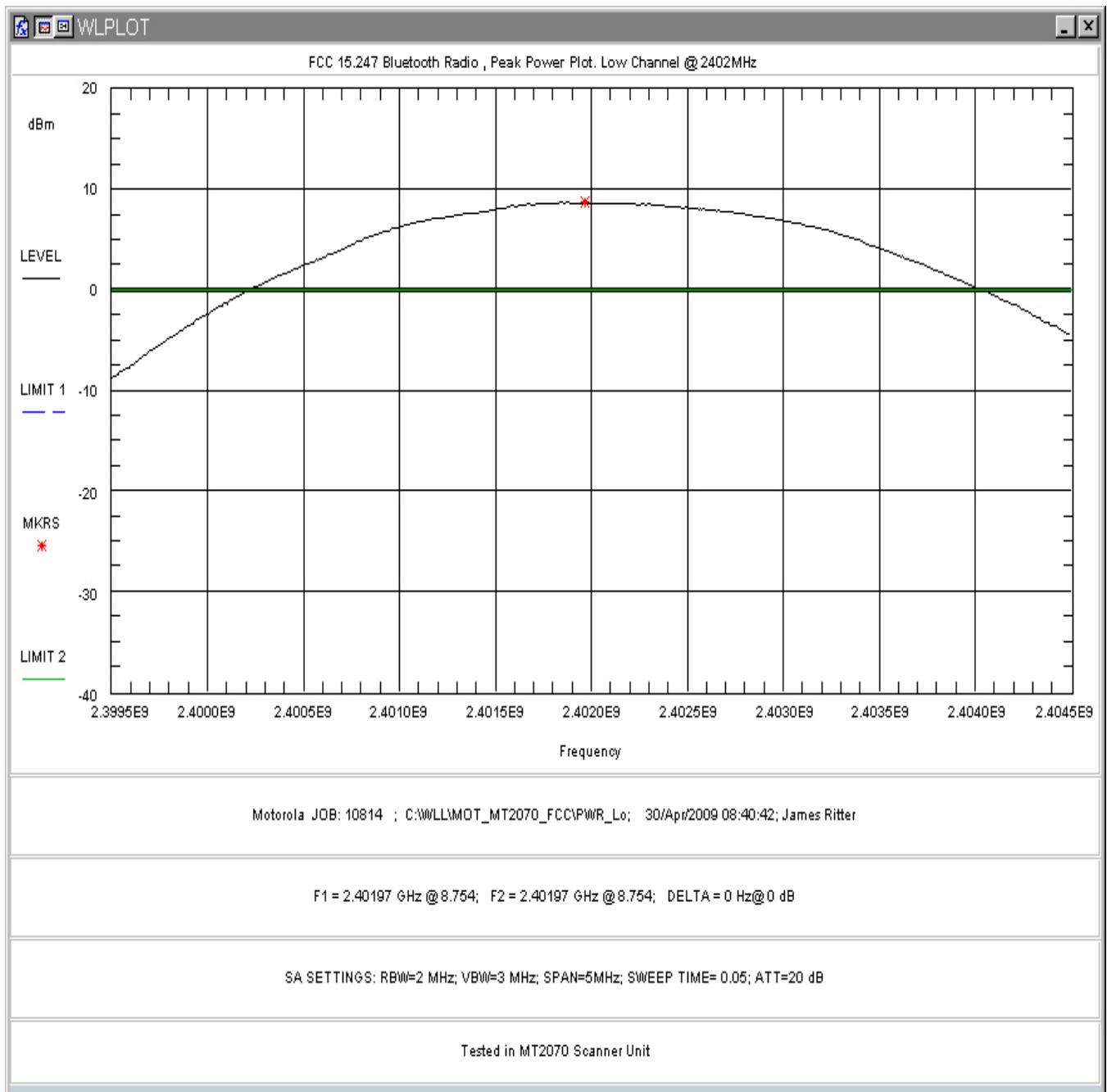

Figure 8. RF Peak Power, Low Channel (In MT2070 Host)

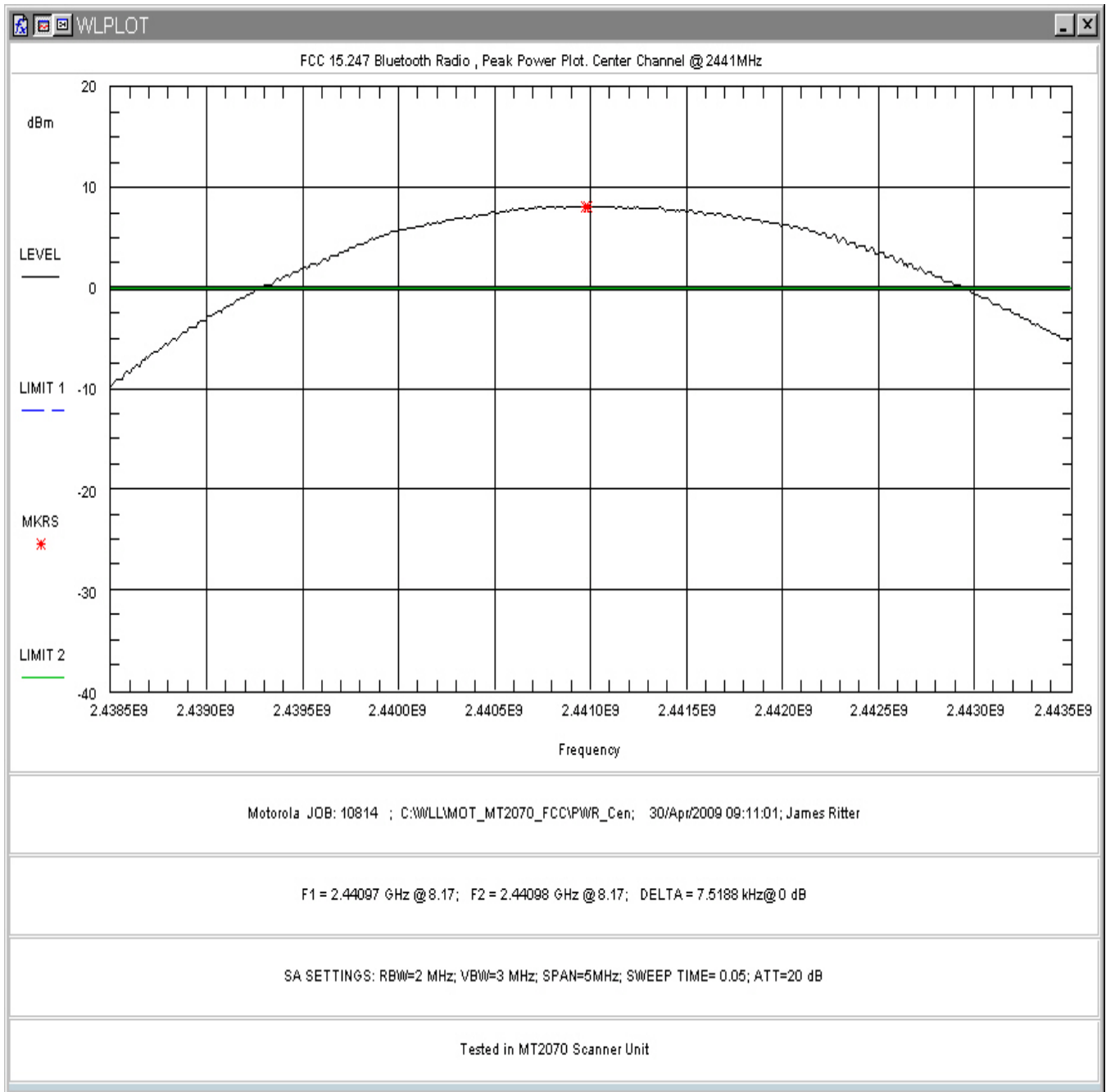

Figure 9. RF Peak Power, Mid Channel (In MT2070 Host)

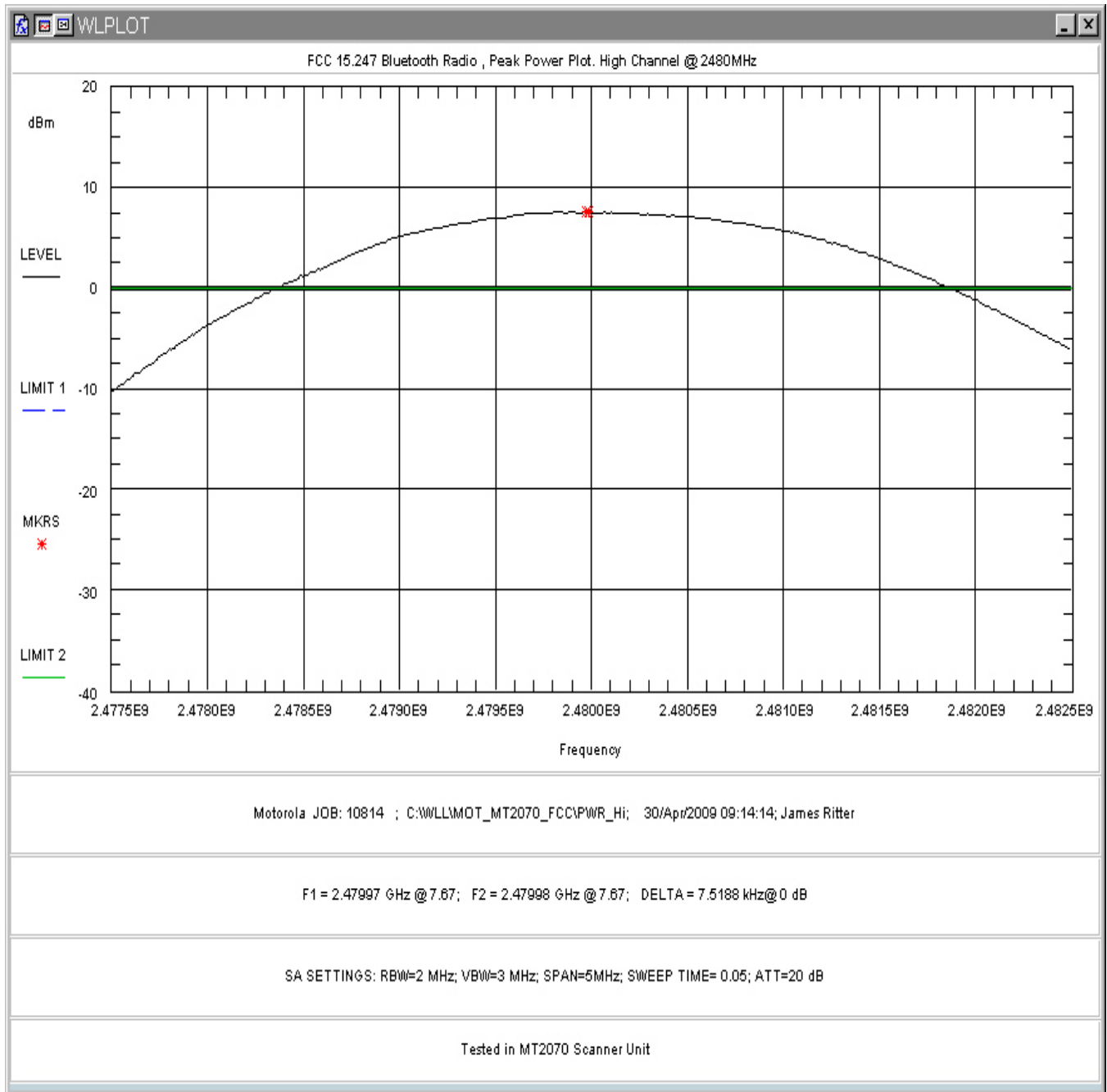

Figure 10. RF Peak Power, High Channel (In MT2070 Host)

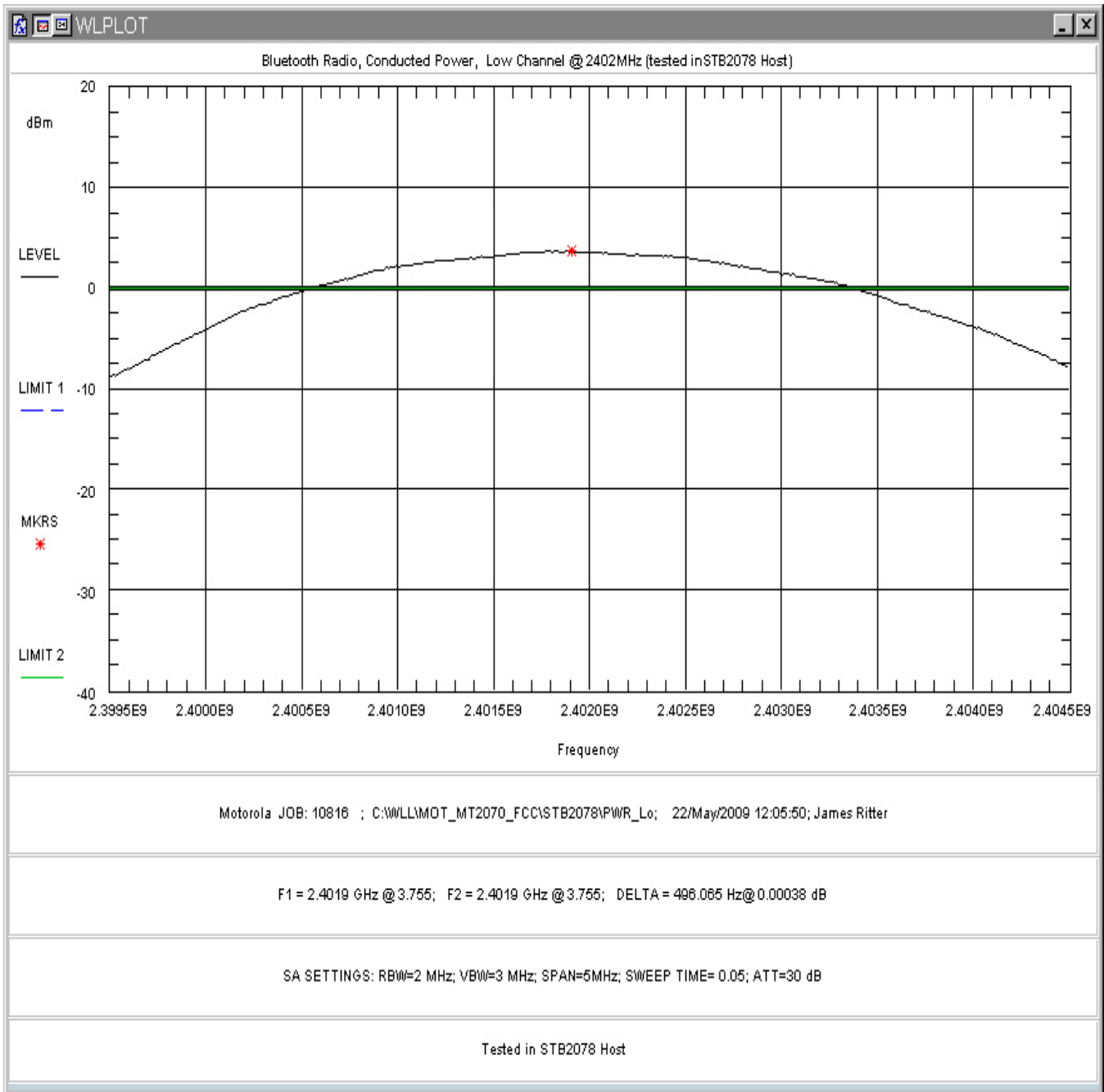

Figure 11. RF Peak Power, Low Channel (In STB2078 Host)

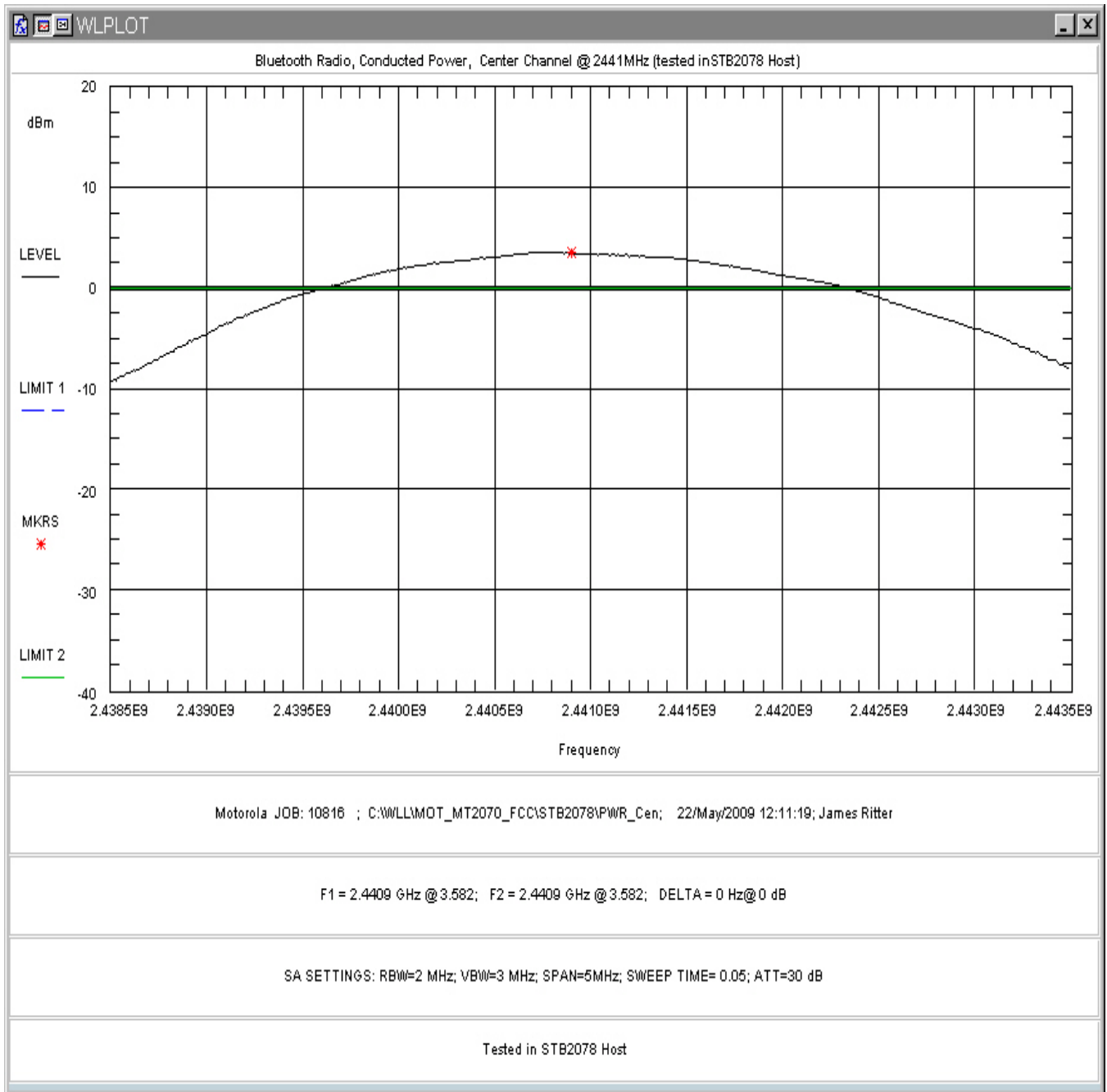

Figure 12. RF Peak Power, Mid Channel (In STB2078 Host)

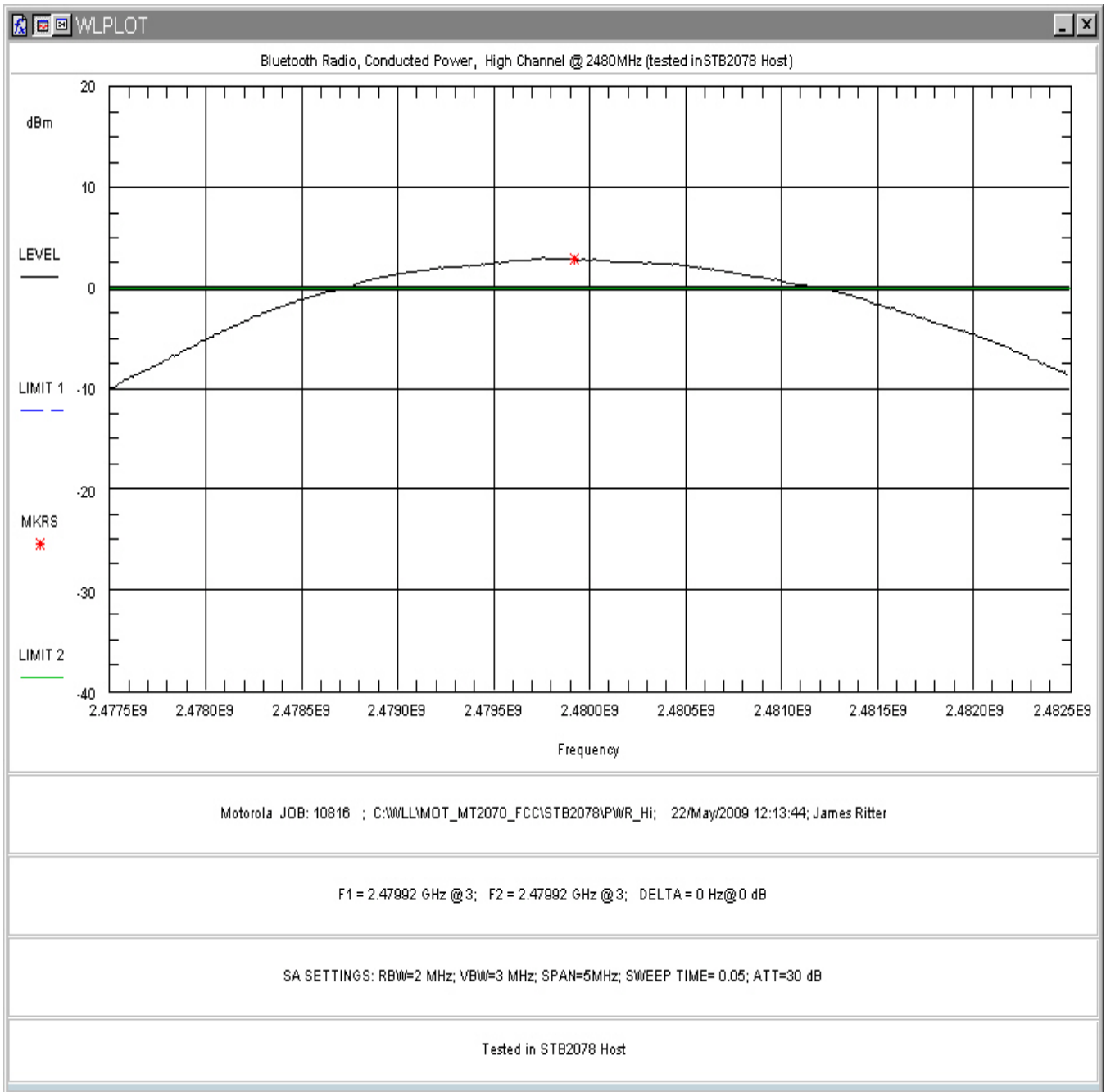

Figure 13.RF Peak Power, High Channel (In STB2078 Host)

5.3 Occupied Bandwidth: (FCC Part §2.1049)

Occupied bandwidth was performed by coupling the output of the EUT to the input of a spectrum analyzer.

At full modulation, the occupied bandwidth was measured as shown:

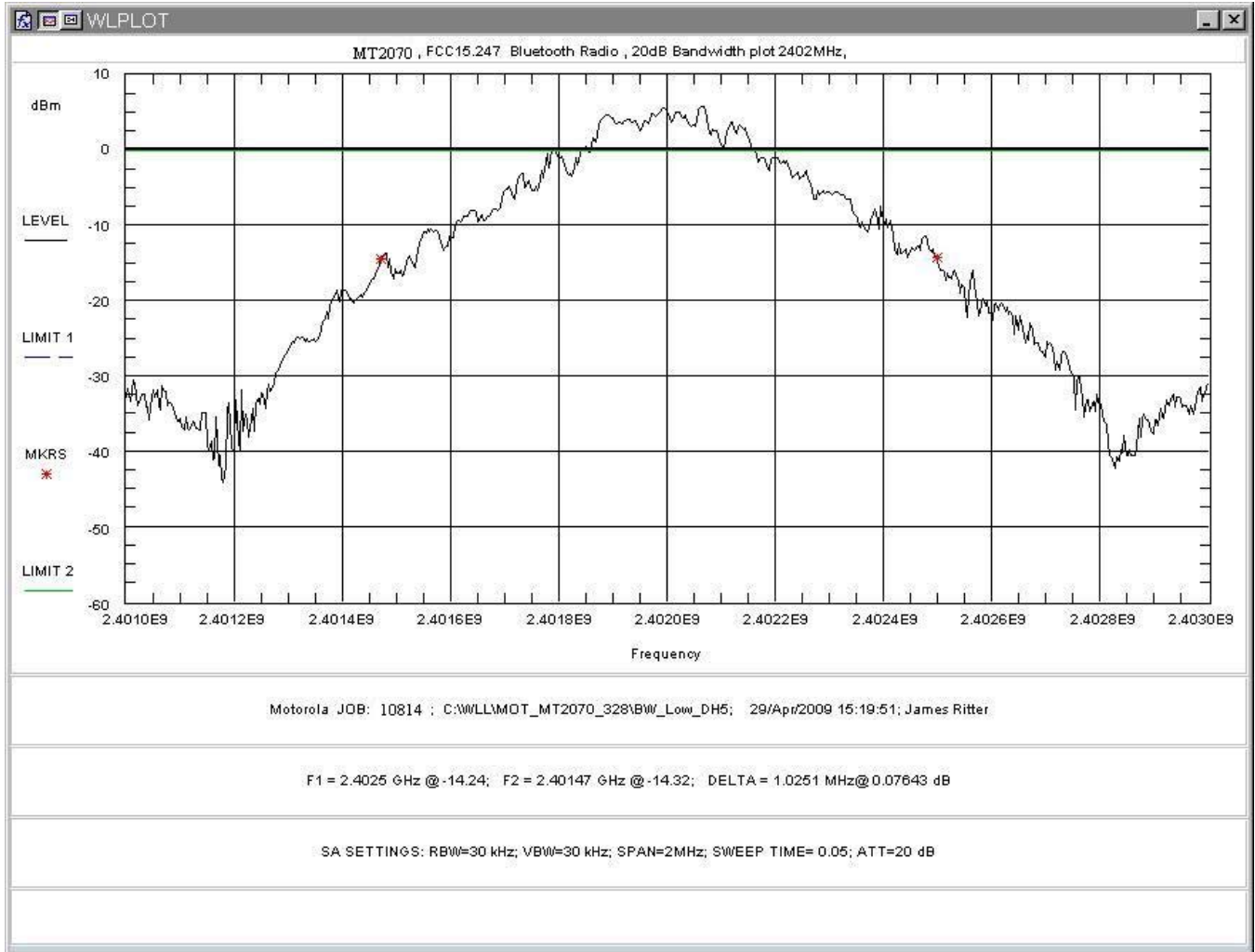

Figure 14. Occupied Bandwidth, Low Channel

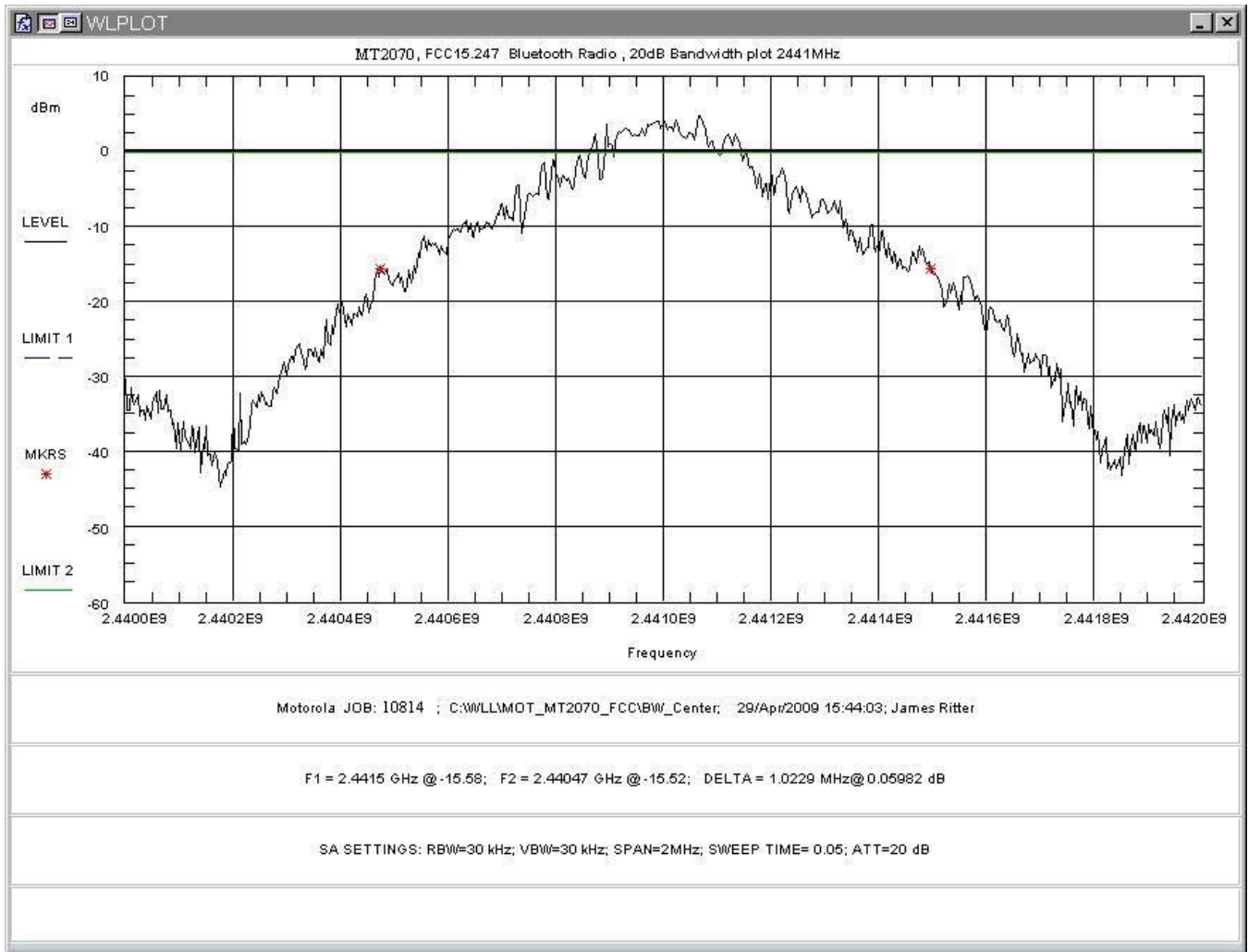

Figure 15. Occupied Bandwidth, Mid Channel

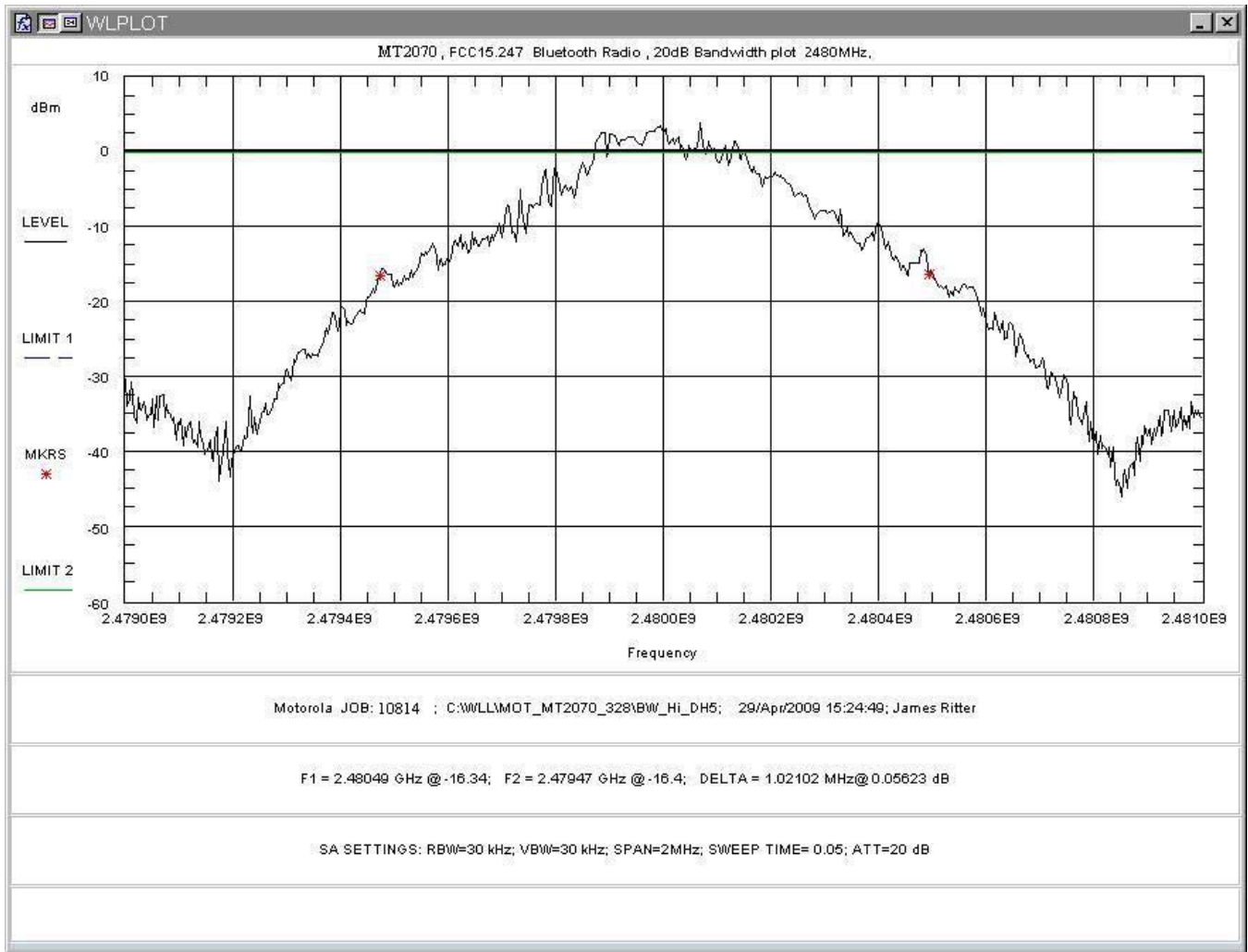

Figure 16. Occupied Bandwidth, High Channel

Table 6 provides a summary of the Occupied Bandwidth Results.

Table 6. Occupied Bandwidth Results

Frequency	Bandwidth
Low Channel: 2402MHz	1.025MHz
Mid Channel: 2441MHz	1.023MHz
High Channel: 2480MHz	1.021MHz