



FCC TEST REPORT

REPORT NO.: RF940414L04B

MODEL NO.: WLH3015
(refer to item 3.1 for other models)

RECEIVED: Jun. 16, 2006

TESTED: Jun. 20 ~ Jun. 22, 2006

ISSUED: Jun. 23, 2006

APPLICANT: ASKEY COMPUTER CORP.

ADDRESS: 10F, No.119, Chien Kang Rd., Chung-Ho,
Taipei, Taiwan, R.O.C.

ISSUED BY: Advance Data Technology Corporation

LAB ADDRESS: 47 14th Lin, Chiapau Tsun, Linko, Taipei,
Taiwan, R.O.C.

TEST LOCATION: No. 19, Hwa Ya 2nd Rd., Kueishan, Taoyuan,
Taiwan, R.O.C.

This test report consists of 71 pages in total. It may be duplicated completely for legal use with the approval of the applicant. It should not be reproduced except in full, without the written approval of our laboratory. The client should not use it to claim product endorsement by CNLA, A2LA or any government agencies. The test results in the report only apply to the tested sample.





Table of Contents

1	CERTIFICATION.....	4
2	SUMMARY OF TEST RESULTS.....	5
2.1	MEASUREMENT UNCERTAINTY.....	5
3	GENERAL INFORMATION.....	6
3.1	GENERAL DESCRIPTION OF EUT.....	6
3.2	DESCRIPTION OF TEST MODES.....	7
3.2.1	CONFIGURATION OF SYSTEM UNDER TEST.....	7
3.2.2	TEST MODE APPLICABILITY AND TESTED CHANNEL DETAIL.....	8
3.3	GENERAL DESCRIPTION OF APPLIED STANDARDS.....	10
3.4	DESCRIPTION OF SUPPORT UNITS.....	10
4	TEST TYPES AND RESULTS.....	11
4.1	CONDUCTED EMISSION MEASUREMENT.....	11
4.1.1	LIMITS OF CONDUCTED EMISSION MEASUREMENT.....	11
4.1.2	TEST INSTRUMENTS.....	11
4.1.3	TEST PROCEDURES.....	12
4.1.4	DEVIATION FROM TEST STANDARD.....	12
4.1.5	TEST SETUP.....	13
4.1.6	EUT OPERATING CONDITIONS.....	13
4.1.7	TEST RESULTS.....	14
4.2	RADIATED EMISSION MEASUREMENT.....	20
4.2.1	LIMITS OF RADIATED EMISSION MEASUREMENT.....	20
4.2.2	TEST INSTRUMENTS.....	21
4.2.3	TEST PROCEDURES.....	22
4.2.4	DEVIATION FROM TEST STANDARD.....	22
4.2.5	TEST SETUP.....	23
4.2.6	EUT OPERATING CONDITIONS.....	23
4.2.7	TEST RESULTS.....	24
4.3	6dB BANDWIDTH MEASUREMENT.....	33
4.3.1	LIMITS OF 6dB BANDWIDTH MEASUREMENT.....	33
4.3.2	TEST INSTRUMENTS.....	33
4.3.3	TEST PROCEDURE.....	34
4.3.4	DEVIATION FROM TEST STANDARD.....	34
4.3.5	TEST SETUP.....	34
4.3.6	EUT OPERATING CONDITIONS.....	34
4.3.7	TEST RESULTS.....	35
4.4	MAXIMUM PEAK OUTPUT POWER.....	43
4.4.1	LIMITS OF MAXIMUM PEAK OUTPUT POWER MEASUREMENT.....	43



4.4.2	TEST INSTRUMENTS	43
4.4.3	TEST PROCEDURES	44
4.4.4	DEVIATION FROM TEST STANDARD	44
4.4.5	TEST SETUP	44
4.4.6	EUT OPERATING CONDITIONS.....	44
4.4.7	TEST RESULTS	45
4.5	POWER SPECTRAL DENSITY MEASUREMENT.....	46
4.5.1	LIMITS OF POWER SPECTRAL DENSITY MEASUREMENT.....	46
4.5.2	TEST INSTRUMENTS.....	46
4.5.3	TEST PROCEDURE.....	47
4.5.4	DEVIATION FROM TEST STANDARD	47
4.5.5	TEST SETUP.....	47
4.5.6	EUT OPERATING CONDITIONS.....	47
4.5.7	TEST RESULTS	48
4.6	BAND EDGES MEASUREMENT.....	56
4.6.1	LIMITS OF BAND EDGES MEASUREMENT.....	56
4.6.2	TEST INSTRUMENTS.....	56
4.6.3	TEST PROCEDURE.....	56
4.6.4	DEVIATION FROM TEST STANDARD	56
4.6.5	EUT OPERATING CONDITION	56
4.6.6	TEST RESULTS	57
4.7	ANTENNA REQUIREMENT	69
4.7.1	STANDARD APPLICABLE.....	69
4.7.2	ANTENNA CONNECTED CONSTRUCTION.....	69
5	INFORMATION ON THE TESTING LABORATORIES	70
	APPENDIX-A	A-1



1 CERTIFICATION

PRODUCT : Wireless LAN PCI Card
MODEL NO.: WLH3015 (refer to item 3.1 for other models)
BRAND: Askey (refer to item 3.1 for other brands)
APPLICANT : ASKEY COMPUTER CORP.
TESTED: Jun. 20 ~ Jun. 22, 2006
TEST SAMPLE: ENGINEERING SAMPLE
STANDARDS : FCC Part 15, Subpart C (Section 15.247),
ANSI C63.4-2003

The above equipment has been tested by **Advance Data Technology Corporation**, and found compliance with the requirement of the above standards. The test record, data evaluation & Equipment Under Test (EUT) configurations represented herein are true and accurate accounts of the measurements of the sample's EMC characteristics under the conditions specified in this report.

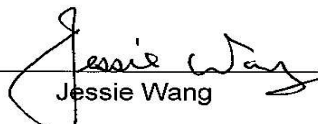
PREPARED BY :  , **DATE:** Jun. 23, 2006
Jessie Wang

TECHNICAL ACCEPTANCE :  , **DATE:** Jun. 23, 2006
Responsible for RF Long Chen

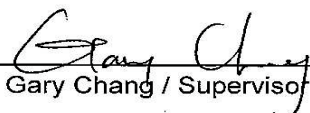
APPROVED BY :  , **DATE:** Jun. 23, 2006
Gary Chang / Supervisor

2 SUMMARY OF TEST RESULTS

The EUT has been tested according to the following specifications:

APPLIED STANDARD: FCC Part 15, Subpart C			
Standard Section	Test Type and Limit	Result	REMARK
15.207	AC Power Conducted Emission	PASS	Meet the requirement of limit. Minimum passing margin is -15.04dB at 0.638MHz.
15.247(a)(2)	Spectrum Bandwidth of a Direct Sequence Spread Spectrum System Limit : min. 500kHz	PASS	Meet the requirement of limit.
15.247(b)	Maximum Peak Output Power Limit: max. 30dBm	PASS	Meet the requirement of limit.
15.247(d)	Transmitter Radiated Emissions Limit: Table 15.209	PASS	Meet the requirement of limit. Minimum passing margin is -1.72dB at 234.11MHz.
15.247(e)	Power Spectral Density Limit: max. 8dBm	PASS	Meet the requirement of limit.
15.247(d)	Band Edge Measurement Limit: 20 dB less than the peak value of fundamental frequency	PASS	Meet the requirement of limit.

2.1 MEASUREMENT UNCERTAINTY

Where relevant, the following measurement uncertainty levels have been estimated for tests performed on the EUT as specified in CISPR 16-4:

Measurement	Frequency	Uncertainty
Conducted emissions	9kHz~30MHz	2.44 dB
Radiated emissions	30MHz ~ 200MHz	3.64 dB
	200MHz ~1000MHz	3.65 dB
	1GHz ~ 18GHz	2.26 dB
	18GHz ~ 40GHz	1.94 dB



3 GENERAL INFORMATION

3.1 GENERAL DESCRIPTION OF EUT

PRODUCT	Wireless LAN PCI Card
MODEL NO.	WLH3015
FCC ID	H8NWLH3015
POWER SUPPLY	3.3Vdc from host equipment
MODULATION TYPE	CCK, DQPSK, DBPSK for DSSS 64QAM, 16QAM, QPSK, BPSK for OFDM
MODULATION TECHNOLOGY	DSSS, OFDM
TRANSFER RATE	802.11b: 11/5.5/2/1Mbps 802.11g: 54/48/36/24/18/12/9/6Mbps (Turbo mode: up to 125Mbps *see Note 5)
FREQUENCY RANGE	2412MHz ~ 2462MHz
NUMBER OF CHANNEL	11 for Normal mode 1 for turbo mode
MAXIMUM OUTPUT POWER	32.509mW
ANTENNA TYPE	Dipole antenna with 2dBi gain
DATA CABLE	NA
I/O PORTS	NA

NOTE:

1. This report is issued as a supplementary report of ADT report no.: RF940414L04.
2. This report is prepared for FCC class II permissive change. Please refer to the information as below for the difference compared with the original design.

Original	Class II Change
Original PCB layout	Modified PCB layout (GND ground)
IC components (sky65206-11)	IC components (sky65206-13)

3. The EUT complies with IEEE 802.11g standards and backwards compatible with IEEE 802.11b products.
4. The EUT operates in the 2.4GHz frequency spectrum with throughput of up to 54Mbps.
5. This EUT is capable of providing data rates of up to 125Mbps in Turbo Mode depending upon reception quality.
6. The model as below are identical to each other expect for their brand name.

Brand	Model Name	Description
Askey	WLH3015	with turbo mode
Belkin	F5D7001	with turbo mode

7. The above EUT information was declared by manufacturer and for more detailed features description, please refer to the manufacturer's specifications or User's Manual.

3.2 DESCRIPTION OF TEST MODES

For 802.11b/g: Eleven channels are provided to this EUT for normal mode.

Channel	Frequency	Channel	Frequency
1	2412 MHz	7	2442 MHz
2	2417 MHz	8	2447 MHz
3	2422 MHz	9	2452 MHz
4	2427 MHz	10	2457 MHz
5	2432 MHz	11	2462 MHz
6	2437 MHz		

For 802.11g: One channel is provided to this EUT for turbo mode.

Channel	Frequency
6	2437 MHz

3.2.1 CONFIGURATION OF SYSTEM UNDER TEST

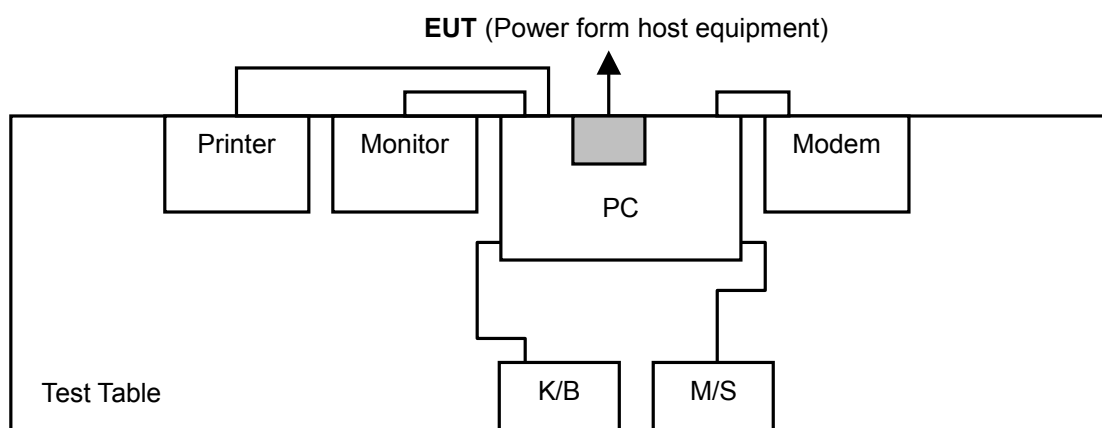

3.2.2 TEST MODE APPLICABILITY AND TESTED CHANNEL DETAIL

EUT CONFIGURE MODE	APPLICABLE TO				DESCRIPTION
	PLC	RE<1G	RE≥1G	APCM	
-	√	√	√	√	-

Where **PLC**: Power Line Conducted Emission **RE<1G**: Radiated Emission below 1GHz
RE≥1G: Radiated Emission above 1GHz **APCM**: Antenna Port Conducted Measurement

POWER LINE CONDUCTED EMISSION TEST:

- Pre-Scan has been conducted to determine the worst-case mode from all possible combinations between available modulations, data rates and antenna ports (if EUT with antenna diversity architecture).
- Following channel(s) was (were) selected for the final test as listed below.

MODE	AVAILABLE CHANNEL	TESTED CHANNEL	MODULATION TECHNOLOGY	MODULATION TYPE	DATA RATE (Mbps)
802.11g	1 to 11	1, 6, 11	OFDM	BPSK	6

RADIATED EMISSION TEST (BELOW 1 GHz):

- Pre-Scan has been conducted to determine the worst-case mode from all possible combinations between available modulations, data rates and antenna ports (if EUT with antenna diversity architecture).
- Following channel(s) was (were) selected for the final test as listed below.

MODE	AVAILABLE CHANNEL	TESTED CHANNEL	MODULATION TECHNOLOGY	MODULATION TYPE	DATA RATE (Mbps)
802.11g	1 to 11	11	OFDM	BPSK	6
802.11g Turbo	6	6	OFDM	QPSK	12

RADIATED EMISSION TEST (ABOVE 1 GHz):

- Pre-Scan has been conducted to determine the worst-case mode from all possible combinations between available modulations, data rates and antenna ports (if EUT with antenna diversity architecture).
- Following channel(s) was (were) selected for the final test as listed below.

MODE	AVAILABLE CHANNEL	TESTED CHANNEL	MODULATION TECHNOLOGY	MODULATION TYPE	DATA RATE (Mbps)
802.11b	1 to 11	1, 6, 11	DSSS	CCK	11
802.11g	1 to 11	1, 6, 11	OFDM	BPSK	6
802.11g Turbo	6	6	OFDM	QPSK	12

BANDEDGE MEASUREMENT:

- Pre-Scan has been conducted to determine the worst-case mode from all possible combinations between available modulations, data rates and antenna ports (if EUT with antenna diversity architecture).
- Following channel(s) was (were) selected for the final test as listed below.

MODE	AVAILABLE CHANNEL	TESTED CHANNEL	MODULATION TECHNOLOGY	MODULATION TYPE	DATA RATE (Mbps)
802.11b	1 to 11	1, 11	DSSS	CCK	11
802.11g	1 to 11	1, 11	OFDM	BPSK	6
802.11g Turbo	6	6	OFDM	QPSK	12

ANTENNA PORT CONDUCTED MEASUREMENT:

- Pre-Scan has been conducted to determine the worst-case mode from all possible combinations between available modulations, data rates and antenna ports (if EUT with antenna diversity architecture).
- Following channel(s) was (were) selected for the final test as listed below.

MODE	AVAILABLE CHANNEL	TESTED CHANNEL	MODULATION TECHNOLOGY	MODULATION TYPE	DATA RATE (Mbps)
802.11b	1 to 11	1, 6, 11	DSSS	CCK	11
802.11g	1 to 11	1, 6, 11	OFDM	BPSK	6
802.11g Turbo	6	6	OFDM	QPSK	12



3.3 GENERAL DESCRIPTION OF APPLIED STANDARDS

The EUT is a RF product. According to the specifications of the manufacturer, it must comply with the requirements of the following standards:

FCC Part 15, Subpart C. (15.247)

ANSI C63.4-2003

All test items have been performed and recorded as per the above standards.

NOTE: The EUT is also considered as a kind of computer peripheral, because the connection to computer is necessary for typical use. It has been verified to comply with the requirements of FCC Part 15, Subpart B, Class B (DoC). The test report has been issued separately.

3.4 DESCRIPTION OF SUPPORT UNITS

The EUT has been tested as an independent unit together with other necessary accessories or support units. The following support units or accessories were used to form a representative test configuration during the tests.

NO.	PRODUCT	BRAND	MODEL NO.	SERIAL NO.	FCC ID
1	PERSONAL COMPUTER	SoftStar	Hetis 865G	380125734	FCC DoC Approved
2	LCD MONITOR	ACER	AL1721	ET.L0408.01040 4001F9PK00	FCC DoC Approved
3	PRINTER	EPSON	LQ-300+	DCGY047265	FCC DoC Approved
4	MODEM	ACEEX	1414V/3	0401008248	IFAXDM1414
5	KEYBOARD	DELL	SK-8115	CN-0J4635- 71616-53A- 0CH2	NA
6	MOUSE	ASUS	M-UV55a	LNA42312842	NA

NO.	SIGNAL CABLE DESCRIPTION OF THE ABOVE SUPPORT UNITS
1	NA
2	1.8m shielded cable.
3	1.5m shielded cable.
4	1.8m shielded cable.
5	1.2m shielded cable.
6	1.2m shielded cable.

NOTE: All power cords of the above support units are non shielded (1.8m).

4 TEST TYPES AND RESULTS

4.1 CONDUCTED EMISSION MEASUREMENT

4.1.1 LIMITS OF CONDUCTED EMISSION MEASUREMENT

FREQUENCY OF EMISSION (MHz)	CONDUCTED LIMIT (dB μ V)	
	Quasi-peak	Average
0.15-0.5	66 to 56	56 to 46
0.5-5	56	46
5-30	60	50

- NOTE:**
1. The lower limit shall apply at the transition frequencies.
 2. The limit decreases in line with the logarithm of the frequency in the range of 0.15 to 0.50 MHz.
 3. All emanations from a class A/B digital device or system, including any network of conductors and apparatus connected thereto, shall not exceed the level of field strengths specified above.

4.1.2 TEST INSTRUMENTS

DESCRIPTION & MANUFACTURER	MODEL NO.	SERIAL NO.	CALIBRATED UNTIL
Test Receiver ROHDE & SCHWARZ	ESCS30	100291	Nov. 11, 2006
RF signal cable Woken	5D-FB	Cable-HYC01-01	Jan. 06, 2007
LISN ROHDE & SCHWARZ	ESH3-Z5	100312	Feb. 15, 2007
LISN ROHDE & SCHWARZ	ESH2-Z5	100104	Feb. 07, 2007
Software ADT	ADT_Cond_V3	NA	NA

- NOTE:**
1. The calibration interval of the above test instruments is 12 months and the calibrations are traceable to NML/ROC and NIST/USA.
 2. The test was performed in HwaYa Shielded Room 1.
 3. The VCCI Site Registration No. is C-2040.

4.1.3 TEST PROCEDURES

- a. The EUT was placed 0.4 meters from the conducting wall of the shielded room with EUT being connected to the power mains through a line impedance stabilization network (LISN). Other support units were connected to the power mains through another LISN. The two LISNs provide 50 ohm/ 50uH of coupling impedance for the measuring instrument.
- b. Both lines of the power mains connected to the EUT were checked for maximum conducted interference.
- c. The frequency range from 150kHz to 30MHz was searched. Emission levels under Limit - 20dB was not recorded.

4.1.4 DEVIATION FROM TEST STANDARD

No deviation

4.1.5 TEST SETUP

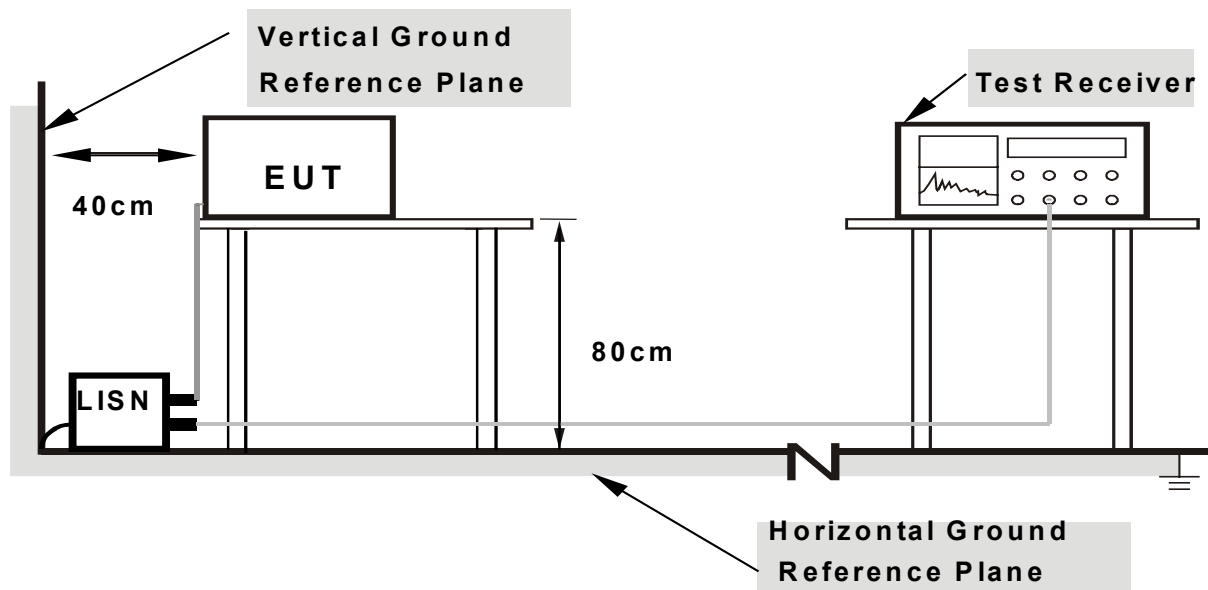

- Note:**
1. Support units were connected to second LISN.
 2. Both of LISNs (AMN) are 80 cm from EUT and at least 80 cm from other units and other metal planes

For the actual test configuration, please refer to the related item – Photographs of the Test Configuration.

4.1.6 EUT OPERATING CONDITIONS

- a. Plugged the EUT to a personal computer and placed on a testing table.
- b. The personal computer ran a test program (provided by manufacturer) to enable EUT under transmission condition continuously at specific channel frequency.
- c. The personal computer show "H" messages to LCD monitor and displayed on the screen.
- d. The personal computer show "H" messages to modem.
- e. The personal computer sent "H" messages to printer, and the printer prints them on paper.
- f. Repeated c ~e.

4.1.7 TEST RESULTS

Conducted Worst-Case Data

EUT TEST CONDITION		MEASUREMENT DETAIL	
CHANNEL	Channel 1	PHASE	Line 1
MODULATION TYPE	BPSK	6dB BANDWIDTH	9 kHz
TRANSFER RATE	6Mbps	INPUT POWER (SYSTEM)	120Vac, 60 Hz
ENVIRONMENTAL CONDITIONS	25deg. C, 65%RH, 991hPa	TESTED BY	Long Chen

No	Freq. [MHz]	Corr. Factor (dB)	Reading Value [dB (uV)]		Emission Level [dB (uV)]		Limit [dB (uV)]		Margin (dB)	
			Q.P.	AV.	Q.P.	AV.	Q.P.	AV.	Q.P.	AV.
1	0.193	0.10	46.13	-	46.23	-	63.91	53.91	-17.68	-
2	0.255	0.10	38.53	-	38.63	-	61.58	51.58	-22.95	-
3	0.447	0.11	37.21	-	37.32	-	56.93	46.93	-19.62	-
4	0.955	0.19	35.83	-	36.02	-	56.00	46.00	-19.98	-
5	0.955	0.19	35.81	-	36.00	-	56.00	46.00	-20.00	-
6	1.465	0.20	34.65	-	34.85	-	56.00	46.00	-21.15	-
7	23.227	0.96	32.27	-	33.23	-	60.00	50.00	-26.77	-

- REMARKS:**
1. Q.P. and AV. are abbreviations of quasi-peak and average individually.
 2. "-": The Quasi-peak reading value also meets average limit and measurement with the average detector is unnecessary.
 3. The emission levels of other frequencies were very low against the limit.
 4. Margin value = Emission level - Limit value
 5. Correction factor = Insertion loss + Cable loss
 6. Emission Level = Correction Factor + Reading Value.

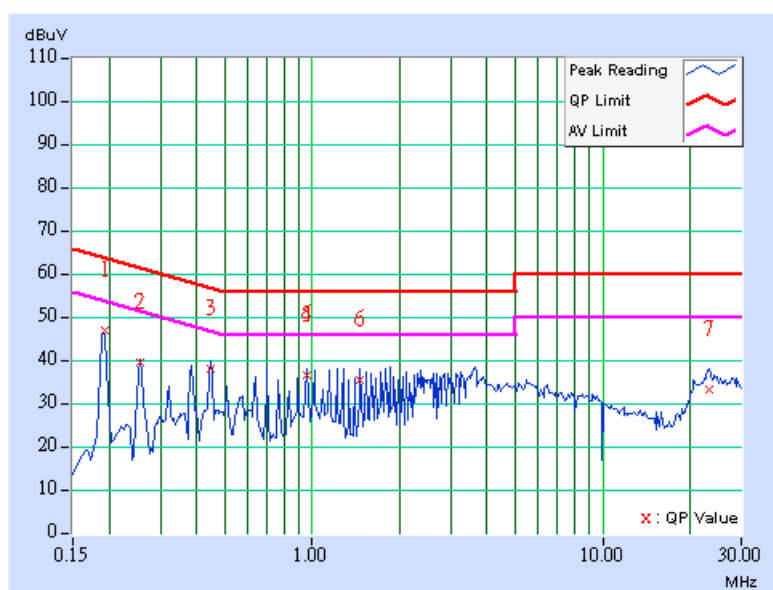

EUT TEST CONDITION		MEASUREMENT DETAIL	
CHANNEL	Channel 1	PHASE	Line 2
MODULATION TYPE	BPSK	6dB BANDWIDTH	9 kHz
TRANSFER RATE	6Mbps	INPUT POWER (SYSTEM)	120Vac, 60 Hz
ENVIRONMENTAL CONDITIONS	25deg. C, 65%RH, 991hPa	TESTED BY	Long Chen

No	Freq. [MHz]	Corr. Factor (dB)	Reading Value [dB (uV)]		Emission Level [dB (uV)]		Limit [dB (uV)]		Margin (dB)	
			Q.P.	AV.	Q.P.	AV.	Q.P.	AV.	Q.P.	AV.
1	0.193	0.10	44.07	-	44.17	-	63.91	53.91	-19.74	-
2	0.384	0.10	41.66	-	41.76	-	58.18	48.18	-16.42	-
3	0.638	0.10	40.86	-	40.96	-	56.00	46.00	-15.04	-
4	0.892	0.10	40.69	-	40.79	-	56.00	46.00	-15.21	-
5	1.211	0.12	38.21	-	38.33	-	56.00	46.00	-17.67	-
6	3.762	0.35	34.83	-	35.18	-	56.00	46.00	-20.82	-

- REMARKS:**
1. Q.P. and AV. are abbreviations of quasi-peak and average individually.
 2. "-": The Quasi-peak reading value also meets average limit and measurement with the average detector is unnecessary.
 3. The emission levels of other frequencies were very low against the limit.
 4. Margin value = Emission level - Limit value
 5. Correction factor = Insertion loss + Cable loss
 6. Emission Level = Correction Factor + Reading Value.

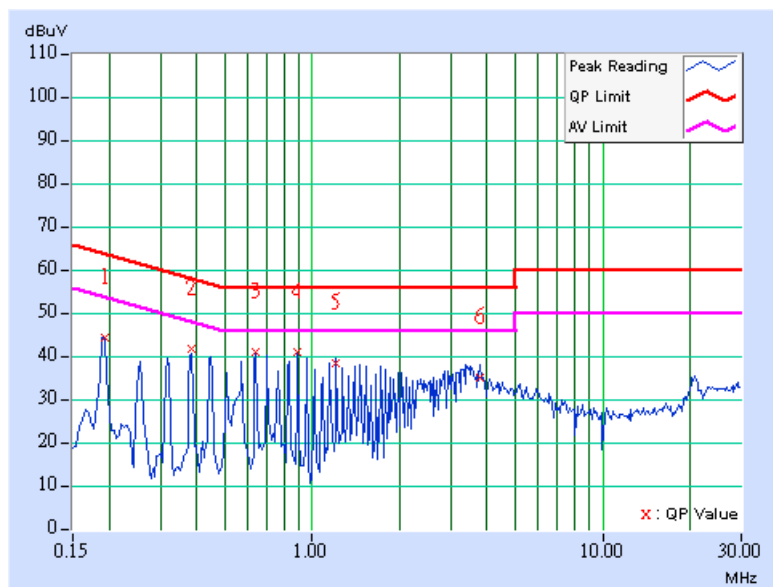

EUT TEST CONDITION		MEASUREMENT DETAIL	
CHANNEL	Channel 6	PHASE	Line 1
MODULATION TYPE	BPSK	6dB BANDWIDTH	9 kHz
TRANSFER RATE	6Mbps	INPUT POWER (SYSTEM)	120Vac, 60 Hz
ENVIRONMENTAL CONDITIONS	25deg. C, 65%RH, 991hPa	TESTED BY	Long Chen

No	Freq. [MHz]	Corr. Factor (dB)	Reading Value [dB (uV)]		Emission Level [dB (uV)]		Limit [dB (uV)]		Margin (dB)	
			Q.P.	AV.	Q.P.	AV.	Q.P.	AV.	Q.P.	AV.
1	0.193	0.10	46.20	-	46.30	-	63.91	53.91	-17.61	-
2	0.255	0.10	38.61	-	38.71	-	61.58	51.58	-22.87	-
3	0.447	0.11	37.25	-	37.36	-	56.93	46.93	-19.58	-
4	0.638	0.14	35.24	-	35.38	-	56.00	46.00	-20.62	-
5	0.959	0.19	36.81	-	37.00	-	56.00	46.00	-19.00	-
6	1.785	0.20	35.31	-	35.51	-	56.00	46.00	-20.49	-

- REMARKS:**
1. Q.P. and AV. are abbreviations of quasi-peak and average individually.
 2. "-": The Quasi-peak reading value also meets average limit and measurement with the average detector is unnecessary.
 3. The emission levels of other frequencies were very low against the limit.
 4. Margin value = Emission level - Limit value
 5. Correction factor = Insertion loss + Cable loss
 6. Emission Level = Correction Factor + Reading Value.

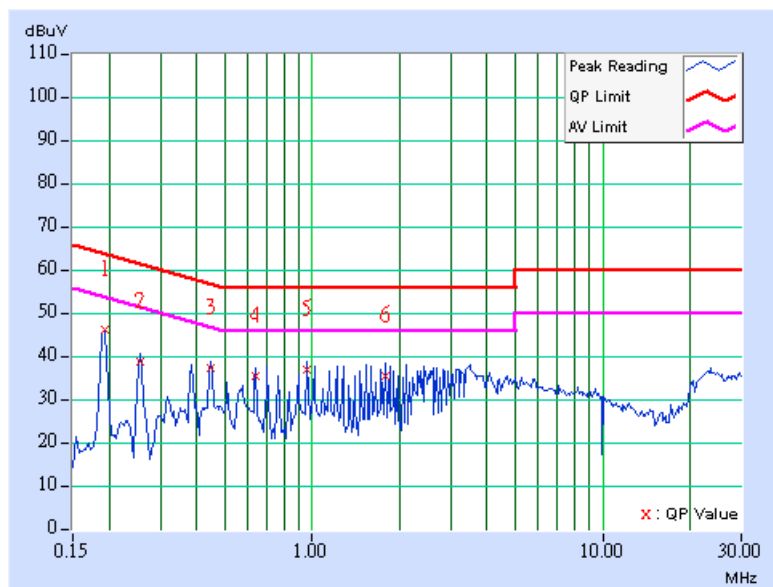

EUT TEST CONDITION		MEASUREMENT DETAIL	
CHANNEL	Channel 6	PHASE	Line 2
MODULATION TYPE	BPSK	6dB BANDWIDTH	9 kHz
TRANSFER RATE	6Mbps	INPUT POWER (SYSTEM)	120Vac, 60 Hz
ENVIRONMENTAL CONDITIONS	25deg. C, 65%RH, 991hPa	TESTED BY	Long Chen

No	Freq. [MHz]	Corr. Factor (dB)	Reading Value [dB (uV)]		Emission Level [dB (uV)]		Limit [dB (uV)]		Margin (dB)	
			Q.P.	AV.	Q.P.	AV.	Q.P.	AV.	Q.P.	AV.
1	0.189	0.10	42.49	-	42.59	-	64.08	54.08	-21.49	-
2	0.384	0.10	41.00	-	41.10	-	58.18	48.18	-17.08	-
3	0.447	0.10	39.95	-	40.05	-	56.93	46.93	-16.88	-
4	0.638	0.10	39.94	-	40.04	-	56.00	46.00	-15.96	-
5	0.959	0.10	39.90	-	40.00	-	56.00	46.00	-16.00	-
6	1.535	0.15	37.07	-	37.22	-	56.00	46.00	-18.78	-

- REMARKS:**
1. Q.P. and AV. are abbreviations of quasi-peak and average individually.
 2. "-": The Quasi-peak reading value also meets average limit and measurement with the average detector is unnecessary.
 3. The emission levels of other frequencies were very low against the limit.
 4. Margin value = Emission level - Limit value
 5. Correction factor = Insertion loss + Cable loss
 6. Emission Level = Correction Factor + Reading Value.

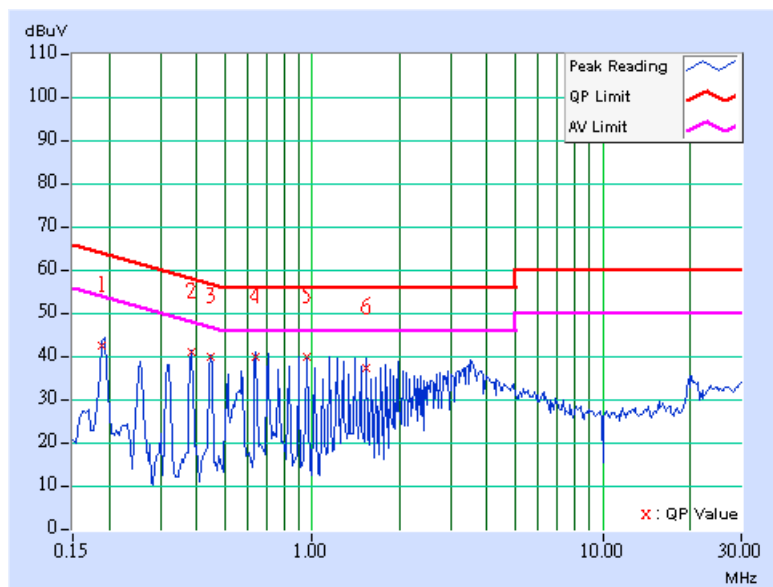

EUT TEST CONDITION		MEASUREMENT DETAIL	
CHANNEL	Channel 11	PHASE	Line 1
MODULATION TYPE	BPSK	6dB BANDWIDTH	9 kHz
TRANSFER RATE	6Mbps	INPUT POWER (SYSTEM)	120Vac, 60 Hz
ENVIRONMENTAL CONDITIONS	25deg. C, 65%RH, 991hPa	TESTED BY	Long Chen

No	Freq. [MHz]	Corr. Factor (dB)	Reading Value [dB (uV)]		Emission Level [dB (uV)]		Limit [dB (uV)]		Margin (dB)	
			Q.P.	AV.	Q.P.	AV.	Q.P.	AV.	Q.P.	AV.
1	0.193	0.10	46.46	-	46.56	-	63.91	53.91	-17.35	-
2	0.255	0.10	38.75	-	38.85	-	61.58	51.58	-22.73	-
3	0.447	0.11	37.35	-	37.46	-	56.93	46.93	-19.48	-
4	0.959	0.19	36.87	-	37.06	-	56.00	46.00	-18.94	-
5	1.281	0.20	36.48	-	36.68	-	56.00	46.00	-19.32	-
6	3.266	0.37	34.80	-	35.17	-	56.00	46.00	-20.83	-

- REMARKS:**
1. Q.P. and AV. are abbreviations of quasi-peak and average individually.
 2. "-": The Quasi-peak reading value also meets average limit and measurement with the average detector is unnecessary.
 3. The emission levels of other frequencies were very low against the limit.
 4. Margin value = Emission level - Limit value
 5. Correction factor = Insertion loss + Cable loss
 6. Emission Level = Correction Factor + Reading Value.

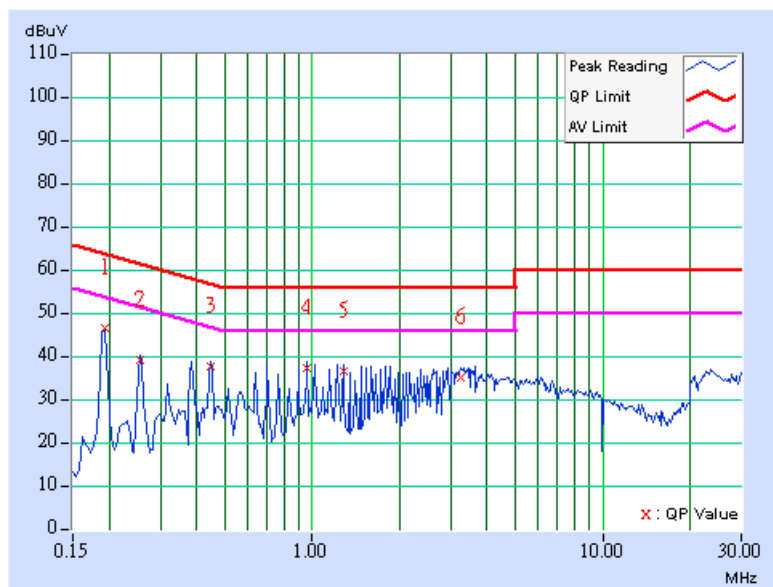

EUT TEST CONDITION		MEASUREMENT DETAIL	
CHANNEL	Channel 11	PHASE	Line 2
MODULATION TYPE	BPSK	6dB BANDWIDTH	9 kHz
TRANSFER RATE	6Mbps	INPUT POWER (SYSTEM)	120Vac, 60 Hz
ENVIRONMENTAL CONDITIONS	25deg. C, 65%RH, 991hPa	TESTED BY	Long Chen

No	Freq. [MHz]	Corr. Factor (dB)	Reading Value [dB (uV)]		Emission Level [dB (uV)]		Limit [dB (uV)]		Margin (dB)	
			Q.P.	AV.	Q.P.	AV.	Q.P.	AV.	Q.P.	AV.
1	0.193	0.10	43.98	-	44.08	-	63.91	53.91	-19.83	-
2	0.384	0.10	40.98	-	41.08	-	58.18	48.18	-17.10	-
3	0.447	0.10	39.93	-	40.03	-	56.93	46.93	-16.90	-
4	0.638	0.10	39.98	-	40.08	-	56.00	46.00	-15.92	-
5	0.959	0.10	39.88	-	39.98	-	56.00	46.00	-16.02	-
6	1.469	0.15	36.93	-	37.08	-	56.00	46.00	-18.92	-

- REMARKS:**
1. Q.P. and AV. are abbreviations of quasi-peak and average individually.
 2. "-": The Quasi-peak reading value also meets average limit and measurement with the average detector is unnecessary.
 3. The emission levels of other frequencies were very low against the limit.
 4. Margin value = Emission level - Limit value
 5. Correction factor = Insertion loss + Cable loss
 6. Emission Level = Correction Factor + Reading Value.

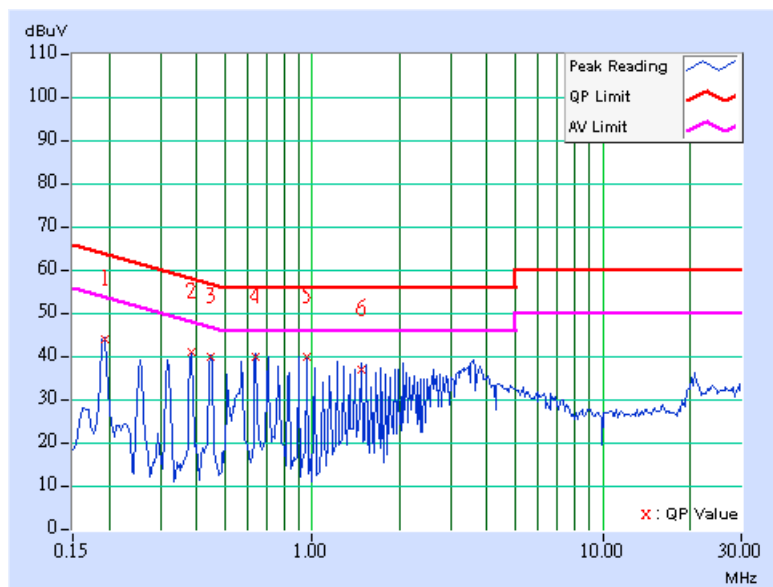

4.2 RADIATED EMISSION MEASUREMENT

4.2.1 LIMITS OF RADIATED EMISSION MEASUREMENT

Emissions radiated outside of the specified bands, shall be according to the general radiated limits in 15.209 as following:

Frequencies (MHz)	Field strength (microvolts/meter)	Measurement distance (meters)
0.009-0.490	2400/F(kHz)	300
0.490-1.705	24000/F(kHz)	30
1.705-30.0	30	30
30-88	100	3
88-216	150	3
216-960	200	3
Above 960	500	3

NOTE:

1. The lower limit shall apply at the transition frequencies.
2. Emission level (dBuV/m) = 20 log Emission level (uV/m).
3. As shown in 15.35(b), for frequencies above 1000MHz, the field strength limits are based on average detector, however, the peak field strength of any emission shall not exceed the maximum permitted average limits, specified above by more than 20dB under any condition of modulation.



4.2.2 TEST INSTRUMENTS

DESCRIPTION & MANUFACTURER	MODEL NO.	SERIAL NO.	CALIBRATED UNTIL
Test Receiver ROHDE & SCHWARZ	ESIB7	100188	Dec. 20, 2006
Spectrum Analyzer ROHDE & SCHWARZ	FSP40	100039	Nov. 27, 2006
BILOG Antenna SCHWARZBECK	VULB9168	9168-157	Jan. 15, 2007
HORN Antenna SCHWARZBECK	BBHA 9120 D	9120D-407	Jan. 22, 2007
HORN Antenna SCHWARZBECK	BBHA 9170	BBHA9170147	Jan. 26, 2007
Preamplifier Agilent	8449B	3008A01961	Oct. 23, 2006
Preamplifier Agilent	8447D	2944A10629	Oct. 27, 2006
RF signal cable HUBER+SUHNER	SUCOFLEX 104	214380/4	Jan. 16, 2007
RF signal cable HUBER+SUHNER	SUCOFLEX 104	219266/4	Jan. 16, 2007
Software ADT.	ADT_Radiated_V5.14	NA	NA
Antenna Tower ADT.	AT100	AT93021702	NA
Turn Table ADT.	TT100.	TT93021702	NA
Controller ADT.	SC100.	SC93021702	NA

- NOTE:**
1. The calibration interval of the above test instruments is 12 months and the calibrations are traceable to NML/ROC and NIST/USA.
 2. The test was performed in HwaYa Chamber 1.
 3. The horn antenna and HP preamplifier (model: 8449B) are used only for the measurement of emission frequency above 1GHz if tested.
 4. The IC Site Registration No. is IC4924-2.

4.2.3 TEST PROCEDURES

- a. The EUT was placed on the top of a rotating table 0.8 meters above the ground at a 3 meter semi-anechoic chamber. The table was rotated 360 degrees to determine the position of the highest radiation.
- b. The EUT was set 3 meters away from the interference-receiving antenna, which was mounted on the top of a variable-height antenna tower.
- c. The antenna is a broadband antenna, and its height is varied from one meter to four meters above the ground to determine the maximum value of the field strength. Both horizontal and vertical polarizations of the antenna are set to make the measurement.
- d. For each suspected emission, the EUT was arranged to its worst case and then the antenna was tuned to heights from 1 meter to 4 meters and the rotatable table was turned from 0 degrees to 360 degrees to find the maximum reading.
- e. The test-receiver system was set to Peak Detect Function and Specified Bandwidth with Maximum Hold Mode.
- f. If the emission level of the EUT in peak mode was 10 dB lower than the limit specified, then testing could be stopped and the peak values of the EUT would be reported. Otherwise the emissions that did not have 10 dB margin would be re-tested one by one using peak, quasi-peak or average method as specified and then reported in a data sheet.

NOTE:

1. The resolution bandwidth and video bandwidth of test receiver/spectrum analyzer is 120kHz for Peak detection (PK) and Quasi-peak detection (QP) at frequency below 1GHz.
2. The resolution bandwidth and video bandwidth of test receiver/spectrum analyzer is 1 MHz for Peak detection at frequency above 1GHz.
3. The resolution bandwidth of test receiver/spectrum analyzer is 1 MHz and the video bandwidth is 1kHz for Average detection (AV) at frequency above 1GHz.

4.2.4 DEVIATION FROM TEST STANDARD

No deviation

4.2.5 TEST SETUP

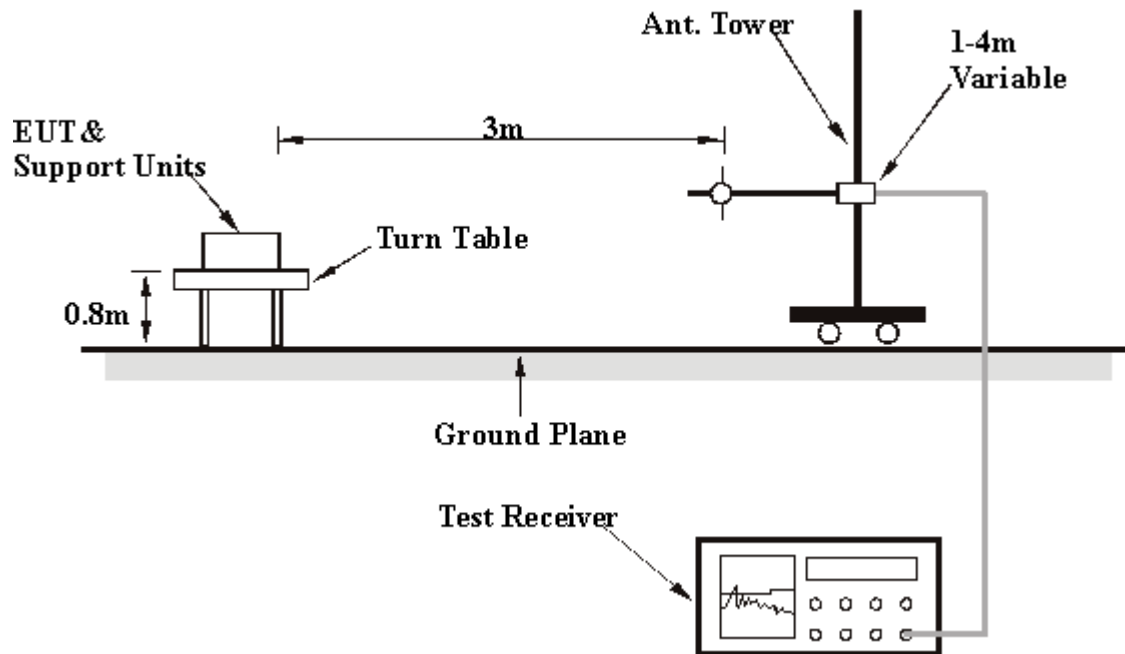

For the actual test configuration, please refer to the related item – Photographs of the Test Configuration.

4.2.6 EUT OPERATING CONDITIONS

Same as 4.1.6

4.2.7 TEST RESULTS

RADIATED WORST-CASE DATA: BELOW 1GHz - 802.11g OFDM MODULATION

EUT TEST CONDITION		MEASUREMENT DETAIL	
CHANNEL	Channel 11	FREQUENCY RANGE	Below 1000MHz
MODULATION TYPE	BPSK	DETECTOR FUNCTION	Quasi-Peak
TRANSFER RATE	6Mbps	INPUT POWER (SYSTEM)	120Vac, 60 Hz
ENVIRONMENTAL CONDITIONS	26deg. C, 66%RH, 991hPa	TESTED BY	Morgan Chen

ANTENNA POLARITY & TEST DISTANCE: HORIZONTAL AT 3 M								
No.	Freq. (MHz)	Emission Level (dBuV/m)	Limit (dBuV/m)	Margin (dB)	Antenna Height (m)	Table Angle (Degree)	Raw Value (dBuV)	Correction Factor (dB/m)
1	99.98	41.52 QP	43.50	-1.98	1.00 H	355	32.53	8.99
2	142.75	35.34 QP	43.50	-8.16	1.00 H	298	21.90	13.44
3	168.02	39.84 QP	43.50	-3.66	1.00 H	184	26.93	12.91
4	201.06	35.14 QP	43.50	-8.36	1.00 H	184	24.27	10.87
5	234.11	44.28 QP	46.00	-1.72	1.00 H	184	32.33	11.95
6	304.09	44.11 QP	46.00	-1.89	1.00 H	214	28.44	15.67
7	374.07	39.07 QP	46.00	-6.93	1.00 H	298	21.99	17.08
8	399.34	38.74 QP	46.00	-7.26	1.00 H	184	20.83	17.92
9	482.93	37.11 QP	46.00	-8.89	1.00 H	136	17.43	19.68

ANTENNA POLARITY & TEST DISTANCE: VERTICAL AT 3 M								
No.	Freq. (MHz)	Emission Level (dBuV/m)	Limit (dBuV/m)	Margin (dB)	Antenna Height (m)	Table Angle (Degree)	Raw Value (dBuV)	Correction Factor (dB/m)
1	31.94	34.39 QP	40.00	-5.61	1.00 V	25	21.85	12.54
2	99.98	40.23 QP	43.50	-3.27	1.00 V	55	31.24	8.99
3	168.02	41.36 QP	43.50	-2.14	1.00 V	166	28.45	12.91
4	236.05	40.33 QP	46.00	-5.67	1.00 V	163	28.32	12.01
5	399.34	40.90 QP	46.00	-5.10	1.00 V	166	22.99	17.92
6	480.98	40.30 QP	46.00	-5.70	1.50 V	97	20.65	19.64

- REMARKS:**
1. Emission level(dBuV/m)=Raw Value(dBuV) + Correction Factor(dB/m)
 2. Correction Factor(dB/m) = Antenna Factor (dB/m) + Cable Factor (dB)
 3. The other emission levels were very low against the limit.
 4. Margin value = Emission level – Limit value.

802.11g Turbo OFDM MODULATION

EUT TEST CONDITION		MEASUREMENT DETAIL	
CHANNEL	Channel 6	FREQUENCY RANGE	Below 1000MHz
MODULATION TYPE	QPSK	DETECTOR FUNCTION	Quasi-Peak
TRANSFER RATE	12Mbps	INPUT POWER (SYSTEM)	120Vac, 60 Hz
ENVIRONMENTAL CONDITIONS	26deg. C, 66%RH, 991hPa	TESTED BY	Morgan Chen

ANTENNA POLARITY & TEST DISTANCE: HORIZONTAL AT 3 M

No.	Freq. (MHz)	Emission Level (dBuV/m)	Limit (dBuV/m)	Margin (dB)	Antenna Height (m)	Table Angle (Degree)	Raw Value (dBuV)	Correction Factor (dB/m)
1	31.94	28.87 QP	40.00	-11.13	2.00 H	1	16.34	12.54
2	142.75	37.61 QP	43.50	-5.89	1.00 H	4	24.17	13.44
3	236.05	39.85 QP	46.00	-6.15	2.00 H	193	27.84	12.01
4	269.10	34.34 QP	46.00	-11.66	2.00 H	193	20.33	14.01
5	368.24	38.88 QP	46.00	-7.12	2.00 H	193	22.00	16.89
6	399.34	39.53 QP	46.00	-6.47	2.00 H	241	21.61	17.92
7	453.77	34.61 QP	46.00	-11.39	2.00 H	178	15.57	19.04
8	480.98	38.79 QP	46.00	-7.21	2.00 H	316	19.15	19.64
9	506.25	33.81 QP	46.00	-12.19	1.00 H	4	13.61	20.20
10	539.30	33.25 QP	46.00	-12.75	1.00 H	4	12.32	20.93
11	673.43	33.72 QP	46.00	-12.28	1.00 H	292	10.17	23.55
12	751.18	32.63 QP	46.00	-13.37	2.00 H	223	6.85	25.78

ANTENNA POLARITY & TEST DISTANCE: VERTICAL AT 3 M

No.	Freq. (MHz)	Emission Level (dBuV/m)	Limit (dBuV/m)	Margin (dB)	Antenna Height (m)	Table Angle (Degree)	Raw Value (dBuV)	Correction Factor (dB/m)
1	31.98	34.45 QP	40.00	-5.55	1.25 V	33	21.91	12.54
2	168.02	41.36 QP	43.50	-2.14	1.00 V	166	28.45	12.91
3	304.09	38.34 QP	46.00	-7.66	1.50 V	115	22.67	15.67
4	399.34	40.90 QP	46.00	-5.10	1.00 V	166	22.99	17.92
5	453.77	37.98 QP	46.00	-8.02	1.00 V	19	18.94	19.04
6	488.76	39.24 QP	46.00	-6.76	1.00 V	25	19.42	19.81

- REMARKS:**
1. Emission level(dBuV/m)=Raw Value(dBuV) + Correction Factor(dB/m)
 2. Correction Factor(dB/m) = Antenna Factor (dB/m) + Cable Factor (dB)
 3. The other emission levels were very low against the limit.
 4. Margin value = Emission level – Limit value.

802.11b DSSS MODULATION

EUT TEST CONDITION		MEASUREMENT DETAIL	
CHANNEL	Channel 1	FREQUENCY RANGE	1 ~ 25GHz
MODULATION TYPE	CCK	DETECTOR FUNCTION	Peak(PK) Average (AV)
TRANSFER RATE	11Mbps	ENVIRONMENTAL CONDITIONS	26deg. C, 66%RH, 991hPa
INPUT POWER (SYSTEM)	120Vac, 60 Hz	TESTED BY	Morgan Chen

ANTENNA POLARITY & TEST DISTANCE: HORIZONTAL AT 3 M								
No.	Freq. (MHz)	Emission Level (dBuV/m)	Limit (dBuV/m)	Margin (dB)	Antenna Height (m)	Table Angle (Degree)	Raw Value (dBuV)	Correction Factor (dB/m)
1	1608.00	44.22 PK	74.00	-29.78	1.06 H	159	15.48	28.74
1	1608.00	39.12 AV	54.00	-14.88	1.06 H	159	10.38	28.74
2	2390.00	53.68 PK	74.00	-20.32	1.00 H	13	22.29	31.39
2	2390.00	44.28 AV	54.00	-9.72	1.00 H	13	12.89	31.39
3	*2412.00	110.01 PK			1.00 H	33	78.55	31.46
3	*2412.00	102.89 AV			1.00 H	33	71.43	31.46
4	4824.00	44.83 PK	74.00	-29.17	1.00 H	298	7.70	37.13
4	4824.00	33.85 AV	54.00	-20.15	1.00 H	298	-3.28	37.13

ANTENNA POLARITY & TEST DISTANCE: VERTICAL AT 3 M								
No.	Freq. (MHz)	Emission Level (dBuV/m)	Limit (dBuV/m)	Margin (dB)	Antenna Height (m)	Table Angle (Degree)	Raw Value (dBuV)	Correction Factor (dB/m)
1	1608.00	44.48 PK	74.00	-29.52	1.36 V	168	15.74	28.74
1	1608.00	39.63 AV	54.00	-14.37	1.36 V	168	10.89	28.74
2	2390.00	54.94 PK	74.00	-19.06	1.25 V	158	23.55	31.39
2	2390.00	44.81 AV	54.00	-9.19	1.25 V	158	13.42	31.39
3	*2412.00	111.17 PK			1.09 V	149	79.71	31.46
3	*2412.00	104.14 AV			1.09 V	149	72.68	31.46
4	4824.00	46.98 PK	74.00	-27.02	1.21 V	233	9.85	37.13
4	4824.00	35.55 AV	54.00	-18.45	1.21 V	233	-1.58	37.13

- RMARKS:**
1. Emission level(dBuV/m)=Raw Value(dBuV) + Correction Factor(dB/m)
 2. Correction Factor(dB/m) = Antenna Factor (dB/m) + Cable Factor (dB)
 3. The other emission levels were very low against the limit.
 4. Margin value = Emission level – Limit value.
 5. " * " : Fundamental frequency.

EUT TEST CONDITION		MEASUREMENT DETAIL	
CHANNEL	Channel 6	FREQUENCY RANGE	1 ~ 25GHz
MODULATION TYPE	CCK	DETECTOR FUNCTION	Peak(PK) Average (AV)
TRANSFER RATE	11Mbps	ENVIRONMENTAL CONDITIONS	26deg. C, 66%RH, 991hPa
INPUT POWER (SYSTEM)	120Vac, 60 Hz	TESTED BY	Morgan Chen

ANTENNA POLARITY & TEST DISTANCE: HORIZONTAL AT 3 M

No.	Freq. (MHz)	Emission Level (dBuV/m)	Limit (dBuV/m)	Margin (dB)	Antenna Height (m)	Table Angle (Degree)	Raw Value (dBuV)	Correction Factor (dB/m)
1	1624.00	44.08 PK	74.00	-29.92	1.00 H	133	15.29	28.79
1	1624.00	38.89 AV	54.00	-15.11	1.00 H	133	10.10	28.79
2	*2437.00	110.09 PK			1.00 H	25	78.55	31.54
2	*2437.00	102.97 AV			1.00 H	25	71.43	31.54
3	4874.00	44.88 PK	74.00	-29.12	1.00 H	320	7.59	37.29
3	4874.00	33.94 AV	54.00	-20.06	1.00 H	320	-3.35	37.29

ANTENNA POLARITY & TEST DISTANCE: VERTICAL AT 3 M

No.	Freq. (MHz)	Emission Level (dBuV/m)	Limit (dBuV/m)	Margin (dB)	Antenna Height (m)	Table Angle (Degree)	Raw Value (dBuV)	Correction Factor (dB/m)
1	1624.00	44.53 PK	74.00	-29.47	1.33 V	152	15.74	28.79
1	1624.00	39.75 AV	54.00	-14.25	1.33 V	152	10.96	28.79
2	*2437.00	111.21 PK			1.13 V	152	79.67	31.54
2	*2437.00	104.08 AV			1.13 V	152	72.54	31.54
3	4874.00	46.55 PK	74.00	-27.45	1.25 V	242	9.26	37.29
3	4874.00	34.95 AV	54.00	-19.05	1.25 V	242	-2.34	37.29

- REMARKS:**
1. Emission level(dBuV/m)=Raw Value(dBuV) + Correction Factor(dB/m)
 2. Correction Factor(dB/m) = Antenna Factor (dB/m) + Cable Factor (dB)
 3. The other emission levels were very low against the limit.
 4. Margin value = Emission level – Limit value.
 5. “ * “ : Fundamental frequency.

EUT TEST CONDITION		MEASUREMENT DETAIL	
CHANNEL	Channel 11	FREQUENCY RANGE	1 ~ 25GHz
MODULATION TYPE	CCK	DETECTOR FUNCTION	Peak(PK) Average (AV)
TRANSFER RATE	11Mbps	ENVIRONMENTAL CONDITIONS	26deg. C, 66%RH, 991hPa
INPUT POWER (SYSTEM)	120Vac, 60 Hz	TESTED BY	Morgan Chen

ANTENNA POLARITY & TEST DISTANCE: HORIZONTAL AT 3 M								
No.	Freq. (MHz)	Emission Level (dBuV/m)	Limit (dBuV/m)	Margin (dB)	Antenna Height (m)	Table Angle (Degree)	Raw Value (dBuV)	Correction Factor (dB/m)
1	1641.00	44.60 PK	90.12	-45.52	1.08 H	165	15.75	28.85
1	1641.00	39.45 AV	83.02	-43.57	1.08 H	165	10.60	28.85
2	*2462.00	110.12 PK			1.00 H	29	78.50	31.62
2	*2462.00	103.02 AV			1.00 H	29	71.40	31.62
3	2483.50	53.71 PK	74.00	-20.29	1.00 H	42	22.01	31.70
3	2483.50	44.39 AV	54.00	-9.61	1.00 H	42	12.69	31.70
4	4924.00	44.98 PK	74.00	-29.02	1.00 H	329	7.54	37.44
4	4924.00	34.09 AV	54.00	-19.91	1.00 H	329	-3.35	37.44

ANTENNA POLARITY & TEST DISTANCE: VERTICAL AT 3 M								
No.	Freq. (MHz)	Emission Level (dBuV/m)	Limit (dBuV/m)	Margin (dB)	Antenna Height (m)	Table Angle (Degree)	Raw Value (dBuV)	Correction Factor (dB/m)
1	1641.00	45.82 PK	91.29	-45.47	1.02 V	171	16.97	28.85
1	1641.00	40.57 AV	84.09	-43.52	1.02 V	171	11.72	28.85
2	*2462.00	111.29 PK			1.10 V	157	79.67	31.62
2	*2462.00	104.09 AV			1.10 V	157	72.47	31.62
3	2483.50	54.85 PK	74.00	-19.15	1.08 V	150	23.15	31.70
3	2483.50	45.59 AV	54.00	-8.41	1.08 V	150	13.89	31.70
4	4924.00	46.03 PK	74.00	-27.97	1.35 V	101	8.59	37.44
4	4924.00	34.40 AV	54.00	-19.60	1.35 V	101	-3.04	37.44

- REMARKS:**
1. Emission level(dBuV/m)=Raw Value(dBuV) + Correction Factor(dB/m)
 2. Correction Factor(dB/m) = Antenna Factor (dB/m) + Cable Factor (dB)
 3. The other emission levels were very low against the limit.
 4. Margin value = Emission level – Limit value.
 5. “ * “ : Fundamental frequency.

802.11g OFDM MODULATION

EUT TEST CONDITION		MEASUREMENT DETAIL	
CHANNEL	Channel 1	FREQUENCY RANGE	1 ~ 25GHz
MODULATION TYPE	BPSK	DETECTOR FUNCTION	Peak(PK) Average (AV)
TRANSFER RATE	6Mbps	ENVIRONMENTAL CONDITIONS	26deg. C, 66%RH, 991hPa
INPUT POWER (SYSTEM)	120Vac, 60 Hz	TESTED BY	Morgan Chen

ANTENNA POLARITY & TEST DISTANCE: HORIZONTAL AT 3 M

No.	Freq. (MHz)	Emission Level (dBuV/m)	Limit (dBuV/m)	Margin (dB)	Antenna Height (m)	Table Angle (Degree)	Raw Value (dBuV)	Correction Factor (dB/m)
1	1608.00	43.08 PK	74.00	-30.92	1.08 H	241	14.34	28.74
1	1608.00	39.03 AV	54.00	-14.97	1.08 H	241	10.29	28.74
2	2390.00	59.35 PK	74.00	-14.65	1.00 H	69	27.96	31.39
2	2390.00	46.23 AV	54.00	-7.77	1.00 H	69	14.84	31.39
3	*2412.00	106.38 PK			1.00 H	52	74.92	31.46
3	*2412.00	96.68 AV			1.00 H	52	65.22	31.46
4	4824.00	44.85 PK	74.00	-29.15	1.05 H	322	7.72	37.13
4	4824.00	31.91 AV	54.00	-22.09	1.05 H	322	-5.22	37.13

ANTENNA POLARITY & TEST DISTANCE: VERTICAL AT 3 M

No.	Freq. (MHz)	Emission Level (dBuV/m)	Limit (dBuV/m)	Margin (dB)	Antenna Height (m)	Table Angle (Degree)	Raw Value (dBuV)	Correction Factor (dB/m)
1	1608.00	44.65 PK	74.00	-29.35	1.36 V	183	15.91	28.74
1	1608.00	39.78 AV	54.00	-14.22	1.36 V	183	11.04	28.74
2	2390.00	60.97 PK	74.00	-13.03	1.24 V	157	29.58	31.39
2	2390.00	47.13 AV	54.00	-6.87	1.24 V	157	15.74	31.39
3	*2412.00	107.16 PK			1.37 V	135	75.70	31.46
3	*2412.00	97.68 AV			1.37 V	135	66.22	31.46
4	4824.00	46.35 PK	74.00	-27.65	1.24 V	245	9.22	37.13
4	4824.00	33.36 AV	54.00	-20.64	1.24 V	245	-3.77	37.13

- REMARKS:**
1. Emission level(dBuV/m)=Raw Value(dBuV) + Correction Factor(dB/m)
 2. Correction Factor(dB/m) = Antenna Factor (dB/m) + Cable Factor (dB)
 3. The other emission levels were very low against the limit.
 4. Margin value = Emission level – Limit value.
 5. “ * “ : Fundamental frequency.

EUT TEST CONDITION		MEASUREMENT DETAIL	
CHANNEL	Channel 6	FREQUENCY RANGE	1 ~ 25GHz
MODULATION TYPE	BPSK	DETECTOR FUNCTION	Peak(PK) Average (AV)
TRANSFER RATE	6Mbps	ENVIRONMENTAL CONDITIONS	26deg. C, 66%RH, 991hPa
INPUT POWER (SYSTEM)	120Vac, 60 Hz	TESTED BY	Morgan Chen

ANTENNA POLARITY & TEST DISTANCE: HORIZONTAL AT 3 M

No.	Freq. (MHz)	Emission Level (dBuV/m)	Limit (dBuV/m)	Margin (dB)	Antenna Height (m)	Table Angle (Degree)	Raw Value (dBuV)	Correction Factor (dB/m)
1	1624.00	44.03 PK	74.00	-29.97	1.05 H	325	15.24	28.79
1	1624.00	39.46 AV	54.00	-14.54	1.05 H	325	10.67	28.79
2	*2437.00	107.20 PK			1.00 H	39	75.66	31.54
2	*2437.00	97.47 AV			1.00 H	39	65.93	31.54
3	4874.00	45.01 PK	74.00	-28.99	1.01 H	325	7.72	37.29
3	4874.00	32.19 AV	54.00	-21.81	1.01 H	325	-5.10	37.29

ANTENNA POLARITY & TEST DISTANCE: VERTICAL AT 3 M

No.	Freq. (MHz)	Emission Level (dBuV/m)	Limit (dBuV/m)	Margin (dB)	Antenna Height (m)	Table Angle (Degree)	Raw Value (dBuV)	Correction Factor (dB/m)
1	1624.00	45.65 PK	74.00	-28.35	1.10 V	182	16.86	28.79
1	1624.00	40.52 AV	54.00	-13.48	1.10 V	182	11.73	28.79
2	*2437.00	108.31 PK			1.14 V	161	76.77	31.54
2	*2437.00	98.56 AV			1.14 V	161	67.02	31.54
3	4874.00	46.56 PK	74.00	-27.44	1.15 V	213	9.27	37.29
3	4874.00	33.42 AV	54.00	-20.58	1.15 V	213	-3.87	37.29

- REMARKS:**
1. Emission level(dBuV/m)=Raw Value(dBuV) + Correction Factor(dB/m)
 2. Correction Factor(dB/m) = Antenna Factor (dB/m) + Cable Factor (dB)
 3. The other emission levels were very low against the limit.
 4. Margin value = Emission level – Limit value.
 5. “ * “ : Fundamental frequency.

EUT TEST CONDITION		MEASUREMENT DETAIL	
CHANNEL	Channel 11	FREQUENCY RANGE	1 ~ 25GHz
MODULATION TYPE	BPSK	DETECTOR FUNCTION	Peak(PK) Average (AV)
TRANSFER RATE	6Mbps	ENVIRONMENTAL CONDITIONS	26deg. C, 66%RH, 991hPa
INPUT POWER (SYSTEM)	120Vac, 60 Hz	TESTED BY	Morgan Chen

ANTENNA POLARITY & TEST DISTANCE: HORIZONTAL AT 3 M								
No.	Freq. (MHz)	Emission Level (dBuV/m)	Limit (dBuV/m)	Margin (dB)	Antenna Height (m)	Table Angle (Degree)	Raw Value (dBuV)	Correction Factor (dB/m)
1	1641.00	44.12 PK	87.42	-43.30	1.03 H	231	15.27	28.85
1	1641.00	39.52 AV	77.69	-38.17	1.03 H	231	10.67	28.85
2	*2462.00	107.42 PK			1.00 H	48	75.80	31.62
2	*2462.00	97.69 AV			1.00 H	48	66.07	31.62
3	2483.50	60.02 PK	74.00	-13.98	1.00 H	32	28.32	31.70
3	2483.50	46.71 AV	54.00	-7.29	1.00 H	32	15.01	31.70
4	4924.00	45.11 PK	74.00	-28.89	1.03 H	345	7.67	37.44
4	4924.00	32.25 AV	54.00	-21.75	1.03 H	345	-5.19	37.44

ANTENNA POLARITY & TEST DISTANCE: VERTICAL AT 3 M								
No.	Freq. (MHz)	Emission Level (dBuV/m)	Limit (dBuV/m)	Margin (dB)	Antenna Height (m)	Table Angle (Degree)	Raw Value (dBuV)	Correction Factor (dB/m)
1	1641.00	45.79 PK	88.52	-42.73	1.08 V	179	16.94	28.85
1	1641.00	40.62 AV	78.81	-38.19	1.08 V	179	11.77	28.85
2	*2462.00	108.52 PK			1.13 V	160	76.90	31.62
2	*2462.00	98.81 AV			1.13 V	160	67.19	31.62
3	2483.50	61.63 PK	74.00	-12.37	1.11 V	164	29.93	31.70
3	2483.50	47.87 AV	54.00	-6.13	1.11 V	164	16.17	31.70
4	4924.00	46.40 PK	74.00	-27.60	1.11 V	325	8.96	37.44
4	4924.00	33.33 AV	54.00	-20.67	1.11 V	325	-4.11	37.44

- REMARKS:**
1. Emission level(dBuV/m)=Raw Value(dBuV) + Correction Factor(dB/m)
 2. Correction Factor(dB/m) = Antenna Factor (dB/m) + Cable Factor (dB)
 3. The other emission levels were very low against the limit.
 4. Margin value = Emission level – Limit value.
 5. “ * “ : Fundamental frequency.

802.11g Turbo OFDM MODULATION

EUT TEST CONDITION		MEASUREMENT DETAIL	
CHANNEL	Channel 6	FREQUENCY RANGE	1 ~ 25GHz
MODULATION TYPE	QPSK	DETECTOR FUNCTION	Peak(PK) Average (AV)
TRANSFER RATE	12Mbps	ENVIRONMENTAL CONDITIONS	25deg. C, 65%RH, 991hPa
INPUT POWER (SYSTEM)	120Vac, 60 Hz	TESTED BY	Morgan Chen

ANTENNA POLARITY & TEST DISTANCE: HORIZONTAL AT 3 M

No.	Freq. (MHz)	Emission Level (dBuV/m)	Limit (dBuV/m)	Margin (dB)	Antenna Height (m)	Table Angle (Degree)	Raw Value (dBuV)	Correction Factor (dB/m)
1	1624.00	43.89 PK	74.00	-30.11	1.02 H	313	14.74	29.15
1	1624.00	39.20 AV	54.00	-14.80	1.02 H	313	10.05	29.15
2	2390.00	51.20 PK	74.00	-22.80	1.00 H	352	19.29	31.91
2	2390.00	41.16 AV	54.00	-12.84	1.00 H	352	9.25	31.91
3	*2437.00	106.98 PK			1.00 H	25	74.78	32.20
3	*2437.00	97.22 AV			1.00 H	25	65.02	32.20
4	2483.50	51.20 PK	74.00	-22.80	1.00 H	318	18.71	32.49
4	2483.50	41.32 AV	54.00	-12.68	1.00 H	318	8.83	32.49
5	4874.00	44.35 PK	74.00	-29.65	1.08 H	320	6.80	37.55
5	4874.00	31.85 AV	54.00	-22.15	1.08 H	320	-5.70	37.55

ANTENNA POLARITY & TEST DISTANCE: VERTICAL AT 3 M

No.	Freq. (MHz)	Emission Level (dBuV/m)	Limit (dBuV/m)	Margin (dB)	Antenna Height (m)	Table Angle (Degree)	Raw Value (dBuV)	Correction Factor (dB/m)
1	1624.00	45.44 PK	74.00	-28.56	1.15 V	168	16.29	29.15
1	1624.00	40.30 AV	54.00	-13.70	1.15 V	168	11.15	29.15
2	2390.00	52.35 PK	74.00	-21.65	1.00 V	315	20.44	31.91
2	2390.00	42.33 AV	54.00	-11.67	1.00 V	315	10.42	31.91
3	*2437.00	107.89 PK			1.09 V	152	75.69	32.20
3	*2437.00	98.02 AV			1.09 V	152	65.82	32.20
4	2483.50	52.63 PK	74.00	-21.37	1.05 V	132	20.14	32.49
4	2483.50	42.58 AV	54.00	-11.42	1.05 V	132	10.09	32.49
5	4874.00	46.32 PK	74.00	-27.68	1.12 V	202	8.77	37.55
5	4874.00	33.15 AV	54.00	-20.85	1.12 V	202	-4.40	37.55

- REMARKS:**
1. Emission level(dBuV/m)=Raw Value(dBuV) + Correction Factor(dB/m)
 2. Correction Factor(dB/m) = Antenna Factor (dB/m) + Cable Factor (dB)
 3. The other emission levels were very low against the limit.
 4. Margin value = Emission level – Limit value.
 5. “ * “ : Fundamental frequency.



4.3 6dB BANDWIDTH MEASUREMENT

4.3.1 LIMITS OF 6dB BANDWIDTH MEASUREMENT

The minimum of 6dB Bandwidth Measurement is 0.5 MHz.

4.3.2 TEST INSTRUMENTS

DESCRIPTION & MANUFACTURER	MODEL NO.	SERIAL NO.	CALIBRATED UNTIL
SPECTRUM ANALYZER	FSEK 30	100049	Aug. 14, 2006

NOTE: The calibration interval of the above test instruments is 12 months and the calibrations are traceable to NML/ROC and NIST/USA.

4.3.3 TEST PROCEDURE

The transmitter output was connected to the spectrum analyzer through an attenuator. The bandwidth of the fundamental frequency was measured by spectrum analyzer with 100 kHz RBW and 100kHz VBW. The 6dB bandwidth is defined as the total spectrum the power of which is higher than peak power minus 6dB.

4.3.4 DEVIATION FROM TEST STANDARD

No deviation

4.3.5 TEST SETUP

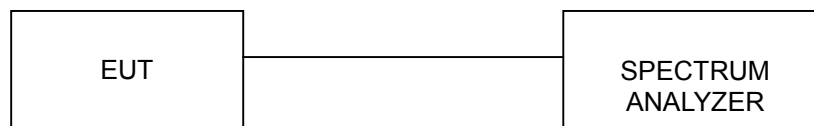

For the actual test configuration, please refer to the related Item – Photographs of the Test Configuration.

4.3.6 EUT OPERATING CONDITIONS

The software provided by client to enable the EUT under transmission condition continuously at lowest, middle and highest channel frequencies individually.



4.3.7 TEST RESULTS

802.11b DSSS MODULATION

MODULATION TYPE	CCK	TRANSFER RATE	11Mbps
INPUT POWER (SYSTEM)	120Vac, 60 Hz	ENVIRONMENTAL CONDITIONS	26deg.C, 66%RH, 991hPa
TESTED BY	Morgan Chen		

CHANNEL	CHANNEL FREQUENCY (MHz)	6dB BANDWIDTH (MHz)	MINIMUM LIMIT (MHz)	PASS/FAIL
1	2412	10.76	0.5	PASS
6	2437	10.73	0.5	PASS
11	2462	10.51	0.5	PASS

CH1

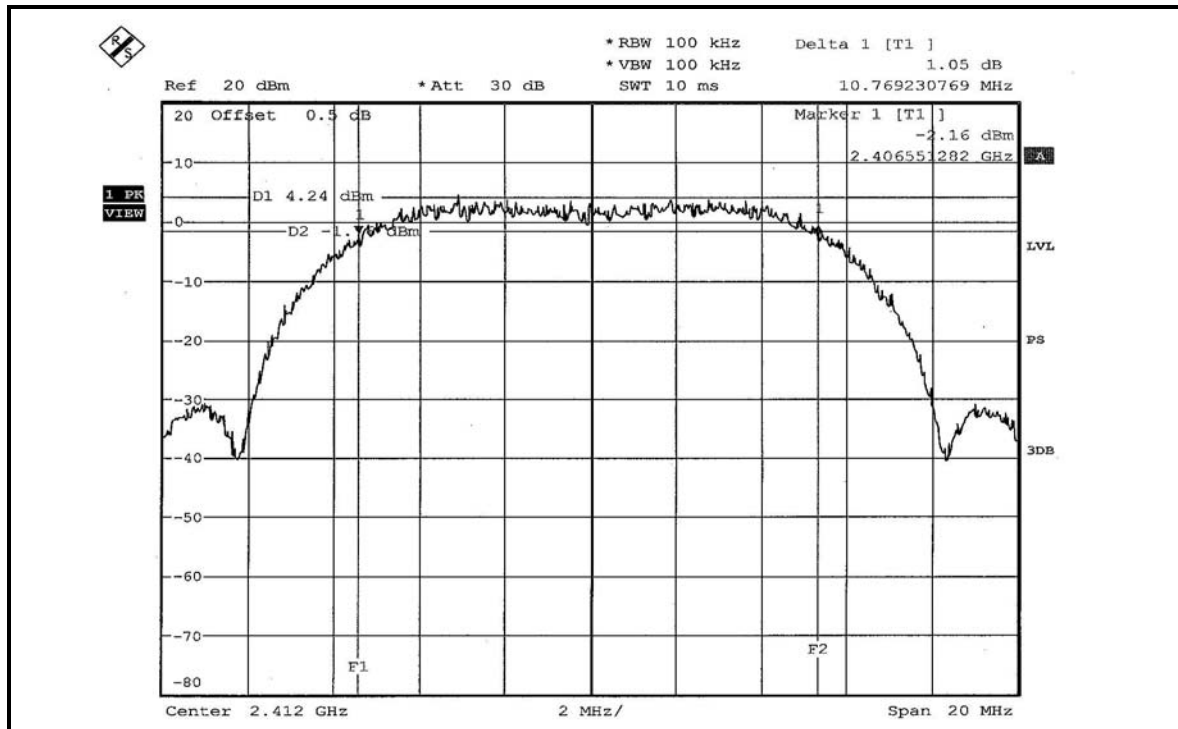

CH6

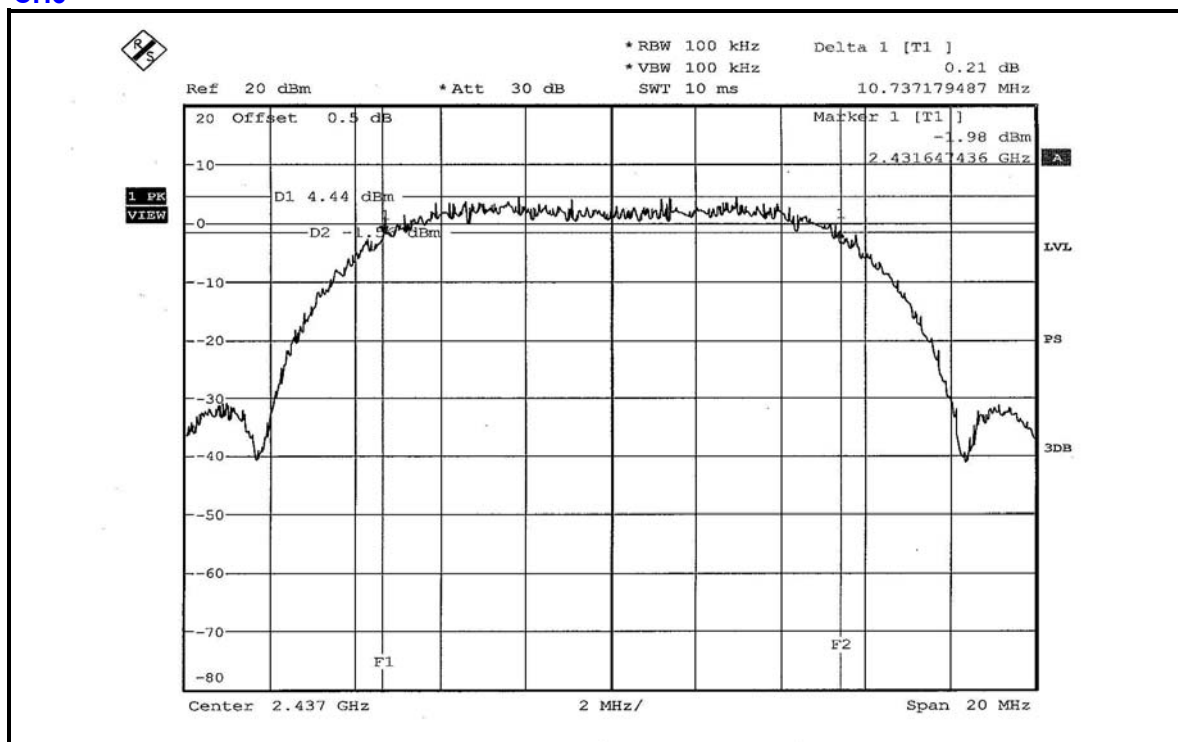

CH11

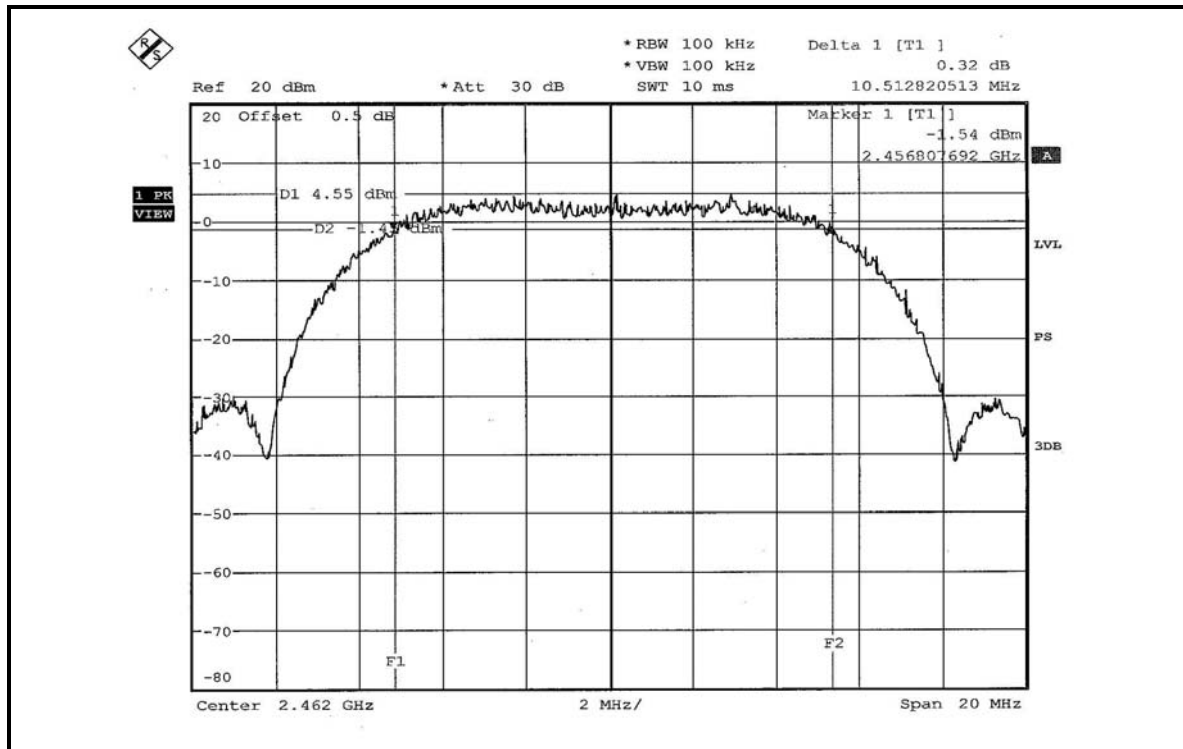



802.11g OFDM MODULATION

MODULATION TYPE	BPSK	TRANSFER RATE	6Mbps
INPUT POWER (SYSTEM)	120Vac, 60 Hz	ENVIRONMENTAL CONDITIONS	26deg.C, 66%RH, 991hPa
TESTED BY	Morgan Chen		

CHANNEL	CHANNEL FREQUENCY (MHz)	6dB BANDWIDTH (MHz)	MINIMUM LIMIT (MHz)	PASS/FAIL
1	2412	16.41	0.5	PASS
6	2437	16.41	0.5	PASS
11	2462	16.37	0.5	PASS

CH1

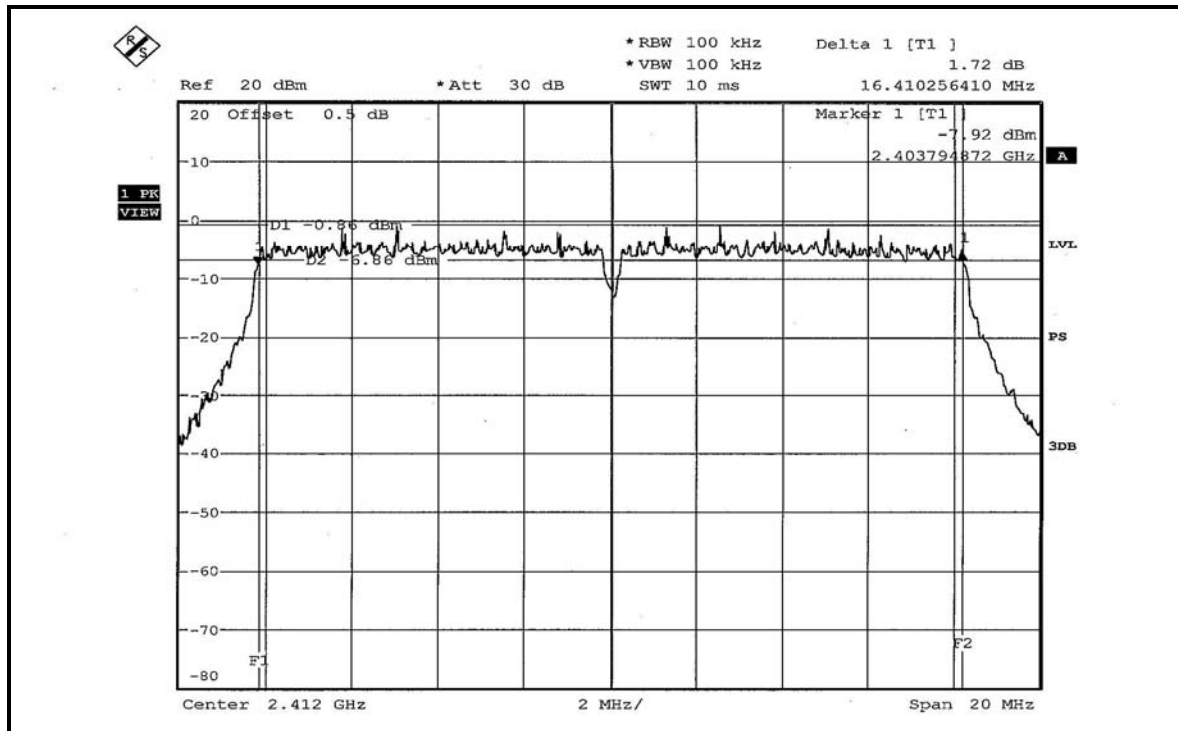

CH6

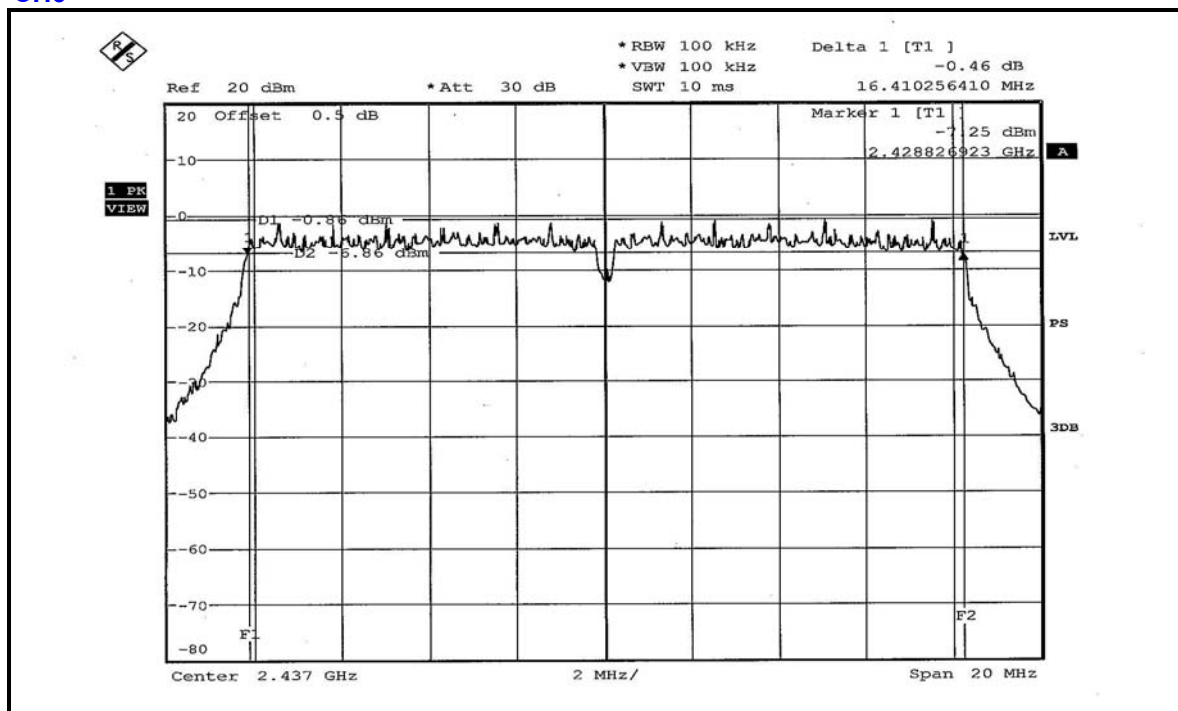

CH11

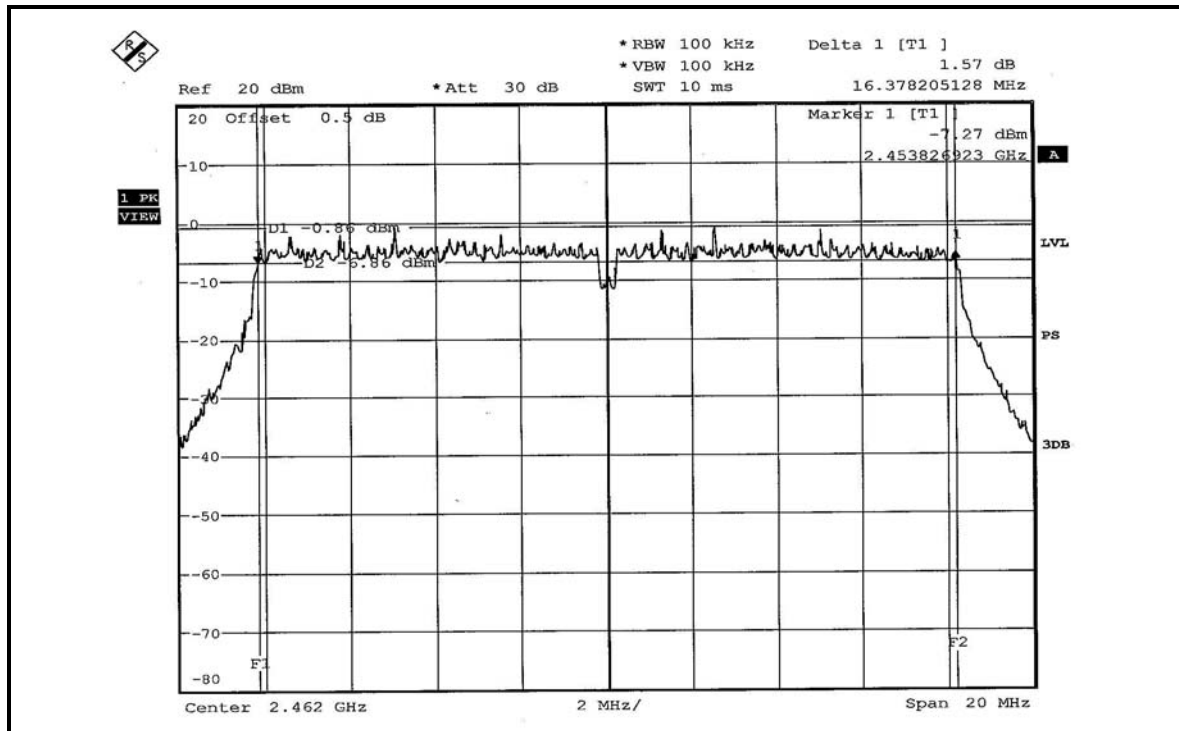



802.11g Turbo OFDM MODULATION

MODULATION TYPE	QPSK	TRANSFER RATE	12Mbps
INPUT POWER (SYSTEM)	120Vac, 60 Hz	ENVIRONMENTAL CONDITIONS	26deg.C, 66%RH, 991hPa
TESTED BY	Morgan Chen		

CHANNEL	CHANNEL FREQUENCY (MHz)	6dB BANDWIDTH (MHz)	MINIMUM LIMIT (MHz)	PASS/FAIL
6	2437	16.60	0.5	PASS

CH6

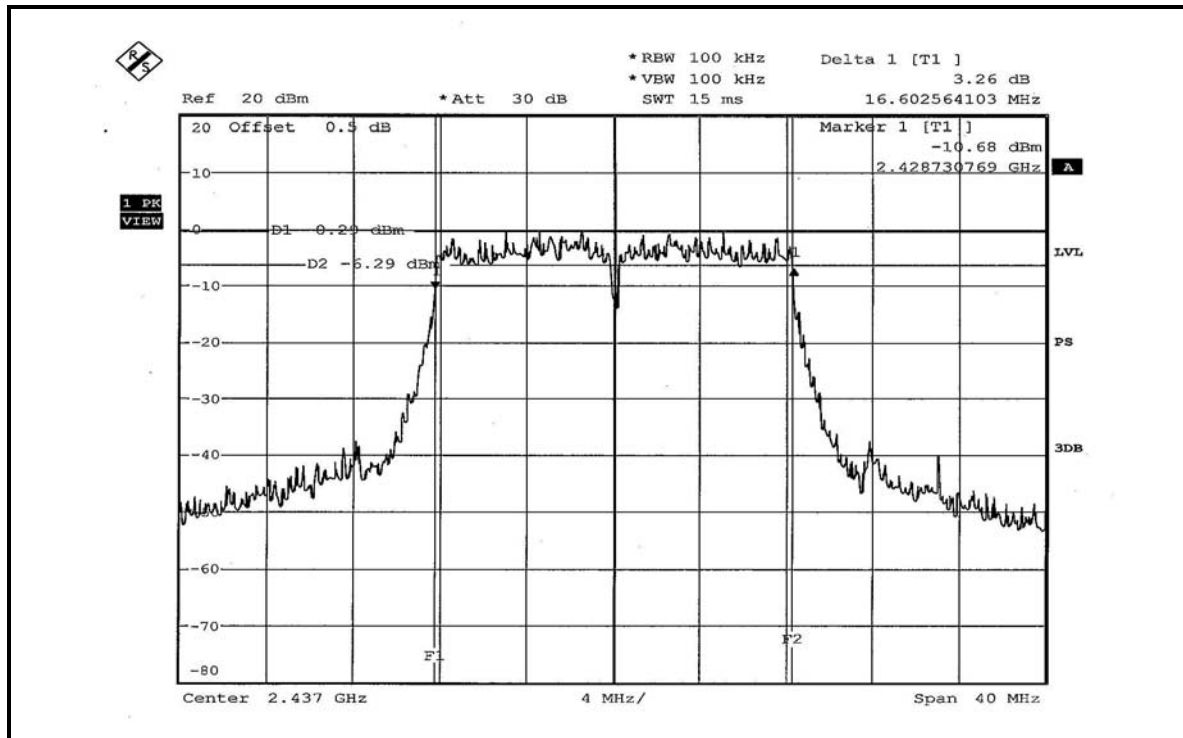



4.4 MAXIMUM PEAK OUTPUT POWER

4.4.1 LIMITS OF MAXIMUM PEAK OUTPUT POWER MEASUREMENT

The Maximum Peak Output Power Measurement is 30dBm. .

4.4.2 TEST INSTRUMENTS

DESCRIPTION & MANUFACTURER	MODEL NO.	SERIAL NO.	CALIBRATED UNTIL
R&S SPECTRUM ANALYZER	FSEK30	100049	Aug. 14, 2006
AGILENT SIGNAL GENERATOR	E8257C	MY43320668	Dec. 07, 2006
DIGITAL RT OSCILLOSCOPE	TDS1012	C037299	Nov. 28, 2006
NARDA DETECTOR	4503A	FSCM99899	NA

NOTE: The calibration interval of the above test instruments is 12 months and the calibrations are traceable to NML/ROC and NIST/USA.

4.4.3 TEST PROCEDURES

1. A detector was used on the output port of the EUT. An oscilloscope was used to peak the response of the detector.
2. Replaced the EUT by the signal generator. The center frequency of the S.G was adjusted to the center frequency of the measured channel.
3. Adjusted the power to have the same peak reading on oscilloscope. Record the power level.

4.4.4 DEVIATION FROM TEST STANDARD

No deviation

4.4.5 TEST SETUP



4.4.6 EUT OPERATING CONDITIONS

Same as Item 4.3.6



4.4.7 TEST RESULTS

802.11b DSSS MODULATION

MODULATION TYPE	CCK	TRANSFER RATE	11Mbps
INPUT POWER (SYSTEM)	120Vac, 60 Hz	ENVIRONMENTAL CONDITIONS	26deg.C, 66%RH, 991hPa
TESTED BY	Morgan Chen		

CHANNEL	CHANNEL FREQUENCY (MHz)	PEAK POWER OUTPUT (mW)	PEAK POWER OUTPUT (dBm)	PEAK POWER LIMIT (dBm)	PASS/FAIL
1	2412	32.211	15.08	30	PASS
6	2437	32.509	15.12	30	PASS
11	2462	32.137	15.07	30	PASS

802.11g OFDM MODULATION

MODULATION TYPE	BPSK	TRANSFER RATE	6Mbps
INPUT POWER (SYSTEM)	120Vac, 60 Hz	ENVIRONMENTAL CONDITIONS	26deg.C, 66%RH, 991hPa
TESTED BY	Morgan Chen		

CHANNEL	CHANNEL FREQUENCY (MHz)	PEAK POWER OUTPUT (mW)	PEAK POWER OUTPUT (dBm)	PEAK POWER LIMIT (dBm)	PASS/FAIL
1	2412	31.989	15.05	30	PASS
6	2437	32.285	15.09	30	PASS
11	2462	31.769	15.02	30	PASS

802.11g Turbo OFDM MODULATION

MODULATION TYPE	QPSK	TRANSFER RATE	12Mbps
INPUT POWER (SYSTEM)	120Vac, 60 Hz	ENVIRONMENTAL CONDITIONS	26deg.C, 66%RH, 991hPa
TESTED BY	Morgan Chen		

CHANNEL	CHANNEL FREQUENCY (MHz)	PEAK POWER OUTPUT (mW)	PEAK POWER OUTPUT (dBm)	PEAK POWER LIMIT (dBm)	PASS/FAIL
6	2437	32.359	15.10	30	PASS



4.5 POWER SPECTRAL DENSITY MEASUREMENT

4.5.1 LIMITS OF POWER SPECTRAL DENSITY MEASUREMENT

The Maximum of Power Spectral Density Measurement is 8dBm.

4.5.2 TEST INSTRUMENTS

DESCRIPTION & MANUFACTURER	MODEL NO.	SERIAL NO.	CALIBRATED UNTIL
R&S SPECTRUM ANALYZER	FSEK30	100049	Aug. 14, 2006

NOTE: The calibration interval of the above test instruments is 12 months and the calibrations are traceable to NML/ROC and NIST/USA.

4.5.3 TEST PROCEDURE

The transmitter output was connected to the spectrum analyzer through an attenuator, the bandwidth of the fundamental frequency was measured with the spectrum analyzer using 3kHz RBW and 30kHz VBW, set sweep time=span/3kHz. The power spectral density was measured and recorded. The sweep time is allowed to be longer than span/3kHz for a full response of the mixer in the spectrum analyzer.

4.5.4 DEVIATION FROM TEST STANDARD

No deviation

4.5.5 TEST SETUP

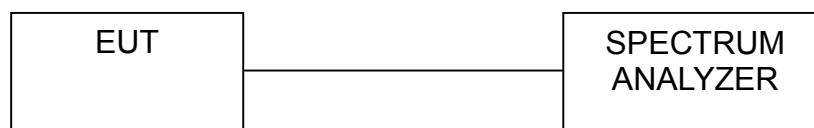

4.5.6 EUT OPERATING CONDITIONS

Same as 4.3.6



4.5.7 TEST RESULTS

802.11b DSSS MODULATION

MODULATION TYPE	CCK	TRANSFER RATE	11Mbps
INPUT POWER (SYSTEM)	120Vac, 60 Hz	ENVIRONMENTAL CONDITIONS	26deg.C, 66%RH, 991hPa
TESTED BY	Morgan Chen		

CHANNEL	CHANNEL FREQUENCY (MHz)	RF POWER LEVEL IN 3 kHz BW (dBm)	MAXIMUM LIMIT (dBm)	PASS/FAIL
1	2412	-9.79	8	PASS
6	2437	-9.99	8	PASS
11	2462	-9.90	8	PASS

CH1

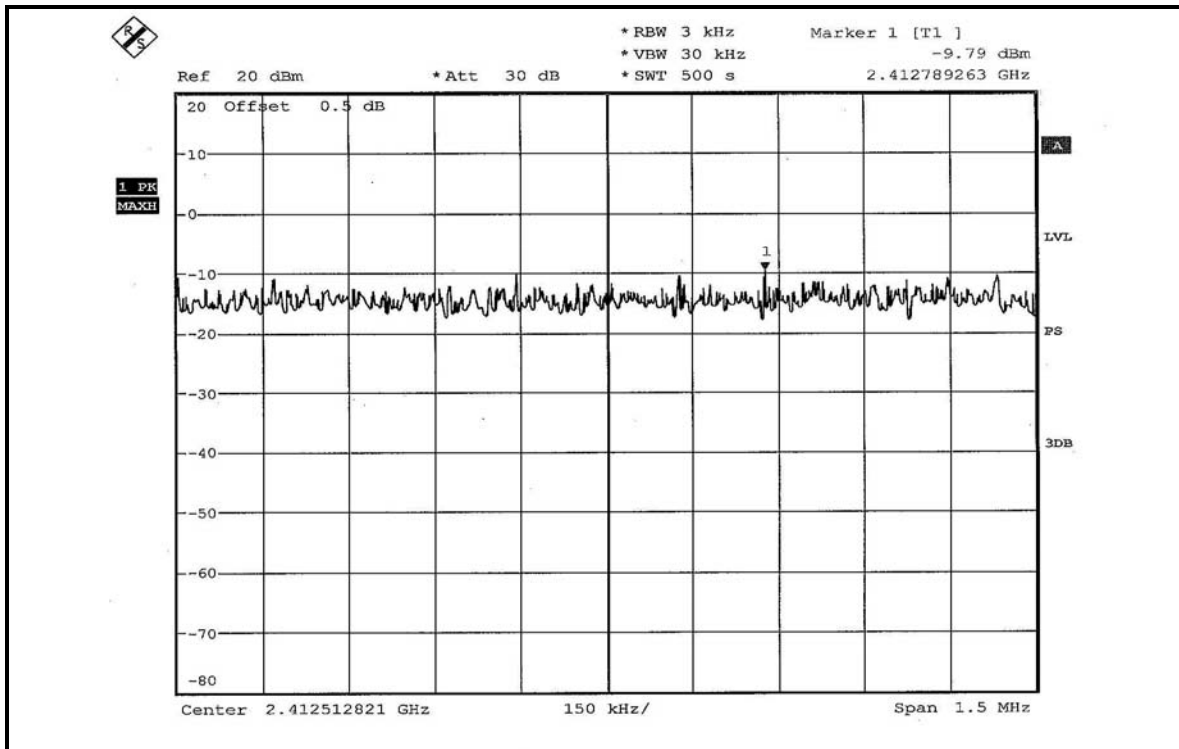

CH6

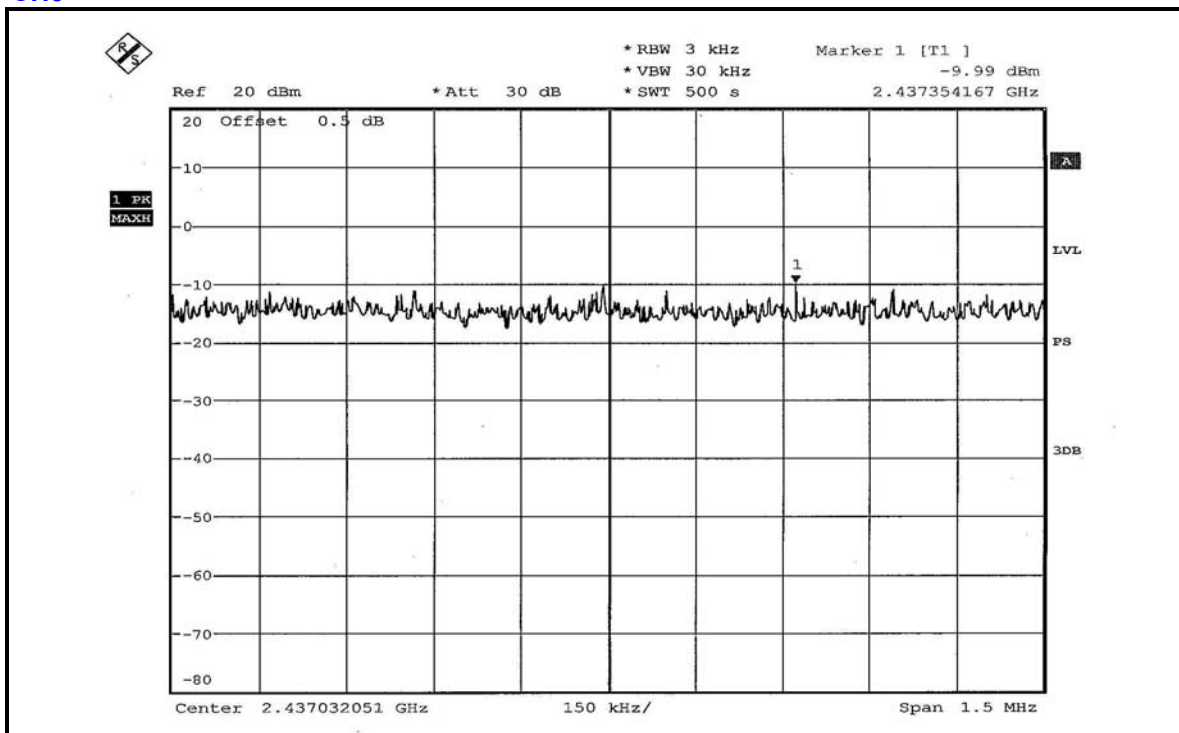

CH11

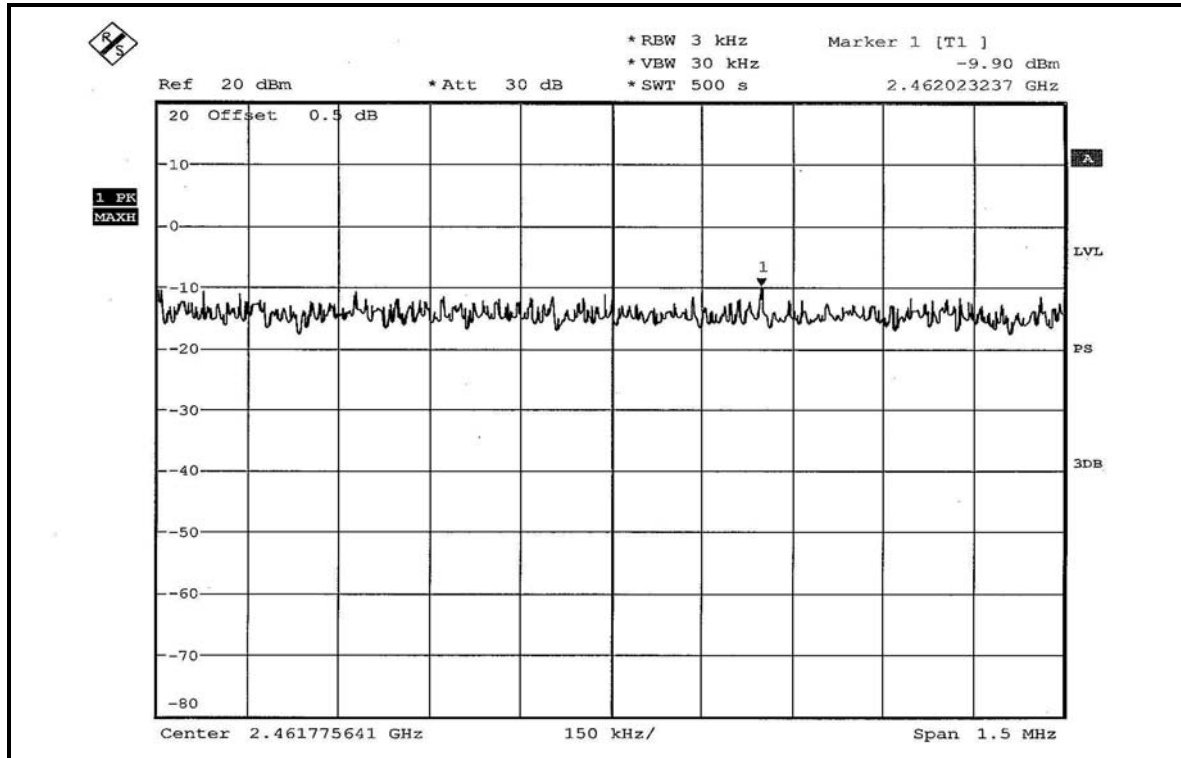



802.11g OFDM MODULATION

MODULATION TYPE	BPSK	TRANSFER RATE	6Mbps
INPUT POWER (SYSTEM)	120Vac, 60 Hz	ENVIRONMENTAL CONDITIONS	26deg.C, 66%RH, 991hPa
TESTED BY	Morgan Chen		

CHANNEL	CHANNEL FREQUENCY (MHz)	RF POWER LEVEL IN 3 kHz BW (dBm)	MAXIMUM LIMIT (dBm)	PASS/FAIL
1	2412	-13.65	8	PASS
6	2437	-13.35	8	PASS
11	2462	-13.64	8	PASS

CH1

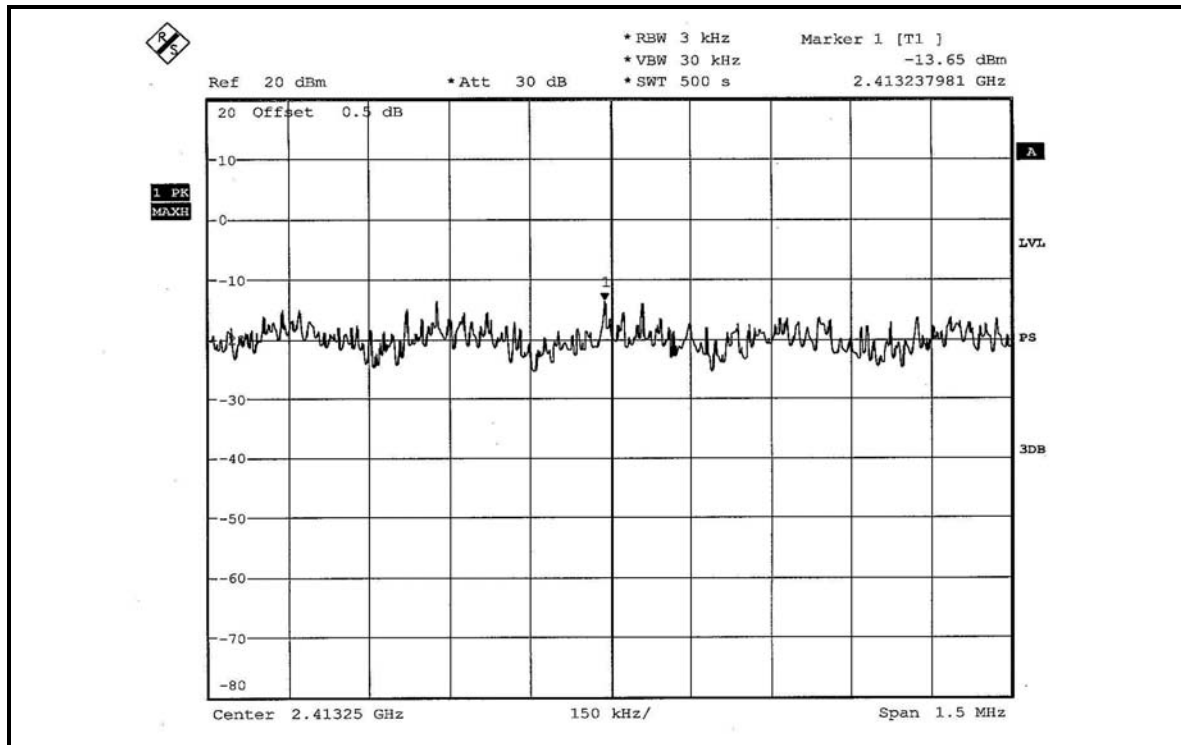

CH6

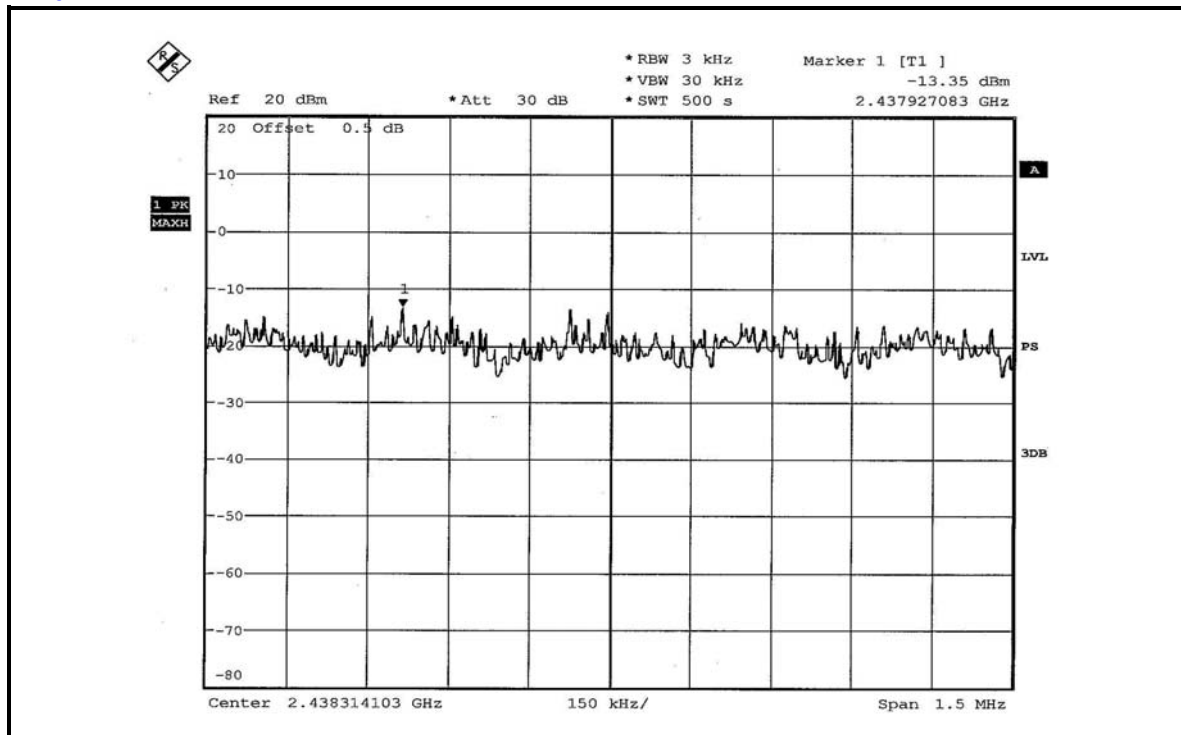

CH11

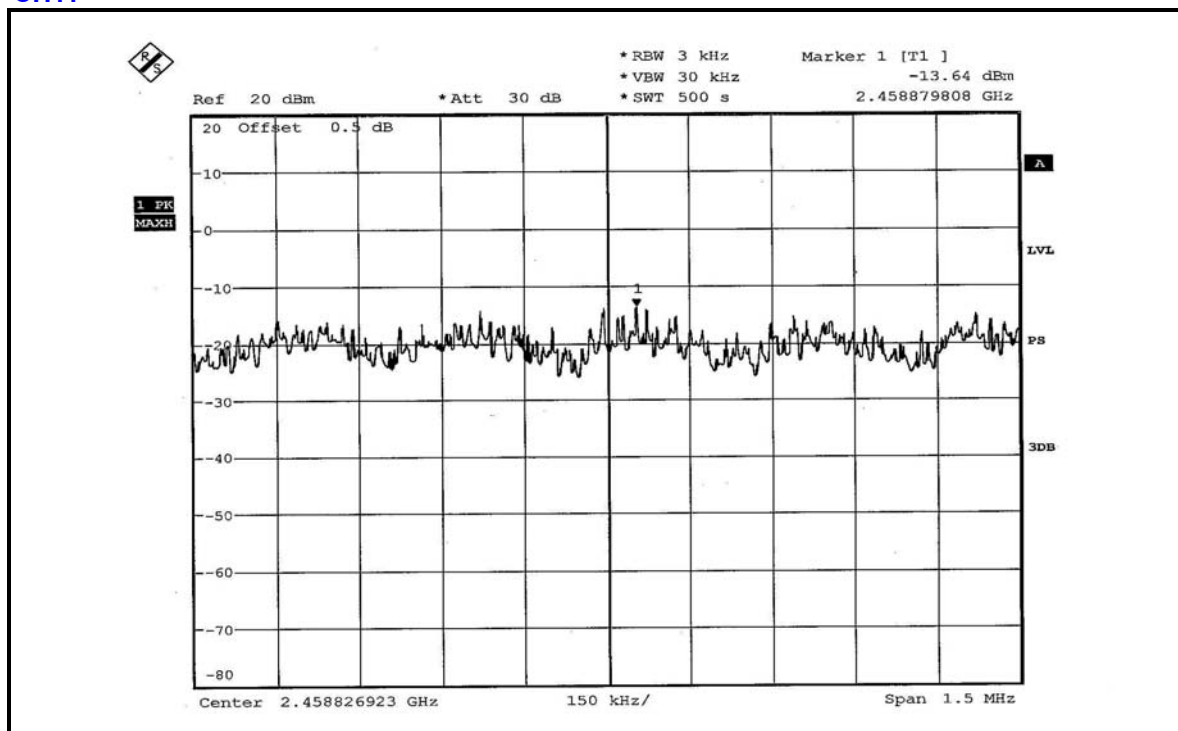



802.11g Turbo OFDM MODULATION

MODULATION TYPE	QPSK	TRANSFER RATE	12Mbps
INPUT POWER (SYSTEM)	120Vac, 60 Hz	ENVIRONMENTAL CONDITIONS	26deg.C, 66%RH, 991hPa
TESTED BY	Morgan Chen		

CHANNEL	CHANNEL FREQUENCY (MHz)	RF POWER LEVEL IN 3 kHz BW (dBm)	MAXIMUM LIMIT (dBm)	PASS/FAIL
6	2437	-13.28	8	PASS

CH6

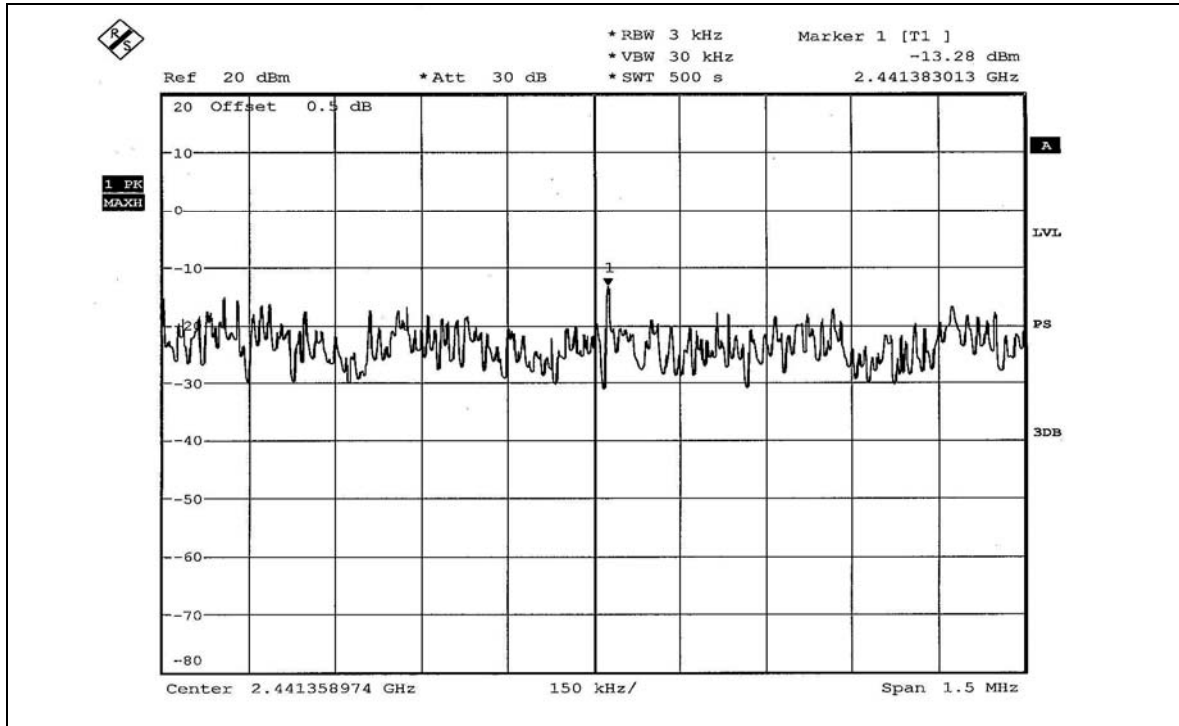



4.6 BAND EDGES MEASUREMENT

4.6.1 LIMITS OF BAND EDGES MEASUREMENT

Below -20dB of the highest emission level of operating band (in 100kHz Resolution Bandwidth).

4.6.2 TEST INSTRUMENTS

DESCRIPTION & MANUFACTURER	MODEL NO.	SERIAL NO.	CALIBRATED UNTIL
R&S SPECTRUM ANALYZER	FSEK30	100049	Aug. 14, 2006

NOTE: The calibration interval of the above test instruments is 12 months and the calibrations are traceable to NML/ROC and NIST/USA.

4.6.3 TEST PROCEDURE

The transmitter output was connected to the spectrum analyzer via a low lose cable. Set both RBW and VBW of spectrum analyzer to 100kHz with suitable frequency span including 100MHz bandwidth from band edge. The band edges was measured and recorded. The spectrum plots (Peak RBW=VBW=100kHz; Average RBW=1MHz, VBW=1kHz) are attached on the following pages.

4.6.4 DEVIATION FROM TEST STANDARD

No deviation

4.6.5 EUT OPERATING CONDITION

Same as Item 4.3.6

4.6.6 TEST RESULTS

The spectrum plots are attached on the following 18 images. D1 line indicates the highest level, and D2 line indicates the 20dB offset below D1. It shows compliance with the requirement in part 15.247(d).

802.11b DSSS MODULATION

NOTE 1: The band edge emission plot of DSSS technique on the next page shows 58.60dBc between carrier maximum power and local maximum emission in restrict band (2.38230GHz). The emission of carrier strength list in the test result of channel 1 at the item 4.2.7 is 111.17dBuV/m (Peak), so the maximum field strength in restrict band is $111.17 - 58.60 = 52.57$ dBuV/m which is under 74dBuV/m limit.

The band edge emission plot of DSSS technique on the next page shows 61.34dBc between carrier maximum power and local maximum emission in restrict band (2.39000GHz). The emission of carrier strength list in the test result of channel 1 at the item 4.2.7 is 104.14dBuV/m (Average), so the maximum field strength in restrict band is $104.14 - 61.34 = 42.80$ dBuV/m which is under 54dBuV/m limit.

NOTE 2: The band edge emission plot of DSSS technique on the next second page shows 58.79dBc between carrier maximum power and local maximum emission in restrict band (2.48382GHz). The emission of carrier strength list in the test result of channel 11 at the item 4.2.7 is 111.29dBuV/m (Peak), so the maximum field strength in restrict band is $111.29 - 58.79 = 52.50$ dBuV/m which is under 74dBuV/m limit.

The band edge emission plot of DSSS technique on the next third page shows 60.73dBc between carrier maximum power and local maximum emission in restrict band (2.48350GHz). The emission of carrier strength list in the test result of channel 11 at the item 4.2.7 is 104.09dBuV/m (Average), so the maximum field strength in restrict band is $104.09 - 60.73 = 43.36$ dBuV/m which is under 54dBuV/m limit.

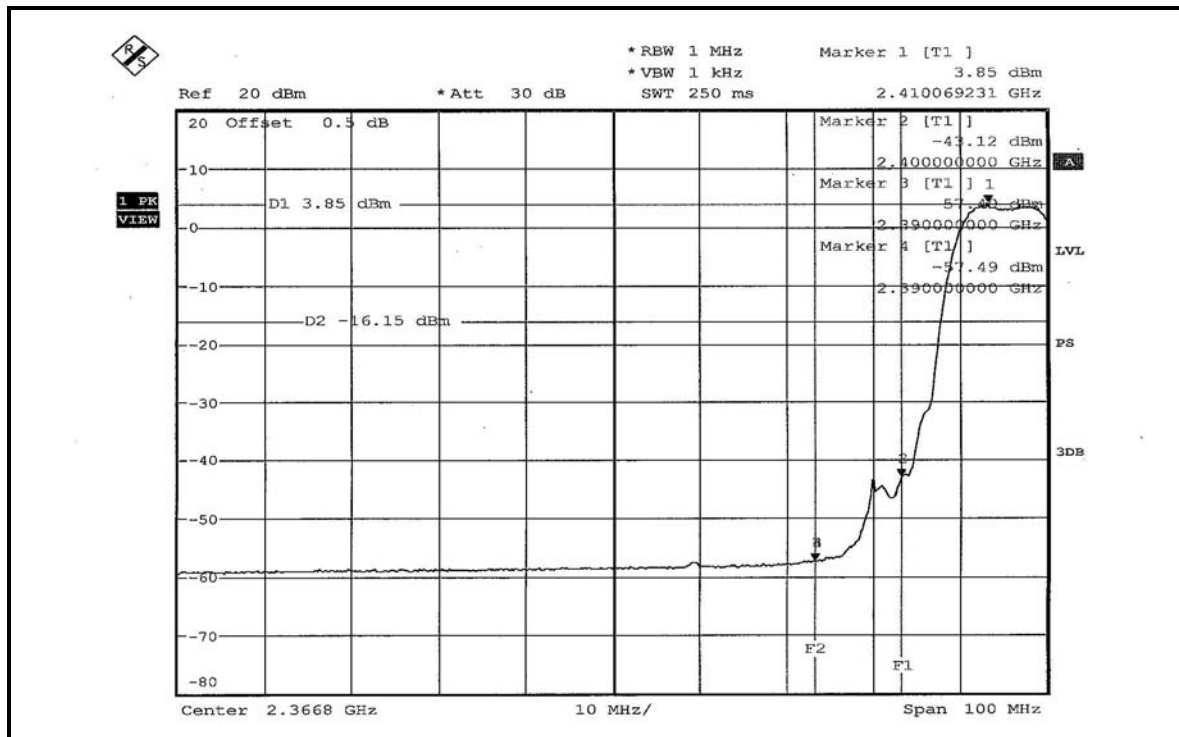
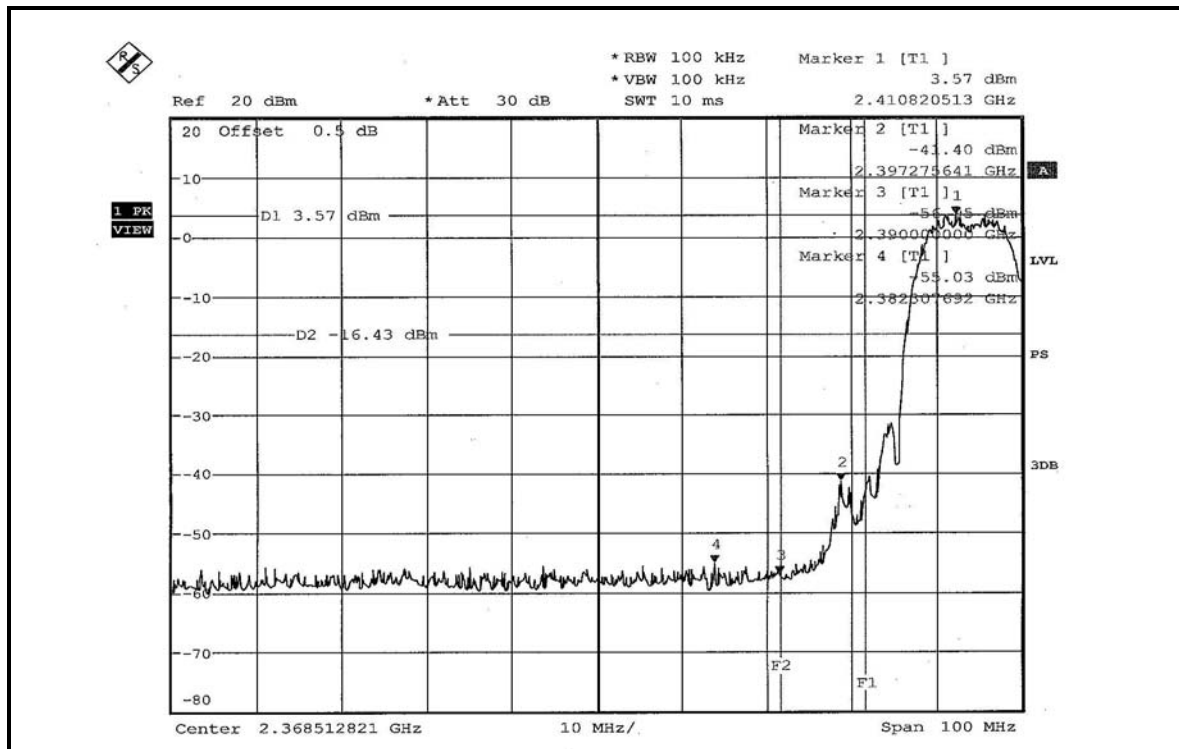

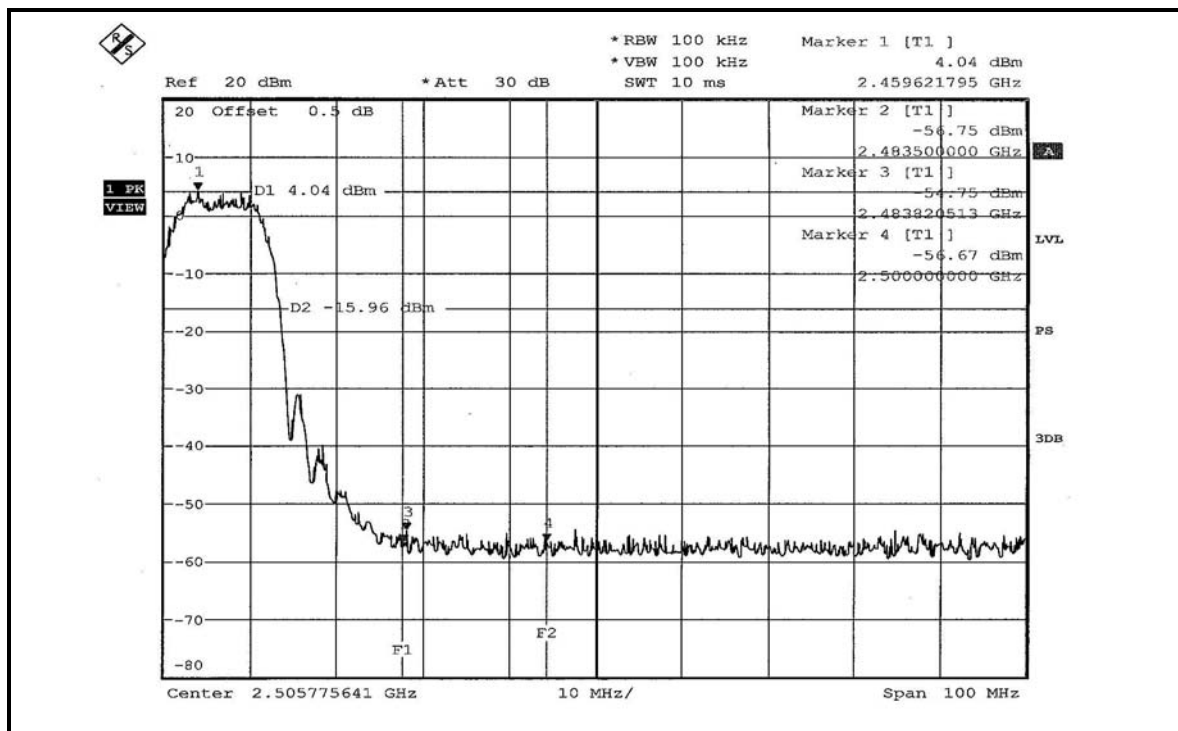
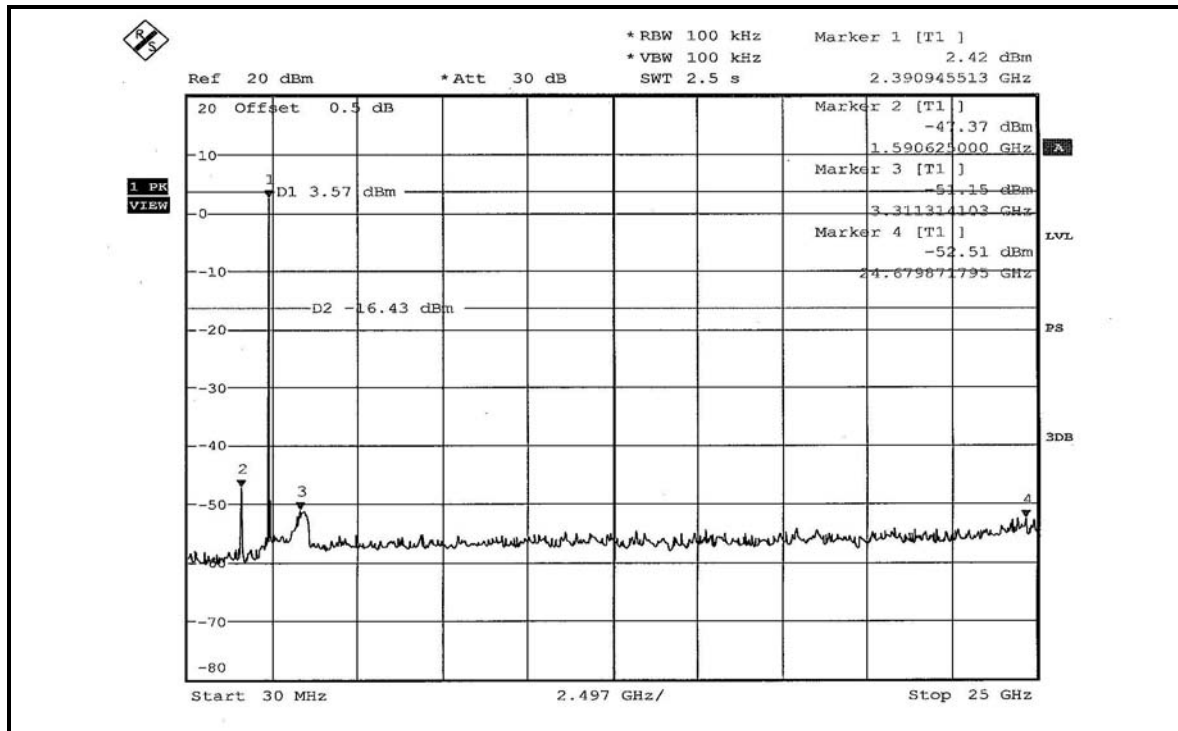

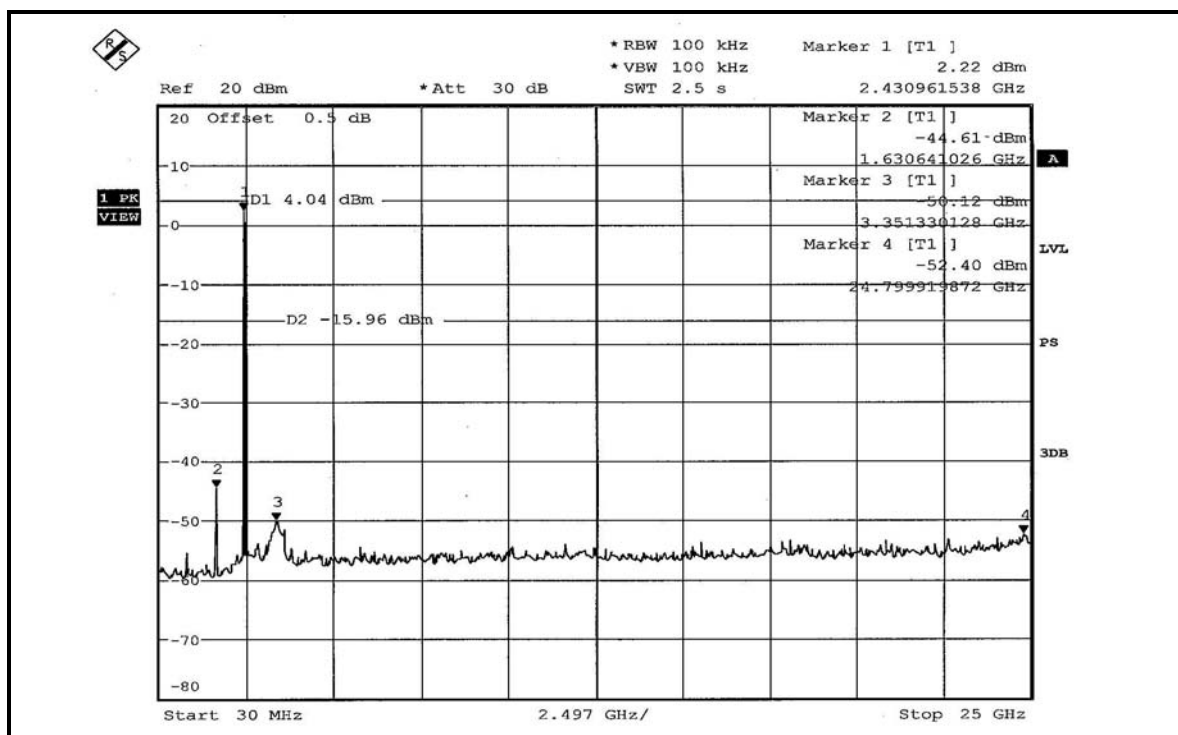
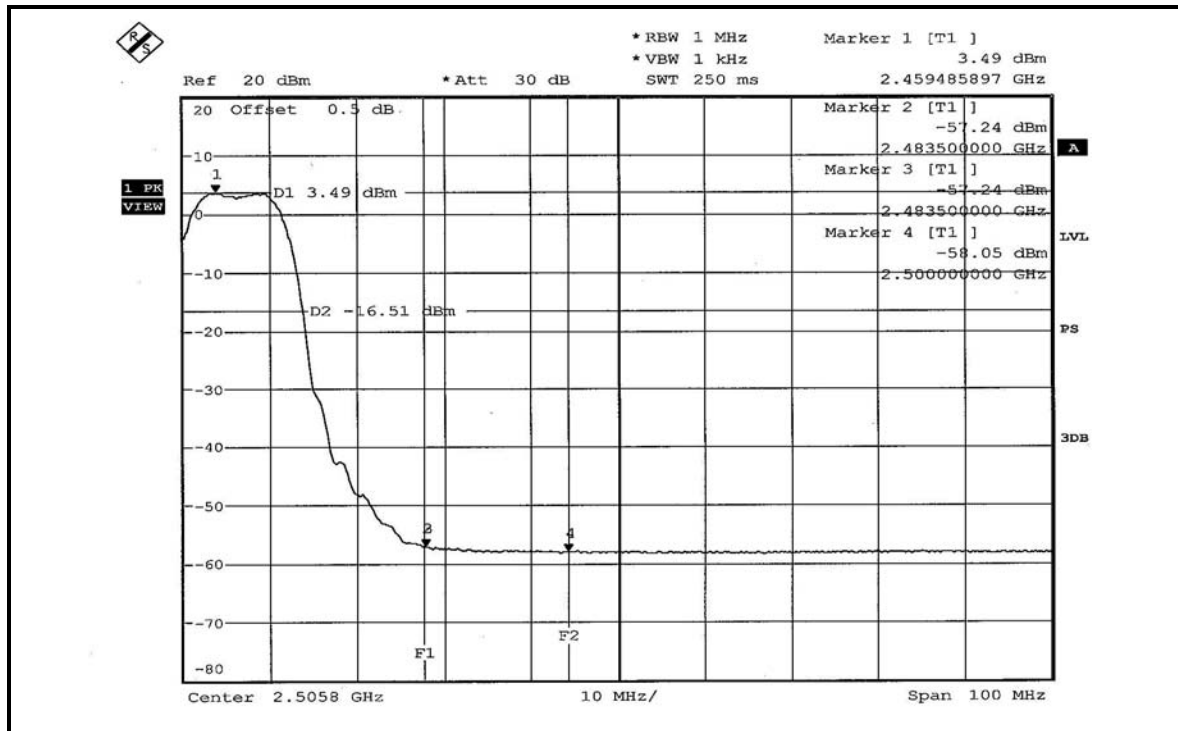

802.11g OFDM MODULATION

NOTE 1: The band edge emission plot of OFDM technique on the next page shows 52.49dBc between carrier maximum power and local maximum emission in restrict band (2.39000GHz). The emission of carrier strength list in the test result of channel 1 at the item 4.2.7 is 107.16dBuV/m (Peak), so the maximum field strength in restrict band is $107.16 - 52.49 = 54.67$ dBuV/m which is under 74dBuV/m limit.

The band edge emission plot of OFDM technique on the next page shows 52.16dBc between carrier maximum power and local maximum emission in restrict band (2.39000GHz). The emission of carrier strength list in the test result of channel 1 at the item 4.2.7 is 97.68dBuV/m (Average), so the maximum field strength in restrict band is $97.68 - 52.16 = 45.52$ dBuV/m which is under 54dBuV/m limit.

NOTE 2: The band edge emission plot of OFDM technique on the next second page shows 51.61dBc between carrier maximum power and local maximum emission in restrict band (2.48435GHz). The emission of carrier strength list in the test result of channel 11 at the item 4.2.7 is 108.52dBuV/m (Peak), so the maximum field strength in restrict band is $108.52 - 51.61 = 56.91$ dBuV/m which is under 74dBuV/m limit.

The band edge emission plot of OFDM technique on the next third page shows 52.40dBc between carrier maximum power and local maximum emission in restrict band (2.48350GHz). The emission of carrier strength list in the test result of channel 11 at the item 4.2.7 is 98.81dBuV/m (Average), so the maximum field strength in restrict band is $98.81 - 52.40 = 46.41$ dBuV/m which is under 54dBuV/m limit.

802.11g OFDM MODULATION

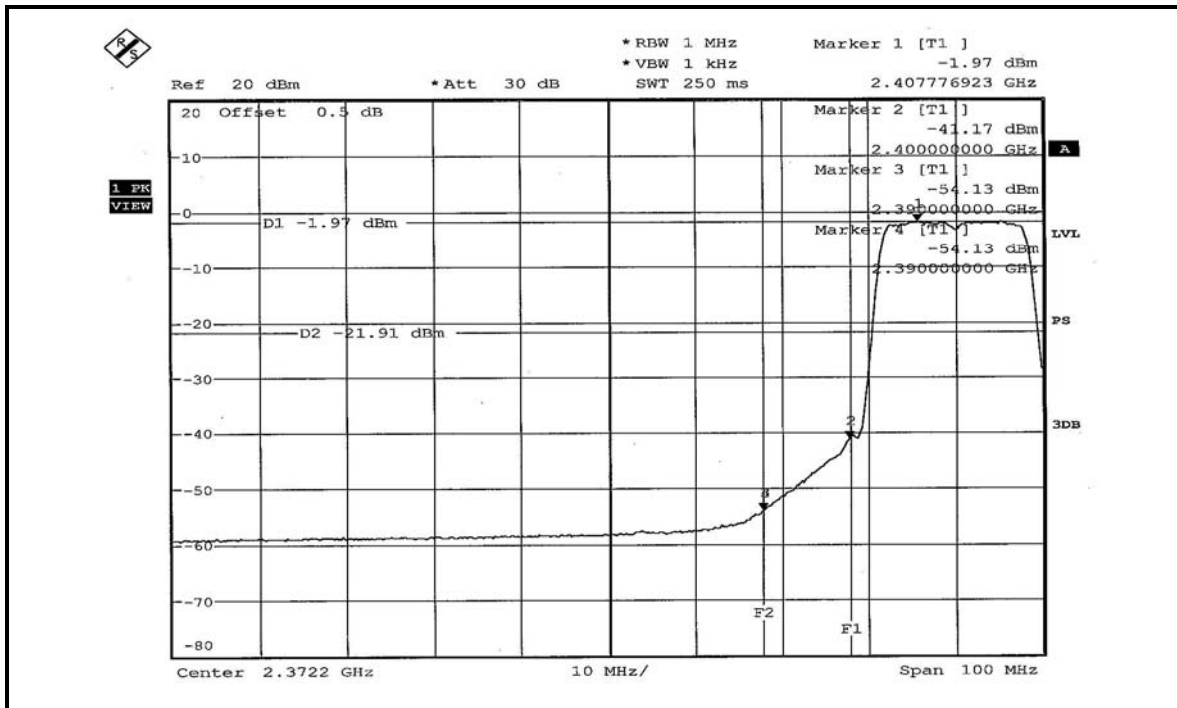
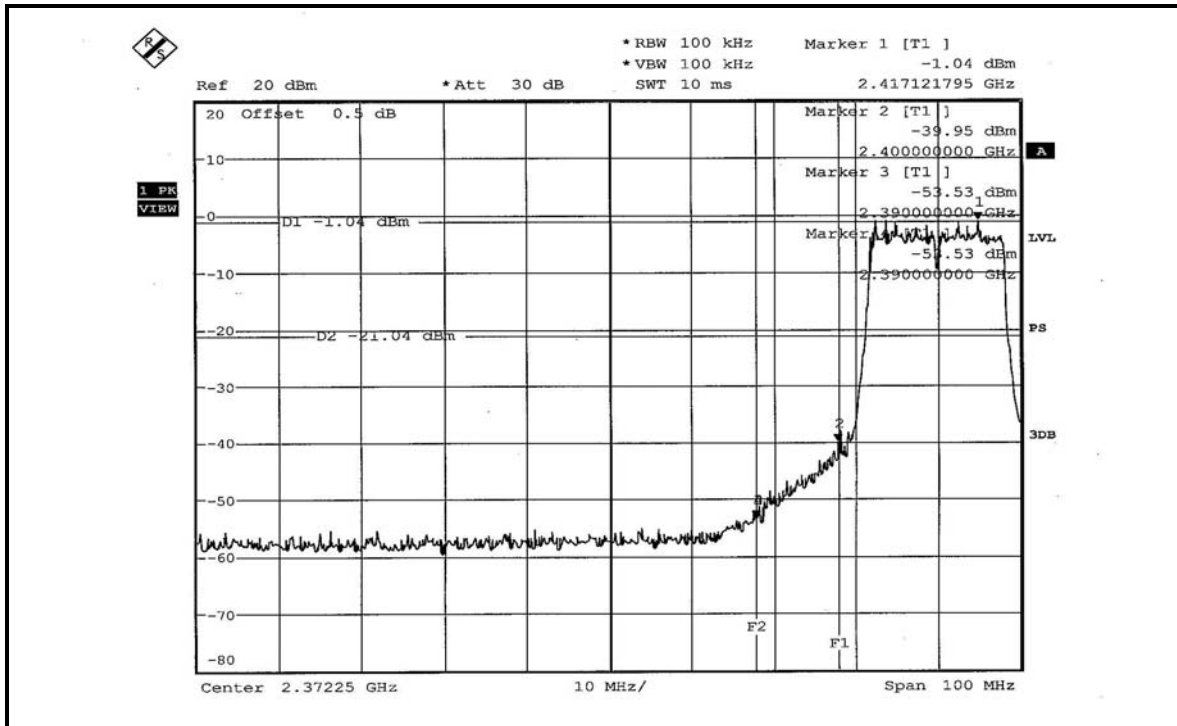

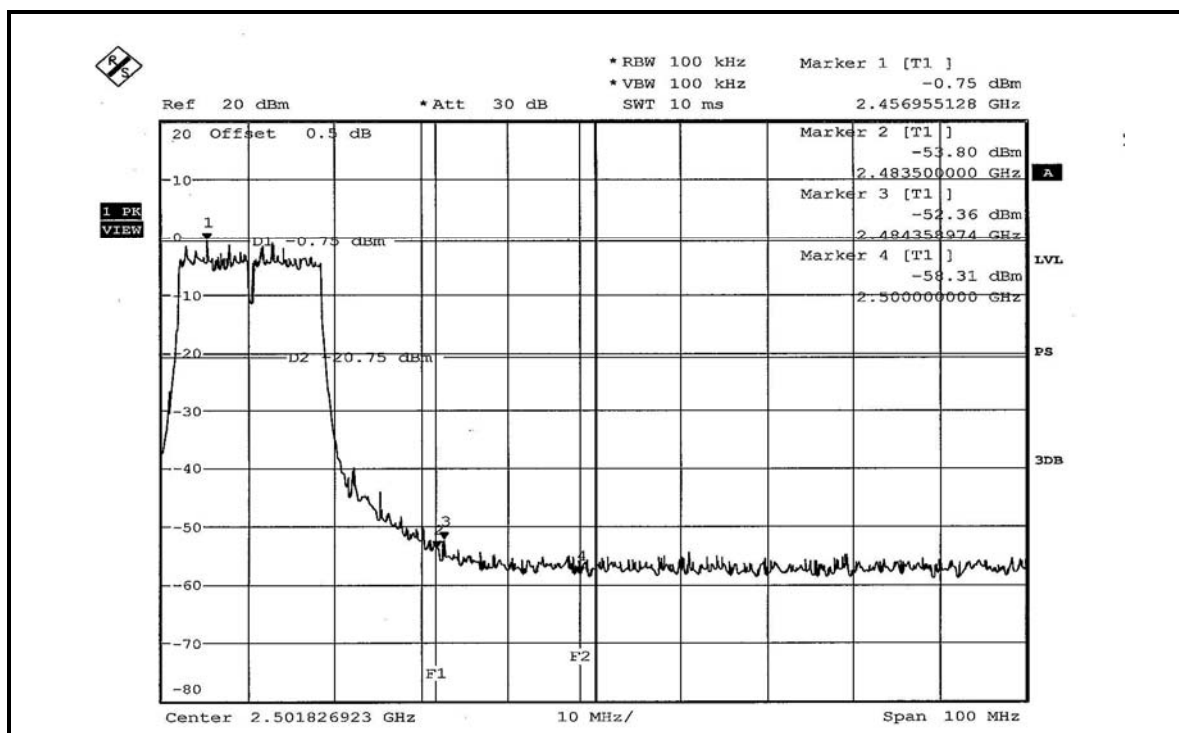
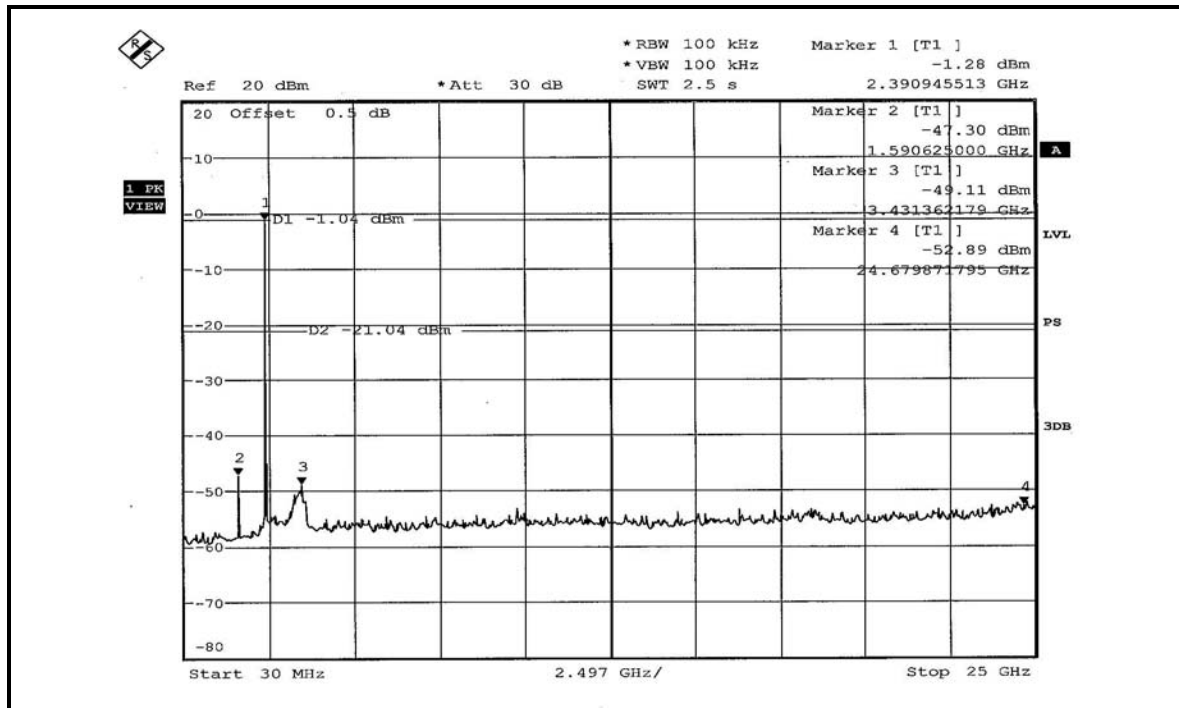

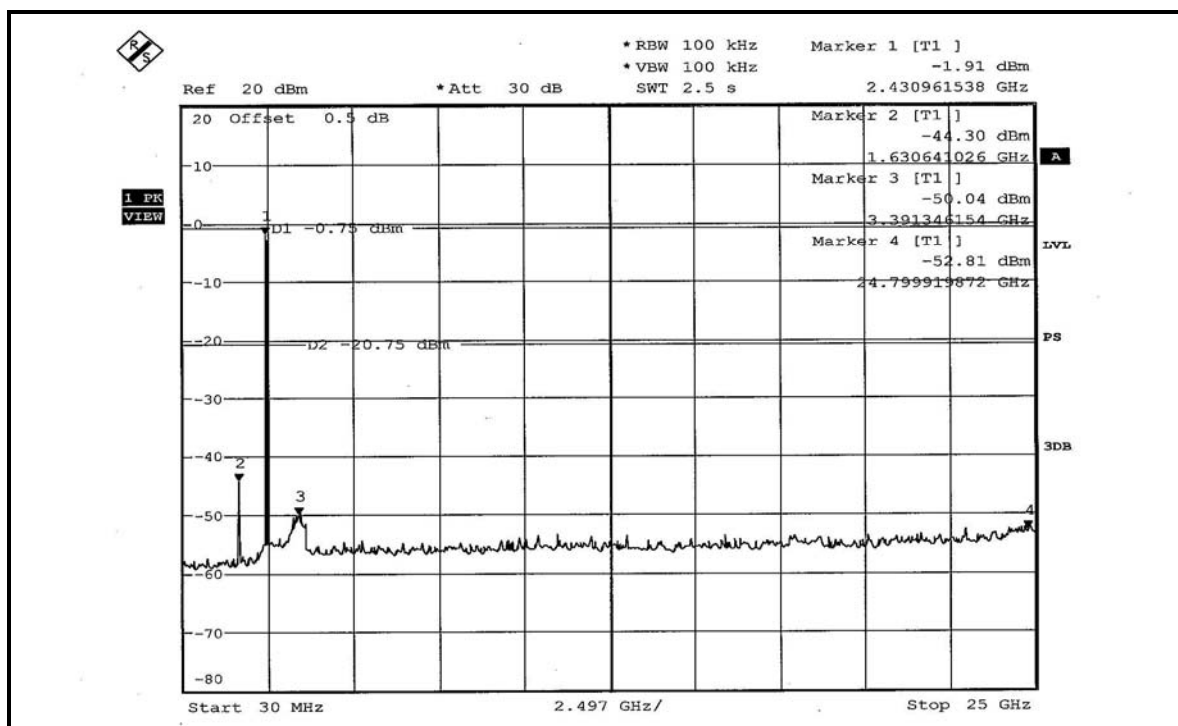
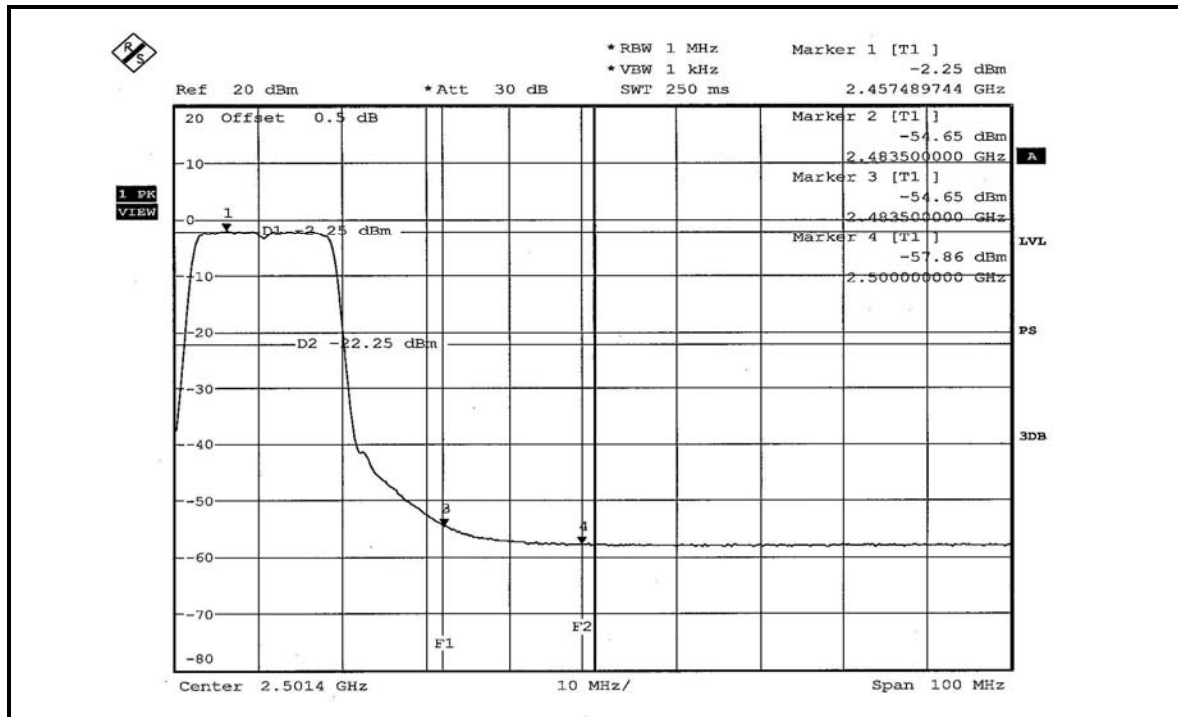

802.11g Turbo OFDM MODULATION

NOTE 1: The band edge emission plot of OFDM technique on the next page shows 54.82dBc between carrier maximum power and local maximum emission in restrict band (2.37269GHz). The emission of carrier strength list in the test result of channel 6 at the item 4.2.7 is 107.89dBuV/m (Peak), so the maximum field strength in restrict band is $107.89 - 54.82 = 53.07$ dBuV/m which is under 74dBuV/m limit.

The band edge emission plot of OFDM technique on the next page shows 56.06dBc between carrier maximum power and local maximum emission in restrict band (2.39000GHz). The emission of carrier strength list in the test result of channel 6 at the item 4.2.7 is 98.02dBuV/m (Average), so the maximum field strength in restrict band is $98.02 - 56.06 = 41.96$ dBuV/m which is under 54dBuV/m limit.

NOTE 2: The band edge emission plot of OFDM technique on the next second page shows 54.04dBc between carrier maximum power and local maximum emission in restrict band (2.49696GHz). The emission of carrier strength list in the test result of channel 6 at the item 4.2.7 is 107.89dBuV/m (Peak), so the maximum field strength in restrict band is $107.89 - 54.04 = 53.85$ dBuV/m which is under 74dBuV/m limit.

The band edge emission plot of OFDM technique on the next third page shows 55.88dBc between carrier maximum power and local maximum emission in restrict band (2.48350GHz). The emission of carrier strength list in the test result of channel 6 at the item 4.2.7 is 98.02dBuV/m (Average), so the maximum field strength in restrict band is $98.02 - 55.88 = 42.14$ dBuV/m which is under 54dBuV/m limit.

802.11g Turbo OFDM MODULATION

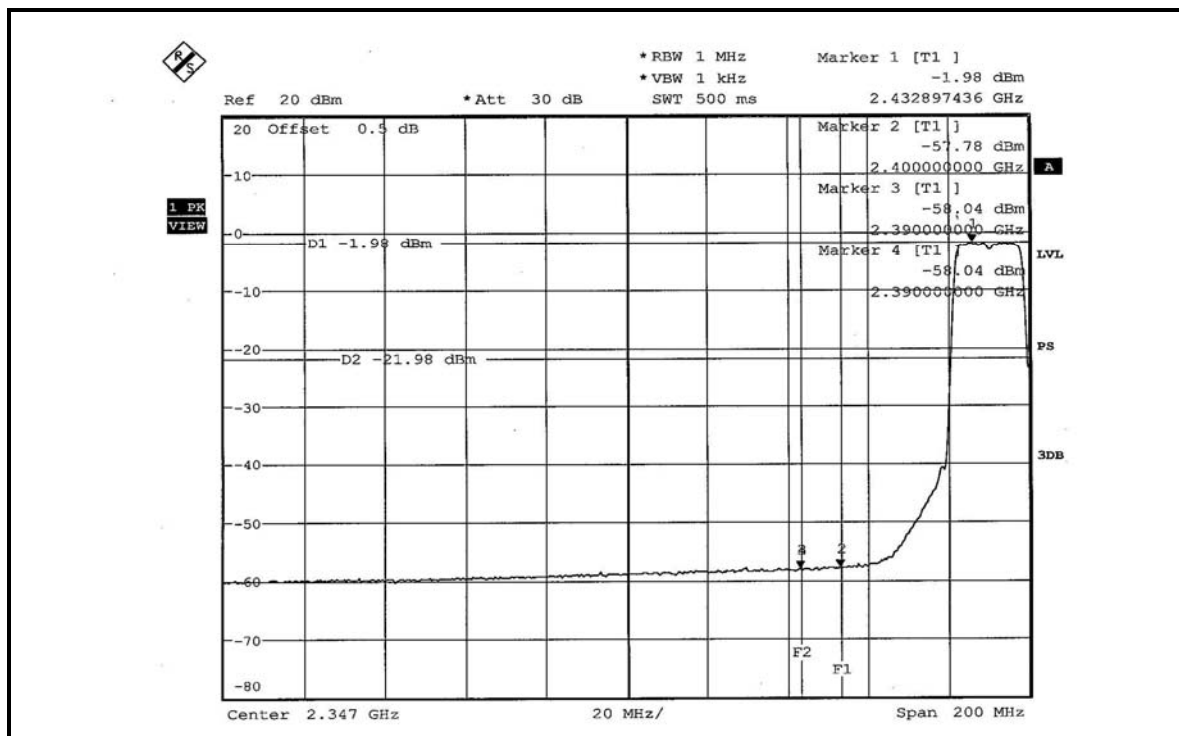
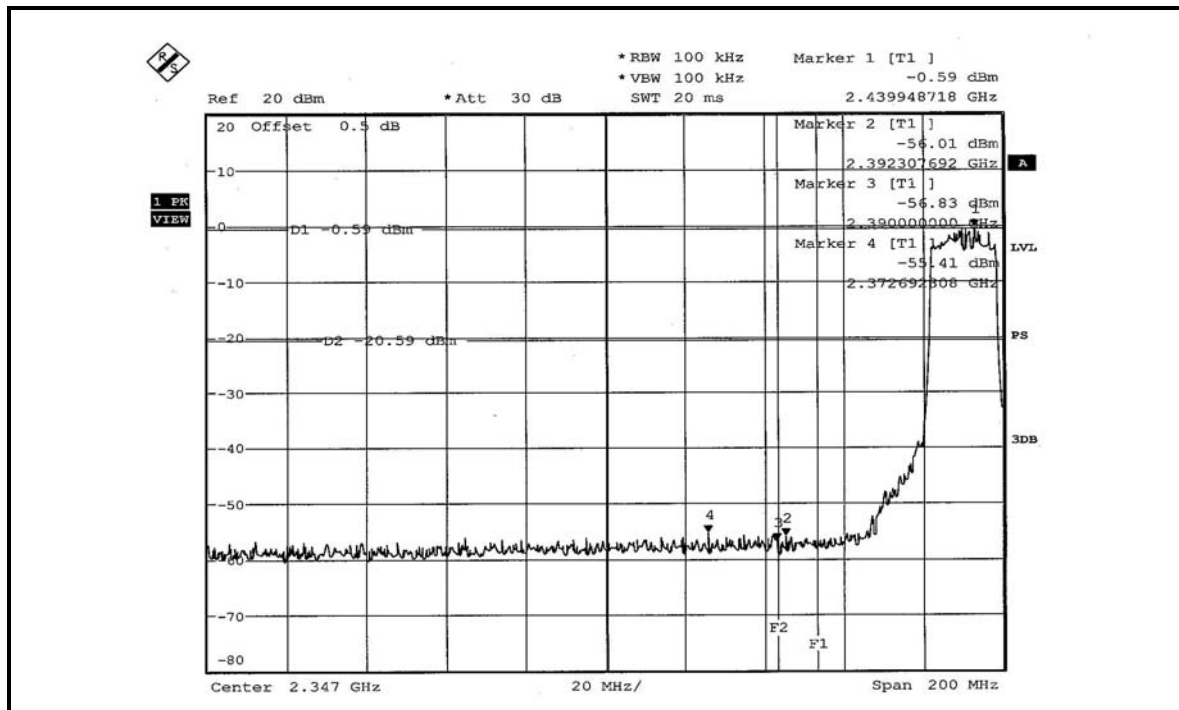

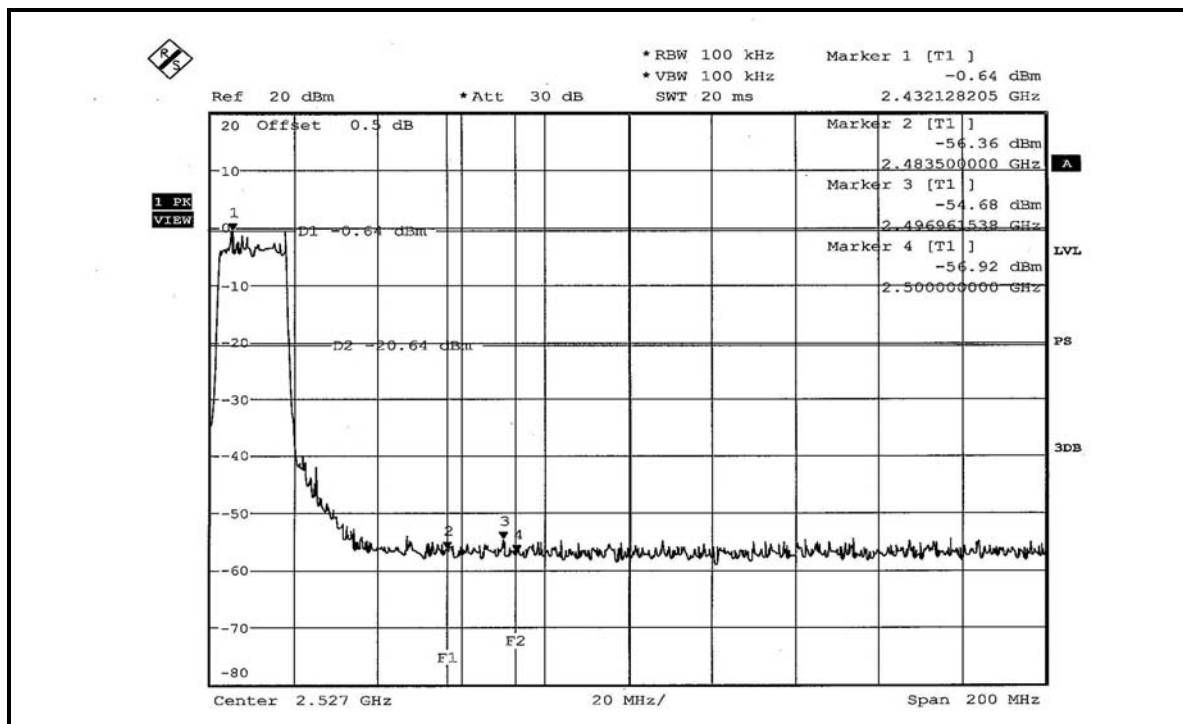
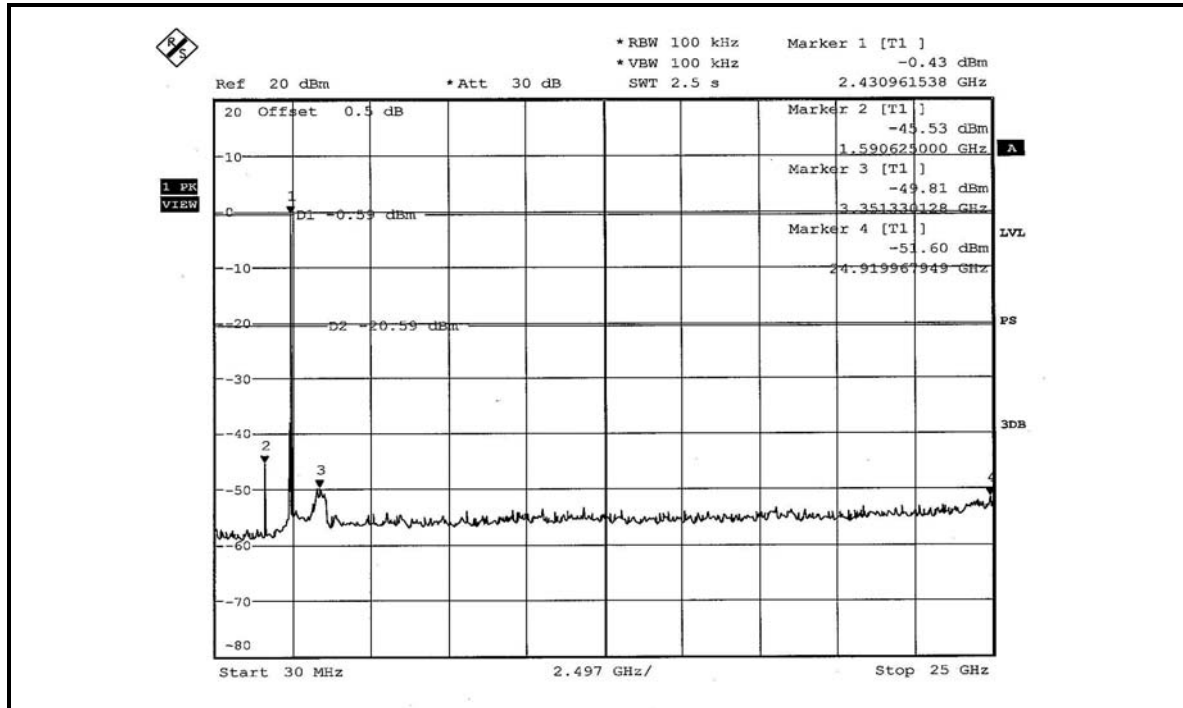

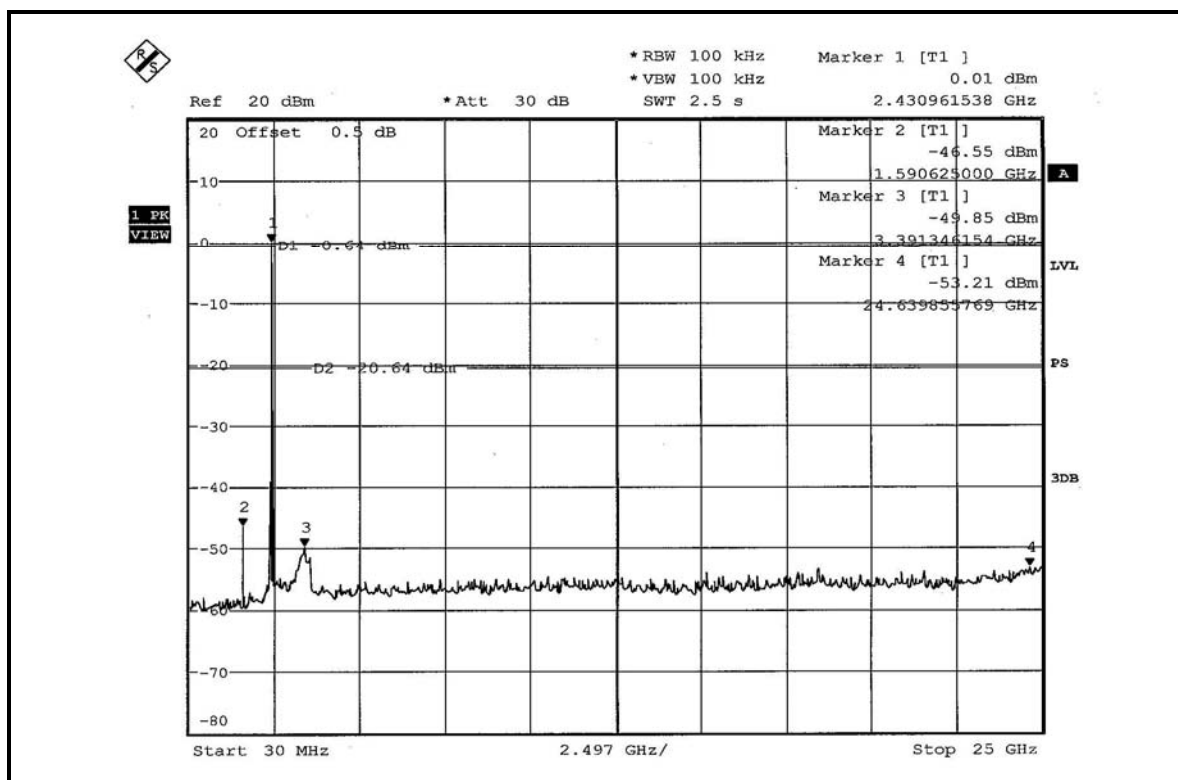
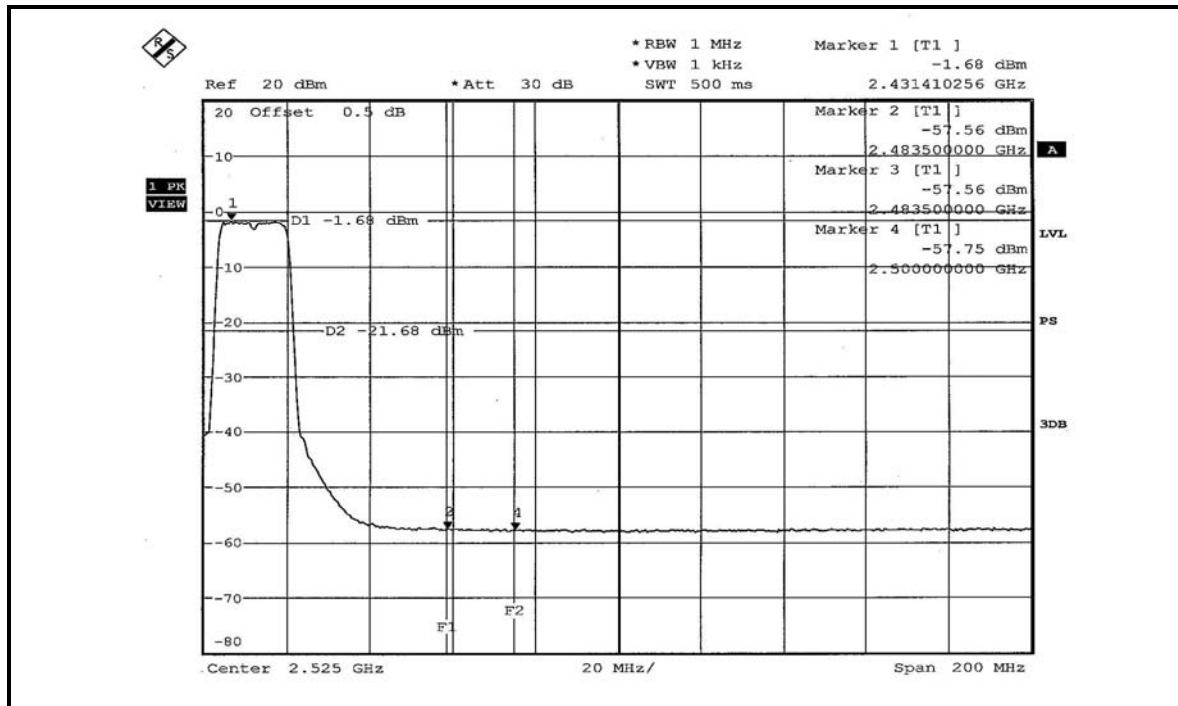



4.7 ANTENNA REQUIREMENT

4.7.1 STANDARD APPLICABLE

For intentional device, according to FCC 47 CFR Section 15.203, an intentional radiator shall be designed to ensure that no antenna other than that furnished by the responsible party shall be used with the device.

And according to FCC 47 CFR Section 15.247 (b), if transmitting antennas of directional gain greater than 6dBi are used, the power shall be reduced by the amount in dB that the directional gain of the antenna exceeds 6dBi.

4.7.2 ANTENNA CONNECTED CONSTRUCTION

The antenna type used in this product is Dipole antenna with RSMA antenna connector. The maximum Gain of this antenna is only 2dBi.



5 INFORMATION ON THE TESTING LABORATORIES

We, ADT Corp., were founded in 1988 to provide our best service in EMC, Radio, Telecom and Safety consultation. Our laboratories are accredited and approved by the following approval agencies according to ISO/IEC 17025

USA	FCC, UL, A2LA
Germany	TUV Rheinland
Japan	VCCI
Norway	NEMKO
Canada	INDUSTRY CANADA , CSA
R.O.C.	CNLA, BSMI, DGT
Netherlands	Telefication
Singapore	PSB , GOST-ASIA(MOU)
Russia	CERTIS(MOU)

Copies of accreditation certificates of our laboratories obtained from approval agencies can be downloaded from our web site:

www.adt.com.tw/index.5/phtml. If you have any comments, please feel free to contact us at the following:

Linko EMC/RF Lab:

Tel: 886-2-26052180

Fax: 886-2-26051924

Hsin Chu EMC/RF Lab:

Tel: 886-3-5935343

Fax: 886-3-5935342

Hwa Ya EMC/RF/Safety/Telecom Lab:

Tel: 886-3-3183232

Fax: 886-3-3185050

Linko RF Lab.

Tel: 886-3-3270910

Fax: 886-3-3270892

Web Site: www.adt.com.tw

The address and road map of all our labs can be found in our web site also.



APPENDIX-A

MODIFICATIONS RECORDERS FOR ENGINEERING CHANGES TO THE EUT BY THE LAB

No any modifications are made to the EUT by the lab during the test.