

SAR Test Report

Report No. : SF200615C06

Applicant : ASKEY COMPUTER CORP.

Address : 10F, NO.119, JIANKANG RD., ZHONGHE DIST., NEW TAIPEI CITY
23585, TAIWAN, R.O.C.

Product : TurboFon E4 / Handheld Device

FCC ID : H8NTN502A1

Brand : TURBONET / Coppernic

Model No. : TN502A1

Series Model : TN502A1(WOS), access, access(WOS)

Standards : FCC 47 CFR Part 2 (2.1093), IEEE C95.1:1992, IEEE Std 1528:2013
KDB 865664 D01 v01r04, KDB 865664 D02 v01r02
KDB 248227 D01 v02r02, KDB 447498 D01 v06
KDB 648474 D04 v01r03, KDB 941225 D01 v03r01
KDB 941225 D05 v02r05, KDB 941225 D06 v02r01

Sample Received Date : Mar. 13, 2020

Date of Testing : Jun. 13, 2020 ~ Sep. 09, 2020

Lab Address : No. 47-2, 14th Ling, Chia Pau Vil., Lin Kou Dist., New Taipei City, Taiwan

Test Location : No. 19, Hwa Ya 2nd Rd., Wen Hwa Vil., Kwei Shan Dist., Taoyuan City, Taiwan

CERTIFICATION: The above equipment have been tested by **Bureau Veritas Consumer Products Services (H.K.) Ltd., Taoyuan Branch–Lin Kou Laboratories**, and found compliance with the requirement of the above standards. The test record, data evaluation & Equipment Under Test (EUT) configurations represented herein are true and accurate accounts of the measurements of the sample’s SAR characteristics under the conditions specified in this report. It should not be reproduced except in full, without the written approval of our laboratory. The client should not use it to claim product certification, approval, or endorsement by TAF or any government agencies.

Prepared By : Shelly Hsueh
Shelly Hsueh / Specialist

Approved By : Gordon Lin
Gordon Lin / Manager



FCC Accredited No.: TW0003

This report is for your exclusive use. Any copying or replication of this report to or for any other person or entity, or use of our name or trademark, is permitted only with our prior written permission. This report sets forth our findings solely with respect to the test samples identified herein. The results set forth in this report are not indicative or representative of the quality or characteristics of the lot from which a test sample was taken or any similar or identical product unless specifically and expressly noted. Our report includes all of the tests requested by you and the results thereof based upon the information that you provided to us. You have 60 days from date of issuance of this report to notify us of any material error or omission caused by our negligence, provided, however, that such notice shall be in writing and shall specifically address the issue you wish to raise. A failure to raise such issue within the prescribed time shall constitute your unqualified acceptance of the completeness of this report, the tests conducted and the correctness of the report contents. Unless specific mention, the uncertainty of measurement has been explicitly taken into account to declare the compliance or non-compliance to the specification.

Table of Contents

Release Control Record	3
1. Summary of Maximum SAR Value	4
2. Description of Equipment Under Test	5
3. SAR Measurement System	6
3.1 Definition of Specific Absorption Rate (SAR)	6
3.2 SPEAG DASY6 System	6
3.2.1 Robot	7
3.2.2 Probes	8
3.2.3 Data Acquisition Electronics (DAE)	8
3.2.4 Phantoms	8
3.2.5 Device Holder	9
3.2.6 System Validation Dipoles	10
3.2.7 Power Source	10
3.2.8 Tissue Simulating Liquids	11
3.3 SAR System Verification	13
3.4 SAR Measurement Procedure	14
3.4.1 Area Scan and Zoom Scan Procedure	14
3.4.2 Volume Scan Procedure	15
3.4.3 Power Drift Monitoring	16
3.4.4 Spatial Peak SAR Evaluation	16
3.4.5 SAR Averaged Methods	16
4. SAR Measurement Evaluation	17
4.1 EUT Configuration and Setting	17
4.2 EUT Testing Position	26
4.2.1 Head Exposure Conditions	26
4.2.2 Body-worn Accessory Exposure Conditions	28
4.2.3 Hotspot Mode Exposure Conditions	29
4.2.4 Product Specific (Phablet) Exposure Conditions	30
4.3 Tissue Verification	31
4.4 System Validation	32
4.5 System Verification	33
4.6 Maximum Output Power	34
4.6.1 Maximum Target Conducted Power	34
4.6.2 Measured Conducted Power Result	34
4.7 SAR Testing Results	35
4.7.1 SAR Test Reduction Considerations	35
4.7.2 SAR Results for Head Exposure Condition	37
4.7.3 SAR Results for Body-worn Exposure Condition (Test Separation Distance is 15 mm)	40
4.7.4 SAR Results for Hotspot Exposure Condition (Test Separation Distance is 10 mm)	43
4.7.5 SAR Results for Product Specific (Phablet) Exposure Condition (Test Separation Distance is 0 mm)	48
4.7.6 SAR Measurement Variability	50
4.7.7 Simultaneous Multi-band Transmission Evaluation	51
5. Calibration of Test Equipment	53
6. Measurement Uncertainty	54
7. Information of the Testing Laboratories	58
Appendix A. SAR Plots of System Verification	
Appendix B. SAR Plots of SAR Measurement	
Appendix C. Calibration Certificate for Probe and Dipole	
Appendix D. Photographs of EUT and Setup	
Appendix E. Maximum Target Conducted Power	
Appendix F. Measured Conducted Power Result	
Appendix G. Analysis of Simultaneous Transmission SAR	
Appendix H. SAR to Peak Location Separation Ratio Analysis	

Release Control Record

Report No.	Reason for Change	Date Issued
SF200615C06	Initial release	Oct. 15, 2020

1. Summary of Maximum SAR Value

Equipment Class	Mode	Highest SAR-1g Head (W/kg)	Highest SAR-1g Body-worn Tested at 15 mm (W/kg)	Highest SAR-1g Hotspot Tested at 10 mm (W/kg)	Highest SAR-10g Product Specific Tested at 0 mm (W/kg)
PCE	GSM850	0.38	0.37	0.38	N/A
	GSM1900	0.97	1.16	1.08	1.76
	WCDMA II	1.18	1.18	1.09	2.94
	WCDMA IV	0.96	1.17	1.15	2.35
	WCDMA V	0.52	0.46	0.65	N/A
	LTE 2	1.06	1.10	1.09	2.19
	LTE 4	0.85	1.12	1.10	2.40
	LTE 5	0.41	0.33	0.49	N/A
	LTE 7	0.91	0.57	1.00	3.59
	LTE 17	0.21	0.23	0.31	N/A
	LTE 26	0.40	0.33	0.52	N/A
	LTE 38	0.64	0.32	0.89	N/A
LTE 41	0.77	0.42	0.73	N/A	
DTS	2.4G WLAN	0.59	0.13	0.24	N/A
NII	5.2G WLAN	N/A	N/A	1.00	N/A
	5.3G WLAN	0.57	0.42	N/A	0.83
	5.6G WLAN	0.60	0.64	N/A	0.86
	5.8G WLAN	0.91	0.50	0.77	N/A
DSS	Bluetooth	0.07	0.00	0.00	0.06

Highest Simultaneous Transmission SAR	Highest SAR-1g Head (W/kg)	Highest SAR-1g Body-worn Tested at 15 mm (W/kg)	Highest SAR-1g Hotspot Tested at 10 mm (W/kg)	Highest SAR-10g Product Specific Tested at 0 mm (W/kg)
	1.56	1.31	1.52	3.80

Note:

- The SAR criteria (**Head & Body: SAR-1g 1.6 W/kg, and Phablet: SAR-10g 4.0 W/kg**) for general population/uncontrolled exposure is specified in FCC 47 CFR part 2 (2.1093) and ANSI/IEEE C95.1-1992.

SAR Test Report

2. Description of Equipment Under Test

EUT Type	TurboFon E4 / Handheld Device
FCC ID	H8NTN502A1
Brand Name	TURBONET / Coppernic
Model Name	TN502A1
Series Model	TN502A1(WOS), access, access(WOS)
Tx Frequency Bands (Unit: MHz)	GSM850 : 824.2 ~ 848.8 GSM1900 : 1850.2 ~ 1909.8 WCDMA Band II : 1852.4 ~ 1907.6 WCDMA Band IV : 1712.4 ~ 1752.6 WCDMA Band V : 826.4 ~ 846.6 LTE Band 2 : 1850.7 ~ 1909.3 (BW: 1.4M, 3M, 5M, 10M, 15M, 20M) LTE Band 4 : 1710.7 ~ 1754.3 (BW: 1.4M, 3M, 5M, 10M, 15M, 20M) LTE Band 5 : 824.7 ~ 848.3 (BW: 1.4M, 3M, 5M, 10M) LTE Band 7 : 2502.5 ~ 2567.5 (BW: 5M, 10M, 15M, 20M) LTE Band 17 : 706.5 ~ 713.5 (BW: 5M, 10M) LTE Band 26 : 814.7 ~ 848.3 (BW: 1.4M, 3M, 5M, 10M, 15M) LTE Band 38 : 2572.5 ~ 2617.5 (BW: 5M, 10M, 15M, 20M) LTE Band 41 : 2498.5 ~ 2687.5 (BW: 5M, 10M, 15M, 20M) WLAN : 2412 ~ 2462, 5180 ~ 5240, 5260 ~ 5320, 5500 ~ 5700, 5745 ~ 5825 Bluetooth : 2402 ~ 2480
Uplink Modulations	GSM & GPRS : GMSK EDGE : 8PSK WCDMA : QPSK LTE : QPSK, 16QAM, 802.11b : DSSS 802.11a/g/n/ac : OFDM Bluetooth : GFSK, $\pi/4$ -DQPSK, 8-DPSK
Maximum Tune-up Conducted Power (Unit: dBm)	Please refer to section 4.6.1 of this report
Antenna Type	PIFA Antenna
EUT Stage	Engineering Sample

Note:

- All models are listed as below. Model TN502A1 is the representative for final test.

Brand	Product name	Model	Difference
TURBONET	TurboFon E4	TN502A1	With scanner
		TN502A1(WOS)	Without scanner
Coppernic	Handheld Device	access	With scanner Model: access is electrically identical to TN502A1, different brands and model names are for marketing purpose.
		access(WOS)	Without scanner Model: access(WOS) is electrically identical to TN502A1(WOS), different brands and model names are for marketing purpose.

- The above EUT information is declared by manufacturer and for more detailed features description please refers to the manufacturer's specifications or User's Manual.

List of Accessory:

Battery	Brand Name	ETI
	Model Name	BP19-002710
	Power Rating	3.85Vdc, 4000mAh, 15.4Wh
	Type	Li-ion

3. SAR Measurement System

3.1 Definition of Specific Absorption Rate (SAR)

SAR is related to the rate at which energy is absorbed per unit mass in an object exposed to a radio field. The SAR distribution in a biological body is complicated and is usually carried out by experimental techniques or numerical modeling. The standard recommends limits for two tiers of groups, occupational/controlled and general population/uncontrolled, based on a person's awareness and ability to exercise control over his or her exposure. In general, occupational/controlled exposure limits are higher than the limits for general population/uncontrolled.

The SAR definition is the time derivative (rate) of the incremental energy (dW) absorbed by (dissipated in) an incremental mass (dm) contained in a volume element (dv) of a given density (ρ). The equation description is as below:

$$SAR = \frac{d}{dt} \left(\frac{dW}{dm} \right) = \frac{d}{dt} \left(\frac{dW}{\rho dv} \right)$$

SAR is expressed in units of Watts per kilogram (W/kg)

SAR measurement can be related to the electrical field in the tissue by

$$SAR = \frac{\sigma |E|^2}{\rho}$$

Where: σ is the conductivity of the tissue, ρ is the mass density of the tissue and E is the RMS electrical field strength.

3.2 SPEAG DASY6 System

DASY6 system consists of high precision robot, probe alignment sensor, phantom, robot controller, controlled measurement server and near-field probe. The robot includes six axes that can move to the precision position of the DASY6 software defined. The DASY6 software can define the area that is detected by the probe. The robot is connected to controlled box. Controlled measurement server is connected to the controlled robot box. The DAE includes amplifier, signal multiplexing, AD converter, offset measurement and surface detection. It is connected to the Electro-optical coupler (ECO). The ECO performs the conversion from the optical into digital electric signal of the DAE and transfers data to the PC.

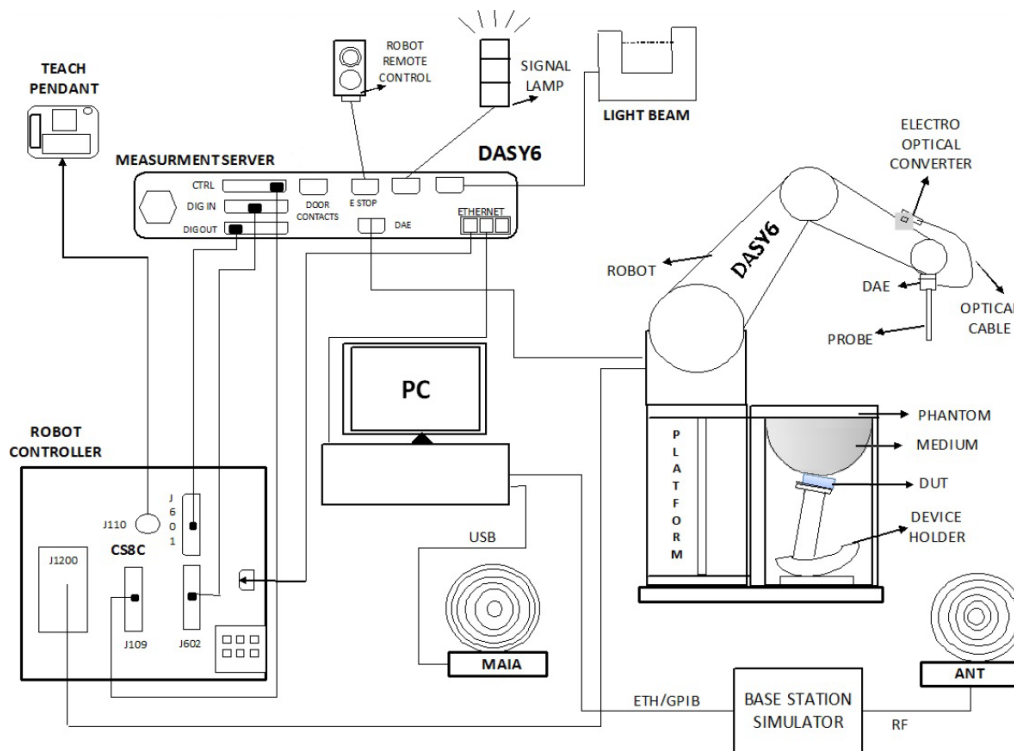

Fig-3.1 SPEAG DASY6 System Setup

3.2.1 Robot

The DASY6 systems use the high precision robots from Stäubli SA (France). For the 6-axis controller system, the robot controller version of CS8c from Stäubli is used. The Stäubli robot series have many features that are important for our application:

- High precision (repeatability ± 0.035 mm)
- High reliability (industrial design)
- Jerk-free straight movements
- Low ELF interference (the closed metallic construction shields against motor control fields)



Fig-3.2 SPEAG DASY6 System

SAR Test Report

3.2.2 Probes

The SAR measurement is conducted with the dosimetric probe. The probe is specially designed and calibrated for use in liquid with high permittivity. The dosimetric probe has special calibration in liquid at different frequency.

Model	EX3DV4	
Construction	Symmetrical design with triangular core. Built-in shielding against static charges. PEEK enclosure material (resistant to organic solvents, e.g., DGBE).	
Frequency	4 MHz to 10 GHz Linearity: ± 0.2 dB	
Directivity	± 0.1 dB in TSL (rotation around probe axis) ± 0.3 dB in TSL (rotation normal to probe axis)	
Dynamic Range	10 μ W/g to 100 mW/g Linearity: ± 0.2 dB (noise: typically < 1 μ W/g)	
Dimensions	Overall length: 337 mm (Tip: 20 mm) Tip diameter: 2.5 mm (Body: 12 mm) Typical distance from probe tip to dipole centers: 1 mm	

3.2.3 Data Acquisition Electronics (DAE)

Model	DAE3, DAE4	
Construction	Signal amplifier, multiplexer, A/D converter and control logic. Serial optical link for communication with DASY embedded system (fully remote controlled). Two step probe touch detector for mechanical surface detection and emergency robot stop.	
Measurement Range	-100 to +300 mV (16 bit resolution and two range settings: 4mV, 400mV)	
Input Offset Voltage	$< 5\mu$ V (with auto zero)	
Input Bias Current	< 50 fA	
Dimensions	60 x 60 x 68 mm	

3.2.4 Phantoms

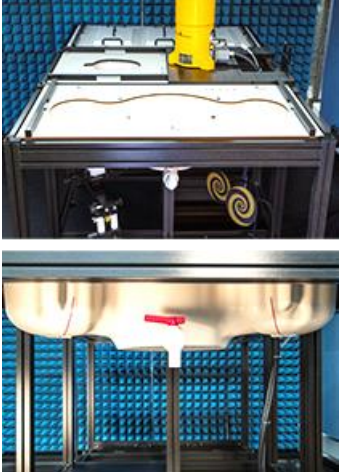
Model	SAM-Twin Phantom	
Construction	The shell corresponds to the specifications of the Specific Anthropomorphic Mannequin (SAM) phantom defined in IEEE Std 1528 and IEC 62209-1. It enables the dosimetric evaluation of left and right hand phone usage as well as body-mounted usage at the flat phantom region. A cover prevents evaporation of the liquid. Reference markings on the phantom allow the complete setup of all predefined phantom positions and measurement grids by teaching three points with the robot.	
Material	Vinylester, fiberglass reinforced (VE-GF)	
Shell Thickness	2 ± 0.2 mm (6 ± 0.2 mm at ear point)	
Dimensions	Length: 1000 mm Width: 500 mm Height: adjustable feet	
Filling Volume	approx. 25 liters	

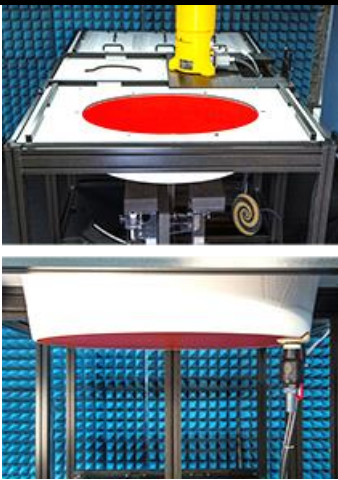
Model	ELI	
Construction	The ELI phantom is used for compliance testing of handheld and body-mounted wireless devices. ELI is fully compatible with the IEC 62209-2 standard and all known tissue simulating liquids. ELI has been optimized regarding its performance and can be integrated into our standard phantom tables. A cover prevents evaporation of the liquid. Reference markings on the phantom allow installation of the complete setup, including all predefined phantom positions and measurement grids, by teaching three points. The phantom is compatible with all SPEAG dosimetric probes and dipoles.	
Material	Vinylester, fiberglass reinforced (VE-GF)	
Shell Thickness	2.0 ± 0.2 mm (bottom plate)	
Dimensions	Major axis: 600 mm Minor axis: 400 mm	
Filling Volume	approx. 30 liters	

3.2.5 Device Holder

Model	MD4HHTV5 - Mounting Device for Hand-Held Transmitters	
Construction	In combination with the Twin SAM or ELI phantoms, the Mounting Device for Hand-Held Transmitters enables rotation of the mounted transmitter device to specified spherical coordinates. At the heads, the rotation axis is at the ear opening. Transmitter devices can be easily and accurately positioned according to IEC 62209-1, IEEE 1528, FCC, or other specifications. The device holder can be locked for positioning at different phantom sections (left head, right head, flat).	
Material	Polyoxymethylene (POM)	

Model	MDA4WTV5 - Mounting Device Adaptor for Ultra Wide Transmitters	
Construction	An upgrade kit to Mounting Device to enable easy mounting of wider devices like big smart-phones, e-books, small tablets, etc. It holds devices with width up to 140 mm.	
Material	Polyoxymethylene (POM)	

Model	MDA4SPV6 - Mounting Device Adaptor for Smart Phones	
Construction	The solid low-density MDA4SPV6 adaptor assuring no impact on the DUT radiation performance and is conform with any DUT design and shape.	
Material	ROHACELL	

SAR Test Report

Model	MD4LAPV5 - Mounting Device for Laptops and other Body-Worn Transmitters	
Construction	In combination with the Twin SAM or ELI phantoms, the Mounting Device (Body-Worn) enables testing of transmitter devices according to IEC 62209-2 specifications. The device holder can be locked for positioning at a flat phantom section.	
Material	Polyoxymethylene (POM), PET-G, Foam	

3.2.6 System Validation Dipoles

Model	D-Serial	
Construction	Symmetrical dipole with 1/4 balun. Enables measurement of feed point impedance with NWA. Matched for use near flat phantoms filled with tissue simulating solutions.	
Frequency	750 MHz to 5800 MHz	
Return Loss	> 20 dB	
Power Capability	> 100 W (f < 1GHz), > 40 W (f > 1GHz)	

3.2.7 Power Source

Model	Powersource1	
Signal Type	Continuous Wave	
Operating Frequencies	600 MHz to 5850 MHz	
Output Power	-5.0 dBm to +17.0 dBm	
Power Supply	5V DC, via USB jack	
Power Consumption	<3 W	
Applications	System performance check and validation with a CW signal.	

SAR Test Report

3.2.8 Tissue Simulating Liquids

For SAR measurement of the field distribution inside the phantom, the phantom must be filled with homogeneous tissue simulating liquid to a depth of at least 15 cm. For head SAR testing, the liquid height from the ear reference point (ERP) of the phantom to the liquid top surface is larger than 15 cm. For body SAR testing, the liquid height from the center of the flat phantom to the liquid top surface is larger than 15 cm. The nominal dielectric values of the tissue simulating liquids in the phantom and the tolerance of 10 % are listed in Table-3.1.

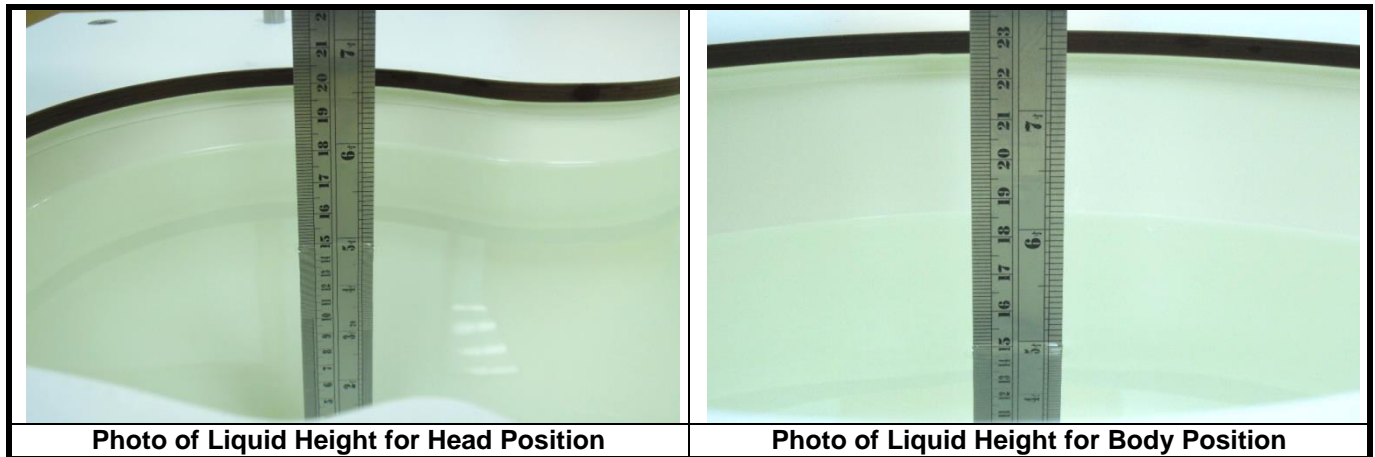

Table-3.1 Targets of Tissue Simulating Liquid

Frequency (MHz)	Target Permittivity	Range of $\pm 10\%$	Target Conductivity	Range of $\pm 10\%$
450	43.5	39.2 ~ 47.9	0.87	0.78 ~ 0.96
750	41.9	37.7 ~ 46.1	0.89	0.80 ~ 0.98
835	41.5	37.4 ~ 45.7	0.90	0.81 ~ 0.99
900	41.5	37.4 ~ 45.7	0.97	0.87 ~ 1.07
1450	40.5	36.5 ~ 44.6	1.20	1.08 ~ 1.32
1500	40.4	36.4 ~ 44.4	1.23	1.11 ~ 1.35
1640	40.2	36.2 ~ 44.2	1.31	1.18 ~ 1.44
1750	40.1	36.1 ~ 44.1	1.37	1.23 ~ 1.51
1800	40.0	36.0 ~ 44.0	1.40	1.26 ~ 1.54
1900	40.0	36.0 ~ 44.0	1.40	1.26 ~ 1.54
2000	40.0	36.0 ~ 44.0	1.40	1.26 ~ 1.54
2100	39.8	35.8 ~ 43.8	1.49	1.34 ~ 1.64
2300	39.5	35.6 ~ 43.5	1.67	1.50 ~ 1.84
2450	39.2	35.3 ~ 43.1	1.80	1.62 ~ 1.98
2600	39.0	35.1 ~ 42.9	1.96	1.76 ~ 2.16
3000	38.5	34.7 ~ 42.4	2.40	2.16 ~ 2.64
3500	37.9	34.1 ~ 41.7	2.91	2.62 ~ 3.20
4000	37.4	33.7 ~ 41.1	3.43	3.09 ~ 3.77
4500	36.8	33.1 ~ 40.5	3.94	3.55 ~ 4.33
5000	36.2	32.6 ~ 39.8	4.45	4.01 ~ 4.90
5200	36.0	32.4 ~ 39.6	4.66	4.19 ~ 5.13
5400	35.8	32.2 ~ 39.4	4.86	4.37 ~ 5.35
5600	35.5	32.0 ~ 39.1	5.07	4.56 ~ 5.58
5800	35.3	31.8 ~ 38.8	5.27	4.74 ~ 5.80
6000	35.1	31.6 ~ 38.6	5.48	4.93 ~ 6.03

SAR Test Report

The dielectric properties of the tissue simulating liquids are defined in IEC 62209-1 and IEC 62209-2. The dielectric properties of the tissue simulating liquids were verified prior to the SAR evaluation using a dielectric assessment kit and a network analyzer.

Since the range of $\pm 10\%$ of the required target values is used to measure relative permittivity and conductivity, the SAR correction procedure is applied to correct measured SAR for the deviations in permittivity and conductivity. Only positive correction has been used to scale up the measured SAR, and SAR result would not be corrected if the correction Δ SAR has a negative sign.

The following table gives the recipes for tissue simulating liquids.

Table-3.2 Recipes of Tissue Simulating Liquid

Tissue Type	Bactericide	DGBE	HEC	NaCl	Sucrose	Triton X-100	Water	Diethylene Glycol Mono-hexylether
H750	0.2	-	0.2	1.5	56.0	-	42.1	-
H835	0.2	-	0.2	1.5	57.0	-	41.1	-
H900	0.2	-	0.2	1.4	58.0	-	40.2	-
H1450	-	43.3	-	0.6	-	-	56.1	-
H1640	-	45.8	-	0.5	-	-	53.7	-
H1750	-	47.0	-	0.4	-	-	52.6	-
H1800	-	44.5	-	0.3	-	-	55.2	-
H1900	-	44.5	-	0.2	-	-	55.3	-
H2000	-	44.5	-	0.1	-	-	55.4	-
H2300	-	44.9	-	0.1	-	-	55.0	-
H2450	-	45.0	-	0.1	-	-	54.9	-
H2600	-	45.1	-	0.1	-	-	54.8	-
H3500	-	8.0	-	0.2	-	20.0	71.8	-
H5G	-	-	-	-	-	17.2	65.5	17.3

3.3 SAR System Verification

The system check verifies that the system operates within its specifications. It is performed daily or before every SAR measurement. The system check uses normal SAR measurements in the flat section of the phantom with a matched dipole at a specified distance. The system verification setup is shown as below.

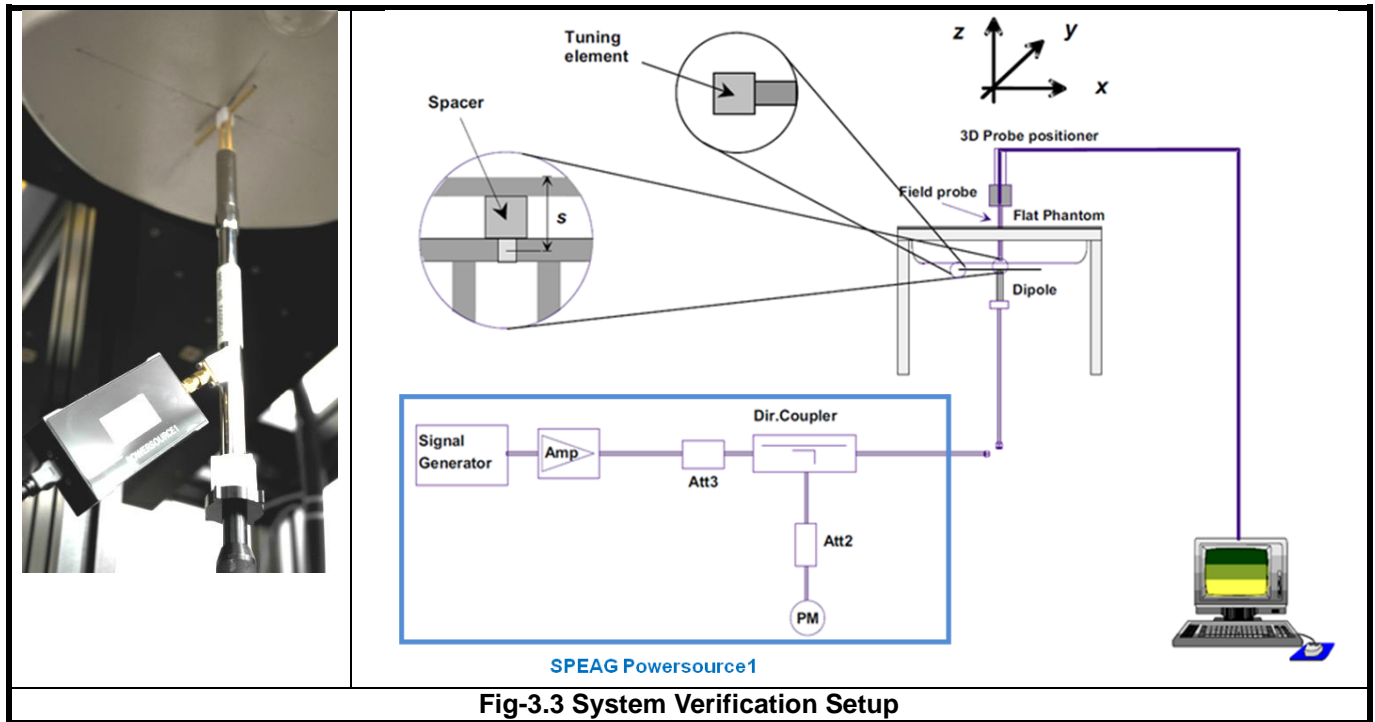

Fig-3.3 System Verification Setup

The SPEAG Powersource1 is a portable and very stable RF source providing a continuous wave (CW) signal. It is designed for conducting SAR system checks and SAR system validation of DASY and is compatible with IEC 62209-1, IEC 62209-2 and IEEE Std 1528 standards. The Powersource1 has been calibrated by SPEAG's ISO/IEC 17025-accredited calibration center. When using Powersource1, the setup can be simplified, as shown in Fig-3.3. The signal purity is warranted by design. Since the Powersource1 is calibrated, no additional equipment is needed and the Powersource1 can directly be connected to the SMA connector of the dipole without a cable as all separate components (signal generator, amplifier, coupler and power meter) are built into the unit.

The validation dipole is placed beneath the flat phantom with the specific spacer in place. The distance spacer is touch the phantom surface with a light pressure at the reference marking and be oriented parallel to the long side of the phantom. The Powersource1 is adjusted for the desired forward power of 17 dBm at the dipole connector and the RF output power would be turned on. After system check testing, the SAR result will be normalized to 1W forward input power and compared with the reference SAR value derived from validation dipole certificate report. The deviation of system check should be within 10 %.

3.4 SAR Measurement Procedure

According to the SAR test standard, the recommended procedure for assessing the peak spatial-average SAR value consists of the following steps:

- (a) Power reference measurement
- (b) Area scan
- (c) Zoom scan
- (d) Power drift measurement

The SAR measurement procedures for each of test conditions are as follows:

- (a) Make EUT to transmit maximum output power
- (b) Measure conducted output power through RF cable
- (c) Place the EUT in the specific position of phantom
- (d) Perform SAR testing steps on the DASY system
- (e) Record the SAR value

3.4.1 Area Scan and Zoom Scan Procedure

First area scan is used to locate the approximate location(s) of the local peak SAR value(s). The measurement grid within an area scan is defined by the grid extent, grid step size and grid offset. Next, in order to determine the EM field distribution in a three-dimensional spatial extension, zoom scan is required. The zoom scan is performed around the highest E-field value to determine the averaged SAR-distribution.

Measure the local SAR at a test point at 1.4 mm of the inner surface of the phantom recommended by SEPAG. The area scan (two-dimensional SAR distribution) is performed cover at least an area larger than the projection of the EUT or antenna. The measurement resolution and spatial resolution for interpolation shall be chosen to allow identification of the local peak locations to within one-half of the linear dimension of the corresponding side of the zoom scan volume. Following table provides the measurement parameters required for the area scan.

Parameter	$f \leq 3 \text{ GHz}$	$3 \text{ GHz} < f \leq 6 \text{ GHz}$
Maximum distance from closest measurement point to phantom surface	5 ± 1	$\delta \ln(2)/2 \pm 0.5$
Maximum probe angle from probe axis to phantom surface normal at the measurement location	$30^\circ \pm 1^\circ$	$20^\circ \pm 1^\circ$
Maximum area scan spatial resolution: $\Delta x_{\text{Area}}, \Delta y_{\text{Area}}$	$\leq 2 \text{ GHz: } \leq 15 \text{ mm}$ $2 - 3 \text{ GHz: } \leq 12 \text{ mm}$	$3 - 4 \text{ GHz: } \leq 12 \text{ mm}$ $4 - 6 \text{ GHz: } \leq 10 \text{ mm}$

From the scanned SAR distribution, identify the position of the maximum SAR value, in addition identify the positions of any local maxima with SAR values within 2 dB of the maximum value that will not be within the zoom scan of other peaks. Additional peaks shall be measured only when the primary peak is within 2 dB of the SAR compliance limit (e.g. 1 W/kg for 1.6 W/kg, 1 g limit; or 1.26 W/kg for 2 W/kg, 10 g limit).

The zoom scan (three-dimensional SAR distribution) is performed at the local maxima locations identified in previous area scan procedure. The zoom scan volume must be larger than the required minimum dimensions. When graded grids are used, which only applies in the direction normal to the phantom surface, the initial grid separation closest to the phantom surface and subsequent graded grid increment ratios must satisfy the required protocols. The 1-g SAR averaging volume must be fully contained within the zoom scan measurement volume boundaries; otherwise, the measurement must be repeated by shifting or expanding the zoom scan volume. The similar requirements also apply to 10-g SAR measurements. Following table provides the measurement parameters required for the zoom scan.

Parameter		$f \leq 3$ GHz	$3 \text{ GHz} < f \leq 6$ GHz
Maximum zoom scan spatial resolution: $\Delta x_{\text{Zoom}}, \Delta y_{\text{Zoom}}$		≤ 2 GHz: ≤ 8 mm 2 – 3 GHz: ≤ 5 mm	3 – 4 GHz: ≤ 5 mm 4 – 6 GHz: ≤ 4 mm
Maximum zoom scan spatial resolution, normal to phantom surface	<i>uniform grid:</i> $\Delta z_{\text{Zoom}}(n)$	≤ 5 mm	3 – 4 GHz: ≤ 4 mm 4 – 5 GHz: ≤ 3 mm 5 – 6 GHz: ≤ 2 mm
	<i>graded grids:</i> $\Delta z_{\text{Zoom}}(1)$	≤ 4 mm	3 – 4 GHz: ≤ 3.0 mm 4 – 5 GHz: ≤ 2.5 mm 5 – 6 GHz: ≤ 2.0 mm
	$\Delta z_{\text{Zoom}}(n>1)$	$\leq 1.5 \cdot \Delta z_{\text{Zoom}}(n-1)$ mm	
Minimum zoom scan volume (x, y, z)		≥ 30 mm	3 – 4 GHz: ≥ 28 mm 4 – 5 GHz: ≥ 25 mm 5 – 6 GHz: ≥ 22 mm

Per IEC 62209-2 AMD1, the successively higher resolution zoom scan is required if the zoom scan measured as defined above complies with both of the following criteria, or if the peak spatial-average SAR is below 0.1 W/kg, no additional measurements are needed:

- (1) The smallest horizontal distance from the local SAR peaks to all points 3 dB below the SAR peak shall be larger than the horizontal grid steps in both x and y directions ($\Delta x, \Delta y$). This shall be checked for the measured zoom scan plane conformal to the phantom at the distance z_{M1} .
- (2) The ratio of the SAR at the second measured point (M2) to the SAR at the closest measured point (M1) at the x-y location of the measured maximum SAR value shall be at least 30 %.

If one or both of the above criteria are not met, the zoom scan measurement shall be repeated using a finer resolution. New horizontal and vertical grid steps shall be determined from the measured SAR distribution so that the above criteria are met. Compliance with the above two criteria shall be demonstrated for the new measured zoom scan.

3.4.2 Volume Scan Procedure

The volume scan is used for assess overlapping SAR distributions for antennas transmitting in different frequency bands. It is equivalent to an oversized zoom scan used in standalone measurements. The measurement volume will be used to enclose all the simultaneous transmitting antennas. For antennas transmitting simultaneously in different frequency bands, the volume scan is measured separately in each frequency band. In order to sum correctly to compute the 1g aggregate SAR, the EUT remain in the same test position for all measurements and all volume scan use the same spatial resolution and grid spacing. When all volume scan were completed, the software, SEMCAD postprocessor can combine and subsequently superpose these measurement data to calculating the multiband SAR.

3.4.3 Power Drift Monitoring

All SAR testing is under the EUT install full charged battery and transmit maximum output power. In DASY measurement software, the power reference measurement and power drift measurement procedures are used for monitoring the power drift of EUT during SAR test. Both these procedures measure the field at a specified reference position before and after the SAR testing. The software will calculate the field difference in dB. If the power drift more than 5%, the SAR will be retested.

3.4.4 Spatial Peak SAR Evaluation

The procedure for spatial peak SAR evaluation has been implemented according to the test standard. It can be conducted for 1g and 10g, as well as for user-specific masses. The DASY software includes all numerical procedures necessary to evaluate the spatial peak SAR value.

The base for the evaluation is a "cube" measurement. The measured volume must include the 1g and 10g cubes with the highest averaged SAR values. For that purpose, the center of the measured volume is aligned to the interpolated peak SAR value of a previously performed area scan.

The entire evaluation of the spatial peak values is performed within the post-processing engine (SEMCAD). The system always gives the maximum values for the 1g and 10g cubes. The algorithm to find the cube with highest averaged SAR is divided into the following stages:

- (a) Extraction of the measured data (grid and values) from the Zoom Scan
- (b) Calculation of the SAR value at every measurement point based on all stored data (A/D values and measurement parameters)
- (c) Generation of a high-resolution mesh within the measured volume
- (d) Interpolation of all measured values from the measurement grid to the high-resolution grid
- (e) Extrapolation of the entire 3-D field distribution to the phantom surface over the distance from sensor to surface
- (f) Calculation of the averaged SAR within masses of 1g and 10g

3.4.5 SAR Averaged Methods

In DASY, the interpolation and extrapolation are both based on the modified Quadratic Shepard's method. The interpolation scheme combines a least-square fitted function method and a weighted average method which are the two basic types of computational interpolation and approximation.

Extrapolation routines are used to obtain SAR values between the lowest measurement points and the inner phantom surface. The extrapolation distance is determined by the surface detection distance and the probe sensor offset. The uncertainty increases with the extrapolation distance. To keep the uncertainty within 1% for the 1 g and 10 g cubes, the extrapolation distance should not be larger than 5 mm.

4. SAR Measurement Evaluation

4.1 EUT Configuration and Setting

<Connections between EUT and System Simulator>

For WWAN SAR testing, the EUT was linked and controlled by base station emulator. Communication between the EUT and the emulator was established by air link. The distance between the EUT and the communicating antenna of the emulator is larger than 50 cm and the output power radiated from the emulator antenna is at least 30 dB smaller than the output power of EUT. The EUT was set from the emulator to radiate maximum output power during SAR testing.

<Considerations Related to GSM / GPRS / EDGE for Setup and Testing>

The maximum multi-slot capability supported by this device is as below.

1. This EUT is class B device
2. This EUT supports GPRS multi-slot class 8 (max. uplink: 1, max. downlink: 4, total timeslots: 5)
3. This EUT supports EDGE multi-slot class 8 (max. uplink: 1, max. downlink: 4, total timeslots: 5)
4. This EUT supports DTM multi-slot class 10 (max. uplink: 2 for 1 CS & 1 PS, max. downlink: 4, total timeslots: 5)

For GSM850 frequency band, the power control level is set to 5 for GSM mode and GPRS (GMSK: CS1), and set to 8 for EDGE (GMSK: MCS1, 8PSK: MCS9). For GSM1900 frequency band, the power control level is set to 0 for GSM mode and GPRS (GMSK: CS1), and set to 2 for EDGE (GMSK: MCS1, 8PSK: MCS9).

SAR test reduction for GPRS and EDGE modes is determined by the source-based time-averaged output power specified for production units, including tune-up tolerance. The data mode with highest specified time-averaged output power should be tested for SAR compliance in the applicable exposure conditions. For modes with the same specified maximum output power and tolerance, the higher number time-slot configuration should be tested.

SAR Test Report

<Considerations Related to WCDMA for Setup and Testing>

WCDMA Handsets Head SAR

SAR for next to the ear head exposure is measured using a 12.2 kbps RMC with TPC bits configured to all "1's". The 3G SAR test reduction procedure is applied to AMR configurations with 12.2 kbps RMC as the primary mode.

WCDMA Handsets Body-worn SAR

SAR for body-worn configurations is measured using a 12.2 kbps RMC with TPC bits configured to all "1's". The 3G SAR test reduction procedure is applied to other spreading codes and multiple DPDCH_n configurations supported by the handset with 12.2 kbps RMC as the primary mode.

Handsets with Release 5 HSDPA

The 3G SAR test reduction procedure is applied to HSDPA body-worn configurations with 12.2 kbps RMC as the primary mode. Otherwise, SAR is measured for HSDPA using the HSDPA body SAR procedures in the "Release 5 HSDPA Data Devices", for the highest reported SAR body-worn exposure configuration in 12.2 kbps RMC. Handsets with both HSDPA and HSUPA are tested according to Release 6 HSPA test procedures.

Handsets with Release 6 HSUPA

The 3G SAR test reduction procedure is applied to HSPA (HSUPA/HSDPA with RMC) body-worn configurations with 12.2 kbps RMC as the primary mode. Otherwise, SAR is measured for HSPA using the HSPA body SAR procedures in the "Release 6 HSPA Data Devices", for the highest reported body-worn exposure SAR configuration in 12.2 kbps RMC. When VOIP is applicable for next to the ear head exposure in HSPA, the 3G SAR test reduction procedure is applied to HSPA with 12.2 kbps RMC as the primary mode; otherwise, the same HSPA configuration used for body-worn measurements is tested for next to the ear head exposure.

Release 5 HSDPA Data Devices

The 3G SAR test reduction procedure is applied to body SAR with 12.2 kbps RMC as the primary mode. Otherwise, body SAR for HSDPA is measured using an FRC with H-Set 1 in Sub-test 1 and a 12.2 kbps RMC configured in Test Loop Mode 1, for the highest reported SAR configuration in 12.2 kbps RMC without HSDPA. HSDPA is configured according to the applicable UE category of a test device. The number of HS-DSCH/HS-PDSCHs, HARQ processes, minimum inter-TTI interval, transport block sizes and RV coding sequence are defined by the H-set. To maintain a consistent test configuration and stable transmission conditions, QPSK is used in the H-set for SAR testing. HS-DPCCH should be configured with a CQI feedback cycle of 4 ms and a CQI repetition factor of 2 to maintain a constant rate of active CQI slots. DPCCH and DPDCH gain factors (β_c , β_d), and HS-DPCCH power offset parameters (Δ_{ACK} , Δ_{NACK} , Δ_{CQI}) are set according to values indicated in below. The CQI value is determined by the UE category, transport block size, number of HS-PDSCHs and modulation used in the H-set.

SAR Test Report

Sub-test	β_c	β_d	β_d (SF)	β_c/β_d	$\beta_{HS}^{(1)(2)}$	CM ⁽³⁾ (dB)	MPR ⁽³⁾ (dB)
1	2/15	15/15	64	2/15	4/15	0.0	0.0
2	12/15 ⁽⁴⁾	15/15 ⁽⁴⁾	64	12/15 ⁽⁴⁾	24/15	1.0	0.0
3	15/15	8/15	64	15/8	30/15	1.5	0.5
4	15/15	4/15	64	15/4	30/15	1.5	0.5

Note 1: Δ_{ACK} , Δ_{NACK} and $\Delta_{CQI} = 30/15$ with $\beta_{HS} = 30/15 * \beta_c$.
 Note 2: For the HS-DPCCH power mask requirement test in clause 5.2C, 5.7A, and the Error Vector Magnitude (EVM) with HS-DPCCH test in clause 5.13.1A, and HSDPA EVM with phase discontinuity in clause 5.13.1AA, Δ_{ACK} and $\Delta_{NACK} = 30/15$ with $\beta_{HS} = 30/15 * \beta_c$, and $\Delta_{CQI} = 24/15$ with $\beta_{HS} = 24/15 * \beta_c$.
 Note 3: CM = 1 for $\beta_c/\beta_d = 12/15, \beta_{HS}/\beta_c = 24/15$. For all other combinations of DPDCH, DPCCH and HS-DPCCH the MPR is based on the relative CM difference. This is applicable for only UEs that support HSDPA in release 6 and later releases.
 Note 4: For subtest 2 the β_c/β_d ratio of 12/15 for the TFC during the measurement period (TF1, TF0) is achieved by setting the signalled gain factors for the reference TFC (TF1, TF0) to $\beta_c = 11/15$ and $\beta_d = 15/15$.

Release 6 HSPA Data Devices

The 3G SAR test reduction procedure is applied to body SAR with 12.2 kbps RMC as the primary mode. Otherwise, body SAR for HSPA is measured with E-DCH Sub-test 5, using H-Set 1 and QPSK for FRC and a 12.2 kbps RMC configured in Test Loop Mode 1 and power control algorithm 2, according to the highest reported body SAR configuration in 12.2 kbps RMC without HSPA. When VOIP applies to head exposure, the 3G SAR test reduction procedure is applied with 12.2 kbps RMC as the primary mode. Otherwise, the same HSPA configuration used for body SAR measurements are applied to head exposure testing. Due to inner loop power control requirements in HSPA, a communication test set is required for output power and SAR tests. The 12.2 kbps RMC, FRC H-set 1 and E-DCH configurations for HSPA are configured according to the β values indicated in below.

Sub-test	β_c	β_d	β_d (SF)	β_c/β_d	$\beta_{HS}^{(1)}$	β_{ec}	$\beta_{ed}^{(4)(5)}$	β_{ed} (SF)	β_{ed} (Codes)	CM ⁽²⁾ (dB)	MPR ⁽²⁾⁽⁶⁾ (dB)	AG ⁽⁵⁾ Index	E-TFCI
1	11/15 ⁽³⁾	15/15 ⁽³⁾	64	11/15 ⁽³⁾	22/15	209/225	1309/225	4	1	1.0	0.0	20	75
2	6/15	15/15	64	6/15	12/15	12/15	94/75	4	1	3.0	2.0	12	67
3	15/15	9/15	64	15/9	30/15	30/15	$\beta_{ed1}: 47/15$ $\beta_{ed2}: 47/15$	4 4	2	2.0	1.0	15	92
4	2/15	15/15	64	2/15	4/15	2/15	56/75	4	1	3.0	2.0	17	71
5	15/15	0	-	-	5/15	5/15	47/15	4	1	1.0	0.0	12	67

Note 1: For sub-test 1 to 4, Δ_{ACK} , Δ_{NACK} and $\Delta_{CQI} = 30/15$ with $\beta_{HS} = 30/15 * \beta_c$. For sub-test 5, Δ_{ACK} , Δ_{NACK} and $\Delta_{CQI} = 5/15$ with $\beta_{HS} = 5/15 * \beta_c$.
 Note 2: CM = 1 for $\beta_c/\beta_d = 12/15, \beta_{HS}/\beta_c = 24/15$. For all other combinations of DPDCH, DPCCH, HS-DPCCH, E-DPCCH and E-DPCCH the MPR is based on the relative CM difference.
 Note 3: For subtest 1 the β_c/β_d ratio of 11/15 for the TFC during the measurement period (TF1, TF0) is achieved by setting the signalled gain factors for the reference TFC (TF1, TF0) to $\beta_c = 10/15$ and $\beta_d = 15/15$.
 Note 4: In case of testing by UE using E-DPDCH Physical Layer category 1, Sub-test 3 is omitted according to TS25.306 Table 5.1g.
 Note 5: β_{ed} can not be set directly; it is set by Absolute Grant Value.
 Note 6: For subtests 2, 3 and 4, UE may perform E-DPDCH power scaling at max power which could results in slightly smaller MPR values.

SAR Test Report

HSPA+ SAR Guidance

The 3G SAR test reduction procedure is applied to HSPA+(uplink) with 12.2 kbps RMC as the primary mode. Otherwise, when SAR is required for Rel. 6 HSPA, SAR is required for Rel. 7 HSPA+. Power is measured for HSPA+ that supports uplink 16QAM according to configurations in Table C.11.1.4 of 3GPP TS 34.121-1 to determine SAR test reduction.

Sub-test	$\beta_c^{(3)}$	β_d	$\beta_{HS}^{(1)}$	β_{ec}	$\beta_{ed}^{(4)}$ (2xSF2)	$\beta_{ed}^{(4)}$ (2xSF4)	CM ⁽²⁾ (dB)	MPR ⁽²⁾ (dB)	AG ⁽⁴⁾ Index	E-TFCI ⁽⁵⁾	E-TFCI (boost)
1	1	0	30/15	30/15	β_{ed1} : 30/15 β_{ed2} : 30/15	β_{ed3} : 24/15 β_{ed4} : 24/15	3.5	2.5	14	105	105

Note 1: Δ_{ACK} , Δ_{NACK} and $\Delta_{CQI} = 30/15$ with $\beta_{HS} = 30/15 * \beta_c$.

Note 2: CM = 3.5 and the MPR is based on the relative CM difference, MPR = MAX(CM-1,0).

Note 3: DPDCH is not configured, therefore the β_c is set to 1 and $\beta_d = 0$ by default.

Note 4: β_{ed} can not be set directly; it is set by Absolute Grant Value.

Note 5: All the sub-tests require the UE to transmit 2SF2+2SF4 16QAM EDCH and they apply for UE using E-DPDCH category 7. E-DCH TTI is set to 2ms TTI and E-DCH table index = 2. To support these E-DCH configurations DPDCH is not allocated. The UE is signalled to use the extrapolation algorithm.

DC-HSDPA SAR Guidance

The 3G SAR test reduction procedure is applied to DC-HSDPA with 12.2 kbps RMC as the primary mode. Otherwise, when SAR is required for Rel. 5 HSDPA, SAR is required for Rel. 8 DC-HSDPA. Power is measured for DC-HSDPA according to the H-Set 12, FRC configuration in Table C.8.1.12 of 3GPP TS 34.121-1 to determine SAR test reduction. A primary and a secondary serving HS-DSCH Cell are required to perform the power measurement and for the results to be acceptable.

<Considerations Related to LTE for Setup and Testing>

This device contains LTE transmitter which follows 3GPP standards, is category 3, supports both QPSK and QAM modulations, and supported LTE band and channel bandwidth is listed in below. The output power was tested per 3GPP TS 36.521-1 maximum transmit procedures for both QPSK and QAM modulation. The results please refer to section 4.6 of this report.

EUT Supported LTE Band and Channel Bandwidth						
LTE Band	BW 1.4 MHz	BW 3 MHz	BW 5 MHz	BW 10 MHz	BW 15 MHz	BW 20 MHz
2	V	V	V	V	V	V
4	V	V	V	V	V	V
5	V	V	V	V		
7			V	V	V	V
17			V	V		
26	V	V	V	V	V	
38			V	V	V	V
41			V	V	V	V

SAR Test Report

The LTE maximum power reduction (MPR) in accordance with 3GPP TS 36.101 is active all times during LTE operation. The allowed MPR for the maximum output power is specified in below.

Modulation	Channel Bandwidth / RB Configurations						LTE MPR Setting (dB)
	BW 1.4 MHz	BW 3 MHz	BW 5 MHz	BW 10 MHz	BW 15 MHz	BW 20 MHz	
QPSK	> 5	> 4	> 8	> 12	> 16	> 18	1
16QAM	<= 5	<= 4	<= 8	<= 12	<= 16	<= 18	1
16QAM	> 5	> 4	> 8	> 12	> 16	> 18	2
64QAM	<= 5	<= 4	<= 8	<= 12	<= 16	<= 18	2
64QAM	> 5	> 4	> 8	> 12	> 16	> 18	3

Note: MPR is according to the standard and implemented in the circuit (mandatory).

In addition, the device is compliant with additional maximum power reduction (A-MPR) requirements defined in 3GPP TS 36.101 section 6.2.4 that was disabled for all FCC compliance testing.

During LTE SAR testing, the related parameters of operating band, channel bandwidth, uplink channel number, modulation type, and RB was set in base station simulator. When the EUT has registered and communicated to base station simulator, the simulator set to make EUT transmitting the maximum radiated power.

TDD-LTE Setup Configurations

According to KDB 941225 D05, SAR testing for TDD-LTE device must be tested using a fixed periodic duty factor according to the highest transmission duty factor implemented for the device and supported by the defined 3GPP TDD-LTE configurations. The TDD-LTE of this device supports frame structure type 2 defined in 3GPP TS 36.211 section 4.2, and the frame structure configuration can be referred to below.

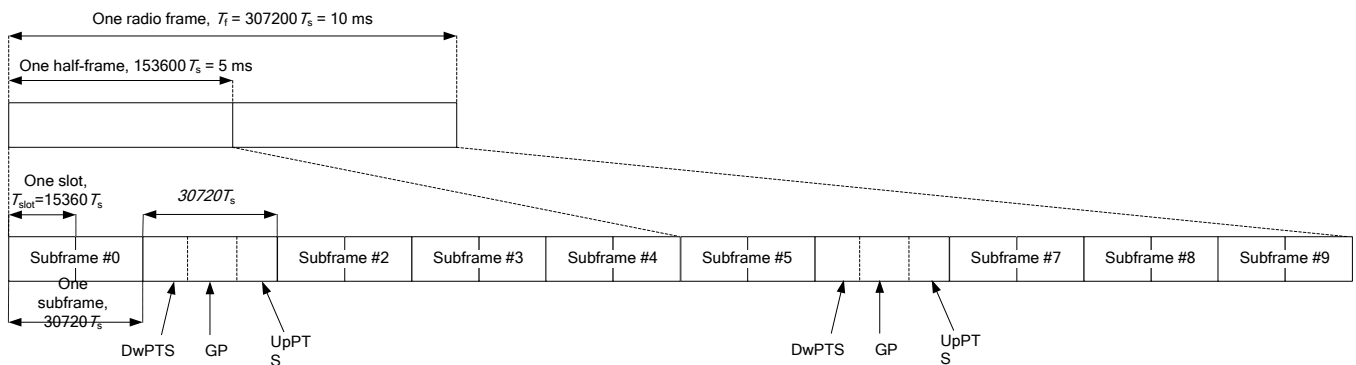

3GPP TS 36.211 Figure 4.2-1: Frame Structure Type 2

SAR Test Report

Special Subframe Configuration	Normal Cyclic Prefix in Downlink			Extended Cyclic Prefix in Downlink		
	DwPTS	UpPTS		DwPTS	UpPTS	
		Normal Cyclic Prefix in Uplink	Extended Cyclic Prefix in Uplink		Normal Cyclic Prefix in Uplink	Extended Cyclic Prefix in Uplink
0	6592 • Ts	2192 • Ts	2560 • Ts	7680 • Ts	2192 • Ts	2560 • Ts
1	19760 • Ts			20480 • Ts		
2	21952 • Ts			23040 • Ts		
3	24144 • Ts			25600 • Ts		
4	26336 • Ts	4384 • Ts	5120 • Ts	7680 • Ts	4384 • Ts	5120 • Ts
5	6592 • Ts			20480 • Ts		
6	19760 • Ts			23040 • Ts		
7	21952 • Ts			12800 • Ts		
8	24144 • Ts			-		
9	13168 • Ts	-	-	-	-	-

3GPP TS 36.211 Table 4.2-1: Configuration of Special Subframe

Uplink-Downlink Configuration	Downlink-to-Uplink Switch-Point Periodicity	Subframe Number									
		0	1	2	3	4	5	6	7	8	9
0	5 ms	D	S	U	U	U	D	S	U	U	U
1	5 ms	D	S	U	U	D	D	S	U	U	D
2	5 ms	D	S	U	D	D	D	S	U	D	D
3	10 ms	D	S	U	U	U	D	D	D	D	D
4	10 ms	D	S	U	U	D	D	D	D	D	D
5	10 ms	D	S	U	D	D	D	D	D	D	D
6	5 ms	D	S	U	U	U	D	S	U	U	D

3GPP TS 36.211 Table 4.2-2: Uplink-Downlink Configurations

The variety of different TD-LTE uplink-downlink configurations allows a network operator to allocate the network's capacity between uplink and downlink traffic to meet the needs of the network. The uplink duty cycle of these seven configurations can readily be computed and shown in below.

UL-DL Configuration	0	1	2	3	4	5	6
Highest Duty-Cycle	63.33%	43.33%	23.33%	31.67%	21.67%	11.67%	53.33%

<Considerations Related to WLAN for Setup and Testing>

In general, various vendor specific external test software and chipset based internal test modes are typically used for SAR measurement. These chipset based test mode utilities are generally hardware and manufacturer dependent, and often include substantial flexibility to reconfigure or reprogram a device. A Wi-Fi device must be configured to transmit continuously at the required data rate, channel bandwidth and signal modulation, using the highest transmission duty factor supported by the test mode tools for SAR measurement. The test frequencies established using test mode must correspond to the actual channel frequencies. When 802.11 frame gaps are accounted for in the transmission, a maximum transmission duty factor of 92 - 96% is typically achievable in most test mode configurations. A minimum transmission duty factor of 85% is required to avoid certain hardware and device implementation issues related to wide range SAR scaling. In addition, a periodic transmission duty factor is required for current generation SAR systems to measure SAR correctly. The reported SAR must be scaled to 100% transmission duty factor to determine compliance at the maximum tune-up tolerance limit.

According to KDB 248227 D01, this device has installed WLAN engineering testing software which can provide continuous transmitting RF signal. During WLAN SAR testing, this device was operated to transmit continuously at the maximum transmission duty with specified transmission mode, operating frequency, lowest data rate, and maximum output power.

Initial Test Configuration

An initial test configuration is determined for OFDM transmission modes in 2.4 GHz and 5 GHz bands according to the channel bandwidth, modulation and data rate combination(s) with the highest maximum output power specified for production units in each standalone and aggregated frequency band. When the same maximum power is specified for multiple transmission modes in a frequency band, the largest channel bandwidth, lowest order modulation, lowest data rate and lowest order 802.11a/g/n/ac mode is used for SAR measurement, on the highest measured output power channel in the initial test configuration, for each frequency band.

Subsequent Test Configuration

SAR measurement requirements for the remaining 802.11 transmission mode configurations that have not been tested in the initial test configuration are determined separately for each standalone and aggregated frequency band, in each exposure condition, according to the maximum output power specified for production units. Additional power measurements may be required to determine if SAR measurements are required for subsequent highest output power channels in a subsequent test configuration. When the highest reported SAR for the initial test configuration according to the initial test position or fixed exposure position requirements, is adjusted by the ratio of the subsequent test configuration to initial test configuration specified maximum output power and the adjusted SAR is ≤ 1.2 W/kg, SAR is not required for that subsequent test configuration.

SAR Test Configuration and Channel Selection

When multiple channel bandwidth configurations in a frequency band have the same specified maximum output power, the initial test configuration is using largest channel bandwidth, lowest order modulation, lowest data rate, and lowest order 802.11 mode (i.e., 802.11a is chosen over 802.11n then 802.11ac or 802.11g is chosen over 802.11n). After an initial test configuration is determined, if multiple test channels have the same measured maximum output power, the channel chosen for SAR measurement is determined according to the following.

- 1) The channel closest to mid-band frequency is selected for SAR measurement.
- 2) For channels with equal separation from mid-band frequency; for example, high and low channels or two mid-band channels, the higher frequency (number) channel is selected for SAR measurement.

Test Reduction for U-NII-1 (5.2 GHz) and U-NII-2A (5.3 GHz) Bands

For devices that operate in both U-NII bands using the same transmitter and antenna(s), SAR test reduction is determined according to the following.

- 1) When the same maximum output power is specified for both bands, begin SAR measurement in U-NII-2A band by applying the OFDM SAR requirements. If the highest reported SAR for a test configuration is ≤ 1.2 W/kg, SAR is not required for U-NII-1 band for that configuration (802.11 mode and exposure condition).
- 2) When different maximum output power is specified for the bands, begin SAR measurement in the band with higher specified maximum output power. The highest reported SAR for the tested configuration is adjusted by the ratio of lower to higher specified maximum output power for the two bands. When the adjusted SAR is ≤ 1.2 W/kg, SAR is not required for the band with lower maximum output power in that test configuration.

SAR Test Report

<Considerations Related to Bluetooth for Setup and Testing>

This device has installed Bluetooth engineering testing software which can provide continuous transmitting RF signal. During Bluetooth SAR testing, this device was operated to transmit continuously at the maximum transmission duty with specified transmission mode, operating frequency, lowest data rate, and maximum output power.

The Bluetooth call box has been used during SAR measurement and the EUT was set to DH5 mode at the maximum output power. Its duty factor was calculated as below and the measured SAR for Bluetooth would be scaled to the 100% transmission duty factor to determine compliance.

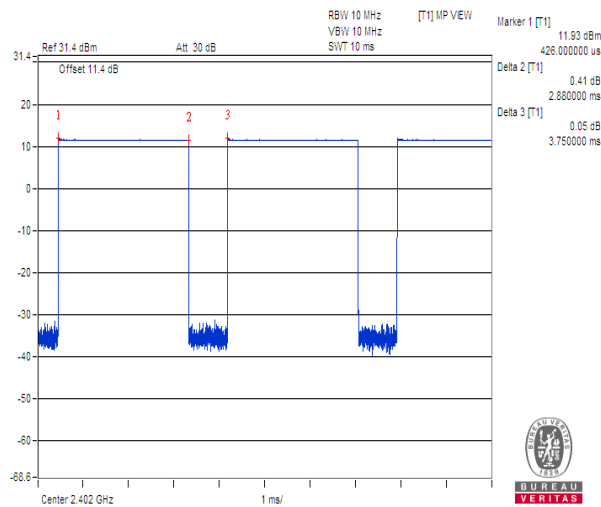

Time-domain plot for Bluetooth transmission signal

The duty factor of Bluetooth signal has been calculated as following.

$$\text{Duty Factor} = \text{Pulse Width} / \text{Total Period} = 2.88 / 3.75 = 76.80 \%$$

4.2 EUT Testing Position

According to KDB 648474 D04, handsets are tested for SAR compliance in head, body-worn accessory and other use configurations described in the following subsections.

4.2.1 Head Exposure Conditions

Head exposure is limited to next to the ear voice mode operations. Head SAR compliance is tested according to the test positions defined in IEEE Std 1528-2003 using the SAM phantom illustrated as below.

1. Define two imaginary lines on the handset
 - (a) The vertical centerline passes through two points on the front side of the handset - the midpoint of the width w_t of the handset at the level of the acoustic output, and the midpoint of the width w_b of the bottom of the handset.
 - (b) The horizontal line is perpendicular to the vertical centerline and passes through the center of the acoustic output. The horizontal line is also tangential to the face of the handset at point A.
 - (c) The two lines intersect at point A. Note that for many handsets, point A coincides with the center of the acoustic output; however, the acoustic output may be located elsewhere on the horizontal line. Also note that the vertical centerline is not necessarily parallel to the front face of the handset, especially for clamshell handsets, handsets with flip covers, and other irregularly shaped handsets.

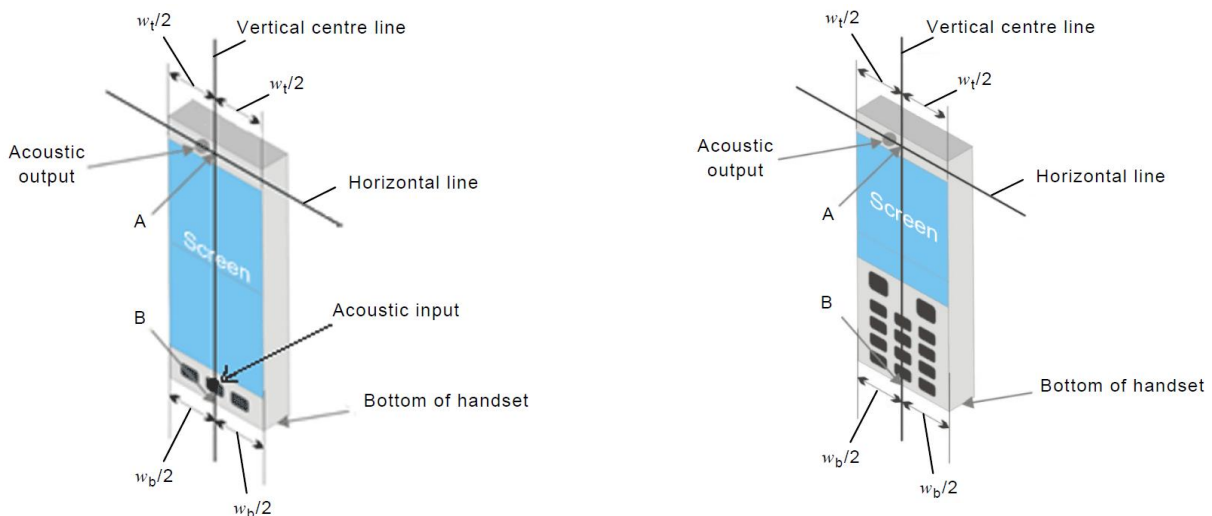

Fig-4.1 Illustration for Handset Vertical and Horizontal Reference Lines

2. Cheek Position

- (a) To position the device with the vertical center line of the body of the device and the horizontal line crossing the center piece in a plane parallel to the sagittal plane of the phantom. While maintaining the device in this plane, align the vertical center line with the reference plane containing the three ear and mouth reference point (M: Mouth, RE: Right Ear, and LE: Left Ear) and align the center of the ear piece with the line RE-LE.
- (b) To move the device towards the phantom with the ear piece aligned with the line LE-RE until the phone touched the ear. While maintaining the device in the reference plane and maintaining the phone contact with the ear, move the bottom of the phone until any point on the front side is in contact with the cheek of the phantom or until contact with the ear is lost (see Fig-4.2).

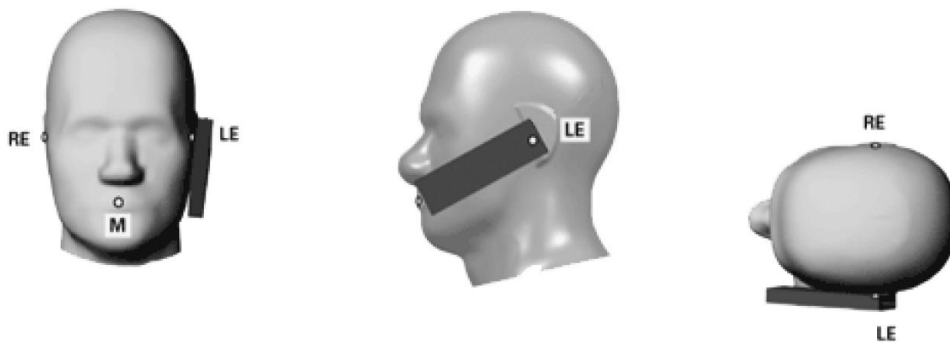

Fig-4.2 Illustration for Cheek Position

3. Tilted Position

- (a) To position the device in the “cheek” position described above.
- (b) While maintaining the device the reference plane described above and pivoting against the ear, moves it outward away from the mouth by an angle of 15 degrees or until contact with the ear is lost (see Fig-4.3).

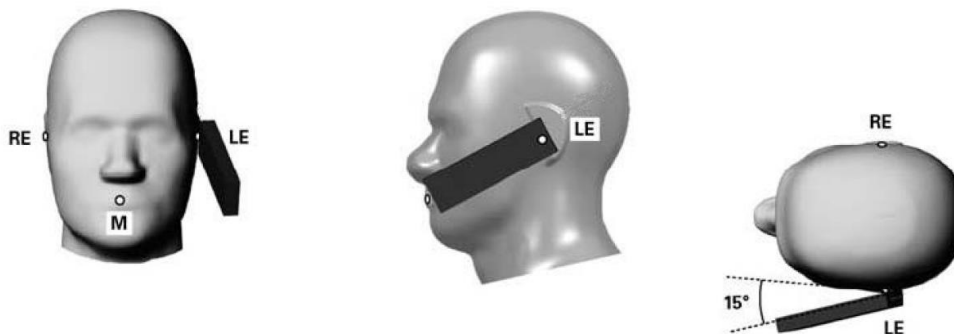

Fig-4.3 Illustration for Tilted Position

4.2.2 Body-worn Accessory Exposure Conditions

Body-worn accessory exposure is typically related to voice mode operations when handsets are carried in body-worn accessories. The body-worn accessory procedures in KDB 447498 D01 are used to test for body-worn accessory SAR compliance, without a headset connected to it. This enables the test results for such configuration to be compatible with that required for hotspot mode when the body-worn accessory test separation distance is greater than or equal to that required for hotspot mode. When the reported SAR for a body-worn accessory, measured without a headset connected to the handset, is $> 1.2 \text{ W/kg}$, the highest reported SAR configuration for that wireless mode and frequency band should be repeated for that body-worn accessory with a headset attached to the handset.

Body-worn accessories that do not contain metallic or conductive components may be tested according to worst-case exposure configurations, typically according to the smallest test separation distance required for the group of body-worn accessories with similar operating and exposure characteristics. All body-worn accessories containing metallic components are tested in conjunction with the host device.

Body-worn accessory SAR compliance is based on a single minimum test separation distance for all wireless and operating modes applicable to each body-worn accessory used by the host, and according to the relevant voice and/or data mode transmissions and operations. If a body-worn accessory supports voice only operations in its normal and expected use conditions, testing of data mode for body-worn compliance is not required.

A conservative minimum test separation distance for supporting off-the-shelf body-worn accessories that may be acquired by users of consumer handsets is used to test for body-worn accessory SAR compliance. This distance is determined by the handset manufacturer, according to the requirements of Supplement C 01-01. Devices that are designed to operate on the body of users using lanyards and straps, or without requiring additional body-worn accessories, will be tested using a conservative minimum test separation distance $\leq 5 \text{ mm}$ to support compliance.

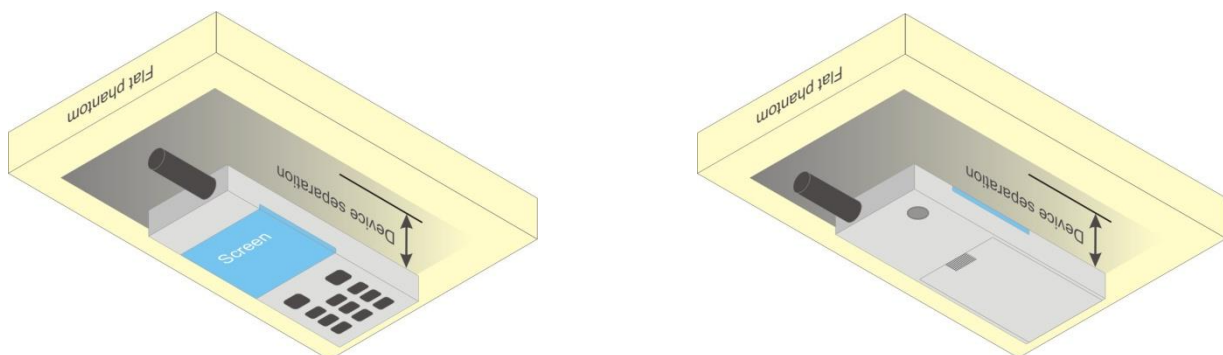
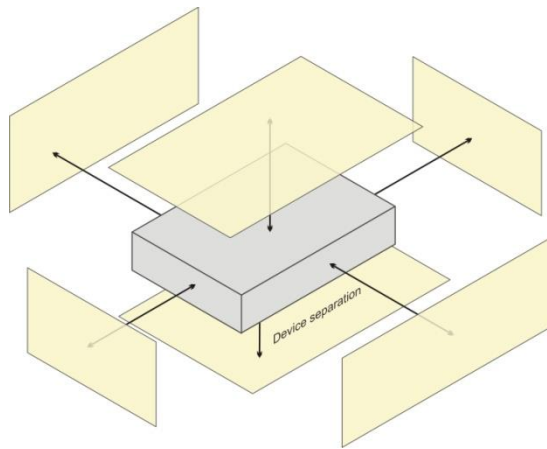

Fig-4.4 Illustration for Body Worn Position

4.2.3 Hotspot Mode Exposure Conditions

For handsets that support hotspot mode operations, with wireless router capabilities and various web browsing functions, the relevant hand and body exposure conditions are tested according to the hotspot SAR procedures in KDB 941225 D06. A test separation distance of 10 mm is required between the phantom and all surfaces and edges with a transmitting antenna located within 25 mm from that surface or edge. When the form factor of a handset is smaller than 9 cm x 5 cm, a test separation distance of 5 mm (instead of 10 mm) is required for testing hotspot mode. When the separation distance required for body-worn accessory testing is larger than or equal to that tested for hotspot mode, in the same wireless mode and for the same surface of the phone, the hotspot mode SAR data may be used to support body-worn accessory SAR compliance for that particular configuration (surface).



Based on the antenna location shown on appendix D of this report, the SAR testing required for hotspot mode is listed as below.

Antenna	Front Face	Rear Face	Left Side	Right Side	Top Side	Bottom Side
WWAN	V	V	V	V	-	V
WLAN / BT	V	V	-	V	V	-

4.2.4 Product Specific (Phablet) Exposure Conditions

For smart phones with a display diagonal dimension > 15 cm or an overall diagonal dimension > 16 cm that provide similar mobile web access and multimedia support found in mini-tablets or UMPC mini-tablets that support voice calls next to the ear, the following Phablet procedures should be applied to evaluate SAR compliance for each applicable wireless mode and frequency band. Devices marketed as Phablets, regardless of form factors and operating characteristics must be tested as a Phablet to determine SAR compliance.

1. The normally required head and body-worn accessory SAR test procedures for handsets, including hotspot mode, must be applied.
2. The UMPC mini-tablet procedures must also be applied to test the SAR of all surfaces and edges with an antenna located at ≤ 25 mm from that surface or edge, in direct contact with a flat phantom, for 10-g extremity SAR according to the body-equivalent tissue dielectric parameters in KDB 865664 to address interactive hand use exposure conditions. The UMPC mini-tablet 1-g SAR at 5 mm is not required. When hotspot mode applies, 10-g extremity SAR is required only for the surfaces and edges with hotspot mode 1-g SAR > 1.2 W/kg. The normal tablet procedures in KDB 616217 are required when the over diagonal dimension of the device is > 20 cm. Hotspot mode SAR is not required when normal tablet procedures are applied. Extremity 10-g SAR is also not required for the front (top) surface of large form factor full size tablets. The more conservative tablet SAR results can be used to support the 10-g extremity SAR for Phablet mode.
3. The simultaneous transmission operating configurations applicable to voice and data transmissions for both phone and mini-tablet modes must be taken into consideration separately for 1-g and 10-g SAR to determine the simultaneous transmission SAR test exclusion and measurement requirements for the relevant wireless mode and exposure conditions.

4.3 Tissue Verification

The measuring results for tissue simulating liquid are shown as below.

Head / Body-worn / Hotspot

Frequency (MHz)	Liquid Temp. (°C)	Measured Conductivity (σ)	Measured Permittivity (ϵ_r)	Target Conductivity (σ)	Target Permittivity (ϵ_r)	Conductivity Deviation (%)	Permittivity Deviation (%)	Test Date
750	23.5	0.896	42.622	0.89	41.9	0.67	1.72	Jun. 14, 2020
750	23.5	0.903	42.293	0.89	41.9	1.46	0.94	Jul. 07, 2020
750	23.5	0.886	43.438	0.89	41.9	-0.45	3.67	Aug. 09, 2020
835	23.5	0.914	43.02	0.9	41.5	1.56	3.66	Jun. 13, 2020
835	23.5	0.912	40.451	0.9	41.5	1.33	-2.53	Jul. 08, 2020
835	23.3	0.905	42.447	0.9	41.5	0.56	2.28	Aug. 08, 2020
1750	23.1	1.325	39.349	1.37	40.1	-3.28	-1.87	Jun. 16, 2020
1750	23.5	1.325	38.809	1.37	40.1	-3.28	-3.22	Jul. 07, 2020
1750	23.3	1.324	39.865	1.37	40.1	-3.36	-0.59	Aug. 09, 2020
1750	23.1	1.32	39.741	1.37	40.1	-3.65	-0.90	Aug. 21, 2020
1900	23.5	1.46	38.175	1.4	40	4.29	-4.56	Jul. 07, 2020
1900	23.3	1.462	39.247	1.4	40	4.43	-1.88	Jul. 16, 2020
1900	23.3	1.451	39.352	1.4	40	3.64	-1.62	Aug. 08, 2020
1900	23.1	1.447	39.229	1.4	40	3.36	-1.93	Aug. 20, 2020
2450	23.1	1.878	39.394	1.8	39.2	4.33	0.49	Jul. 21, 2020
2450	23.2	1.862	38.539	1.8	39.2	3.44	-1.69	Sep. 08, 2020
2450	23.1	1.878	38.844	1.8	39.2	4.33	-0.91	Sep. 09, 2020
2600	23.5	2.049	37.692	1.96	39	4.54	-3.35	Jun. 13, 2020
2600	23.5	2.042	37.776	1.96	39	4.18	-3.14	Jul. 07, 2020
2600	23.5	2.008	37.939	1.96	39	2.45	-2.72	Aug. 09, 2020
2600	23.1	2.056	37.803	1.96	39	4.90	-3.07	Aug. 21, 2020
5250	23.1	4.713	36.255	4.71	35.9	0.06	0.99	Jul. 20, 2020
5250	23.2	4.78	35.347	4.71	35.9	1.49	-1.54	Sep. 08, 2020
5600	23.1	5.139	35.632	5.07	35.5	1.36	0.37	Jul. 20, 2020
5750	23.1	5.313	35.352	5.22	35.4	1.78	-0.14	Jul. 20, 2020

Product Specific (Phablet)

Frequency (MHz)	Liquid Temp. (°C)	Measured Conductivity (σ)	Measured Permittivity (ϵ_r)	Target Conductivity (σ)	Target Permittivity (ϵ_r)	Conductivity Deviation (%)	Permittivity Deviation (%)	Test Date
1750	23.1	1.325	39.349	1.37	40.1	-3.28	-1.87	Jun. 16, 2020
1900	23.1	1.46	38.759	1.4	40	4.29	-3.10	Jun. 16, 2020
1900	23.1	1.447	39.229	1.4	40	3.36	-1.93	Aug. 20, 2020
2450	23.1	1.878	38.844	1.8	39.2	4.33	-0.91	Sep. 09, 2020
2600	23.4	1.984	38.033	1.96	39	1.22	-2.48	Sep. 03, 2020
2600	23.2	2.036	37.736	1.96	39	3.88	-3.24	Sep. 08, 2020
5250	23.1	4.623	37.419	4.71	35.9	-1.85	4.23	Sep. 09, 2020
5600	23.1	4.986	36.942	5.07	35.5	-1.66	4.06	Sep. 09, 2020

Note:

The dielectric properties of the tissue simulating liquid have been measured within 24 hours before the SAR testing and within $\pm 10\%$ of the target values. Liquid temperature during the SAR testing has kept within $\pm 2^\circ\text{C}$.

SAR Test Report

4.4 System Validation

The SAR measurement system was validated according to procedures in KDB 865664 D01. The validation status in tabulated summary is as below.

Head / Body-worn / Hotspot

Test Date	Probe S/N	Calibration Point	Measured Conductivity (σ)	Measured Permittivity (ϵ_r)	Validation for CW			Validation for Modulation		
					Sensitivity Range	Probe Linearity	Probe Isotropy	Modulation Type	Duty Factor	PAR
Jun. 14, 2020	3650	750	0.896	42.622	Pass	Pass	Pass	N/A	N/A	N/A
Jul. 07, 2020	7472	750	0.903	42.293	Pass	Pass	Pass	N/A	N/A	N/A
Aug. 09, 2020	3650	750	0.886	43.438	Pass	Pass	Pass	N/A	N/A	N/A
Jun. 13, 2020	3650	835	0.914	43.02	Pass	Pass	Pass	GMSK	Pass	N/A
Jul. 08, 2020	7472	835	0.912	40.451	Pass	Pass	Pass	GMSK	Pass	N/A
Aug. 08, 2020	3650	835	0.905	42.447	Pass	Pass	Pass	GMSK	Pass	N/A
Jun. 16, 2020	7472	1750	1.325	39.349	Pass	Pass	Pass	N/A	N/A	N/A
Jul. 07, 2020	7472	1750	1.325	38.809	Pass	Pass	Pass	N/A	N/A	N/A
Aug. 09, 2020	3650	1750	1.324	39.865	Pass	Pass	Pass	N/A	N/A	N/A
Aug. 21, 2020	3820	1750	1.32	39.741	Pass	Pass	Pass	N/A	N/A	N/A
Jul. 07, 2020	7472	1900	1.46	38.175	Pass	Pass	Pass	GMSK	Pass	N/A
Jul. 16, 2020	7472	1900	1.462	39.247	Pass	Pass	Pass	GMSK	Pass	N/A
Aug. 08, 2020	3650	1900	1.451	39.352	Pass	Pass	Pass	GMSK	Pass	N/A
Aug. 20, 2020	3820	1900	1.447	39.229	Pass	Pass	Pass	GMSK	Pass	N/A
Jul. 21, 2020	7537	2450	1.878	39.394	Pass	Pass	Pass	OFDM	N/A	Pass
Sep. 08, 2020	3971	2450	1.862	38.539	Pass	Pass	Pass	OFDM	N/A	Pass
Sep. 09, 2020	7472	2450	1.878	38.844	Pass	Pass	Pass	OFDM	N/A	Pass
Jun. 13, 2020	3650	2600	2.049	37.692	Pass	Pass	Pass	N/A	N/A	N/A
Jul. 07, 2020	7472	2600	2.042	37.776	Pass	Pass	Pass	N/A	N/A	N/A
Aug. 09, 2020	3650	2600	2.008	37.939	Pass	Pass	Pass	N/A	N/A	N/A
Aug. 21, 2020	3820	2600	2.056	37.803	Pass	Pass	Pass	N/A	N/A	N/A
Jul. 20, 2020	7472	5250	4.713	36.255	Pass	Pass	Pass	OFDM	N/A	Pass
Sep. 08, 2020	3971	5250	4.78	35.347	Pass	Pass	Pass	OFDM	N/A	Pass
Jul. 20, 2020	7472	5600	5.139	35.632	Pass	Pass	Pass	OFDM	N/A	Pass
Jul. 20, 2020	7472	5750	5.313	35.352	Pass	Pass	Pass	OFDM	N/A	Pass

Product Specific (Phablet)

Test Date	Probe S/N	Calibration Point	Measured Conductivity (σ)	Measured Permittivity (ϵ_r)	Validation for CW			Validation for Modulation		
					Sensitivity Range	Probe Linearity	Probe Isotropy	Modulation Type	Duty Factor	PAR
Jun. 16, 2020	7472	1750	1.325	39.349	Pass	Pass	Pass	N/A	N/A	N/A
Jun. 16, 2020	7472	1900	1.46	38.759	Pass	Pass	Pass	GMSK	Pass	N/A
Aug. 20, 2020	3820	1900	1.447	39.229	Pass	Pass	Pass	GMSK	Pass	N/A
Sep. 09, 2020	7472	2450	1.878	38.844	Pass	Pass	Pass	OFDM	N/A	Pass
Sep. 03, 2020	3971	2600	1.984	38.033	Pass	Pass	Pass	N/A	N/A	N/A
Sep. 08, 2020	3971	2600	2.036	37.736	Pass	Pass	Pass	N/A	N/A	N/A
Sep. 09, 2020	7472	5250	4.623	37.419	Pass	Pass	Pass	OFDM	N/A	Pass
Sep. 09, 2020	7472	5600	4.986	36.942	Pass	Pass	Pass	OFDM	N/A	Pass

SAR Test Report

4.5 System Verification

The measuring result for system verification is tabulated as below.

Head / Body-worn / Hotspot

Test Date	Frequency (MHz)	1W Target SAR-1g (W/kg)	Measured SAR-1g (W/kg)	Normalized to 1W SAR-1g (W/kg)	Deviation (%)	Dipole S/N	Probe S/N	DAE S/N
Jun. 14, 2020	750	8.56	0.46	9.20	7.48	1013	3650	861
Jul. 07, 2020	750	8.56	0.393	7.86	-8.18	1013	7472	579
Aug. 09, 2020	750	8.56	0.411	8.22	-3.97	1013	3650	861
Jun. 13, 2020	835	9.61	0.463	9.26	-3.64	4d121	3650	861
Jul. 08, 2020	835	9.61	0.47	9.40	-2.19	4d121	7472	579
Aug. 08, 2020	835	9.61	0.476	9.52	-0.94	4d121	3650	861
Jun. 16, 2020	1750	37.00	1.89	37.80	2.16	1055	7472	579
Jul. 07, 2020	1750	37.00	1.77	35.40	-4.32	1055	7472	579
Aug. 09, 2020	1750	35.50	1.8	36.00	1.41	1111	3650	861
Aug. 21, 2020	1750	35.50	1.85	37.00	4.23	1111	3820	393
Jul. 07, 2020	1900	40.30	1.94	38.80	-3.72	5d036	7472	579
Jul. 16, 2020	1900	40.30	1.97	39.40	-2.23	5d036	7472	579
Aug. 08, 2020	1900	40.30	1.95	39.00	-3.23	5d036	3650	861
Aug. 20, 2020	1900	40.30	1.96	39.20	-2.73	5d036	3820	393
Jul. 21, 2020	2450	52.70	2.52	50.40	-4.36	737	7537	1585
Sep. 08, 2020	2450	51.10	2.54	50.80	-0.59	903	3971	917
Sep. 09, 2020	2450	51.10	2.61	52.20	2.15	903	7472	579
Jun. 13, 2020	2600	57.30	2.97	59.40	3.66	1020	3650	861
Jul. 07, 2020	2600	57.30	2.67	53.40	-6.81	1020	7472	579
Aug. 09, 2020	2600	55.90	2.78	55.60	-0.54	1077	3650	861
Aug. 21, 2020	2600	55.90	2.76	55.20	-1.25	1077	3820	393
Jul. 20, 2020	5250	79.70	3.72	74.40	-6.65	1019	7472	579
Sep. 08, 2020	5250	79.70	4.07	81.40	2.13	1019	3971	917
Jul. 20, 2020	5600	83.80	3.85	77.00	-8.11	1019	7472	579
Jul. 20, 2020	5750	80.40	3.71	74.20	-7.71	1019	7472	579

Product Specific (Phablet)

Test Date	Frequency (MHz)	1W Target SAR-1g (W/kg)	Measured SAR-1g (W/kg)	Normalized to 1W SAR-1g (W/kg)	Deviation (%)	Dipole S/N	Probe S/N	DAE S/N
Jun. 16, 2020	1750	19.50	1.03	20.60	5.64	1055	7472	579
Jun. 16, 2020	1900	20.90	1.12	22.40	7.18	5d036	7472	579
Aug. 20, 2020	1900	20.90	1.09	21.80	4.31	5d036	3820	393
Sep. 09, 2020	2450	23.40	1.24	24.80	5.98	903	7472	579
Sep. 03, 2020	2600	24.50	1.22	24.40	-0.41	1077	3971	1277
Sep. 08, 2020	2600	24.50	1.27	25.40	3.67	1077	3971	917
Sep. 09, 2020	5250	22.80	1.11	22.20	-2.63	1019	7472	579
Sep. 09, 2020	5600	23.70	1.19	23.80	0.42	1019	7472	579

Note:

Comparing to the reference SAR value provided by SPEAG in dipole calibration certificate, the deviation of system check results is within its specification of 10 %. The result indicates the system check can meet the variation criterion and the plots please refer to Appendix A of this report.

4.6 Maximum Output Power

4.6.1 Maximum Target Conducted Power

Refer to Appendix E.

4.6.2 Measured Conducted Power Result

Refer to Appendix F.

4.7 SAR Testing Results

4.7.1 SAR Test Reduction Considerations

<KDB 447498 D01, General RF Exposure Guidance>

Testing of other required channels within the operating mode of a frequency band is not required when the reported SAR for the mid-band or highest output power channel is:

- (1) ≤ 0.8 W/kg or 2.0 W/kg, for 1-g or 10-g respectively, when the transmission band is ≤ 100 MHz
- (2) ≤ 0.6 W/kg or 1.5 W/kg, for 1-g or 10-g respectively, when the transmission band is between 100 MHz and 200 MHz
- (3) ≤ 0.4 W/kg or 1.0 W/kg, for 1-g or 10-g respectively, when the transmission band is ≥ 200 MHz

When SAR is not measured at the maximum power level allowed for production units, the measured SAR will be scaled to the maximum tune-up tolerance limit to determine compliance. The scaling factor for the tune-up power is defined as maximum tune-up limit (mW) / measured conducted power (mW). The reported SAR would be calculated by measured SAR x tune-up power scaling factor.

The SAR has been measured with highest transmission duty factor supported by the test mode tools for WLAN and/or Bluetooth. When the transmission duty factor could not achieve 100%, the reported SAR will be scaled to 100% transmission duty factor to determine compliance at the maximum tune-up power. The scaling factor for the duty factor is defined as 100% / transmission duty cycle (%). The reported SAR would be calculated by measured SAR x tune-up power scaling factor x duty cycle scaling factor.

<KDB 941225 D01, 3G SAR Measurement Procedures>

The mode tested for SAR is referred to as the primary mode. The equivalent modes considered for SAR test reduction are denoted as secondary modes. Both primary and secondary modes must be in the same frequency band. When the maximum output power and tune-up tolerance specified for production units in a secondary mode is $\leq 1/4$ dB higher than the primary mode or when the highest reported SAR of the primary mode is scaled by the ratio of specified maximum output power and tune-up tolerance of secondary to primary mode and the adjusted SAR is ≤ 1.2 W/kg, SAR measurement is not required for the secondary mode.

<KDB 941225 D05, SAR Evaluation Considerations for LTE Devices>

- (1) QPSK with 1 RB and 50% RB allocation

Start with the largest channel bandwidth and measure SAR, using the RB offset and required test channel combination with the highest maximum output power among RB offsets at the upper edge, middle and lower edge of each required test channel. When the reported SAR is ≤ 0.8 W/kg, testing of the remaining RB offset configurations and required test channels is not required; otherwise, SAR is required for the remaining required test channels and only for the RB offset configuration with the highest output power for that channel. When the reported SAR of a required test channel is > 1.45 W/kg, SAR is required for all three RB offset configurations for that required test channel.

SAR Test Report

(2) QPSK with 100% RB allocation

SAR is not required when the highest maximum output power for 100% RB allocation is less than the highest maximum output power in 50% and 1 RB allocations and the highest reported SAR for 1 RB and 50% RB allocation are ≤ 0.8 W/kg. Otherwise, SAR is measured for the highest output power channel; and if the reported SAR is > 1.45 W/kg, the remaining required test channels must also be tested.

(3) Higher order modulations

SAR is required only when the highest maximum output power for the configuration in the higher order modulation is $>1/2$ dB higher than the same configuration in QPSK or when the reported SAR for the QPSK configuration is > 1.45 W/kg.

(4) Other channel bandwidth

SAR is required when the highest maximum output power of the smaller channel bandwidth is $>1/2$ dB higher than the equivalent channel configurations in the largest channel bandwidth configuration or the reported SAR of a configuration for the largest channel bandwidth is > 1.45 W/kg.

<KDB 248227 D01, SAR Guidance for Wi-Fi Transmitters>

- (1) For handsets operating next to ear, hotspot mode or mini-tablet configurations, the initial test position procedures were applied. The test position with the highest extrapolated peak SAR will be used as the initial test position. When the reported SAR of initial test position is ≤ 0.4 W/kg, SAR testing for remaining test positions is not required. Otherwise, SAR is evaluated at the subsequent highest peak SAR positions until the reported SAR result is ≤ 0.8 W/kg or all test positions are measured.
- (2) For WLAN 2.4 GHz, the highest measured maximum output power channel for DSSS was selected for SAR measurement. When the reported SAR is ≤ 0.8 W/kg, no further SAR testing is required. Otherwise, SAR is evaluated at the next highest measured output power channel. When any reported SAR is >1.2 W/kg, SAR is required for the third channel. For OFDM modes (802.11g/n), SAR is not required when the highest reported SAR for DSSS is adjusted by the ratio of OFDM to DSSS specified maximum output power and it is ≤ 1.2 W/kg.
- (3) For WLAN 5GHz, the initial test configuration was selected according to the transmission mode with the highest maximum output power. When the reported SAR of initial test configuration is > 0.8 W/kg, SAR is required for the subsequent highest measured output power channel until the reported SAR result is ≤ 1.2 W/kg or all required channels are measured. For other transmission modes, SAR is not required when the highest reported SAR for initial test configuration is adjusted by the ratio of subsequent test configuration to initial test configuration specified maximum output power and it is ≤ 1.2 W/kg.

SAR Test Report

4.7.2 SAR Results for Head Exposure Condition

Plot No.	Band	Mode	Test Position	Ch.	Max. Tune-up Power (dBm)	Measured Conducted Power (dBm)	Scaling Factor	Power Drift (dB)	Measured SAR-1g (W/kg)	Scaled SAR-1g (W/kg)
01	GSM850	GPRS12	Right Cheek	189	27.50	27.15	1.08	-0.06	0.351	0.38
	GSM850	GPRS12	Right Tilted	189	27.50	27.15	1.08	0.03	0.219	0.24
	GSM850	GPRS12	Left Cheek	189	27.50	27.15	1.08	-0.15	0.259	0.28
	GSM850	GPRS12	Left Tilted	189	27.50	27.15	1.08	0.07	0.212	0.23
	GSM850	GPRS12	Right Cheek	128	27.50	27.11	1.09	-0.03	0.325	0.35
	GSM850	GPRS12	Right Cheek	251	27.50	27.12	1.09	0.01	0.339	0.37
	GSM1900	EDGE12	Right Cheek	512	26.50	25.60	1.23	0.05	0.376	0.46
	GSM1900	EDGE12	Right Tilted	512	26.50	25.60	1.23	0.09	0.199	0.24
02	GSM1900	EDGE12	Left Cheek	512	26.50	25.60	1.23	0.02	0.788	0.97
	GSM1900	EDGE12	Left Tilted	512	26.50	25.60	1.23	-0.02	0.223	0.27
	GSM1900	EDGE12	Left Cheek	661	26.50	25.55	1.24	-0.07	0.672	0.83
	GSM1900	EDGE12	Left Cheek	810	26.50	25.42	1.28	0.03	0.482	0.62
03	WCDMA II	RMC12.2K	Right Cheek	9262	24.00	23.95	1.01	-0.06	0.503	0.51
	WCDMA II	RMC12.2K	Right Tilted	9262	24.00	23.95	1.01	0.01	0.31	0.31
	WCDMA II	RMC12.2K	Left Cheek	9262	24.00	23.95	1.01	-0.03	1.17	1.18
	WCDMA II	RMC12.2K	Left Tilted	9262	24.00	23.95	1.01	0.13	0.326	0.33
	WCDMA II	RMC12.2K	Left Cheek	9400	24.00	23.79	1.05	-0.05	0.923	0.97
	WCDMA II	RMC12.2K	Left Cheek	9538	24.00	23.91	1.02	0.02	0.808	0.82
	WCDMA II	RMC12.2K	Left Cheek	9262	24.00	23.95	1.01	-0.03	1.14	1.15
	WCDMA IV	RMC12.2K	Right Cheek	1312	24.50	24.47	1.01	0.11	0.345	0.35
	WCDMA IV	RMC12.2K	Right Tilted	1312	24.50	24.47	1.01	-0.01	0.261	0.26
	WCDMA IV	RMC12.2K	Left Cheek	1312	24.50	24.47	1.01	-0.06	0.701	0.71
	WCDMA IV	RMC12.2K	Left Tilted	1312	24.50	24.47	1.01	0.03	0.243	0.25
	04	WCDMA IV	RMC12.2K	Left Cheek	1413	24.50	24.22	1.07	0.01	0.806
WCDMA IV		RMC12.2K	Left Cheek	1513	24.50	24.41	1.02	-0.01	0.943	0.96
WCDMA IV		RMC12.2K	Left Cheek	1513	24.50	24.41	1.02	-0.16	0.921	0.94
05	WCDMA V	RMC12.2K	Right Cheek	4233	24.50	24.16	1.08	-0.03	0.482	0.52
	WCDMA V	RMC12.2K	Right Tilted	4233	24.50	24.16	1.08	0.05	0.298	0.32
	WCDMA V	RMC12.2K	Left Cheek	4233	24.50	24.16	1.08	-0.12	0.368	0.40
	WCDMA V	RMC12.2K	Left Tilted	4233	24.50	24.16	1.08	0.05	0.296	0.32
	WCDMA V	RMC12.2K	Right Cheek	4132	24.50	24.13	1.09	-0.08	0.427	0.47
	WCDMA V	RMC12.2K	Right Cheek	4182	24.50	24.03	1.11	0.02	0.465	0.52

SAR Test Report

Plot No.	Band	Mode	Test Position	Ch.	RB	offset	Max. Tune-up Power (dBm)	Measured Conducted Power (dBm)	Scaling Factor	Power Drift (dB)	Measured SAR-1g (W/kg)	Scaled SAR-1g (W/kg)
	LTE 2	QPSK20M	Right Cheek	18700	1	0	23.50	23.15	1.08	0.11	0.381	0.41
	LTE 2	QPSK20M	Right Tilted	18700	1	0	23.50	23.15	1.08	-0.03	0.243	0.26
06	LTE 2	QPSK20M	Left Cheek	18700	1	0	23.50	23.15	1.08	-0.06	0.985	1.06
	LTE 2	QPSK20M	Left Tilted	18700	1	0	23.50	23.15	1.08	0.12	0.287	0.31
	LTE 2	QPSK20M	Right Cheek	18700	50	0	22.50	22.11	1.09	0.05	0.306	0.33
	LTE 2	QPSK20M	Right Tilted	18700	50	0	22.50	22.11	1.09	-0.01	0.192	0.21
	LTE 2	QPSK20M	Left Cheek	18700	50	0	22.50	22.11	1.09	-0.03	0.821	0.89
	LTE 2	QPSK20M	Left Tilted	18700	50	0	22.50	22.11	1.09	0.07	0.219	0.24
	LTE 2	QPSK20M	Left Cheek	18700	100	0	22.50	22.05	1.11	0.02	0.733	0.81
	LTE 2	QPSK20M	Left Cheek	18900	1	0	23.50	22.98	1.13	-0.06	0.875	0.99
	LTE 2	QPSK20M	Left Cheek	19100	1	0	23.50	22.91	1.15	-0.14	0.796	0.92
	LTE 2	QPSK20M	Left Cheek	18900	50	0	22.50	22.03	1.11	0.05	0.692	0.77
	LTE 2	QPSK20M	Left Cheek	19100	50	0	22.50	21.98	1.13	-0.08	0.628	0.71
	LTE 2	QPSK20M	Left Cheek	18700	1	0	23.50	23.15	1.08	0.13	0.971	1.05
	LTE 4	QPSK20M	Right Cheek	20050	1	0	23.50	22.73	1.19	0.03	0.254	0.30
	LTE 4	QPSK20M	Right Tilted	20050	1	0	23.50	22.73	1.19	-0.06	0.162	0.19
	LTE 4	QPSK20M	Left Cheek	20050	1	0	23.50	22.73	1.19	0.12	0.568	0.68
	LTE 4	QPSK20M	Left Tilted	20050	1	0	23.50	22.73	1.19	0.05	0.207	0.25
	LTE 4	QPSK20M	Right Cheek	20050	50	0	22.50	21.80	1.17	-0.07	0.206	0.24
	LTE 4	QPSK20M	Right Tilted	20050	50	0	22.50	21.80	1.17	0.09	0.133	0.16
	LTE 4	QPSK20M	Left Cheek	20050	50	0	22.50	21.80	1.17	-0.01	0.473	0.55
	LTE 4	QPSK20M	Left Tilted	20050	50	0	22.50	21.80	1.17	-0.03	0.174	0.20
	LTE 4	QPSK20M	Left Cheek	20050	100	0	22.50	21.69	1.21	-0.01	0.455	0.55
	LTE 4	QPSK20M	Left Cheek	20175	1	0	23.50	22.66	1.21	0.08	0.637	0.77
07	LTE 4	QPSK20M	Left Cheek	20300	1	0	23.50	22.71	1.20	-0.04	0.705	0.85
	LTE 5	QPSK10M	Right Cheek	20525	1	0	23.50	23.09	1.10	0.11	0.333	0.37
	LTE 5	QPSK10M	Right Tilted	20525	1	0	23.50	23.09	1.10	-0.05	0.177	0.19
	LTE 5	QPSK10M	Left Cheek	20525	1	0	23.50	23.09	1.10	-0.01	0.241	0.27
	LTE 5	QPSK10M	Left Tilted	20525	1	0	23.50	23.09	1.10	-0.07	0.189	0.21
	LTE 5	QPSK10M	Right Cheek	20525	25	0	22.50	22.08	1.10	0.03	0.268	0.29
	LTE 5	QPSK10M	Right Tilted	20525	25	0	22.50	22.08	1.10	-0.01	0.139	0.15
	LTE 5	QPSK10M	Left Cheek	20525	25	0	22.50	22.08	1.10	0.09	0.194	0.21
	LTE 5	QPSK10M	Left Tilted	20525	25	0	22.50	22.08	1.10	0.12	0.145	0.16
	LTE 5	QPSK10M	Right Cheek	20450	1	0	23.50	23.03	1.11	0.05	0.323	0.36
08	LTE 5	QPSK10M	Right Cheek	20600	1	0	23.50	22.87	1.16	-0.01	0.351	0.41
	LTE 7	QPSK20M	Right Cheek	21100	1	0	22.50	22.49	1.00	0.05	0.342	0.34
	LTE 7	QPSK20M	Right Tilted	21100	1	0	22.50	22.49	1.00	-0.01	0.213	0.21
	LTE 7	QPSK20M	Left Cheek	21100	1	0	22.50	22.49	1.00	0.03	0.805	0.81
	LTE 7	QPSK20M	Left Tilted	21100	1	0	22.50	22.49	1.00	0.07	0.146	0.15
	LTE 7	QPSK20M	Right Cheek	21100	50	0	21.50	21.50	1.00	0.12	0.293	0.29
	LTE 7	QPSK20M	Right Tilted	21100	50	0	21.50	21.50	1.00	-0.06	0.178	0.18
	LTE 7	QPSK20M	Left Cheek	21100	50	0	21.50	21.50	1.00	-0.05	0.735	0.74
	LTE 7	QPSK20M	Left Tilted	21100	50	0	21.50	21.50	1.00	0.03	0.117	0.12
	LTE 7	QPSK20M	Left Cheek	21100	100	0	21.50	21.45	1.01	0.01	0.668	0.67
09	LTE 7	QPSK20M	Left Cheek	20850	1	0	22.50	22.41	1.02	0.01	0.896	0.91
	LTE 7	QPSK20M	Left Cheek	21350	1	0	22.50	22.36	1.03	-0.05	0.879	0.91
	LTE 7	QPSK20M	Left Cheek	20850	1	0	22.50	22.41	1.02	-0.03	0.885	0.90

SAR Test Report

Plot No.	Band	Mode	Test Position	Ch.	RB	offset	Max. Tune-up Power (dBm)	Measured Conducted Power (dBm)	Scaling Factor	Power Drift (dB)	Measured SAR-1g (W/kg)	Scaled SAR-1g (W/kg)
10	LTE 17	QPSK10M	Right Cheek	23790	1	0	23.50	22.64	1.22	-0.03	0.173	0.21
	LTE 17	QPSK10M	Right Tilted	23790	1	0	23.50	22.64	1.22	0.02	0.092	0.11
	LTE 17	QPSK10M	Left Cheek	23790	1	0	23.50	22.64	1.22	-0.06	0.136	0.17
	LTE 17	QPSK10M	Left Tilted	23790	1	0	23.50	22.64	1.22	0.13	0.117	0.14
	LTE 17	QPSK10M	Right Cheek	23790	25	0	22.50	21.69	1.21	0.08	0.143	0.17
	LTE 17	QPSK10M	Right Tilted	23790	25	0	22.50	21.69	1.21	-0.03	0.066	0.08
	LTE 17	QPSK10M	Left Cheek	23790	25	0	22.50	21.69	1.21	-0.06	0.116	0.14
	LTE 17	QPSK10M	Left Tilted	23790	25	0	22.50	21.69	1.21	0.11	0.095	0.11
	LTE 17	QPSK10M	Right Cheek	23780	1	0	23.50	22.57	1.24	0.07	0.166	0.21
	LTE 17	QPSK10M	Right Cheek	23800	1	0	23.50	22.61	1.23	-0.02	0.163	0.20
	LTE 26	QPSK15M	Right Cheek	26865	1	0	23.50	23.15	1.08	0.09	0.348	0.38
	LTE 26	QPSK15M	Right Tilted	26865	1	0	23.50	23.15	1.08	0.01	0.193	0.21
	LTE 26	QPSK15M	Left Cheek	26865	1	0	23.50	23.15	1.08	-0.07	0.273	0.29
	LTE 26	QPSK15M	Left Tilted	26865	1	0	23.50	23.15	1.08	-0.03	0.212	0.23
	LTE 26	QPSK15M	Right Cheek	26865	36	0	22.50	22.06	1.11	0.12	0.289	0.32
	LTE 26	QPSK15M	Right Tilted	26865	36	0	22.50	22.06	1.11	0.05	0.153	0.17
	LTE 26	QPSK15M	Left Cheek	26865	36	0	22.50	22.06	1.11	-0.08	0.219	0.24
	LTE 26	QPSK15M	Left Tilted	26865	36	0	22.50	22.06	1.11	0.03	0.166	0.18
	LTE 26	QPSK15M	Right Cheek	26765	1	0	23.50	23.02	1.12	-0.01	0.321	0.36
11	LTE 26	QPSK15M	Right Cheek	26965	1	0	23.50	23.01	1.12	-0.03	0.361	0.40
	LTE 38	QPSK20M	Right Cheek	38150	1	0	23.00	22.85	1.04	0.08	0.232	0.24
	LTE 38	QPSK20M	Right Tilted	38150	1	0	23.00	22.85	1.04	-0.03	0.151	0.16
	LTE 38	QPSK20M	Left Cheek	38150	1	0	23.00	22.85	1.04	0.11	0.605	0.63
	LTE 38	QPSK20M	Left Tilted	38150	1	0	23.00	22.85	1.04	0.05	0.109	0.11
	LTE 38	QPSK20M	Right Cheek	38150	50	0	22.00	21.85	1.04	-0.07	0.192	0.20
	LTE 38	QPSK20M	Right Tilted	38150	50	0	22.00	21.85	1.04	0.03	0.123	0.13
	LTE 38	QPSK20M	Left Cheek	38150	50	0	22.00	21.85	1.04	-0.01	0.577	0.60
	LTE 38	QPSK20M	Left Tilted	38150	50	0	22.00	21.85	1.04	0.05	0.085	0.09
	LTE 38	QPSK20M	Left Cheek	37850	1	0	23.00	22.73	1.06	0.07	0.588	0.62
12	LTE 38	QPSK20M	Left Cheek	38000	1	0	23.00	22.78	1.05	-0.04	0.614	0.64
	LTE 41	QPSK20M	Right Cheek	41490	1	0	23.00	22.50	1.12	0.12	0.217	0.24
	LTE 41	QPSK20M	Right Tilted	41490	1	0	23.00	22.50	1.12	-0.09	0.173	0.19
	LTE 41	QPSK20M	Left Cheek	41490	1	0	23.00	22.50	1.12	0.03	0.591	0.66
	LTE 41	QPSK20M	Left Tilted	41490	1	0	23.00	22.50	1.12	-0.01	0.108	0.12
	LTE 41	QPSK20M	Right Cheek	41490	50	0	22.00	21.50	1.12	0.06	0.171	0.19
	LTE 41	QPSK20M	Right Tilted	41490	50	0	22.00	21.50	1.12	-0.05	0.126	0.14
	LTE 41	QPSK20M	Left Cheek	41490	50	0	22.00	21.50	1.12	-0.01	0.458	0.51
	LTE 41	QPSK20M	Left Tilted	41490	50	0	22.00	21.50	1.12	0.07	0.084	0.09
	LTE 41	QPSK20M	Left Cheek	39750	1	0	23.00	22.08	1.24	0.05	0.581	0.72
	LTE 41	QPSK20M	Left Cheek	40185	1	0	23.00	22.41	1.15	-0.06	0.619	0.71
	LTE 41	QPSK20M	Left Cheek	40620	1	0	23.00	22.44	1.14	-0.12	0.637	0.73
13	LTE 41	QPSK20M	Left Cheek	41055	1	0	23.00	22.47	1.13	-0.01	0.680	0.77

SAR Test Report

Plot No.	Band	Mode	Test Position	Ch.	Duty Cycle	Crest Factor	Max. Tune-up Power (dBm)	Measured Conducted Power (dBm)	Scaling Factor	Power Drift (dB)	Measured SAR-1g (W/kg)	Scaled SAR-1g (W/kg)
	WLAN2.4G	802.11b	Right Cheek	1	99.00	1.01	18.00	17.98	1.00	-0.12	0.125	0.13
	WLAN2.4G	802.11b	Right Tilted	1	99.00	1.01	18.00	17.98	1.00	0.03	0.076	0.08
	WLAN2.4G	802.11b	Left Cheek	1	99.00	1.01	18.00	17.98	1.00	0.07	0.536	0.54
	WLAN2.4G	802.11b	Left Tilted	1	99.00	1.01	18.00	17.98	1.00	-0.05	0.248	0.25
14	WLAN2.4G	802.11b	Left Cheek	6	99.00	1.01	18.00	17.70	1.07	-0.03	0.547	0.59
	WLAN2.4G	802.11b	Left Cheek	11	99.00	1.01	18.00	17.91	1.02	0.12	0.539	0.56
	WLAN5.3G	802.11ac VHT80	Right Cheek	58	82.23	1.22	19.00	18.82	1.04	0.11	0.251	0.32
	WLAN5.3G	802.11ac VHT80	Right Tilted	58	82.23	1.22	19.00	18.82	1.04	0.02	0.102	0.13
15	WLAN5.3G	802.11ac VHT80	Left Cheek	58	82.23	1.22	19.00	18.82	1.04	-0.08	0.45	0.57
	WLAN5.3G	802.11ac VHT80	Left Tilted	58	82.23	1.22	19.00	18.82	1.04	0.08	0.279	0.35
	WLAN5.6G	802.11ac VHT80	Right Cheek	106	82.23	1.22	19.00	18.80	1.05	0.11	0.207	0.27
	WLAN5.6G	802.11ac VHT80	Right Tilted	106	82.23	1.22	19.00	18.80	1.05	-0.12	0.131	0.17
16	WLAN5.6G	802.11ac VHT80	Left Cheek	106	82.23	1.22	19.00	18.80	1.05	-0.08	0.468	0.60
	WLAN5.6G	802.11ac VHT80	Left Tilted	106	82.23	1.22	19.00	18.80	1.05	0.11	0.237	0.30
	WLAN5.6G	802.11ac VHT80	Left Cheek	122	82.23	1.22	19.00	18.78	1.05	-0.05	0.451	0.58
	WLAN5.8G	802.11ac VHT80	Right Cheek	155	82.23	1.22	19.00	18.76	1.06	0.05	0.378	0.49
	WLAN5.8G	802.11ac VHT80	Right Tilted	155	82.23	1.22	19.00	18.76	1.06	-0.03	0.26	0.34
17	WLAN5.8G	802.11ac VHT80	Left Cheek	155	82.23	1.22	19.00	18.76	1.06	-0.06	0.701	0.91
	WLAN5.8G	802.11ac VHT80	Left Tilted	155	82.23	1.22	19.00	18.76	1.06	0.07	0.504	0.65
	BT	BDR	Right Cheek	39	76.80	1.30	11.50	11.15	1.08	0	< 0.001	0.00
	BT	BDR	Right Tilted	39	76.80	1.30	11.50	11.15	1.08	0	< 0.001	0.00
18	BT	BDR	Left Cheek	39	76.80	1.30	11.50	11.15	1.08	0.11	0.052	0.07
	BT	BDR	Left Tilted	39	76.80	1.30	11.50	11.15	1.08	0	< 0.001	0.00
	BT	BDR	Left Cheek	0	76.80	1.30	11.00	10.75	1.06	0	< 0.001	0.00
	BT	BDR	Left Cheek	78	76.80	1.30	10.50	10.08	1.10	0	< 0.001	0.00

Note: The "< 0.001" means there is no SAR value or the SAR is too low to be measured.

4.7.3 SAR Results for Body-worn Exposure Condition (Test Separation Distance is 15 mm)

Plot No.	Band	Mode	Test Position	Ch.	Max. Tune-up Power (dBm)	Measured Conducted Power (dBm)	Scaling Factor	Power Drift (dB)	Measured SAR-1g (W/kg)	Scaled SAR-1g (W/kg)
	GSM850	GPRS12	Front Face	189	27.50	27.15	1.08	0.19	0.267	0.29
	GSM850	GPRS12	Rear Face	189	27.50	27.15	1.08	0.08	0.323	0.35
19	GSM850	GPRS12	Rear Face	128	27.50	27.11	1.09	-0.01	0.336	0.37
	GSM850	GPRS12	Rear Face	251	27.50	27.12	1.09	-0.07	0.312	0.34
	GSM1900	EDGE12	Front Face	512	26.50	25.60	1.23	0.15	0.316	0.39
20	GSM1900	EDGE12	Rear Face	512	26.50	25.60	1.23	-0.18	0.94	1.16
	GSM1900	EDGE12	Rear Face	661	26.50	25.55	1.24	-0.08	0.643	0.80
	GSM1900	EDGE12	Rear Face	810	26.50	25.42	1.28	-0.01	0.406	0.52
	GSM1900	EDGE12	Rear Face	512	26.50	25.60	1.23	0.05	0.911	1.12
	WCDMA II	RMC12.2K	Front Face	9262	24.00	23.95	1.01	0.1	0.425	0.43
21	WCDMA II	RMC12.2K	Rear Face	9262	24.00	23.95	1.01	-0.16	1.17	1.18
	WCDMA II	RMC12.2K	Rear Face	9400	24.00	23.79	1.05	-0.14	0.86	0.90
	WCDMA II	RMC12.2K	Rear Face	9538	24.00	23.91	1.02	-0.18	0.646	0.66
	WCDMA II	RMC12.2K	Rear Face	9262	24.00	23.95	1.01	0.02	1.11	1.12
	WCDMA IV	RMC12.2K	Front Face	1312	24.50	24.47	1.01	-0.06	0.263	0.27
	WCDMA IV	RMC12.2K	Rear Face	1312	24.50	24.47	1.01	-0.02	0.808	0.82
	WCDMA IV	RMC12.2K	Rear Face	1413	24.50	24.22	1.07	0.14	0.988	1.06
22	WCDMA IV	RMC12.2K	Rear Face	1513	24.50	24.41	1.02	-0.1	1.15	1.17
	WCDMA IV	RMC12.2K	Rear Face	1513	24.50	24.41	1.02	0.03	1.11	1.13
	WCDMA V	RMC12.2K	Front Face	4233	24.50	24.16	1.08	-0.12	0.384	0.41
23	WCDMA V	RMC12.2K	Rear Face	4233	24.50	24.16	1.08	0.02	0.427	0.46
	WCDMA V	RMC12.2K	Rear Face	4132	24.50	24.13	1.09	-0.14	0.407	0.44
	WCDMA V	RMC12.2K	Rear Face	4182	24.50	24.03	1.11	0.16	0.402	0.45

SAR Test Report

Plot No.	Band	Mode	Test Position	Ch.	RB	offset	Max. Tune-up Power (dBm)	Measured Conducted Power (dBm)	Scaling Factor	Power Drift (dB)	Measured SAR-1g (W/kg)	Scaled SAR-1g (W/kg)
24	LTE 2	QPSK20M	Front Face	18700	1	0	23.50	23.15	1.08	-0.11	0.367	0.40
	LTE 2	QPSK20M	Rear Face	18700	1	0	23.50	23.15	1.08	-0.19	1.02	1.10
	LTE 2	QPSK20M	Front Face	18700	50	0	22.50	22.11	1.09	-0.04	0.289	0.32
	LTE 2	QPSK20M	Rear Face	18700	50	0	22.50	22.11	1.09	0.19	0.766	0.83
	LTE 2	QPSK20M	Rear Face	18700	100	0	22.50	22.05	1.11	-0.09	0.698	0.77
	LTE 2	QPSK20M	Rear Face	18900	1	0	23.50	22.98	1.13	0.14	0.812	0.92
	LTE 2	QPSK20M	Rear Face	19100	1	0	23.50	22.91	1.15	-0.04	0.654	0.75
	LTE 2	QPSK20M	Rear Face	18900	50	0	22.50	22.03	1.11	-0.11	0.618	0.69
	LTE 2	QPSK20M	Rear Face	19100	50	0	22.50	21.98	1.13	-0.07	0.485	0.55
LTE 2	QPSK20M	Rear Face	18700	1	0	23.50	23.15	1.08	0.02	0.995	1.07	
25	LTE 4	QPSK20M	Front Face	20050	1	0	23.50	22.73	1.19	0.09	0.235	0.28
	LTE 4	QPSK20M	Rear Face	20050	1	0	23.50	22.73	1.19	-0.03	0.728	0.87
	LTE 4	QPSK20M	Front Face	20050	50	0	22.50	21.80	1.17	-0.09	0.202	0.24
	LTE 4	QPSK20M	Rear Face	20050	50	0	22.50	21.80	1.17	0.13	0.622	0.73
	LTE 4	QPSK20M	Rear Face	20050	100	0	22.50	21.69	1.21	0.09	0.647	0.78
	LTE 4	QPSK20M	Rear Face	20175	1	0	23.50	22.66	1.21	0.03	0.854	1.03
26	LTE 4	QPSK20M	Rear Face	20300	1	0	23.50	22.71	1.20	-0.14	0.931	1.12
	LTE 4	QPSK20M	Rear Face	20300	1	0	23.50	22.71	1.20	0.03	0.903	1.08
27	LTE 5	QPSK10M	Front Face	20525	1	0	23.50	23.09	1.10	-0.06	0.247	0.27
	LTE 5	QPSK10M	Rear Face	20525	1	0	23.50	23.09	1.10	-0.12	0.288	0.32
	LTE 5	QPSK10M	Front Face	20525	25	0	22.50	22.08	1.10	0.18	0.201	0.22
	LTE 5	QPSK10M	Rear Face	20525	25	0	22.50	22.08	1.10	0.06	0.231	0.25
	LTE 5	QPSK10M	Rear Face	20450	1	0	23.50	23.03	1.11	-0.03	0.293	0.33
	LTE 5	QPSK10M	Rear Face	20600	1	0	23.50	22.87	1.16	-0.08	0.285	0.33
28	LTE 7	QPSK20M	Front Face	21100	1	0	22.50	22.49	1.00	0.1	0.401	0.40
	LTE 7	QPSK20M	Rear Face	21100	1	0	22.50	22.49	1.00	-0.13	0.538	0.54
	LTE 7	QPSK20M	Front Face	21100	50	0	21.50	21.50	1.00	-0.08	0.327	0.33
	LTE 7	QPSK20M	Rear Face	21100	50	0	21.50	21.50	1.00	-0.17	0.439	0.44
	LTE 7	QPSK20M	Rear Face	20850	1	0	22.50	22.41	1.02	0.13	0.544	0.55
	LTE 7	QPSK20M	Rear Face	21350	1	0	22.50	22.36	1.03	-0.14	0.55	0.57
29	LTE 17	QPSK10M	Front Face	23790	1	0	23.50	22.64	1.22	-0.05	0.147	0.18
	LTE 17	QPSK10M	Rear Face	23790	1	0	23.50	22.64	1.22	0.09	0.182	0.22
	LTE 17	QPSK10M	Front Face	23790	25	0	22.50	21.69	1.21	-0.04	0.118	0.14
	LTE 17	QPSK10M	Rear Face	23790	25	0	22.50	21.69	1.21	-0.15	0.155	0.19
	LTE 17	QPSK10M	Rear Face	23780	1	0	23.50	22.57	1.24	0.08	0.178	0.22
	LTE 17	QPSK10M	Rear Face	23800	1	0	23.50	22.61	1.23	-0.09	0.191	0.23
30	LTE 26	QPSK15M	Front Face	26865	1	0	23.50	23.15	1.08	0.18	0.245	0.26
	LTE 26	QPSK15M	Rear Face	26865	1	0	23.50	23.15	1.08	-0.03	0.295	0.32
	LTE 26	QPSK15M	Front Face	26865	36	0	22.50	22.06	1.11	-0.02	0.201	0.22
	LTE 26	QPSK15M	Rear Face	26865	36	0	22.50	22.06	1.11	0.05	0.237	0.26
	LTE 26	QPSK15M	Rear Face	26765	1	0	23.50	23.02	1.12	0.07	0.283	0.32
	LTE 26	QPSK15M	Rear Face	26965	1	0	23.50	23.01	1.12	-0.02	0.299	0.33
31	LTE 38	QPSK20M	Front Face	38150	1	0	23.00	22.85	1.04	-0.19	0.229	0.24
	LTE 38	QPSK20M	Rear Face	38150	1	0	23.00	22.85	1.04	-0.1	0.304	0.32
	LTE 38	QPSK20M	Front Face	38150	50	0	22.00	21.85	1.04	-0.15	0.185	0.19
	LTE 38	QPSK20M	Rear Face	38150	50	0	22.00	21.85	1.04	0.06	0.245	0.25
	LTE 38	QPSK20M	Rear Face	37850	1	0	23.00	22.73	1.06	-0.06	0.272	0.29
	LTE 38	QPSK20M	Rear Face	38000	1	0	23.00	22.78	1.05	-0.11	0.291	0.31
31	LTE 41	QPSK20M	Front Face	41490	1	0	23.00	22.50	1.12	-0.04	0.281	0.31
	LTE 41	QPSK20M	Rear Face	41490	1	0	23.00	22.50	1.12	0.08	0.323	0.36
	LTE 41	QPSK20M	Front Face	41490	50	0	22.00	21.50	1.12	0.05	0.218	0.24
	LTE 41	QPSK20M	Rear Face	41490	50	0	22.00	21.50	1.12	0.06	0.248	0.28
	LTE 41	QPSK20M	Rear Face	39750	1	0	23.00	22.08	1.24	0.07	0.292	0.36
	LTE 41	QPSK20M	Rear Face	40185	1	0	23.00	22.41	1.15	0.05	0.304	0.35
	LTE 41	QPSK20M	Rear Face	40620	1	0	23.00	22.44	1.14	0.02	0.334	0.38
	LTE 41	QPSK20M	Rear Face	41055	1	0	23.00	22.47	1.13	-0.09	0.376	0.42

SAR Test Report

Plot No.	Band	Mode	Test Position	Ch.	Duty Cycle	Crest Factor	Max. Tune-up Power (dBm)	Measured Conducted Power (dBm)	Scaling Factor	Power Drift (dB)	Measured SAR-1g (W/kg)	Scaled SAR-1g (W/kg)
	WLAN2.4G	802.11b	Front Face	1	99.00	1.01	18.00	17.98	1.00	0.03	0.071	0.07
	WLAN2.4G	802.11b	Rear Face	1	99.00	1.01	18.00	17.98	1.00	0.11	0.123	0.12
	WLAN2.4G	802.11b	Rear Face	6	99.00	1.01	18.00	17.70	1.07	-0.07	0.115	0.12
32	WLAN2.4G	802.11b	Rear Face	11	99.00	1.01	18.00	17.91	1.02	-0.08	0.127	0.13
	WLAN5.3G	802.11ac VHT80	Front Face	58	82.23	1.22	19.00	18.82	1.04	0.05	0.072	0.09
33	WLAN5.3G	802.11ac VHT80	Rear Face	58	82.23	1.22	19.00	18.82	1.04	-0.1	0.33	0.42
	WLAN5.6G	802.11ac VHT80	Front Face	106	82.23	1.22	19.00	18.80	1.05	-0.11	0.102	0.13
34	WLAN5.6G	802.11ac VHT80	Rear Face	106	82.23	1.22	19.00	18.80	1.05	0.09	0.503	0.64
	WLAN5.6G	802.11ac VHT80	Rear Face	122	82.23	1.22	19.00	18.78	1.05	-0.05	0.487	0.62
	WLAN5.8G	802.11ac VHT80	Front Face	155	82.23	1.22	19.00	18.76	1.06	0.03	0.151	0.20
35	WLAN5.8G	802.11ac VHT80	Rear Face	155	82.23	1.22	19.00	18.76	1.06	-0.08	0.388	0.50
	BT	BDR	Front Face	39	76.80	1.30	11.50	11.15	1.08	0	< 0.001	0.00
	BT	BDR	Rear Face	39	76.80	1.30	11.50	11.15	1.08	0	< 0.001	0.00
	BT	BDR	Rear Face	0	76.80	1.30	11.00	10.75	1.06	0	< 0.001	0.00
	BT	BDR	Rear Face	78	76.80	1.30	10.50	10.08	1.10	0	< 0.001	0.00

Note: The “< 0.001” means there is no SAR value or the SAR is too low to be measured.

SAR Test Report

4.7.4 SAR Results for Hotspot Exposure Condition (Test Separation Distance is 10 mm)

Plot No.	Band	Mode	Test Position	Ch.	Max. Tune-up Power (dBm)	Measured Conducted Power (dBm)	Scaling Factor	Power Drift (dB)	Measured SAR-1g (W/kg)	Scaled SAR-1g (W/kg)
	GSM850	GPRS12	Front Face	189	27.50	27.15	1.08	0.02	0.278	0.30
	GSM850	GPRS12	Rear Face	189	27.50	27.15	1.08	0.13	0.338	0.37
	GSM850	GPRS12	Left Side	189	27.50	27.15	1.08	0	0.06	0.06
	GSM850	GPRS12	Right Side	189	27.50	27.15	1.08	0.02	0.228	0.25
	GSM850	GPRS12	Bottom Side	189	27.50	27.15	1.08	0.01	0.098	0.11
36	GSM850	GPRS12	Rear Face	128	27.50	27.11	1.09	0.02	0.346	0.38
	GSM850	GPRS12	Rear Face	251	27.50	27.12	1.09	0.05	0.342	0.37
	GSM1900	GPRS10	Front Face	661	27.50	27.44	1.01	0.02	0.609	0.62
37	GSM1900	GPRS10	Rear Face	661	27.50	27.44	1.01	-0.03	1.07	1.08
	GSM1900	GPRS10	Left Side	661	27.50	27.44	1.01	0.13	0.438	0.44
	GSM1900	GPRS10	Right Side	661	27.50	27.44	1.01	0.13	0.067	0.07
	GSM1900	GPRS10	Bottom Side	661	27.50	27.44	1.01	0.11	0.227	0.23
	GSM1900	GPRS10	Rear Face	512	27.50	27.40	1.02	0.02	0.942	0.96
	GSM1900	GPRS10	Rear Face	810	27.50	27.38	1.03	0.02	0.946	0.97
	GSM1900	GPRS10	Rear Face	661	27.50	27.44	1.01	0.01	1.03	1.04
	WCDMA II	RMC12.2K	Front Face	9262	19.50	19.48	1.00	0.11	0.826	0.83
38	WCDMA II	RMC12.2K	Rear Face	9262	19.50	19.48	1.00	-0.05	1.09	1.09
	WCDMA II	RMC12.2K	Left Side	9262	19.50	19.48	1.00	0.03	0.812	0.81
	WCDMA II	RMC12.2K	Right Side	9262	19.50	19.48	1.00	-0.07	0.141	0.14
	WCDMA II	RMC12.2K	Bottom Side	9262	19.50	19.48	1.00	-0.06	0.416	0.42
	WCDMA II	RMC12.2K	Front Face	9400	19.50	19.34	1.04	0.07	0.749	0.78
	WCDMA II	RMC12.2K	Front Face	9538	19.50	19.30	1.05	-0.15	0.763	0.80
	WCDMA II	RMC12.2K	Rear Face	9400	19.50	19.34	1.04	0.03	0.874	0.91
	WCDMA II	RMC12.2K	Rear Face	9538	19.50	19.30	1.05	-0.01	0.749	0.79
	WCDMA II	RMC12.2K	Left Side	9400	19.50	19.34	1.04	0.08	0.742	0.77
	WCDMA II	RMC12.2K	Left Side	9538	19.50	19.30	1.05	0.11	0.798	0.84
	WCDMA II	RMC12.2K	Rear Face	9262	19.50	19.48	1.00	-0.05	1.03	1.03
	WCDMA IV	RMC12.2K	Front Face	1312	19.50	18.91	1.15	-0.11	0.257	0.30
	WCDMA IV	RMC12.2K	Rear Face	1312	19.50	18.91	1.15	-0.03	0.858	0.99
	WCDMA IV	RMC12.2K	Left Side	1312	19.50	18.91	1.15	0.08	0.251	0.29
	WCDMA IV	RMC12.2K	Right Side	1312	19.50	18.91	1.15	-0.05	0.103	0.12
	WCDMA IV	RMC12.2K	Bottom Side	1312	19.50	18.91	1.15	0.15	0.398	0.46
	WCDMA IV	RMC12.2K	Rear Face	1413	19.50	18.80	1.17	0.05	0.918	1.07
39	WCDMA IV	RMC12.2K	Rear Face	1513	19.50	18.81	1.17	-0.04	0.981	1.15
	WCDMA IV	RMC12.2K	Rear Face	1513	19.50	18.81	1.17	0.08	0.945	1.11
	WCDMA V	RMC12.2K	Front Face	4233	24.50	24.16	1.08	0.05	0.464	0.50
40	WCDMA V	RMC12.2K	Rear Face	4233	24.50	24.16	1.08	-0.03	0.598	0.65
	WCDMA V	RMC12.2K	Left Side	4233	24.50	24.16	1.08	0.11	0.114	0.12
	WCDMA V	RMC12.2K	Right Side	4233	24.50	24.16	1.08	-0.09	0.356	0.38
	WCDMA V	RMC12.2K	Bottom Side	4233	24.50	24.16	1.08	-0.05	0.177	0.19
	WCDMA V	RMC12.2K	Rear Face	4132	24.50	24.13	1.09	0.01	0.522	0.57
	WCDMA V	RMC12.2K	Rear Face	4182	24.50	24.03	1.11	-0.07	0.533	0.59

SAR Test Report

Plot No.	Band	Mode	Test Position	Ch.	RB	offset	Max. Tune-up Power (dBm)	Measured Conducted Power (dBm)	Scaling Factor	Power Drift (dB)	Measured SAR-1g (W/kg)	Scaled SAR-1g (W/kg)
41	LTE 2	QPSK20M	Front Face	18700	1	0	19.50	19.49	1.00	0.02	0.792	0.79
	LTE 2	QPSK20M	Rear Face	18700	1	0	19.50	19.49	1.00	-0.03	1.09	1.09
	LTE 2	QPSK20M	Left Side	18700	1	0	19.50	19.49	1.00	0.06	0.794	0.79
	LTE 2	QPSK20M	Right Side	18700	1	0	19.50	19.49	1.00	-0.12	0.113	0.11
	LTE 2	QPSK20M	Bottom Side	18700	1	0	19.50	19.49	1.00	-0.07	0.465	0.47
	LTE 2	QPSK20M	Front Face	18700	50	0	19.50	19.45	1.01	0.05	0.619	0.63
	LTE 2	QPSK20M	Rear Face	18700	50	0	19.50	19.45	1.01	-0.13	0.821	0.83
	LTE 2	QPSK20M	Left Side	18700	50	0	19.50	19.45	1.01	0.05	0.618	0.62
	LTE 2	QPSK20M	Right Side	18700	50	0	19.50	19.45	1.01	-0.07	0.085	0.09
	LTE 2	QPSK20M	Bottom Side	18700	50	0	19.50	19.45	1.01	0.05	0.357	0.36
	LTE 2	QPSK20M	Rear Face	18700	100	0	19.50	19.44	1.01	-0.09	0.761	0.77
	LTE 2	QPSK20M	Rear Face	18900	1	0	19.50	19.37	1.03	0.04	0.885	0.91
	LTE 2	QPSK20M	Rear Face	19100	1	0	19.50	19.23	1.06	-0.11	0.705	0.75
	LTE 2	QPSK20M	Rear Face	18900	50	0	19.50	19.33	1.04	-0.05	0.656	0.68
	LTE 2	QPSK20M	Rear Face	19100	50	0	19.50	19.19	1.07	0.08	0.556	0.59
	LTE 2	QPSK20M	Rear Face	18700	1	0	19.50	19.49	1.00	-0.03	1.02	1.02
42	LTE 4	QPSK20M	Front Face	20050	1	0	19.50	19.40	1.02	-0.01	0.289	0.29
	LTE 4	QPSK20M	Rear Face	20050	1	0	19.50	19.40	1.02	0.03	0.968	0.99
	LTE 4	QPSK20M	Left Side	20050	1	0	19.50	19.40	1.02	-0.06	0.279	0.28
	LTE 4	QPSK20M	Right Side	20050	1	0	19.50	19.40	1.02	-0.12	0.103	0.11
	LTE 4	QPSK20M	Bottom Side	20050	1	0	19.50	19.40	1.02	-0.01	0.418	0.43
	LTE 4	QPSK20M	Front Face	20050	50	0	19.50	19.38	1.03	0.11	0.239	0.25
	LTE 4	QPSK20M	Rear Face	20050	50	0	19.50	19.38	1.03	0.09	0.811	0.84
	LTE 4	QPSK20M	Left Side	20050	50	0	19.50	19.38	1.03	-0.05	0.212	0.22
	LTE 4	QPSK20M	Right Side	20050	50	0	19.50	19.38	1.03	-0.12	0.113	0.12
	LTE 4	QPSK20M	Bottom Side	20050	50	0	19.50	19.38	1.03	-0.12	0.358	0.37
	LTE 4	QPSK20M	Rear Face	20050	100	0	19.50	19.35	1.04	0.04	0.845	0.88
	LTE 4	QPSK20M	Rear Face	20175	1	0	19.50	19.38	1.03	-0.11	0.992	1.02
	LTE 4	QPSK20M	Rear Face	20300	1	0	19.50	19.37	1.03	-0.05	1.07	1.10
	LTE 4	QPSK20M	Rear Face	20175	50	0	19.50	19.36	1.03	0.05	0.821	0.85
	LTE 4	QPSK20M	Rear Face	20300	50	0	19.50	19.35	1.04	-0.09	0.831	0.86
	LTE 4	QPSK20M	Rear Face	20300	1	0	19.50	19.37	1.03	-0.05	1.01	1.04
43	LTE 5	QPSK10M	Front Face	20525	1	0	23.50	23.09	1.10	-0.11	0.316	0.35
	LTE 5	QPSK10M	Rear Face	20525	1	0	23.50	23.09	1.10	-0.03	0.447	0.49
	LTE 5	QPSK10M	Left Side	20525	1	0	23.50	23.09	1.10	0.03	0.251	0.28
	LTE 5	QPSK10M	Right Side	20525	1	0	23.50	23.09	1.10	-0.03	0.086	0.09
	LTE 5	QPSK10M	Bottom Side	20525	1	0	23.50	23.09	1.10	-0.07	0.117	0.13
	LTE 5	QPSK10M	Front Face	20525	25	0	22.50	22.08	1.10	-0.02	0.259	0.28
	LTE 5	QPSK10M	Rear Face	20525	25	0	22.50	22.08	1.10	0.04	0.366	0.40
	LTE 5	QPSK10M	Left Side	20525	25	0	22.50	22.08	1.10	0.12	0.206	0.23
	LTE 5	QPSK10M	Right Side	20525	25	0	22.50	22.08	1.10	-0.07	0.072	0.08
	LTE 5	QPSK10M	Bottom Side	20525	25	0	22.50	22.08	1.10	-0.11	0.093	0.10
LTE 5	QPSK10M	Rear Face	20450	1	0	23.50	23.03	1.11	0.03	0.431	0.48	
LTE 5	QPSK10M	Rear Face	20600	1	0	23.50	22.87	1.16	-0.09	0.412	0.48	

Note: The "< 0.001" means there is no SAR value or the SAR is too low to be measured.

SAR Test Report

Plot No.	Band	Mode	Test Position	Ch.	RB	offset	Max. Tune-up Power (dBm)	Measured Conducted Power (dBm)	Scaling Factor	Power Drift (dB)	Measured SAR-1g (W/kg)	Scaled SAR-1g (W/kg)
44	LTE 7	QPSK20M	Front Face	21100	1	0	21.50	21.49	1.00	-0.11	0.512	0.51
	LTE 7	QPSK20M	Rear Face	21100	1	0	21.50	21.49	1.00	-0.01	0.999	1.00
	LTE 7	QPSK20M	Left Side	21100	1	0	21.50	21.49	1.00	0.03	0.598	0.60
	LTE 7	QPSK20M	Right Side	21100	1	0	21.50	21.49	1.00	0.05	0.03	0.03
	LTE 7	QPSK20M	Bottom Side	21100	1	0	21.50	21.49	1.00	-0.12	0.865	0.87
	LTE 7	QPSK20M	Front Face	21100	50	0	21.50	21.45	1.01	0.03	0.419	0.42
	LTE 7	QPSK20M	Rear Face	21100	50	0	21.50	21.45	1.01	-0.11	0.813	0.82
	LTE 7	QPSK20M	Left Side	21100	50	0	21.50	21.45	1.01	-0.07	0.502	0.51
	LTE 7	QPSK20M	Right Side	21100	50	0	21.50	21.45	1.01	-0.12	0.024	0.02
	LTE 7	QPSK20M	Bottom Side	21100	50	0	21.50	21.45	1.01	-0.12	0.685	0.69
	LTE 7	QPSK20M	Rear Face	21100	100	0	21.50	21.43	1.02	-0.05	0.813	0.83
	LTE 7	QPSK20M	Bottom Side	21100	100	0	21.50	21.43	1.02	0.01	0.673	0.69
	LTE 7	QPSK20M	Rear Face	20850	1	0	21.50	21.48	1.00	0.12	0.964	0.96
	LTE 7	QPSK20M	Rear Face	21350	1	0	21.50	21.31	1.04	-0.07	0.935	0.97
	LTE 7	QPSK20M	Bottom Side	20850	1	0	21.50	21.48	1.00	0.05	0.737	0.74
	LTE 7	QPSK20M	Bottom Side	21350	1	0	21.50	21.31	1.04	0.02	0.714	0.74
LTE 7	QPSK20M	Rear Face	20850	50	0	21.50	21.44	1.01	0.09	0.795	0.80	
LTE 7	QPSK20M	Rear Face	21350	50	0	21.50	21.27	1.05	0.11	0.76	0.80	
LTE 7	QPSK20M	Rear Face	21100	1	0	21.50	21.49	1.00	-0.01	0.985	0.99	
	LTE 17	QPSK10M	Front Face	23790	1	0	23.50	22.64	1.22	-0.11	0.142	0.17
	LTE 17	QPSK10M	Rear Face	23790	1	0	23.50	22.64	1.22	-0.03	0.238	0.29
	LTE 17	QPSK10M	Left Side	23790	1	0	23.50	22.64	1.22	0.05	0.102	0.12
	LTE 17	QPSK10M	Right Side	23790	1	0	23.50	22.64	1.22	0.12	0.151	0.18
	LTE 17	QPSK10M	Bottom Side	23790	1	0	23.50	22.64	1.22	-0.07	0.039	0.05
	LTE 17	QPSK10M	Front Face	23790	25	0	22.50	21.69	1.21	0.11	0.117	0.14
	LTE 17	QPSK10M	Rear Face	23790	25	0	22.50	21.69	1.21	-0.03	0.207	0.25
	LTE 17	QPSK10M	Left Side	23790	25	0	22.50	21.69	1.21	0.01	0.081	0.10
	LTE 17	QPSK10M	Right Side	23790	25	0	22.50	21.69	1.21	-0.09	0.121	0.15
	LTE 17	QPSK10M	Bottom Side	23790	25	0	22.50	21.69	1.21	0.05	0.034	0.04
	LTE 17	QPSK10M	Rear Face	23780	1	0	23.50	22.57	1.24	-0.08	0.234	0.29
	45	LTE 17	QPSK10M	Rear Face	23800	1	0	23.50	22.61	1.23	-0.01	0.251
	LTE 26	QPSK15M	Front Face	26865	1	0	23.50	23.15	1.08	-0.11	0.345	0.37
	LTE 26	QPSK15M	Rear Face	26865	1	0	23.50	23.15	1.08	0.03	0.458	0.49
	LTE 26	QPSK15M	Left Side	26865	1	0	23.50	23.15	1.08	-0.05	0.089	0.10
	LTE 26	QPSK15M	Right Side	26865	1	0	23.50	23.15	1.08	0.12	0.264	0.29
	LTE 26	QPSK15M	Bottom Side	26865	1	0	23.50	23.15	1.08	0.05	0.125	0.14
	LTE 26	QPSK15M	Front Face	26865	36	0	22.50	22.06	1.11	-0.07	0.276	0.31
	LTE 26	QPSK15M	Rear Face	26865	36	0	22.50	22.06	1.11	0.13	0.365	0.41
	LTE 26	QPSK15M	Left Side	26865	36	0	22.50	22.06	1.11	-0.05	0.074	0.08
	LTE 26	QPSK15M	Right Side	26865	36	0	22.50	22.06	1.11	0.09	0.211	0.23
	LTE 26	QPSK15M	Bottom Side	26865	36	0	22.50	22.06	1.11	0.06	0.099	0.11
	LTE 26	QPSK15M	Rear Face	26765	1	0	23.50	23.02	1.12	0.01	0.421	0.47
	46	LTE 26	QPSK15M	Rear Face	26965	1	0	23.50	23.01	1.12	-0.03	0.461

Note: The "< 0.001" means there is no SAR value or the SAR is too low to be measured.

SAR Test Report

Plot No.	Band	Mode	Test Position	Ch.	RB	offset	Max. Tune-up Power (dBm)	Measured Conducted Power (dBm)	Scaling Factor	Power Drift (dB)	Measured SAR-1g (W/kg)	Scaled SAR-1g (W/kg)
	LTE 38	QPSK20M	Front Face	38150	1	0	23.00	22.85	1.04	0.03	0.393	0.41
	LTE 38	QPSK20M	Rear Face	38150	1	0	23.00	22.85	1.04	-0.05	0.784	0.82
	LTE 38	QPSK20M	Left Side	38150	1	0	23.00	22.85	1.04	0.12	0.434	0.45
	LTE 38	QPSK20M	Right Side	38150	1	0	23.00	22.85	1.04	0	< 0.001	0.00
	LTE 38	QPSK20M	Bottom Side	38150	1	0	23.00	22.85	1.04	-0.11	0.523	0.54
	LTE 38	QPSK20M	Front Face	38150	50	0	22.00	21.85	1.04	0.03	0.316	0.33
	LTE 38	QPSK20M	Rear Face	38150	50	0	22.00	21.85	1.04	-0.07	0.567	0.59
	LTE 38	QPSK20M	Left Side	38150	50	0	22.00	21.85	1.04	0.12	0.372	0.39
	LTE 38	QPSK20M	Right Side	38150	50	0	22.00	21.85	1.04	0	< 0.001	0.00
	LTE 38	QPSK20M	Bottom Side	38150	50	0	22.00	21.85	1.04	-0.05	0.377	0.39
	LTE 38	QPSK20M	Rear Face	38150	100	0	22.00	21.87	1.03	-0.11	0.603	0.62
	LTE 38	QPSK20M	Rear Face	37850	1	0	23.00	22.73	1.06	0.09	0.829	0.88
47	LTE 38	QPSK20M	Rear Face	38000	1	0	23.00	22.78	1.05	-0.04	0.846	0.89
	LTE 38	QPSK20M	Rear Face	38000	1	0	23.00	22.78	1.05	0.08	0.835	0.88
	LTE 41	QPSK20M	Front Face	41490	1	0	21.50	21.49	1.00	-0.12	0.339	0.34
48	LTE 41	QPSK20M	Rear Face	41490	1	0	21.50	21.49	1.00	-0.03	0.729	0.73
	LTE 41	QPSK20M	Left Side	41490	1	0	21.50	21.49	1.00	0.05	0.371	0.37
	LTE 41	QPSK20M	Right Side	41490	1	0	21.50	21.49	1.00	-0.11	0.025	0.03
	LTE 41	QPSK20M	Bottom Side	41490	1	0	21.50	21.49	1.00	0.09	0.282	0.28
	LTE 41	QPSK20M	Front Face	41490	50	0	21.50	21.48	1.00	0.07	0.227	0.23
	LTE 41	QPSK20M	Rear Face	41490	50	0	21.50	21.48	1.00	-0.05	0.462	0.46
	LTE 41	QPSK20M	Left Side	41490	50	0	21.50	21.48	1.00	0.11	0.242	0.24
	LTE 41	QPSK20M	Right Side	41490	50	0	21.50	21.48	1.00	0	0.001	0.00
	LTE 41	QPSK20M	Bottom Side	41490	50	0	21.50	21.48	1.00	0.12	0.201	0.20
	LTE 41	QPSK20M	Rear Face	39750	1	0	21.50	21.36	1.03	0.03	0.409	0.42
	LTE 41	QPSK20M	Rear Face	40185	1	0	21.50	21.43	1.02	-0.07	0.442	0.45
	LTE 41	QPSK20M	Rear Face	40620	1	0	21.50	21.47	1.01	-0.12	0.406	0.41
	LTE 41	QPSK20M	Rear Face	41055	1	0	21.50	21.48	1.00	-0.05	0.491	0.49

Note: The “< 0.001” means there is no SAR value or the SAR is too low to be measured.

SAR Test Report

Plot No.	Band	Mode	Test Position	Ch.	Duty Cycle	Crest Factor	Max. Tune-up Power (dBm)	Measured Conducted Power (dBm)	Scaling Factor	Power Drift (dB)	Measured SAR-1g (W/kg)	Scaled SAR-1g (W/kg)
	WLAN2.4G	802.11b	Front Face	1	99.00	1.01	18.00	17.98	1.00	0.08	0.127	0.13
	WLAN2.4G	802.11b	Rear Face	1	99.00	1.01	18.00	17.98	1.00	-0.11	0.211	0.21
49	WLAN2.4G	802.11b	Right Side	1	99.00	1.01	18.00	17.98	1.00	-0.05	0.233	0.24
	WLAN2.4G	802.11b	Top Side	1	99.00	1.01	18.00	17.98	1.00	0.03	0.071	0.07
	WLAN2.4G	802.11b	Right Side	6	99.00	1.01	18.00	17.70	1.07	-0.05	0.204	0.22
	WLAN2.4G	802.11b	Right Side	11	99.00	1.01	18.00	17.91	1.02	0.07	0.222	0.23
	WLAN5.2G	802.11ac VHT80	Front Face	42	82.23	1.22	19.00	18.80	1.05	0.11	0.189	0.24
50	WLAN5.2G	802.11ac VHT80	Rear Face	42	82.23	1.22	19.00	18.80	1.05	0.12	0.782	1.00
	WLAN5.2G	802.11ac VHT80	Right Side	42	82.23	1.22	19.00	18.80	1.05	0.05	0.471	0.60
	WLAN5.2G	802.11ac VHT80	Top Side	42	82.23	1.22	19.00	18.80	1.05	0.03	0.224	0.29
	WLAN5.8G	802.11ac VHT80	Front Face	155	82.23	1.22	19.00	18.76	1.06	-0.11	0.216	0.28
51	WLAN5.8G	802.11ac VHT80	Rear Face	155	82.23	1.22	19.00	18.76	1.06	0.09	0.598	0.77
	WLAN5.8G	802.11ac VHT80	Right Side	155	82.23	1.22	19.00	18.76	1.06	-0.07	0.461	0.60
	WLAN5.8G	802.11ac VHT80	Top Side	155	82.23	1.22	19.00	18.76	1.06	-0.03	0.087	0.11
	BT	BDR	Front Face	39	76.80	1.30	11.50	11.15	1.08	0	< 0.001	0.00
	BT	BDR	Rear Face	39	76.80	1.30	11.50	11.15	1.08	0	< 0.001	0.00
52	BT	BDR	Right Side	39	76.80	1.30	11.50	11.15	1.08	0.09	0.003	0.00
	BT	BDR	Top Side	39	76.80	1.30	11.50	11.15	1.08	0	< 0.001	0.00
	BT	BDR	Right Side	0	76.80	1.30	11.00	10.75	1.06	0	< 0.001	0.00
	BT	BDR	Right Side	78	76.80	1.30	10.50	10.08	1.10	0	< 0.001	0.00

Note: The "< 0.001" means there is no SAR value or the SAR is too low to be measured.

SAR Test Report

4.7.5 SAR Results for Product Specific (Phablet) Exposure Condition (Test Separation Distance is 0 mm)

Plot No.	Band	Mode	Test Position	Ch.	Max. Tune-up Power (dBm)	Measured Conducted Power (dBm)	Scaling Factor	Power Drift (dB)	Measured SAR-10g (W/kg)	Scaled SAR-10g (W/kg)
53	GSM1900	EDGE12	Front Face	512	26.50	25.60	1.23	0.14	1.17	1.44
	GSM1900	EDGE12	Rear Face	512	26.50	25.60	1.23	-0.06	1.43	1.76
	GSM1900	EDGE12	Left Side	512	26.50	25.60	1.23	0.1	0.782	0.96
	GSM1900	EDGE12	Right Side	512	26.50	25.60	1.23	0.17	0.117	0.14
	GSM1900	EDGE12	Bottom Side	512	26.50	25.60	1.23	0.14	0.396	0.49
	GSM1900	EDGE12	Rear Face	661	26.50	25.55	1.24	0.12	1.4	1.74
	GSM1900	EDGE12	Rear Face	810	26.50	25.42	1.28	0.15	1.37	1.75
54	WCDMA II	RMC12.2K	Front Face	9262	24.00	23.95	1.01	0.01	2.46	2.48
	WCDMA II	RMC12.2K	Rear Face	9262	24.00	23.95	1.01	-0.04	2.91	2.94
	WCDMA II	RMC12.2K	Left Side	9262	24.00	23.95	1.01	0.03	1.73	1.75
	WCDMA II	RMC12.2K	Right Side	9262	24.00	23.95	1.01	0.03	0.238	0.24
	WCDMA II	RMC12.2K	Bottom Side	9262	24.00	23.95	1.01	0.03	0.896	0.90
	WCDMA II	RMC12.2K	Front Face	9400	24.00	23.79	1.05	0.15	2.29	2.40
	WCDMA II	RMC12.2K	Front Face	9538	24.00	23.91	1.02	0.11	2.2	2.24
	WCDMA II	RMC12.2K	Rear Face	9400	24.00	23.79	1.05	0.01	2.76	2.90
	WCDMA II	RMC12.2K	Rear Face	9538	24.00	23.91	1.02	0.13	2.85	2.91
	WCDMA II	RMC12.2K	Rear Face	9262	24.00	23.95	1.01	0.03	2.88	2.91
55	WCDMA IV	RMC12.2K	Front Face	1312	24.50	24.47	1.01	-0.18	1.3	1.31
	WCDMA IV	RMC12.2K	Rear Face	1312	24.50	24.47	1.01	0.09	2.23	2.25
	WCDMA IV	RMC12.2K	Left Side	1312	24.50	24.47	1.01	0.11	1.23	1.24
	WCDMA IV	RMC12.2K	Right Side	1312	24.50	24.47	1.01	0.13	0.155	0.16
	WCDMA IV	RMC12.2K	Bottom Side	1312	24.50	24.47	1.01	0.11	1.14	1.15
	WCDMA IV	RMC12.2K	Rear Face	1413	24.50	24.22	1.07	0.13	2.19	2.34
	WCDMA IV	RMC12.2K	Rear Face	1513	24.50	24.41	1.02	-0.1	2.3	2.35
WCDMA IV	RMC12.2K	Rear Face	1513	24.50	24.41	1.02	0.03	2.27	2.32	

Plot No.	Band	Mode	Test Position	Ch.	RB	offset	Max. Tune-up Power (dBm)	Measured Conducted Power (dBm)	Scaling Factor	Power Drift (dB)	Measured SAR-10g (W/kg)	Scaled SAR-10g (W/kg)
56	LTE 2	QPSK20M	Front Face	18700	1	0	23.50	23.15	1.08	0.01	1.63	1.76
	LTE 2	QPSK20M	Rear Face	18700	1	0	23.50	23.15	1.08	-0.09	2.03	2.19
	LTE 2	QPSK20M	Left Side	18700	1	0	23.50	23.15	1.08	-0.04	1.23	1.33
	LTE 2	QPSK20M	Right Side	18700	1	0	23.50	23.15	1.08	0.03	0.185	0.20
	LTE 2	QPSK20M	Bottom Side	18700	1	0	23.50	23.15	1.08	0.04	0.611	0.66
	LTE 2	QPSK20M	Front Face	18700	50	0	22.50	22.11	1.09	0.19	1.35	1.47
	LTE 2	QPSK20M	Rear Face	18700	50	0	22.50	22.11	1.09	-0.19	1.56	1.70
	LTE 2	QPSK20M	Left Side	18700	50	0	22.50	22.11	1.09	0.03	0.937	1.02
	LTE 2	QPSK20M	Right Side	18700	50	0	22.50	22.11	1.09	-0.09	0.096	0.10
	LTE 2	QPSK20M	Bottom Side	18700	50	0	22.50	22.11	1.09	-0.03	0.436	0.48
	LTE 2	QPSK20M	Rear Face	18700	100	0	22.50	22.05	1.11	-0.07	1.56	1.73
	LTE 2	QPSK20M	Rear Face	18900	1	0	23.50	22.98	1.13	-0.17	1.85	2.09
	LTE 2	QPSK20M	Rear Face	19100	1	0	23.50	22.91	1.15	0.02	1.79	2.06
	LTE 2	QPSK20M	Rear Face	18700	1	0	23.50	23.15	1.08	0.08	1.98	2.14

SAR Test Report

Plot No.	Band	Mode	Test Position	Ch.	RB	offset	Max. Tune-up Power (dBm)	Measured Conducted Power (dBm)	Scaling Factor	Power Drift (dB)	Measured SAR-10g (W/kg)	Scaled SAR-10g (W/kg)
	LTE 4	QPSK20M	Front Face	20050	1	0	23.50	22.73	1.19	0.09	1.09	1.30
	LTE 4	QPSK20M	Rear Face	20050	1	0	23.50	22.73	1.19	0.11	1.87	2.23
	LTE 4	QPSK20M	Left Side	20050	1	0	23.50	22.73	1.19	-0.05	1.07	1.27
	LTE 4	QPSK20M	Right Side	20050	1	0	23.50	22.73	1.19	0.09	0.142	0.17
	LTE 4	QPSK20M	Bottom Side	20050	1	0	23.50	22.73	1.19	-0.18	0.934	1.11
	LTE 4	QPSK20M	Front Face	20050	50	0	22.50	21.80	1.17	0.14	0.891	1.04
	LTE 4	QPSK20M	Rear Face	20050	50	0	22.50	21.80	1.17	0.02	1.47	1.72
	LTE 4	QPSK20M	Left Side	20050	50	0	22.50	21.80	1.17	-0.03	0.897	1.05
	LTE 4	QPSK20M	Right Side	20050	50	0	22.50	21.80	1.17	-0.11	0.134	0.16
	LTE 4	QPSK20M	Bottom Side	20050	50	0	22.50	21.80	1.17	0.04	0.677	0.79
	LTE 4	QPSK20M	Rear Face	20050	100	0	22.50	21.69	1.21	0.01	1.63	1.97
	LTE 4	QPSK20M	Rear Face	20175	1	0	23.50	22.66	1.21	0.09	1.86	2.25
57	LTE 4	QPSK20M	Rear Face	20300	1	0	23.50	22.71	1.20	-0.09	2	2.40
	LTE 4	QPSK20M	Rear Face	20300	1	0	23.50	22.71	1.20	-0.07	1.95	2.34
	LTE 7	QPSK20M	Front Face	21100	1	0	22.50	22.49	1.00	0.03	1.17	1.17
58	LTE 7	QPSK20M	Rear Face	21100	1	0	22.50	22.49	1.00	0.08	3.59	3.59
	LTE 7	QPSK20M	Left Side	21100	1	0	22.50	22.49	1.00	0.09	1.01	1.01
	LTE 7	QPSK20M	Right Side	21100	1	0	22.50	22.49	1.00	-0.11	0.04	0.04
	LTE 7	QPSK20M	Bottom Side	21100	1	0	22.50	22.49	1.00	0.02	1.08	1.08
	LTE 7	QPSK20M	Front Face	21100	50	0	21.50	21.50	1.00	-0.02	0.881	0.88
	LTE 7	QPSK20M	Rear Face	21100	50	0	21.50	21.50	1.00	-0.11	2.84	2.84
	LTE 7	QPSK20M	Left Side	21100	50	0	21.50	21.50	1.00	0.16	0.804	0.80
	LTE 7	QPSK20M	Right Side	21100	50	0	21.50	21.50	1.00	-0.02	0.031	0.03
	LTE 7	QPSK20M	Bottom Side	21100	50	0	21.50	21.50	1.00	-0.15	0.927	0.93
	LTE 7	QPSK20M	Rear Face	21100	100	0	21.50	21.45	1.01	0.02	3.03	3.06
	LTE 7	QPSK20M	Rear Face	20850	1	0	22.50	22.41	1.02	0.02	3.31	3.38
	LTE 7	QPSK20M	Rear Face	21350	1	0	22.50	22.36	1.03	-0.02	3.46	3.56
	LTE 7	QPSK20M	Rear Face	20850	50	0	21.50	21.48	1.00	0.02	2.87	2.87
	LTE 7	QPSK20M	Rear Face	21350	50	0	21.50	21.43	1.02	-0.02	3.08	3.14
	LTE 7	QPSK20M	Rear Face	21100	1	0	22.50	22.49	1.00	0.11	3.51	3.51

Plot No.	Band	Mode	Test Position	Ch.	Duty Cycle	Crest Factor	Max. Tune-up Power (dBm)	Measured Conducted Power (dBm)	Scaling Factor	Power Drift (dB)	Measured SAR-10g (W/kg)	Scaled SAR-10g (W/kg)
	WLAN5.3G	802.11ac VHT80	Front Face	58	82.23	1.22	19.00	18.82	1.04	0.03	0.266	0.34
	WLAN5.3G	802.11ac VHT80	Rear Face	58	82.23	1.22	19.00	18.82	1.04	0.07	0.583	0.74
59	WLAN5.3G	802.11ac VHT80	Right Side	58	82.23	1.22	19.00	18.82	1.04	-0.08	0.653	0.83
	WLAN5.3G	802.11ac VHT80	Top Side	58	82.23	1.22	19.00	18.82	1.04	0.08	0.154	0.20
	WLAN5.6G	802.11ac VHT80	Front Face	106	82.23	1.22	19.00	18.80	1.05	0.08	0.31	0.40
60	WLAN5.6G	802.11ac VHT80	Rear Face	106	82.23	1.22	19.00	18.80	1.05	-0.01	0.673	0.86
	WLAN5.6G	802.11ac VHT80	Right Side	106	82.23	1.22	19.00	18.80	1.05	0.01	0.633	0.81
	WLAN5.6G	802.11ac VHT80	Top Side	106	82.23	1.22	19.00	18.80	1.05	0.05	0.151	0.19
	WLAN5.6G	802.11ac VHT80	Rear Face	122	82.23	1.22	19.00	18.78	1.05	-0.18	0.653	0.84
	BT	BDR	Front Face	39	76.80	1.30	11.50	11.15	1.08	0.12	0.038	0.05
	BT	BDR	Rear Face	39	76.80	1.30	11.50	11.15	1.08	0.18	0.033	0.05
61	BT	BDR	Right Side	39	76.80	1.30	11.50	11.15	1.08	-0.01	0.04	0.06
	BT	BDR	Top Side	39	76.80	1.30	11.50	11.15	1.08	0.15	< 0.001	0.00
	BT	BDR	Right Side	0	76.80	1.30	11.00	10.75	1.06	-0.03	0.032	0.04
	BT	BDR	Right Side	78	76.80	1.30	10.50	10.08	1.10	0.04	0.028	0.04

Note: The "< 0.001" means there is no SAR value or the SAR is too low to be measured.

SAR Test Report

4.7.6 SAR Measurement Variability

According to KDB 865664 D01, SAR measurement variability was assessed for each frequency band, which is determined by the SAR probe calibration point and tissue-equivalent medium used for the device measurements. When both head and body tissue-equivalent media are required for SAR measurements in a frequency band, the variability measurement procedures should be applied to the tissue medium with the highest measured SAR, using the highest measured SAR configuration for that tissue-equivalent medium. Alternatively, if the highest measured SAR for both head and body tissue-equivalent media are ≤ 1.45 W/kg and the ratio of these highest SAR values, i.e., largest divided by smallest value, is ≤ 1.10 , the highest SAR configuration for either head or body tissue-equivalent medium maybe used to perform the repeated measurement. These additional measurements are repeated after the completion of all measurements requiring the same head or body tissue-equivalent medium in a frequency band. The test device should be returned to ambient conditions (normal room temperature) with the battery fully charged before it is re-mounted on the device holder for the repeated measurement(s) to minimize any unexpected variations in the repeated results.

SAR repeated measurement procedure:

1. When the highest measured SAR is < 0.80 W/kg, repeated measurement is not required.
2. When the highest measured SAR is ≥ 0.80 W/kg, repeat that measurement once.
3. If the ratio of largest to smallest SAR for the original and first repeated measurements is > 1.20 , or when the original or repeated measurement is ≥ 1.45 W/kg, perform a second repeated measurement.
4. If the ratio of largest to smallest SAR for the original, first and second repeated measurements is > 1.20 , and the original, first or second repeated measurement is ≥ 1.5 W/kg, perform a third repeated measurement.

Head

Band	Mode	Test Position	Ch.	Original Measured SAR-1g (W/kg)	1st Repeated SAR-1g (W/kg)	L/S Ratio	2nd Repeated SAR-1g (W/kg)	L/S Ratio	3rd Repeated SAR-1g (W/kg)	L/S Ratio
WCDMA II	RMC12.2K	Left Cheek	9262	1.17	1.14	1.03	N/A	N/A	N/A	N/A
WCDMA IV	RMC12.2K	Left Cheek	1513	0.943	0.921	1.02	N/A	N/A	N/A	N/A
LTE 2	QPSK20M	Left Cheek	18700	0.985	0.971	1.01	N/A	N/A	N/A	N/A
LTE 7	QPSK20M	Left Cheek	20850	0.896	0.885	1.01	N/A	N/A	N/A	N/A

Body-Worn

Band	Mode	Test Position	Ch.	Original Measured SAR-1g (W/kg)	1st Repeated SAR-1g (W/kg)	L/S Ratio	2nd Repeated SAR-1g (W/kg)	L/S Ratio	3rd Repeated SAR-1g (W/kg)	L/S Ratio
GSM1900	EDGE12	Rear Face	512	0.94	0.911	1.03	N/A	N/A	N/A	N/A
WCDMA II	RMC 12.2K	Rear Face	9262	1.17	1.11	1.05	N/A	N/A	N/A	N/A
WCDMA IV	RMC 12.2K	Rear Face	1513	1.15	1.11	1.04	N/A	N/A	N/A	N/A
LTE 2	QPSK20M	Rear Face	18700	1.02	0.995	1.03	N/A	N/A	N/A	N/A
LTE 4	QPSK20M	Rear Face	20300	0.931	0.903	1.03	N/A	N/A	N/A	N/A

SAR Test Report

Hotspot

Band	Mode	Test Position	Ch.	Original Measured SAR-1g (W/kg)	1st Repeated SAR-1g (W/kg)	L/S Ratio	2nd Repeated SAR-1g (W/kg)	L/S Ratio	3rd Repeated SAR-1g (W/kg)	L/S Ratio
GSM1900	GPRS10	Rear Face	661	1.07	1.03	1.04	N/A	N/A	N/A	N/A
WCDMA II	RMC 12.2K	Rear Face	9262	1.09	1.03	1.06	N/A	N/A	N/A	N/A
WCDMA IV	RMC 12.2K	Rear Face	1513	0.981	0.945	1.04	N/A	N/A	N/A	N/A
LTE 2	QPSK20M	Rear Face	18700	1.09	1.02	1.07	N/A	N/A	N/A	N/A
LTE 4	QPSK20M	Rear Face	20300	1.07	1.01	1.06	N/A	N/A	N/A	N/A
LTE 7	QPSK20M	Rear Face	21100	0.999	0.985	1.01	N/A	N/A	N/A	N/A
LTE 38	QPSK20M	Rear Face	38000	0.846	0.835	1.01	N/A	N/A	N/A	N/A

Product Specific (Phablet)

Band	Mode	Test Position	Ch.	Original Measured SAR-10g (W/kg)	1st Repeated SAR-10g (W/kg)	L/S Ratio	2nd Repeated SAR-10g (W/kg)	L/S Ratio	3rd Repeated SAR-10g (W/kg)	L/S Ratio
WCDMA II	RMC 12.2K	Rear Face	9262	2.91	2.88	1.01	N/A	N/A	N/A	N/A
WCDMA IV	RMC 12.2K	Rear Face	1513	2.3	2.27	1.01	N/A	N/A	N/A	N/A
LTE 2	QPSK20M	Rear Face	18700	2.03	1.98	1.03	N/A	N/A	N/A	N/A
LTE 4	QPSK20M	Rear Face	20300	2	1.95	1.03	N/A	N/A	N/A	N/A
LTE 7	QPSK20M	Rear Face	21100	3.59	3.51	1.02	N/A	N/A	N/A	N/A

4.7.7 Simultaneous Multi-band Transmission Evaluation

<Possibilities of Simultaneous Transmission>

The simultaneous transmission possibilities for this device are listed as below.

Simultaneous TX Combination	Capable Transmit Configurations	Head Exposure Condition	Body Exposure Condition	Hotspot Exposure Condition
1	WWAN + WLAN 2.4G	Yes	Yes	Yes
2	WWAN + WLAN 5G	Yes	Yes	Yes
3	WWAN + BT	Yes	Yes	Yes

Note :

1. The WLAN 2.4G and WLAN 5G cannot transmit simultaneously.
2. The WLAN and Bluetooth cannot transmit simultaneously.

<SAR Summation Analysis>

Simultaneous transmission SAR test exclusion is determined for each operating configuration and exposure condition according to the reported standalone SAR of each applicable simultaneous transmitting antenna. When the sum of SAR_{1g} of all simultaneously transmitting antennas in an operating mode and exposure condition combination is within the SAR limit (SAR_{1g} 1.6 W/kg), the simultaneous transmission SAR is not required. When the sum of SAR_{1g} is greater than the SAR limit (SAR_{1g} 1.6 W/kg), SAR test exclusion is determined by the SPLSR.

Refer to Appendix G

SAR Test Report

<SAR to Peak Location Separation Ratio Analysis>

The simultaneous transmitting antennas in each operating mode and exposure condition combination are considered one pair at a time to determine the SPLSR. When SAR is measured for both antennas in the pair, the peak location separation distance is computed by the following formula.

$$\text{Peak Location Separation Distance} = \sqrt{(x_1 - x_2)^2 + (y_1 - y_2)^2 + (z_1 - z_2)^2}$$

Where (x_1, y_1, z_1) and (x_2, y_2, z_2) are the coordinates of the extrapolated peak SAR locations in the area or zoom scans.

When standalone test exclusion applies, SAR is estimated; the peak location is assumed to be at the feed-point or geometric center of the antenna. Due to curvatures on the SAM phantom, when SAR is estimated for one of the antennas in an antenna pair, the measured peak SAR location will be translated onto the test device to determine the peak location separation for the antenna pair.

The SPLSR is determined by the following formula.

$$\text{SPLSR} = \frac{(\text{SAR}_1 + \text{SAR}_2)^{1.5}}{R_i}$$

Where SAR_1 and SAR_2 are the highest reported or estimated SAR for each antenna in the pair, and R_i is the separation distance between the peak SAR locations for the antenna pair in mm.

When the SPLSR is ≤ 0.04 , the simultaneous transmission SAR is not required. Otherwise, the enlarged zoom scan and volume scan post-processing procedures will be performed.

Refer to Appendix H

Test Engineer : Mars Chang, and Chienlun Huang

5. Calibration of Test Equipment

Equipment	Manufacturer	Model	SN	Cal. Date	Cal. Interval
System Validation Dipole	SPEAG	D750V3	1013	Aug. 23, 2019	1 Year
System Validation Dipole	SPEAG	D835V2	4d121	Aug. 23, 2019	1 Year
System Validation Dipole	SPEAG	D1750V2	1055	Aug. 23, 2019	1 Year
System Validation Dipole	SPEAG	D1750V2	1111	Apr. 29, 2020	1 Year
System Validation Dipole	SPEAG	D1900V2	5d036	Jan. 21, 2020	1 Year
System Validation Dipole	SPEAG	D2450V2	737	Aug. 13, 2020	1 Year
System Validation Dipole	SPEAG	D2450V2	903	Oct. 15, 2019	1 Year
System Validation Dipole	SPEAG	D2600V2	1020	Aug. 26, 2019	1 Year
System Validation Dipole	SPEAG	D2600V2	1077	Apr. 26, 2020	1 Year
System Validation Dipole	SPEAG	D5GHzV2	1019	Mar. 13, 2020	1 Year
Dosimetric E-Field Probe	SPEAG	EX3DV4	3820	Jun. 25, 2020	1 Year
Dosimetric E-Field Probe	SPEAG	EX3DV4	3971	Jan. 27, 2020	1 Year
Dosimetric E-Field Probe	SPEAG	EX3DV4	3650	Mar. 25, 2020	1 Year
Dosimetric E-Field Probe	SPEAG	EX3DV4	7472	Aug. 30, 2019	1 Year
Dosimetric E-Field Probe	SPEAG	EX3DV4	7472	Aug. 24, 2020	1 Year
Dosimetric E-Field Probe	SPEAG	EX3DV4	7537	May. 29, 2020	1 Year
Data Acquisition Electronics	SPEAG	DAE3	579	Aug. 12, 2020	1 Year
Data Acquisition Electronics	SPEAG	DAE4	393	Apr. 30, 2020	1 Year
Data Acquisition Electronics	SPEAG	DAE4	1277	Jan. 24, 2020	1 Year
Data Acquisition Electronics	SPEAG	DAE4	861	May. 27, 2020	1 Year
Data Acquisition Electronics	SPEAG	DAE4	917	Dec. 17, 2019	1 Year
Data Acquisition Electronics	SPEAG	DAE4	1585	Jun. 07, 2019	1 Year
Data Acquisition Electronics	SPEAG	DAE4	1585	May. 28, 2020	1 Year
Wireless Communication Test Set	Agilent	E5515C	MY50266628	Dec. 13, 2019	1 Year
Radio Communication Analyzer	Anritsu	MT8820C	6201300638	Jun. 27, 2019	1 Year
Spectrum Analyzer	Anritsu	MS2720T	1513085	May. 30, 2019	1 Year
Spectrum Analyzer	R&S	FSL6	102006	Mar. 26, 2020	1 Year
Universal Wireless Test Set	Anritsu	MT8870A/MU8 87000A	6201699387	Oct. 07, 2019	1 Year
Thermometer	YFE	YF-160A	120702365	Aug. 06, 2019	1 Year
Thermometer	YFE	YF-160A	150601219	Apr. 21, 2020	1 Year
Dielectric Assessment Kit	SPEAG	DAKS-3.5	1092	May. 07, 2019	1 Year
Dielectric Assessment Kit	SPEAG	DAKS-3.5	1092	May. 26, 2020	1 Year
Powersource1	SPEAG	SE_UMS_160 BA	4010	Aug. 21, 2019	1 Year
Powersource1	SPEAG	SE_UMS_160 BA	4010	Aug. 13, 2020	1 Year

6. Measurement Uncertainty

Source of Uncertainty	Uncertainty (± %)	Probability Distribution	Divisor	Ci (1g)	Ci (10g)	Standard Uncertainty (± %, 1g)	Standard Uncertainty (± %, 10g)	Vi
Measurement System								
Probe Calibration	6.0	Normal	1	1	1	6.0	6.0	∞
Axial Isotropy	4.7	Rectangular	√3	√0.5	√0.5	1.9	1.9	∞
Hemispherical Isotropy	9.6	Rectangular	√3	√0.5	√0.5	3.9	3.9	∞
Boundary Effect	1.0	Rectangular	√3	1	1	0.6	0.6	∞
Linearity	4.7	Rectangular	√3	1	1	2.7	2.7	∞
Detection Limits	0.25	Rectangular	√3	1	1	0.14	0.14	∞
Probe Modulation Response	4.8	Rectangular	√3	1	1	2.8	2.8	∞
Readout Electronics	0.3	Normal	1	1	1	0.3	0.3	∞
Response Time	0.0	Rectangular	√3	1	1	0.0	0.0	∞
Integration Time	1.7	Rectangular	√3	1	1	1.0	1.0	∞
RF Ambient Conditions – Noise	3.0	Rectangular	√3	1	1	1.7	1.7	∞
RF Ambient Conditions – Reflections	3.0	Rectangular	√3	1	1	1.7	1.7	∞
Probe Positioner Mechanical Tolerance	0.02	Rectangular	√3	1	1	0.01	0.01	∞
Probe Positioning with Respect to Phantom	0.4	Rectangular	√3	1	1	0.2	0.2	∞
Post-processing	2.0	Rectangular	√3	1	1	1.2	1.2	∞
Test Sample Related								
Test Sample Positioning	2.82 / 1.60	Normal	1	1	1	2.8	1.6	35
Device Holder Uncertainty	2.55 / 2.76	Normal	1	1	1	2.6	2.8	7
Power Drift of Measurement	5.0	Rectangular	√3	1	1	2.9	2.9	∞
PowerScaling	0.0	Rectangular	√3	1	1	0.0	0.0	∞
Phantom and Setup								
Phantom Uncertainty (Shape and Thickness Tolerances)	5.7	Rectangular	√3	1	1	3.3	3.3	∞
Liquid Conductivity (Temperature Uncertainty)	2.58	Rectangular	√3	0.78	0.71	1.2	1.1	∞
Liquid Conductivity (Measured)	2.95	Normal	1	0.78	0.71	2.3	2.1	61
Liquid Permittivity (Temperature Uncertainty)	1.97	Rectangular	√3	0.23	0.26	0.3	0.3	∞
Liquid Permittivity (Measured)	3.04	Normal	1	0.23	0.26	0.7	0.8	47
Combined Standard Uncertainty						± 10.9 %	± 10.7 %	
Expanded Uncertainty (K=2)						± 21.8 %	± 21.4 %	

Head SAR Uncertainty Budget for Frequency Range of 300 MHz to 3 GHz

SAR Test Report

Source of Uncertainty	Uncertainty (± %)	Probability Distribution	Divisor	Ci (1g)	Ci (10g)	Standard Uncertainty (± %, 1g)	Standard Uncertainty (± %, 10g)	Vi
Measurement System								
Probe Calibration	6.55	Normal	1	1	1	6.55	6.55	∞
Axial Isotropy	4.7	Rectangular	√3	0.7	0.7	1.9	1.9	∞
Hemispherical Isotropy	9.6	Rectangular	√3	0.7	0.7	3.9	3.9	∞
Boundary Effect	2.0	Rectangular	√3	1	1	1.2	1.2	∞
Linearity	4.7	Rectangular	√3	1	1	2.7	2.7	∞
Detection Limits	0.25	Rectangular	√3	1	1	0.14	0.14	∞
Probe Modulation Response	4.8	Rectangular	√3	1	1	2.8	2.8	∞
Readout Electronics	0.3	Normal	1	1	1	0.3	0.3	∞
Response Time	0.0	Rectangular	√3	1	1	0.0	0.0	∞
Integration Time	1.7	Rectangular	√3	1	1	1.0	1.0	∞
RF Ambient Conditions – Noise	3.0	Rectangular	√3	1	1	1.7	1.7	∞
RF Ambient Conditions – Reflections	3.0	Rectangular	√3	1	1	1.7	1.7	∞
Probe Positioner Mechanical Tolerance	0.04	Rectangular	√3	1	1	0.02	0.02	∞
Probe Positioning with Respect to Phantom	0.8	Rectangular	√3	1	1	0.5	0.5	∞
Post-processing	4.0	Rectangular	√3	1	1	2.3	2.3	∞
Test Sample Related								
Test Sample Positioning	2.82 / 1.60	Normal	1	1	1	2.8	1.6	35
Device Holder Uncertainty	2.55 / 2.76	Normal	1	1	1	2.6	2.8	7
Power Drift of Measurement	5.0	Rectangular	√3	1	1	2.9	2.9	∞
PowerScaling	0.0	Rectangular	√3	1	1	0.0	0.0	∞
Phantom and Setup								
Phantom Uncertainty (Shape and Thickness Tolerances)	6.2	Rectangular	√3	1	1	3.6	3.6	∞
Liquid Conductivity (Temperature Uncertainty)	2.58	Rectangular	√3	0.78	0.71	1.2	1.1	∞
Liquid Conductivity (Measured)	2.95	Normal	1	0.78	0.71	2.3	2.1	61
Liquid Permittivity (Temperature Uncertainty)	1.97	Rectangular	√3	0.23	0.26	0.3	0.3	∞
Liquid Permittivity (Measured)	3.04	Normal	1	0.23	0.26	0.7	0.8	47
Combined Standard Uncertainty						± 11.6 %	± 11.3 %	
Expanded Uncertainty (K=2)						± 23.2 %	± 22.6 %	

Head SAR Uncertainty Budget for Frequency Range of 3 GHz to 6 GHz

SAR Test Report

Source of Uncertainty	Uncertainty (± %)	Probability Distribution	Divisor	Ci (1g)	Ci (10g)	Standard Uncertainty (± %, 1g)	Standard Uncertainty (± %, 10g)	Vi
Measurement System								
Probe Calibration	6.0	Normal	1	1	1	6.0	6.0	∞
Axial Isotropy	4.7	Rectangular	√3	√0.5	√0.5	1.9	1.9	∞
Hemispherical Isotropy	9.6	Rectangular	√3	√0.5	√0.5	3.9	3.9	∞
Boundary Effect	1.0	Rectangular	√3	1	1	0.6	0.6	∞
Linearity	4.7	Rectangular	√3	1	1	2.7	2.7	∞
Detection Limits	0.25	Rectangular	√3	1	1	0.14	0.14	∞
Probe Modulation Response	4.8	Rectangular	√3	1	1	2.8	2.8	∞
Readout Electronics	0.3	Normal	1	1	1	0.3	0.3	∞
Response Time	0.0	Rectangular	√3	1	1	0.0	0.0	∞
Integration Time	1.7	Rectangular	√3	1	1	1.0	1.0	∞
RF Ambient Conditions – Noise	3.0	Rectangular	√3	1	1	1.7	1.7	∞
RF Ambient Conditions – Reflections	3.0	Rectangular	√3	1	1	1.7	1.7	∞
Probe Positioner Mechanical Tolerance	0.02	Rectangular	√3	1	1	0.01	0.01	∞
Probe Positioning with Respect to Phantom	0.4	Rectangular	√3	1	1	0.2	0.2	∞
Post-processing	2.0	Rectangular	√3	1	1	1.2	1.2	∞
Test Sample Related								
Test Sample Positioning	3.68 / 1.73	Normal	1	1	1	3.7	1.7	29
Device Holder Uncertainty	2.55 / 2.76	Normal	1	1	1	2.6	2.8	7
Power Drift of Measurement	5.0	Rectangular	√3	1	1	2.9	2.9	∞
PowerScaling	0.0	Rectangular	√3	1	1	0.0	0.0	∞
Phantom and Setup								
Phantom Uncertainty (Shape and Thickness Tolerances)	7.2	Rectangular	√3	1	1	4.2	4.2	∞
Liquid Conductivity (Temperature Uncertainty)	2.58	Rectangular	√3	0.78	0.71	1.2	1.1	∞
Liquid Conductivity (Measured)	2.95	Normal	1	0.78	0.71	2.3	2.1	61
Liquid Permittivity (Temperature Uncertainty)	1.97	Rectangular	√3	0.23	0.26	0.3	0.3	∞
Liquid Permittivity (Measured)	3.04	Normal	1	0.23	0.26	0.7	0.8	47
Combined Standard Uncertainty						± 11.5 %	± 11.0 %	
Expanded Uncertainty (K=2)						± 23.0 %	± 22.0 %	

Body SAR Uncertainty Budget for Frequency Range of 300 MHz to 3 GHz

SAR Test Report

Source of Uncertainty	Uncertainty (± %)	Probability Distribution	Divisor	Ci (1g)	Ci (10g)	Standard Uncertainty (± %, 1g)	Standard Uncertainty (± %, 10g)	Vi
Measurement System								
Probe Calibration	6.55	Normal	1	1	1	6.55	6.55	∞
Axial Isotropy	4.7	Rectangular	√3	0.7	0.7	1.9	1.9	∞
Hemispherical Isotropy	9.6	Rectangular	√3	0.7	0.7	3.9	3.9	∞
Boundary Effect	2.0	Rectangular	√3	1	1	1.2	1.2	∞
Linearity	4.7	Rectangular	√3	1	1	2.7	2.7	∞
Detection Limits	0.25	Rectangular	√3	1	1	0.14	0.14	∞
Probe Modulation Response	4.8	Rectangular	√3	1	1	2.8	2.8	∞
Readout Electronics	0.3	Normal	1	1	1	0.3	0.3	∞
Response Time	0.0	Rectangular	√3	1	1	0.0	0.0	∞
Integration Time	1.7	Rectangular	√3	1	1	1.0	1.0	∞
RF Ambient Conditions – Noise	3.0	Rectangular	√3	1	1	1.7	1.7	∞
RF Ambient Conditions – Reflections	3.0	Rectangular	√3	1	1	1.7	1.7	∞
Probe Positioner Mechanical Tolerance	0.04	Rectangular	√3	1	1	0.02	0.02	∞
Probe Positioning with Respect to Phantom	0.8	Rectangular	√3	1	1	0.5	0.5	∞
Post-processing	4.0	Rectangular	√3	1	1	2.3	2.3	∞
Test Sample Related								
Test Sample Positioning	3.68 / 1.73	Normal	1	1	1	3.7	1.7	29
Device Holder Uncertainty	2.55 / 2.76	Normal	1	1	1	2.6	2.8	7
Power Drift of Measurement	5.0	Rectangular	√3	1	1	2.9	2.9	∞
PowerScaling	0.0	Rectangular	√3	1	1	0.0	0.0	∞
Phantom and Setup								
Phantom Uncertainty (Shape and Thickness Tolerances)	7.6	Rectangular	√3	1	1	4.4	4.4	∞
Liquid Conductivity (Temperature Uncertainty)	2.58	Rectangular	√3	0.78	0.71	1.2	1.1	∞
Liquid Conductivity (Measured)	2.95	Normal	1	0.78	0.71	2.3	2.1	61
Liquid Permittivity (Temperature Uncertainty)	1.97	Rectangular	√3	0.23	0.26	0.3	0.3	∞
Liquid Permittivity (Measured)	3.04	Normal	1	0.23	0.26	0.7	0.8	47
Combined Standard Uncertainty						± 12.1 %	± 11.6 %	
Expanded Uncertainty (K=2)						± 24.2 %	± 23.2 %	

Body SAR Uncertainty Budget for Frequency Range of 3 GHz to 6 GHz

7. Information of the Testing Laboratories

We, Bureau Veritas Consumer Products Services (H.K.) Ltd., Taoyuan Branch, were founded in 1988 to provide our best service in EMC, Radio, Telecom and Safety consultation. Our laboratories are accredited and approved according to ISO/IEC 17025.

If you have any comments, please feel free to contact us at the following:

Taiwan Huaya Lab:

Add: No. 19, Huaya 2nd Rd., Guishan Dist., Taoyuan City 333, Taiwan

Tel: +886-(0)3-318-3232

Fax: +886-(0)3-211-5834

Taiwan Linkou Lab:

Add: No. 47-2, Baodoucuokeng, Linkou Dist., New Taipei City 244, Taiwan

Tel: +886-(0)2-2605-2180

Fax: +886-(0)2-2605-2943

Taiwan Hsinchu Lab1:

Add: E-2, No. 1, Lixing 1st Rd., East Dist., Hsinchu City 300, Taiwan

Tel: +886-(0)3-666-8565

Fax: +886-(0)3-666-8323

Taiwan Hsinchu Lab2:

Add: No. 49, Ln. 206, Wende Rd., Qionglin Township, Hsinchu County 307, Taiwan

Tel: +886-(0)3-512-0595

Fax: +886-(0)3-512-0568

Taiwan Xindian Lab:

Add: B2F., No. 215, Sec. 3, Beixin Rd., Xindian Dist., New Taipei City 231, Taiwan

Tel: +886-(0)2-8914-5882

Fax: +886-(0)2-8914-5840

Email: service.adt@tw.bureauveritas.com

Web Site: <https://ee.bureauveritas.com.tw/BVInternet/Default>

The road map of all our labs can be found in our web site also.

---END---

Appendix A. SAR Plots of System Verification

The plots for system verification with largest deviation for each SAR system combination are shown as follows.

System Check_H750_200707

DUT: Dipole 750 MHz; Type: D750V3; SN: 1013

Communication System: UID 0, CW; Frequency: 750 MHz; Duty Cycle: 1:1

Medium: H06T09N1_0707 Medium parameters used: $f = 750$ MHz; $\sigma = 0.903$ S/m; $\epsilon_r = 42.293$; $\rho = 1000$ kg/m³

Ambient Temperature : 23.8 °C ; Liquid Temperature : 23.5 °C

DASY5 Configuration:

- Probe: EX3DV4 - SN7472; ConvF(10.49, 10.49, 10.49) @ 750 MHz; Calibrated: 2019/08/30
- Sensor-Surface: 1.4mm (Mechanical Surface Detection)
- Electronics: DAE3 Sn579; Calibrated: 2019/08/27
- Phantom: Twin SAM Phantom_1653; Type: QD000P40CD;
- Measurement SW: DASY52, Version 52.10 (4); SEMCAD X Version 14.6.14 (7483)

Pin=50mW/Area Scan (61x81x1): Interpolated grid: dx=1.500 mm, dy=1.500 mm

Maximum value of SAR (interpolated) = 0.517 W/kg

Pin=50mW/Zoom Scan (5x5x7)/Cube 0: Measurement grid: dx=8mm, dy=8mm, dz=5mm

Reference Value = 24.63 V/m; Power Drift = 0.05 dB

Peak SAR (extrapolated) = 0.572 W/kg

SAR(1 g) = 0.393 W/kg; SAR(10 g) = 0.266 W/kg (SAR corrected for target medium)

Maximum value of SAR (measured) = 0.516 W/kg

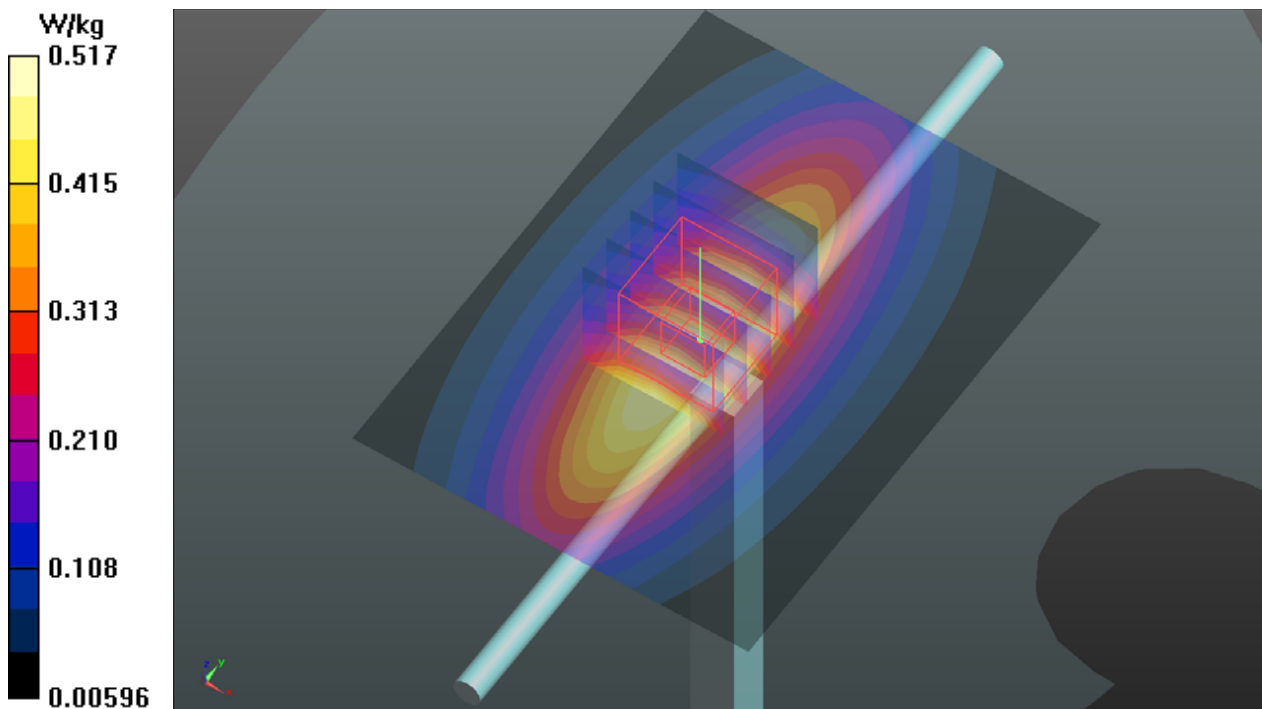

System Check_H835_200613

DUT: Dipole 835 MHz; Type: D835V2; SN: 4d121

Communication System: UID 0, CW; Frequency: 835 MHz; Duty Cycle: 1:1
Medium: H07T10N1_0613 Medium parameters used: $f = 835$ MHz; $\sigma = 0.914$ S/m; $\epsilon_r = 43.02$; $\rho = 1000$ kg/m³
Ambient Temperature : 23.7 °C ; Liquid Temperature : 23.5 °C

DASY5 Configuration:

- Probe: EX3DV4 - SN3650; ConvF(9.69, 9.69, 9.69) @ 835 MHz; Calibrated: 2020/03/25
- Sensor-Surface: 1.4mm (Mechanical Surface Detection)
- Electronics: DAE4 Sn861; Calibrated: 2020/05/27
- Phantom: Twin SAM Phantom_1823; Type: QD 000 P40 CD;
- Measurement SW: DASY52, Version 52.10 (4); SEMCAD X Version 14.6.14 (7483)

Pin=50mW/Area Scan (61x61x1): Interpolated grid: dx=1.500 mm, dy=1.500 mm
Maximum value of SAR (interpolated) = 0.602 W/kg

Pin=50mW/Zoom Scan (5x5x7)/Cube 0: Measurement grid: dx=8mm, dy=8mm, dz=5mm
Reference Value = 26.68 V/m; Power Drift = 0.06 dB
Peak SAR (extrapolated) = 0.683 W/kg
SAR(1 g) = 0.463 W/kg; SAR(10 g) = 0.302 W/kg (SAR corrected for target medium)
Maximum value of SAR (measured) = 0.614 W/kg

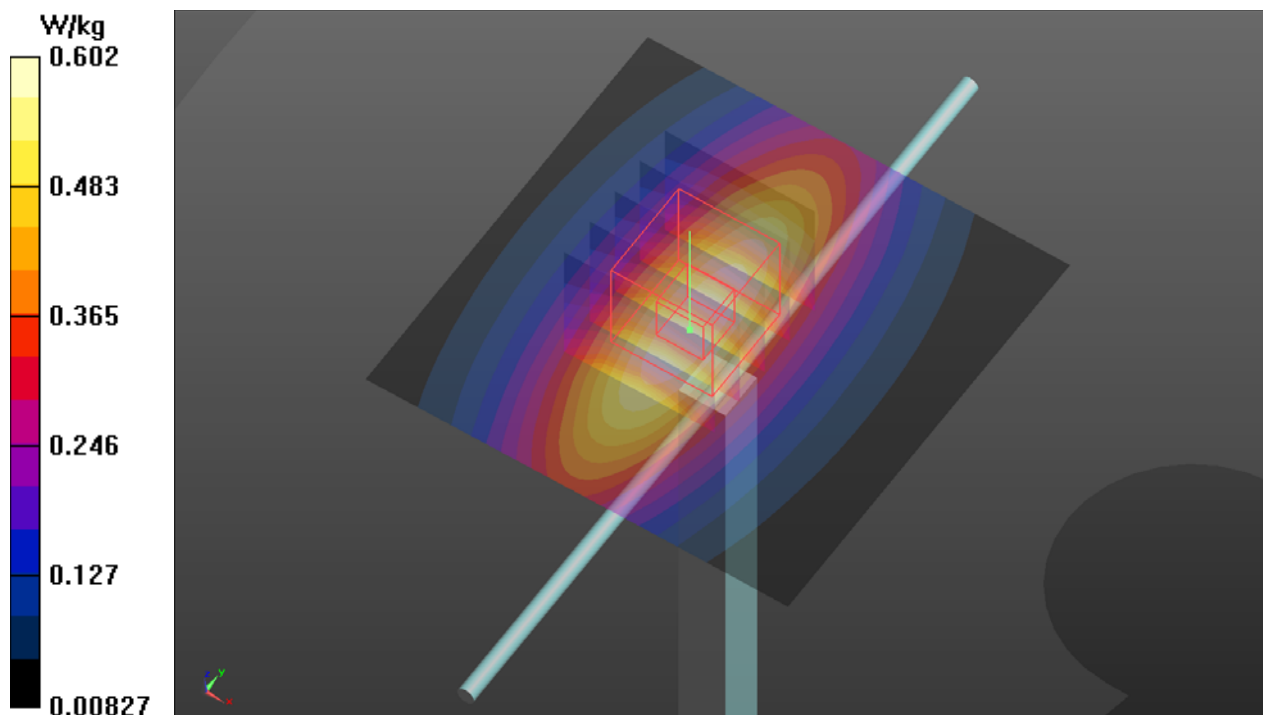

System Check_H1750_200707

DUT: Dipole 1750 MHz; Type: D1750V2; SN: 1055

Communication System: UID 0, CW; Frequency: 1750 MHz; Duty Cycle: 1:1

Medium: H16T20N1_0707 Medium parameters used: $f = 1750$ MHz; $\sigma = 1.325$ S/m; $\epsilon_r = 38.809$; $\rho = 1000$ kg/m³

Ambient Temperature : 23.8 °C ; Liquid Temperature : 23.5 °C

DASY5 Configuration:

- Probe: EX3DV4 - SN7472; ConvF(8.68, 8.68, 8.68) @ 1750 MHz; Calibrated: 2019/08/30
- Sensor-Surface: 1.4mm (Mechanical Surface Detection)
- Electronics: DAE3 Sn579; Calibrated: 2019/08/27
- Phantom: Twin SAM Phantom_1653; Type: QD000P40CD;
- Measurement SW: DASY52, Version 52.10 (4); SEMCAD X Version 14.6.14 (7483)

Pin=50mW/Area Scan (61x61x1): Interpolated grid: dx=1.500 mm, dy=1.500 mm

Maximum value of SAR (interpolated) = 2.65 W/kg

Pin=50mW/Zoom Scan (5x5x7)/Cube 0: Measurement grid: dx=8mm, dy=8mm, dz=5mm

Reference Value = 45.14 V/m; Power Drift = 0.07 dB

Peak SAR (extrapolated) = 3.10 W/kg

SAR(1 g) = 1.77 W/kg; SAR(10 g) = 0.964 W/kg (SAR corrected for target medium)

Maximum value of SAR (measured) = 2.62 W/kg

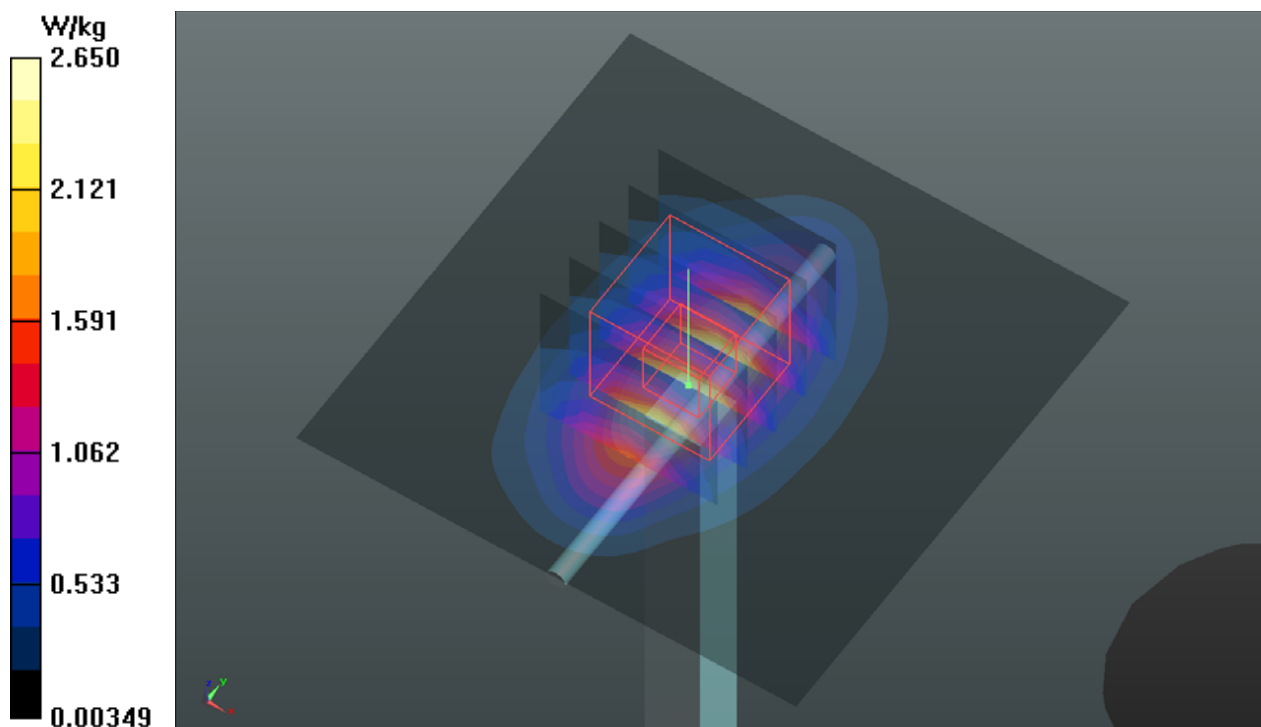

System Check_H1900_200707

DUT: Dipole 1900 MHz; Type: D1900V2; SN: 5d036

Communication System: UID 0, CW; Frequency: 1900 MHz; Duty Cycle: 1:1
Medium: H16T20N1_0707 Medium parameters used: $f = 1900$ MHz; $\sigma = 1.46$ S/m; $\epsilon_r = 38.175$; $\rho = 1000$ kg/m³
Ambient Temperature : 23.8 °C ; Liquid Temperature : 23.5 °C

DASY5 Configuration:

- Probe: EX3DV4 - SN7472; ConvF(8.34, 8.34, 8.34) @ 1900 MHz; Calibrated: 2019/08/30
- Sensor-Surface: 1.4mm (Mechanical Surface Detection)
- Electronics: DAE3 Sn579; Calibrated: 2019/08/27
- Phantom: Twin SAM Phantom_1653; Type: QD000P40CD;
- Measurement SW: DASY52, Version 52.10 (4); SEMCAD X Version 14.6.14 (7483)

Pin=50mW/Area Scan (61x61x1): Interpolated grid: dx=1.500 mm, dy=1.500 mm
Maximum value of SAR (interpolated) = 3.05 W/kg

Pin=50mW/Zoom Scan (5x5x7)/Cube 0: Measurement grid: dx=8mm, dy=8mm, dz=5mm
Reference Value = 45.76 V/m; Power Drift = 0.15 dB
Peak SAR (extrapolated) = 3.61 W/kg
SAR(1 g) = 1.94 W/kg; SAR(10 g) = 1.04 W/kg (SAR corrected for target medium)
Maximum value of SAR (measured) = 3.05 W/kg

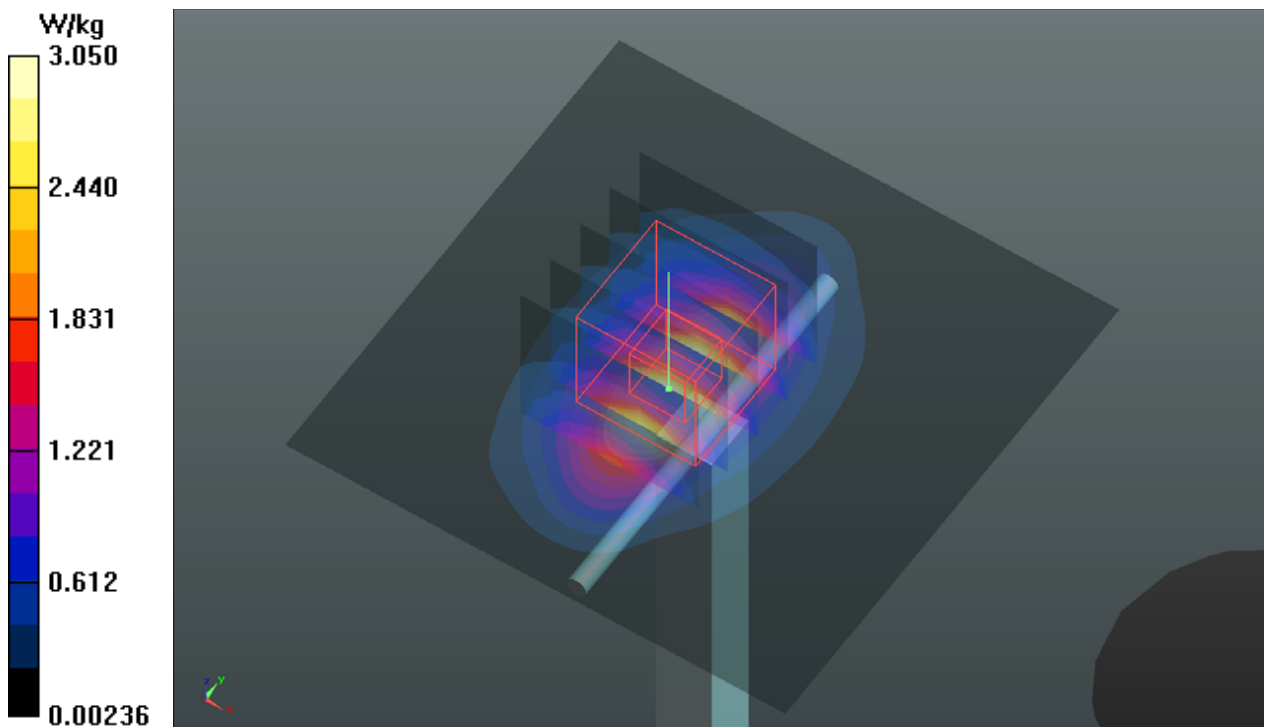

System Check_H2450_200721

DUT: Dipole 2450 MHz; Type: D2450V2; SN: 737

Communication System: UID 0, CW; Frequency: 2450 MHz; Duty Cycle: 1:1

Medium: H19T27N1_0721 Medium parameters used (interpolated): $f = 2450$ MHz; $\sigma = 1.878$ S/m; $\epsilon_r = 39.394$; $\rho = 1000$ kg/m³

Ambient Temperature : 23.5 °C ; Liquid Temperature : 23.1 °C

DASY5 Configuration:

- Probe: EX3DV4 - SN7537; ConvF(7.4, 7.4, 7.4) @ 2450 MHz; Calibrated: 2020/5/29
- Sensor-Surface: 1.4mm (Mechanical Surface Detection)
- Electronics: DAE4 Sn1585; Calibrated: 2020/5/28
- Phantom: SAM Phantom_1982; Type: QD 000 P41 Ax;
- Measurement SW: DASY52, Version 52.10 (4); SEMCAD X Version 14.6.14 (7483)

Pin=50mW/Area Scan (81x81x1): Interpolated grid: dx=1.200 mm, dy=1.200 mm
Maximum value of SAR (interpolated) = 3.12 W/kg

Pin=50mW/Zoom Scan (7x7x7)/Cube 0: Measurement grid: dx=5mm, dy=5mm, dz=5mm
Reference Value = 42.57 V/m; Power Drift = -0.07 dB
Peak SAR (extrapolated) = 3.78 W/kg
SAR(1 g) = 2.52 W/kg; SAR(10 g) = 0.940 W/kg (SAR corrected for target medium)
Maximum value of SAR (measured) = 3.14 W/kg

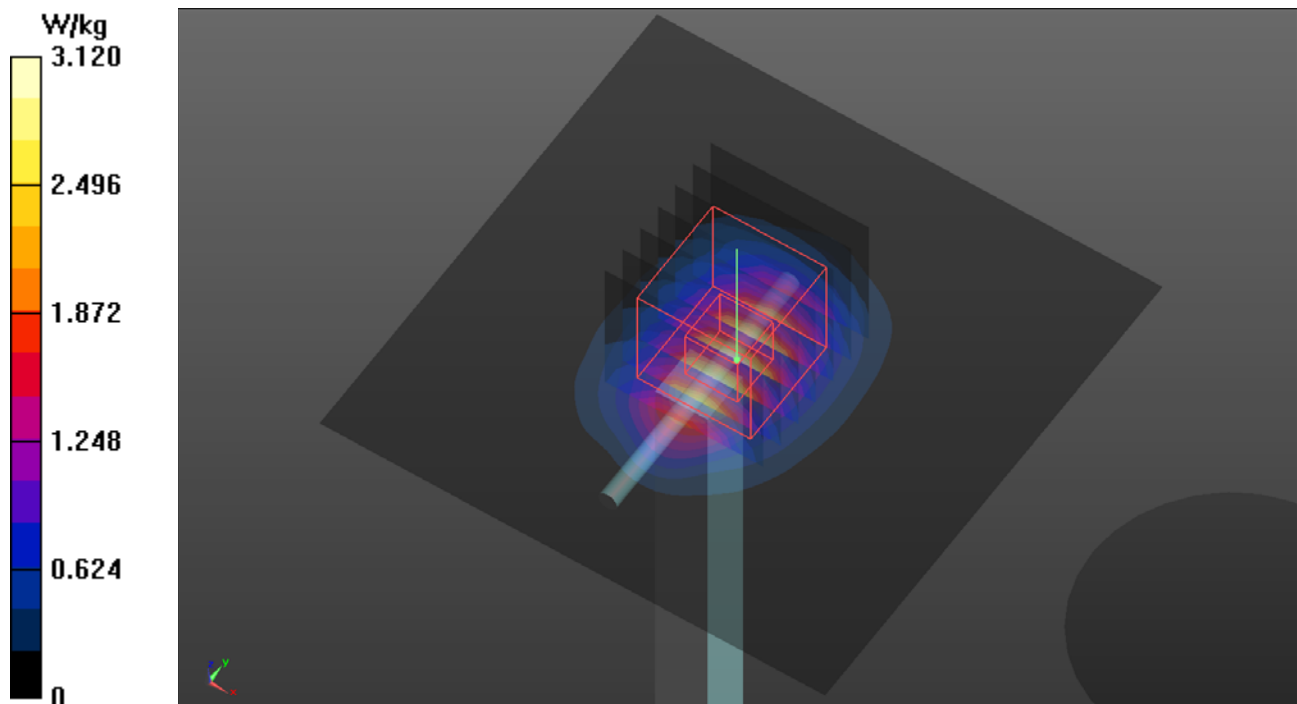

System Check_H2600_200707

DUT: Dipole 2600 MHz; Type: D2600V2; SN: 1020

Communication System: UID 0, CW; Frequency: 2600 MHz; Duty Cycle: 1:1
Medium: H19T27N1_0707 Medium parameters used: $f = 2600$ MHz; $\sigma = 2.042$ S/m; $\epsilon_r = 37.776$; $\rho = 1000$ kg/m³
Ambient Temperature : 23.8 °C ; Liquid Temperature : 23.5 °C

DASY5 Configuration:

- Probe: EX3DV4 - SN7472; ConvF(7.64, 7.64, 7.64) @ 2600 MHz; Calibrated: 2019/08/30
- Sensor-Surface: 1.4mm (Mechanical Surface Detection)
- Electronics: DAE3 Sn579; Calibrated: 2019/08/27
- Phantom: Twin SAM Phantom_1653; Type: QD000P40CD;
- Measurement SW: DASY52, Version 52.10 (4); SEMCAD X Version 14.6.14 (7483)

Pin=50mW/Area Scan (81x81x1): Interpolated grid: dx=1.200 mm, dy=1.200 mm
Maximum value of SAR (interpolated) = 4.54 W/kg

Pin=50mW/Zoom Scan (7x7x7)/Cube 0: Measurement grid: dx=5mm, dy=5mm, dz=5mm
Reference Value = 48.91 V/m; Power Drift = -0.01 dB
Peak SAR (extrapolated) = 5.57 W/kg
SAR(1 g) = 2.67 W/kg; SAR(10 g) = 1.24 W/kg (SAR corrected for target medium)
Maximum value of SAR (measured) = 4.55 W/kg

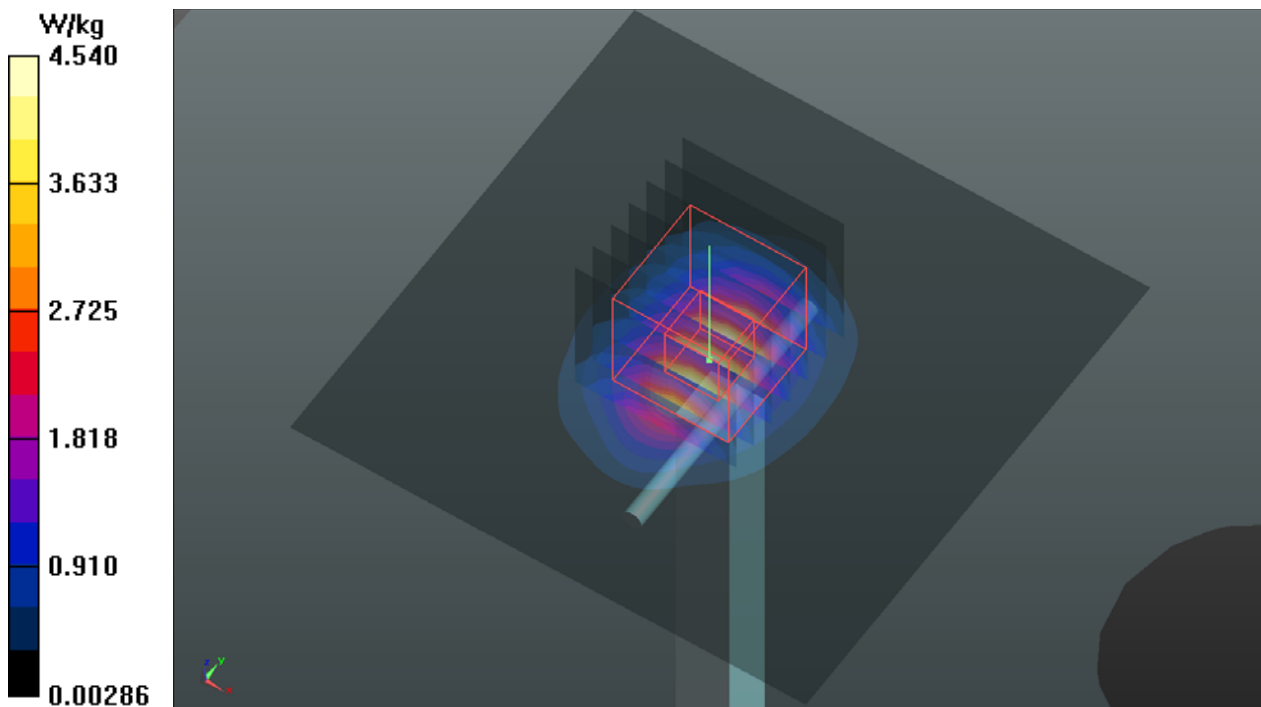

System Check_H5250_200720

DUT: Dipole 5 GHz; Type: D5GHzV2; SN: 1019

Communication System: UID 0, CW; Frequency: 5250 MHz; Duty Cycle: 1:1

Medium: H34T60N1_0720 Medium parameters used: $f = 5250$ MHz; $\sigma = 4.713$ S/m; $\epsilon_r = 36.255$; $\rho = 1000$ kg/m³

Ambient Temperature : 23.5 °C ; Liquid Temperature : 23.1 °C

DASY5 Configuration:

- Probe: EX3DV4 - SN7472; ConvF(5.67, 5.67, 5.67) @ 5250 MHz; Calibrated: 2019/08/30
- Sensor-Surface: 1.4mm (Mechanical Surface Detection)
- Electronics: DAE3 Sn579; Calibrated: 2019/08/27
- Phantom: Twin SAM Phantom_1653; Type: QD000P40CD;
- Measurement SW: DASY52, Version 52.10 (4); SEMCAD X Version 14.6.14 (7483)

Pin=50mW/Area Scan (91x91x1): Interpolated grid: dx=1.000 mm, dy=1.000 mm

Maximum value of SAR (interpolated) = 7.91 W/kg

Pin=50mW/Zoom Scan (7x7x7)/Cube 0: Measurement grid: dx=4mm, dy=4mm, dz=1.4mm

Reference Value = 46.02 V/m; Power Drift = -0.13 dB

Peak SAR (extrapolated) = 13.1 W/kg

SAR(1 g) = 3.72 W/kg; SAR(10 g) = 1.07 W/kg (SAR corrected for target medium)

Maximum value of SAR (measured) = 8.71 W/kg

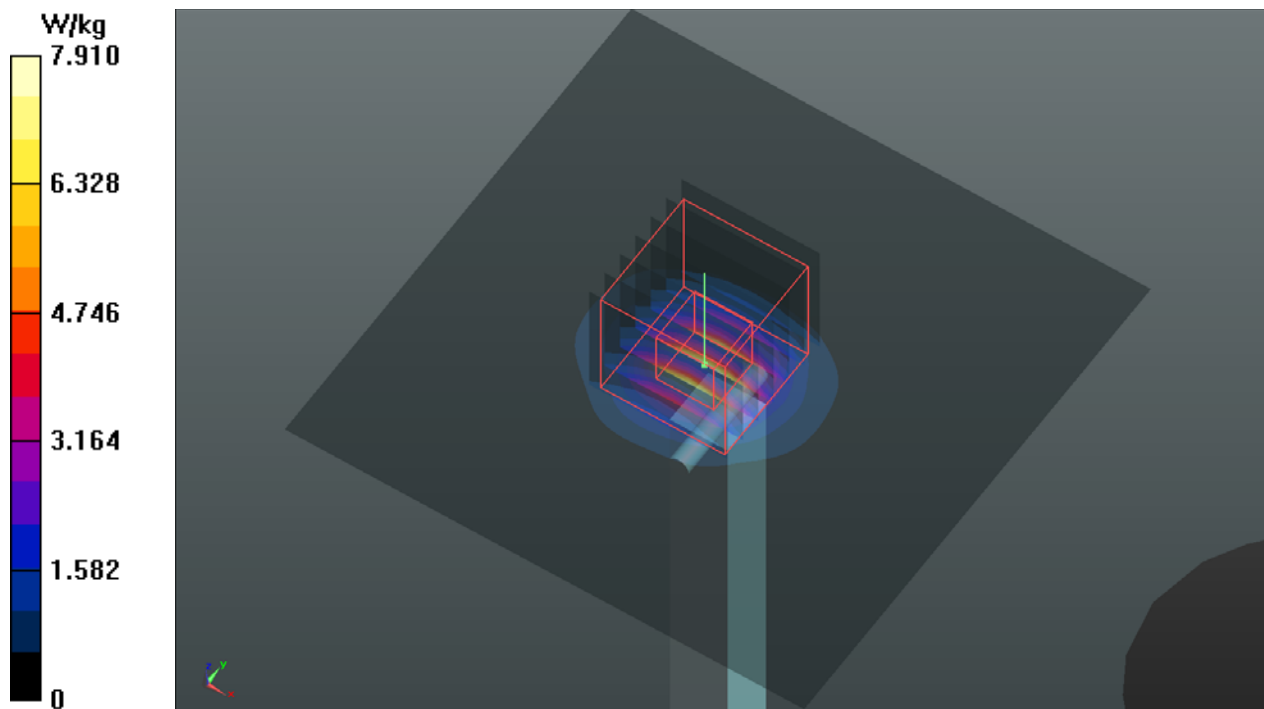

System Check_H5600_200720

DUT: Dipole 5 GHz; Type: D5GHzV2; SN: 1019

Communication System: UID 0, CW; Frequency: 5600 MHz; Duty Cycle: 1:1

Medium: H34T60N1_0720 Medium parameters used: $f = 5600$ MHz; $\sigma = 5.139$ S/m; $\epsilon_r = 35.632$; $\rho = 1000$ kg/m³

Ambient Temperature : 23.5 °C ; Liquid Temperature : 23.1 °C

DASY5 Configuration:

- Probe: EX3DV4 - SN7472; ConvF(5.1, 5.1, 5.1) @ 5600 MHz; Calibrated: 2019/08/30
- Sensor-Surface: 1.4mm (Mechanical Surface Detection)
- Electronics: DAE3 Sn579; Calibrated: 2019/08/27
- Phantom: Twin SAM Phantom_1653; Type: QD000P40CD;
- Measurement SW: DASY52, Version 52.10 (4); SEMCAD X Version 14.6.14 (7483)

Pin=50mW/Area Scan (91x91x1): Interpolated grid: dx=1.000 mm, dy=1.000 mm
Maximum value of SAR (interpolated) = 8.88 W/kg

Pin=50mW/Zoom Scan (7x7x7)/Cube 0: Measurement grid: dx=4mm, dy=4mm, dz=1.4mm
Reference Value = 46.22 V/m; Power Drift = -0.09 dB
Peak SAR (extrapolated) = 15.4 W/kg
SAR(1 g) = 3.85 W/kg; SAR(10 g) = 1.13 W/kg (SAR corrected for target medium)
Maximum value of SAR (measured) = 9.59 W/kg

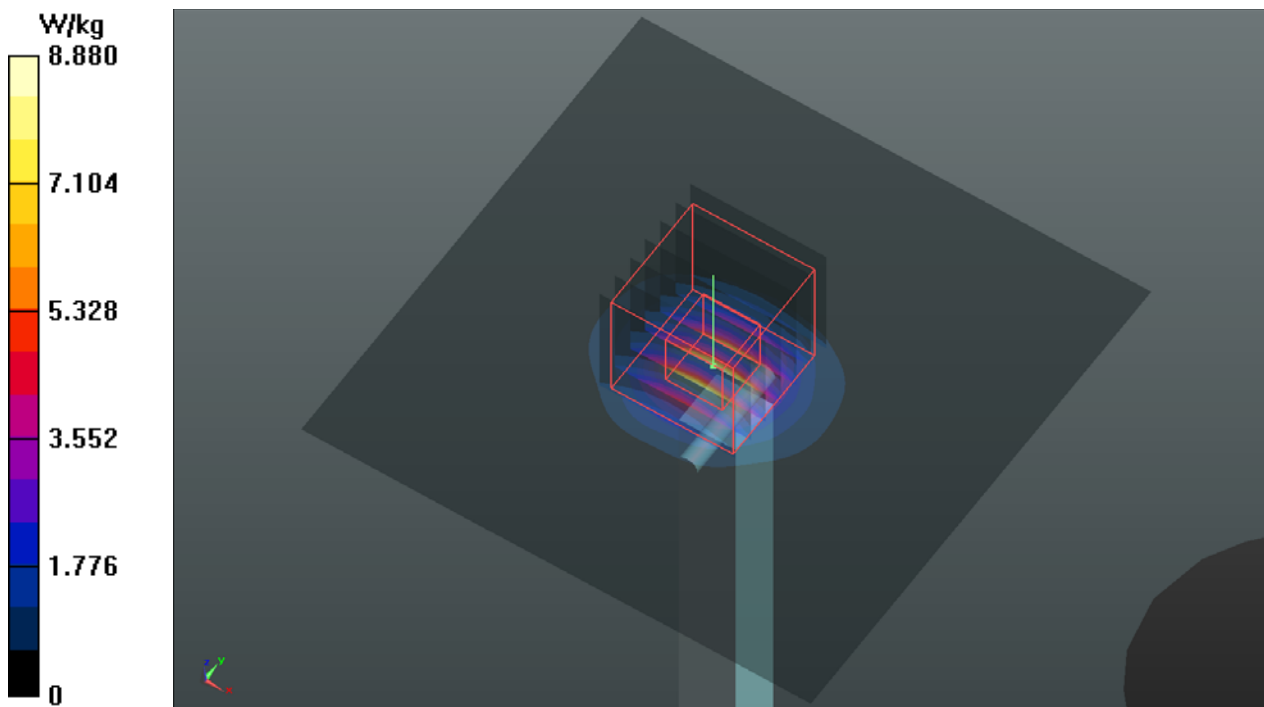

System Check_H5750_200720

DUT: Dipole 5 GHz; Type: D5GHzV2; SN: 1019

Communication System: UID 0, CW; Frequency: 5750 MHz; Duty Cycle: 1:1

Medium: H34T60N1_0720 Medium parameters used: $f = 5750$ MHz; $\sigma = 5.313$ S/m; $\epsilon_r = 35.352$; $\rho = 1000$ kg/m³

Ambient Temperature : 23.5 °C ; Liquid Temperature : 23.1 °C

DASY5 Configuration:

- Probe: EX3DV4 - SN7472; ConvF(5.23, 5.23, 5.23) @ 5750 MHz; Calibrated: 2019/08/30
- Sensor-Surface: 1.4mm (Mechanical Surface Detection)
- Electronics: DAE3 Sn579; Calibrated: 2019/08/27
- Phantom: Twin SAM Phantom_1653; Type: QD000P40CD;
- Measurement SW: DASY52, Version 52.10 (4); SEMCAD X Version 14.6.14 (7483)

Pin=50mW/Area Scan (91x91x1): Interpolated grid: dx=1.000 mm, dy=1.000 mm

Maximum value of SAR (interpolated) = 8.12 W/kg

Pin=50mW/Zoom Scan (7x7x7)/Cube 0: Measurement grid: dx=4mm, dy=4mm, dz=1.4mm

Reference Value = 43.81 V/m; Power Drift = -0.13 dB

Peak SAR (extrapolated) = 14.7 W/kg

SAR(1 g) = 3.71 W/kg; SAR(10 g) = 1.03 W/kg (SAR corrected for target medium)

Maximum value of SAR (measured) = 8.93 W/kg

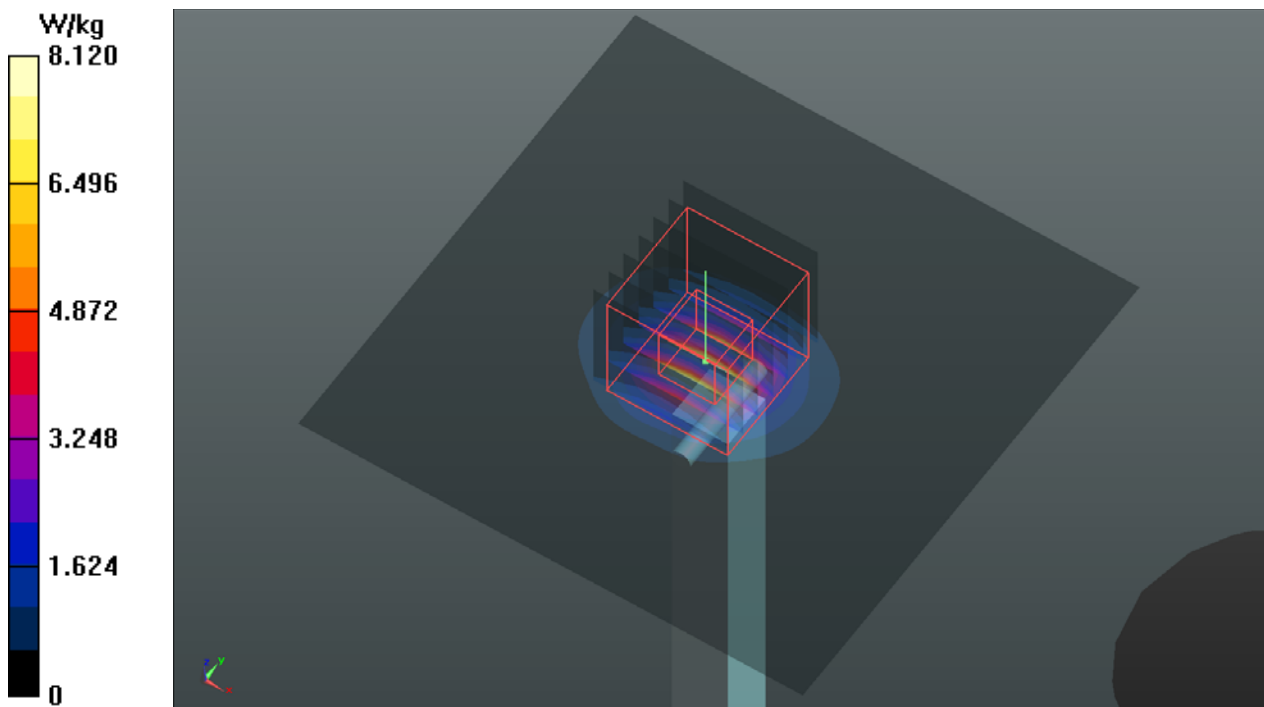

System Check_H1750_200616

DUT: Dipole 1750 MHz; Type: D1750V2; SN: 1055

Communication System: UID 0, CW; Frequency: 1750 MHz; Duty Cycle: 1:1

Medium: H16T20N1_0616 Medium parameters used: $f = 1750$ MHz; $\sigma = 1.325$ S/m; $\epsilon_r = 39.349$; $\rho = 1000$ kg/m³

Ambient Temperature : 23.2 °C ; Liquid Temperature : 23.1 °C

DASY5 Configuration:

- Probe: EX3DV4 - SN7472; ConvF(8.68, 8.68, 8.68) @ 1750 MHz; Calibrated: 2019/08/30
- Sensor-Surface: 1.4mm (Mechanical Surface Detection)
- Electronics: DAE3 Sn579; Calibrated: 2019/08/27
- Phantom: Twin SAM Phantom_1653; Type: QD000P40CD;
- Measurement SW: DASY52, Version 52.10 (4); SEMCAD X Version 14.6.14 (7483)

Pin=50mW/Area Scan (61x61x1): Interpolated grid: dx=1.500 mm, dy=1.500 mm

Maximum value of SAR (interpolated) = 2.79 W/kg

Pin=50mW/Zoom Scan (5x5x7)/Cube 0: Measurement grid: dx=8mm, dy=8mm, dz=5mm

Reference Value = 45.65 V/m; Power Drift = 0.18 dB

Peak SAR (extrapolated) = 3.29 W/kg

SAR(1 g) = 1.89 W/kg; SAR(10 g) = 1.03 W/kg (SAR corrected for target medium)

Maximum value of SAR (measured) = 2.75 W/kg

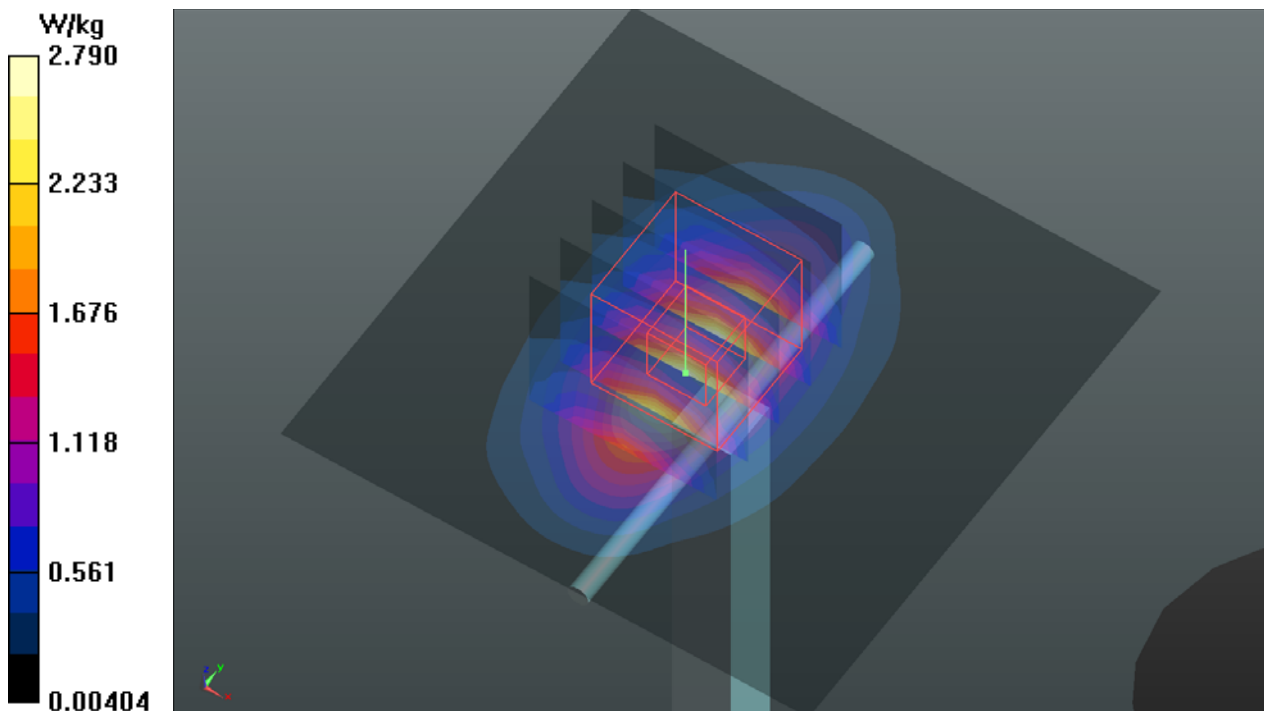

System Check_H1900_200616

DUT: Dipole 1900 MHz; Type: D1900V2; SN: 5d036

Communication System: UID 0, CW; Frequency: 1900 MHz; Duty Cycle: 1:1

Medium: H16T20N1_0616 Medium parameters used: $f = 1900$ MHz; $\sigma = 1.46$ S/m; $\epsilon_r = 38.759$; $\rho = 1000$ kg/m³

Ambient Temperature : 23.2 °C ; Liquid Temperature : 23.1 °C

DASY5 Configuration:

- Probe: EX3DV4 - SN7472; ConvF(8.34, 8.34, 8.34) @ 1900 MHz; Calibrated: 2019/08/30
- Sensor-Surface: 1.4mm (Mechanical Surface Detection)
- Electronics: DAE3 Sn579; Calibrated: 2019/08/27
- Phantom: Twin SAM Phantom_1653; Type: QD000P40CD;
- Measurement SW: DASY52, Version 52.10 (4); SEMCAD X Version 14.6.14 (7483)

Pin=50mW/Area Scan (61x61x1): Interpolated grid: dx=1.500 mm, dy=1.500 mm

Maximum value of SAR (interpolated) = 3.23 W/kg

Pin=50mW/Zoom Scan (5x5x7)/Cube 0: Measurement grid: dx=8mm, dy=8mm, dz=5mm

Reference Value = 47.89 V/m; Power Drift = 0.05 dB

Peak SAR (extrapolated) = 3.85 W/kg

SAR(1 g) = 2.07 W/kg; SAR(10 g) = 1.12 W/kg (SAR corrected for target medium)

Maximum value of SAR (measured) = 3.24 W/kg

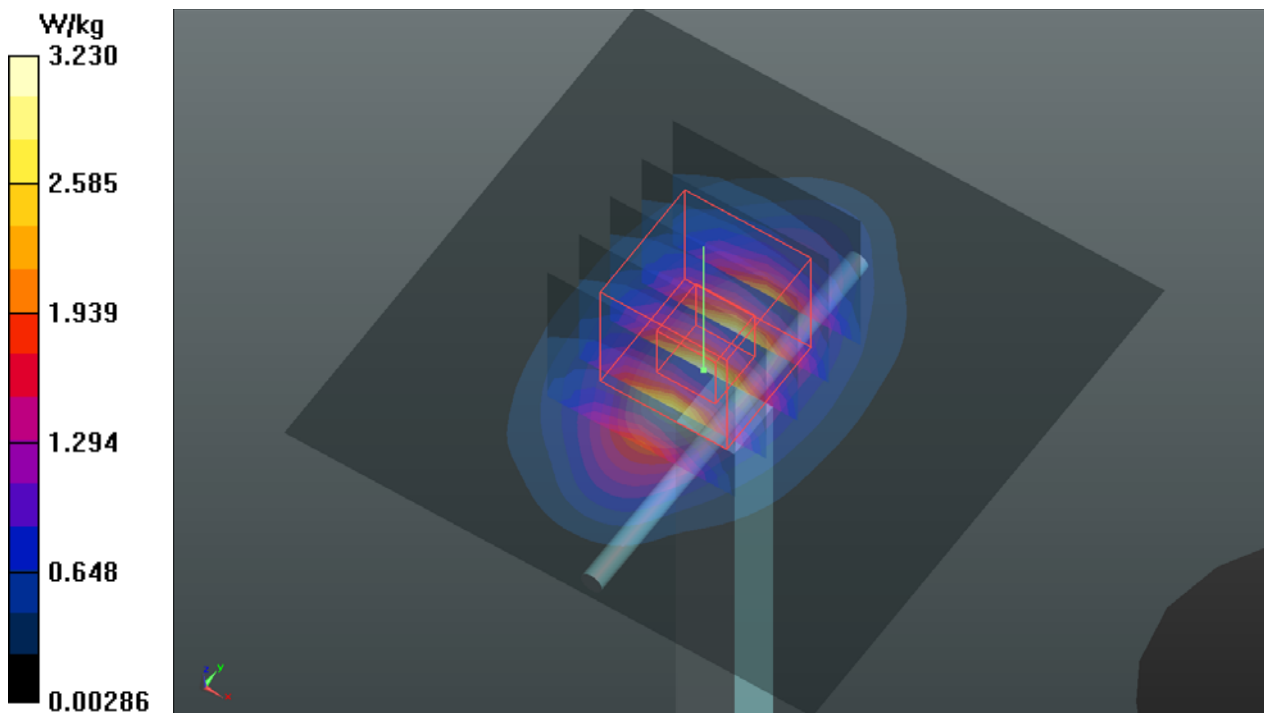

System Check_H2450_200909

DUT: Dipole 2450 MHz; Type: D2450V2; SN: 903

Communication System: UID 0, CW; Frequency: 2450 MHz; Duty Cycle: 1:1

Medium: H19T27N1_0909 Medium parameters used (interpolated): $f = 2450$ MHz; $\sigma = 1.878$ S/m; $\epsilon_r = 38.844$; $\rho = 1000$ kg/m³

Ambient Temperature : 23.7 °C ; Liquid Temperature : 23.1 °C

DASY5 Configuration:

- Probe: EX3DV4 - SN7472; ConvF(7.69, 7.69, 7.69) @ 2450 MHz; Calibrated: 2020/8/24
- Sensor-Surface: 1.4mm (Mechanical Surface Detection)
- Electronics: DAE3 Sn579; Calibrated: 2020/8/12
- Phantom: SAM Phantom_1982; Type: QD 000 P41 Ax;
- Measurement SW: DASY52, Version 52.10 (4); SEMCAD X Version 14.6.14 (7483)

Pin=50mW/Area Scan (81x81x1): Interpolated grid: dx=1.200 mm, dy=1.200 mm
Maximum value of SAR (interpolated) = 4.47 W/kg

Pin=50mW/Zoom Scan (7x7x7)/Cube 0: Measurement grid: dx=5mm, dy=5mm, dz=5mm
Reference Value = 50.68 V/m; Power Drift = -0.03 dB
Peak SAR (extrapolated) = 5.45 W/kg
SAR(1 g) = 2.61 W/kg; SAR(10 g) = 1.24 W/kg (SAR corrected for target medium)
Maximum value of SAR (measured) = 4.46 W/kg

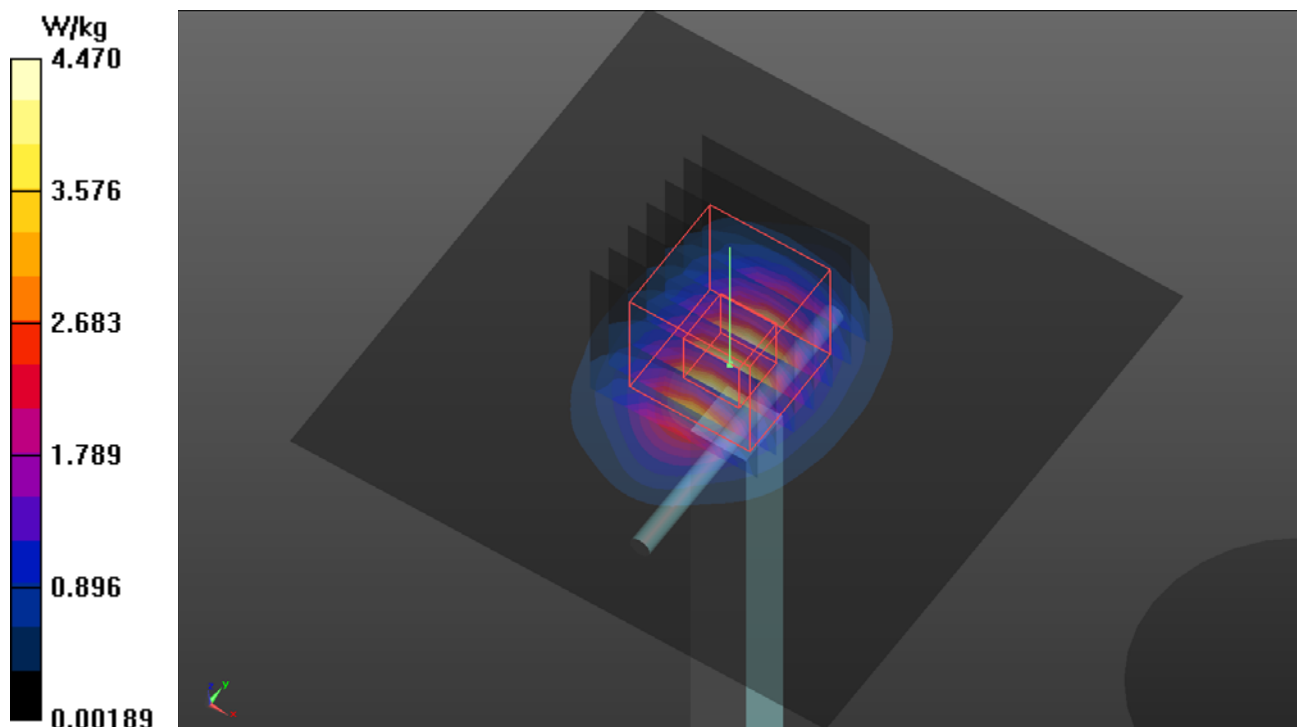

System Check_H2600_200908

DUT: Dipole 2600 MHz; Type: D2600V2; SN: 1077

Communication System: UID 0, CW; Frequency: 2600 MHz; Duty Cycle: 1:1

Medium: H19T27N1_0908 Medium parameters used: $f = 2600$ MHz; $\sigma = 2.036$ S/m; $\epsilon_r = 37.736$; $\rho = 1000$ kg/m³

Ambient Temperature : 23.7 °C ; Liquid Temperature : 23.2 °C

DASY5 Configuration:

- Probe: EX3DV4 - SN3971; ConvF(7.71, 7.71, 7.71) @ 2600 MHz; Calibrated: 2020/01/27
- Sensor-Surface: 1.4mm (Mechanical Surface Detection)
- Electronics: DAE4 Sn917; Calibrated: 2019/12/17
- Phantom: Twin SAM Phantom_1823; Type: QD 000 P40 CD;
- Measurement SW: DASY52, Version 52.10 (4); SEMCAD X Version 14.6.14 (7483)

Pin=50mW/Area Scan (81x81x1): Interpolated grid: dx=1.200 mm, dy=1.200 mm
Maximum value of SAR (interpolated) = 4.78 W/kg

Pin=50mW/Zoom Scan (7x7x7)/Cube 0: Measurement grid: dx=5mm, dy=5mm, dz=5mm
Reference Value = 49.06 V/m; Power Drift = 0.10 dB
Peak SAR (extrapolated) = 5.97 W/kg
SAR(1 g) = 2.77 W/kg; SAR(10 g) = 1.27 W/kg (SAR corrected for target medium)
Maximum value of SAR (measured) = 4.82 W/kg

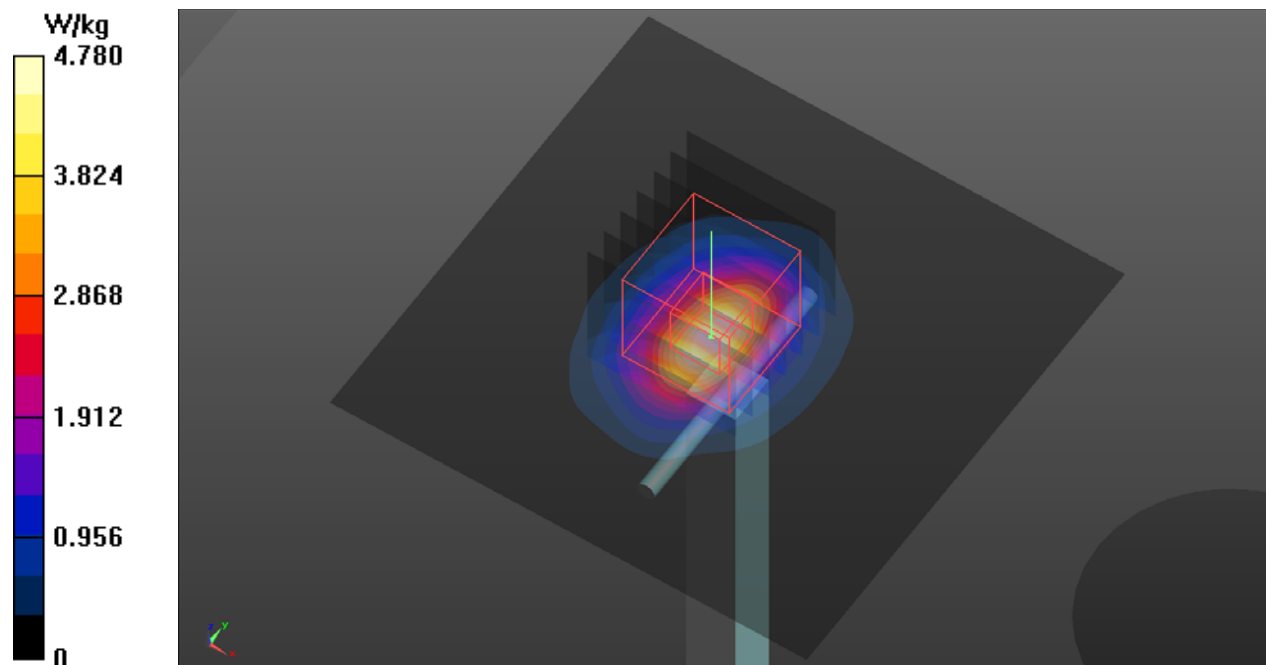

System Check_H5250_200909

DUT: Dipole 5 GHz; Type: D5GHzV2; SN: 1019

Communication System: UID 0, CW; Frequency: 5250 MHz; Duty Cycle: 1:1

Medium: H34T60N1_0909 Medium parameters used (interpolated): $f = 5250$ MHz; $\sigma = 4.623$ S/m; $\epsilon_r = 37.419$; $\rho = 1000$ kg/m³

Ambient Temperature : 23.7 °C ; Liquid Temperature : 23.1 °C

DASY5 Configuration:

- Probe: EX3DV4 - SN7472; ConvF(5.72, 5.72, 5.72) @ 5250 MHz; Calibrated: 2020/8/24
- Sensor-Surface: 1.4mm (Mechanical Surface Detection)
- Electronics: DAE3 Sn579; Calibrated: 2020/8/12
- Phantom: SAM Phantom_1982; Type: QD 000 P41 Ax;
- Measurement SW: DASY52, Version 52.10 (4); SEMCAD X Version 14.6.14 (7483)

Pin=50mW/Area Scan (91x91x1): Interpolated grid: dx=1.000 mm, dy=1.000 mm
Maximum value of SAR (interpolated) = 8.38 W/kg

Pin=50mW/Zoom Scan (7x7x7)/Cube 0: Measurement grid: dx=4mm, dy=4mm, dz=1.4mm
Reference Value = 48.52 V/m; Power Drift = -0.08 dB
Peak SAR (extrapolated) = 14.0 W/kg
SAR(1 g) = 3.78 W/kg; SAR(10 g) = 1.11 W/kg (SAR corrected for target medium)
Maximum value of SAR (measured) = 9.11 W/kg

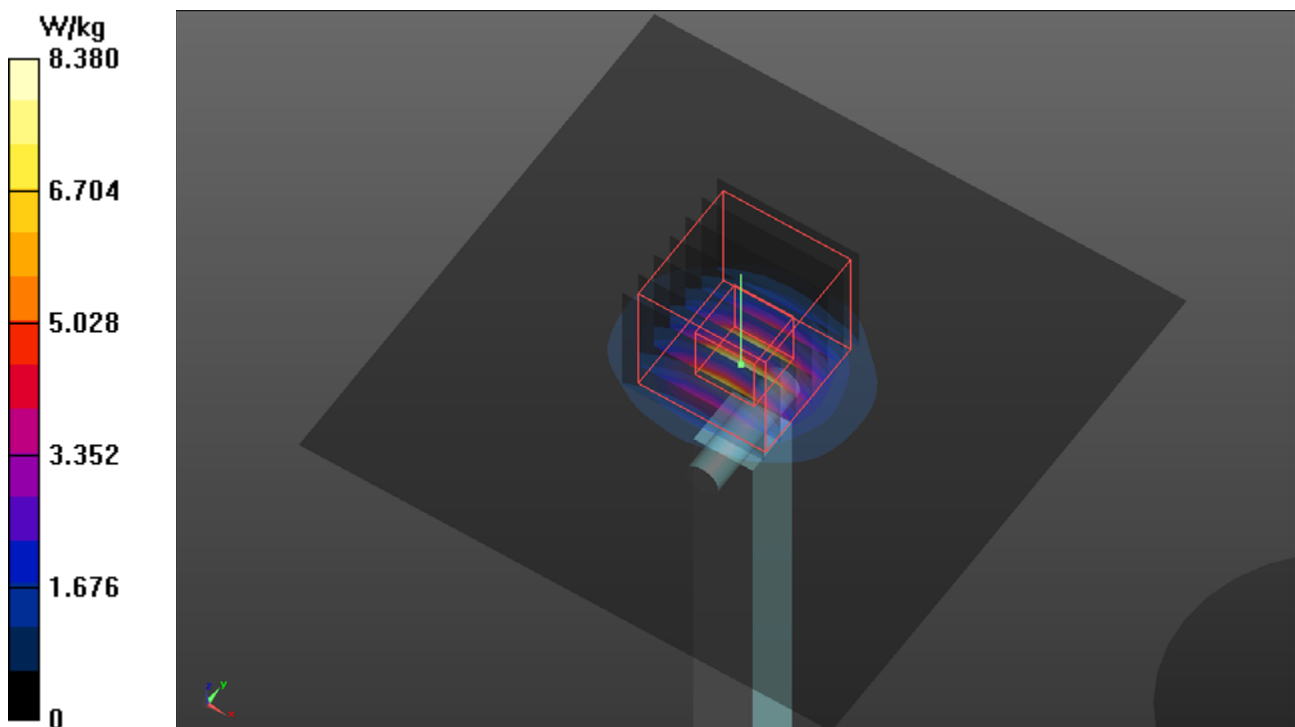

System Check_H5600_200909

DUT: Dipole 5 GHz; Type: D5GHzV2; SN: 1019

Communication System: UID 0, CW; Frequency: 5600 MHz; Duty Cycle: 1:1

Medium: H34T60N1_0909 Medium parameters used: $f = 5600$ MHz; $\sigma = 4.986$ S/m; $\epsilon_r = 36.942$; $\rho = 1000$ kg/m³

Ambient Temperature : 23.7 °C ; Liquid Temperature : 23.1 °C

DASY5 Configuration:

- Probe: EX3DV4 - SN7472; ConvF(5.04, 5.04, 5.04) @ 5600 MHz; Calibrated: 2020/8/24
- Sensor-Surface: 1.4mm (Mechanical Surface Detection)
- Electronics: DAE3 Sn579; Calibrated: 2020/8/12
- Phantom: SAM Phantom_1982; Type: QD 000 P41 Ax;
- Measurement SW: DASY52, Version 52.10 (4); SEMCAD X Version 14.6.14 (7483)

Pin=50mW/Area Scan (91x91x1): Interpolated grid: dx=1.000 mm, dy=1.000 mm
Maximum value of SAR (interpolated) = 9.62 W/kg

Pin=50mW/Zoom Scan (7x7x7)/Cube 0: Measurement grid: dx=4mm, dy=4mm, dz=1.4mm
Reference Value = 49.55 V/m; Power Drift = -0.04 dB
Peak SAR (extrapolated) = 16.8 W/kg
SAR(1 g) = 4.13 W/kg; SAR(10 g) = 1.19 W/kg (SAR corrected for target medium)
Maximum value of SAR (measured) = 10.4 W/kg

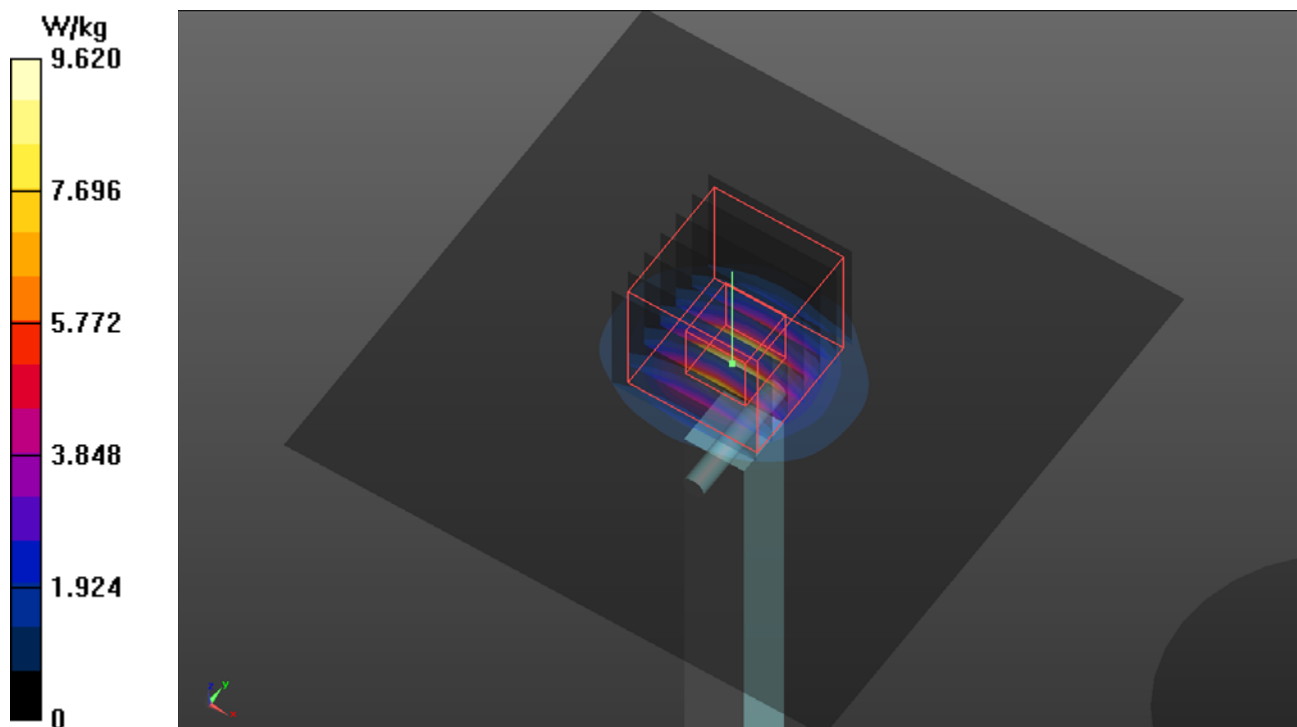

Appendix B. SAR Plots of SAR Measurement

The SAR plots for highest measured SAR in each exposure configuration, wireless mode and frequency band combination, and measured SAR > 1.5 W/kg are shown as follows.

P01 GSM850_GPRS12_Right Cheek_Ch189

DUT: 200313C17

Communication System: UID 10028 - DAC, GPRS-FDD (TDMA, GMSK, TN 0-1-2-3); Frequency: 836.4 MHz; Duty Cycle: 1:2.27

Medium: H07T10N1_0808 Medium parameters used: $f = 836.4$ MHz; $\sigma = 0.907$ S/m; $\epsilon_r = 42.43$; $\rho = 1000$ kg/m³

Ambient Temperature : 23.8 °C ; Liquid Temperature : 23.3 °C

DASY5 Configuration:

- Probe: EX3DV4 - SN3650; ConvF(9.69, 9.69, 9.69) @ 836.4 MHz; Calibrated: 2020/03/25
- Sensor-Surface: 1.4mm (Mechanical Surface Detection)
- Electronics: DAE4 Sn861; Calibrated: 2020/05/27
- Phantom: Twin SAM Phantom_1823; Type: QD 000 P40 CD;
- Measurement SW: DASY52, Version 52.10 (2); SEMCAD X Version 14.6.14 (7483)

Area Scan (71x131x1): Interpolated grid: dx=1.500 mm, dy=1.500 mm

Maximum value of SAR (interpolated) = 0.418 W/kg

Zoom Scan (5x5x7)/Cube 0: Measurement grid: dx=8mm, dy=8mm, dz=5mm

Reference Value = 22.14 V/m; Power Drift = -0.06 dB

Peak SAR (extrapolated) = 0.433 W/kg

SAR(1 g) = 0.351 W/kg; SAR(10 g) = 0.263 W/kg (SAR corrected for target medium)

Smallest distance from peaks to all points 3 dB below: Larger than measurement grid

Ratio of SAR at M2 to SAR at M1 = 79.9%

Maximum value of SAR (measured) = 0.402 W/kg

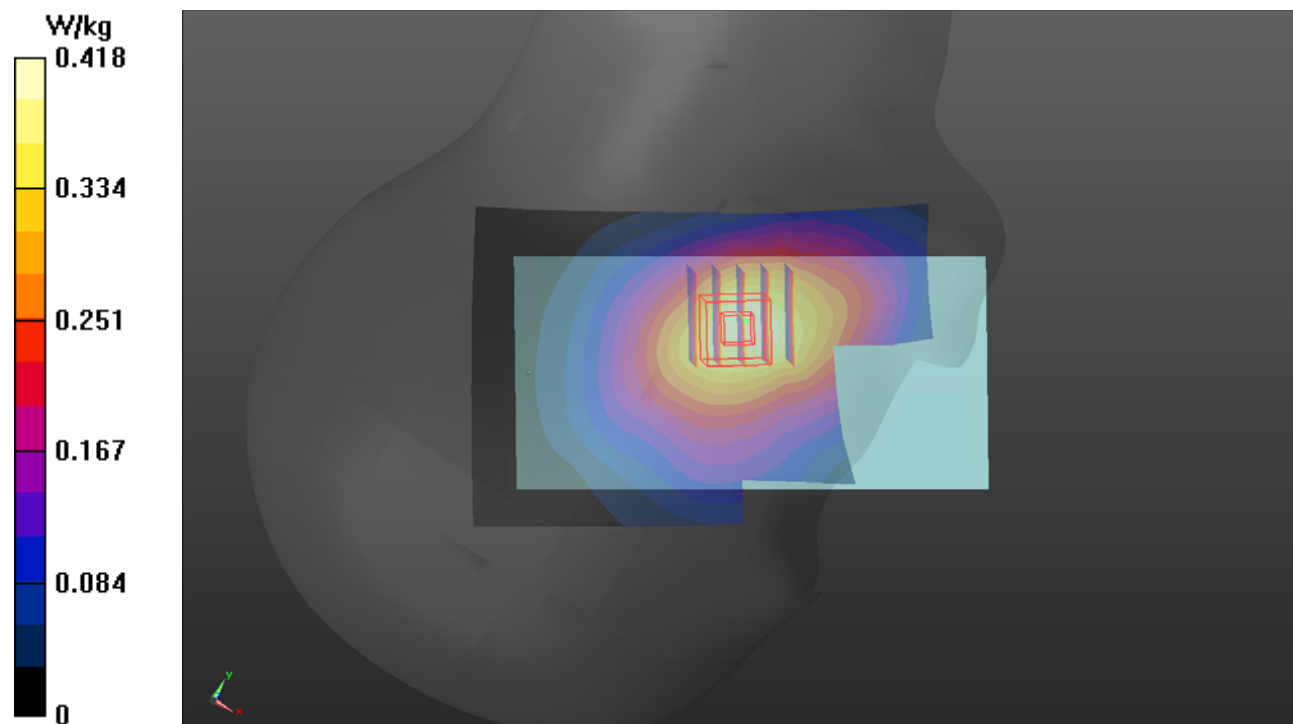

P02 GSM1900_EDGE12_Left Cheek_Ch512

DUT: 200313C17

Communication System: UID 10058 - DAC, EDGE-FDD (TDMA, 8PSK, TN 0-1-2-3); Frequency: 1850.2 MHz; Duty Cycle: 1:4.49

Medium: H16T20N1_0808 Medium parameters used (interpolated): $f = 1850.2$ MHz; $\sigma = 1.411$ S/m; $\epsilon_r = 39.5$; $\rho = 1000$ kg/m³

Ambient Temperature : 23.8 °C ; Liquid Temperature : 23.5 °C

DASY5 Configuration:

- Probe: EX3DV4 - SN3650; ConvF(8.23, 8.23, 8.23) @ 1850.2 MHz; Calibrated: 2020/03/25
- Sensor-Surface: 1.4mm (Mechanical Surface Detection)
- Electronics: DAE4 Sn861; Calibrated: 2020/05/27
- Phantom: Twin SAM Phantom_1823; Type: QD 000 P40 CD;
- Measurement SW: DASY52, Version 52.10 (2); SEMCAD X Version 14.6.14 (7483)

Area Scan (71x131x1): Interpolated grid: dx=1.500 mm, dy=1.500 mm

Maximum value of SAR (interpolated) = 1.07 W/kg

Zoom Scan (5x5x7)/Cube 0: Measurement grid: dx=8mm, dy=8mm, dz=5mm

Reference Value = 27.42 V/m; Power Drift = 0.02 dB

Peak SAR (extrapolated) = 1.17 W/kg

SAR(1 g) = 0.788 W/kg; SAR(10 g) = 0.506 W/kg (SAR corrected for target medium)

Smallest distance from peaks to all points 3 dB below = 14.9 mm

Ratio of SAR at M2 to SAR at M1 = 68.2%

Maximum value of SAR (measured) = 1.04 W/kg

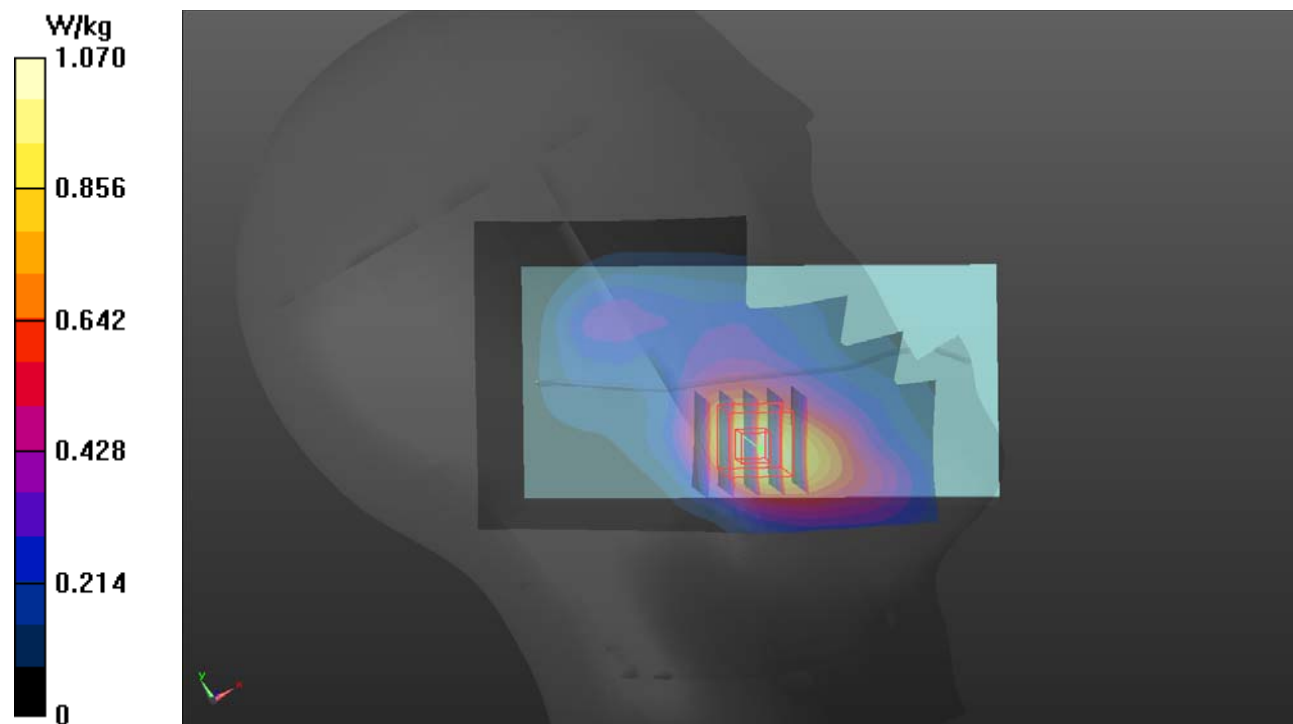

P03 WCDMA II_RMC12.2K_Left Cheek_Ch9262

DUT: 200313C17

Communication System: UID 10011 - CAB, UMTS-FDD (WCDMA); Frequency: 1852.4 MHz; Duty Cycle: 1:1.95

Medium: H16T20N1_0808 Medium parameters used (interpolated): $f = 1852.4$ MHz; $\sigma = 1.413$ S/m; $\epsilon_r = 39.49$; $\rho = 1000$ kg/m³

Ambient Temperature : 23.8 °C ; Liquid Temperature : 23.3 °C

DASY5 Configuration:

- Probe: EX3DV4 - SN3650; ConvF(8.23, 8.23, 8.23) @ 1852.4 MHz; Calibrated: 2020/03/25
- Sensor-Surface: 1.4mm (Mechanical Surface Detection)
- Electronics: DAE4 Sn861; Calibrated: 2020/05/27
- Phantom: Twin SAM Phantom_1823; Type: QD 000 P40 CD;
- Measurement SW: DASY52, Version 52.10 (4); SEMCAD X Version 14.6.14 (7483)

Area Scan (71x131x1): Interpolated grid: dx=1.500 mm, dy=1.500 mm

Maximum value of SAR (interpolated) = 1.60 W/kg

Zoom Scan (5x5x7)/Cube 0: Measurement grid: dx=8mm, dy=8mm, dz=5mm

Reference Value = 33.74 V/m; Power Drift = -0.03 dB

Peak SAR (extrapolated) = 1.73 W/kg

SAR(1 g) = 1.17 W/kg; SAR(10 g) = 0.767 W/kg (SAR corrected for target medium)

Smallest distance from peaks to all points 3 dB below = 15.7 mm

Ratio of SAR at M2 to SAR at M1 = 68.9%

Maximum value of SAR (measured) = 1.54 W/kg

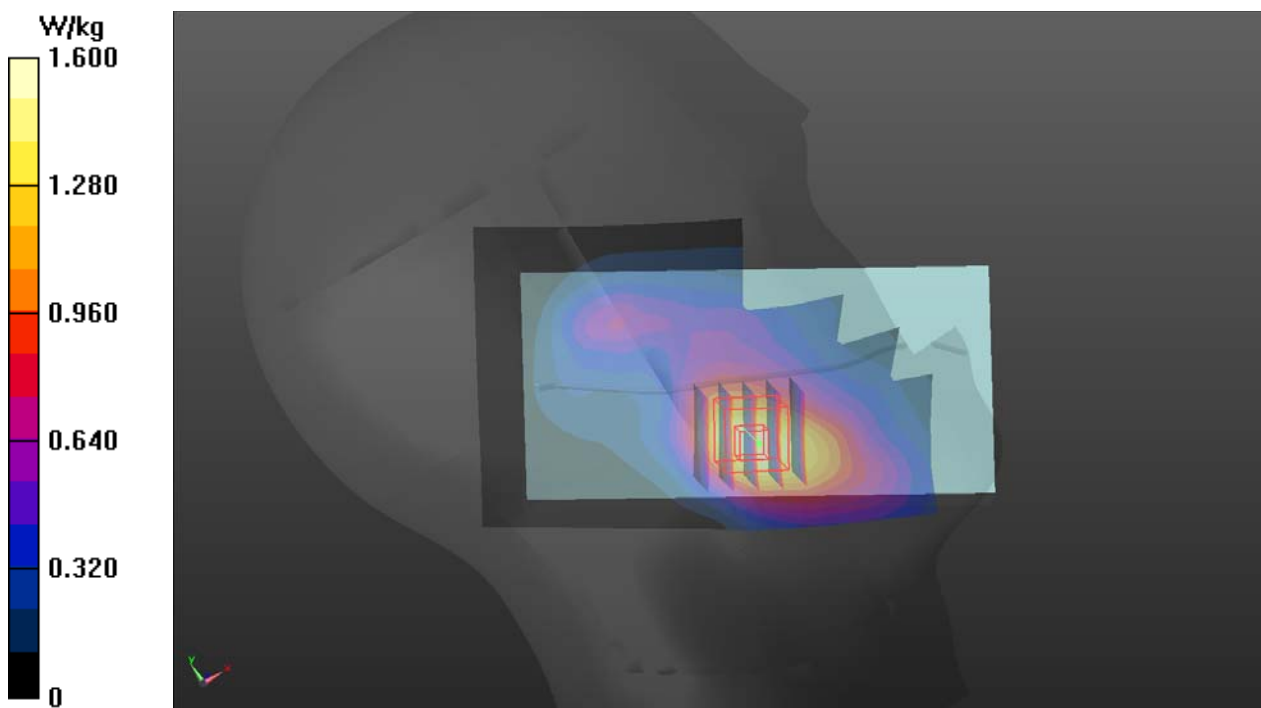

P04 WCDMA IV_RMC12.2K_Left Cheek_Ch1513**DUT: 200313C17**

Communication System: UID 10011 - CAB, UMTS-FDD (WCDMA); Frequency: 1752.6 MHz; Duty Cycle: 1:1.95

Medium: H16T20N1_0809 Medium parameters used: $f = 1753$ MHz; $\sigma = 1.327$ S/m; $\epsilon_r = 39.851$; $\rho = 1000$ kg/m³

Ambient Temperature : 23.8 °C ; Liquid Temperature : 23.3 °C

DASY5 Configuration:

- Probe: EX3DV4 - SN3650; ConvF(8.54, 8.54, 8.54) @ 1752.6 MHz; Calibrated: 2020/03/25
- Sensor-Surface: 1.4mm (Mechanical Surface Detection)
- Electronics: DAE4 Sn861; Calibrated: 2020/05/27
- Phantom: Twin SAM Phantom_1823; Type: QD 000 P40 CD;
- Measurement SW: DASY52, Version 52.10 (4); SEMCAD X Version 14.6.14 (7483)

Area Scan (71x131x1): Interpolated grid: dx=1.500 mm, dy=1.500 mm

Maximum value of SAR (interpolated) = 1.26 W/kg

Zoom Scan (5x5x7)/Cube 0: Measurement grid: dx=8mm, dy=8mm, dz=5mm

Reference Value = 30.31 V/m; Power Drift = -0.01 dB

Peak SAR (extrapolated) = 1.37 W/kg

SAR(1 g) = 0.943 W/kg; SAR(10 g) = 0.619 W/kg (SAR corrected for target medium)

Smallest distance from peaks to all points 3 dB below = 17.1 mm

Ratio of SAR at M2 to SAR at M1 = 68.5%

Maximum value of SAR (measured) = 1.21 W/kg

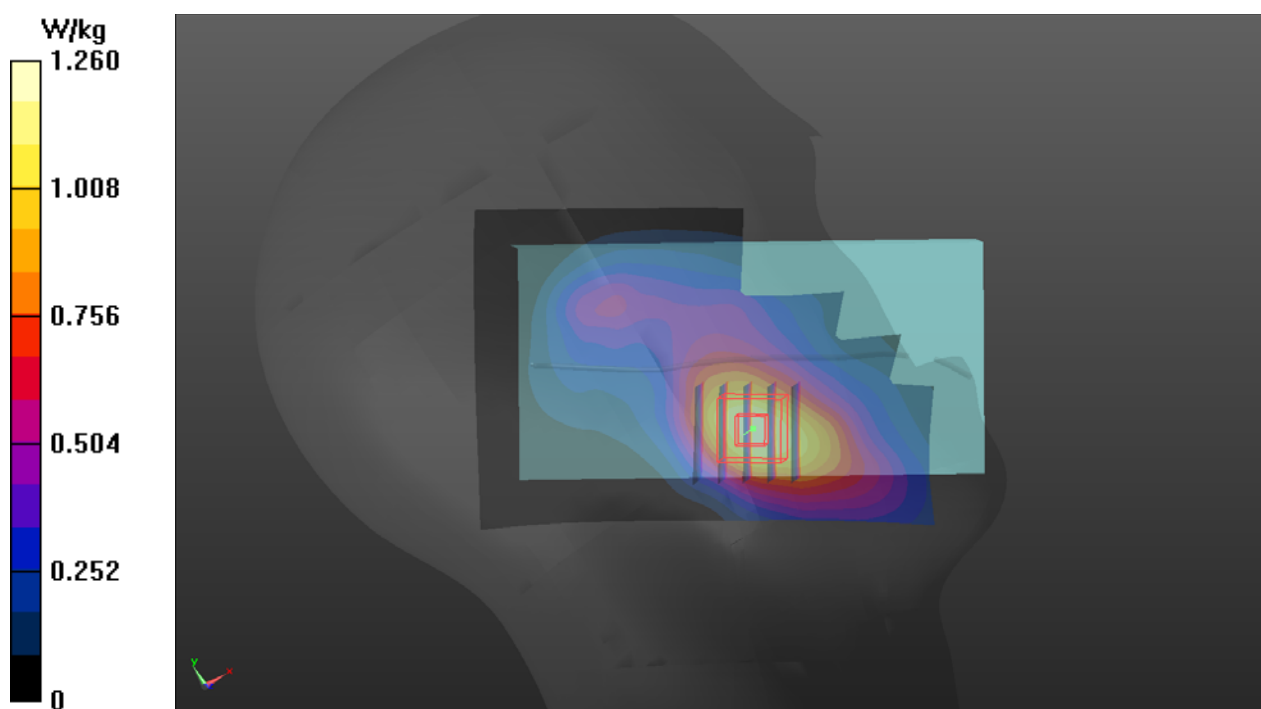

P05 WCDMA V_RMC12.2K_Right Cheek_Ch4233

DUT: 200313C17

Communication System: UID 10011 - CAB, UMTS-FDD (WCDMA); Frequency: 846.6 MHz; Duty Cycle: 1:1.95

Medium: H07T10N1_0808 Medium parameters used: $f = 847$ MHz; $\sigma = 0.917$ S/m; $\epsilon_r = 42.306$; $\rho = 1000$ kg/m³

Ambient Temperature : 23.8 °C ; Liquid Temperature : 23.3 °C

DASY5 Configuration:

- Probe: EX3DV4 - SN3650; ConvF(9.69, 9.69, 9.69) @ 846.6 MHz; Calibrated: 2020/03/25
- Sensor-Surface: 1.4mm (Mechanical Surface Detection)
- Electronics: DAE4 Sn861; Calibrated: 2020/05/27
- Phantom: Twin SAM Phantom_1823; Type: QD 000 P40 CD;
- Measurement SW: DASY52, Version 52.10 (4); SEMCAD X Version 14.6.14 (7483)

Area Scan (71x131x1): Interpolated grid: dx=1.500 mm, dy=1.500 mm

Maximum value of SAR (interpolated) = 0.601 W/kg

Zoom Scan (5x5x7)/Cube 0: Measurement grid: dx=8mm, dy=8mm, dz=5mm

Reference Value = 26.49 V/m; Power Drift = -0.03 dB

Peak SAR (extrapolated) = 0.632 W/kg

SAR(1 g) = 0.482 W/kg; SAR(10 g) = 0.356 W/kg (SAR corrected for target medium)

Smallest distance from peaks to all points 3 dB below = 19.5 mm

Ratio of SAR at M2 to SAR at M1 = 77%

Maximum value of SAR (measured) = 0.580 W/kg

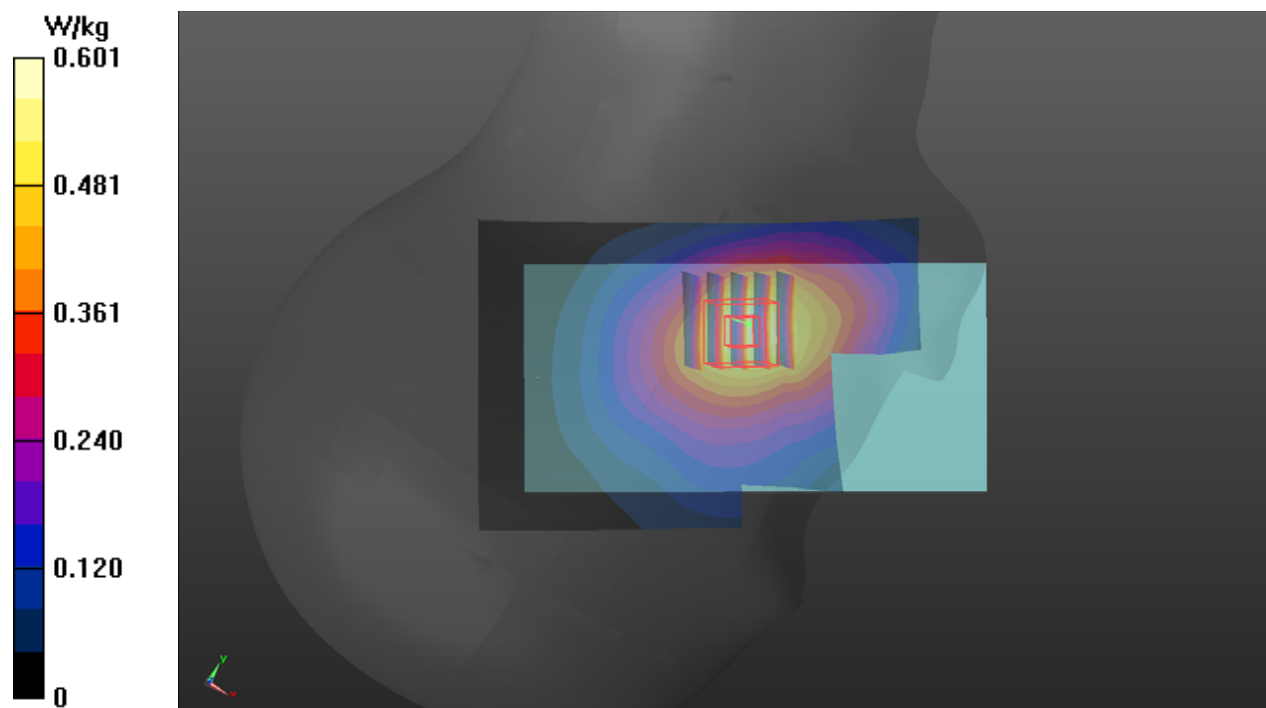

P06 LTE 2_QPSK20M_Left Cheek_Ch18700_1RB_OS0

DUT: 200313C17

Communication System: UID 10169 - CAE, LTE-FDD (SC-FDMA, 1 RB, 20 MHz, QPSK);

Frequency: 1860 MHz; Duty Cycle: 1:3.74

Medium: H16T20N1_0808 Medium parameters used: $f = 1860$ MHz; $\sigma = 1.42$ S/m; $\epsilon_r = 39.461$; $\rho = 1000$ kg/m³

Ambient Temperature : 23.8 °C ; Liquid Temperature : 23.3 °C

DASY5 Configuration:

- Probe: EX3DV4 - SN3650; ConvF(8.23, 8.23, 8.23) @ 1860 MHz; Calibrated: 2020/03/25

- Sensor-Surface: 1.4mm (Mechanical Surface Detection)

- Electronics: DAE4 Sn861; Calibrated: 2020/05/27

- Phantom: Twin SAM Phantom_1823; Type: QD 000 P40 CD;

- Measurement SW: DASY52, Version 52.10 (4); SEMCAD X Version 14.6.14 (7483)

Area Scan (71x131x1): Interpolated grid: dx=1.500 mm, dy=1.500 mm

Maximum value of SAR (interpolated) = 1.36 W/kg

Zoom Scan (5x5x7)/Cube 0: Measurement grid: dx=8mm, dy=8mm, dz=5mm

Reference Value = 31.00 V/m; Power Drift = -0.06 dB

Peak SAR (extrapolated) = 1.48 W/kg

SAR(1 g) = 0.985 W/kg; SAR(10 g) = 0.638 W/kg (SAR corrected for target medium)

Smallest distance from peaks to all points 3 dB below = 16.3 mm

Ratio of SAR at M2 to SAR at M1 = 67.6%

Maximum value of SAR (measured) = 1.32 W/kg

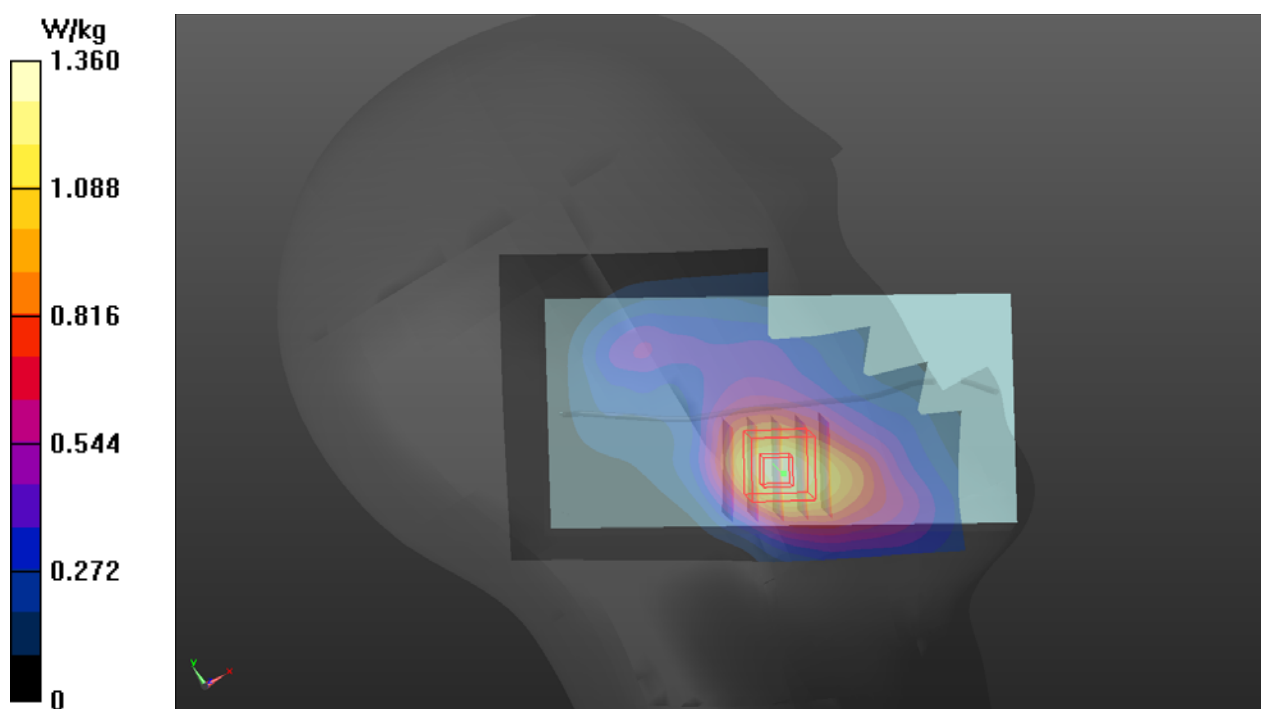

P07 LTE 4_QPSK20M_Left Cheek_Ch20300_1RB_OS0**DUT: 200313C17**

Communication System: UID 10169 - CAE, LTE-FDD (SC-FDMA, 1 RB, 20 MHz, QPSK);

Frequency: 1745 MHz; Duty Cycle: 1:3.74

Medium: H16T20N1_0809 Medium parameters used (interpolated): $f = 1745$ MHz; $\sigma = 1.32$ S/m; $\epsilon_r = 39.89$; $\rho = 1000$ kg/m³

Ambient Temperature : 23.8 °C ; Liquid Temperature : 23.3 °C

DASY5 Configuration:

- Probe: EX3DV4 - SN3650; ConvF(8.54, 8.54, 8.54) @ 1745 MHz; Calibrated: 2020/03/25

- Sensor-Surface: 1.4mm (Mechanical Surface Detection)

- Electronics: DAE4 Sn861; Calibrated: 2020/05/27

- Phantom: Twin SAM Phantom_1823; Type: QD 000 P40 CD;

- Measurement SW: DASY52, Version 52.10 (4); SEMCAD X Version 14.6.14 (7483)

Area Scan (71x131x1): Interpolated grid: dx=1.500 mm, dy=1.500 mm

Maximum value of SAR (interpolated) = 0.950 W/kg

Zoom Scan (5x5x7)/Cube 0: Measurement grid: dx=8mm, dy=8mm, dz=5mm

Reference Value = 26.19 V/m; Power Drift = -0.04 dB

Peak SAR (extrapolated) = 1.03 W/kg

SAR(1 g) = 0.705 W/kg; SAR(10 g) = 0.458 W/kg (SAR corrected for target medium)

Smallest distance from peaks to all points 3 dB below = 16.9 mm

Ratio of SAR at M2 to SAR at M1 = 68.4%

Maximum value of SAR (measured) = 0.904 W/kg

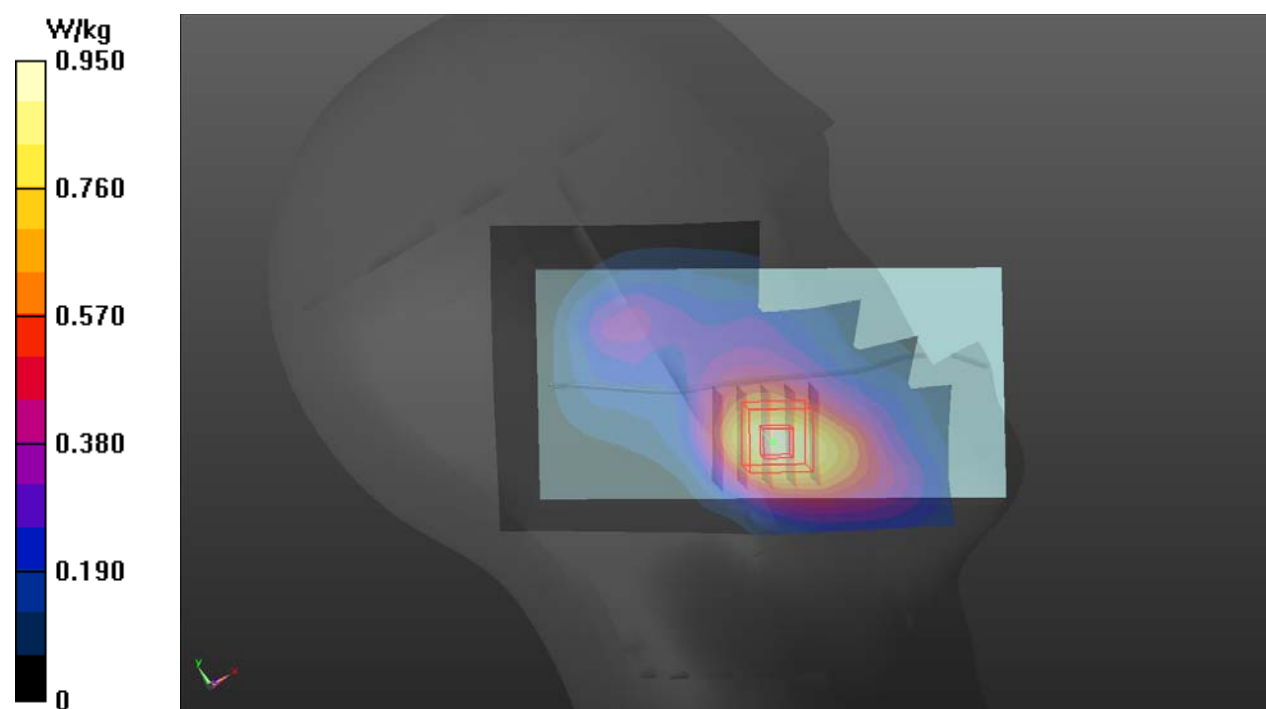

P08 LTE 5_QPSK10M_Right Cheek_Ch20600_1RB_OS0

DUT: 200313C17

Communication System: UID 10175 - CAG, LTE-FDD (SC-FDMA, 1 RB, 10 MHz, QPSK);
Frequency: 844 MHz; Duty Cycle: 1:3.74
Medium: H07T10N1_0808 Medium parameters used: $f = 844$ MHz; $\sigma = 0.914$ S/m; $\epsilon_r = 42.34$; $\rho = 1000$ kg/m³
Ambient Temperature : 23.8 °C ; Liquid Temperature : 23.3 °C

DASY5 Configuration:

- Probe: EX3DV4 - SN3650; ConvF(9.69, 9.69, 9.69) @ 844 MHz; Calibrated: 2020/03/25
- Sensor-Surface: 1.4mm (Mechanical Surface Detection)
- Electronics: DAE4 Sn861; Calibrated: 2020/05/27
- Phantom: Twin SAM Phantom_1823; Type: QD 000 P40 CD;
- Measurement SW: DASY52, Version 52.10 (4); SEMCAD X Version 14.6.14 (7483)

Area Scan (71x131x1): Interpolated grid: $dx=1.500$ mm, $dy=1.500$ mm
Maximum value of SAR (interpolated) = 0.436 W/kg

Zoom Scan (5x5x7)/Cube 0: Measurement grid: $dx=8$ mm, $dy=8$ mm, $dz=5$ mm
Reference Value = 22.60 V/m; Power Drift = -0.01 dB
Peak SAR (extrapolated) = 0.455 W/kg
SAR(1 g) = 0.351 W/kg; SAR(10 g) = 0.261 W/kg (SAR corrected for target medium)
Smallest distance from peaks to all points 3 dB below = 20.8 mm
Ratio of SAR at M2 to SAR at M1 = 77.9%
Maximum value of SAR (measured) = 0.420 W/kg

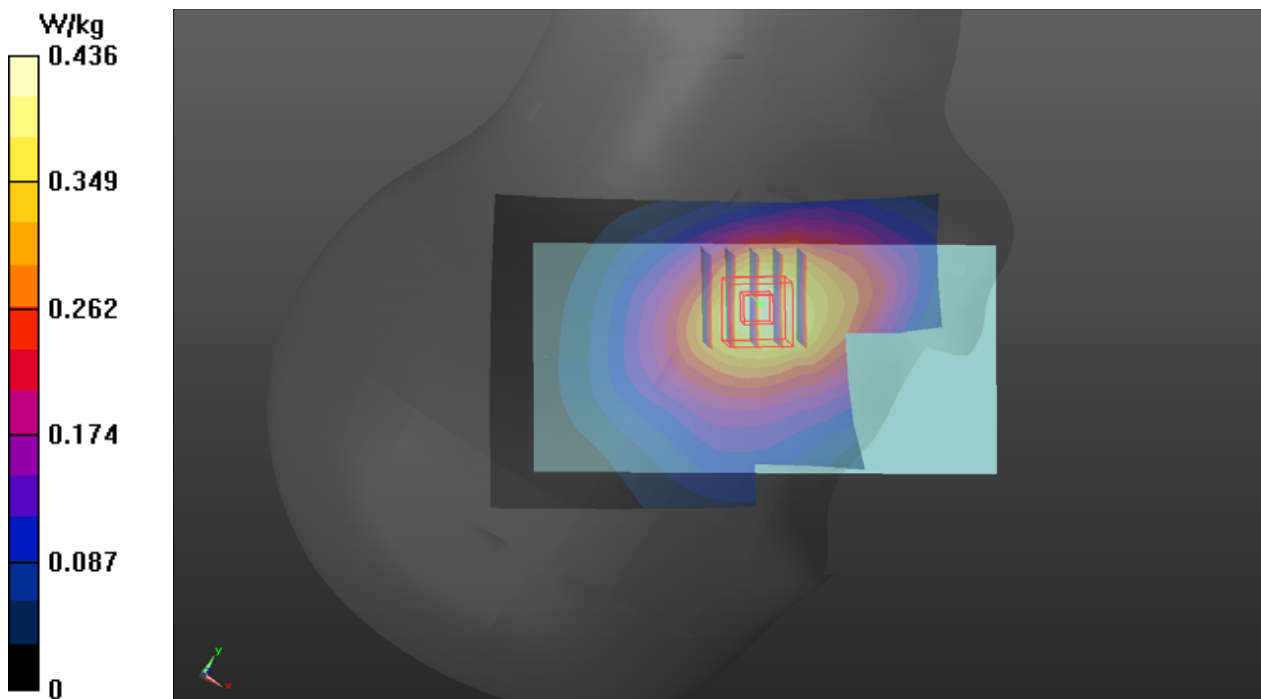

P09 LTE 7_QPSK20M_Left Cheek_Ch20850_1RB_OS0

DUT: 200313C17

Communication System: UID 10169 - CAE, LTE-FDD (SC-FDMA, 1 RB, 20 MHz, QPSK);

Frequency: 2510 MHz; Duty Cycle: 1:3.74

Medium: H19T27N1_0809 Medium parameters used: $f = 2510$ MHz; $\sigma = 1.915$ S/m; $\epsilon_r = 38.265$; $\rho = 1000$ kg/m³

Ambient Temperature : 23.8 °C ; Liquid Temperature : 23.5 °C

DASY5 Configuration:

- Probe: EX3DV4 - SN3650; ConvF(7.56, 7.56, 7.56) @ 2510 MHz; Calibrated: 2020/03/25

- Sensor-Surface: 1.4mm (Mechanical Surface Detection)

- Electronics: DAE4 Sn861; Calibrated: 2020/05/27

- Phantom: Twin SAM Phantom_1823; Type: QD 000 P40 CD;

- Measurement SW: DASY52, Version 52.10 (4); SEMCAD X Version 14.6.14 (7483)

Area Scan (91x171x1): Interpolated grid: dx=1.200 mm, dy=1.200 mm

Maximum value of SAR (interpolated) = 1.34 W/kg

Zoom Scan (7x7x7)/Cube 0: Measurement grid: dx=5mm, dy=5mm, dz=5mm

Reference Value = 26.28 V/m; Power Drift = 0.01 dB

Peak SAR (extrapolated) = 1.54 W/kg

SAR(1 g) = 0.896 W/kg; SAR(10 g) = 0.512 W/kg (SAR corrected for target medium)

Smallest distance from peaks to all points 3 dB below = 11.2 mm

Ratio of SAR at M2 to SAR at M1 = 61%

Maximum value of SAR (measured) = 1.29 W/kg

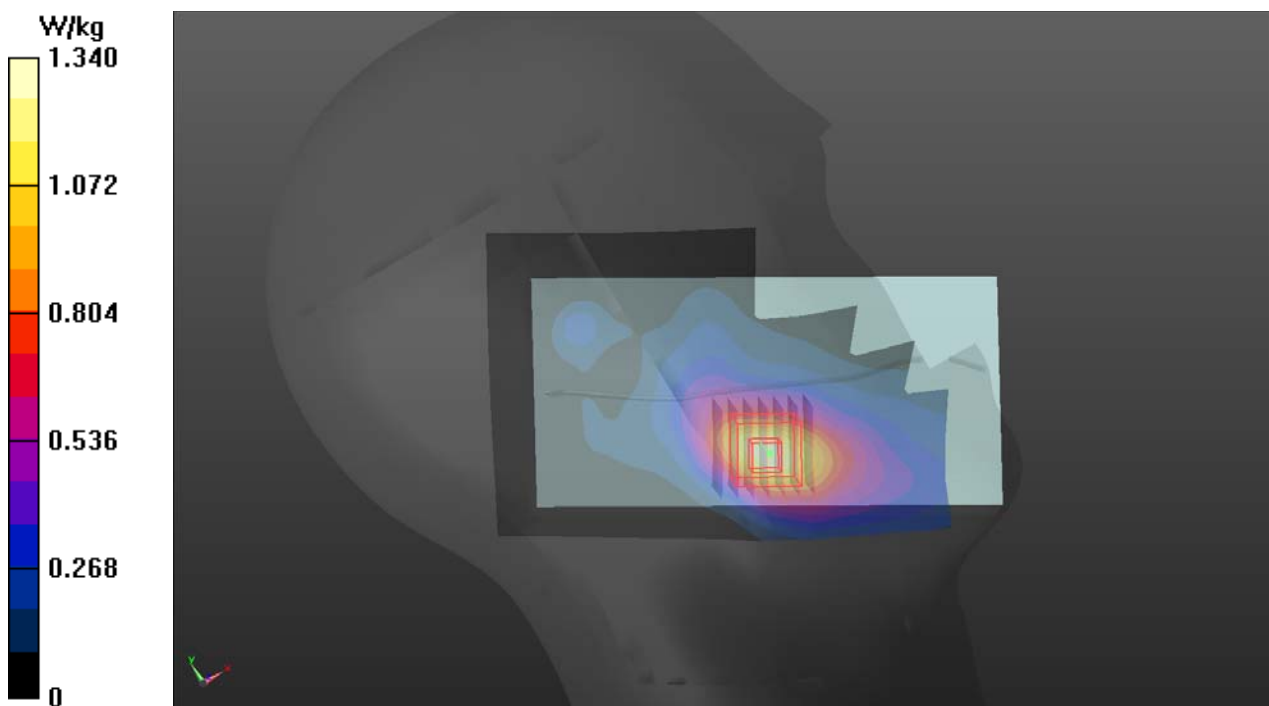

P10 LTE 17_QPSK10M_Right Cheek_Ch23790_1RB_OS0

DUT: 200313C17

Communication System: UID 10175 - CAG, LTE-FDD (SC-FDMA, 1 RB, 10 MHz, QPSK);
Frequency: 710 MHz; Duty Cycle: 1:3.74
Medium: H06T09N1_0809 Medium parameters used: $f = 710$ MHz; $\sigma = 0.85$ S/m; $\epsilon_r = 43.953$; $\rho = 1000$ kg/m³
Ambient Temperature : 23.8 °C ; Liquid Temperature : 23.5 °C

DASY5 Configuration:

- Probe: EX3DV4 - SN3650; ConvF(9.83, 9.83, 9.83) @ 710 MHz; Calibrated: 2020/03/25
- Sensor-Surface: 1.4mm (Mechanical Surface Detection)
- Electronics: DAE4 Sn861; Calibrated: 2020/05/27
- Phantom: Twin SAM Phantom_1823; Type: QD 000 P40 CD;
- Measurement SW: DASY52, Version 52.10 (4); SEMCAD X Version 14.6.14 (7483)

Area Scan (71x131x1): Interpolated grid: $dx=1.500$ mm, $dy=1.500$ mm
Maximum value of SAR (interpolated) = 0.202 W/kg

Zoom Scan (5x5x7)/Cube 0: Measurement grid: $dx=8$ mm, $dy=8$ mm, $dz=5$ mm
Reference Value = 15.73 V/m; Power Drift = -0.03 dB
Peak SAR (extrapolated) = 0.209 W/kg
SAR(1 g) = 0.173 W/kg; SAR(10 g) = 0.132 W/kg (SAR corrected for target medium)
Smallest distance from peaks to all points 3 dB below: Larger than measurement grid
Ratio of SAR at M2 to SAR at M1 = 78.2%
Maximum value of SAR (measured) = 0.192 W/kg

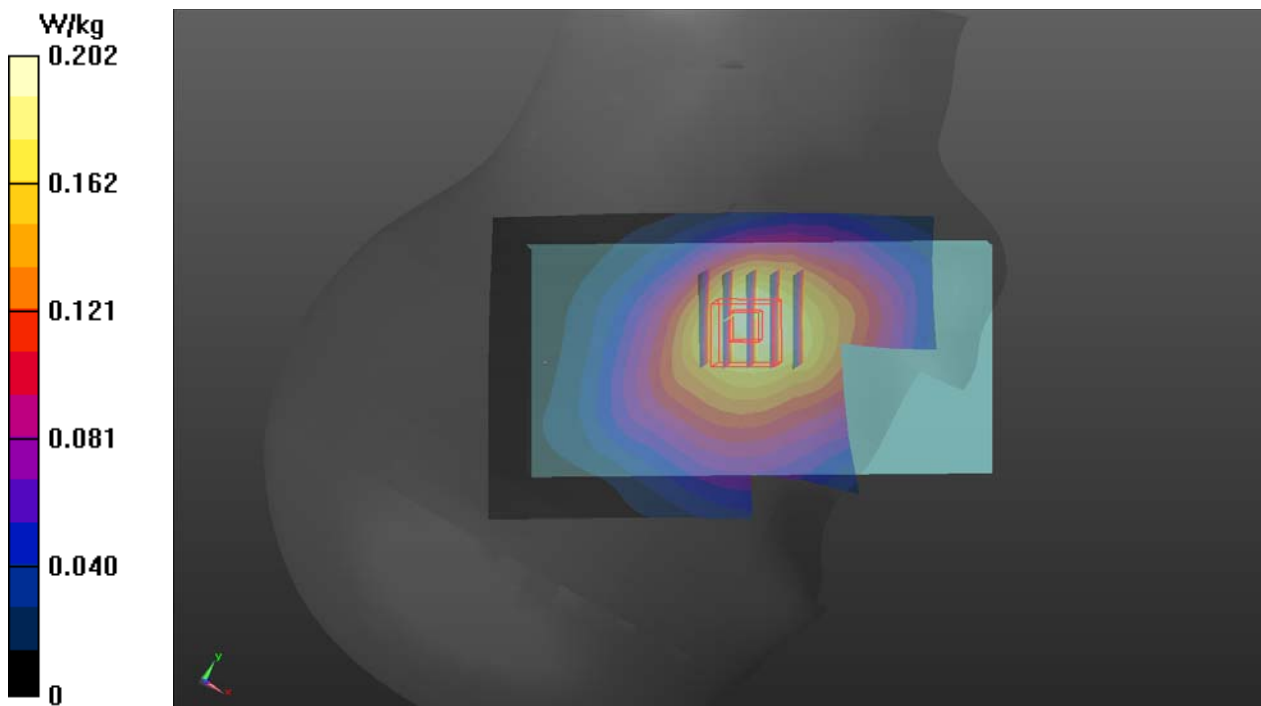

P11 LTE 26_QPSK15M_Right Cheek_Ch26965_1RB_OS0

DUT: 200313C17

Communication System: UID 10181 - CAE, LTE-FDD (SC-FDMA, 1 RB, 15 MHz, QPSK);
Frequency: 841.5 MHz; Duty Cycle: 1:3.74
Medium: H07T10N1_0808 Medium parameters used (interpolated): $f = 841.5$ MHz; $\sigma = 0.912$ S/m;
 $\epsilon_r = 42.371$; $\rho = 1000$ kg/m³
Ambient Temperature : 23.8 °C ; Liquid Temperature : 23.3 °C

DASY5 Configuration:

- Probe: EX3DV4 - SN3650; ConvF(9.69, 9.69, 9.69) @ 841.5 MHz; Calibrated: 2020/03/25
- Sensor-Surface: 1.4mm (Mechanical Surface Detection)
- Electronics: DAE4 Sn861; Calibrated: 2020/05/27
- Phantom: Twin SAM Phantom_1823; Type: QD 000 P40 CD;
- Measurement SW: DASY52, Version 52.10 (4); SEMCAD X Version 14.6.14 (7483)

Area Scan (71x131x1): Interpolated grid: dx=1.500 mm, dy=1.500 mm
Maximum value of SAR (interpolated) = 0.447 W/kg

Zoom Scan (5x5x7)/Cube 0: Measurement grid: dx=8mm, dy=8mm, dz=5mm
Reference Value = 22.75 V/m; Power Drift = -0.03 dB
Peak SAR (extrapolated) = 0.468 W/kg
SAR(1 g) = 0.361 W/kg; SAR(10 g) = 0.270 W/kg (SAR corrected for target medium)
Smallest distance from peaks to all points 3 dB below: Larger than measurement grid
Ratio of SAR at M2 to SAR at M1 = 77.4%
Maximum value of SAR (measured) = 0.426 W/kg

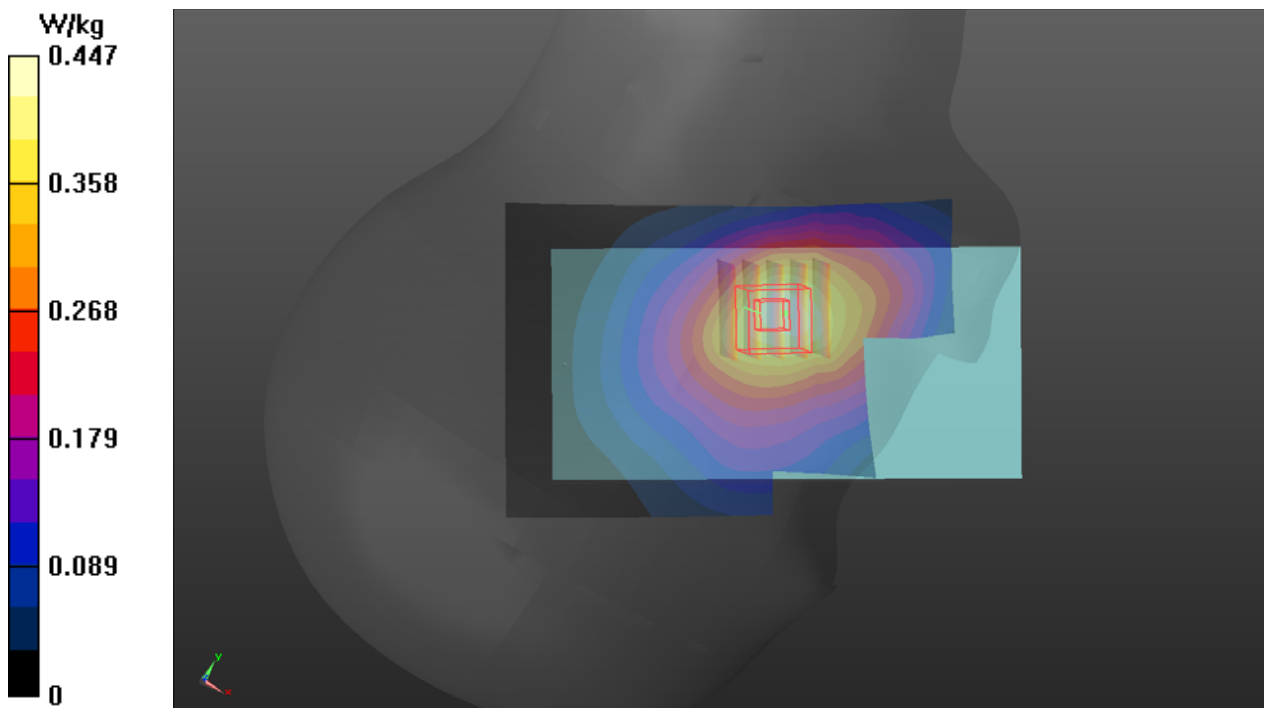

P12 LTE 38_QPSK20M_Left Cheek_Ch38000_1RB_OS0

DUT: 200313C17

Communication System: UID 10172 - CAG, LTE-TDD (SC-FDMA, 1 RB, 20 MHz, QPSK);
Frequency: 2595 MHz; Duty Cycle: 1:8.33
Medium: H19T27N1_0809 Medium parameters used (interpolated): $f = 2595$ MHz; $\sigma = 2.003$ S/m;
 $\epsilon_r = 37.954$; $\rho = 1000$ kg/m³
Ambient Temperature : 23.8 °C ; Liquid Temperature : 23.5 °C

DASY5 Configuration:

- Probe: EX3DV4 - SN3650; ConvF(7.56, 7.56, 7.56) @ 2595 MHz; Calibrated: 2020/03/25
- Sensor-Surface: 1.4mm (Mechanical Surface Detection)
- Electronics: DAE4 Sn861; Calibrated: 2020/05/27
- Phantom: Twin SAM Phantom_1823; Type: QD 000 P40 CD;
- Measurement SW: DASY52, Version 52.10 (4); SEMCAD X Version 14.6.14 (7483)

Area Scan (91x171x1): Interpolated grid: dx=1.200 mm, dy=1.200 mm
Maximum value of SAR (interpolated) = 0.941 W/kg

Zoom Scan (7x7x7)/Cube 0: Measurement grid: dx=5mm, dy=5mm, dz=5mm
Reference Value = 21.53 V/m; Power Drift = -0.04 dB
Peak SAR (extrapolated) = 1.07 W/kg
SAR(1 g) = 0.614 W/kg; SAR(10 g) = 0.347 W/kg (SAR corrected for target medium)
Smallest distance from peaks to all points 3 dB below = 11.8 mm
Ratio of SAR at M2 to SAR at M1 = 58.6%
Maximum value of SAR (measured) = 0.902 W/kg

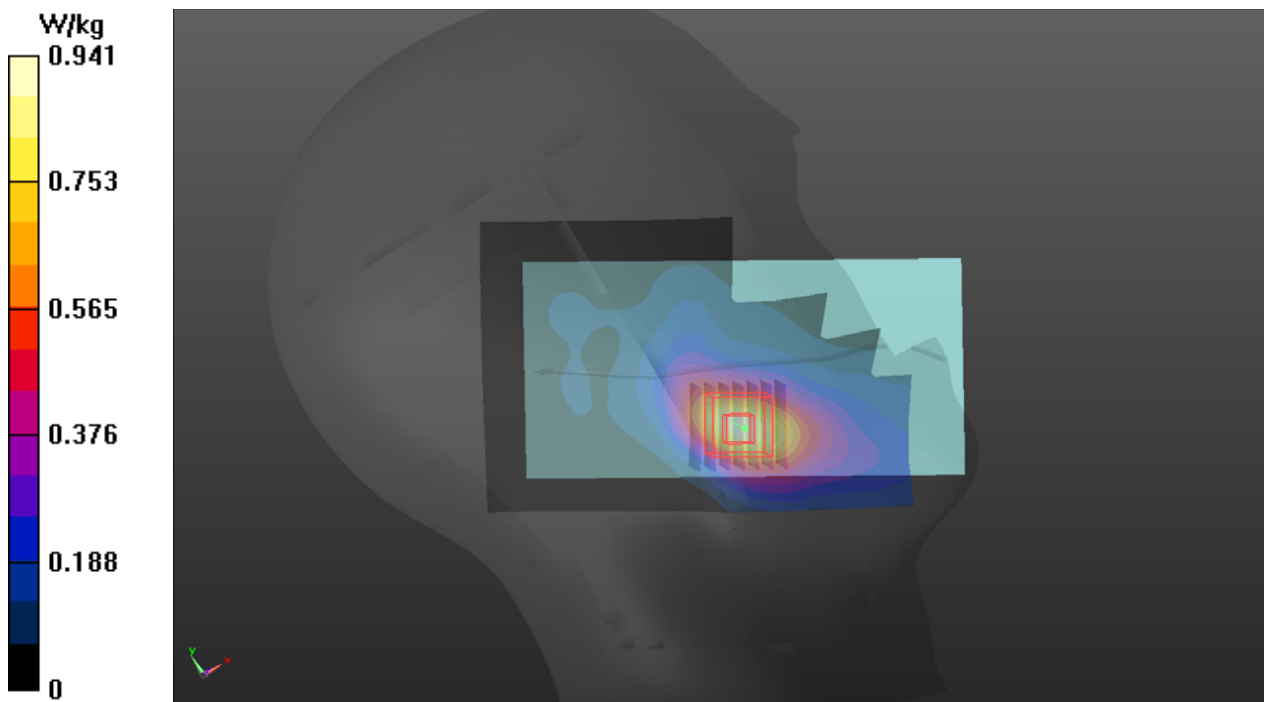

P13 LTE 41_QPSK20M_Left Cheek_Ch41055_1RB_OS0

DUT: 200313C17

Communication System: UID 10172 - CAG, LTE-TDD (SC-FDMA, 1 RB, 20 MHz, QPSK);
Frequency: 2636.5 MHz; Duty Cycle: 1:8.33
Medium: H19T27N1_0809 Medium parameters used (interpolated): $f = 2636.5$ MHz; $\sigma = 2.045$ S/m; $\epsilon_r = 37.811$; $\rho = 1000$ kg/m³
Ambient Temperature : 23.8 °C ; Liquid Temperature : 23.5 °C

DASY5 Configuration:

- Probe: EX3DV4 - SN3650; ConvF(7.56, 7.56, 7.56) @ 2636.5 MHz; Calibrated: 2020/03/25
- Sensor-Surface: 1.4mm (Mechanical Surface Detection)
- Electronics: DAE4 Sn861; Calibrated: 2020/05/27
- Phantom: Twin SAM Phantom_1823; Type: QD 000 P40 CD;
- Measurement SW: DASY52, Version 52.10 (4); SEMCAD X Version 14.6.14 (7483)

Area Scan (91x171x1): Interpolated grid: dx=1.200 mm, dy=1.200 mm
Maximum value of SAR (interpolated) = 1.04 W/kg

Zoom Scan (7x7x7)/Cube 0: Measurement grid: dx=5mm, dy=5mm, dz=5mm
Reference Value = 22.46 V/m; Power Drift = -0.01 dB
Peak SAR (extrapolated) = 1.21 W/kg
SAR(1 g) = 0.680 W/kg; SAR(10 g) = 0.378 W/kg (SAR corrected for target medium)
Smallest distance from peaks to all points 3 dB below = 12 mm
Ratio of SAR at M2 to SAR at M1 = 57.4%
Maximum value of SAR (measured) = 1.02 W/kg

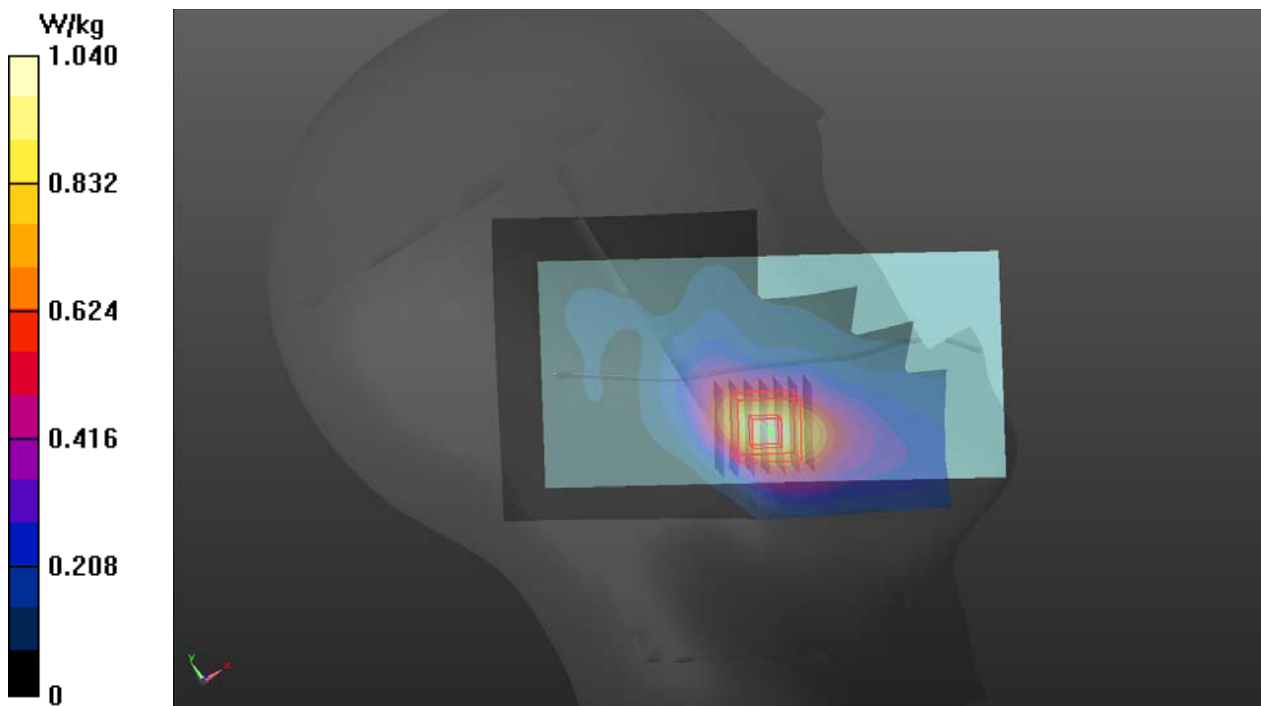

P14 WLAN2.4G_802.11b_Left Cheek_Ch6

DUT: 200313C17

Communication System: UID 10315 - AAB, IEEE 802.11b WiFi 2.4 GHz (DSSS, 1 Mbps, 96pc duty cycle); Frequency: 2437 MHz; Duty Cycle: 1:1.01

Medium: H19T27N1_0721 Medium parameters used (interpolated): $f = 2437$ MHz; $\sigma = 1.864$ S/m; $\epsilon_r = 39.437$; $\rho = 1000$ kg/m³

Ambient Temperature : 23.5 °C ; Liquid Temperature : 23.1 °C

DASY5 Configuration:

- Probe: EX3DV4 - SN7537; ConvF(7.4, 7.4, 7.4) @ 2437 MHz; Calibrated: 2020/5/29
- Sensor-Surface: 1.4mm (Mechanical Surface Detection)
- Electronics: DAE4 Sn1585; Calibrated: 2020/5/28
- Phantom: SAM Phantom_1982; Type: QD 000 P41 Ax;
- Measurement SW: DASY52, Version 52.10 (4); SEMCAD X Version 14.6.14 (7483)

Area Scan (91x171x1): Interpolated grid: dx=1.200 mm, dy=1.200 mm

Maximum value of SAR (interpolated) = 1.02 W/kg

Zoom Scan (7x7x7)/Cube 0: Measurement grid: dx=5mm, dy=5mm, dz=5mm

Reference Value = 23.46 V/m; Power Drift = -0.03 dB

Peak SAR (extrapolated) = 1.31 W/kg

SAR(1 g) = 0.547 W/kg; SAR(10 g) = 0.291 W/kg (SAR corrected for target medium)

Smallest distance from peaks to all points 3 dB below = 10.1 mm

Ratio of SAR at M2 to SAR at M1 = 46.3%

Maximum value of SAR (measured) = 1.03 W/kg

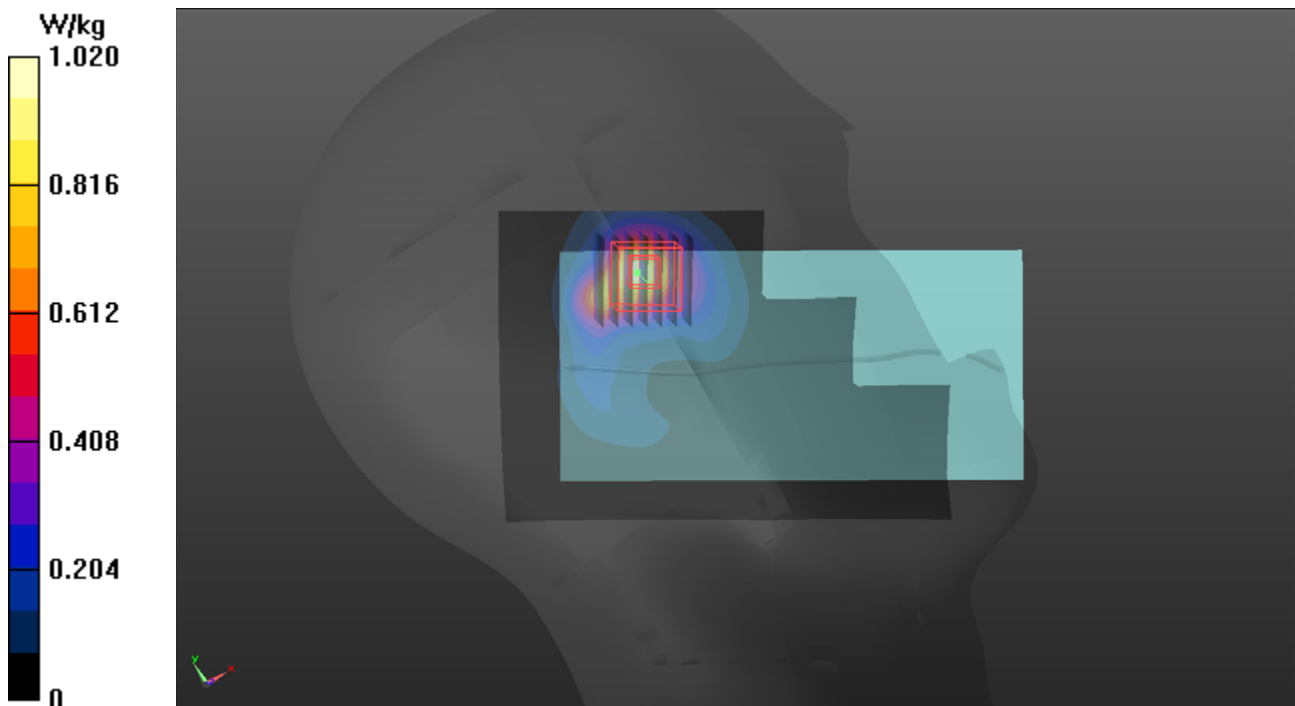

P15 WLAN5.3G_802.11ac VHT80_Left Cheek_Ch58

DUT: 200313C17

Communication System: UID 10626 - AAB, IEEE 802.11ac WiFi (80MHz, MCS0, 90pc duty cycle); Frequency: 5290 MHz; Duty Cycle: 1:1.22

Medium: H34T60N1_0720 Medium parameters used: $f = 5290$ MHz; $\sigma = 4.766$ S/m; $\epsilon_r = 36.209$; $\rho = 1000$ kg/m³

Ambient Temperature : 23.5 °C ; Liquid Temperature : 23.1 °C

DASY5 Configuration:

- Probe: EX3DV4 - SN7472; ConvF(5.67, 5.67, 5.67) @ 5290 MHz; Calibrated: 2019/08/30
- Sensor-Surface: 1.4mm (Mechanical Surface Detection)
- Electronics: DAE3 Sn579; Calibrated: 2019/08/27
- Phantom: Twin SAM Phantom_1653; Type: QD000P40CD;
- Measurement SW: DASY52, Version 52.10 (4); SEMCAD X Version 14.6.14 (7483)

Area Scan (111x201x1): Interpolated grid: dx=1.000 mm, dy=1.000 mm

Maximum value of SAR (interpolated) = 1.01 W/kg

Zoom Scan (7x7x7)/Cube 0: Measurement grid: dx=4mm, dy=4mm, dz=1.4mm

Reference Value = 14.67 V/m; Power Drift = -0.08 dB

Peak SAR (extrapolated) = 1.61 W/kg

SAR(1 g) = 0.450 W/kg; SAR(10 g) = 0.162 W/kg (SAR corrected for target medium)

Smallest distance from peaks to all points 3 dB below = 7.6 mm

Ratio of SAR at M2 to SAR at M1 = 69.2%

Maximum value of SAR (measured) = 1.06 W/kg

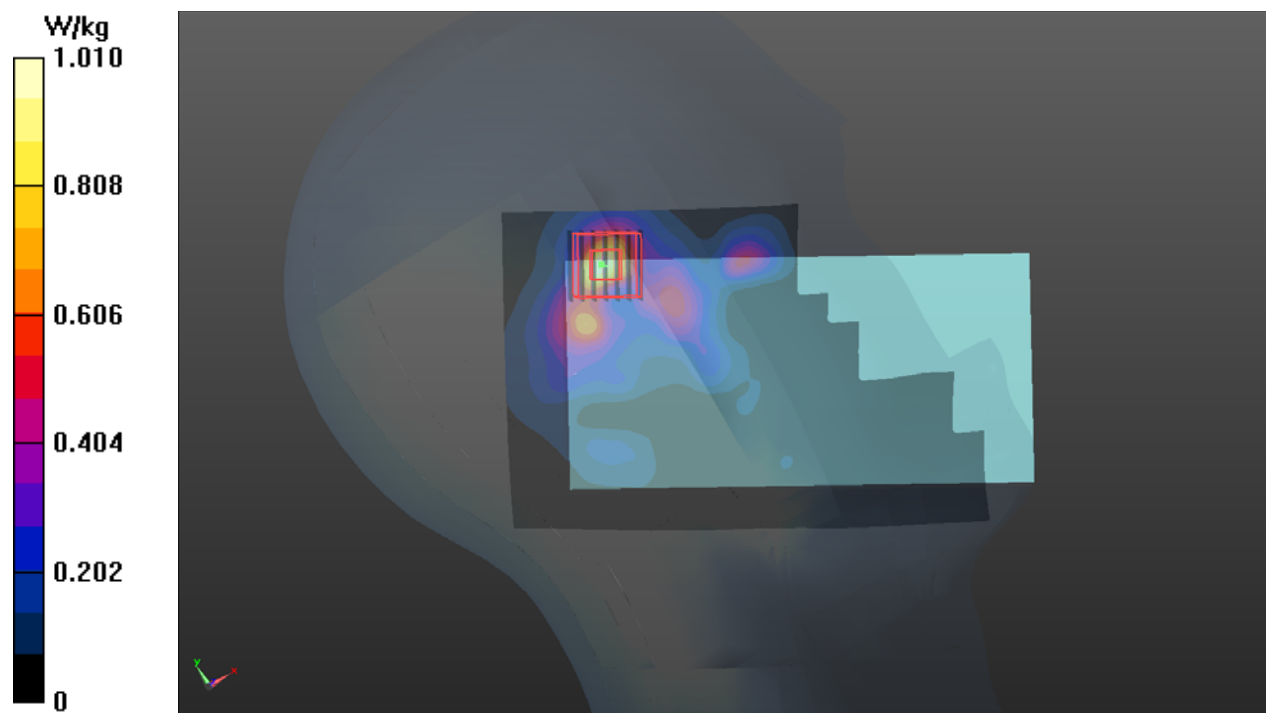

P16 WLAN5.6G_802.11ac VHT80_Left Cheek_Ch106

DUT: 200313C17

Communication System: UID 10626 - AAB, IEEE 802.11ac WiFi (80MHz, MCS0, 90pc duty cycle); Frequency: 5530 MHz; Duty Cycle: 1:1.22

Medium: H34T60N1_0720 Medium parameters used: $f = 5530$ MHz; $\sigma = 5.053$ S/m; $\epsilon_r = 35.773$; $\rho = 1000$ kg/m³

Ambient Temperature : 23.5 °C ; Liquid Temperature : 23.1 °C

DASY5 Configuration:

- Probe: EX3DV4 - SN7472; ConvF(5.1, 5.1, 5.1) @ 5530 MHz; Calibrated: 2019/08/30
- Sensor-Surface: 1.4mm (Mechanical Surface Detection)
- Electronics: DAE3 Sn579; Calibrated: 2019/08/27
- Phantom: Twin SAM Phantom_1653; Type: QD000P40CD;
- Measurement SW: DASY52, Version 52.10 (4); SEMCAD X Version 14.6.14 (7483)

Area Scan (111x201x1): Interpolated grid: dx=1.000 mm, dy=1.000 mm

Maximum value of SAR (interpolated) = 1.23 W/kg

Zoom Scan (7x7x7)/Cube 0: Measurement grid: dx=4mm, dy=4mm, dz=1.4mm

Reference Value = 15.52 V/m; Power Drift = -0.08 dB

Peak SAR (extrapolated) = 1.80 W/kg

SAR(1 g) = 0.468 W/kg; SAR(10 g) = 0.149 W/kg (SAR corrected for target medium)

Smallest distance from peaks to all points 3 dB below = 8.5 mm

Ratio of SAR at M2 to SAR at M1 = 66.8%

Maximum value of SAR (measured) = 1.26 W/kg

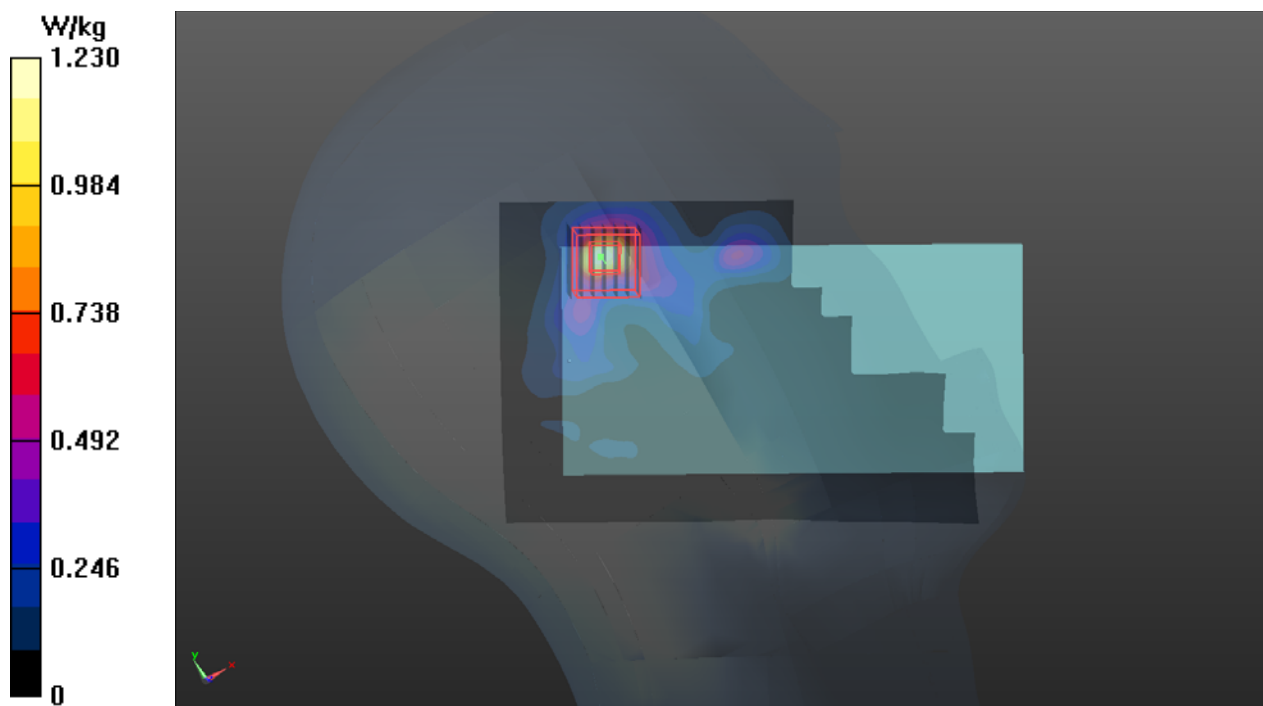

P17 WLAN5.8G_802.11ac VHT80_Left Cheek_Ch155

DUT: 200313C17

Communication System: UID 10626 - AAB, IEEE 802.11ac WiFi (80MHz, MCS0, 90pc duty cycle); Frequency: 5775 MHz; Duty Cycle: 1:1.22

Medium: H34T60N1_0720 Medium parameters used: $f = 5775$ MHz; $\sigma = 5.338$ S/m; $\epsilon_r = 35.32$; $\rho = 1000$ kg/m³

Ambient Temperature : 23.5 °C ; Liquid Temperature : 23.1 °C

DASY5 Configuration:

- Probe: EX3DV4 - SN7472; ConvF(5.23, 5.23, 5.23) @ 5775 MHz; Calibrated: 2019/08/30
- Sensor-Surface: 1.4mm (Mechanical Surface Detection)
- Electronics: DAE3 Sn579; Calibrated: 2019/08/27
- Phantom: Twin SAM Phantom_1653; Type: QD000P40CD;
- Measurement SW: DASY52, Version 52.10 (4); SEMCAD X Version 14.6.14 (7483)

Area Scan (111x201x1): Interpolated grid: dx=1.000 mm, dy=1.000 mm

Maximum value of SAR (interpolated) = 1.65 W/kg

Zoom Scan (7x7x7)/Cube 0: Measurement grid: dx=4mm, dy=4mm, dz=1.4mm

Reference Value = 18.53 V/m; Power Drift = -0.06 dB

Peak SAR (extrapolated) = 2.65 W/kg

SAR(1 g) = 0.701 W/kg; SAR(10 g) = 0.238 W/kg (SAR corrected for target medium)

Smallest distance from peaks to all points 3 dB below = 8.3 mm

Ratio of SAR at M2 to SAR at M1 = 65.6%

Maximum value of SAR (measured) = 1.70 W/kg

Zoom Scan (7x7x7)/Cube 1: Measurement grid: dx=4mm, dy=4mm, dz=1.4mm

Reference Value = 18.53 V/m; Power Drift = -0.06 dB

Peak SAR (extrapolated) = 2.48 W/kg

SAR(1 g) = 0.605 W/kg; SAR(10 g) = 0.208 W/kg (SAR corrected for target medium)

Smallest distance from peaks to all points 3 dB below = 7.9 mm

Ratio of SAR at M2 to SAR at M1 = 65.3%

Maximum value of SAR (measured) = 1.59 W/kg

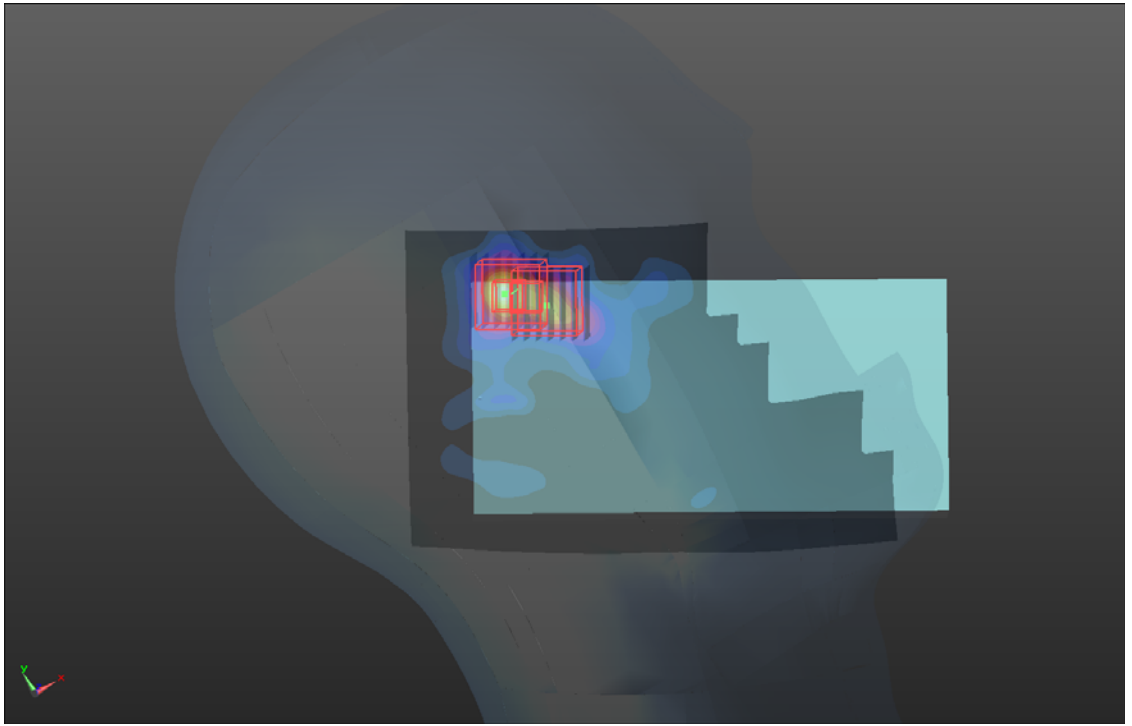
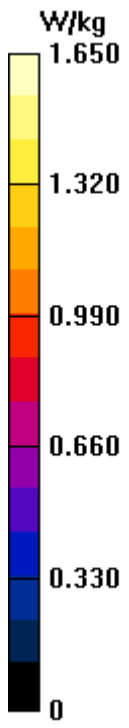

P18 BT_BDR_Left Cheek_Ch39

DUT: 200313C17

Communication System: UID 10032 - CAA, IEEE 802.15.1 Bluetooth (GFSK, DH5); Frequency: 2441 MHz; Duty Cycle: 1:1.3

Medium: H19T27N1_0909 Medium parameters used (interpolated): $f = 2441$ MHz; $\sigma = 1.867$ S/m; $\epsilon_r = 38.871$; $\rho = 1000$ kg/m³

Ambient Temperature : 23.7 °C ; Liquid Temperature : 23.1 °C

DASY5 Configuration:

- Probe: EX3DV4 - SN7472; ConvF(7.69, 7.69, 7.69) @ 2441 MHz; Calibrated: 2020/8/24
- Sensor-Surface: 1.4mm (Mechanical Surface Detection)
- Electronics: DAE3 Sn579; Calibrated: 2020/8/12
- Phantom: SAM Phantom_1982; Type: QD 000 P41 Ax;
- Measurement SW: DASY52, Version 52.10 (4); SEMCAD X Version 14.6.14 (7483)

Area Scan (91x161x1): Interpolated grid: dx=1.200 mm, dy=1.200 mm

Maximum value of SAR (interpolated) = 0.0885 W/kg

Zoom Scan (7x7x7)/Cube 0: Measurement grid: dx=5mm, dy=5mm, dz=5mm

Reference Value = 6.665 V/m; Power Drift = 0.11 dB

Peak SAR (extrapolated) = 0.118 W/kg

SAR(1 g) = 0.052 W/kg; SAR(10 g) = 0.021 W/kg (SAR corrected for target medium)

Smallest distance from peaks to all points 3 dB below: Larger than measurement grid

Ratio of SAR at M2 to SAR at M1 = 50.7%

Maximum value of SAR (measured) = 0.0907 W/kg

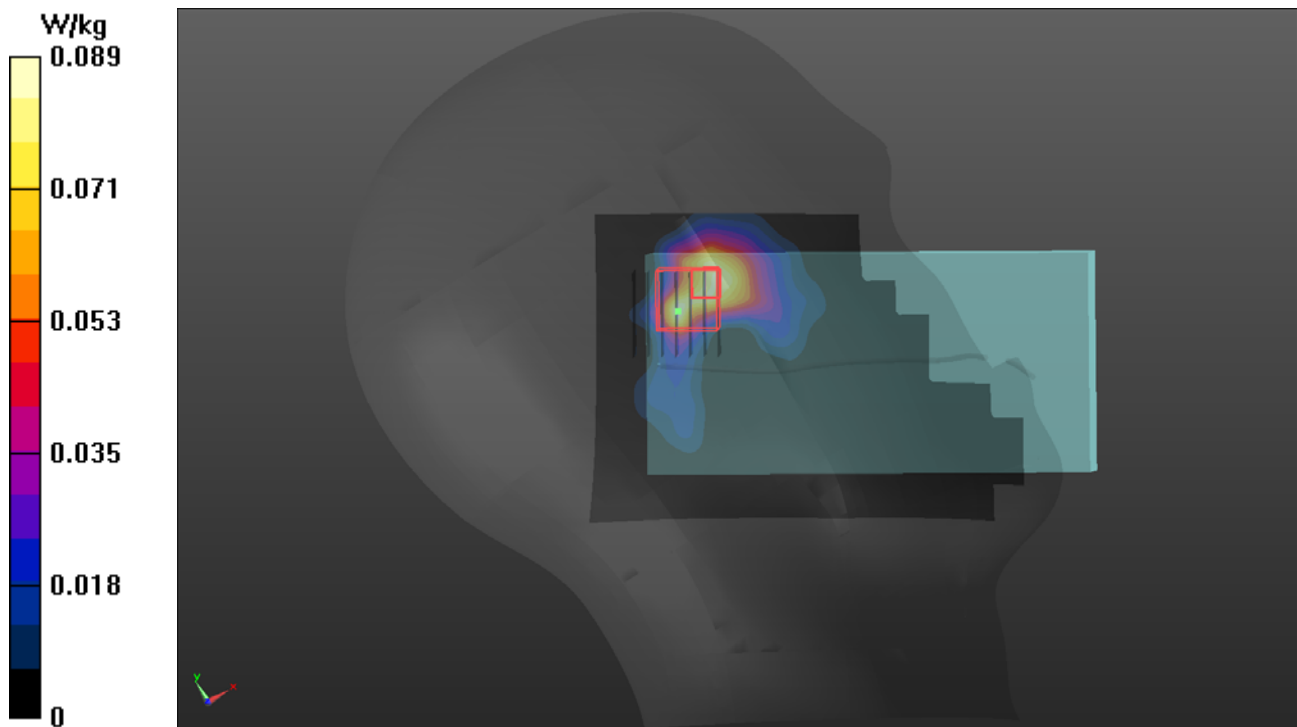

P19 GSM850_GPRS12_Rear Face_15mm_Ch128

DUT: 200313C17

Communication System: UID 10028 - DAC, GPRS-FDD (TDMA, GMSK, TN 0-1-2-3); Frequency: 824.2 MHz; Duty Cycle: 1:2.27

Medium: H07T10N2_0708 Medium parameters used (interpolated): $f = 824.2$ MHz; $\sigma = 0.912$ S/m;

$\epsilon_r = 40.579$; $\rho = 1000$ kg/m³

Ambient Temperature : 23.8 °C ; Liquid Temperature : 23.5 °C

DASY5 Configuration:

- Probe: EX3DV4 - SN7472; ConvF(10.18, 10.18, 10.18) @ 824.2 MHz; Calibrated: 2019/08/30
- Sensor-Surface: 1.4mm (Mechanical Surface Detection)
- Electronics: DAE3 Sn579; Calibrated: 2019/08/27
- Phantom: Twin SAM Phantom_1653; Type: QD000P40CD;
- Measurement SW: DASY52, Version 52.10 (4); SEMCAD X Version 14.6.14 (7483)

Area Scan (71x131x1): Interpolated grid: dx=1.500 mm, dy=1.500 mm

Maximum value of SAR (interpolated) = 0.417 W/kg

Zoom Scan (5x5x7)/Cube 0: Measurement grid: dx=8mm, dy=8mm, dz=5mm

Reference Value = 21.34 V/m; Power Drift = -0.01 dB

Peak SAR (extrapolated) = 0.443 W/kg

SAR(1 g) = 0.336 W/kg; SAR(10 g) = 0.254 W/kg (SAR corrected for target medium)

Smallest distance from peaks to all points 3 dB below = 23.8 mm

Ratio of SAR at M2 to SAR at M1 = 76.1%

Maximum value of SAR (measured) = 0.410 W/kg

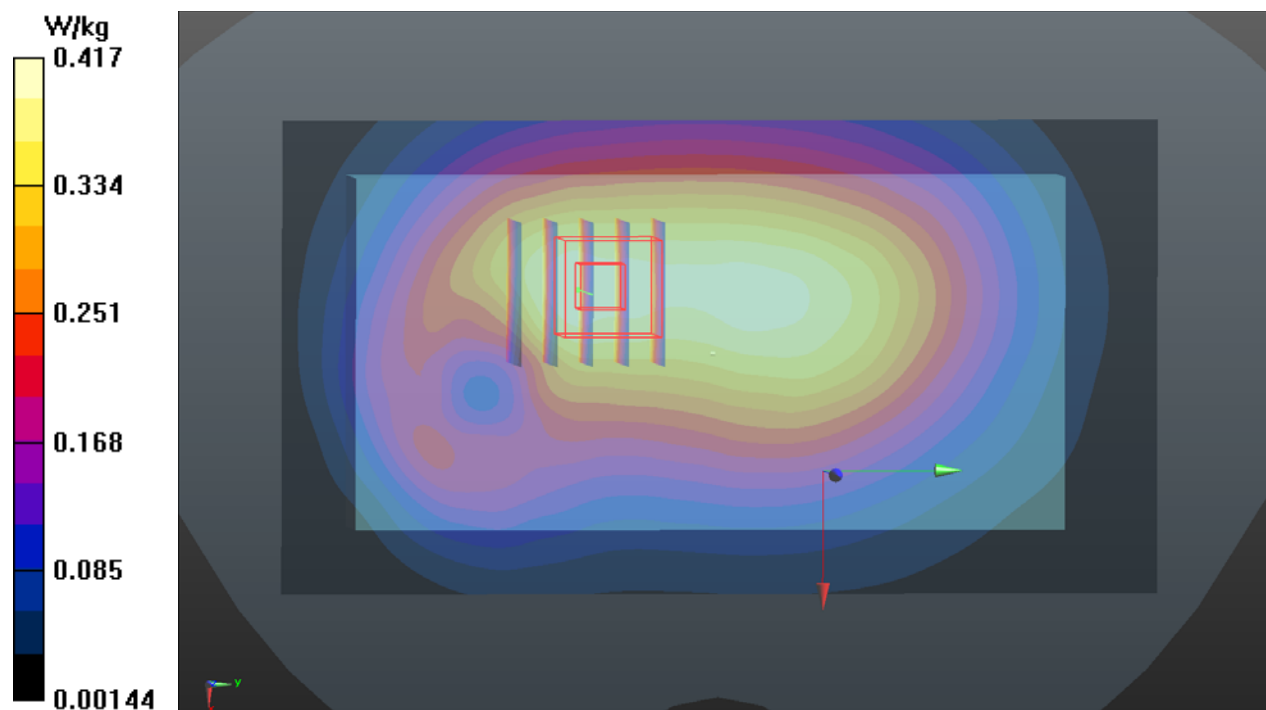

P20 GSM1900_EDGE12_Rear Face_15mm_Ch512

DUT: 200313C17

Communication System: UID 10058 - DAC, EDGE-FDD (TDMA, 8PSK, TN 0-1-2-3); Frequency: 1850.2 MHz; Duty Cycle: 1:4.49
Medium: H16T20N1_0716 Medium parameters used (interpolated): $f = 1850.2$ MHz; $\sigma = 1.419$ S/m; $\epsilon_r = 39.416$; $\rho = 1000$ kg/m³
Ambient Temperature : 23.6 °C ; Liquid Temperature : 23.3 °C

DASY5 Configuration:

- Probe: EX3DV4 - SN7472; ConvF(8.34, 8.34, 8.34) @ 1850.2 MHz; Calibrated: 2019/08/30
- Sensor-Surface: 1.4mm (Mechanical Surface Detection)
- Electronics: DAE3 Sn579; Calibrated: 2019/08/27
- Phantom: Twin SAM Phantom_1653; Type: QD000P40CD;
- Measurement SW: DASY52, Version 52.10 (4); SEMCAD X Version 14.6.14 (7483)

Area Scan (71x131x1): Interpolated grid: dx=1.500 mm, dy=1.500 mm
Maximum value of SAR (interpolated) = 1.39 W/kg

Zoom Scan (5x5x7)/Cube 0: Measurement grid: dx=8mm, dy=8mm, dz=5mm
Reference Value = 29.95 V/m; Power Drift = -0.18 dB
Peak SAR (extrapolated) = 1.56 W/kg
SAR(1 g) = 0.940 W/kg; SAR(10 g) = 0.535 W/kg (SAR corrected for target medium)
Smallest distance from peaks to all points 3 dB below = 11.6 mm
Ratio of SAR at M2 to SAR at M1 = 62.9%
Maximum value of SAR (measured) = 1.34 W/kg

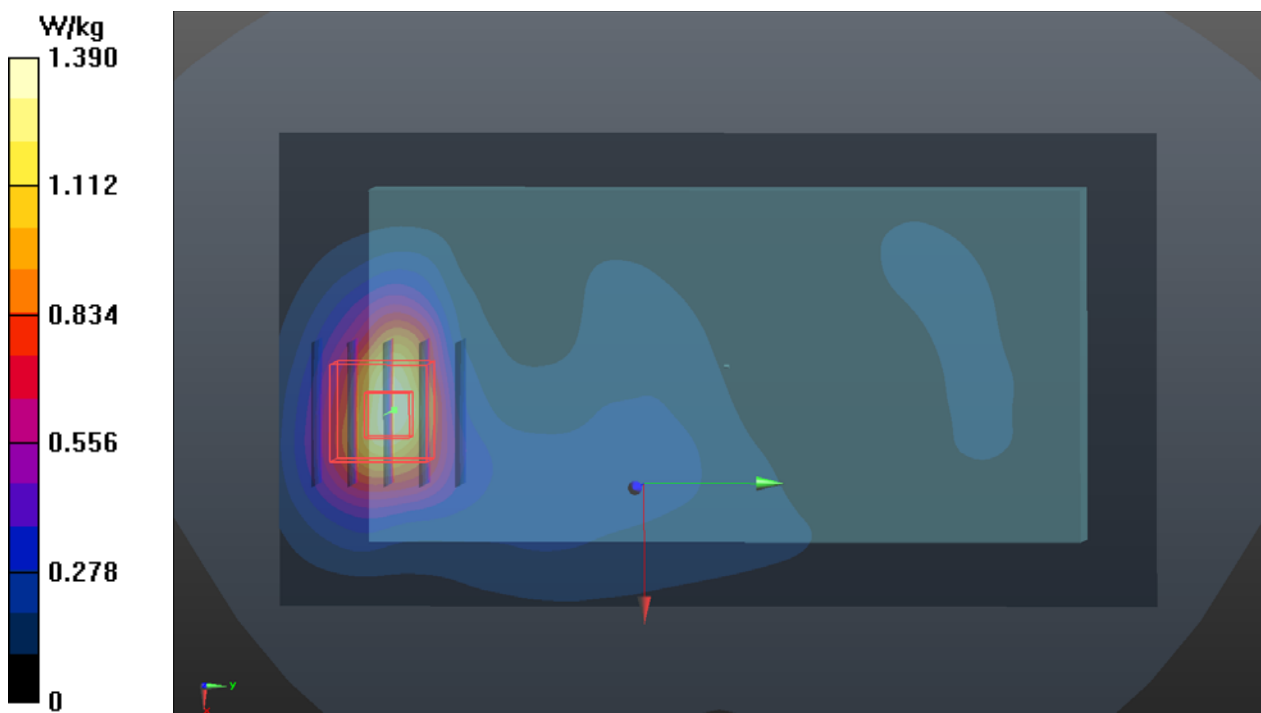

P21 WCDMA II_RMC12.2K_Rear Face_15mm_Ch9262

DUT: 200313C17

Communication System: UID 10011 - CAB, UMTS-FDD (WCDMA); Frequency: 1852.4 MHz; Duty Cycle: 1:1.95

Medium: H16T20N1_0707 Medium parameters used (interpolated): $f = 1852.4$ MHz; $\sigma = 1.418$ S/m; $\epsilon_r = 38.375$; $\rho = 1000$ kg/m³

Ambient Temperature : 23.8 °C ; Liquid Temperature : 23.5 °C

DASY5 Configuration:

- Probe: EX3DV4 - SN7472; ConvF(8.34, 8.34, 8.34) @ 1852.4 MHz; Calibrated: 2019/08/30
- Sensor-Surface: 1.4mm (Mechanical Surface Detection)
- Electronics: DAE3 Sn579; Calibrated: 2019/08/27
- Phantom: Twin SAM Phantom_1653; Type: QD000P40CD;
- Measurement SW: DASY52, Version 52.10 (4); SEMCAD X Version 14.6.14 (7483)

Area Scan (71x131x1): Interpolated grid: dx=1.500 mm, dy=1.500 mm

Maximum value of SAR (interpolated) = 1.89 W/kg

Zoom Scan (5x5x7)/Cube 0: Measurement grid: dx=8mm, dy=8mm, dz=5mm

Reference Value = 37.08 V/m; Power Drift = -0.16 dB

Peak SAR (extrapolated) = 2.15 W/kg

SAR(1 g) = 1.17 W/kg; SAR(10 g) = 0.674 W/kg (SAR corrected for target medium)

Smallest distance from peaks to all points 3 dB below = 12.8 mm

Ratio of SAR at M2 to SAR at M1 = 61.8%

Maximum value of SAR (measured) = 1.85 W/kg

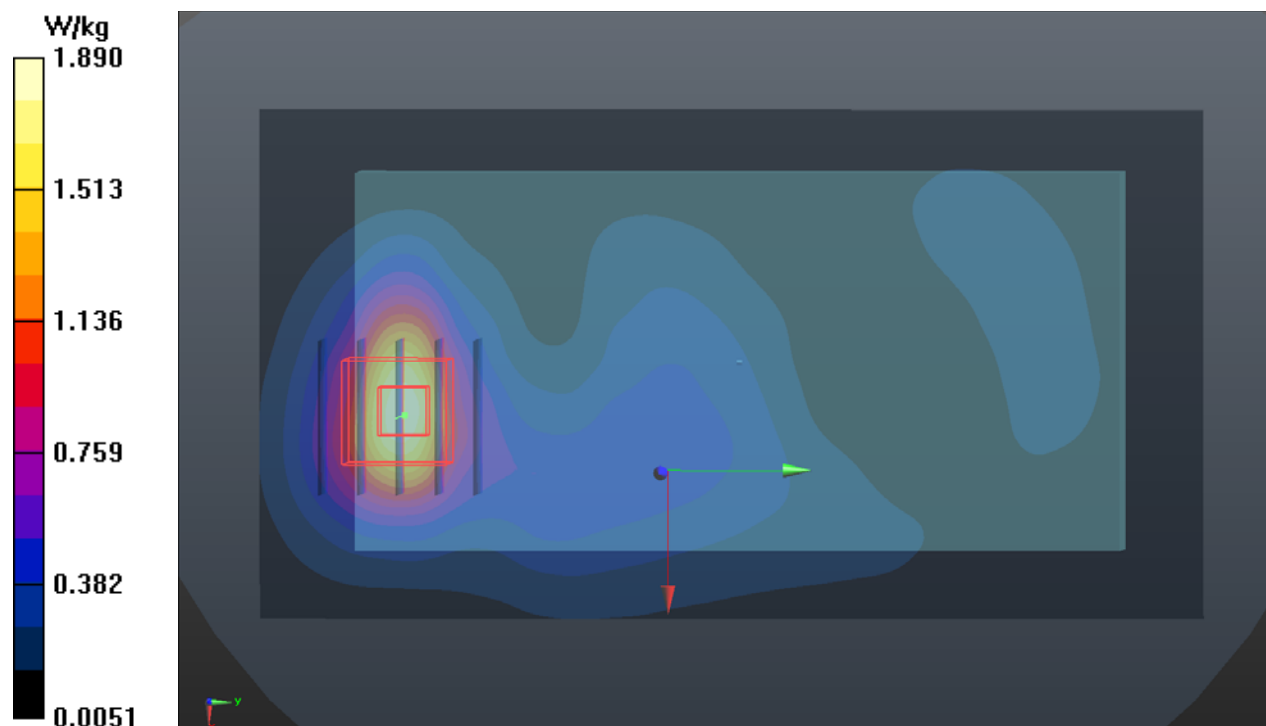

P22 WCDMA IV_RMC12.2K_Rear Face_15mm_Ch1513

DUT: 200313C17

Communication System: UID 10011 - CAB, UMTS-FDD (WCDMA); Frequency: 1752.6 MHz; Duty Cycle: 1:1.95

Medium: H16T20N1_0707 Medium parameters used: $f = 1753$ MHz; $\sigma = 1.327$ S/m; $\epsilon_r = 38.798$; $\rho = 1000$ kg/m³

Ambient Temperature : 23.8 °C ; Liquid Temperature : 23.5 °C

DASY5 Configuration:

- Probe: EX3DV4 - SN7472; ConvF(8.68, 8.68, 8.68) @ 1752.6 MHz; Calibrated: 2019/08/30
- Sensor-Surface: 1.4mm (Mechanical Surface Detection)
- Electronics: DAE3 Sn579; Calibrated: 2019/08/27
- Phantom: Twin SAM Phantom_1653; Type: QD000P40CD;
- Measurement SW: DASY52, Version 52.10 (4); SEMCAD X Version 14.6.14 (7483)

Area Scan (71x131x1): Interpolated grid: dx=1.500 mm, dy=1.500 mm

Maximum value of SAR (interpolated) = 1.69 W/kg

Zoom Scan (5x5x7)/Cube 0: Measurement grid: dx=8mm, dy=8mm, dz=5mm

Reference Value = 36.32 V/m; Power Drift = -0.10 dB

Peak SAR (extrapolated) = 1.91 W/kg

SAR(1 g) = 1.15 W/kg; SAR(10 g) = 0.664 W/kg (SAR corrected for target medium)

Smallest distance from peaks to all points 3 dB below = 11.2 mm

Ratio of SAR at M2 to SAR at M1 = 63.5%

Maximum value of SAR (measured) = 1.63 W/kg

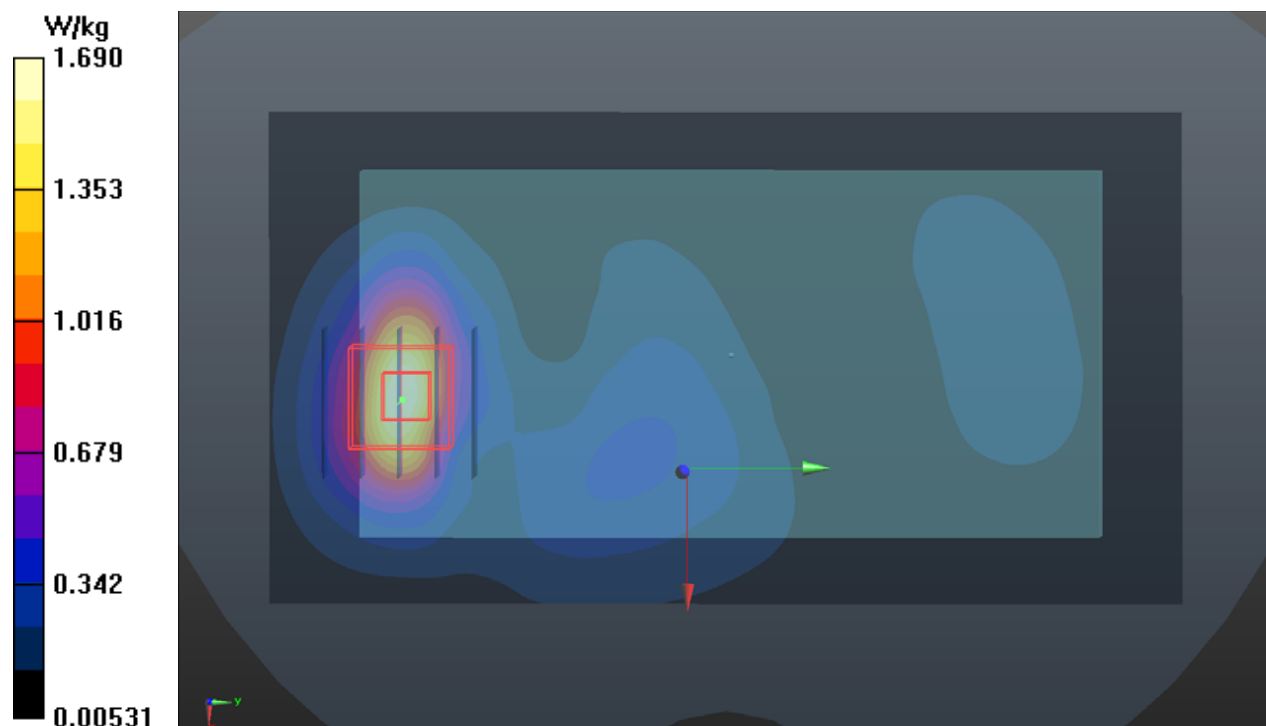

P23 WCDMA V_RMC12.2K_Rear Face_15mm_Ch4233

DUT: 200313C17

Communication System: UID 10011 - CAB, UMTS-FDD (WCDMA); Frequency: 846.6 MHz; Duty Cycle: 1:1.95

Medium: H07T10N2_0708 Medium parameters used: $f = 847$ MHz; $\sigma = 0.933$ S/m; $\epsilon_r = 40.314$; $\rho = 1000$ kg/m³

Ambient Temperature : 23.8 °C ; Liquid Temperature : 23.5 °C

DASY5 Configuration:

- Probe: EX3DV4 - SN7472; ConvF(10.18, 10.18, 10.18) @ 846.6 MHz; Calibrated: 2019/08/30
- Sensor-Surface: 1.4mm (Mechanical Surface Detection)
- Electronics: DAE3 Sn579; Calibrated: 2019/08/27
- Phantom: Twin SAM Phantom_1653; Type: QD000P40CD;
- Measurement SW: DASY52, Version 52.10 (4); SEMCAD X Version 14.6.14 (7483)

Area Scan (71x131x1): Interpolated grid: dx=1.500 mm, dy=1.500 mm

Maximum value of SAR (interpolated) = 0.544 W/kg

Zoom Scan (5x5x7)/Cube 0: Measurement grid: dx=8mm, dy=8mm, dz=5mm

Reference Value = 24.40 V/m; Power Drift = 0.02 dB

Peak SAR (extrapolated) = 0.579 W/kg

SAR(1 g) = 0.427 W/kg; SAR(10 g) = 0.316 W/kg (SAR corrected for target medium)

Smallest distance from peaks to all points 3 dB below = 18.2 mm

Ratio of SAR at M2 to SAR at M1 = 76.3%

Maximum value of SAR (measured) = 0.529 W/kg

