

Global Product Compliance Laboratory
600-700 Mountain Avenue
Room 5B-108
Murray Hill, New Jersey 07974-0636 USA



TESTING
NVLAP LAB CODE: 100275-0

Test Report

Regulation:

FCC Part 15 and 27

Client:

Nokia Mobility

Product Evaluated:

TMO V2 SOHO B2B4 (B4 LTE) with NB-IoT Guard band

Report Number:

TR-2018-0148-FCC15-27

Date Issued:

August 31, 2018

This report shall not be reproduced, in whole or in part without the approval of Nokia Global Product Compliance Laboratory. This report must not be used by the recipient to claim product endorsement by NVLAP or any other agency of the U.S. Government.

Table of Contents

1. SYSTEM INFORMATION AND REQUIREMENTS	4
1.1 INTRODUCTION	5
1.2 PURPOSE AND SCOPE	5
1.3 EUT DETAILS	5
1.3.1 <i>Test Requirements</i>	5
1.4 REFERENCE DOCUMENTS, TEST SPECIFICATIONS & PROCEDURES.....	6
1.4.1 <i>Test Specifications</i>	6
1.4.2 <i>Procedures</i>	7
1.4.3 <i>MEASUREMENT UNCERTAINTY</i>	7
1.5 EXECUTIVE SUMMARY	8
1.6 TEST CONFIGURATION FOR ALL ANTENNA PORT MEASUREMENTS.	8
2. FCC SECTION 2.1046 - RF POWER OUTPUT	9
2.1 RF POWER OUTPUT.....	9
3. FCC SECTION 2.1047 - MODULATION CHARACTERISTICS	11
3.1 MODULATION CHARACTERISTICS.....	11
4. FCC SECTION 2.1049 – OCCUPIED BANDWIDTH.....	12
4.1 OCCUPIED BANDWIDTH.....	12
4.2 OCCUPIED BANDWIDTH/ EDGE OF BAND EMISSIONS	14
4.2.1 <i>Occupied Bandwidth Results</i>	14
4.3 EDGE OF BAND EMISSIONS - SAMPLE PLOTS	15
5. FCC SECTION 2.1051 - SPURIOUS EMISSIONS AT TRANSMIT ANTENNA PORT.....	16
5.1 MEASUREMENT OF SPURIOUS EMISSIONS AT TRANSMIT ANTENNA PORT.....	16
5.1.1 <i>Spurious Emissions at Transmit Antenna Port Sample Plots</i>	17
5.1.2 <i>Spurious Emissions at Transmit Antenna Port - Photographs</i>	18
5.1.3 <i>Spurious Emissions at Transmit Antenna Port - Test Equipment</i>	18
6. FCC SECTION 2.1053 AND PART 15.109	19
6.1 SECTION 2.1053 FIELD STRENGTH OF SPURIOUS EMISSIONS	19
6.2 FIELD STRENGTH OF SPURIOUS EMISSIONS - LIMITS	19
6.3 FIELD STRENGTH OF SPURIOUS EMISSIONS RESULTS	19
6.4 FIELD STRENGTH OF SPURIOUS EMISSIONS PHOTOGRAPHS	26
6.5 FIELD STRENGTH OF SPURIOUS EMISSIONS TEST EQUIPMENT	28
7. NVLAP CERTIFICATE OF ACCREDITATION	29

Revisions

Date	Revision	Section	Change
8/29/2018	0		Initial Release
8/31/2018	1		Final review

Nokia Global Product Compliance Laboratory represents to the client that testing was done in accordance with standard procedures as applicable, and that reported test results are accurate within generally accepted commercial ranges of accuracy in accordance with the scope of our NVLAP Accreditation. Nokia Global Product Compliance reports only apply to the specific samples tested. This report is the property of the client. This report shall not be reproduced except in full without the written approval of the Nokia Global Product Compliance Laboratory.

Nokia Global Product Compliance Laboratory is accredited with the US Department of Commerce National Institute of Standards and Technology's National Voluntary Laboratory Accreditation Program (NVLAP) for satisfactory compliance with criteria established in Title 15, Part 7 Code of Federal Regulations for offering test services for selected test methods in Electromagnetic Compatibility; Voluntary Control Council for Interference (VCCI), Japan; Australian Communications and Media Authority (ACMA).

Nokia Global Product Compliance Laboratory represents to the client that the laboratory's accreditation or any of its calibration or test reports in no way constitutes or implies product certification, approval, or endorsement by NVLAP, NIST, or any agency of the federal government.

Prepared By:

Approved By:

Signed:  8/31/2018
 Nilesch Patel
 Compliance Engineer

Signed:  8/31/2018
 Raymond Johnson
 Technical Manager

Reviewed By:

Signed:  8/31/2018
 Steve Gordon
 Compliance Engineer

1. System Information and Requirements

Equipment Under Test (EUT):	TMO V2 SOHO B2B4 (B4 LTE) with NB-IoT Guard band
Serial Number:	Part 27 Testing: LBALLUASK 180306711 Part 15 Testing: LBALLUASK 180306783
Cell Name / Number	Model: SSF2II Femtocell Multi-band SOHO
FCC ID:	H8NSS2FII
Manufacturer:	Askey Computer Corp 10F, No. 119, JIANKANG RD. ZHONGHE DIST. NEW TAIPEI CITY , 23585 Taiwan
Company:	NOKIA SOLUTIONS AND NETWORKS OY KARAPORTTI 3, FI-02610 ESPOO FINLAND
Test Requirement(s):	47 CFR FCC Part 2, Part 15 and Part 27
Test Standard(s)	<ul style="list-style-type: none"> 47 CFR FCC Parts 2, 27 and 15 KDB 971168 D01 Licensed DTS Guidance v02 June 4, 2013 KDB 662911 D01 Multiple Transmitter Output v02r01 Oct 2013
Reference(s)	<ul style="list-style-type: none"> ANSI C63.26 (2015) ANSI C63.4 (2014)
Measurement Procedure(s):	FCC-IC-OBSC – GPCL FCC and IC Occupied Bandwidth and Spurious Emission Test Procedure 3-15-2016 FCC-IC-OB - GPCL Occupied Bandwidth and Power Measurement Test Procedure 12-4-2017 FCC-IC-SE - GPCL Spurious Emissions Test Procedure 12-4-2017
Test Date(s):	July/August 2018
Test Performed By:	Nokia Global Product Compliance Laboratory 600-700 Mountain Ave. P.O. Box 636 Murray Hill, NJ 07974-0636
<p>Nokia Global Product Compliance Laboratories is accredited by the National Voluntary Laboratory Accreditation Program (NVLAP®) for specific services, listed on the Scope of Accreditation, for: Electromagnetic Compatibility and Telecommunications. This laboratory is accredited in accordance with the recognized International Standard ISO/IEC 17025:2005. This accreditation demonstrates technical competence for a defined scope and the operation of a laboratory quality management system (refer to joint ISO-ILAC-IAF Communiqué dated January 2009). NVLAP LAB CODE: 100275-0.</p>	
Product Engineer(s):	Obi Okorie, Ron Remy
Lead Engineer	Steve Gordon
Test Engineer (s):	Jaideep Yadav, Eugene Mitchell, Mike Soli
<p>Test Results: The TMO V2 SOHO B2B4 (B4 LTE) with NB-IoT Guard band, <i>as tested</i> met the above listed requirements. Report copies and other information not contained in this report are held by either the product engineer or in an identified file at the Global Product Compliance Laboratory in New Providence, NJ.</p>	

1.1 Introduction

This Conformity Assessment Report applies to the TMO V2 SOHO B2B4 (B4 LTE) with NB-IoT Guard band, hereinafter referred to as the Equipment Under Test (EUT).

1.2 Purpose and Scope

The purpose of this document is to provide the testing data required for qualifying the EUT in compliance with FCC Parts 15 and 27, measured in accordance with the procedures set out in Section 2.1033 (c) (14) of the Rules.

The EUT was tested for Class II Permissive change to add NB-IoT Guard Band. Only 10, 15, and 20 MHz bandwidths were qualified during this testing.

1.3 EUT Details

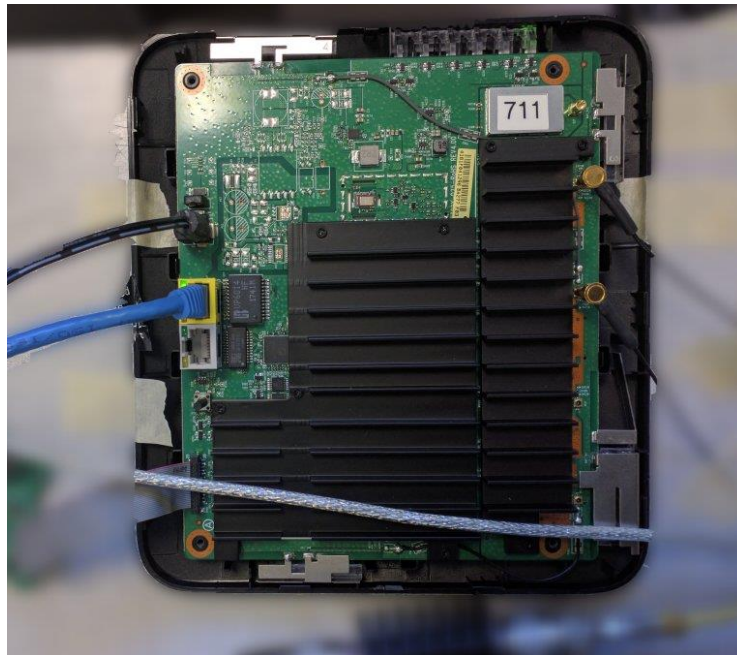

1.3.1 Test Requirements

Each required measurement is listed below:

47 CFR FCC Sections	Description of Tests	Test Required
2.1046	RF Power Output	Yes
2.1047	Modulation Characteristics	Yes
2.1049	(a) Occupied Bandwidth (b) Out-of-Band Emissions	Yes
2.1051	Spurious Emissions at Antenna Terminals	Yes
2.1053	Field Strength of Spurious Radiation	Yes

1.4 Reference Documents, Test Specifications & Procedures

A list of the applicable documents are provided in Section 1.0

1.4.1 Test Specifications

- Title 47 Code of Federal Regulations, Federal Communications Commission Part 2
- Title 47 Code of Federal Regulations, Federal Communications Commission Part 15.
- Title 47 Code of Federal Regulations , Federal Communications Commission Part 27.

1.4.2 Procedures

1. FCC-IC-0B and FCC-IC-SE
2. ANSI C63.4 (2014) entitled: “American National Standard for Methods of Measurement of Radio-Noise Emissions from Low Voltage Electrical and Electronic Equipment in the Range of 9kHz to 40 GHz”, American National Standards Institute, Institute of Electrical and Electronic Engineers, Inc., New York, NY 10017-2394, USA.
3. FCC KDB 971168 D01 Power Measurement Digital Systems v02r02 Oct 2014
FCC KDB 662911 D01 Multiple Transmitter Output v02r01 Oct 2013

1.4.3 MEASUREMENT UNCERTAINTY

The results of the calculations to estimate uncertainties for the several test methods and standards are shown in the Table below. These are the worst-case values.

Worst-Case Estimated Measurement Uncertainties

Standard, Method or Procedure	Condition	Frequency MHz	Expanded Uncertainty (k=2)
a. Classical Emissions, (e.g., ANSI C63.4, CISPR 11, 14, 22, etc., using ESHS 30,	Conducted Emissions	0.009 - 30	±3.5 dB
	Radiated Emissions (AR-6 Semi-Anechoic Chamber)	30 MHz – 200MHz H	±5.1 dB
		30 MHz – 200 MHz V	±5.1 dB
		200 MHz – 1000 MHz H	±4.7 dB
		200 MHz – 1000 MHz V	±4.7 dB
	1 GHz - 18 GHz	±3.3 dB	

Antenna Port Test	Signal Bandwidth	Frequency Range	Expanded Uncertainty (k=2), Amplitude
Occupied Bandwidth, Edge of Band, Conducted Spurious Emissions	10 Hz	9 kHz to 20 MHz	1.78 dB
	100 Hz	20 MHz to 1 GHz	
	10 kHz to 1 MHz	1 GHz to 10 GHz	
	1MHz	10 GHz to 40 GHz:	
RF Power	10 Hz to 20 MHz	50 MHz to 18 GHz	0.5 dB

1.5 Executive Summary

Requirement	Description	Result
47 CFR FCC Parts 2 and 27		
2.1046	RF Power Output Peak to Average Power Ratio	COMPLIES
2.1047	Modulation Characteristics	COMPLIES
2.1049	Occupied Bandwidth (a) Emissions Signal Bandwidth (b) Occupied Bandwidth/ Edge of Band Emissions	COMPLIES
2.1051	Spurious Emissions at Antenna Terminals	COMPLIES
2.1053	Field Strength of Spurious Radiation	COMPLIES

1. **COMPLIES** - Passed all applicable tests.
2. **N/A** – Not Applicable.
3. **NT** – Not Tested.

1.6 Test Configuration for all Antenna Port Measurements.

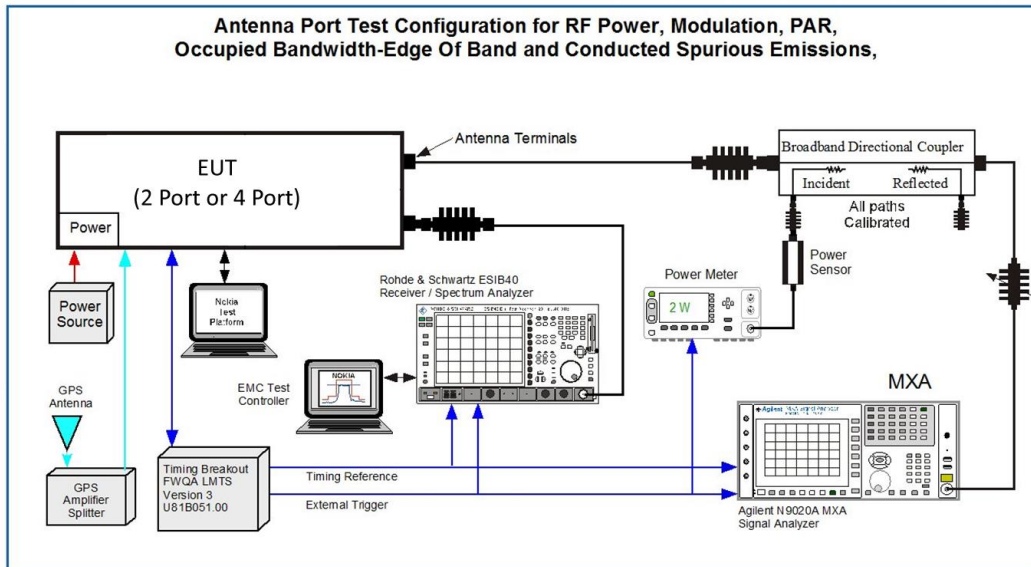

2. FCC Section 2.1046 - RF Power Output

2.1 RF Power Output

This test is a measurement of the total RF power level transmitted at the antenna-transmitting terminal. The product was configured for test as shown in Figure 1.6 above and allowed to warm up and stabilize per KDB 971168 D01 and ANSI C63.26.

Power measurements were made with a broadband Power Meter in the average mode. Before the testing was started, the Base Station was given a sufficient “warm-up” period as required.

The Data is within the parameters as previously filed.

NOTE: Only a sample of all the plots taken have been used in this report. The full suite of raw data resides at the MH, New Jersey location.

Tabular Data – Low Guard Band Channel RF Power

Modulation	Bandwidth 10 MHz		Bandwidth 15 MHz		Bandwidth 20 MHz	
	Channel MHz	RF Power dBm	Channel MHz	RF Power dBm	Channel MHz	RF Power dBm
64QAM	2115	20.64	NT	NT	2120	20.58
	2132.5	20.23	NT	NT	2132.5	21.03
	2150	21.32	NT	NT	2145	20.9
QPSK+16QAM	2115	21.08	2117.5	21.04	2120	20.84
	2132.5	21.46	2132.5	21.26	2132.5	20.93
	2150	21.44	2147.5	21.17	2145	20.98

NT=Not Tested

Tabular Data – High Guard Band Channel RF Power

Modulation	Bandwidth 10 MHz		Bandwidth 15 MHz		Bandwidth 20 MHz	
	Channel MHz	RF Power dBm	Channel MHz	RF Power dBm	Channel MHz	RF Power dBm
64QAM	2115	20.29	NT	NT	2120	20.48
	2132.5	21.01	NT	NT	2132.5	20.75
	2150	20.59	NT	NT	2145	20.87
QPSK+16QAM	2115	21.04	2117.5	20.92	2120	20.75
	2132.5	21.22	2132.5	21.21	2132.5	20.9
	2150	21.35	2147.5	21.12	2145	20.88

NT=Not Tested

Sample Plots – Channel RF Power

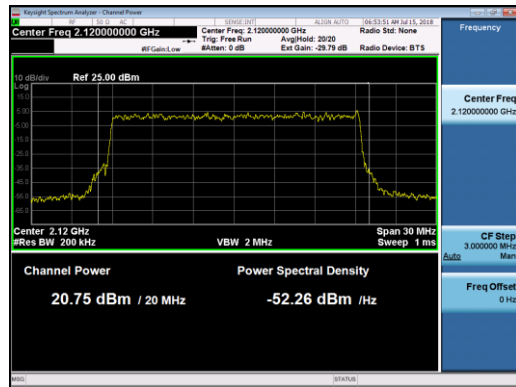
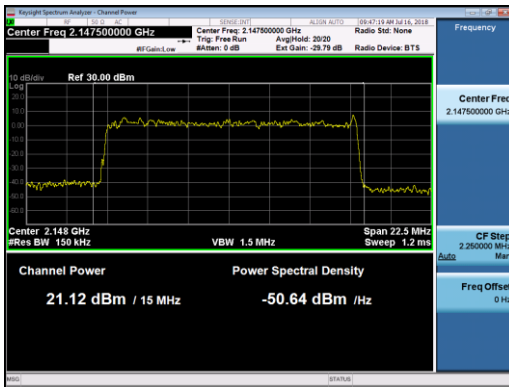
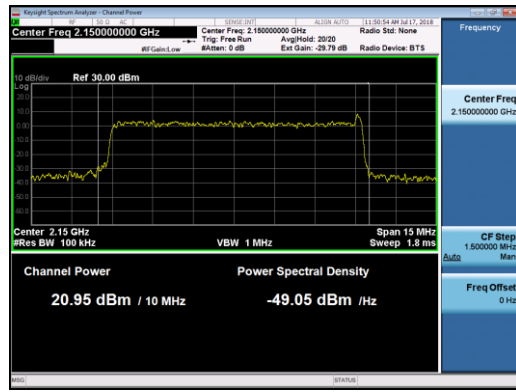
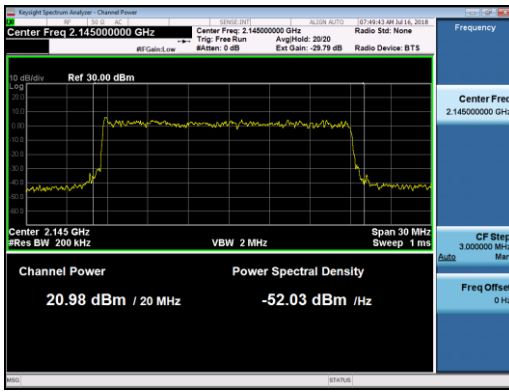
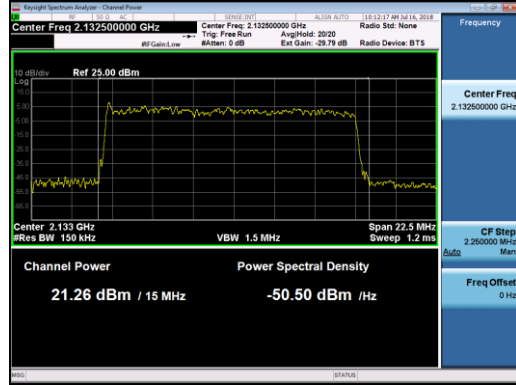
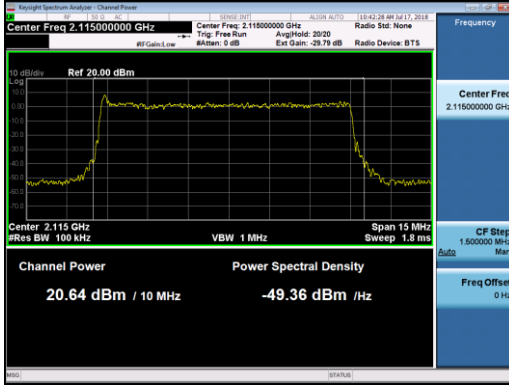

3. FCC Section 2.1047 - Modulation Characteristics

3.1 Modulation Characteristics

The product supports LTE FDD technologies. LTE utilizes Orthogonal Frequency Division Multiplexing (OFDM) which splits the carrier frequency bandwidth into many small subcarriers. Each individual subcarrier can be modulated with a combined QPSK + 16QAM, or 64QAM digital modulation formats.

In QPSK, there are 4 possible symbol states and each symbol carries 2 bits of information. In 16QAM, there are 16 possible symbol states and each 16-QAM symbol carries 4 bits of information. In 64QAM, there are 64 possible symbol states and each 64-QAM symbol carries 6 bits of information. The higher-order modulations, where the constellations become more dense, are more sensitive to poor channel conditions than the lower-order modulation. The Narrow Band Internet of Things (NB-IoT) increases the power to a single data stream for a low data rate (Narrow Band) Internet of Things coverage. Spectrally it looks like a single peak at the edge of the transmit signal.

The RF signal at the antenna port was demodulated and verified for correctness of the modulation signal used before each test was performed. For these products the operation with QPSK+16QAM and 64QAM modulation with NB-IoT was evaluated and verified.

NOTE: Only a sample of all the data taken have been used in this report. The full suite of raw data resides at the MH, New Jersey location.

QPSK

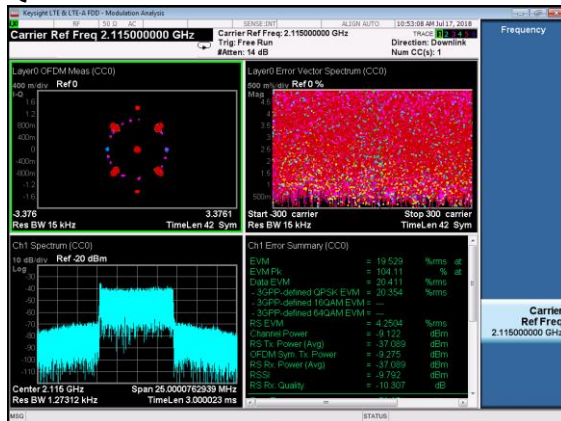

QPSK+16QAM

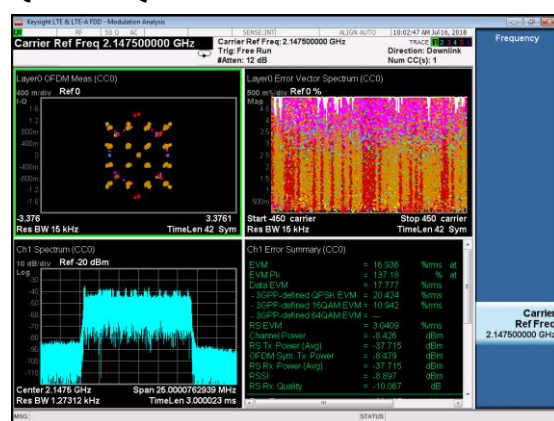

64QAM

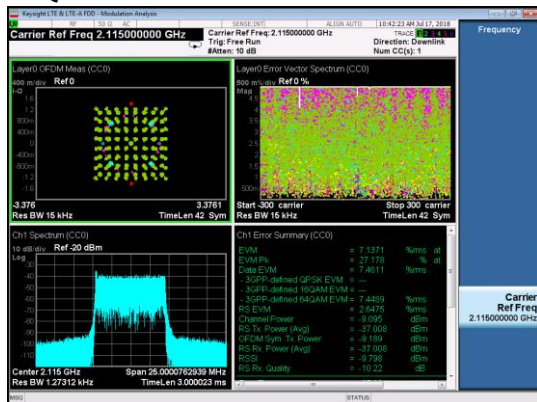

4. FCC Section 2.1049 – Occupied Bandwidth

4.1 Occupied Bandwidth

In 47CFR 2.1049 the FCC requires:

“The occupied bandwidth, that is the frequency bandwidth such that, below its lower and above its upper frequency limits, the mean powers radiated are each equal to 0.5 percent of the total mean power radiated by a given emission shall be measured under the following conditions as applicable.”

This required measurement is the 99% Occupied Bandwidth, also called the designated signal bandwidth and needs to be within the parameters of the products specified emissions designator. The -26 dB bandwidth values were also recorded.

During these measurements it is customary to evaluate the Edge of Band emissions at block/band edges.

The transmitted signal occupied bandwidth was measured using a Keysight MXA Signal Analyzer. All emissions were within the parameters as previously filed. Sample Charts are below.

Tabular Data – Low Guard Band Occupied Bandwidth

Modulation	Bandwidth 10 MHz		Bandwidth 15 MHz		Bandwidth 20 MHz	
	Channel MHz	OBW MHz	Channel MHz	OBW MHz	Channel MHz	OBW MHz
64QAM	2115	9.15	NT	NT	2120	18.082
	2132.5	9.1476	NT	NT	2132.5	18.069
	2150	9.154	NT	NT	2145	18.093
QPSK+16QAM	2115	9.1485	2117.5	13.636	2120	18.058
	2132.5	9.149	2132.5	13.624	2132.5	18.042
	2150	9.1606	2147.5	13.631	2145	18.051

NT=Not Tested

Tabular Data – High Guard Band Occupied Bandwidth

Modulation	Bandwidth 10 MHz		Bandwidth 15 MHz		Bandwidth 20 MHz	
	Channel MHz	OBW MHz	Channel MHz	OBW MHz	Channel MHz	OBW MHz
64QAM	2115	9.4161	NT	NT	2120	18.082
	2132.5	9.1458	NT	NT	2132.5	18.08
	2150	9.1549	NT	NT	2145	19.094
QPSK+16QAM	2115	9.1342	2117.5	13.621	2120	18.095
	2132.5	9.1334	2132.5	13.62	2132.5	18.084
	2150	9.1452	2147.5	13.628	2145	18.121

NT=Not Tested

Sample Plots – Occupied Bandwidth

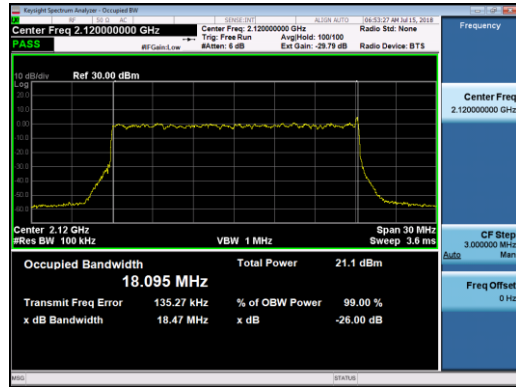
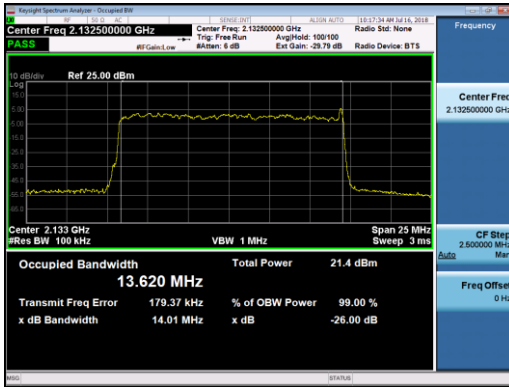
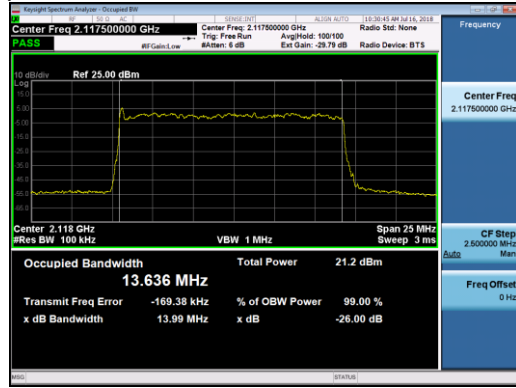

4.2 Occupied Bandwidth/ Edge of band Emissions

The Edge of Band emissions of the EUT at the external antenna connector (EAC) were measured using a Keysight MXA Signal Analyzer . The RF power level was continuously measured using a RF broadband power meter. The RF output from the EAC port to spectrum analyzer was reduced (to an amplitude usable by the spectrum analyzer) by using a calibrated attenuator and test coupler. The path attenuation was offset on the display and the signal for single carrier was adjusted to the corrected RF power level for the resolution bandwidth used for the transmit signal. All mask values were adjusted based upon the designated signal bandwidth and measurement bandwidths. The Top of Mask corresponds to the set rated power level as confirmed by the RF power meter.

4.2.1 Occupied Bandwidth Results.

The Occupied Bandwidth was measured for all three modulations, at each signal bandwidth and at left center and right side of band. The mask on the plots meet the Block Edge requirements as specified in 47CFR 27.53.

All of the measurements met the requirements of Part 27.53 when measured per Part 2-1049.

NOTE: Only a sample of all the data taken have been used in this report. The full suite of data resides at the MH, New Jersey location.

4.3 Edge of band Emissions - Sample Plots

10 MHz Left Side of Band QPSK

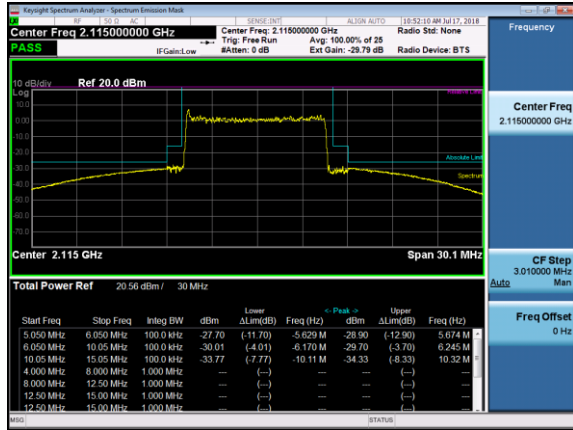

10 MHz Right Side of Band QPSK

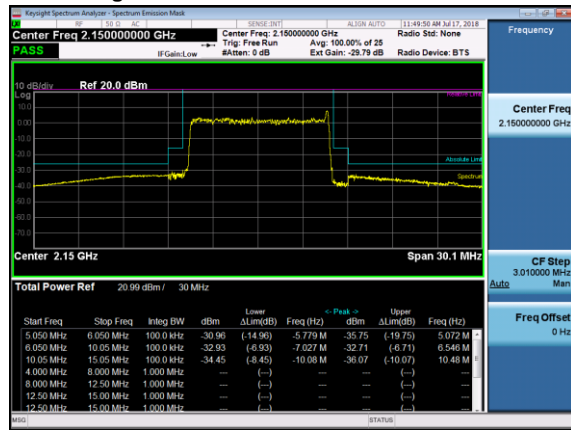

15 MHz Left Side of Band QPSK+16QAM

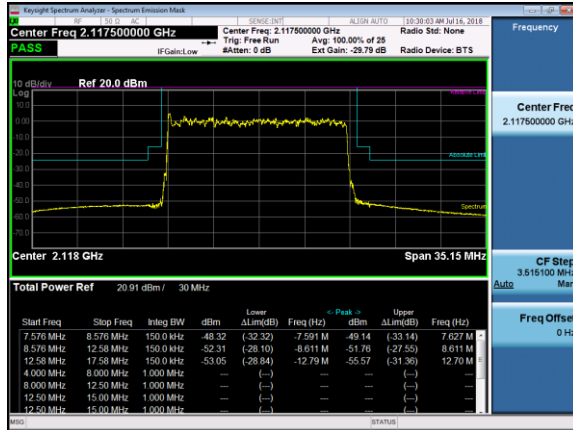

15 MHz Right Side of Band QPSK+16QAM

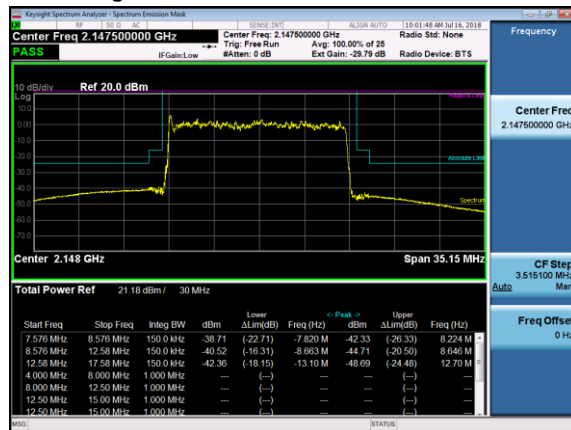

20 MHz Left Side of Band QPSK+16QAM

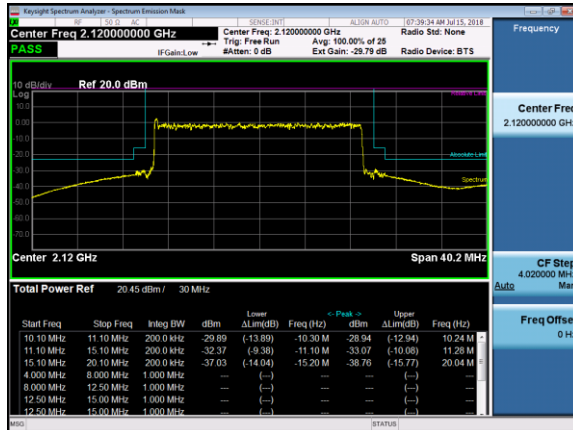

20 MHz Right Side of Band QPSK+16QAM



5. FCC Section 2.1051 - Spurious Emissions at Transmit Antenna Port

5.1 Measurement of Spurious Emissions at Transmit Antenna Port

Spurious Emissions at the transmit-antenna terminals were investigated over the frequency range of 10 MHz to beyond the 10th harmonic of the specific transmit band. For this band of operation, the measurements were performed up to 22GHz. Measurements were made using a Keysight MXA Signal Analyzer. The RF output from the transmitter was reduced (to an amplitude usable by the receivers) using calibrated attenuators. The RF power level was continuously monitored via a coupled RF Power Meter.

The required emission limitation is specified as appropriate in 27.53. The measured spurious emission levels were plotted for the frequency range as specified in 2.1057. There were no reportable emissions. Data below documents performance up to 22 GHz.

NOTE: Only a sample of all the data taken have been used in this report. The full suite of raw data resides at the MH, New Jersey location.

5.1.1 Spurious Emissions at Transmit Antenna Port Sample Plots

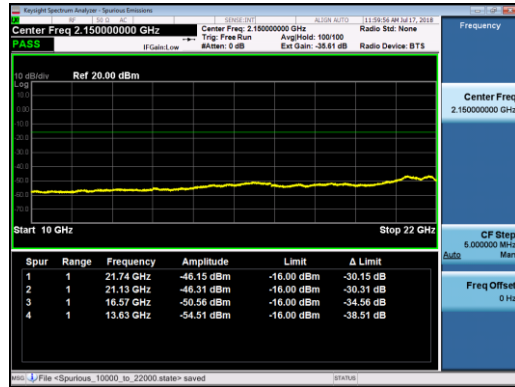
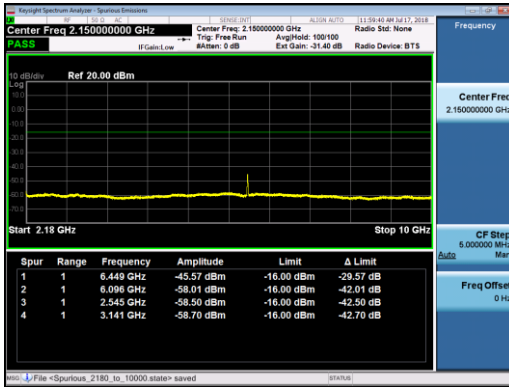
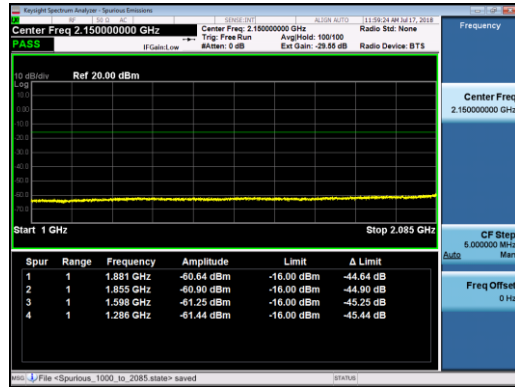
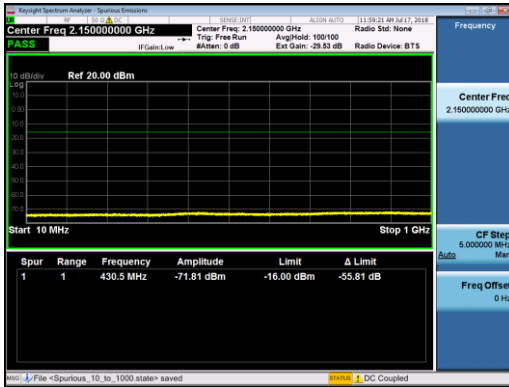

5.1.2 Spurious Emissions at Transmit Antenna Port - Photographs

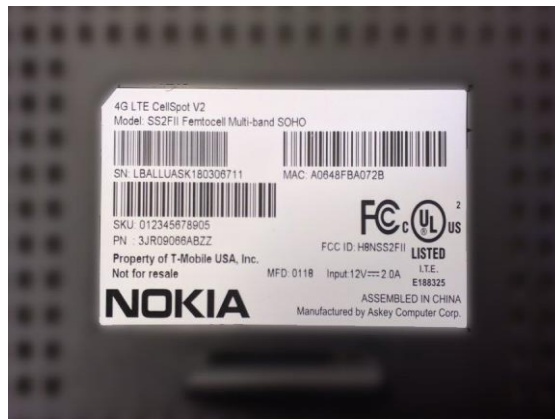
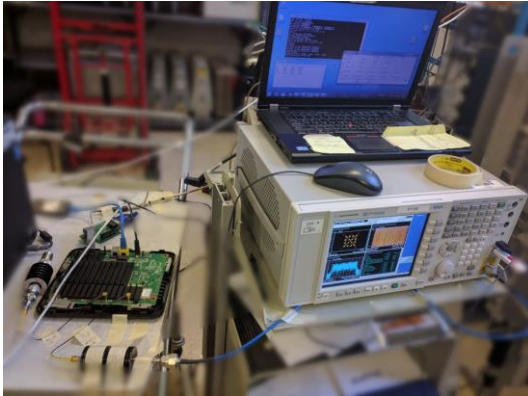

5.1.3 Spurious Emissions at Transmit Antenna Port - Test Equipment

Asset ID	Manufacturer	Type	Description	Model	Serial	Calibration Date	Calibration Due	Calibration Type	Status
E1152	Agilent Technologies	MXA Signal Analyzer	20Hz-26.5GHz Analyzer	N9020A	MY53420147	2017-03-13	2019-03-13	Requires Calibration	Active
E130	Hewlett Packard	HP-IB Extender	HPIB Extender	37204	3212U23686			Calibration Not Required	Active

6. FCC Section 2.1053 and Part 15.109

6.1 Section 2.1053 Field Strength of Spurious Emissions

Field strength measurements of radiated spurious emissions were made in 3m Semi-Anechoic Chambers the of Global Product Compliance Laboratories of Nokia Bell Labs in Murray Hill NJ. A complete description and full measurement data for the site is on file with the Commission (FCC File 515091).

The spectrum from 30 MHz to beyond the tenth harmonic of the carrier, 26.5 GHz, was searched for spurious radiation. Measurements were made using both horizontally and vertically polarized broadband antennas. Per FCC regulations, the comparison of out of band spurious emissions directly to the limit is appropriately made using the substitution method. However, when the emissions are more than 20 dB below the specification limit, the use of field strength measurements for compliance determination is acceptable and those emissions are considered not reportable (Section 2.1053 and the FCC Interpretive database for 2.1053). For this case the evaluation of acceptable radiated field strength is as follows.

6.2 Field Strength of Spurious Emissions - Limits

Sections 2.1053 and 27.53 contain the requirements for the levels of spurious radiation as a function of the level of the unmodulated carrier. The reference level for the unmodulated carrier is calculated as the field produced by an ideal dipole excited by the transmitter output power according to the following relation taken from Reference Data for Radio Engineers, page 676, 4th edition, IT&T Corp.

$$E = [(30 \cdot P)^{1/2}] / R$$

$$20 \log (E \cdot 10^6) - (43 + 10 \log P) = 82.23 \text{ dB}\mu\text{V/m}$$

Where:

E = Field Intensity in Volts/meter

P = Transmitted Power in Watts

R = Measurement distance in meters = 3 m

The Part 27 Limit is 62.23 dB μ V/m at 3m and 91.77 dB μ V/m at 1m

The Part 27 non-report level is 62.23 dB μ V/m at 3m.

The FCC Part 15 Class B limit is 54 dB μ V/m at 3m.

The calculated emission levels were found by:

$$\text{Measured level (dB}\mu\text{V)} + \text{Cable Loss(dB)} + \text{Antenna Factor(dB)} = \text{Field Strength (dB}\mu\text{V/m)}$$

6.3 Field Strength of Spurious Emissions Results

RESULTS:

For compliance with 47CFR Parts 2 and 27, the field strength of any spurious radiation, measured at 3m, is required to be less than 82.23 dB μ V/meter (82.23 @ 3m). Emissions equal to or less than 62.23 dB μ V/meter at 3m are not reportable and may be verified using field strength measurements and broadband antennas. Over the out of band spectrum investigated from 30 MHz to beyond the tenth harmonic of the carrier (up to 26.5 GHz), one reportable spurious emissions was detected. The 6449.44 MHz emission at 62.66 dB μ V/m/MHz had 19.57 dB of margin to the limit. A representative set of measurement scans are included below.

T12 RADIATED EMISSIONS 30 MHz – 200 MHz

FCCB_64QAM

24 Aug 18 08:46

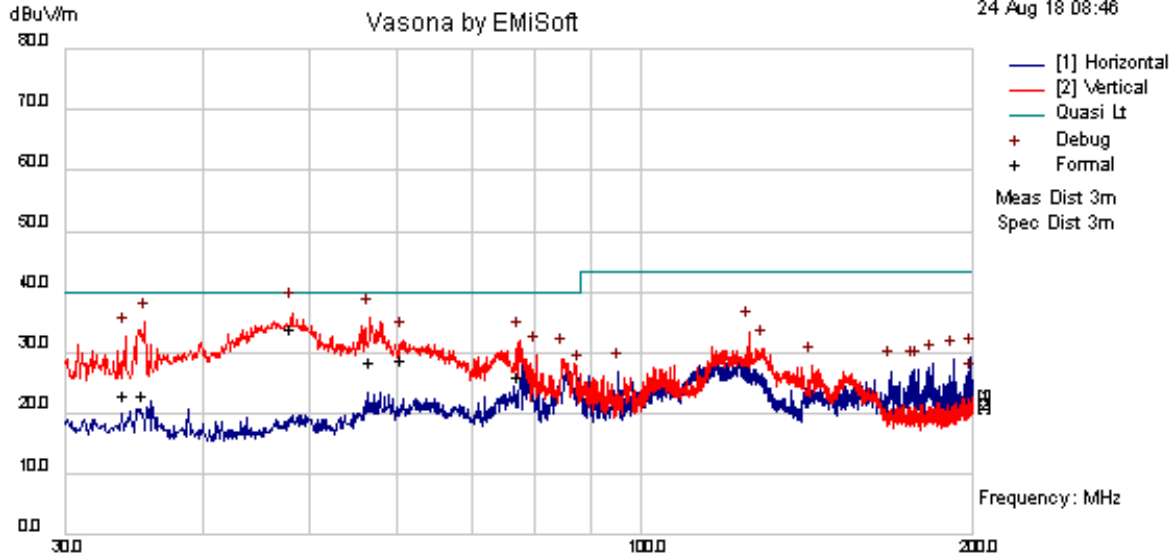

Radiated Emissions Template: RE 30M-1GHz Bicon-Log 3m
 Filename: c:\program files\emisoft - vasona\results\2018-0085+83\T11 RE 200 MHz - 1 GHz FCCB.emi

Results Title:	RE 30M-200 MHz Bicon-Log 3m
File Name:	c:\program files\emisoft - vasona\results\2018-148\T12 RE 30 MHz - 200 MHz FCCB.emi
Test Laboratory:	GPCL AR6MH 23C 67%RH, 995mB
Test Engineer:	SEG
Test Software:	Vasona by EMIsoft, version 2.161
Equipment:	Nokia
EUT Details:	TMO V1 B@B\$ (B4 LTE) Model: 9961 Home Cell V1; P/N: 3JRO9051ABEC; S/N: LBALLUASK171100867 Rev:02 ; FCC ID:H8N9961V1. TX Output: 2115 MHz, 10 MHz BW, 64QAM, 20 dBm, NB-IOT, Guardband. TMO V2 SOHO B2B4 (B4 LTE) Part 15/Part 27 Also identified as 4G LTE Cell Spot V2V2 Model: SS2FII Femtocell Multiband SOHO [S/N:LBALLUAK180306783]; FCC ID: H8NSS2FI; TX Output: 2150 MHz, 10 MHz BW, 64QAM, 21 dBm, NB-IOT , Guard band
Configuration:	Radiated Emissions 30MHz -200 MHz FCC Part 15 B Class B, RCVR E908, Preamp E512, 6dB pad(E889), Bicon Antenna E051, 3M Distance offset, ESI- Preview BW (30 kHz RBW/ 30 kHz VBW); Formal BW (default). Analyzer Reference Level: 100 dBuV, Internal Attenuation: 10 dB. Project 2018-0148 / 147
Date:	2018-08-24 11:11:49

Formal Data

Frequency. MHz	Raw dBuV	Cable dB	Factor dB	Level dBuV/m	Emission Type	Pol H/V	Ht. cm	Az. Deg.	Limit dBuV/m	Margin dB	Pass /Fail	Comments
48.026	44.64	6.77	-21	30.45	Quasi Max	V	125	158	40	-9.55	Pass	
60.529	41.2	6.86	-22.8	25.25	Quasi Max	V	150	168	40	-14.75	Pass	
56.707	40.48	6.83	-22.3	24.99	Quasi Max	V	192	151	40	-15.01	Pass	
77.553	39.73	7.05	-24.3	22.47	Quasi Max	V	188	9	40	-17.53	Pass	
33.994	31.48	6.75	-18.7	19.56	Quasi Max	V	113	40	40	-20.44	Pass	
35.299	31.56	6.75	-18.9	19.44	Quasi Max	V	294	1	40	-20.56	Pass	

Preview Data

Frequency. MHz	Raw dBuV	Cable dB	Factor dB	Level dBuV/m	Emission Type	Pol H/V	Ht. cm	Az. Deg.	Limit dBuV/m	Margin dB	Pass /Fail	Comments
48.0842	50.82	6.77	-21	36.61	Preview	V	105	90	40	-3.39	Pass	
56.6453	51.11	6.83	-22.3	35.64	Preview	V	205	0	40	-4.36	Pass	
35.3868	47.13	6.75	-18.9	35.01	Preview	V	105	45	40	-4.99	Pass	
33.9439	44.53	6.75	-18.7	32.62	Preview	V	105	45	40	-7.38	Pass	
77.4228	49.23	7.04	-24.3	32	Preview	V	205	0	40	-8	Pass	
60.5892	47.79	6.86	-22.8	31.82	Preview	V	105	270	40	-8.18	Pass	
125.038	45.89	7.51	-19.9	33.53	Preview	V	105	180	43.5	-9.97	Pass	
80.3086	47.23	7.09	-24.8	29.54	Preview	V	105	135	40	-10.46	Pass	
84.9259	46.52	7.16	-24.7	28.99	Preview	V	105	135	40	-11.01	Pass	
128.693	42.77	7.53	-19.7	30.64	Preview	V	105	135	43.5	-12.86	Pass	
199.218	39.3	7.83	-17.9	29.26	Preview	H	190	270	43.5	-14.24	Pass	
191.976	39.45	7.81	-18.3	28.93	Preview	H	105	270	43.5	-14.57	Pass	
183.535	39.37	7.78	-19.1	28.1	Preview	H	105	270	43.5	-15.4	Pass	
142.641	39.45	7.6	-19.3	27.78	Preview	V	105	45	43.5	-15.72	Pass	
177.96	38.8	7.75	-19.4	27.17	Preview	H	190	270	43.5	-16.33	Pass	
176.762	38.87	7.75	-19.5	27.16	Preview	H	105	270	43.5	-16.34	Pass	

Note: Preview data was measured using a peak detector to identify frequencies of interest for formal measurement. Formal data consist of all frequencies in the preview list within 6 dB of specification limit or the top six frequencies. Failure in preview data does not necessarily constitute failure in formal data.

T11 RADIATED EMISSIONS 200 MHz 1 GHz

FCCB_64QAM

24 Aug 18 08:40

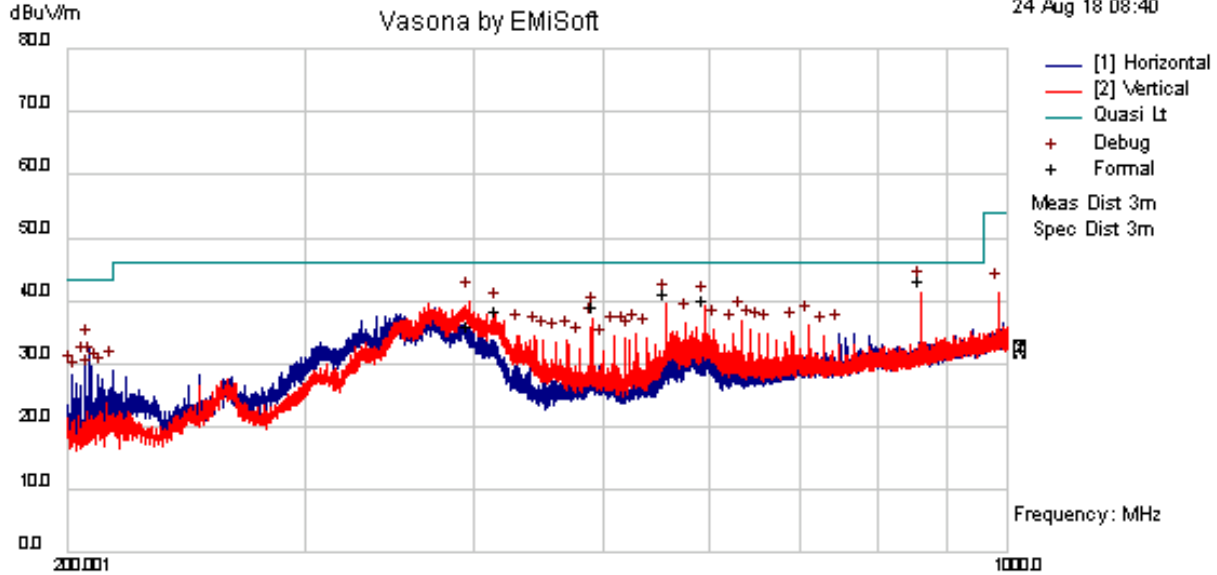

Radiated Emissions Template: RE 30M-1GHz Bicon-Log 3m
 Filename: Data not stored

Results Title:	RE 30M-1GHz Bicon-Log 3m
File Name:	c:\program files\emisoft - vasona\results\2018-0148\T11 RE 200 MHz - 1 GHz FCCB.emi
Test Laboratory:	GPCL AR6MH 23C 67%RH, 995mB
Test Engineer:	MJS / SEG
Test Software:	Vasona by EMIsoft, version 2.161
Equipment:	Nokia
EUT Details:	TMO V1 B@B\$ (B4 LTE) Model: 9961 Home Cell Vi; P/N: 3JRO9051ABEC; S/N: LBALLUASK171100867 Rev:02; FCC ID:H8N9961V1. TX Output: 2115 MHz, 10 MHz BW, 64QAM, 20 dBm, NB-IOT, Guardband. TMO V2 SOHO B2B4 (B4 LTE) Part 15/Part 27 Also identified as 4G LTE Cell Spot V2V2 Model: SS2FII Femtocell Multiband SOHO [S/N:LBALLUAK180306783]; FCC ID: H8NSS2FII; TX Output: 2150 MHz, 10 MHz BW, 64QAM, 21 dBm, NB-IOT, Guard band
Configuration:	Radiated Emissions 200MHz -1GHz FCC Part 15 B Class B, RCVR E908, Preamp E512, 6dB pad(E889), Log-Periodic Antenna E060, 3M Distance offset, ESI- Preview BW (30 kHz RBW/ 30 KHz VBW); Formal BW (default). Analyzer Reference Level: 100 dBuV, Internal Attenuation: 10 dB. Project 2018-0148 / 147
Date:	2018-08-24 08:46:39

Formal Data

Frequency. MHz	Raw dBuV	Cable dB	Factor dB	Level dBuV/m	Emission Type	Pol H/V	Ht. cm	Az. Deg.	Limit dBuV/m	Margin dB	Pass /Fail	Comments
860.164	38.27	9.85	-8.35	39.77	Quasi Max	H	104	185	46	-6.23	Pass	
556.79	41.55	8.99	-12.8	37.77	Quasi Max	V	100	309	46	-8.23	Pass	
595.178	39.69	9.1	-12.2	36.58	Quasi Max	V	117	312	46	-9.42	Pass	
491.523	39.66	8.79	-12.6	35.83	Quasi Max	V	126	299	46	-10.17	Pass	
415.994	41.77	8.56	-15.5	34.86	Quasi Max	V	115	109	46	-11.14	Pass	
397.317	39.69	8.5	-15.7	32.44	Quasi Max	V	139	226	46	-13.56	Pass	

Preview Data

Frequency. MHz	Raw dBuV	Cable dB	Factor dB	Level dBuV/m	Emission Type	Pol H/V	Ht. cm	Az. Deg.	Limit dBuV/m	Margin dB	Pass /Fail	Comments
860.14	39.9	9.85	-8.35	41.39	Preview	H	105	180	46	-4.61	Pass	
397.359	46.99	8.5	-15.7	39.75	Preview	V	105	135	46	-6.25	Pass	
556.846	43.32	8.99	-12.8	39.55	Preview	V	105	315	46	-6.45	Pass	
595.323	42.17	9.1	-12.2	39.06	Preview	V	105	315	46	-6.94	Pass	
416.02	45.1	8.56	-15.5	38.18	Preview	V	105	90	46	-7.82	Pass	
491.531	41.06	8.79	-12.6	37.23	Preview	V	105	270	46	-8.77	Pass	
633.607	39.13	9.2	-11.6	36.73	Preview	V	105	135	46	-9.27	Pass	
576.084	39.92	9.04	-12.5	36.48	Preview	V	105	315	46	-9.52	Pass	
710.369	36.83	9.4	-10.1	36.09	Preview	V	105	0	46	-9.91	Pass	
489.703	39.61	8.78	-12.7	35.67	Preview	V	105	315	46	-10.33	Pass	
643.419	37.71	9.23	-11.5	35.48	Preview	V	105	0	46	-10.52	Pass	
604.749	38.2	9.12	-12.1	35.27	Preview	V	105	315	46	-10.73	Pass	
691.226	36.31	9.34	-10.6	35.1	Preview	V	105	0	46	-10.9	Pass	
652.846	36.89	9.25	-11.3	34.83	Preview	V	105	135	46	-11.17	Pass	
527.892	38.94	8.9	-13.1	34.75	Preview	V	105	315	46	-11.25	Pass	
748.846	35.03	9.52	-9.81	34.74	Preview	H	105	225	46	-11.26	Pass	

Note: Preview data was measured using a peak detector to identify frequencies of interest for formal measurement. Formal data consist of all frequencies in the preview list within 6 dB of specification limit or the top six frequencies. Failure in preview data does not necessarily constitute failure in formal data.

T6a RADIATED EMISSIONS 1G-3.5GHz FCC B V2

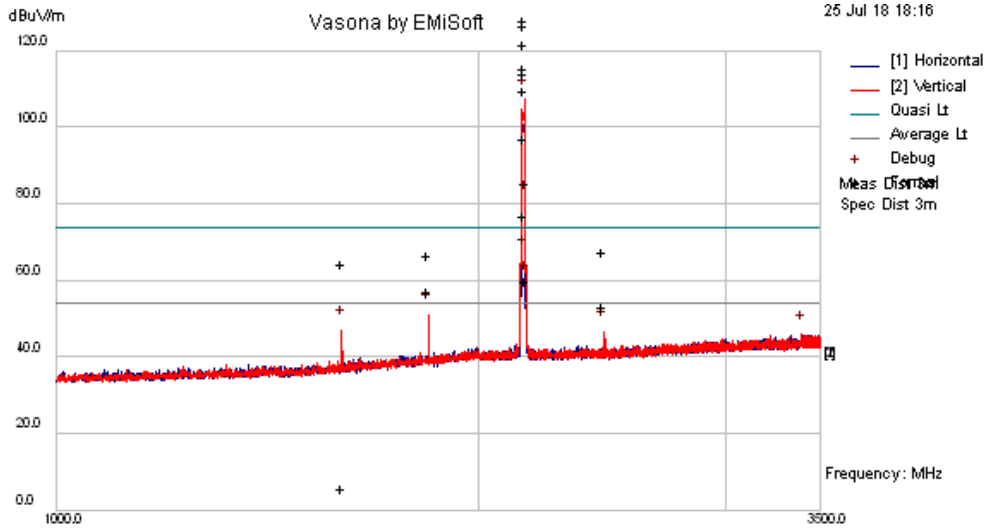

Radiated Emissions Template: Radiated E 3m 1GHz-18GHz
 Filename: c:\program files\emisoft - vasona\results\2018-0148 v2 femtocell\T6a RE 1G-3.5G_FCCB V2.emi

Results Title:	Radiated E 3m 1GHz-18GHz
File Name:	c:\program files\EMISoft - vasona\results\2018-0148 v2 femtocell\T6a RE 1G-3.5G_FCCB V2.emi
Test Laboratory:	GPCL AR5-MH 22C, 67%RH, 996mB
Test Engineer:	EEM / GM / MJS
Test Software:	Vasona by EMISoft, version 2.161
Equipment:	Nokia
EUT Details:	TMO V2 SOHO B2B4 (B4 LTE) Part 15/Part 27 Also identified as 4G LTE Cell Spot V2V2 Model: SS2FII Femtocell Multiband SOHO [S/N:LBALLUAK180306783]; FCC ID: H8NSS2FII; TX Output: 2150 MHz, 10 MHz BW, 256QAM, 21 dBm, NB-IOT , Guard band "Upper" [Project 2018-0148]
Configuration:	Radiated Emissions 1 -3.5 GHz FCC Part 15 B Class B, RCVR E954, Preamp E1166, 10dB pad(E583), Horn Antenna E0573, 3M Distance offset, ESU using Peak and Average Detector. Driver Modified to address overload condition (30dB for formals); Preview BW (100 kHz RBW/ 3000 KHz VBW); Formal BW (1MHz RBW). Analyzer Reference Level: 115 dBuV, Internal Attenuation: 20 dB. Official Scan #1 Project 2018-0148
Date:	2018-07-25 18:16:45

Formal Data

Frequency. MHz	Raw dBuV	Cable dB	Factor dB	Level dBuV/m	Emission Type	Pol H/V	Ht. cm	Az. Deg.	Limit dBuV/m	Margin dB	Pass /Fail	Comments
2154.52	106.04	13.75	-9.87	109.92	Average	V	114	218	54	55.92	N/A	Authorized Transmit Carrier
2154.52	104.46	13.75	-9.87	108.33	Average	V	107	274	54	54.33	N/A	
2155	100.13	13.75	-9.87	104	Average	V	154	226	54	50	N/A	
2154.52	118.17	13.75	-9.87	122.04	Peak	V	114	218	74	48.04	N/A	
2154.52	116.97	13.75	-9.87	120.84	Peak	V	107	274	74	46.84	N/A	
2155	112.26	13.75	-9.87	116.13	Peak	V	154	226	74	42.13	N/A	
2158.22	67.52	13.75	-9.87	71.4	Average	V	118	214	54	17.4	N/A	
2158.22	87.29	13.75	-9.87	91.17	Peak	V	118	214	74	17.17	N/A	
2162.72	75.95	13.76	-9.88	79.83	Peak	V	117	285	74	5.83	N/A	
2162.72	50.3	13.76	-9.88	54.19	Average	V	117	285	54	0.19	N/A	
1843.2	48.95	13.42	-10.9	51.48	Average	V	312	8	54	-2.52	Pass	
2453.02	43.41	14.14	-10	47.52	Average	V	234	101	54	-6.48	Pass	
2453.02	57.5	14.14	-10	61.61	Peak	V	234	101	74	-12.39	Pass	
1843.2	58.45	13.42	-10.9	60.99	Peak	V	312	8	74	-13.01	Pass	
1597.44	58.17	13.23	-12.8	58.6	Peak	V	280	175	74	-15.4	Pass	
1597.44	-0.43	13.23	-12.8	0	Average	V	280	175	54	-54	Pass	

Preview Data

Frequency. MHz	Raw dBuV	Cable dB	Factor dB	Level dBuV/m	Emission Type	Pol H/V	Ht. cm	Az. Deg.	Limit dBuV/m	Margin dB	Pass /Fail	Comments
2155	103.34	13.75	-9.87	107.22	Preview	V	202	225	54	53.22	Fail	
2158.22	61.58	13.75	-9.87	65.46	Preview	V	102	225	54	11.46	Fail	
2162.72	54.97	13.76	-9.88	58.85	Preview	V	102	270	54	4.85	Fail	
1843.28	48.46	13.42	-10.9	50.99	Preview	V	302	0	54	-3.01	Pass	
1597.75	46.62	13.23	-12.8	47.05	Preview	V	202	180	54	-6.95	Pass	
2454.52	42.52	14.14	-10	46.63	Preview	V	202	180	54	-7.37	Pass	
3398.06	39.3	14.57	-7.98	45.89	Preview	V	102	225	54	-8.11	Pass	

Note: Preview data was measured using a peak detector to identify frequencies of interest for formal measurement. Formal data consist of all frequencies in the preview list within 6 dB of specification limit or the top six frequencies. Failure in preview data does not necessarily constitute failure in formal data.

T9b RADIATED EMISSIONS 3.5 GHz – 10 GHz

FCC Class B_64QAM

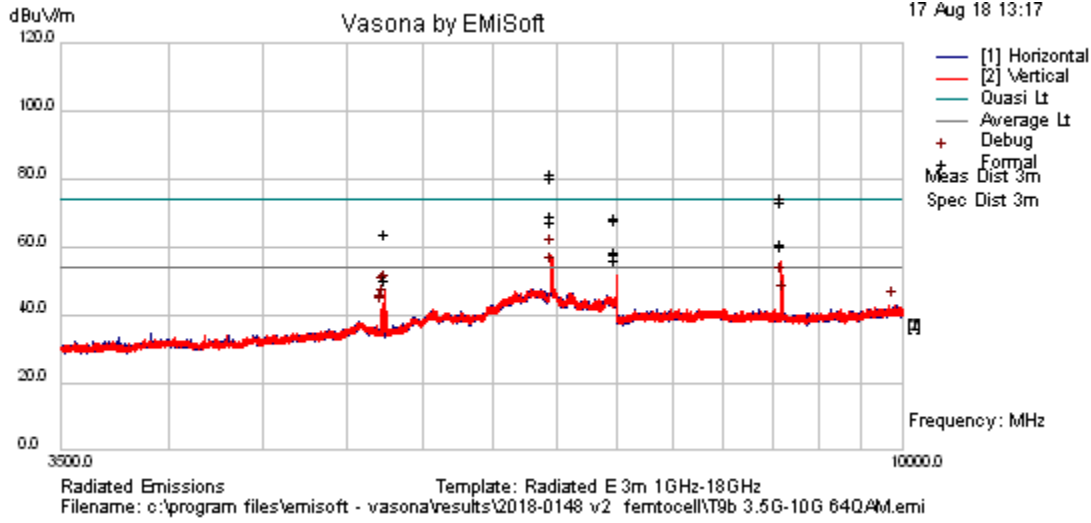

Results Title:	Radiated Emissions 3m 3.5GHz-18GHz
File Name:	c:\program files\EMISoft - vasona\results\2018-0148 v2 femtocell\T9b 3.5G-10G 64QAM.emi
Test Laboratory:	GPCL AR5-MH 22C, 64%RH, 996mB
Test Engineer:	GM
Test Software:	Vasona by EMISoft, version 2.161
Equipment:	Nokia
EUT Details:	TMO V2 SOHO B2B4 (B4 LTE) Part 15/Part 27 Also identified as 4G LTE Cell Spot V2V2 Model: SS2FII Femtocell Multiband SOHO [S/N:LBALLUAK180306783]; FCC ID: H8NS52FI; TX Output: 2150 MHz, 10 MHz BW, 64QAM, 21 dBm, NB-IOT , Guard band Mitigation: Split-Core Ferriter Material was added tot he Ribbon Cable which interfaces Debug Board and the EU.T. Debug Cable and Debug Board was encapsulated with Copper Tape over insulating Material.
Configuration:	Radiated Emissions 3.5GHz -10GHz FCC Part 15 B Class B, RCVR E1190, Preamp E1166, HPF(E986), Horn Antenna E0573, 3M Distance offset, ESU using Peak and Average Detector. Preview BW (100 kHz RBW/ 3000 KHz VBW); Formal BW (1MHz RBW). Analyzer Reference Level: 100 dBuV, Internal Attenuation: 20 dB. Non-Official Scan, Project 2018-0148
Date:	2018-08-17 13:17:33

Formal Data

Frequency. MHz	Raw dBuV	Cable dB	Factor dB	Level dBuV/m	Emission Type	Pol H/V	Ht. cm	Az. Deg.	Part 27 Limit dBuV/m	Margin dB	Pass /Fail	Comments
6449.44	58.73	6.6	-2.67	62.66	AvgMax	V	198	343	82.23	-19.57	Pass	Reportable
8600.01	50.69	6.73	-1.16	56.26	AvgMax	V	123	203	82.23	-25.97	Pass	
8599.96	50.28	6.73	-1.16	55.85	AvgMax	V	128	202	82.23	-26.38	Pass	
8602.65	50.14	6.72	-1.15	55.71	AvgMax	V	211	189	82.23	-26.52	Pass	
7000	48.59	7.17	-1.85	53.91	AvgMax	V	118	350	82.23	-28.32	Pass	
7000	46.26	7.17	-1.85	51.58	AvgMax	V	109	352	82.23	-30.65	Pass	
7000.02	46.26	7.17	-1.85	51.58	AvgMax	V	102	352	82.23	-30.65	Pass	
7000.22	47.88	7.17	-1.85	53.2	AvgMax	V	101	346	82.23	-29.03	Pass	
5245.39	45.07	5.21	-4.4	45.88	AvgMax	V	254	301	82.23	-36.35	Pass	

Preview Data

Frequency. MHz	Raw dBuV	Cable dB	Factor dB	Level dBuV/m	Emission Type	Pol H/V	Ht. cm	Az. Deg.	Part 15 Limit dBuV/m	Margin dB	Pass /Fail	Comments
6448.6	53.81	6.6	-2.67	57.73	Preview	V	102	352	54	3.73	N/A	
8600.24	50.24	6.73	-1.16	55.81	Preview	V	102	198	54	1.81	N/A	
6459.86	48.57	6.61	-2.67	52.52	Preview	V	102	0	54	-1.48	Pass	
6999.98	46.22	7.17	-1.85	51.54	Preview	V	102	330	54	-2.46	Pass	
8602.65	44.31	6.72	-1.15	49.88	Preview	V	102	198	54	-4.12	Pass	
5245.39	46.52	5.21	-4.4	47.33	Preview	V	102	44	54	-6.67	Pass	
5238.96	46.14	5.2	-4.41	46.94	Preview	V	102	198	54	-7.06	Pass	
8613.9	38.92	6.71	-1.14	44.48	Preview	V	102	198	54	-9.52	Pass	
5230.12	42.7	5.19	-4.42	43.48	Preview	V	102	198	54	-10.52	Pass	
9891.44	36.28	6.55	-0.17	42.66	Preview	V	390	176	54	-11.34	Pass	
5218.87	40.87	5.18	-4.44	41.62	Preview	V	102	44	54	-12.38	Pass	
5225.3	40.81	5.19	-4.43	41.57	Preview	V	102	44	54	-12.43	Pass	
5221.28	39.85	5.19	-4.44	40.6	Preview	V	102	66	54	-13.4	Pass	

Note: Preview data was measured using a peak detector to identify frequencies of interest for formal measurement. Formal data consist of all frequencies in the preview list within 6 dB of specification limit or the top six frequencies. Failure in preview data does not necessarily constitute failure in formal data.

T10 RADIATED EMISSIONS 10 GHz – 18 GHz

FCC B_64QAM

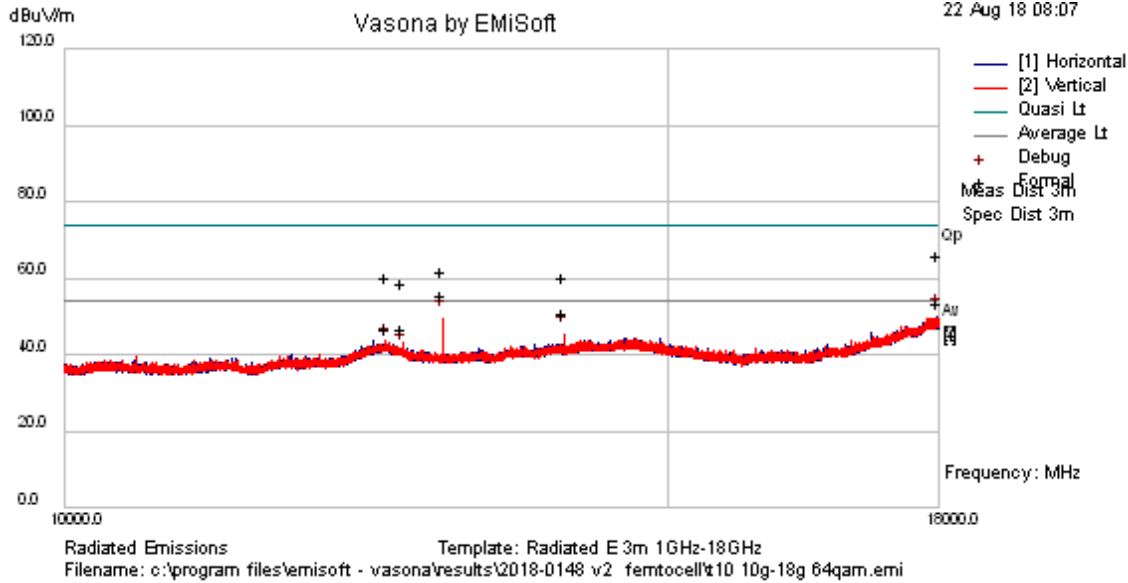

Results Title:	Radiated E 3m 1GHz-18GHz
File Name:	c:\program files\emisoft - vasona\results\2018-0148 v2 femtocell\t10 10g-18g 64qam.emi
Test Laboratory:	GPCL AR5-MH 22C, 64%RH, 996mB
Test Engineer:	SEG / MJS
Test Software:	Vasona by EMISoft, version 2.161
Equipment:	Nokia
EUT Details:	TMO V2 SOHO B2B4 (B4 LTE) Part 15/Part 27 Also identified as 4G LTE Cell Spot V2V2 Model: SS2FII Femtocell Multiband SOHO [S/N:LBALLUAK180306783]; FCC ID: H8NSS2FII; TX Output: 2150 MHz, 10 MHz BW, 64QAM, 21 dBm, NB-IOT, Guard band Mitigation: Split-Core Ferrite Material was added to the Ribbon Cable which interfaces Debug Board and the EU.T. Debug Cable and Debug Board was encapsulated with Copper Tape over insulating Material.
Configuration:	Radiated Emissions 10GHz -18GHz FCC Part 15 B Class B, RCVR E1190, Preamp E1166, HPF(E988), Horn Antenna E393, 3M Distance offset, ESI-1G using Peak and Average Detector. Preview BW (30 kHz RBW/ 3000 KHz VBW); Formal BW (1MHz RBW). Analyzer Reference Level: 100 dBuV, Internal Attenuation: 10 dB. Project 2018-0148
Date:	2018-08-22 08:07:43

Formal Data

Frequency, MHz	Raw dBuV	Cable dB	Factor dB	Level dBuV/m	Emission Type	Pol H/V	Ht. cm	Az. Deg.	Limit dBuV/m	Margin dB	Pass /Fail	Comments
17993.7	40.93	10.11	10	61.04	Peak	H	148	206	74	-12.96	Pass	
12900	46.02	8.32	2.41	56.75	Peak	V	227	161	74	-17.25	Pass	
13999.9	40.52	8.6	5.92	55.04	Peak	V	209	176	74	-18.96	Pass	
12419.2	45.63	8.15	1.29	55.07	Peak	H	284	252	74	-18.93	Pass	
12562.2	43.65	8.2	1.5	53.35	Peak	H	134	347	74	-20.65	Pass	
17993.7	28.41	10.11	10	48.52	AvgMax	H	148	206	54	-5.48	Pass	
12900	39.7	8.32	2.41	50.44	AvgMax	V	227	161	54	-3.56	Pass	
13999.9	31	8.6	5.92	45.52	AvgMax	V	209	176	54	-8.48	Pass	
12419.2	32.32	8.15	1.29	41.76	AvgMax	H	284	252	54	-12.24	Pass	
12562.2	31.71	8.2	1.5	41.41	AvgMax	H	134	347	54	-12.59	Pass	

Preview Data

Frequency, MHz	Raw dBuV	Cable dB	Factor dB	Level dBuV/m	Emission Type	Pol H/V	Ht. cm	Az. Deg.	Limit dBuV/m	Margin dB	Pass /Fail	Comments
17984.8	29.9	10.1	9.94	49.95	Preview	H	190	242	54	-4.05	Pass	
12900.3	38.51	8.32	2.42	49.24	Preview	V	202	154	54	-4.76	Pass	
13999.8	30.73	8.6	5.92	45.25	Preview	V	202	176	54	-8.75	Pass	
12419.2	32.56	8.15	1.29	42	Debug	H	100	355	54	-12	Pass	
12562.2	30.68	8.2	1.5	40.38	Debug	H	100	355	54	-13.62	Pass	

Note: Preview data was measured using a peak detector to identify frequencies of interest for formal measurement. Formal data consist of all frequencies in the preview list within 6 dB of specification limit or the top six frequencies. Failure in preview data does not necessarily constitute failure in formal data.

T18+ RADIATED EMISSIONS 18 GHz – 26.5 GHz

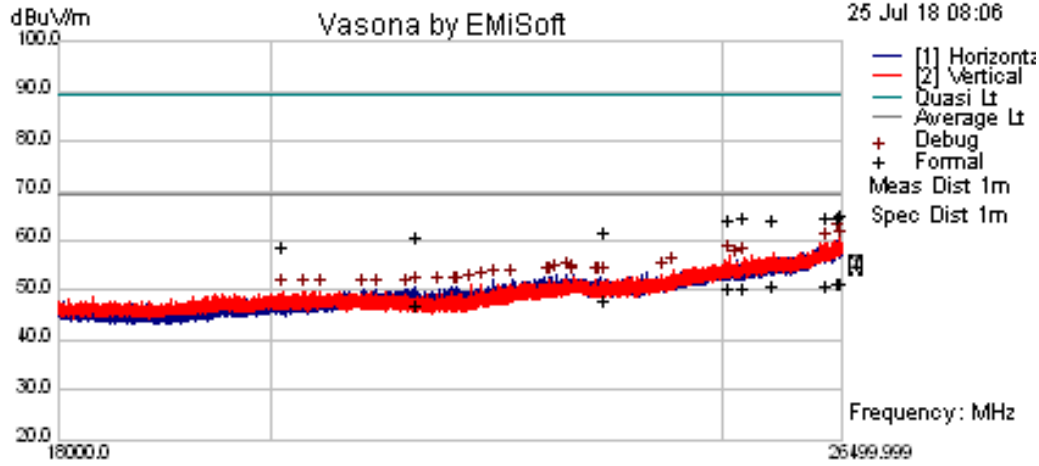

Radiated Emissions Template: Radiated E 1m 18GHz-26.5GHz
 Filename: c:\program files\emisoft - vasona\results\fermocell_2018-0148_0147\RE18-26.5GHz

Results Title:	Radiated Emissions 1m 18GHz-26.5GHz
File Name:	c:\program files\emisoft - vasona\results\2018-0148 v2 femtocell\RE18-26.5GHz V2.emi
Test Laboratory:	GPCL AR5-MH 22C, 67%RH, 996mB
Test Engineer:	EEM
Test Software:	Vasona by EMISoft, version 2.161
Equipment:	Nokia
EUT Details:	TMO V2 SOHO B2B4 (B4 LTE) Part 15/Part 27 Also identified as 4G LTE Cell Spot V2V2 Model: SS2FII Femtocell Multiband SOHO [S/N:LBALLUAK180306783]; FCC ID: H8NSS2FII; TX Output: 2150 MHz, 10 MHz BW, 256QAM, 21 dBm, NB-IOT , Guardband "Upper" [Project 2018-0148]
Configuration:	Radiated Emissions 1 -3.5 GHz FCC Part 15 B Class B, RCVR E954, Preamp E1166, HPF(E1235), Horn Antenna E0573, 3M Distance offset, ESU using Peak and Average Detector. Driver Modified to address overload condition ; Preview BW (100 kHz RBW/ 3000 KHz VBW); Formal BW (1MHz RBW).. Analyzer Reference Level: 115 dBuV, Internal Atten: 10 dB . Official Scan #1 Project 2018-0148
Date:	2018-07-25 10:59:57

Formal Data

Frequency. MHz	Raw dBuV	Cable dB	Factor dB	Level dBuV/m	Emission Type	Pol H/V	Ht. cm	Az. Deg.	Limit dBuV/m	Margin dB	Pass /Fail	Comments
26470.1	25.17	12.79	11.08	49.04	AvgMax	V	129	255	91.77	-42.73	Pass	
26487.3	25.06	12.83	11.12	49.01	AvgMax	V	163	81	91.77	-42.76	Pass	
26299.7	25.67	12.36	10.59	48.62	AvgMax	V	195	142	91.77	-43.15	Pass	
25622.9	27.76	11.29	9.36	48.41	AvgMax	V	192	147	91.77	-43.36	Pass	
25254.6	28.24	11.03	8.97	48.24	AvgMax	V	99	247	91.77	-43.53	Pass	
25072.1	28.19	10.91	8.76	47.86	AvgMax	V	167	328	91.77	-43.91	Pass	
23579	27.8	9.93	7.96	45.69	AvgMax	H	157	51	91.77	-46.08	Pass	
21480.4	27.82	8.48	8.21	44.51	AvgMax	H	123	25	91.77	-47.26	Pass	

Preview Data

Frequency. MHz	Raw dBuV	Cable dB	Factor dB	Level dBuV/m	Emission Type	Pol H/V	Ht. cm	Az. Deg.	Limit dBuV/m	Margin dB	Pass /Fail	Comments
26470.1	37.46	12.79	11.08	61.32	Preview	V	152	135	69.5	-8.18	Pass	
26487.3	35.71	12.83	11.12	59.67	Preview	V	102	45	69.5	-9.83	Pass	
26299.7	36.5	12.36	10.59	59.45	Preview	V	200	180	69.5	-10.05	Pass	
25072.1	37.32	10.91	8.76	56.99	Preview	V	200	352	69.5	-12.51	Pass	
25254.6	36.32	11.03	8.97	56.32	Preview	V	200	90	69.5	-13.18	Pass	
25156.9	36.19	10.97	8.86	56.02	Preview	H	200	270	69.5	-13.48	Pass	
24394.6	35.99	10.18	8	54.17	Preview	V	102	270	69.5	-15.33	Pass	
23143.9	35.11	10.17	8.05	53.33	Preview	H	200	0	69.5	-16.17	Pass	
24258.4	35.31	10.03	7.9	53.24	Preview	V	102	180	69.5	-16.26	Pass	
23026.9	34.8	10.24	8.07	53.1	Preview	H	200	270	69.5	-16.4	Pass	
23222.3	34.73	10.13	8.04	52.9	Preview	H	200	135	69.5	-16.6	Pass	
23206.2	34.46	10.14	8.04	52.64	Preview	V	152	0	69.5	-16.86	Pass	
22962.6	34.29	10.2	8.08	52.58	Preview	H	200	270	69.5	-16.92	Pass	
22933.7	34.31	10.16	8.09	52.56	Preview	H	200	270	69.5	-16.94	Pass	
21480.4	27.82	8.48	8.21	44.52	AvgMax	H	123	25	69.5	-24.98	Pass	
20109.5	40.25	8	8.02	56.27	Peak	V	193	245	89.5	-33.23	Pass	
23579	34.32	9.93	7.96	52.22	Preview	H	200	90	69.5	-17.28	Pass	

Note: Preview data was measured using a peak detector to identify frequencies of interest for formal measurement. Formal data consist of all frequencies in the preview list within 6 dB of specification limit or the top six frequencies. Failure in preview data does not necessarily constitute failure in formal data.

6.4 Field Strength of Spurious Emissions Photographs

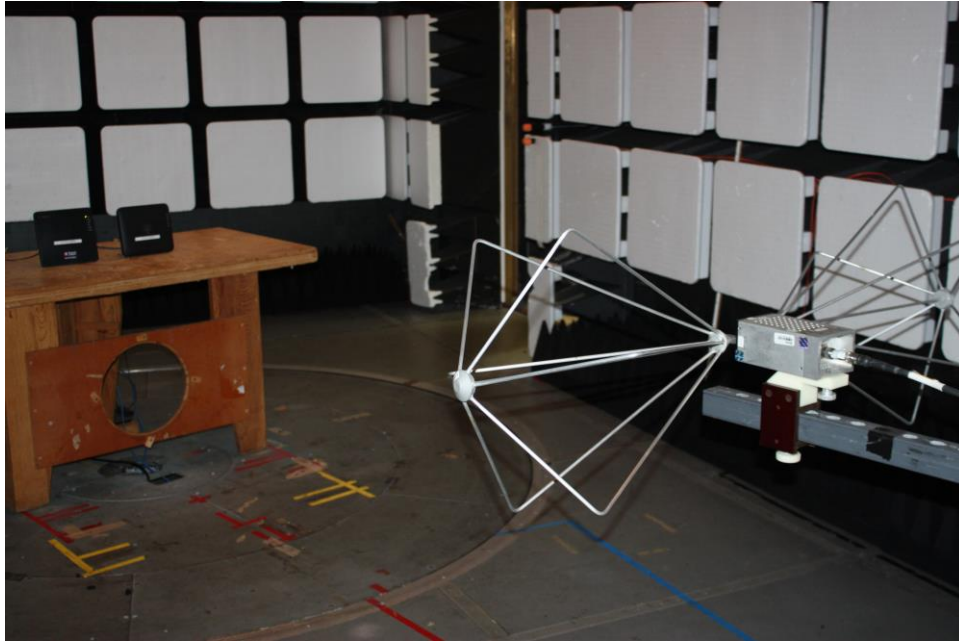

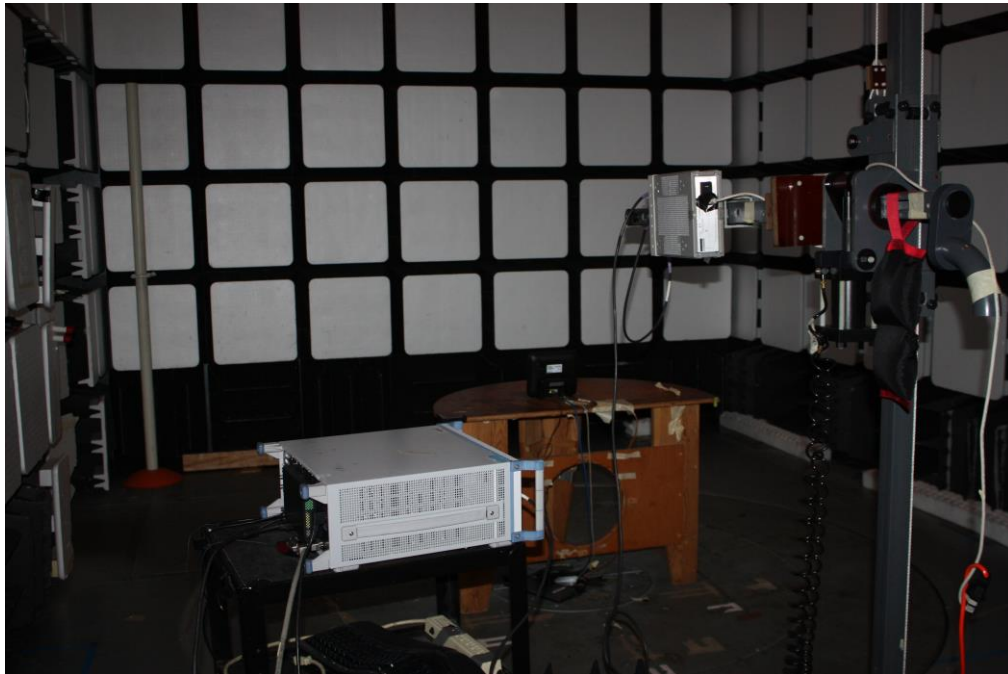
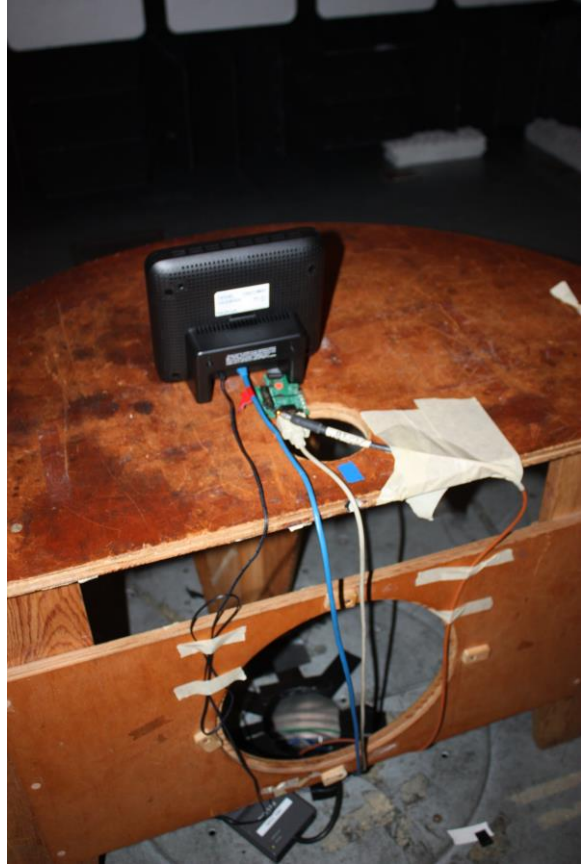
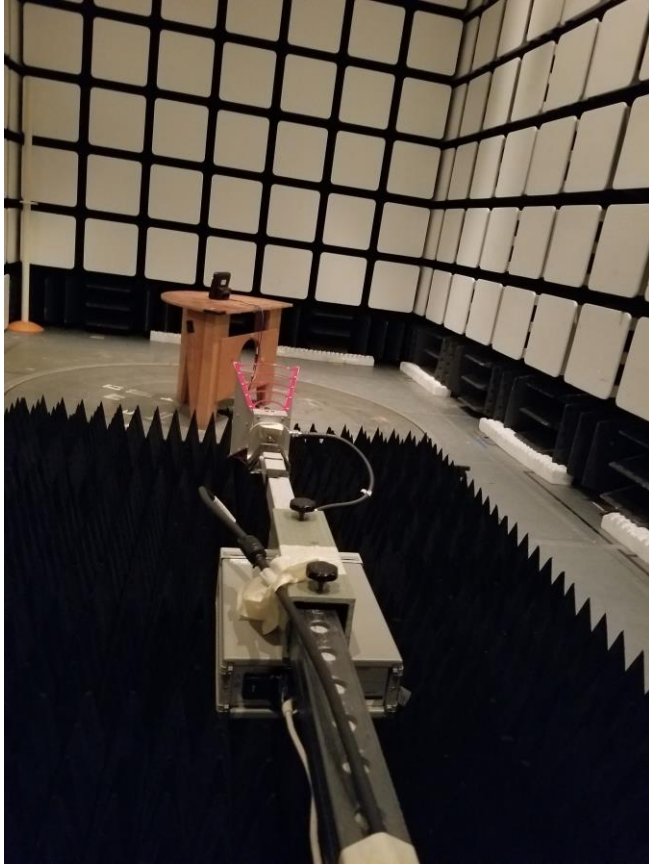

6.5 Field Strength of Spurious Emissions Test Equipment

Asset ID	Manufacturer	Type	Description	Model	Serial	Calibration Date	Calibration Due	Calibration Type	Status
E1105	EMC Test Systems	Multi-Device Controller		2090	1600			Calibration Not Required	Active
E051	EMCO	Biconical Antenna		3109	2187	2016-12-01	2018-12-01	Requires Calibration	Active
E060	EMCO	Log Periodic Antenna	Log periodic antenna	3146	1458	2016-12-06	2018-12-06	Requires Calibration	Active
E1321	Extech	Data Logger	Barometric Pressure/Humidity/Temperature Datalogger	SD700	A075782				Active
E908	Rohde & Schwarz	Test Receiver	EMI (20Hz to 40 GHz)-150 +30dBm	ESIB40	100100	2018-03-12	2020-03-12	Requires Calibration	Active
E512	Sonoma Instrument Co.	Amplifier	9KHz-1GHz	310N	185826	2018-03-27	2020-03-27	Requires Calibration	Active
E889	Weinschel	Attenuator	6 dB DC-18GHz 5 Watt	2-6	BX3438	2018-05-23	2020-05-23	Requires Calibration	Active
E1166	Agilent Technologies	Amplifier	Pre-Amplifier 1-26.5GHz	8449B	3008A01740	2016-02-25	2018-07-25	Requires Calibration	Active
E555	EMC Test Systems	Multi-Device Controller		2090	1577			Calibration Not Required	Active
E057	EMCO	Horn Antenna	Double Ridged Horn 1-18 GHz	3115	9006-3460	2017-05-24	2019-05-24	Requires Calibration	Active
E1235	RLC Electronics Inc	High Pass Filter	High Pass filter 5GHz to 26GHz	F-19413	1446-006			Calibration Not Required, Must Be Verified	Active
E954	Rohde & Schwarz	Test Receiver	EMI 20Hz - 40GHz -155 dBm +30 dBm	ESU40	100246	2016-12-05	2018-12-05	Requires Calibration	Active
E583	Weinschel	Attenuator	10dB 25W DC-18 GHz	46-10-34	BL7552	2018-05-23	2020-05-23	Requires Calibration	Active

7. NVLAP Certificate of Accreditation

United States Department of Commerce
National Institute of Standards and Technology

NVLAP[®]

Certificate of Accreditation to ISO/IEC 17025:2005

NVLAP LAB CODE: 100275-0

Nokia, Global Product Compliance Lab
Murray Hill, NJ

*is accredited by the National Voluntary Laboratory Accreditation Program for specific services,
listed on the Scope of Accreditation, for:*

Electromagnetic Compatibility & Telecommunications

*This laboratory is accredited in accordance with the recognized International Standard ISO/IEC 17025:2005.
This accreditation demonstrates technical competence for a defined scope and the operation of a laboratory quality
management system (refer to joint ISO-ILAC-IAF Communique dated January 2009).*

2017-08-17 through 2018-09-30

Effective Dates





For the National Voluntary Laboratory Accreditation Program