

## FCC Test Report (Part 96: LTE Band 48)

**Report No.:** RF191115C09

**FCC ID:** H8NSFE3160S

**Test Model:** SFE3160S

**Received Date:** Nov. 15, 2019

**Test Date:** Nov. 30, 2019 ~ Mar. 12, 2020

**Issued Date:** Mar. 12, 2020

**Applicant:** ASKEY COMPUTER CORP.

**Address:** 10F, NO.119, JIANKANG RD., ZHONGHE DIST., NEW TAIPEI CITY  
23585, TAIWAN, R.O.C.

**Issued By:** Bureau Veritas Consumer Products Services (H.K.) Ltd., Taoyuan Branch  
Lin Kou Laboratories

**Lab Address:** No. 47-2, 14th Ling, Chia Pau Vil., Lin Kou Dist., New Taipei City, Taiwan

**Test Location:** No.19, Hwa Ya 2nd Rd., Wen Hwa Vil., Kwei Shan Dist., Taoyuan City  
33383, TAIWAN

**FCC Registration/  
Designation Number:** 788550 / TW0003



This report is for your exclusive use. Any copying or replication of this report to or for any other person or entity, or use of our name or trademark, is permitted only with our prior written permission. This report sets forth our findings solely with respect to the test samples identified herein. The results set forth in this report are not indicative or representative of the quality or characteristics of the lot from which a test sample was taken or any similar or identical product unless specifically and expressly noted. Our report includes all of the tests requested by you and the results thereof based upon the information that you provided to us. You have 60 days from date of issuance of this report to notify us of any material error or omission caused by our negligence, provided, however, that such notice shall be in writing and shall specifically address the issue you wish to raise. A failure to raise such issue within the prescribed time shall constitute your unqualified acceptance of the completeness of this report, the tests conducted and the correctness of the report contents. Unless specific mention, the uncertainty of measurement has been explicitly taken into account to declare the compliance or non-compliance to the specification. The report must not be used by the client to claim product certification, approval, or endorsement by TAF or any government agencies.

## Table of Contents

<b>Release Control Record</b> .....	<b>4</b>
<b>1 Certificate of Conformity</b> .....	<b>5</b>
<b>2 Summary of Test Results</b> .....	<b>6</b>
2.1 Measurement Uncertainty .....	6
2.2 Modification Record .....	6
<b>3 General Information</b> .....	<b>7</b>
3.1 General Description of EUT .....	7
3.2 Test Mode Applicability and Tested Channel Detail .....	8
3.3 Description of Support Units .....	10
3.3.1 Configuration of System under Test .....	10
3.4 General Description of Applied Standards and References.....	11
<b>4 Test Types and Results</b> .....	<b>12</b>
4.1 Maximum Output Power Measurement .....	12
4.1.1 Limits of Maximum Output Power Measurement .....	12
4.1.2 Test Setup.....	12
4.1.3 Test Instruments .....	12
4.1.4 Test Procedures.....	13
4.1.5 Deviation from Test Standard .....	13
4.1.6 EUT Operating Conditions.....	13
4.1.7 Test Results .....	14
4.2 Maximum Power Spectral Density Measurement .....	16
4.2.1 Limits of Maximum Power Spectral Density Measurement .....	16
4.2.2 Test Setup.....	16
4.2.3 Test Instruments .....	16
4.2.4 Test Procedure .....	16
4.2.5 Deviation from Test Standard .....	16
4.2.6 EUT Operating Condition .....	16
4.2.7 Test Results .....	17
4.3 Modulation characteristics Measurement .....	19
4.3.1 Limits of Modulation characteristics .....	19
4.3.2 Test Procedure .....	19
4.3.3 Test Setup.....	19
4.3.4 Test Results .....	19
4.4 Frequency Stability Measurement.....	20
4.4.1 Limits of Frequency Stability Measurement.....	20
4.4.2 Test Procedure .....	20
4.4.3 Test Setup.....	20
4.4.4 Test Results .....	21
4.5 Emission Bandwidth Measurement.....	23
4.5.1 Emission Bandwidth Measurement.....	23
4.5.2 Test Setup.....	23
4.5.3 Test Instruments .....	23
4.5.4 Test Procedure .....	23
4.5.5 Deviation from Test Standard .....	23
4.5.6 EUT Operating Conditions.....	23
4.5.7 Test Result (-26dB Bandwidth).....	24
4.5.8 Test Result (Occupied Bandwidth) .....	26
4.6 Peak to Average Ratio Measurement .....	28
4.6.1 Limits of Peak to Average Ratio Measurement .....	28
4.6.2 Test Setup.....	28
4.6.3 Test Procedures.....	28
4.6.4 Test Results .....	29

4.7	Conducted Spurious Emissions .....	31
4.7.1	Limits of Conducted Spurious Emissions Measurement .....	31
4.7.2	Test Setup .....	31
4.7.3	Test Procedure .....	31
4.7.4	Test Results .....	32
4.8	Radiated Emission Measurement .....	48
4.8.1	Limits of Radiated Emission Measurement .....	48
4.8.2	Test Instruments .....	48
4.8.3	Test Procedures.....	49
4.8.4	Deviation from Test Standard .....	49
4.8.5	Test Set Up .....	50
4.8.6	Test Results .....	51
<b>5</b>	<b>Pictures of Test Arrangements.....</b>	<b>59</b>
	<b>Appendix – Information of the Testing Laboratories .....</b>	<b>60</b>

### Release Control Record

Issue No.	Description	Date Issued
RF191115C09	Original release.	Mar. 12, 2020

## 1 Certificate of Conformity

**Product:** CBSD SmallCell

**Brand:** Askey

**Test Model:** SFE3160S

**Sample Status:** Engineering sample

**Applicant:** ASKEY COMPUTER CORP.

**Test Date:** Nov. 30, 2019 ~ Mar. 12, 2020

**Standards:** 47 CFR FCC Part 96

The above equipment has been tested by **Bureau Veritas Consumer Products Services (H.K.) Ltd., Taoyuan Branch**, and found compliance with the requirement of the above standards. The test record, data evaluation & Equipment Under Test (EUT) configurations represented herein are true and accurate accounts of the measurements of the sample's RF characteristics under the conditions specified in this report.

**Prepared by :**

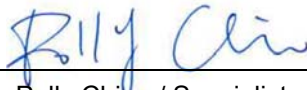

Polly Chien / Specialist

**Date:**

Mar. 12, 2020

**Approved by :**



Bruce Chen / Senior Project Engineer

**Date:**

Mar. 12, 2020

## 2 Summary of Test Results

47 CFR FCC Part 96			
FCC Clause	Test Item	Result	Remarks
2.1046 96.41(b)	Maximum Peak Output Power	Pass	Meet the requirement of limit.
2.1046 96.41(b)	Maximum Power Spectral Density	Pass	Meet the requirement of limit.
2.1047 96.41(a)	Modulation Characteristics	Pass	Meet the requirement of limit.
96.41(g)	Peak to Average Ration	Pass	Meet the requirement of limit.
2.1049	Emission Bandwidth	Pass	Meet the requirement of limit.
2.1055	Frequency Stability	Pass	Meet the requirement of limit.
2.1051 96.41(e)	Conducted Spurious Emissions	Pass	Meet the requirement of limit.
2.1053 96.41(e)	Radiated Spurious Emissions	Pass	Meet the requirement of limit. Minimum passing margin is -1.0dB at 7120.00MHz.

Note: Determining compliance based on the results of the compliance measurement, not taking into account measurement instrumentation uncertainty.

### 2.1 Measurement Uncertainty

Where relevant, the following measurement uncertainty levels have been estimated for tests performed on the EUT as specified in CISPR 16-4-2:

Measurement	Frequency	Expanded Uncertainty (k=2) (±)
Radiated Emissions up to 1 GHz	9 kHz ~ 30MHz	3.04 dB
	30 MHz ~ 200 MHz	3.59 dB
	200 MHz ~ 1000 MHz	3.60 dB
Radiated Emissions above 1 GHz	1 GHz ~ 18 GHz	2.29 dB
	18 GHz ~ 40 GHz	2.29 dB

### 2.2 Modification Record

There were no modifications required for compliance.

### 3 General Information

#### 3.1 General Description of EUT

Product	CBSD SmallCell		
Brand	Askey		
Test Model	SFE3160S		
Status of EUT	Engineering sample		
Modulation Type	64QAM		
Operating Frequency	LTE Band 48	Channel Bandwidth 10MHz	TX: 3555 ~ 3695 MHz RX: 3555 ~ 3695 MHz
		Channel Bandwidth 20MHz	TX: 3560 ~ 3690 MHz RX: 3560 ~ 3690 MHz
Max. EIRP Power	LTE Band 48		64QAM
		Channel Bandwidth 10MHz	749.894mW(28.75dBm)
		Channel Bandwidth 20MHz	778.037mW(28.91dBm)
Emission Designator	LTE Band 48	Channel Bandwidth 10MHz	8M93D7W
		Channel Bandwidth 20MHz	17M9D7W
Antenna Type	Dipole antenna with 4.2dBi gain		
Antenna Connector	I-Pex(1)		
Accessory Device	Adapter		
Data Cable Supplied	2.97m non-shielded RJ45 cable without core		

Note:

1. The EUT consumes power from the following adapter and POE.

Adapter	
Brand	SHENZHEN FRECOM ELECTRONICS CO., LTD
Model	F24W5-120200SPAU
Input	100-240Vac, 50/60Hz, 0.6A
Output	12Vdc, 2A
Power Line	1.5m DC power cable without core attached on adapter

POE (Support unit only)	
Brand	EUSSO
Model	UPE5600-IHGM
Input Power	100-240Vac, 50-60Hz
Output Power	48-52Vdc, 30Watt Maximum

2. The EUT provides 2 completed transmitters and 2 receivers.
3. The EUT can support full RB only.

### 3.2 Test Mode Applicability and Tested Channel Detail

Pre-Scan has been conducted to determine the worst-case mode from all possible combinations between available modulations, data rates, XYZ axis and antenna ports

The worst case was found when positioned on Z-plane. Following channel(s) was (were) selected for the final test as listed below:

Test Item	Available Channel	Tested Channel	Channel Bandwidth	Modulation
Maximum Output Power	55290 to 56690	55290 (3555.0MHz), 55990 (3625.0MHz), 56690 (3695.0MHz)	10MHz	64QAM
	55340 to 56640	55340 (3560.0MHz), 55990 (3625.0MHz), 56640 (3690.0MHz)	20MHz	
Modulation Characteristics	55340 to 56640	55990 (3625.0MHz)	20MHz	64QAM
Frequency Stability	55290 to 56690	55290 (3555.0MHz), 56690 (3695.0MHz)	10MHz	64QAM
	55340 to 56640	55340 (3560.0MHz), 56640 (3690.0MHz)	20MHz	64QAM
Occupied Bandwidth	55290 to 56690	55290 (3555.0MHz), 55990 (3625.0MHz), 56690 (3695.0MHz)	10MHz	64QAM
	55340 to 56640	55340 (3560.0MHz), 55990 (3625.0MHz), 56640 (3690.0MHz)	20MHz	64QAM
Peak to Average Ratio	55290 to 56690	55290 (3555.0MHz), 55990 (3625.0MHz), 56690 (3695.0MHz)	10MHz	64QAM
	55340 to 56640	55340 (3560.0MHz), 55990 (3625.0MHz), 56640 (3690.0MHz)	20MHz	64QAM
Conducted Emission	55290 to 56690	55290 (3555.0MHz), 55990 (3625.0MHz), 56690 (3695.0MHz)	10MHz	64QAM
	55340 to 56640	55340 (3560.0MHz), 55990 (3625.0MHz), 56640 (3690.0MHz)	20MHz	64QAM
Radiated Emission Below 1GHz	55290 to 56690	55990 (3625.0MHz),	10MHz	64QAM
	55340 to 56640	55340 (3560.0MHz)	20MHz	64QAM
Radiated Emission Above 1GHz	55290 to 56690	55290 (3555.0MHz), 55990 (3625.0MHz), 56690 (3695.0MHz)	10MHz	64QAM
	55340 to 56640	55340 (3560.0MHz), 55990 (3625.0MHz), 56640 (3690.0MHz)	20MHz	64QAM

**Note:**

1. This device was tested under all bandwidths, RB configurations and modulations. For radiated emission below 1GHz, low, mid and high channels were pre-tested in chamber. High channel was found to be the worst case and therefore had been chosen for all final tests.
2. For radiated emission above 1GHz, according to 3GPP 36.141 Section 4.7, choose the lowest & highest channel bandwidth for final test.



**Test Condition:**

Test Item	Environmental Conditions	Input Power	Tested By
Maximum Output Power	22deg. C, 68%RH	120Vac, 60Hz	James Yang
Modulation Characteristics	22deg. C, 68%RH	120Vac, 60Hz	James Yang
Frequency Stability	22deg. C, 68%RH	120Vac, 60Hz	James Yang
Occupied Bandwidth	22deg. C, 68%RH	120Vac, 60Hz	James Yang
Peak to Average Ratio	22deg. C, 68%RH	120Vac, 60Hz	James Yang
Condcudeted Emission	22deg. C, 68%RH	120Vac, 60Hz	James Yang
Radiated Emission	22deg. C, 68%RH	120Vac, 60Hz	Greg Lin

### 3.3 Description of Support Units

The EUT has been tested as an independent unit together with other necessary accessories or support units. The following support units or accessories were used to form a representative test configuration during the tests.

ID	Product	Brand	Model No.	Serial No.	FCC ID	Remarks
A.	Notebook	DELL	E5410	1HC2XM1	FCC DoC Approved	-
B.	Load	NA	NA	NA	NA	-
C.	GPS Antenna	INPAQ TECHNOLOGY CO., LTD.	GPSGLONASS15D-S6-0010-A	NA	NA	Supplied by client

Note:

1. All power cords of the above support units are non-shielded (1.8m).
2. Items A acted as communication partners to transfer data.

ID	Cable Descriptions	Qty.	Length (m)	Shielding (Yes/No)	Cores (Qty.)	Remarks
1.	DC power cable	1	1.5	N	0	Attached on EUT
2.	LAN cable	1	1.5	N	0	Provided by Lab RJ45, Cat5e
3.	LAN cable	1	7	N	0	Provided by Lab RJ45, Cat5e
4.	GPS Antenna cable	1	2	Y	0	Supplied by client

#### 3.3.1 Configuration of System under Test

Adapter Mode:

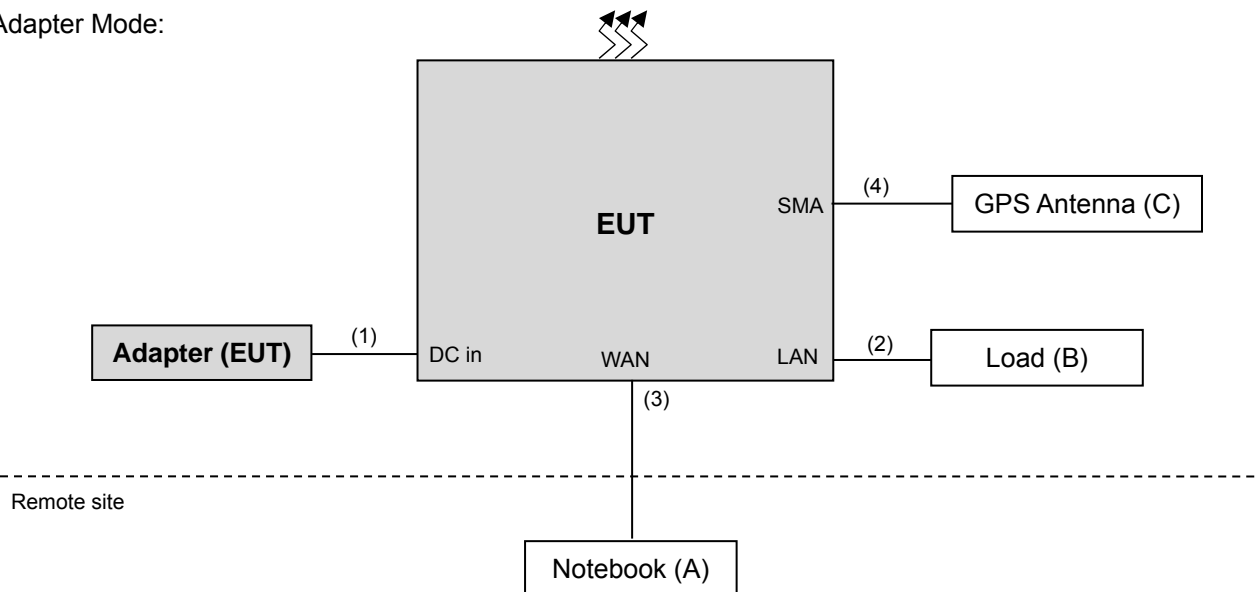

### **3.4 General Description of Applied Standards and References**

The EUT is a RF Product. According to the specifications of the manufacturer, it must comply with the requirements of the following standards and references:

**Test standard:**

**FCC 47 CFR Part 2**

**FCC 47 CFR Part 96**

ANSI/TIA/EIA-603-D-2010

All test items have been performed and recorded as per the above standards.

**References Test Guidance:**

**KDB 971168 D01 Power Meas License Digital Systems v03r01**

**KDB 940660 D01 Part 96 CBRS Eqpt v02**

**KDB 662911 D01 Multiple Transmitter Output v02r01**

All test items have been performed as a reference to the above KDB test guidance.

## 4 Test Types and Results

### 4.1 Maximum Output Power Measurement

#### 4.1.1 Limits of Maximum Output Power Measurement

Device		Maximum EIRP (dBm/10 MHz)
<input type="checkbox"/>	End User Device	23
<input checked="" type="checkbox"/>	Category A CBSD	30
<input type="checkbox"/>	Category B CBSD	47

#### 4.1.2 Test Setup

Conducted Measurement Method

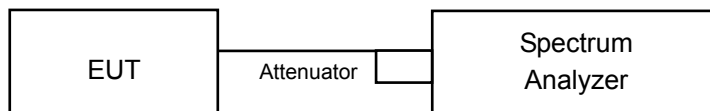

#### 4.1.3 Test Instruments

Description & Manufacturer	Model No.	Serial No.	Date of Calibration	Due Date of Calibration
Spectrum Analyzer KEYSIGHT	N9030A	MY54490561	Jul. 31, 2019	Jul. 30, 2020
DC-6GHz 20dB 50W Fixed attenuator Woken	MDC9331N-20	0724	Jun. 19, 2018	Jun. 18, 2020
JFW 20dB attenuation	50HF-020-SMA	NA	NA	NA

Note: 1. The calibration interval of the above test instruments is 12/24 months and the calibrations are traceable to NML/ROC and NIST/USA.

#### 4.1.4 Test Procedures

##### Conducted Measurement Method

1. Connect the DUT transmitter output to the spectrum analyzer via coaxial cable while ensuring proper impedance matching.
2. Set span to at least 1.5 times the OBW.
3. Set RBW = 1-5% of the OBW, not to exceed 1 MHz.
4. Set VBW  $\geq 3 \times$  RBW.
5. Set number of points in sweep  $\geq 2 \times$  span / RBW.
6. Sweep time = auto-couple.
7. Detector = RMS (power averaging).
8. If the EUT can be configured to transmit continuously (i.e., burst duty cycle  $\geq 98\%$ ), then set the trigger to free run.
9. If the EUT cannot be configured to transmit continuously (i.e., burst duty cycle  $< 98\%$ ), then use a sweep trigger with the level set to enable triggering only on full power bursts and configure the EUT to transmit at full power for the entire duration of each sweep. Ensure that the sweep time is less than or equal to the transmission burst duration.
10. Trace average at least 100 traces in power averaging (i.e., RMS) mode.
11. Compute the power by integrating the spectrum across the OBW of the signal using the instrument's band power measurement function, with the band limits set equal to the OBW band edges. If the instrument does not have a band power function, then sum the spectrum levels (in linear power units) at intervals equal to the RBW extending across the entire OBW of the spectrum.

##### Maximum EIRP (dBm/MHz)

The relevant equation for determining the maximum ERP or EIRP from the measured RF output power is given in Equation as follows:

$$\text{ERP or EIRP} = P_{\text{Meas}} + G_{\text{T}}$$

where

ERP or EIRP effective radiated power or equivalent isotropically radiated power, respectively  
(expressed in the same units as  $P_{\text{Meas}}$ , e.g., dBm or dBW)

$P_{\text{Meas}}$  measured transmitter output power or PSD, in dBm or dBW

$G_{\text{T}}$  gain of the transmitting antenna, in dBd (ERP) or dBi (EIRP)

#### 4.1.5 Deviation from Test Standard

No deviation.

#### 4.1.6 EUT Operating Conditions

The software provided by client to enable the EUT under transmission condition continuously at lowest, middle and highest channel frequencies individually.

### 4.1.7 Test Results

#### Conducted Output Power (dBm / 10MHz)

Band / BW	Chain	64QAM		
		Low CH	Mid CH	High CH
		55290 3555 MHz	55990 3625 MHz	56690 3695 MHz
48 / 10M	0	20.02	20.19	<b>21.78</b>
	1	19.97	19.92	21.29

Band / BW	Chain	64QAM		
		Low CH	Mid CH	High CH
		55340 3560 MHz	55990 3625 MHz	56640 3690 MHz
48 / 20M	0	19.39	19.37	<b>19.45</b>
	1	18.96	18.86	18.94

#### Spectrum Plot of Worst Value



#### Maximum EIRP (dBm/ 10MHz)

Band / BW	Chain	64QAM		
		Low CH	Mid CH	High CH
		55290 3555 MHz	55990 3625 MHz	56690 3695 MHz
48 / 10M	0	24.22	24.39	25.98
	1	24.17	24.12	25.49
	0+1	27.21	27.27	<b>28.75</b>

Band / BW	Chain	64QAM		
		Low CH	Mid CH	High CH
		55340 3560 MHz	55990 3625 MHz	56640 3690 MHz
48 / 20M	0	23.59	23.57	23.65
	1	23.16	23.06	23.14
	0+1	26.39	26.33	<b>26.41</b>

\*EIRP = Conducted + antenna gain.

### Full Conducted Output Power (dBm / 10MHz)

Band / BW	Chain	64QAM		
		Low CH	Mid CH	High CH
		55290 3555 MHz	55990 3625 MHz	56690 3695 MHz
48 / 10M	0	20.02	20.19	<b>21.78</b>
	1	19.97	19.92	21.29

### Full Conducted Output Power (dBm / 20MHz)

Band / BW	Chain	64QAM		
		Low CH	Mid CH	High CH
		55340 3560 MHz	55990 3625 MHz	56640 3690 MHz
48 / 20M	0	21.68	21.16	<b>21.96</b>
	1	21.05	21.52	21.42

### Spectrum Plot of Worst Value



### Full Maximum EIRP (dBm/ 10MHz)

Band / BW	Chain	64QAM		
		Low CH	Mid CH	High CH
		55290 3555 MHz	55990 3625 MHz	56690 3695 MHz
48 / 10M	0	24.22	24.39	25.98
	1	24.17	24.12	25.49
	0+1	27.21	27.27	<b>28.75</b>

### Full Maximum EIRP (dBm/ 20MHz)

Band / BW	Chain	64QAM		
		Low CH	Mid CH	High CH
		55340 3560 MHz	55990 3625 MHz	56640 3690 MHz
48 / 20M	0	25.88	25.36	26.16
	1	25.25	25.72	25.62
	0+1	28.59	28.55	<b>28.91</b>

\*EIRP = Conducted + antenna gain.

## 4.2 Maximum Power Spectral Density Measurement

### 4.2.1 Limits of Maximum Power Spectral Density Measurement

Device	Maximum Radiated PSD (dBm/MHz)
End User Device	n/a
Category A CBSD	20
Category B CBSD	37

### 4.2.2 Test Setup

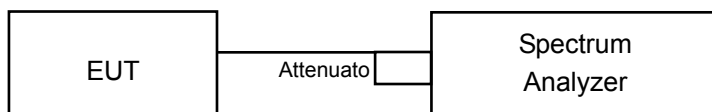

### 4.2.3 Test Instruments

Refer to section 4.1.3 to get information of above instrument.

### 4.2.4 Test Procedure

1. Connect the transmitter to the spectrum analyzer via coaxial cable while ensuring proper impedance matching.
2. Tune the analyzer to the nominal center frequency of the emission bandwidth (EBW).
3. Set the resolution bandwidth (RBW) to 1MHz.
4. Set the video bandwidth (VBW) to  $\geq 3 \times$  RBW.
5. Select the average power (RMS) display detector.
6. Set number of points in sweep  $\geq 2 \times$  span / RBW.
7. Use auto-coupled sweep time.
8. Perform the measurement over an interval of time when the transmission is continuous and at its maximum power level.

#### Maximum EIRP (dBm/MHz)

The relevant equation for determining the maximum ERP or EIRP from the measured RF output power is given in Equation as follows:

$$\text{ERP or EIRP} = P_{\text{Meas}} + G_{\text{T}}$$

where

ERP or EIRP effective radiated power or equivalent isotropically radiated power, respectively (expressed in the same units as  $P_{\text{Meas}}$ , e.g., dBm or dBW)

$P_{\text{Meas}}$  measured transmitter output power or PSD, in dBm or dBW

$G_{\text{T}}$  gain of the transmitting antenna, in dBd (ERP) or dBi (EIRP)

### 4.2.5 Deviation from Test Standard

No deviation.

### 4.2.6 EUT Operating Condition

The software provided by client to enable the EUT under transmission condition continuously at lowest, middle and highest channel frequencies individually.



## 4.2.7 Test Results

### Chain 0

LTE Band 48, Channel Bandwidth 10MHz						
Channel	Frequency (MHz)	Conducted PSD (dBm/MHz)	Antenna Gain (dBi)	Radiated PSD (dBm/MHz)	Limit (dBm/MHz)	Pass/Fail
55290	3555.0	13.72	4.2	17.92	20	Pass
55990	3625.0	13.09	4.2	17.29	20	Pass
56690	3695.0	15.78	4.2	19.98	20	Pass
LTE Band 48, Channel Bandwidth 20MHz						
Channel	Frequency (MHz)	Conducted PSD (dBm/MHz)	Antenna Gain (dBi)	Radiated PSD (dBm/MHz)	Limit (dBm/MHz)	Pass/Fail
55340	3560.0	13.32	4.2	17.52	20	Pass
55990	3625.0	13.12	4.2	17.32	20	Pass
56640	3690.0	12.99	4.2	17.19	20	Pass

\*Note: Radiated PSD= Conducted PSD (dBm/ MHz) + Antenna Gain (4.2dBi)



Chain 1

LTE Band 48, Channel Bandwidth 10MHz						
Channel	Frequency (MHz)	Conducted PSD (dBm/MHz)	Antenna Gain (dBi)	Radiated PSD (dBm/MHz)	Limit (dBm/MHz)	Pass/Fail
55290	3555.0	13.58	4.2	17.78	20	Pass
55990	3625.0	12.94	4.2	17.14	20	Pass
56690	3695.0	15.55	4.2	19.75	20	Pass

LTE Band 48, Channel Bandwidth 20MHz						
Channel	Frequency (MHz)	Conducted PSD (dBm/MHz)	Antenna Gain (dBi)	Radiated PSD (dBm/MHz)	Limit (dBm/MHz)	Pass/Fail
55340	3560.0	13.80	4.2	18.00	20	Pass
55990	3625.0	13.49	4.2	17.69	20	Pass
56640	3690.0	14.12	4.2	18.32	20	Pass

\*Note: Radiated PSD= Conducted PSD (dBm/ MHz) + Antenna Gain (4.2dBi)

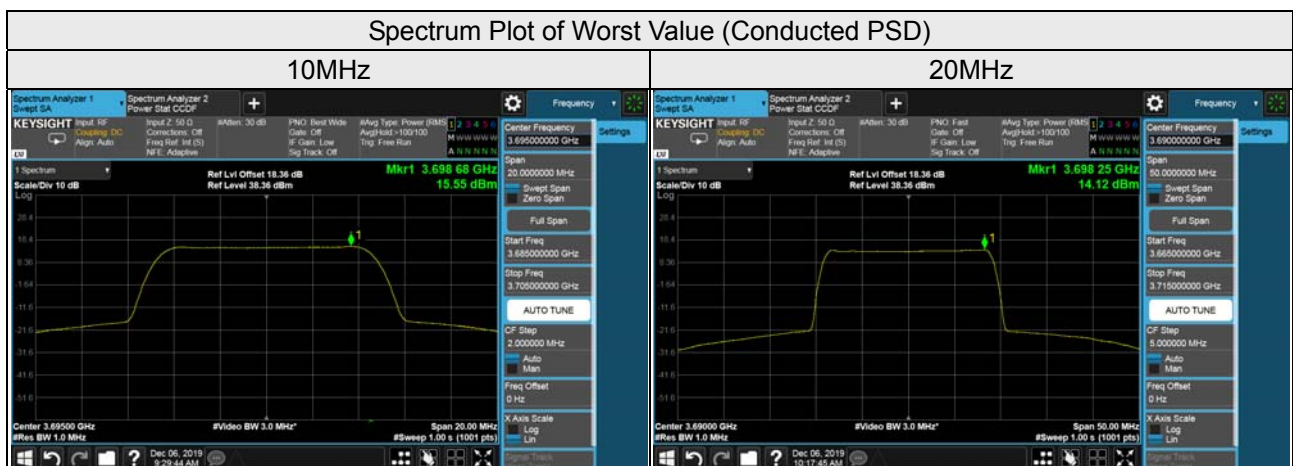

### 4.3 Modulation characteristics Measurement

#### 4.3.1 Limits of Modulation characteristics

N/A

#### 4.3.2 Test Procedure

Connect the EUT to Communication Simulator via the antenna connector, The frequency band is set as EUT supported Modulation and Channels, the EUT output is matched with 50 ohm load, the waveform quality and constellation of the EUT was tested.

#### 4.3.3 Test Setup



#### 4.3.4 Test Results

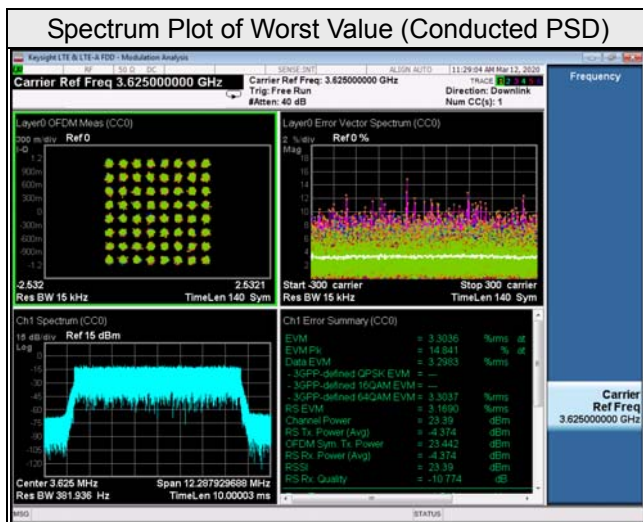

## 4.4 Frequency Stability Measurement

### 4.4.1 Limits of Frequency Stability Measurement

The frequency stability shall be sufficient to ensure that the fundamental emission stays within the authorized frequency band.

### 4.4.2 Test Procedure

- Device is placed at the oven room. The oven room could control the temperatures and humidity. Power warm up is at least 15 min and power applied should perform before recording frequency error.
- EUT is connected the external power supply to control the AC input power. The test voltage range is from minimum to maximum working voltage. Each step shall be record the frequency error rate.
- The temperature range step is 10 degrees in this test items. All temperature levels shall be hold the  $\pm 0.5$  °C during the measurement testing. The each temperature step shall be at least 0.5 hours, consider the EUT could be test under the stability condition.

**NOTE:** The frequency error was recorded frequency error from the communication simulator.

### 4.4.3 Test Setup

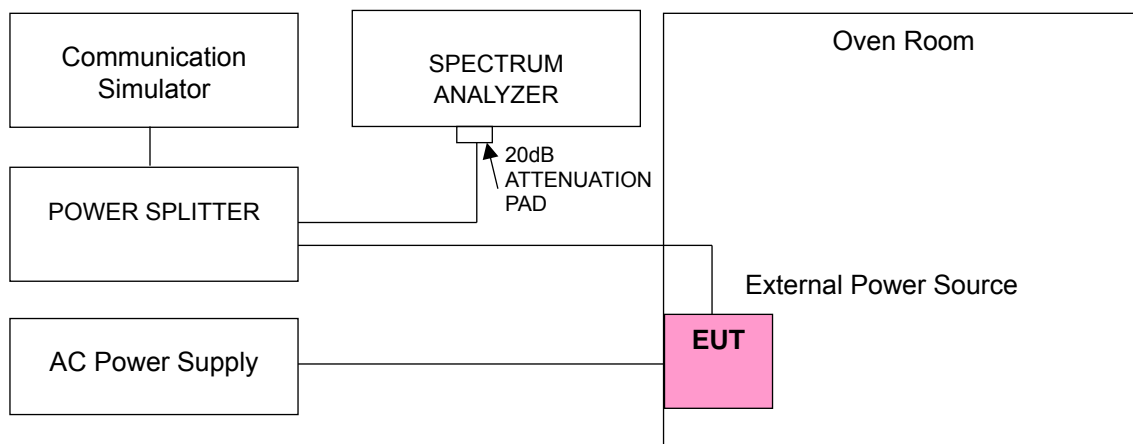

#### 4.4.4 Test Results

##### Frequency Error vs. Voltage

Voltage (Volts)	LTE Band 48, Channel Bandwidth: 10MHz			
	Low Channel		High Channel	
	Frequency (MHz)	Frequency Error (ppm)	Frequency (MHz)	Frequency Error (ppm)
102	3555.000003	0.001	3695.000002	0.001
120	3555.000002	0.000	3695.000003	0.001
138	3555.000003	0.001	3695.000001	0.000

Note: The applicant defined the normal working voltage is from 102Vac to 138Vac.

##### Frequency Error vs. Temperature

Temp. (°C)	LTE Band 48, Channel Bandwidth: 10MHz			
	Low Channel		High Channel	
	Frequency (MHz)	Frequency Error (ppm)	Frequency (MHz)	Frequency Error (ppm)
-30	3555.000003	0.001	3695.000002	0.001
-20	3555.000002	0.001	3695.000001	0.000
-10	3555.000003	0.001	3695.000004	0.001
0	3555.000001	0.000	3695.000001	0.000
10	3555.000003	0.001	3695.000003	0.001
20	3554.999996	-0.001	3694.999997	-0.001
30	3554.999998	-0.001	3694.999998	-0.001
40	3554.999999	0.000	3694.999997	-0.001
50	3554.999998	-0.001	3694.999997	-0.001

## Frequency Error vs. Voltage

Voltage (Volts)	LTE Band 48, Channel Bandwidth: 20MHz			
	Low Channel		High Channel	
	Frequency (MHz)	Frequency Error (ppm)	Frequency (MHz)	Frequency Error (ppm)
102	3560.000004	0.001	3690.000003	0.001
120	3560.000001	0.000	3690.000002	0.001
138	3560.000004	0.001	3690.000003	0.001

Note: The applicant defined the normal working voltage is from 102Vac to 138Vac.

## Frequency Error vs. Temperature

Temp. (°C)	LTE Band 48, Channel Bandwidth: 20MHz			
	Low Channel		High Channel	
	Frequency (MHz)	Frequency Error (ppm)	Frequency (MHz)	Frequency Error (ppm)
-30	3560.000002	0.001	3690.000003	0.001
-20	3560.000001	0.000	3690.000002	0.001
-10	3560.000001	0.000	3690.000001	0.000
0	3560.000002	0.000	3690.000004	0.001
10	3560.000002	0.001	3690.000001	0.000
20	3559.999999	0.000	3689.999996	-0.001
30	3559.999997	-0.001	3689.999998	-0.001
40	3559.999998	-0.001	3689.999997	-0.001
50	3559.999996	-0.001	3689.999997	-0.001

## 4.5 Emission Bandwidth Measurement

### 4.5.1 Emission Bandwidth Measurement

Reference only

### 4.5.2 Test Setup

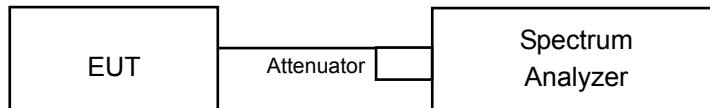

### 4.5.3 Test Instruments

Refer to section 4.1.3 to get information of above instrument.

### 4.5.4 Test Procedure

#### Occupied Bandwidth & 26dBc Bandwidth

1. The spectrum analyzer center frequency is set to the nominal EUT channel center frequency. The span range for the spectrum analyzer shall be wide enough to see sufficient roll off of the signal to make the measurement.
2. The nominal RBW shall be in the range of 1% to 5% of the anticipated OBW, and the VBW shall be set  $\geq 3 \times$  RBW.
3. Set the reference level of the instrument as required to prevent the signal amplitude from exceeding the maximum spectrum analyzer input mixer level for linear operation.  
NOTE—Step 1), step 2), and step 3) may require iteration to adjust within the specified tolerances.
4. The dynamic range of the spectrum analyzer at the selected RBW shall be more than 10 dB below the target “-X dB” requirement, i.e., if the requirement calls for measuring the -26 dB OBW, the spectrum analyzer noise floor at the selected RBW shall be at least 36 dB below the reference level.
5. Set spectrum analyzer detection mode to peak, and the trace mode to max hold.
6. Determine the reference value by either of the following:
  - a) Set the EUT to transmit a modulated signal. Allow the trace to stabilize. Set the spectrum analyzer marker to the highest level of the displayed trace (this is the reference value).
  - b) Set the EUT to transmit an unmodulated carrier. Set the spectrum analyzer marker to the level of the carrier.
7. Determine the “-X dB amplitude” as equal to (Reference Value - X). Alternatively, this calculation can be performed on the spectrum analyzer using the delta-marker measurement function.

### 4.5.5 Deviation from Test Standard

No deviation.

### 4.5.6 EUT Operating Conditions

The software provided by client to enable the EUT under transmission condition continuously at lowest, middle and highest channel frequencies individually.

#### 4.5.7 Test Result (-26dB Bandwidth)

LTE Band 48

Chain 0

LTE Band 48, Channel Bandwidth 10MHz		
Channel	Frequency (MHz)	26dB Bandwidth (MHz)
		64QAM
55290	3555.0	9.26
55990	3625.0	9.28
56690	3695.0	10.15
LTE Band 48, Channel Bandwidth 20MHz		
Channel	Frequency (MHz)	26dB Bandwidth (MHz)
		64QAM
55340	3560.0	18.50
55990	3625.0	18.48
56640	3690.0	18.48

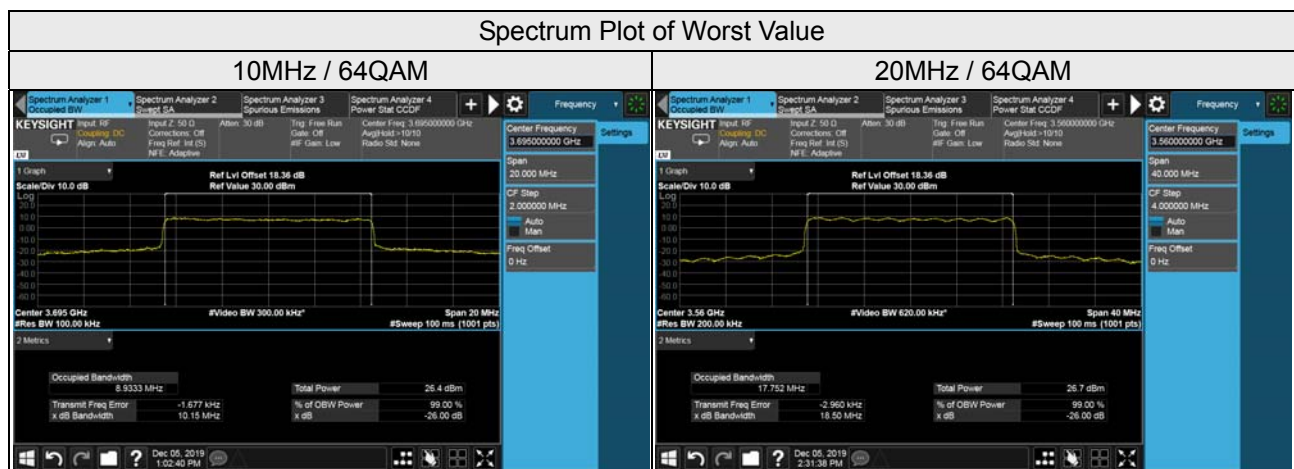



Chain 1

LTE Band 48, Channel Bandwidth 10MHz		
Channel	Frequency (MHz)	26dB Bandwidth (MHz)
		64QAM
55290	3555.0	9.33
55990	3625.0	9.28
56690	3695.0	9.28
LTE Band 48, Channel Bandwidth 20MHz		
Channel	Frequency (MHz)	26dB Bandwidth (MHz)
		64QAM
55340	3560.0	18.46
55990	3625.0	18.55
56640	3690.0	18.48

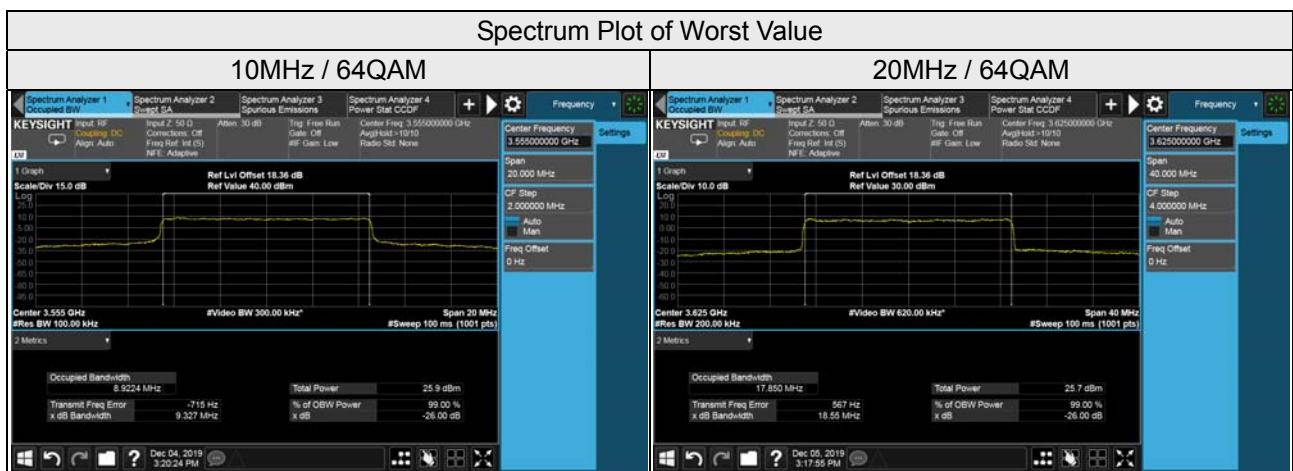

### 4.5.8 Test Result (Occupied Bandwidth)

LTE Band 48

Chain 0

LTE Band 48, Channel Bandwidth 10MHz			
Channel	Frequency (MHz)	99% Occupied Bandwidth (MHz)	
		64QAM	
55290	3555.0	8.90	
55990	3625.0	8.90	
56690	3695.0	8.93	
LTE Band 48, Channel Bandwidth 20MHz			
Channel	Frequency (MHz)	99% Occupied Bandwidth (MHz)	
		64QAM	
55340	3560.0	17.75	
55990	3625.0	17.81	
56640	3690.0	17.78	

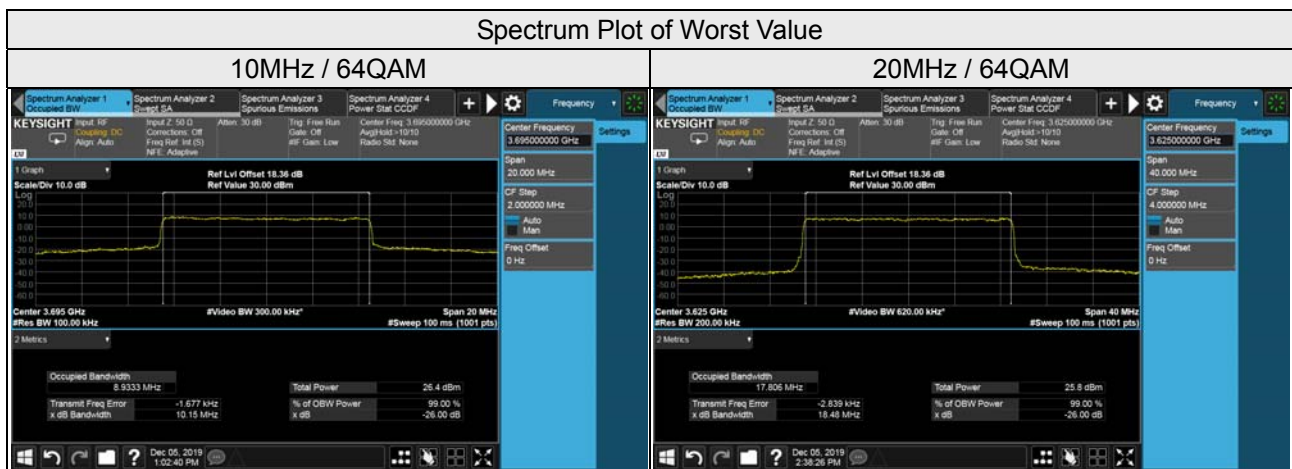

Chain 1

LTE Band 48, Channel Bandwidth 10MHz		
Channel	Frequency (MHz)	99% Occupied Bandwidth (MHz)
		64QAM
55290	3555.0	8.92
55990	3625.0	8.90
56690	3695.0	8.89
LTE Band 48, Channel Bandwidth 20MHz		
Channel	Frequency (MHz)	99% Occupied Bandwidth (MHz)
		64QAM
55340	3560.0	17.76
55990	3625.0	17.85
56640	3690.0	17.83

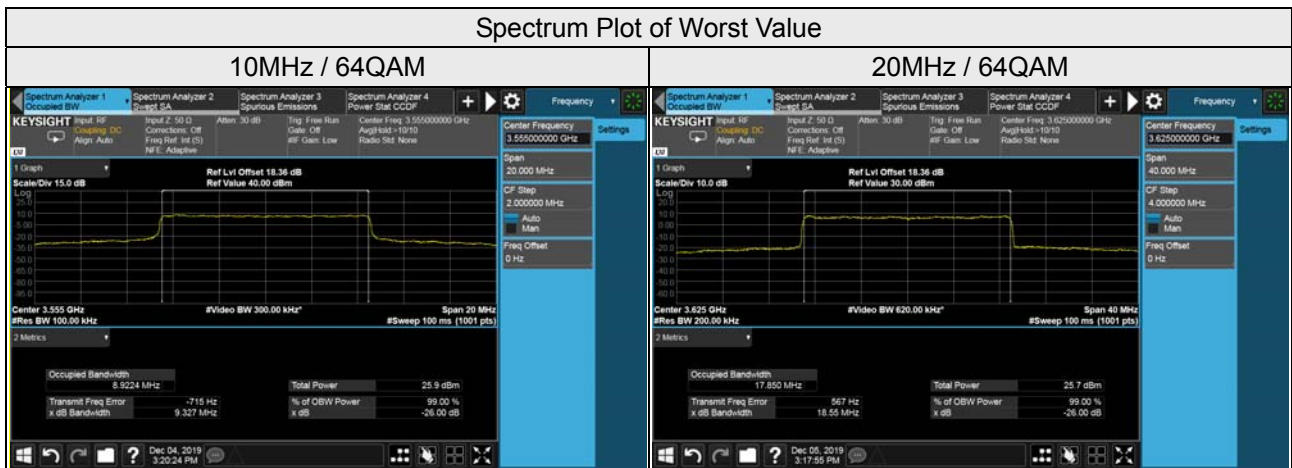

## 4.6 Peak to Average Ratio Measurement

### 4.6.1 Limits of Peak to Average Ratio Measurement

In measuring transmissions in this band using an average power technique, the peak to-average ratio (PAR) of the transmission may not exceed 13 dB

### 4.6.2 Test Setup

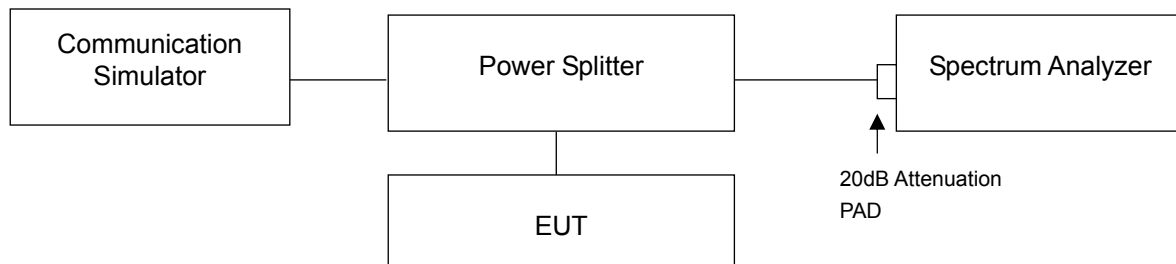

### 4.6.3 Test Procedures

- a. Set resolution/measurement bandwidth  $\geq$  signal's occupied bandwidth;
- b. Set the number of counts to a value that stabilizes the measured CCDF curve;
- c. Record the maximum PAPR level associated with a probability of 0.1%.

#### 4.6.4 Test Results

LTE Band 48

Chain 0

LTE Band 48, Channel Bandwidth 10MHz		
Channel	Frequency (MHz)	Peak To Average Ratio (dB)
		64QAM
55290	3555.0	9.14
55990	3625.0	9.21
56690	3695.0	9.16

LTE Band 48, Channel Bandwidth 20MHz		
Channel	Frequency (MHz)	Peak To Average Ratio (dB)
		64QAM
55340	3560.0	9.02
55990	3625.0	9.00
56640	3690.0	8.91

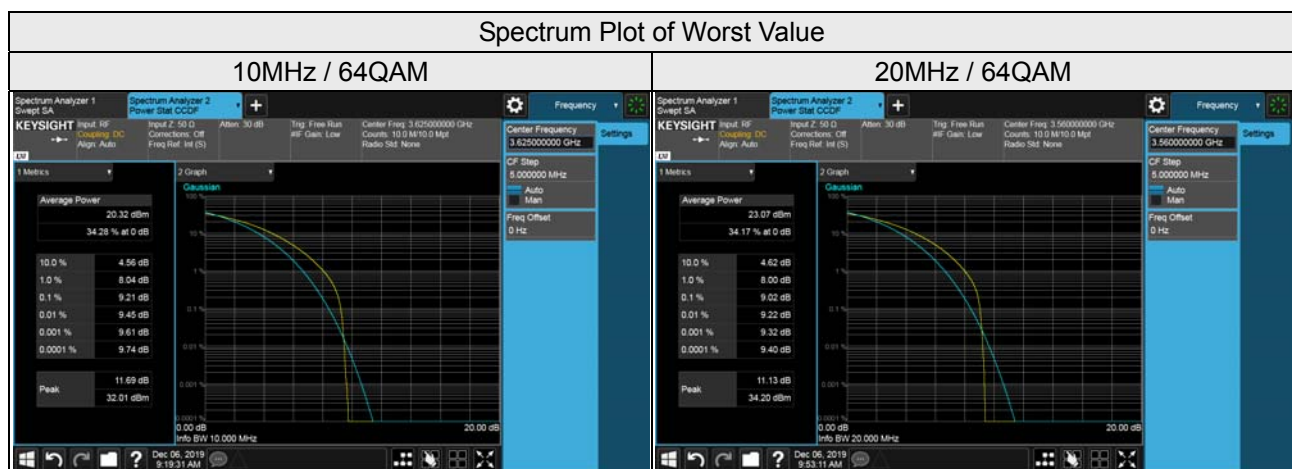

Chain 1

LTE Band 48, Channel Bandwidth 10MHz		
Channel	Frequency (MHz)	Peak To Average Ratio (dB)
		64QAM
55290	3555.0	9.15
55990	3625.0	9.19
56690	3695.0	9.04

LTE Band 48, Channel Bandwidth 20MHz		
Channel	Frequency (MHz)	Peak To Average Ratio (dB)
		64QAM
55340	3560.0	9.00
55990	3625.0	8.90
56640	3690.0	8.94



## 4.7 Conducted Spurious Emissions

### 4.7.1 Limits of Conducted Spurious Emissions Measurement

Power of any emissions outside the Fundamental	Limit
Within 0-10MHz above the Assigned Channel	-13 dBm/MHz
Within 0-10MHz below the Assigned Channel	
Greater than 0-10MHz above the Assigned Channel	-25 dBm/MHz
Greater than 0-10MHz below the Assigned Channel	
Power of any emission below 3530MHz	-40 dBm/MHz
Power of any emission above 3720MHz	

Note:

This device can be implement MIMO function, so the limit of spurious emissions needs to be reduced by  $10\log(\text{Numbers}_{\text{Ant}})$  according to FCC KDB 662911 D01 guidance.

{ The limit is adjusted to  $-13\text{dBm} - 10*\log(2) = -16.01\text{dBm}$ . }

{ The limit is adjusted to  $-25\text{dBm} - 10*\log(2) = -28.01\text{dBm}$ . }

{ The limit is adjusted to  $-40\text{dBm} - 10*\log(2) = -43.01\text{dBm}$ . }

### 4.7.2 Test Setup

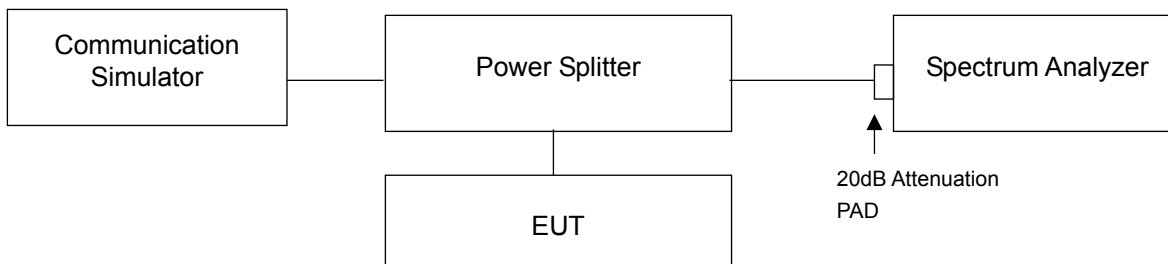

### 4.7.3 Test Procedure

- The EUT makes a phone call to the communication simulator. All measurements were done at low, middle and high operational frequency range.
- Measuring frequency range are from 9 kHz to 40GHz. 20dB attenuation pad is connected with spectrum. RBW=1MHz and VBW=3MHz is used for conducted emission measurement.
- Measuring frequency band edge, 20dB attenuation pad is connected with spectrum. 1% of the fundamental emission bandwidth is used for conducted emission measurement.

## 4.7.4 Test Results

### Chain 0

LTE Band 48, Channel Bandwidth 10MHz

Channel 55290 (3555.0MHz)

Channel 55990 (3625.0MHz)

Full RB

Full RB

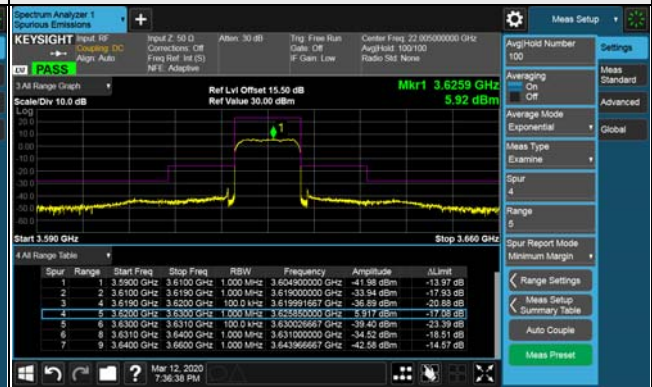
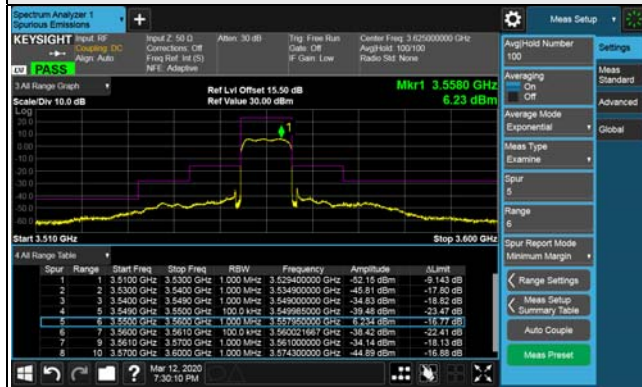

Channel 56690 (3695.0MHz)

Full RB





LTE Band 48, Channel Bandwidth 10MHz

Channel 55290 (3555.0MHz)

Frequency Range : 9kHz~1GHz

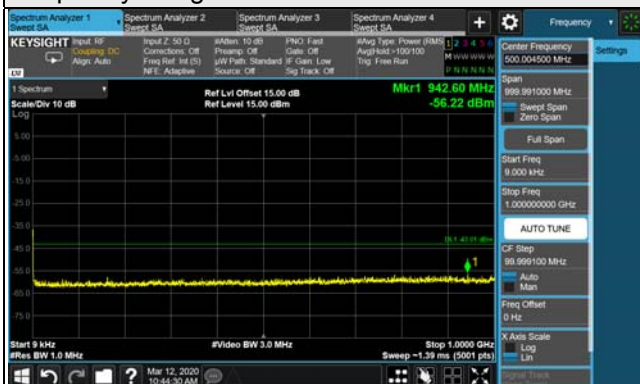

Frequency Range : 1GHz~3.48GHz

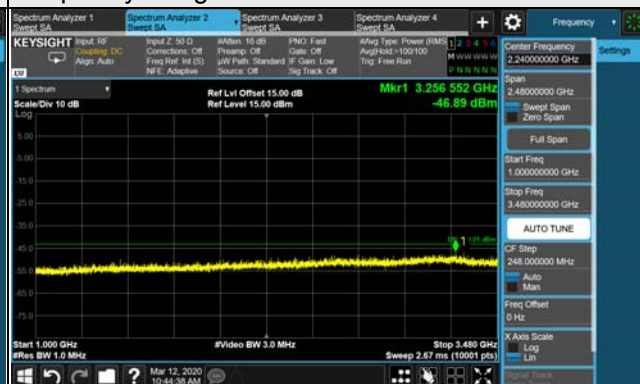

Frequency Range : 3.75GHz~26.5GHz



Frequency Range : 26.5GHz~40GHz



Note: The signal at 9 kHz is IF signal from spectrum analyzer.

LTE Band 48, Channel Bandwidth 10MHz

Channel 55990 (3625.00MHz)

Frequency Range : 9kHz~1GHz

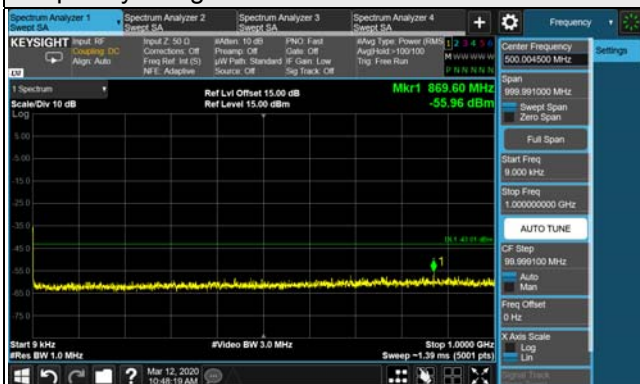

Frequency Range : 1GHz~3.48GHz

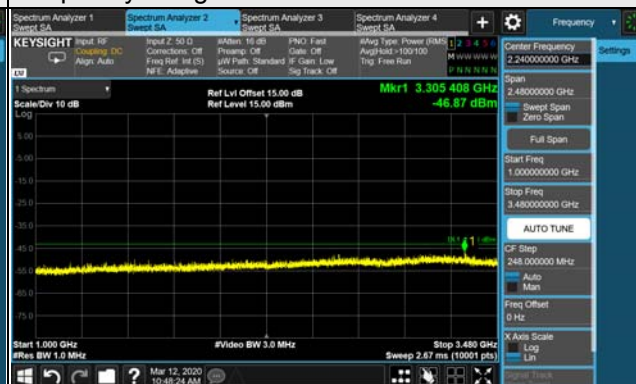

Frequency Range : 3.75GHz~26.5GHz

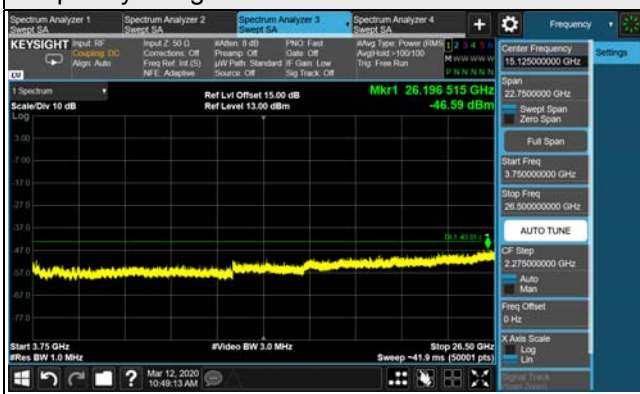

Frequency Range : 26.5GHz~40GHz

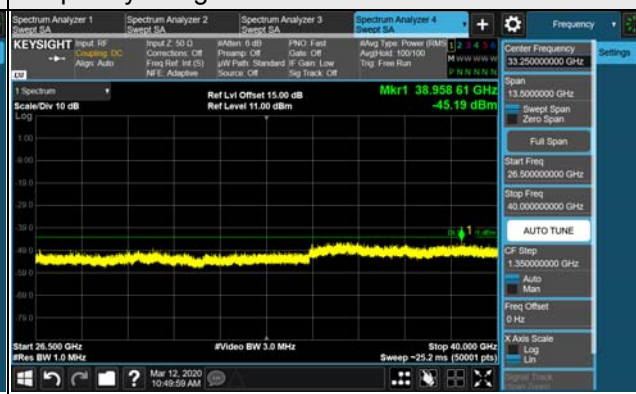

Note: The signal at 9 kHz is IF signal from spectrum analyzer.

LTE Band 48, Channel Bandwidth 10MHz

Channel 56690 (3695.0MHz)

Frequency Range : 9kHz~1GHz

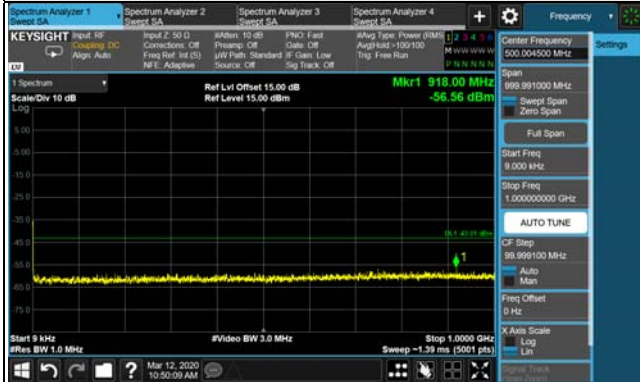

Frequency Range : 1GHz~3.48GHz



Frequency Range : 3.75GHz~26.5GHz



Frequency Range : 26.5GHz~40GHz

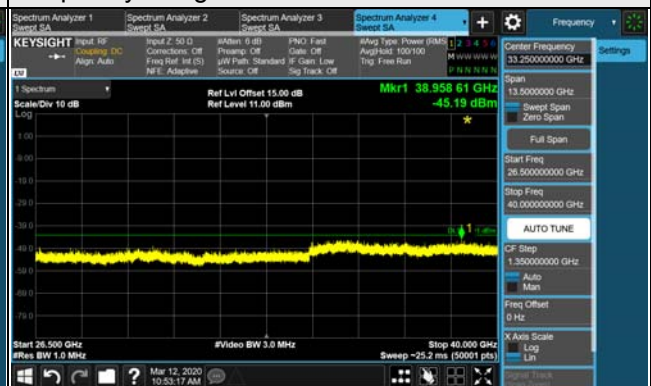

Note: The signal at 9 kHz is IF signal from spectrum analyzer.

LTE Band 48, Channel Bandwidth 20MHz

Channel 55340 (3560.0MHz)

Full RB

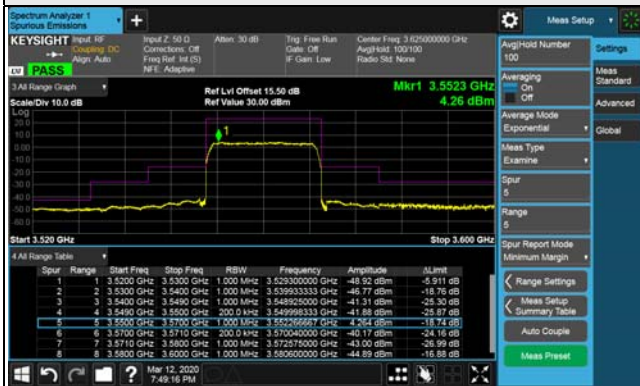

Channel 55990 (3625.0MHz)

Full RB

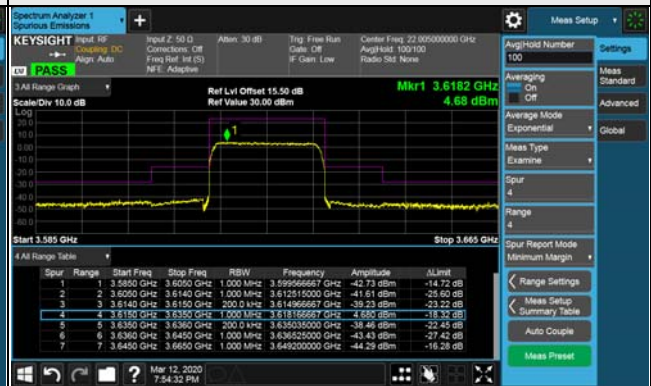

Channel 56640 (3690.0MHz)

Full RB



LTE Band 48, Channel Bandwidth 20MHz

Channel 55340 (3560.0MHz)

Frequency Range : 9kHz~1GHz

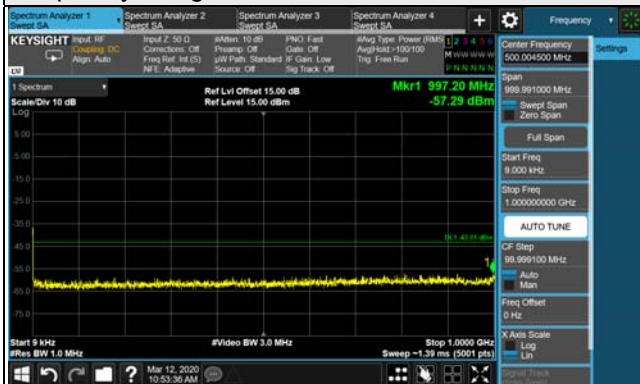

Frequency Range : 1GHz~3.48GHz



Frequency Range : 3.75GHz~26.5GHz



Frequency Range : 26.5GHz~40GHz



Note: The signal at 9 kHz is IF signal from spectrum analyzer.

LTE Band 48, Channel Bandwidth 20MHz

Channel 55990 (3625.0MHz)

Frequency Range : 9kHz~1GHz



Frequency Range : 1GHz~3.48GHz



Frequency Range : 3.75GHz~26.5GHz



Frequency Range : 26.5GHz~40GHz



Note: The signal at 9 kHz is IF signal from spectrum analyzer.

LTE Band 48, Channel Bandwidth 20MHz

Channel 56640 (3690.0MHz)

Frequency Range : 9kHz~1GHz

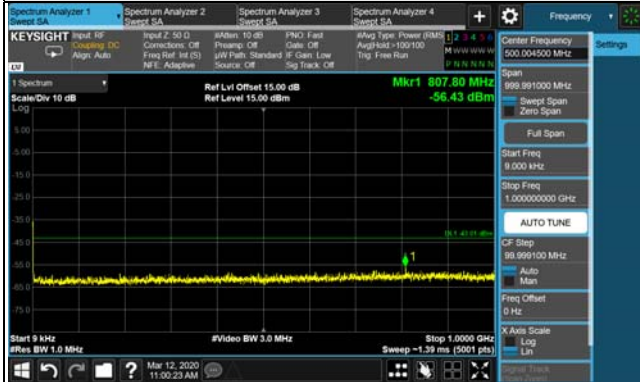

Frequency Range : 1GHz~3.48GHz

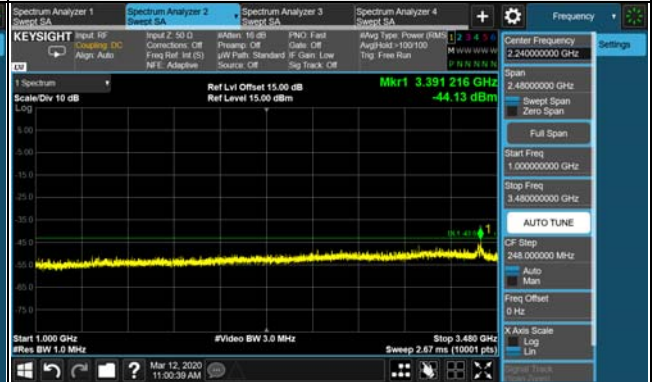

Frequency Range : 3.75GHz~26.5GHz

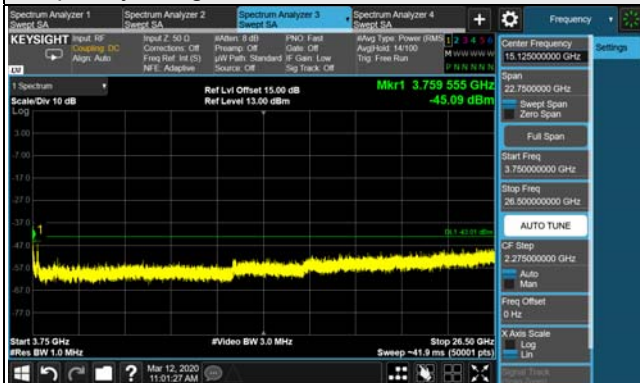

Frequency Range : 26.5GHz~40GHz

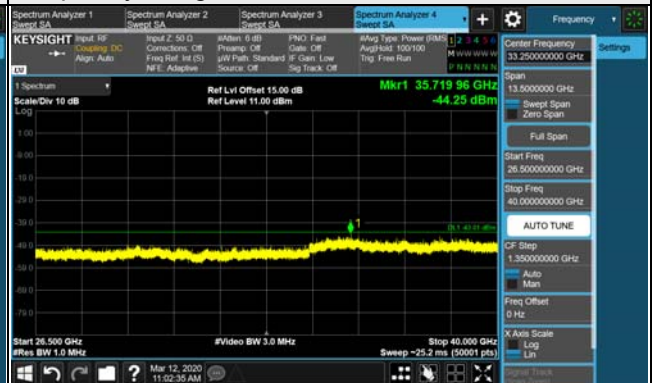

Note: The signal at 9 kHz is IF signal from spectrum analyzer.

Chain 1

LTE Band 48, Channel Bandwidth 10MHz

Channel 55290 (3555.0MHz)

Full RB

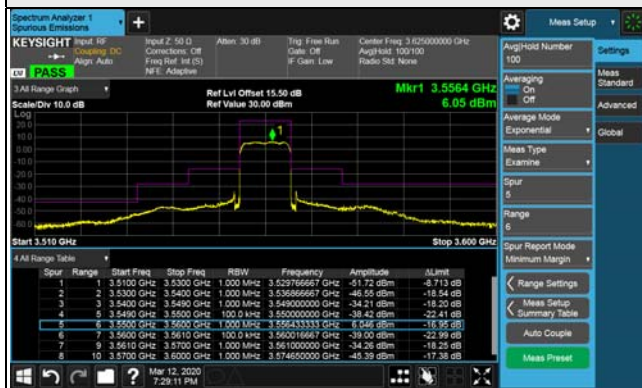

Channel 55990 (3625.00MHz)

Full RB



Channel 56690 (3695.0MHz)

Full RB





LTE Band 48, Channel Bandwidth 10MHz

Channel 55290 (3555.0MHz)

Frequency Range : 9kHz~1GHz

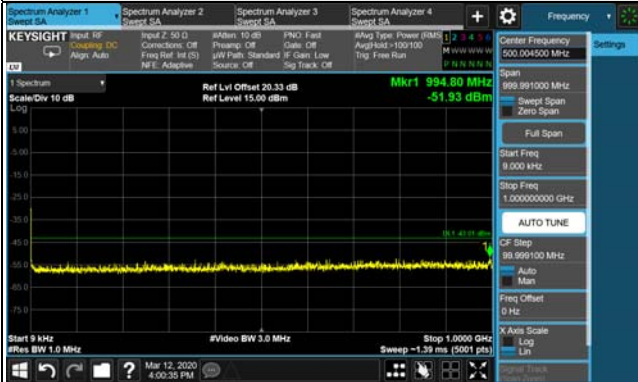

Frequency Range : 1GHz~3.48GHz

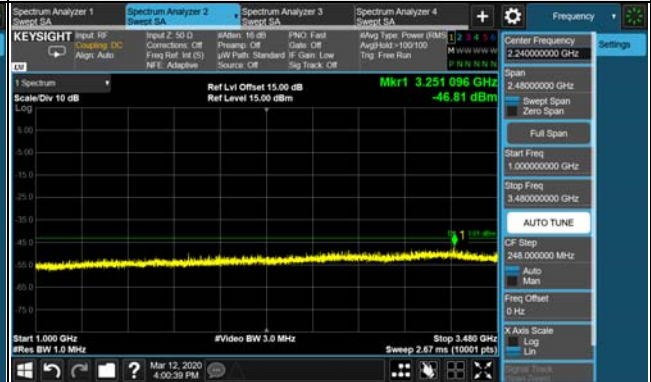

Frequency Range : 3.75GHz~26.5GHz



Frequency Range : 26.5GHz~40GHz

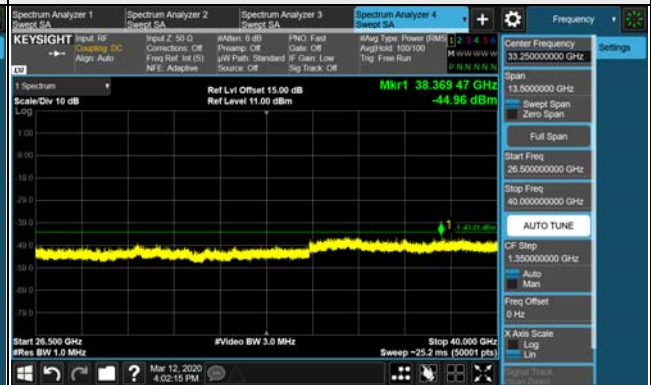

Note: The signal at 9 kHz is IF signal from spectrum analyzer.

LTE Band 48, Channel Bandwidth 10MHz

Channel 55990 (3625.00MHz)

Frequency Range : 9kHz~1GHz

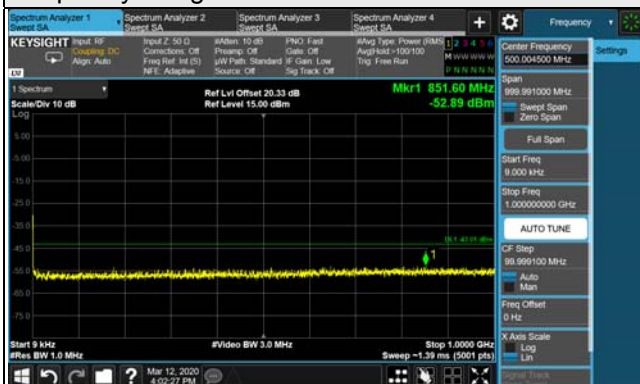

Frequency Range : 1GHz~3.48GHz

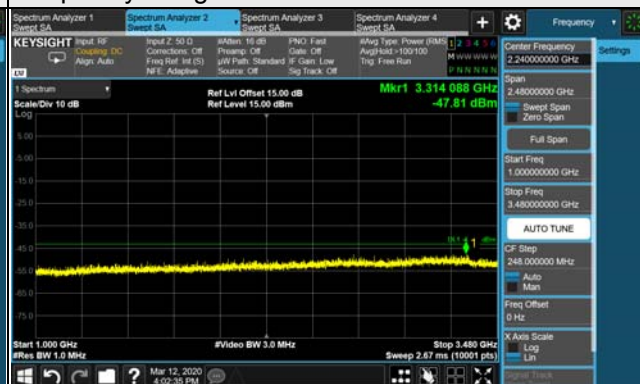

Frequency Range : 3.75GHz~26.5GHz



Frequency Range : 26.5GHz~40GHz

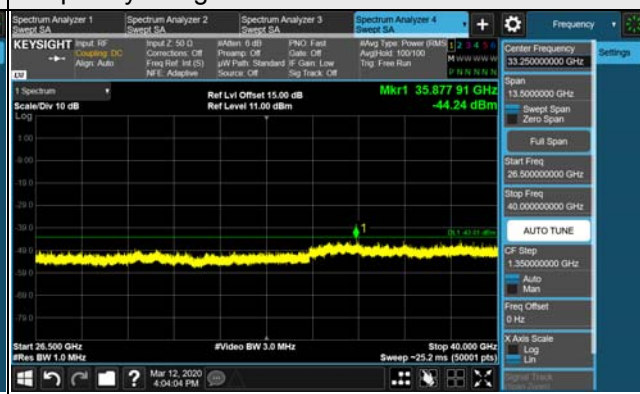

Note: The signal at 9 kHz is IF signal from spectrum analyzer.

LTE Band 48, Channel Bandwidth 10MHz

Channel 56690 (3695.0MHz)

Frequency Range : 9kHz~1GHz

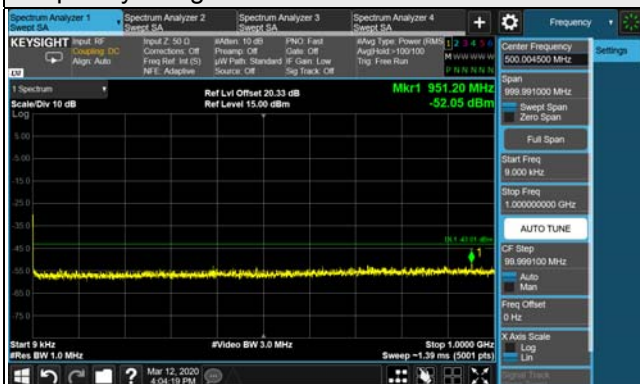

Frequency Range : 1GHz~3.48GHz

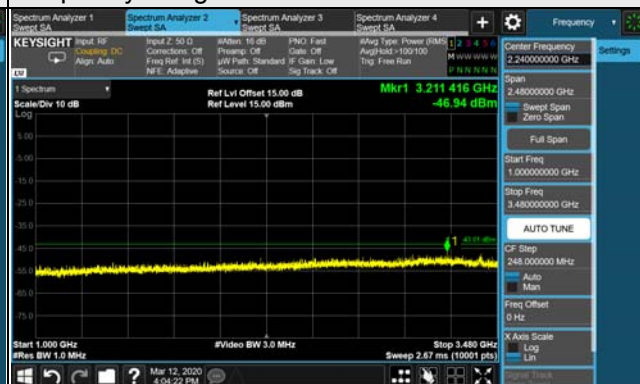

Frequency Range : 3.75GHz~26.5GHz



Frequency Range : 26.5GHz~40GHz

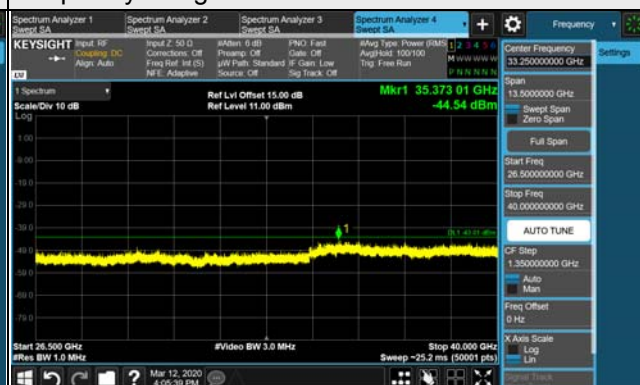

Note: The signal at 9 kHz is IF signal from spectrum analyzer.

LTE Band 48, Channel Bandwidth 20MHz

Channel 55340 (3560.0MHz)

Full RB

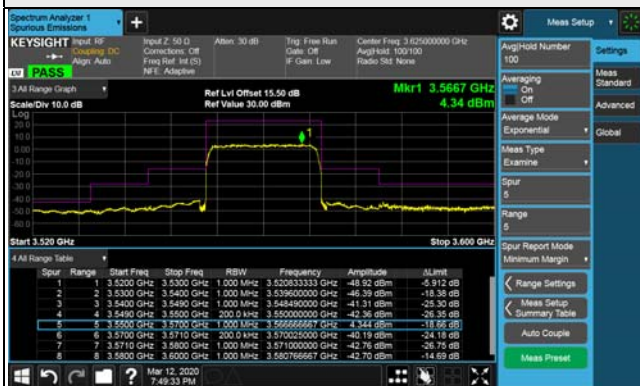

Channel 55990 (3625.0MHz)

Full RB

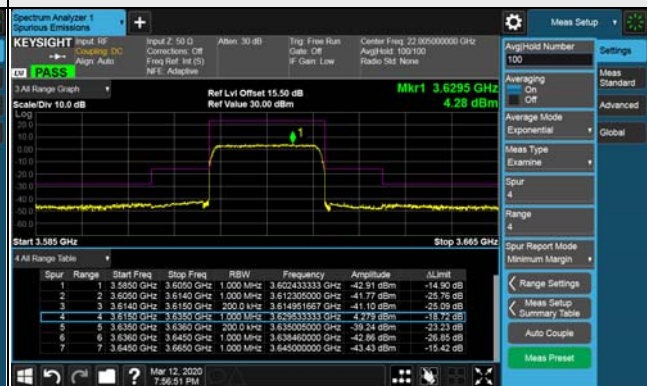

Channel 56640 (3690.0MHz)

Full RB



LTE Band 48, Channel Bandwidth 20MHz

Channel 55340 (3560.0MHz)

Frequency Range : 9kHz~1GHz

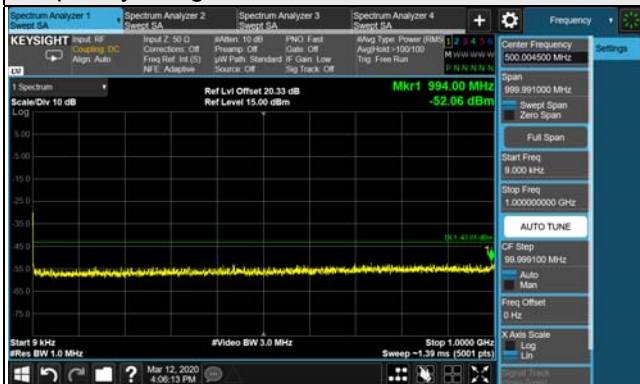

Frequency Range : 1GHz~3.48GHz



Frequency Range : 3.75GHz~26.5GHz



Frequency Range : 26.5GHz~40GHz



Note: The signal at 9 kHz is IF signal from spectrum analyzer.

LTE Band 48, Channel Bandwidth 20MHz

Channel 55990 (3625.0MHz)

Frequency Range : 9kHz~1GHz

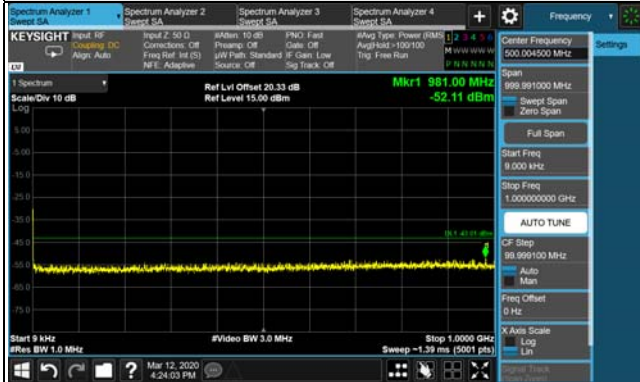

Frequency Range : 1GHz~3.48GHz

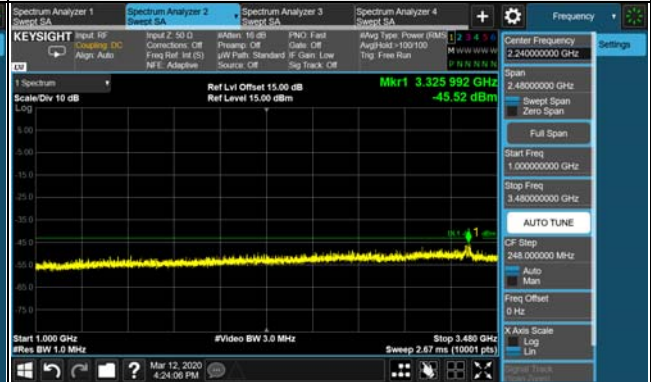

Frequency Range : 3.75GHz~26.5GHz



Frequency Range : 26.5GHz~40GHz

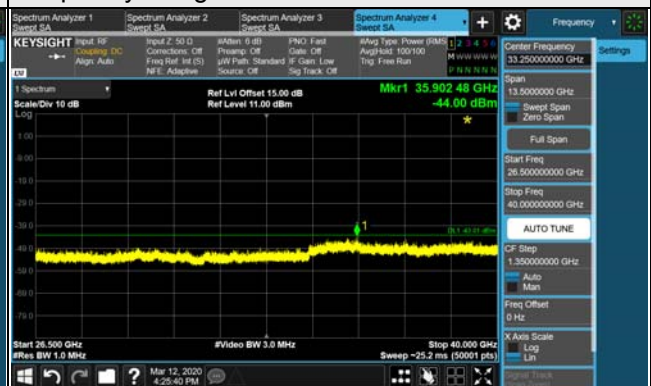

Note: The signal at 9 kHz is IF signal from spectrum analyzer.

LTE Band 48, Channel Bandwidth 20MHz

Channel 56640 (3690.0MHz)

Frequency Range : 9kHz~1GHz



Frequency Range : 1GHz~3.48GHz

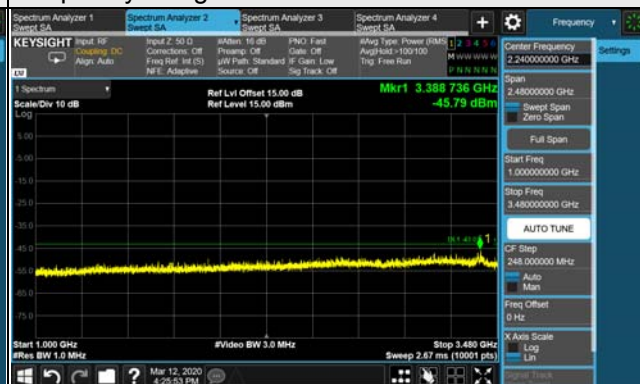

Frequency Range : 3.75GHz~26.5GHz

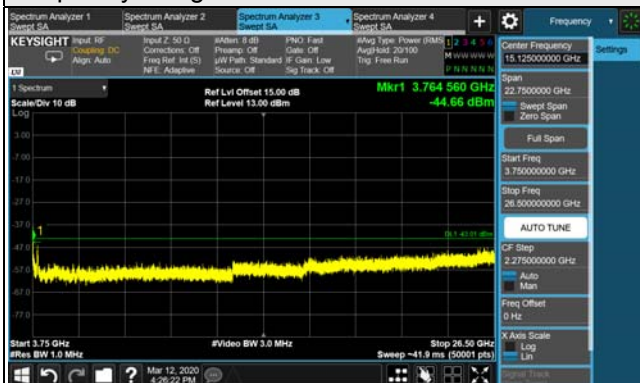

Frequency Range : 26.5GHz~40GHz



Note: The signal at 9 kHz is IF signal from spectrum analyzer.

## 4.8 Radiated Emission Measurement

### 4.8.1 Limits of Radiated Emission Measurement

The power of any emissions below 3530 MHz or above 3720 MHz shall not exceed -40dBm/MHz.

### 4.8.2 Test Instruments

Description & Manufacturer	Model No.	Serial No.	Cal. Date	Cal. Due
Test Receiver KEYSIGHT	N9038A	MY55420137	Apr. 15, 2019	Apr. 14, 2020
Spectrum Analyzer ROHDE & SCHWARZ	FSP40	100039	Jun. 12, 2019	Jun. 11, 2020
MXG Vector signal generator Agilent	N5182B	MY53050430	Nov. 25, 2019	Nov. 24, 2020
BILOG Antenna SCHWARZBECK	VULB9168	9168-160	Nov. 21, 2018	Nov. 20, 2019
HORN Antenna SCHWARZBECK	BBHA 9120D	9120D-969	Nov. 24, 2019	Nov. 23, 2020
HORN Antenna SCHWARZBECK	BBHA 9120 D	9120D-1169	Nov. 24, 2019	Nov. 23, 2020
HORN Antenna SCHWARZBECK	BBHA 9170	BBHA9170241	Nov. 24, 2019	Nov. 23, 2020
Preamplifier Agilent (Below 1GHz)	8447D	2944A10638	Jul. 11, 2019	Jul. 10, 2020
Preamplifier Agilent (Above 1GHz)	8449B	3008A02367	Feb. 19, 2019	Feb. 18, 2020
RF signal cable HUBER+SUHNER&EMCI	SUCOFLEX 104 & EMC104-SM-SM800 0	CABLE-CH9-02 (248780+171006)	Jan. 19, 2019	Jan. 18, 2020
			Jan. 18, 2020	Jan. 17, 2021
RF signal cable HUBER+SUHNER	SUCOFLEX 104	CABLE-CH9-(250795/4)	Jul. 11, 2019	Jul. 10, 2020
RF signal cable Woken	8D-FB	Cable-CH9-01	Jul. 30, 2019	Jul. 29, 2020
Software BV ADT	ADT_Radiated_ V7.6.15.9.5	NA	NA	NA
Antenna Tower EMCO	2070/2080	512.835.4684	NA	NA
Turn Table EMCO	2087-2.03	NA	NA	NA
Antenna Tower & Turn BV ADT	AT100	AT93021705	NA	NA
Turn Table BV ADT	TT100	TT93021705	NA	NA
Turn Table Controller BV ADT	SC100	SC93021705	NA	NA
Boresight Antenna Fixture	FBA-01	FBA-SIP01	NA	NA
Pre-amplifier (18GHz-40GHz) EMC	EMC184045B	980175	Sep. 05, 2019	Sep. 04, 2020
Standard Temperature And Humidity Chamber	MHU-225AU	920842	May 31, 2019	May 30, 2020
JFW 20dB attenuation	50HF-020-SMA	NA	NA	NA
True RMS Clamp Meter Fluke	325	31130711WS	May 21, 2019	May 20, 2020
AC Power Source EEC	6905S	1991553	NA	NA

Note: 1. The calibration interval of the above test instruments is 12 months and the calibrations are traceable to NML/ROC and NIST/USA.  
2. The test was performed in HwaYa Chamber 9.



#### 4.8.3 Test Procedures

- a. Substitution method is used for EIRP measurement. In the semi-anechoic chamber, EUT placed on the 0.8m (below or equal 1GHz) and / or 1.5m (above 1GHz) height of Turn Table, rotated the table around 360 degrees to search the maximum radiation power and receiver antenna shall be rotated vertical and horizontal polarization and moved height from 1m to 4m to find the maximum polar radiated power. The "Read Value" is the spectrum reading the maximum power value.
- b. The substitution antenna is substituted for EUT at the same position and signals generator export the CW signal to the substitution antenna via a TX cable. Rotated the Turn Table and moved receiving antenna to find the maximum radiation power. Adjust output power level of S.G to get a Value of spectrum reading equal to "Read Value" of step a. Record the power level of S.G
- c.  $EIRP = \text{Output power level of S.G} - \text{TX cable loss} + \text{Antenna gain of substitution horn}$ .
- d. ERP power can be calculated form EIRP power by subtracting the gain of dipole,  $ERP \text{ power} = EIRP \text{ power} - 2.15dBi$ .

**Note:** The resolution bandwidth of spectrum analyzer is 1 MHz and the video bandwidth is 3 MHz.

#### 4.8.4 Deviation from Test Standard

No deviation.

#### 4.8.5 Test Set Up

##### <Frequency Range below 1GHz>

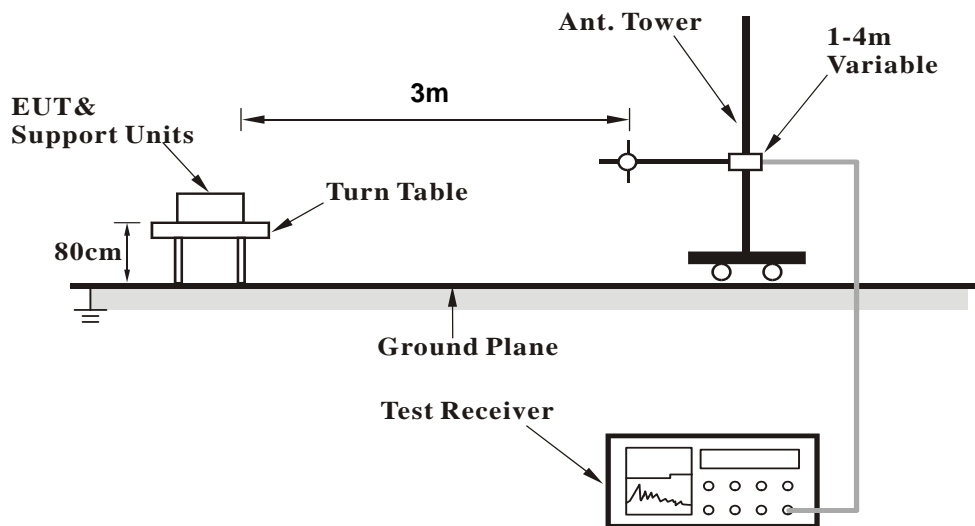

##### <Frequency Range above 1GHz>

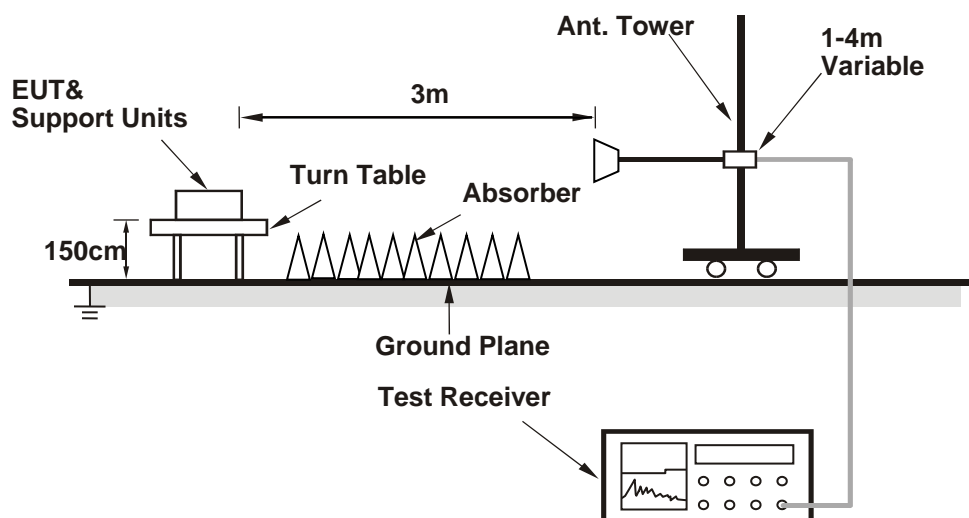

For the actual test configuration, please refer to the attached file (Test Setup Photo).

#### 4.8.6 Test Results

Test was done with 50ohm terminator on antenna port.

#### Below 1GHz Data

LTE Band 48, Channel Bandwidth 10MHz

Mode	TX channel 55900 (3625.0MHz)	Frequency Range	Below 1000 MHz
Environmental Conditions	22deg. C, 68%RH	Input Power	120Vac, 60Hz
Tested By	Greg Lin		

Antenna Polarity & Test Distance: Horizontal at 3 M							
No.	Freq. (MHz)	Reading (dBm)	S.G Power Value (dBm)	Correction Factor (dB)	EIRP (dBm)	Limit (dBm)	Margin (dB)
1	31.94	-53.3	-31.6	-18.3	-49.9	-40.0	-9.9
2	87.23	-37.5	-44.6	-0.1	-44.7	-40.0	-4.7
3	188.11	-52.2	-57.7	-2.7	-60.4	-40.0	-20.4
4	289.96	-60.8	-62.5	-1.7	-64.2	-40.0	-24.2
5	582.90	-61.0	-63.6	3.8	-59.8	-40.0	-19.8
6	821.52	-64.9	-62.3	3.9	-58.4	-40.0	-18.4

Remarks:

1. EIRP (dBm) = S.G Value (dBm) + Correction Factor (dB).
2. Correction Factor (dB) = Substitution Antenna Gain (dB) + Cable Loss (dB).

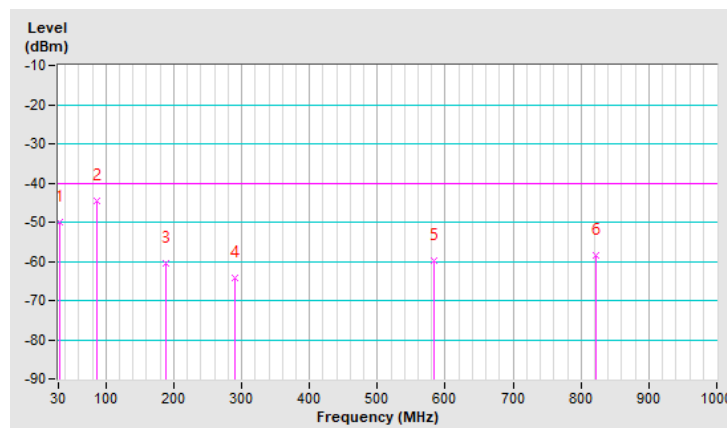

Mode	TX channel 55900 (3625.0MHz)	Frequency Range	Below 1000 MHz
Environmental Conditions	22deg. C, 68%RH	Input Power	120Vac, 60Hz
Tested By	Greg Lin		

Antenna Polarity & Test Distance: Vertical at 3 M							
No.	Freq. (MHz)	Reading (dBm)	S.G Power Value (dBm)	Correction Factor (dB)	EIRP (dBm)	Limit (dBm)	Margin (dB)
1	68.80	-44.2	-50.0	-0.8	-50.8	-40.0	-10.8
2	132.82	-49.7	-50.6	-3.3	-53.9	-40.0	-13.9
3	185.20	-48.4	-48.5	-2.8	-51.3	-40.0	-11.3
4	253.10	-55.5	-54.0	-1.4	-55.4	-40.0	-15.4
5	583.87	-59.9	-61.3	3.8	-57.5	-40.0	-17.5
6	901.06	-66.0	-61.2	3.5	-57.7	-40.0	-17.7

Remarks:

1. EIRP (dBm) = S.G Value (dBm) + Correction Factor (dB).
2. Correction Factor (dB) = Substitution Antenna Gain (dB) + Cable Loss (dB).

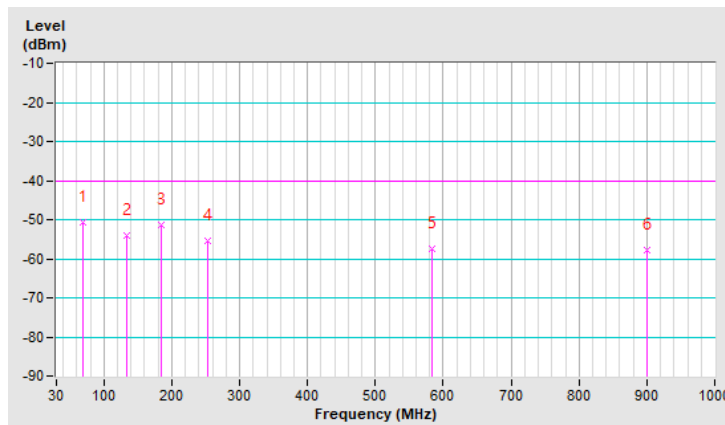

LTE Band 48, Channel Bandwidth 20MHz

Mode	TX channel 55340 (3560.0MHz)	Frequency Range	Below 1000 MHz
Environmental Conditions	22deg. C, 68%RH	Input Power	120Vac, 60Hz
Tested By	Greg Lin		

Antenna Polarity & Test Distance: Horizontal at 3 M

No.	Freq. (MHz)	Reading (dBm)	S.G Power Value (dBm)	Correction Factor (dB)	EIRP (dBm)	Limit (dBm)	Margin (dB)
1	37.76	-49.1	-31.1	-14.7	-45.8	-40.0	-5.8
2	87.23	-36.7	-43.8	-0.1	-43.9	-40.0	-3.9
3	154.16	-55.8	-57.2	-2.9	-60.1	-40.0	-20.1
4	262.80	-55.8	-58.9	-1.6	-60.5	-40.0	-20.5
5	579.02	-61.0	-63.7	3.7	-60.0	-40.0	-20.0
6	903.97	-65.7	-61.7	3.6	-58.1	-40.0	-18.1

Remarks:

1. EIRP (dBm) = S.G Value (dBm) + Correction Factor (dB).
2. Correction Factor (dB) = Substitution Antenna Gain (dB) + Cable Loss (dB).

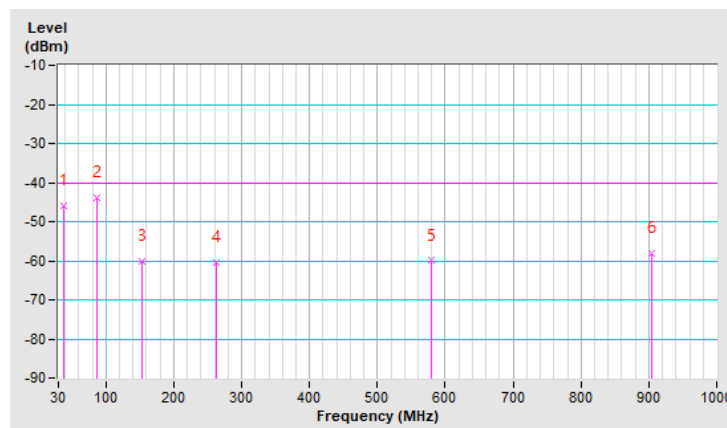

Mode	TX channel 55340 (3560.0MHz)	Frequency Range	Below 1000 MHz
Environmental Conditions	22deg. C, 68%RH	Input Power	120Vac, 60Hz
Tested By	Greg Lin		

Antenna Polarity & Test Distance: Vertical at 3 M

No.	Freq. (MHz)	Reading (dBm)	S.G Power Value (dBm)	Correction Factor (dB)	EIRP (dBm)	Limit (dBm)	Margin (dB)
1	60.07	-37.3	-40.7	-3.4	-44.1	-40.0	-4.1
2	141.55	-48.4	-47.8	-3.0	-50.8	-40.0	-10.8
3	191.02	-45.4	-44.6	-2.7	-47.3	-40.0	-7.3
4	358.83	-56.9	-61.3	4.0	-57.3	-40.0	-17.3
5	667.29	-50.9	-49.1	3.6	-45.5	-40.0	-5.5
6	909.79	-65.3	-60.4	3.5	-56.9	-40.0	-16.9

Remarks:

1. EIRP (dBm) = S.G Value (dBm) + Correction Factor (dB).
2. Correction Factor (dB) = Substitution Antenna Gain (dB) + Cable Loss (dB).

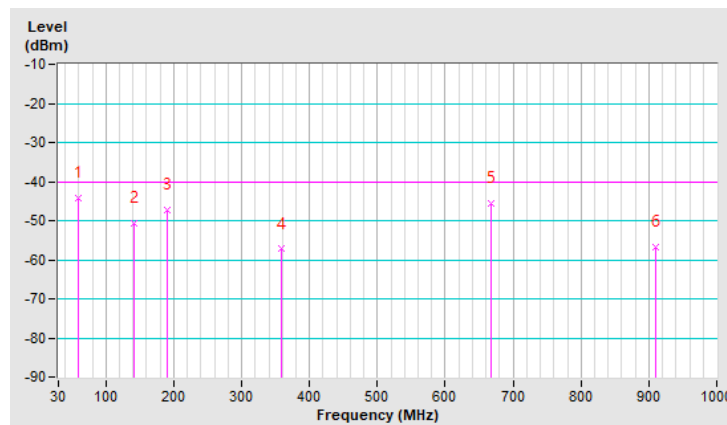

### Above 1GHz

LTE Band 48, Channel Bandwidth 10MHz

Mode	TX channel 55290 (3555.0MHz)	Frequency Range	1GHz ~ 40GHz
Environmental Conditions	22deg. C, 68%RH	Input Power	120Vac, 60Hz
Tested By	Greg Lin		

Antenna Polarity & Test Distance: Horizontal at 3 M							
No.	Freq. (MHz)	Reading (dBm)	S.G Power Value (dBm)	Correction Factor (dB)	EIRP (dBm)	Limit (dBm)	Margin (dB)
1	7111.00	-60.1	-42.0	0.7	-41.3	-40.0	-1.3
Antenna Polarity & Test Distance: Vertical at 3 M							
No.	Freq. (MHz)	Reading (dBm)	S.G Power Value (dBm)	Correction Factor (dB)	EIRP (dBm)	Limit (dBm)	Margin (dB)
1	7111.00	-60.7	-43.0	0.7	-42.3	-40.0	-2.3

Remarks:

1. EIRP (dBm) = S.G Value (dBm) + Correction Factor (dB).
2. Correction Factor (dB) = Substitution Antenna Gain (dB) + Cable Loss (dB).

Mode	TX channel 55990 (3625.0MHz)	Frequency Range	1GHz ~ 40GHz
Environmental Conditions	22deg. C, 68%RH	Input Power	120Vac, 60Hz
Tested By	Greg Lin		

Antenna Polarity & Test Distance: Horizontal at 3 M							
No.	Freq. (MHz)	Reading (dBm)	S.G Power Value (dBm)	Correction Factor (dB)	EIRP (dBm)	Limit (dBm)	Margin (dB)
1	7250.00	-59.8	-42.0	0.9	-41.1	-40.0	-1.1
Antenna Polarity & Test Distance: Vertical at 3 M							
No.	Freq. (MHz)	Reading (dBm)	S.G Power Value (dBm)	Correction Factor (dB)	EIRP (dBm)	Limit (dBm)	Margin (dB)
1	7250.00	-60.4	-42.5	0.9	-41.6	-40.0	-1.6

Remarks:

1. EIRP (dBm) = S.G Value (dBm) + Correction Factor (dB).
2. Correction Factor (dB) = Substitution Antenna Gain (dB) + Cable Loss (dB).

Mode	TX channel 56690 (3695.0MHz)	Frequency Range	1GHz ~ 40GHz
Environmental Conditions	22deg. C, 68%RH	Input Power	120Vac, 60Hz
Tested By	Greg Lin		

Antenna Polarity & Test Distance: Horizontal at 3 M							
No.	Freq. (MHz)	Reading (dBm)	S.G Power Value (dBm)	Correction Factor (dB)	EIRP (dBm)	Limit (dBm)	Margin (dB)
1	7390.00	-60.7	-42.1	0.9	-41.2	-40.0	-1.2
Antenna Polarity & Test Distance: Vertical at 3 M							
No.	Freq. (MHz)	Reading (dBm)	S.G Power Value (dBm)	Correction Factor (dB)	EIRP (dBm)	Limit (dBm)	Margin (dB)
1	7390.00	-61.3	-43.6	0.9	-42.7	-40.0	-2.7

Remarks:

1. EIRP (dBm) = S.G Value (dBm) + Correction Factor (dB).
2. Correction Factor (dB) = Substitution Antenna Gain (dB) + Cable Loss (dB).



LTE Band 48, Channel Bandwidth 20MHz

Mode	TX channel 55340 (3560.0MHz)	Frequency Range	1GHz ~ 40GHz
Environmental Conditions	22deg. C, 68%RH	Input Power	120Vac, 60Hz
Tested By	Greg Lin		

Antenna Polarity & Test Distance: Horizontal at 3 M

No.	Freq. (MHz)	Reading (dBm)	S.G Power Value (dBm)	Correction Factor (dB)	EIRP (dBm)	Limit (dBm)	Margin (dB)
1	7120.00	-59.7	-41.7	0.7	-41.0	-40.0	-1.0

Antenna Polarity & Test Distance: Vertical at 3 M

No.	Freq. (MHz)	Reading (dBm)	S.G Power Value (dBm)	Correction Factor (dB)	EIRP (dBm)	Limit (dBm)	Margin (dB)
1	7120.00	-60.0	-42.3	0.7	-41.6	-40.0	-1.6

Remarks:

1. EIRP (dBm) = S.G Value (dBm) + Correction Factor (dB).
2. Correction Factor (dB) = Substitution Antenna Gain (dB) + Cable Loss (dB).

Mode	TX channel 55990 (3625.00MHz)	Frequency Range	1GHz ~ 40GHz
Environmental Conditions	22deg. C, 68%RH	Input Power	120Vac, 60Hz
Tested By	Greg Lin		

Antenna Polarity & Test Distance: Horizontal at 3 M

No.	Freq. (MHz)	Reading (dBm)	S.G Power Value (dBm)	Correction Factor (dB)	EIRP (dBm)	Limit (dBm)	Margin (dB)
1	7250.00	-59.9	-42.1	0.9	-41.2	-40.0	-1.2

Antenna Polarity & Test Distance: Vertical at 3 M

No.	Freq. (MHz)	Reading (dBm)	S.G Power Value (dBm)	Correction Factor (dB)	EIRP (dBm)	Limit (dBm)	Margin (dB)
1	7250.00	-60.2	-42.3	0.9	-41.4	-40.0	-1.4

Remarks:

1. EIRP (dBm) = S.G Value (dBm) + Correction Factor (dB).
2. Correction Factor (dB) = Substitution Antenna Gain (dB) + Cable Loss (dB).

Mode	TX channel 56640 (3690.00MHz)	Frequency Range	1GHz ~ 40GHz
Environmental Conditions	22deg. C, 68%RH	Input Power	120Vac, 60Hz
Tested By	Greg Lin		

Antenna Polarity & Test Distance: Horizontal at 3 M							
No.	Freq. (MHz)	Reading (dBm)	S.G Power Value (dBm)	Correction Factor (dB)	EIRP (dBm)	Limit (dBm)	Margin (dB)
1	7380.00	-60.5	-42.0	0.9	-41.1	-40.0	-1.1
Antenna Polarity & Test Distance: Vertical at 3 M							
No.	Freq. (MHz)	Reading (dBm)	S.G Power Value (dBm)	Correction Factor (dB)	EIRP (dBm)	Limit (dBm)	Margin (dB)
1	7380.00	-60.7	-43.0	0.9	-42.1	-40.0	-2.1

Remarks:

1. EIRP (dBm) = S.G Value (dBm) + Correction Factor (dB).
2. Correction Factor (dB) = Substitution Antenna Gain (dB) + Cable Loss (dB).

## 5 Pictures of Test Arrangements

Please refer to the attached file (Test Setup Photo).

## Appendix – Information of the Testing Laboratories

We, Bureau Veritas Consumer Products Services (H.K.) Ltd., Taoyuan Branch, were founded in 1988 to provide our best service in EMC, Radio, Telecom and Safety consultation. Our laboratories are accredited and approved according to ISO/IEC 17025.

If you have any comments, please feel free to contact us at the following:

### Lin Kou EMC/RF Lab

Tel: 886-2-26052180

Fax: 886-2-26051924

### Hsin Chu EMC/RF Lab/Telecom Lab

Tel: 886-3-6668565

Fax: 886-3-6668323

### Hwa Ya EMC/RF/Safety Lab

Tel: 886-3-3183232

Fax: 886-3-3270892

**Email:** [service.adt@tw.bureauveritas.com](mailto:service.adt@tw.bureauveritas.com)

**Web Site:** [www.bureauveritas-adt.com](http://www.bureauveritas-adt.com)

The address and road map of all our labs can be found in our web site also.

--- END ---