

# FEMTOCELL MULTI-BAND SOHO

B2/B4 (SS2FII)

## Quick Start Guide



**Table of Contents**

Welcome ..... 3

Box Content ..... 4

Connection Overview ..... 5

Quick Setup ..... 6

Common Troubleshooting Procedures ..... 10

FAQs ..... 11

## *Welcome*

The Femtocell Multi-band SOHO (Small Office Home Office) provides enhanced mobile voice and data service within buildings. It delivers high quality voice calls and faster, more reliable mobile data service.

The Femtocell Multi-band SOHO connects to your broadband Internet service to deliver extended indoor mobile network coverage. The in-building mobile phone connectivity, signal quality, and data bandwidth will greatly improve, especially if the building is in a remote area or out of adequate mobile phone tower range.

Inside this package you will find the Femtocell Multi-band SOHO and its accessories necessary for the installation. The Femtocell Multi-band SOHO has a zero touch set-up process. Just install as detailed in this guide and it connects to your mobile phone automatically whenever your phone is within range.

Before you begin you need to make sure you have the following:

- High speed internet service and an available Ethernet LAN port on your router.
- An available power socket or electrical outlet. This is not required if using Power-Over-Ethernet (PoE).
- A 3G or LTE phone registered for 3G or LTE service with your service provider.

# *Box Content*



**Quick Start Guide**  
(This document)

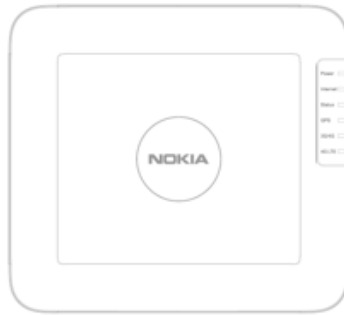

**Femtocell Multi-band SOHO**

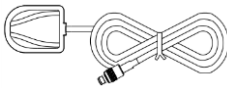

**GPS Antenna & Cable**  
(15 feet)

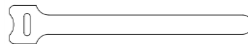

**Velcro Strap**

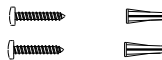

**Wall Mounting Kit**  
(2 Screws and 2 Wall Anchors)

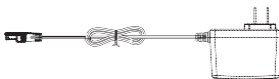

**AC Power Adaptor**

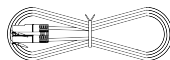

**Ethernet Cable**

# Connection Overview

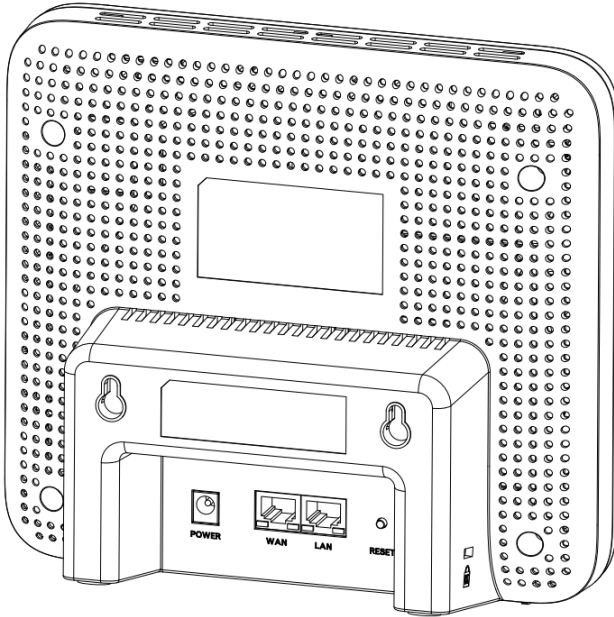

### Power

Power on when AC Adaptor is plugged in

### Yellow WAN Port

Connect to internet router

### Grey LAN Port

Connect to other devices, like PC, if needed

### Reset

1. Press and hold for 5 seconds for reboot
2. Press and hold for 20 seconds for factory setting reset and software update

# Quick Setup

## 1 Connect your Femtocell Multi-band SOHO to the Internet

Connect the yellow Ethernet cable from the yellow “WAN” port on your Femtocell Multi-band SOHO to an available Ethernet port on your internet router.

## 2 Connect GPS antenna to your Femtocell Multi-band SOHO

Connect the GPS antenna cable to the GPS port on the Femtocell Multi-band SOHO. The GPS antenna helps reduce the device setup time and improves device location accuracy. Position the antenna as close to a window as possible.

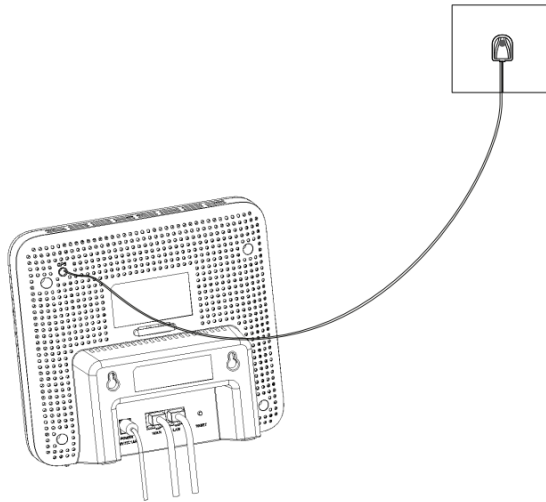

## 3 Power on your Femtocell Multi-band SOHO

Plug in your AC power adaptor into the power outlet and connect the power cable to the Femtocell Multi-band SOHO power port.

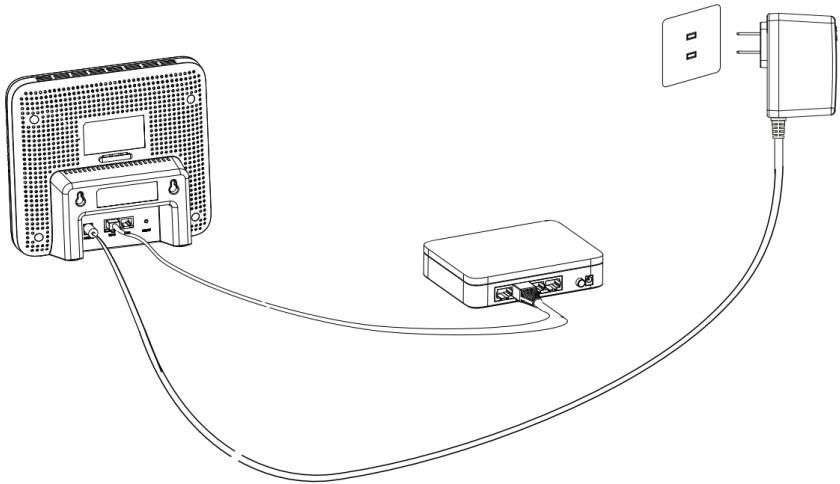

## 4 Let your Femtocell Multi-band SOHO set up

After you power on your Femtocell Multi-band SOHO, it will go through self-installation. It can take up to 45 minutes to complete the device setup. Your Femtocell Multi-band SOHO may download updates and restart during this time.

- **Power (Solid Green)**

Power on. Device self-testing and update complete.

- **Internet (Solid Green)**

Successful internet connection.

- **Status (Solid Green)**

Successful connection established with mobile operator network.

- **GPS (Solid Green Optional)**

GPS position locked if GPS if signal is present.

- **3G/4G (Solid Green)**

Device is ready to provide 3G service.

- **4G LTE (Solid Green)**

Device is ready to provide LTE service.







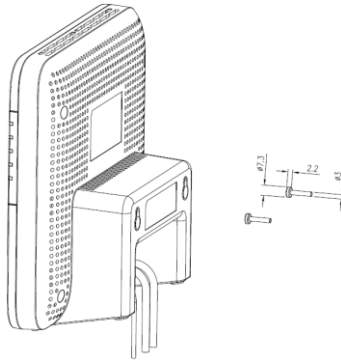

























## 5 Wall mount your Femtocell Multi-band SOHO if desired



**Congratulations! Your Femtocell Multi-band SOHO setup is complete.**

You should see improved signal strength from your device. Make your first call to enjoy more dependable voice calls and a more reliable high speed data connection.

# Common Troubleshooting Procedures

Issue Description and Resolution	Power	Internet	Status	GPS	3G	4G
Device has a hardware issue.	 Solid Orange	 Solid Orange	 Solid Orange	 Solid Orange	 Solid Orange	 Solid Orange
Device unable to capture GPS signal. Without GPS signal lock, device is still able to proceed through setup and operate normally. You may receive SMS or email notifications to verify your device use address for emergency 119 or 911 call safety.	Any	Any	Any	 Solid Orange	Any	Any
Device connection issue with router.	 Flashing or Solid Green	 Solid Orange	Off	Any	Off	Off
Device is unable to reach network. Check with Internet Service Provider on network settings. Ensure ports UDP 500, UDP 4500 and UDP 123 are opened.	 Flashing or Solid Green	 Flashing Orange	Off	Any	Off	Off
Unable to activate the device with network.	 Flashing or Solid Green	 Solid Green	 Solid or Flashing Orange	Any	Off	Off
3G, 4G, service is not available. Device may not be used in market or remote disabled.	 Solid Green	 Solid Green	 Solid or Flashing Green	Any	Off	Off
Device has reached maximum number of active voice and data connections for each technology. Attempt to call again after existing calls are terminated.	 Solid Green	 Solid Green	 Flashing Green	Any	 Flashing Green	 Flashing Green
The device is overheated. Move device to a cooler location.	 Flashing Orange	 Flashing Orange	 Flashing Orange	 Flashing Orange	 Flashing Orange	 Flashing Orange

## FAQs

### **How do I know that I am using my Femtocell Multi-band SOHO service?**

Your mobile phone display will automatically indicate if you are within small cell signal range. If registered and configured properly, your mobile phone should display a small cell service message and an associated signal indicator.

### **Will my call drop if I leave the building in the middle of a call?**

If you move out of range of the Femtocell Multi-band SOHO, your call will be automatically transferred to the next available network service offered by your mobile service provider, without disconnecting your call. If no other mobile network is available your call will be disconnected.

### **What happens if my broadband connection fails?**

If you lose your broadband connection in cases of IP connectivity set up failure, the Internet light will light solid orange and your Femtocell Multi-band SOHO coverage will stop. The Femtocell Multi-band SOHO service will return when the broadband connection is recovered.

### **What happens if my Femtocell Multi-band SOHO stops operating – can I still place a call?**

If your Femtocell Multi-band SOHO stops operating (e.g. if you have lost your broadband connection) then you will no

longer be able to place calls through the Femtocell Multi-band SOHO. However, if you have coverage from the mobile network of your mobile service provider you can still place calls normally.

## *Safety Notes*

**GENERAL:** Please read this Quick Start Guide carefully before using the Femtocell Multi-band SOHO. The purpose of the Femtocell Multi-band SOHO is to provide improved mobile signal coverage inside a building. Do not use this device for any other purpose, as doing so may be dangerous.

**PLACEMENT:** The Femtocell Multi-band SOHO and all its components (including cables and power adaptor) should be placed in a dry, indoor area, at elevated heights such as on top of shelves, cabinets, etc. It should be kept away from any wet or damp environments; such as kitchens, bathrooms, laundry rooms or any other areas with exposure to moisture, sprays, drips, or running water. For the safety of stored data, it should not be placed near magnetic devices such as audio or video tapes, diskettes or credit cards. While in service, the antenna should not be co-located with another antenna or transmitting device.

**CONDITIONS OF USE:**

Temperature rating: -5°C to 45°C.  
Relative Humidity rating: 5% to 95%.  
Maximum altitude: 3960m.

**MEDICAL DEVICES:** The Femtocell Multi-band SOHO contains a radio transmitter. Medical devices such as pacemakers and hearing aids may be affected, unless precautions are taken, when using this device. Please contact your healthcare provider for additional safety guidelines.

**COMPLIANCE WITH APPLICABLE EXPOSURE LIMITS:** The Femtocell Multi-band SOHO is a multiband radio transmitter and receiver. When it's turned on, it receives and transmits radio frequency (RF) signals. The system controls the transmitted power level within a range up to 0.5 W, cumulated over all transmitting bands.

**EMERGENCY:** The Femtocell Multi-band SOHO does not operate during instances of power loss. To make emergency calls under this condition, please use a mobile or land line phone.

**POWER SUPPLY:** Ensure that the voltage specified corresponds to the power socket to which you connect it. In case of power loss (and therefore loss of service), all mobile calls, including emergency calls, will be redirected automatically to the default mobile (carrier) network. If you have no mobile network coverage and need to make an emergency call, please use a land line. In case of a thunderstorm, please disconnect the device to avoid damage. For safety reasons, only authorized service technicians should open the device.

The AC/DC adapter meets the following specifications:

Input power: 100-240VAC, 50-60Hz, 1.0A

Output power: 12VDC, 2A

**INTERFACES:**

All output ports are considered limited power sources (LPS).

**DISPOSAL & RECYCLING:** To facilitate disposal and/or recycling, please respect the sorting rules of your country or region for this kind of device. European regulations require the disposal of this device at sales points or at designated collection points such as drop-off centers, etc.

# *Federal Communications Commission Interference Statement*

This equipment complies with Part 15 of the FCC Rules. Operation is subject to the following two conditions: (1) This device does not cause harmful interference, and (2) this device must accept any interference received, including interference that may cause undesired operation.

This equipment has been tested and complies with the Class B digital device limits, pursuant to Part 15 of the FCC Rules. These limits are designed to provide reasonable protection against harmful interference in a residential installation. This equipment generates, uses and can radiate radio frequency energy and, if not installed and used according to the instructions, may cause harmful interference to radio communications. However, there is no guarantee that interference cannot occur in a particular installation. If this equipment does cause harmful interference to radio or television reception, which can be determined by turning the equipment off and on, the user is encouraged to try to correct the interference by taking one of the

following actions:

- Reorient or relocate the receiving antenna.
- Increase the separation between the equipment and the receiver.
- Connect the equipment into an outlet on a circuit different from that to which the receiver is connected.
- Consult the dealer or an experienced radio/TV technician for help.

## **FCC Caution**

Any changes or modifications not expressly approved by the party responsible for compliance could void the user's authority to operate this equipment.

This transmitter must not be co-located or operated in conjunction with any other antenna or transmitter.

## **Radiofrequency Radiation Exposure Statement**

When using FCC OET Bulletin 65 and its supplements, this equipment complies with FCC 47 CFR 1.1307(b) for radiofrequency radiation exposure in uncontrolled (general public) environments. This equipment shall be installed and operated with a minimum distance of 20cm between the radiator and your body.

**Copyright © 2017 Nokia. All rights reserved.**

The information presented is subject to change without notice. Nokia assumes no responsibility for inaccuracies contained herein.

**NOTICE OF LIABILITY:** Every effort has been made to ensure that this guide contains accurate and current information. However Nokia and the author shall not be liable for any loss or damage suffered by readers as a result of any information contained herein.

**TRADEMARKS:** Nokia and the Nokia logo are registered trademarks of Nokia. All other trademarks are the property of their respective owners.

20170501