



FCC TEST REPORT (15.247)

REPORT NO.: RF990614E03

MODEL NO.: DWG875T,
DWG875XX (The "X" of Model Name could be A~Z)

FCC ID: H8NPKE938

RECEIVED: June 14, 2010

TESTED: June 15 to July 14, 2010

ISSUED: July 23, 2010

APPLICANT: ASKEY COMPUTER CORP.

ADDRESS: 10F, No.119, ChienKang RD., Chungho,
Taipei, Taiwan

ISSUED BY: Bureau Veritas Consumer Products Services
(H.K.) Ltd., Taoyuan Branch Hsin Chu Laboratory

LAB ADDRESS: No. 81-1, Lu Liao Keng, 9th Ling,Wu Lung Tsuen,
Chiung Lin Hsiang, Hsin Chu Hsien 307, Taiwan

TEST LOCATION (1): No. 81-1, Lu Liao Keng, 9th Ling,Wu Lung Tsuen,
Chiung Lin Hsiang, Hsin Chu Hsien 307, Taiwan

TEST LOCATION (2): No. 49, Ln. 206, Wende Rd., Shangshan Tsuen,
Chiung Lin Hsiang, Hsin Chu Hsien 307, Taiwan

This test report consists of 124 pages in total. It may be duplicated completely for legal use with the approval of the applicant. It should not be reproduced except in full, without the written approval of our laboratory. The client should not use it to claim product endorsement by any government agencies. The test results in the report only apply to the tested sample.



Table of Contents

| | | |
|-------|---|----|
| 1. | CERTIFICATION | 5 |
| 2. | SUMMARY OF TEST RESULTS | 6 |
| 2.1 | MEASUREMENT UNCERTAINTY | 8 |
| 3. | GENERAL INFORMATION | 9 |
| 3.1 | GENERAL DESCRIPTION OF EUT | 9 |
| 3.2 | DESCRIPTION OF TEST MODES | 13 |
| 3.2.1 | TEST MODE APPLICABILITY AND TESTED CHANNEL DETAIL | 14 |
| 3.3 | GENERAL DESCRIPTION OF APPLIED STANDARDS | 17 |
| 3.4 | DESCRIPTION OF SUPPORT UNITS | 18 |
| 3.5 | CONFIGURATION OF SYSTEM UNDER TEST | 19 |
| 4. | TEST TYPES AND RESULTS (802.11b & g, 2400 ~ 2483.5MHz Band) | 20 |
| 4.1 | CONDUCTED EMISSION MEASUREMENT | 20 |
| 4.1.1 | LIMITS OF CONDUCTED EMISSION MEASUREMENT | 20 |
| 4.1.2 | TEST INSTRUMENTS | 20 |
| 4.1.3 | TEST PROCEDURES | 21 |
| 4.1.4 | DEVIATION FROM TEST STANDARD | 21 |
| 4.1.5 | TEST SETUP | 22 |
| 4.1.6 | EUT OPERATING CONDITIONS | 22 |
| 4.1.7 | TEST RESULTS | 23 |
| 4.2 | RADIATED EMISSION MEASUREMENT | 27 |
| 4.2.1 | LIMITS OF RADIATED EMISSION MEASUREMENT | 27 |
| 4.2.2 | TEST INSTRUMENTS | 28 |
| 4.2.3 | TEST PROCEDURES | 30 |
| 4.2.4 | DEVIATION FROM TEST STANDARD | 30 |
| 4.2.5 | TEST SETUP | 31 |
| 4.2.6 | EUT OPERATING CONDITIONS | 32 |
| 4.2.7 | TEST RESULTS | 33 |
| 4.3 | 6dB BANDWIDTH MEASUREMENT | 62 |
| 4.3.1 | LIMITS OF 6dB BANDWIDTH MEASUREMENT | 62 |
| 4.3.2 | TEST INSTRUMENTS | 62 |
| 4.3.3 | TEST PROCEDURE | 62 |
| 4.3.4 | DEVIATION FROM TEST STANDARD | 62 |
| 4.3.5 | TEST SETUP | 62 |
| 4.3.6 | EUT OPERATING CONDITIONS | 62 |
| 4.3.7 | TEST RESULTS | 63 |
| 4.4 | MAXIMUM PEAK OUTPUT POWER | 67 |
| 4.4.1 | LIMITS OF MAXIMUM PEAK OUTPUT POWER MEASUREMENT | 67 |



A D T

| | | |
|-------|---|-----|
| 4.4.2 | INSTRUMENTS | 67 |
| 4.4.3 | TEST PROCEDURES | 67 |
| 4.4.4 | DEVIATION FROM TEST STANDARD | 67 |
| 4.4.5 | TEST SETUP | 67 |
| 4.4.6 | EUT OPERATING CONDITIONS | 67 |
| 4.4.7 | TEST RESULTS | 68 |
| 4.5 | POWER SPECTRAL DENSITY MEASUREMENT | 70 |
| 4.5.1 | LIMITS OF POWER SPECTRAL DENSITY MEASUREMENT | 70 |
| 4.5.2 | TEST INSTRUMENTS | 70 |
| 4.5.3 | TEST PROCEDURE | 70 |
| 4.5.4 | DEVIATION FROM TEST STANDARD | 70 |
| 4.5.5 | TEST SETUP | 70 |
| 4.5.6 | EUT OPERATING CONDITION | 70 |
| 4.5.7 | TEST RESULTS | 71 |
| 4.6 | CONDUCTED OUT-BAND EMISSION MEASUREMENT | 75 |
| 4.6.1 | LIMITS OF CONDUCTED OUT-BAND EMISSION MEASUREMENT | 75 |
| 4.6.2 | TEST INSTRUMENTS | 75 |
| 4.6.3 | TEST PROCEDURE | 75 |
| 4.6.4 | DEVIATION FROM TEST STANDARD | 75 |
| 4.6.5 | EUT OPERATING CONDITION | 75 |
| 4.6.6 | TEST RESULTS | 75 |
| 5. | TEST TYPES AND RESULTS (802.11a, 5725~5850MHz Band) | 84 |
| 5.1 | CONDUCTED EMISSION MEASUREMENT | 84 |
| 5.1.1 | LIMITS OF CONDUCTED EMISSION MEASUREMENT | 84 |
| 5.1.2 | TEST INSTRUMENTS | 84 |
| 5.1.3 | TEST PROCEDURES | 85 |
| 5.1.4 | DEVIATION FROM TEST STANDARD | 85 |
| 5.1.5 | TEST SETUP | 86 |
| 5.1.6 | EUT OPERATING CONDITIONS | 86 |
| 5.1.7 | TEST RESULTS | 87 |
| 5.2 | RADIATED EMISSION MEASUREMENT | 91 |
| 5.2.1 | LIMITS OF RADIATED EMISSION MEASUREMENT | 91 |
| 5.2.2 | TEST INSTRUMENTS | 92 |
| 5.2.3 | TEST PROCEDURES | 94 |
| 5.2.4 | DEVIATION FROM TEST STANDARD | 94 |
| 5.2.5 | TEST SETUP | 95 |
| 5.2.6 | EUT OPERATING CONDITIONS | 96 |
| 5.2.7 | TEST RESULTS | 97 |
| 5.3 | 6dB BANDWIDTH MEASUREMENT | 106 |



A D T

| | | |
|-------|---|-----|
| 5.3.1 | LIMITS OF 6dB BANDWIDTH MEASUREMENT | 106 |
| 5.3.2 | TEST INSTRUMENTS | 106 |
| 5.3.3 | TEST PROCEDURE | 106 |
| 5.3.4 | DEVIATION FROM TEST STANDARD | 106 |
| 5.3.5 | TEST SETUP | 106 |
| 5.3.6 | EUT OPERATING CONDITIONS | 106 |
| 5.3.7 | TEST RESULTS | 107 |
| 5.4 | MAXIMUM PEAK OUTPUT POWER | 110 |
| 5.4.1 | LIMITS OF MAXIMUM PEAK OUTPUT POWER MEASUREMENT | 110 |
| 5.4.2 | INSTRUMENTS | 110 |
| 5.4.3 | TEST PROCEDURES | 110 |
| 5.4.4 | DEVIATION FROM TEST STANDARD | 110 |
| 5.4.5 | TEST SETUP | 110 |
| 5.4.6 | EUT OPERATING CONDITIONS | 110 |
| 5.4.7 | TEST RESULTS | 111 |
| 5.5 | POWER SPECTRAL DENSITY MEASUREMENT | 112 |
| 5.5.1 | LIMITS OF POWER SPECTRAL DENSITY MEASUREMENT | 112 |
| 5.5.2 | TEST INSTRUMENTS | 112 |
| 5.5.3 | TEST PROCEDURE | 112 |
| 5.5.4 | DEVIATION FROM TEST STANDARD | 112 |
| 5.5.5 | TEST SETUP | 112 |
| 5.5.6 | EUT OPERATING CONDITION | 112 |
| 5.5.7 | TEST RESULTS | 113 |
| 5.6 | CONDUCTED OUT-BAND EMISSION MEASUREMENT | 116 |
| 5.6.1 | LIMITS OF CONDUCTED OUT-BAND EMISSION MEASUREMENT | 116 |
| 5.6.2 | TEST INSTRUMENTS | 116 |
| 5.6.3 | TEST PROCEDURE | 116 |
| 5.6.4 | DEVIATION FROM TEST STANDARD | 116 |
| 5.6.5 | EUT OPERATING CONDITION | 116 |
| 5.6.6 | TEST RESULTS | 116 |
| 6. | INFORMATION ON THE TESTING LABORATORIES | 123 |
| 7. | APPENDIX A - MODIFICATIONS RECORDERS FOR ENGINEERING CHANGES TO THE EUT BY THE LAB | 124 |



1. CERTIFICATION

PRODUCT: Cable Modem
BRAND NAME: THOMSON
MODEL NO.: DWG875T,
DWG875XX (The "X" of Model Name could be A~Z)
TEST SAMPLE: ENGINEERING SAMPLE
TESTED: June 15 to July 14, 2010
APPLICANT: ASKEY COMPUTER CORP.
STANDARDS: FCC Part 15, Subpart C (Section 15.247)
ANSI C63.4-2003

The above equipment (Model: DWG875T) has been tested by **Bureau Veritas Consumer Products Services (H.K.) Ltd., Taoyuan Branch**, and found compliance with the requirement of the above standards. The test record, data evaluation & Equipment Under Test (EUT) configurations represented herein are true and accurate accounts of the measurements of the sample's EMC characteristics under the conditions specified in this report.

PREPARED BY : Carol Liao , **DATE:** July 23, 2010
(Carol Liao, Specialist)

TECHNICAL ACCEPTANCE : Hank Chung , **DATE:** July 23, 2010
(Hank Chung, Deputy Manager)

APPROVED BY : May Chen , **DATE:** July 23, 2010
(May Chen, Deputy Manager)

2. SUMMARY OF TEST RESULTS

The EUT has been tested according to the following specifications:

For 802.11b & g, 2400~2483.5MHz Band

| APPLIED STANDARD: FCC Part 15, Subpart C (Section 15.247) | | | |
|--|--|---------------|--|
| Standard Section | Test Type and Limit | Result | Remark |
| 15.207 | AC Power Conducted Emission | PASS | Meet the requirement of limit. Minimum passing margin is -9.84dB at 2.973MHz |
| 15.247(a)(2) | Spectrum Bandwidth of a Direct Sequence Spread Spectrum System Limit: min. 500kHz | PASS | Meet the requirement of limit. |
| 15.247(b) | Maximum Peak Output Power Limit: max. 30dBm | PASS | Meet the requirement of limit. |
| 15.247(d) | Radiated Emissions Limit: Table 15.209 | PASS | Meet the requirement of limit. Minimum passing margin is -0.7dB at 2483.5.00MHz |
| 15.247(e) | Power Spectral Density Limit: max. 8dBm | PASS | Meet the requirement of limit. |
| 15.247(d) | Conducted Out-Band Emission Measurement Limit: 20dB less than the peak value of fundamental frequency | PASS | Meet the requirement of limit. |
| 15.203 | Antenna Requirement | PASS | Antenna connector is I-PEX not a standard connector. |



A D T

For 802.11a, 5725~5850MHz Band

| APPLIED STANDARD: FCC Part 15, Subpart C (Section 15.247) | | | |
|--|--|---------------|---|
| Standard Section | Test Type and Limit | Result | Remark |
| 15.207 | AC Power Conducted Emission | PASS | Meet the requirement of limit. Minimum passing margin is -9.93dB at 2.371MHz |
| 15.247(a)(2) | Spectrum Bandwidth of a Direct Sequence Spread Spectrum System Limit: min. 500kHz | PASS | Meet the requirement of limit. |
| 15.247(b) | Maximum Peak Output Power Limit: max. 30dBm | PASS | Meet the requirement of limit. |
| 15.247(d) | Radiated Emissions Limit: Table 15.209 | PASS | Meet the requirement of limit. Minimum passing margin is -6.7dB at 11650.00MHz |
| 15.247(e) | Power Spectral Density Limit: max. 8dBm | PASS | Meet the requirement of limit. |
| 15.247(d) | Conducted Out-Band Emission Measurement Limit: 20dB less than the peak value of fundamental frequency | PASS | Meet the requirement of limit. |
| 15.203 | Antenna Requirement | PASS | Antenna connector is I-PEX not a standard connector. |

NOTE:

1. The EUT was operating in 2400 ~ 2483.5MHz, 5.15~5.25GHz and 5.725~5.85GHz frequencies band. This report was recorded the RF parameters including 2400 ~ 2483.5MHz and 5.725~5.85GHz. For the 5.15~5.25GHz RF parameters was recorded in another test report.



A D T

2.1 MEASUREMENT UNCERTAINTY

Where relevant, the following measurement uncertainty levels have been estimated for tests performed on the EUT as specified in CISPR 16-4-2:

This uncertainty represents an expanded uncertainty expressed at approximately the 95% confidence level using a coverage factor of $k=2$.

| Measurement | Value |
|-----------------------------------|---------|
| Conducted emissions | 2.45 dB |
| Radiated emissions (30MHz-1GHz) | 3.70 dB |
| Radiated emissions (1GHz -18GHz) | 2.19 dB |
| Radiated emissions (18GHz -40GHz) | 2.55 dB |



A D T

3. GENERAL INFORMATION

3.1 GENERAL DESCRIPTION OF EUT

| | |
|------------------------------|--|
| PRODUCT | Cable Modem |
| MODEL NO. | DWG875T, DWG875XX (The "X" of Model Name could be A~Z) |
| FCC ID | H8NPKE938 |
| POWER SUPPLY | Internal power supply or Battery |
| MODULATION TYPE | CCK, DQPSK, DBPSK for DSSS 64QAM, 16QAM, QPSK, BPSK for OFDM |
| MODULATION TECHNOLOGY | DSSS, OFDM |
| TRANSFER RATE | 802.11a/g: 54/48/36/24/18/12/9/6Mbps 802.11b:11/5.5/2/1Mbps HT20 MCS0~7 (800ns GI): 6.5Mbps, 13Mbps, 19.5Mbps, 26Mbps, 39Mbps, 52Mbps, 58.5Mbps, 65Mbps, HT20 MCS8~15 (800ns GI): 13Mbps, 26Mbps, 39Mbps, 52Mbps, 78Mbps, 104Mbps, 117Mbps, 130Mbps. HT40 MCS0~7 (800ns GI): 13.5Mbps, 27Mbps, 40.5Mbps, 54Mbps, 81Mbps, 108Mbps, 121.5Mbps, 135Mbps. HT40 MCS8~15 (800ns GI): 27Mbps, 54Mbps, 81Mbps, 108Mbps, 162Mbps, 216Mbps, 243Mbps, 270Mbps. |
| OPERATING FREQUENCY | For 15.407 802.11a: 5.18 ~ 5.24GHz |
| | For 15.247 802.11b & 802.11g: 2412 ~ 2462MHz 802.11a: 5.745 ~ 5.825GHz |
| NUMBER OF CHANNEL | For 15.407 4 for 802.11a, 802.11n (20MHz) 2 for 802.11n (40MHz) |
| | For 15.247(2.4GHz) 11 for 802.11b, 802.11g, 802.11n (20MHz) 7 for 802.11n (40MHz) For 15.247(5GHz) 5 for 802.11a, 802.11n (20MHz) 2 for 802.11n (40MHz) |



A D T

| | |
|-----------------------------|--|
| MAXIMUM OUTPUT POWER | For 15.407 802.11a: 24.5mW 802.11n (20MHz): 23.1mW 802.11n (40MHz): 26.1mW For 15.247(2.4GHz) 802.11b: 218.8mW 802.11g: 346.7mW 802.11n (20MHz): 647.4mW 802.11n (40MHz): 382.4mW For 15.247(5GHz) 802.11a: 223.9mW 802.11n (20MHz): 458.2mW 802.11n (40MHz): 418.0mW |
| ANTENNA TYPE | Please see note 4 |
| ANTENNA CONNECTOR | Please see note 4 |
| DATA CABLE | LAN cable x 1 (Unshielded, 1.5m) AC input cable x 1 (Unshielded, 1.8m) |
| I/O PORTS | Phone(RJ11) port x 2 LAN(RJ45) port x 4 (10/100/1000Mbps) USB port x 1 Coaxial port x 1 |
| ASSOCIATED DEVICES | Battery x 1 |

NOTE:

1. The EUT has below brand name and model names which are identical to each other in all aspects except for the following :

| Brand | Model No. | Description |
|---------|-----------|---|
| THOMSON | DWG875T | For marketing requirement (The "X" of Model Name could be A~Z) |
| | DWG875XX | |

From the above models, model: **DWG875T** was selected as representative model for the test and its data was recorded in this report.

2. The EUT must be supplied with a battery or an internal power supply and following two different model numbers could be chosen:

| Battery | | |
|-------------------------|-------------------|---|
| Brand | Model No. | Spec. |
| GETAC TECHNOLOGY CORP | BP-PKE9-31/2600 S | 11V, 2.6Ah, 28.9Wh. Max charge voltage : 12.6V |
| Internal power supply 1 | | |
| Brand | Model No. | Spec. |
| AMIGO | AMS56-1502400F | Input: 100-240V, 50/60Hz, 1A Output: 15V, 2.4A |
| Internal power supply 2 | | |
| Brand | Model No. | Spec. |
| LEI | SU36-2150240-I3 | Input: 100-240V, 50/60Hz, 1.2A Output: 15V, 2.4A |

3. For radiated test, the EUT was pre-tested under following test modes :

| Pre-test Mode | Description |
|---------------|---------------------------------------|
| Mode A | Battery x 1 + Internal power supply 1 |
| Mode B | Battery x 1 + Internal power supply 2 |
| Mode C | Battery x 2 + Internal power supply 1 |

The worse radiated emission was found in **Mode C**. Therefore only the test data of the mode was recorded in this report.



A D T

4. There are two antennas provided to this EUT, please refer to the following table:

| No. | Antenna Type | Antenna Connector | Antenna Gain (dBi) | Cable loss(dB) | Net Gain (dBi) | Cable Length (mm) | Frequency range (GHz) |
|-----|--------------|-------------------|--------------------|----------------|----------------|-------------------|-----------------------|
| 1 | PIFA | I-PEX | 2.45 | 0.45 | 2 | 150 | 1~6 |
| 2 | PIFA | I-PEX | 2.56 | 0.56 | 2 | 200 | 1~6 |

5. The EUT incorporates a MIMO function with 802.11n. Physically, the EUT provides two completed transmitters and two completed receivers.
6. The EUT is 2 * 2 spatial MIMO (2Tx & 2Rx) without beam forming function. The antenna configurations are two transmitter antennas and two receiver antennas, as there are 2 PIFA antennas. Spatial multiplexing modes for simultaneous transmission using 2 antennas, and for simultaneous receiver using 2 antennas. The 11abg legacy mode is limited to single transmitter only.
7. The EUT complies with 802.11n standards and backwards compatible with 802. 11a, 802.11b, 802.11g products.
8. The above EUT information was declared by manufacturer and for more detailed features description, please refer to the manufacturer's specifications or user's manual.

3.2 DESCRIPTION OF TEST MODES

Operated in 2400 ~ 2483.5MHz band:

Eleven channels are provided for 802.11b, 802.11g, 802.11n (20MHz):

| CHANNEL | FREQUENCY | CHANNEL | FREQUENCY |
|---------|-----------|---------|-----------|
| 1 | 2412MHz | 7 | 2442MHz |
| 2 | 2417MHz | 8 | 2447MHz |
| 3 | 2422MHz | 9 | 2452MHz |
| 4 | 2427MHz | 10 | 2457MHz |
| 5 | 2432MHz | 11 | 2462MHz |
| 6 | 2437MHz | | |

Seven channels are provided for 802.11n (40MHz):

| CHANNEL | FREQUENCY | CHANNEL | FREQUENCY |
|---------|-----------|---------|-----------|
| 1 | 2422MHz | 5 | 2442MHz |
| 2 | 2427MHz | 6 | 2447MHz |
| 3 | 2432MHz | 7 | 2452MHz |
| 4 | 2437MHz | | |

Operated in 5725 ~ 5850MHz band:

Five channels are provided for 802.11a, 802.11n (20MHz):

| CHANNEL | FREQUENCY | CHANNEL | FREQUENCY |
|---------|-----------|---------|-----------|
| 149 | 5745 MHz | 161 | 5805 MHz |
| 153 | 5765 MHz | 165 | 5825 MHz |
| 157 | 5785 MHz | | |

Two channels are provided for 802.11n (40MHz):

| CHANNEL | FREQUENCY |
|---------|-----------|
| 151 | 5755 MHz |
| 159 | 5795 MHz |

3.2.1 TEST MODE APPLICABILITY AND TESTED CHANNEL DETAIL

| EUT CONFIGURE MODE | APPLICABLE TO | | | | DESCRIPTION |
|--------------------|---------------|---------|---------|------|------------------------------|
| | PLC | RE < 1G | RE ≥ 1G | APCM | |
| 1 | √ | √ | √ | √ | with Internal power supply 1 |
| 2 | √ | | | | with Internal power supply 2 |

Where **PLC**: Power Line Conducted Emission **RE < 1G**: Radiated Emission below 1GHz
RE ≥ 1G: Radiated Emission above 1GHz **APCM**: Antenna Port Conducted Measurement

ANTENNA COMBINATION MODE:

| COMBINATION MODE | OPERATION MODE | TX CHAIN(0) | TX CHAIN(1) |
|------------------|----------------------------|-------------|-------------|
| A | 802.11 a | √ | |
| B | 802.11 b | √ | |
| C | 802.11 g | √ | |
| D | 802.11n(20MHz) for MCS0~7 | √ | |
| E | 802.11n(20MHz) for MCS8~15 | √ | √ |
| F | 802.11n(40MHz) for MCS0~7 | √ | |
| G | 802.11n(40MHz) for MCS8~15 | √ | √ |

Note:

1. The above information was declared by manufacturer and for more detailed features description, please refer to the manufacturer's specifications or user's manual.
2. Mode A, B, C, E and G the worst modes, were selected as representative modes for the report.

POWER LINE CONDUCTED EMISSION TEST:

- Pre-Scan has been conducted to determine the worst-case mode from all possible combinations between available modulations, data rates and antenna ports (if EUT with antenna diversity architecture).
- Following channel(s) was (were) selected for the final test as listed below.

| MODE | AVAILABLE CHANNEL | TESTED CHANNEL | MODULATION TECHNOLOGY | MODULATION TYPE | DATA RATE (Mbps) | COMBINATION |
|--------------------------------|-------------------|----------------|-----------------------|-----------------|------------------|-------------|
| For 2.4 GHz 802.11n (20MHz) | 1 to 11 | 6 | OFDM | BPSK | 13 | E |
| For 5 GHz 802.11n (20MHz) | 149 to 165 | 157 | OFDM | BPSK | 13 | E |



A D T

RADIATED EMISSION TEST (BELOW 1 GHz):

- Pre-Scan has been conducted to determine the worst-case mode from all possible combinations between available modulations, data rates and antenna ports (if EUT with antenna diversity architecture).
- Following channel(s) was (were) selected for the final test as listed below.

| MODE | AVAILABLE CHANNEL | TESTED CHANNEL | MODULATION TECHNOLOGY | MODULATION TYPE | DATA RATE (Mbps) | COMBINATION |
|--------------------------------|-------------------|----------------|-----------------------|-----------------|------------------|-------------|
| For 2.4 GHz 802.11n (20MHz) | 1 to 11 | 6 | OFDM | BPSK | 13 | E |
| For 5 GHz 802.11n (20MHz) | 149 to 165 | 157 | OFDM | BPSK | 13 | E |

RADIATED EMISSION TEST (ABOVE 1 GHz):

- Pre-Scan has been conducted to determine the worst-case mode from all possible combinations between available modulations, data rates and antenna ports (if EUT with antenna diversity architecture).
- Following channel(s) was (were) selected for the final test as listed below.

| MODE | AVAILABLE CHANNEL | TESTED CHANNEL | MODULATION TECHNOLOGY | MODULATION TYPE | DATA RATE (Mbps) | COMBINATION |
|--------------------------------|-------------------|----------------|-----------------------|-----------------|------------------|-------------|
| 802.11b | 1 to 11 | 1, 6, 11 | DSSS | DBPSK | 1 | B |
| 802.11g | 1 to 11 | 1, 6, 11 | OFDM | BPSK | 6 | C |
| For 2.4 GHz 802.11n (20MHz) | 1 to 11 | 1, 6, 11 | OFDM | BPSK | 13 | E |
| For 2.4 GHz 802.11n (40MHz) | 1 to 7 | 1, 4, 7 | OFDM | BPSK | 27 | G |
| 802.11a | 149 to 165 | 149, 157, 165 | OFDM | BPSK | 6 | A |
| For 5 GHz 802.11n (20MHz) | 149 to 165 | 149, 157, 165 | OFDM | BPSK | 13 | E |
| For 5 GHz 802.11n (40MHz) | 151 to 159 | 151, 159 | OFDM | BPSK | 27 | G |

**CONDUCTED OUT-BAND EMISSION MEASUREMENT:**

- Pre-Scan has been conducted to determine the worst-case mode from all possible combinations between available modulations, data rates and antenna ports (if EUT with antenna diversity architecture).
- Following channel(s) was (were) selected for the final test as listed below.

| MODE | AVAILABLE CHANNEL | TESTED CHANNEL | MODULATION TECHNOLOGY | MODULATION TYPE | DATA RATE (Mbps) | COMBINATION |
|--------------------------------|-------------------|----------------|-----------------------|-----------------|------------------|-------------|
| 802.11b | 1 to 11 | 1, 11 | DSSS | DBPSK | 1 | B |
| 802.11g | 1 to 11 | 1, 11 | OFDM | BPSK | 6 | C |
| For 2.4 GHz 802.11n (20MHz) | 1 to 11 | 1, 11 | OFDM | BPSK | 13 | E |
| For 2.4 GHz 802.11n (40MHz) | 1 to 7 | 1, 7 | OFDM | BPSK | 27 | G |
| 802.11a | 149 to 165 | 149, 165 | OFDM | BPSK | 6 | A |
| For 5 GHz 802.11n (20MHz) | 149 to 165 | 149, 165 | OFDM | BPSK | 13 | E |
| For 5 GHz 802.11n (40MHz) | 151 to 159 | 151, 159 | OFDM | BPSK | 27 | G |

- ※ After verification, conducted out band emission as show worst chain in report by investigations.

ANTENNA PORT CONDUCTED MEASUREMENT:

- This item includes all test value of each mode, but only includes spectrum plot of worst value of each mode.
- Pre-Scan has been conducted to determine the worst-case mode from all possible combinations between available modulations, data rates and antenna ports (if EUT with antenna diversity architecture).
- Following channel(s) was (were) selected for the final test as listed below.

| MODE | AVAILABLE CHANNEL | TESTED CHANNEL | MODULATION TECHNOLOGY | MODULATION TYPE | DATA RATE (Mbps) | COMBINATION |
|--------------------------------|-------------------|----------------|-----------------------|-----------------|------------------|-------------|
| 802.11b | 1 to 11 | 1, 6, 11 | DSSS | DBPSK | 1 | B |
| 802.11g | 1 to 11 | 1, 6, 11 | OFDM | BPSK | 6 | C |
| For 2.4 GHz 802.11n (20MHz) | 1 to 11 | 1, 6, 11 | OFDM | BPSK | 13 | E |
| For 2.4 GHz 802.11n (40MHz) | 1 to 7 | 1, 4, 7 | OFDM | BPSK | 27 | G |
| 802.11a | 149 to 165 | 149, 157, 165 | OFDM | BPSK | 6 | A |
| For 5 GHz 802.11n (20MHz) | 149 to 165 | 149, 157, 165 | OFDM | BPSK | 13 | E |
| For 5 GHz 802.11n (40MHz) | 151 to 159 | 151, 159 | OFDM | BPSK | 27 | G |

- ※ After verification, bandwidth as show worst chain in report by investigations.



A D T

※ **TEST CONDITION:**

| APPLICABLE TO | ENVIRONMENTAL CONDITIONS | INPUT POWER | TESTED BY |
|--------------------|---------------------------|--------------|------------|
| RE ³ 1G | 26deg. C, 70%RH, 1014 hPa | 120Vac, 60Hz | Eric Lee |
| RE<1G | 26deg. C, 81%RH, 1014 hPa | 120Vac, 60Hz | Eagle Chen |
| PLC | 26deg. C, 60%RH, 1014 hPa | 120Vac, 60Hz | Timmy Hu |
| APCM | 27deg. C, 72%RH, 1014 hPa | 120Vac, 60Hz | Eric Lee |

3.3 GENERAL DESCRIPTION OF APPLIED STANDARDS

The EUT is a RF product. According to the specifications of the manufacturer, it must comply with the requirements of the following standards:

FCC Part 15, Subpart C. (15.247)

ANSI C63.4-2003

All test items have been performed and recorded as per the above standards.

NOTE: The EUT has been verified to comply with the requirements of FCC Part 15, Subpart B, Class B (DoC). The test report has been issued separately.



3.4 DESCRIPTION OF SUPPORT UNITS

The EUT has been tested as an independent unit together with other necessary accessories or support units. The following support units or accessories were used to form a representative test configuration during the tests.

| NO. | PRODUCT | BRAND | MODEL NO. | SERIAL NO. | FCC ID |
|-----|-------------------------------------|--------|---------------|---------------|---------|
| 1 | NOTEBOOK COMPUTER | DELL | PP32LA | FSLB32S | FCC DoC |
| 2 | NOTEBOOK COMPUTER | DELL | PP32LA | GSLB32S | FCC DoC |
| 3 | NOTEBOOK COMPUTER | Acer | TravelMate270 | NA | NA |
| 4 | TELEPHONE | WONDER | WD-303 | 6C17FA00515 | NA |
| 5 | TELEPHONE | WONDER | WD-303 | 6C17FA00774 | NA |
| 6 | Icra Cable Modem Termination System | ARRIS | CMT1000 | NA | NA |
| 7 | HUB | ZyXEL | ES-116P | S060H02000215 | FCC DoC |
| 8 | iPod nano 1GB | Apple | A1137 | 5K7170JBUPR | FCC DoC |

| NO. | SIGNAL CABLE DESCRIPTION OF THE ABOVE SUPPORT UNITS |
|-----|--|
| 1 | RJ-45 cable (10m) |
| 2 | RJ-45 cable (3m) |
| 3 | NA |
| 4 | RJ-11 cable (1m) |
| 5 | RJ-11 cable (1m) |
| 6 | Coaxial cable (10m) |
| 7 | RJ-45 cable (10m) |
| 8 | 1 m shielded cable, terminated with USB connector, w/o core. |

NOTE: 1. All power cords of the above support units are non shielded (1.8m).

3.5 CONFIGURATION OF SYSTEM UNDER TEST

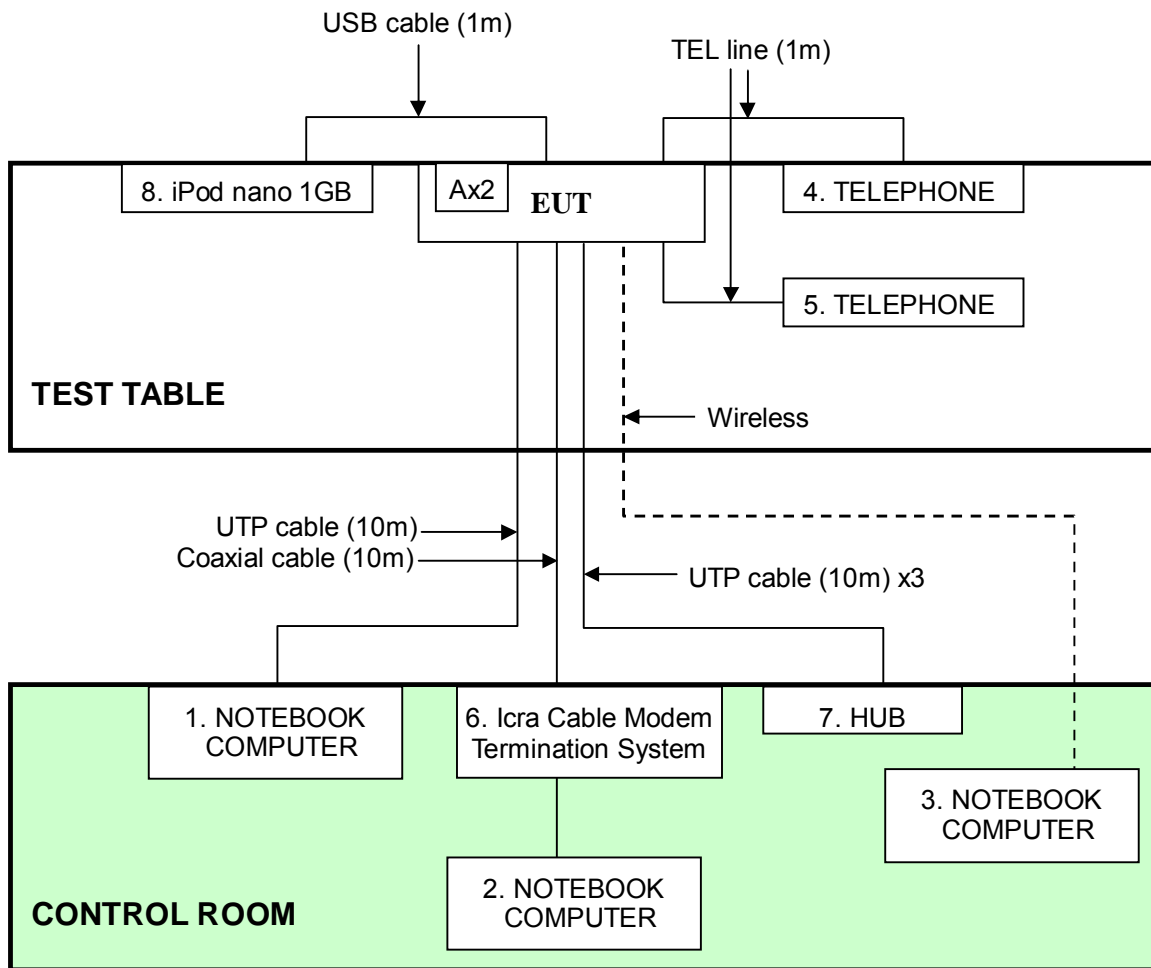

NOTE: 1. Item A is the battery.



A D T

4. TEST TYPES AND RESULTS (802.11b & g, 2400 ~ 2483.5MHz Band)

4.1 CONDUCTED EMISSION MEASUREMENT

4.1.1 LIMITS OF CONDUCTED EMISSION MEASUREMENT

| FREQUENCY OF EMISSION (MHz) | CONDUCTED LIMIT (dBµV) | |
|-----------------------------|------------------------|----------|
| | Quasi-peak | Average |
| 0.15-0.5 | 66 to 56 | 56 to 46 |
| 0.5-5 | 56 | 46 |
| 5-30 | 60 | 50 |

- NOTE:**
1. The lower limit shall apply at the transition frequencies.
 2. The limit decreases in line with the logarithm of the frequency in the range of 0.15 to 0.50 MHz.
 3. All emanations from a class A/B digital device or system, including any network of conductors and apparatus connected thereto, shall not exceed the level of field strengths specified above.

4.1.2 TEST INSTRUMENTS

| DESCRIPTION & MANUFACTURER | MODEL NO. | SERIAL NO. | CALIBRATED DATE | CALIBRATED UNTIL |
|---|---------------------|------------|-----------------|------------------|
| ROHDE & SCHWARZ Test Receiver | ESCS 30 | 100287 | Mar. 01, 2010 | Feb. 28, 2011 |
| Line-Impedance Stabilization Network (for EUT) | NSLK 8127 | 8127-523 | Sep. 23, 2009 | Sep. 22, 2010 |
| Line-Impedance Stabilization Network (for Peripheral) | ENV-216 | 100072 | June 11, 2010 | June 10, 2011 |
| RF Cable (JYEBAO) | 5DFB | COACAB-001 | Dec. 14, 2009 | Dec. 13, 2010 |
| 50 ohms Terminator | 50 | 3 | Oct. 28, 2009 | Oct. 27, 2010 |
| Software | BV ADT_ Cond_V7.3.7 | NA | NA | NA |

Note:

1. The calibration interval of the above test instruments is 12 months and the calibrations are traceable to NML/ROC and NIST/USA.
2. The test was performed in Shielded Room No. A.
3. The VCCI Con A Registration No. is C-817.

4.1.3 TEST PROCEDURES

- a. The EUT was placed 0.4 meters from the conducting wall of the shielded room with EUT being connected to the power mains through a line impedance stabilization network (LISN). Other support units were connected to the power mains through another LISN. The two LISNs provide 50 ohm/ 50uH of coupling impedance for the measuring instrument.
- b. Both lines of the power mains connected to the EUT were checked for maximum conducted interference.
- c. The frequency range from 150kHz to 30MHz was searched. Emission levels under (Limit - 20dB) were not recorded.

4.1.4 DEVIATION FROM TEST STANDARD

No deviation

4.1.5 TEST SETUP

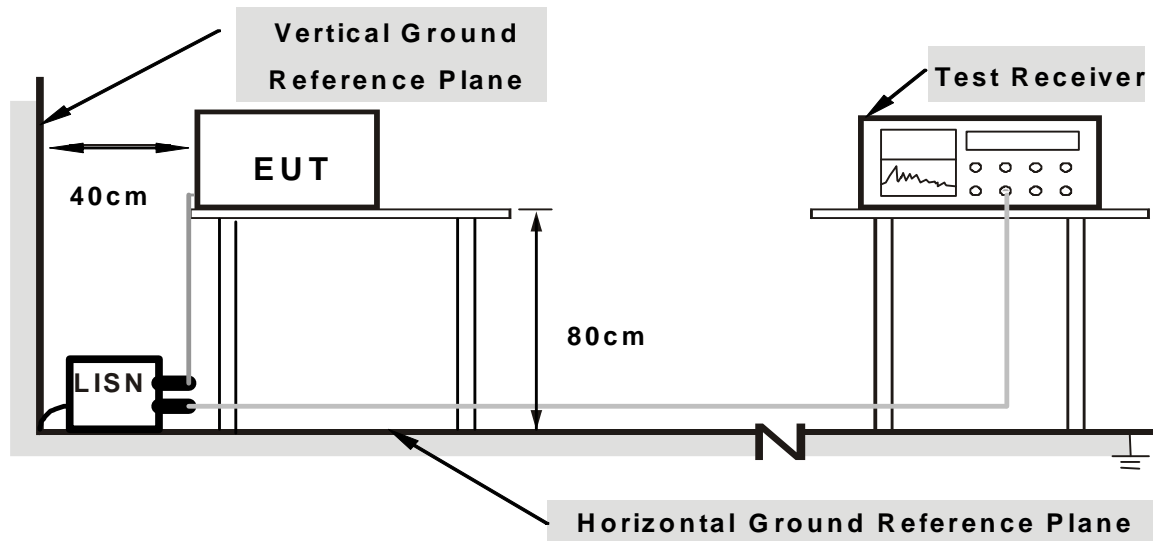

Note: 1. Support units were connected to second LISN.

2. Both of LISNs (AMN) are 80 cm from EUT and at least 80 from other units and other metal planes

For the actual test configuration, please refer to the related item – Photographs of the Test Configuration.

4.1.6 EUT OPERATING CONDITIONS

1. Placed the EUT on testing table.
2. Prepared other computer systems (support units 1 ~ 3) to act as communication partners and placed them outside of testing area.
3. The communication partners ran test program “Ping.exe” to enable EUT under transmission/receiving condition continuously via one UTP cable, one coaxial cable and wireless transmission.
4. The support units 4~5 (Telephone) called to each other via EUT.
5. Support unit 8 (iPod nano 1G) was connected to EUT via one USB cable to simulate real connection.

4.1.7 TEST RESULTS

802.11n (20MHz) OFDM MODULATION:

| | | | |
|------------------|------------------------------|----------------------|-------|
| PHASE | Line (L) | 6dB BANDWIDTH | 9 kHz |
| TEST MODE | With Internal power supply 1 | | |

| No | Freq. [MHz] | Corr. Factor (dB) | Reading Value [dB (uV)] | | Emission Level [dB (uV)] | | Limit [dB (uV)] | | Margin (dB) | |
|----|----------------|-------------------------|----------------------------|-----|-----------------------------|-----|--------------------|-------|----------------|-----|
| | | | Q.P. | AV. | Q.P. | AV. | Q.P. | AV. | Q.P. | AV. |
| | | | | | | | | | | |
| 1 | 0.150 | 0.03 | 46.85 | - | 46.88 | - | 66.00 | 56.00 | -19.12 | - |
| 2 | 0.205 | 0.04 | 46.06 | - | 46.10 | - | 63.42 | 53.42 | -17.32 | - |
| 3 | 0.826 | 0.16 | 42.83 | - | 42.99 | - | 56.00 | 46.00 | -13.01 | - |
| 4 | 2.535 | 0.22 | 45.37 | - | 45.59 | - | 56.00 | 46.00 | -10.41 | - |
| 5 | 2.895 | 0.21 | 45.71 | - | 45.92 | - | 56.00 | 46.00 | -10.08 | - |
| 6 | 12.574 | 0.52 | 41.82 | - | 42.34 | - | 60.00 | 50.00 | -17.66 | - |

- REMARKS:**
1. Q.P. and AV. are abbreviations of quasi-peak and average individually.
 2. "-": The Quasi-peak reading value also meets average limit and measurement with the average detector is unnecessary.
 3. The emission levels of other frequencies were very low against the limit.
 4. Margin value = Emission level - Limit value
 5. Correction factor = Insertion loss + Cable loss
 6. Emission Level = Correction Factor + Reading Value.

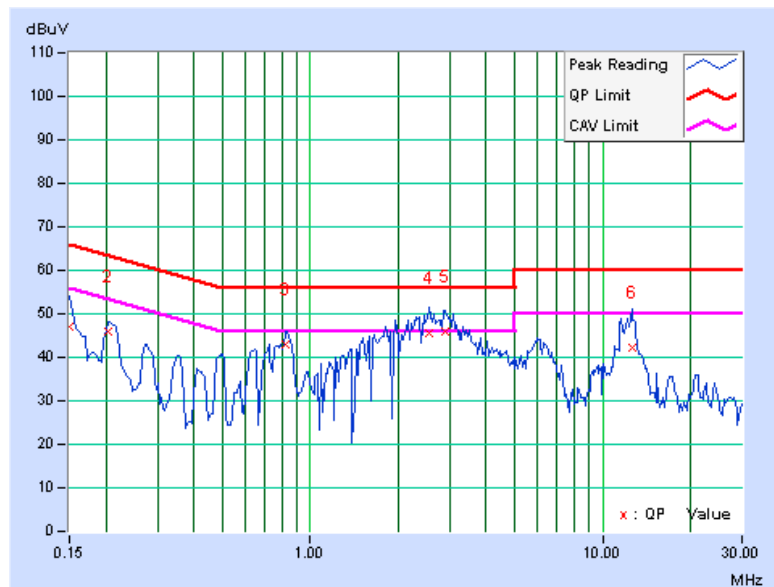

| | | | |
|------------------|------------------------------|----------------------|-------|
| PHASE | Neutral (N) | 6dB BANDWIDTH | 9 kHz |
| TEST MODE | With Internal power supply 1 | | |

| No | Freq. [MHz] | Corr. Factor (dB) | Reading Value | | Emission Level | | Limit | | Margin | |
|----------|----------------|-------------------------|---------------|--------------|----------------|--------------|--------------|--------------|--------------|---------------|
| | | | [dB (uV)] | | [dB (uV)] | | [dB (uV)] | | (dB) | |
| | | | Q.P. | AV. | Q.P. | AV. | Q.P. | AV. | Q.P. | AV. |
| 1 | 0.150 | 0.04 | 45.92 | - | 45.96 | - | 66.00 | 56.00 | -20.04 | - |
| 2 | 0.642 | 0.12 | 40.91 | - | 41.03 | - | 56.00 | 46.00 | -14.97 | - |
| 3 | 0.834 | 0.18 | 43.96 | - | 44.14 | - | 56.00 | 46.00 | -11.86 | - |
| 4 | 2.371 | 0.23 | 45.56 | - | 45.79 | - | 56.00 | 46.00 | -10.21 | - |
| 5 | 2.973 | 0.23 | 45.93 | 31.76 | 46.16 | 31.99 | 56.00 | 46.00 | -9.84 | -14.01 |
| 6 | 12.047 | 0.54 | 40.79 | - | 41.33 | - | 60.00 | 50.00 | -18.67 | - |

- REMARKS:**
1. Q.P. and AV. are abbreviations of quasi-peak and average individually.
 2. "-": The Quasi-peak reading value also meets average limit and measurement with the average detector is unnecessary.
 3. The emission levels of other frequencies were very low against the limit.
 4. Margin value = Emission level - Limit value
 5. Correction factor = Insertion loss + Cable loss
 6. Emission Level = Correction Factor + Reading Value.

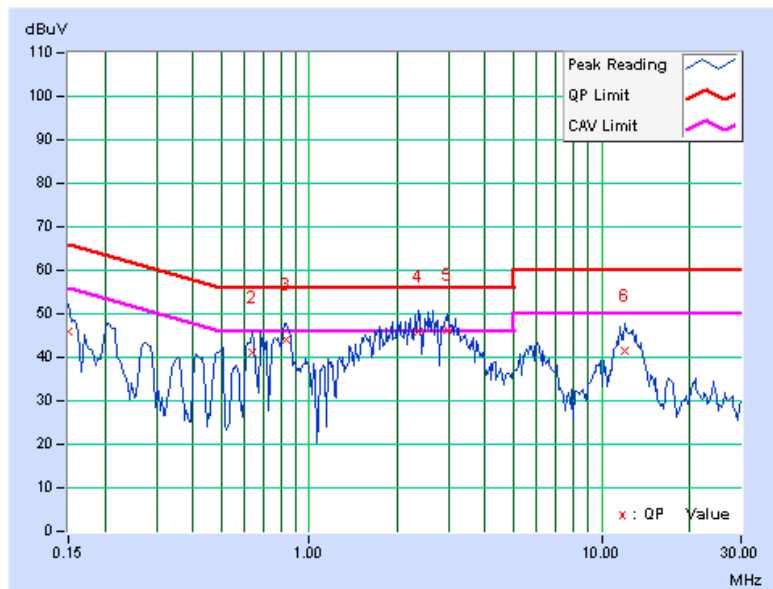

| | | | |
|------------------|------------------------------|----------------------|-------|
| PHASE | Line (L) | 6dB BANDWIDTH | 9 kHz |
| TEST MODE | With Internal power supply 2 | | |

| No | Freq. [MHz] | Corr. Factor (dB) | Reading Value | | Emission Level | | Limit | | Margin | |
|----|----------------|-------------------------|---------------|-----|----------------|-----|-----------|-------|--------|-----|
| | | | [dB (uV)] | | [dB (uV)] | | [dB (uV)] | | (dB) | |
| | | | Q.P. | AV. | Q.P. | AV. | Q.P. | AV. | Q.P. | AV. |
| 1 | 0.177 | 0.04 | 52.18 | - | 52.22 | - | 64.61 | 54.61 | -12.39 | - |
| 2 | 0.240 | 0.04 | 45.47 | - | 45.51 | - | 62.10 | 52.10 | -16.59 | - |
| 3 | 0.869 | 0.18 | 22.86 | - | 23.04 | - | 56.00 | 46.00 | -32.96 | - |
| 4 | 2.563 | 0.22 | 29.37 | - | 29.59 | - | 56.00 | 46.00 | -26.41 | - |
| 5 | 15.395 | 0.46 | 37.33 | - | 37.79 | - | 60.00 | 50.00 | -22.21 | - |
| 6 | 17.641 | 0.53 | 35.29 | - | 35.82 | - | 60.00 | 50.00 | -24.18 | - |
| 7 | 22.746 | 0.63 | 34.03 | - | 34.66 | - | 60.00 | 50.00 | -25.34 | - |

- REMARKS:**
1. Q.P. and AV. are abbreviations of quasi-peak and average individually.
 2. "-": The Quasi-peak reading value also meets average limit and measurement with the average detector is unnecessary.
 3. The emission levels of other frequencies were very low against the limit.
 4. Margin value = Emission level - Limit value
 5. Correction factor = Insertion loss + Cable loss
 6. Emission Level = Correction Factor + Reading Value.

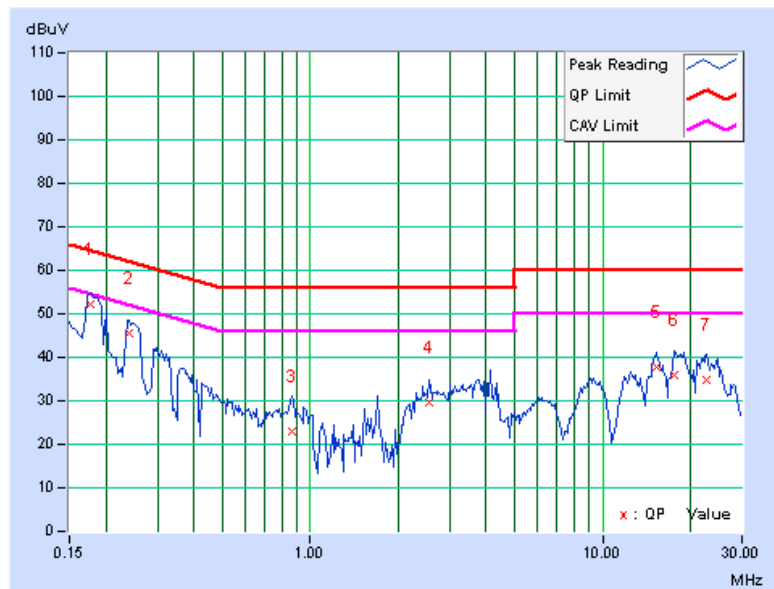

| | | | |
|------------------|------------------------------|----------------------|-------|
| PHASE | Neutral (N) | 6dB BANDWIDTH | 9 kHz |
| TEST MODE | With Internal power supply 2 | | |

| No | Freq. [MHz] | Corr. Factor (dB) | Reading Value [dB (uV)] | | Emission Level [dB (uV)] | | Limit [dB (uV)] | | Margin (dB) | |
|----|----------------|-------------------------|----------------------------|-------|-----------------------------|-------|--------------------|-------|----------------|-------|
| | | | Q.P. | AV. | Q.P. | AV. | Q.P. | AV. | Q.P. | AV. |
| | | | 1 | 0.177 | 0.05 | 53.19 | - | 53.24 | - | 64.61 |
| 2 | 0.236 | 0.05 | 46.55 | - | 46.60 | - | 62.24 | 52.24 | -15.64 | - |
| 3 | 3.926 | 0.21 | 31.54 | - | 31.75 | - | 56.00 | 46.00 | -24.25 | - |
| 4 | 15.355 | 0.47 | 39.54 | - | 40.01 | - | 60.00 | 50.00 | -19.99 | - |
| 5 | 18.203 | 0.56 | 37.00 | - | 37.56 | - | 60.00 | 50.00 | -22.44 | - |
| 6 | 21.836 | 0.64 | 35.02 | - | 35.66 | - | 60.00 | 50.00 | -24.34 | - |

- REMARKS:**
1. Q.P. and AV. are abbreviations of quasi-peak and average individually.
 2. "-": The Quasi-peak reading value also meets average limit and measurement with the average detector is unnecessary.
 3. The emission levels of other frequencies were very low against the limit.
 4. Margin value = Emission level - Limit value
 5. Correction factor = Insertion loss + Cable loss
 6. Emission Level = Correction Factor + Reading Value.

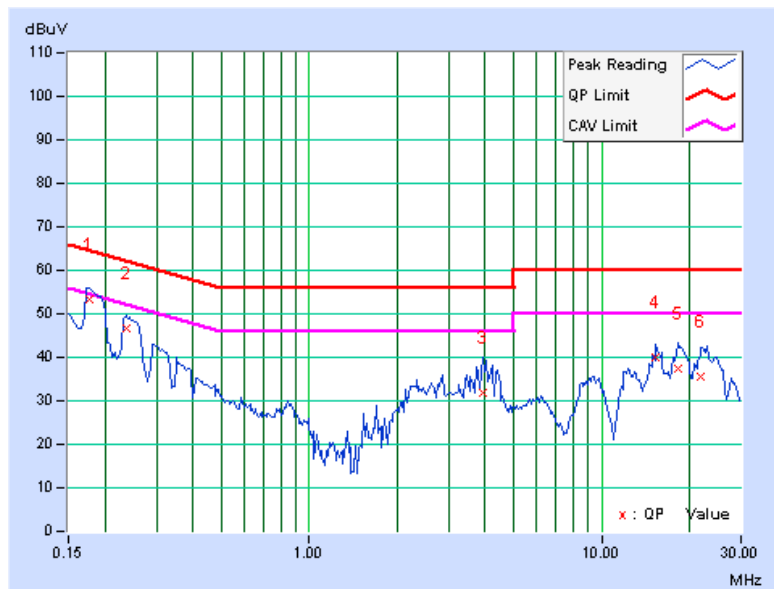

4.2 RADIATED EMISSION MEASUREMENT

4.2.1 LIMITS OF RADIATED EMISSION MEASUREMENT

Emissions radiated outside of the specified bands, shall be according to the general radiated limits in 15.209 as following:

| Frequencies (MHz) | Field strength (microvolts/meter) | Measurement distance (meters) |
|-------------------|-----------------------------------|-------------------------------|
| 0.009-0.490 | 2400/F(kHz) | 300 |
| 0.490-1.705 | 24000/F(kHz) | 30 |
| 1.705-30.0 | 30 | 30 |
| 30-88 | 100 | 3 |
| 88-216 | 150 | 3 |
| 216-960 | 200 | 3 |
| Above 960 | 500 | 3 |

NOTE:

1. The lower limit shall apply at the transition frequencies.
2. Emission level (dBuV/m) = 20 log Emission level (uV/m).
3. As shown in 15.35(b), for frequencies above 1000MHz, the field strength limits are based on average detector, however, the peak field strength of any emission shall not exceed the maximum permitted average limits, specified above by more than 20dB under any condition of modulation.



A D T

4.2.2 TEST INSTRUMENTS

Below 1GHz test

| DESCRIPTION & MANUFACTURER | MODEL NO. | SERIAL NO. | CALIBRATED DATE | CALIBRATED UNTIL |
|-------------------------------|--------------------------|---------------------------|-----------------|------------------|
| ADVANTEST Spectrum Analyzer | U3751 | 170100022 | Nov. 18, 2009 | Nov. 17, 2010 |
| PSA Seviés Spectrum Analyzer | E4446A | MY46180622 111 115 UK6 | May 12, 2010 | May 11, 2011 |
| HP Pre_Amplifier | 8449B | 3008A01922 | Sep. 25, 2009 | Sep. 24, 2010 |
| ROHDE & SCHWARZ Test Receiver | ESCS 30 | 100375 | Mar. 09, 2010 | Mar. 08, 2011 |
| SCHWARZBECK Broadband Antenna | VULB-9168 | 263 | Apr. 28, 2010 | Apr. 27, 2011 |
| Schwarzbeck Horn_Antenna | BBHA9120 | D123 | Sep. 21, 2009 | Sep. 20, 2010 |
| Schwarzbeck Horn_Antenna | BBHA 9170 | BBHA9170153 | Jan. 23, 2010 | Jan. 22, 2011 |
| RF Switches | EM-H-01-1 | 1009 | Aug. 10, 2009 | Aug. 08, 2010 |
| RF Cable | 8DFB | STACAB-30M-1GHz-091 | Nov. 20, 2009 | Nov. 19, 2010 |
| Software | ADT_Radiated_V7.6.15.9.2 | NA | NA | NA |
| CT Antenna Tower & Turn Table | TT100 | ADT01 | NA | NA |
| CORCOM AC Filter | MRI2030 | 107/108 | NA | NA |

- Note: 1. The calibration interval of the above test instruments is 12 months and the calibrations are traceable to NML/ROC and NIST/USA.
2. The horn antenna, preamplifier (model: 8449B) and Spectrum Analyzer (model: E4446A) are used only for the measurement of emission frequency above 1GHz if tested.
3. The test was performed in Open Site No. A.
4. The VCCI Site Registration No. is R-782.
5. The FCC Site Registration No. is 91097.
6. The CANADA Site Registration No. is IC 7450G-1.



A D T

Above 1GHz test

| DESCRIPTION & MANUFACTURER | MODEL NO. | SERIAL NO. | CALIBRATED DATE | CALIBRATED UNTIL |
|--------------------------------------|-----------------------------|-------------------------------------|-----------------|------------------|
| Agilent Spectrum Analyzer | E4446A | MY48250254 | Aug. 03, 2009 | Aug. 02, 2010 |
| Agilent Pre-Selector | N9039A | MY46520310 | Aug. 18, 2009 | Aug. 17, 2010 |
| Agilent Signal Generator | N5181A | MY49060347 | July 18, 2009 | July 17, 2010 |
| LIG NEX1 Test Receiver | ER-265 | L09068005 | Aug. 31, 2009 | Aug. 30, 2010 |
| Mini-Circuits Pre-Amplifier | ZFL-1000VH2B | AMP-ZFL-04 | Nov. 18, 2009 | Nov. 17, 2010 |
| Agilent Pre-Amplifier | 8449B | 3008A02465 | Mar. 01, 2010 | Feb. 28, 2011 |
| Miteq Pre-Amplifier | AFS33-1800265 0-30-8P-44 | 881786 | NA | NA |
| SCHWARZBECK Trilog Broadband Antenna | VULB 9168 | 9168-361 | Sep. 30, 2009 | Sep. 29, 2010 |
| AISI Horn_Antenna | AIH.8018 | 0000220091110 | Nov. 16, 2009 | Nov. 15, 2010 |
| SCHWARZBECK Horn_Antenna | BBHA 9170 | 9170-424 | Sep. 30, 2009 | Sep. 29, 2010 |
| RF CABLE | NA | RF104-205 RF104-207 RF104-208 | Dec. 24, 2009 | Dec. 23, 2010 |
| RF Cable | NA | CHHCAB_001 | NA | NA |
| Software | ADT_Radiated_V8.7.05 | NA | NA | NA |
| CT Antenna Tower & Turn Table | NA | NA | NA | NA |

- Note: 1. The calibration interval of the above test instruments is 12 months and the calibrations are traceable to NML/ROC and NIST/USA.
2. The horn antenna, preamplifier (model: 8449B) are used only for the measurement of emission frequency above 1GHz if tested.
3. The test was performed in 966 Chamber No. H.
4. The FCC Site Registration No. is 797305.
5. The CANADA Site Registration No. is IC 7450H-3.

4.2.3 TEST PROCEDURES

- a. The EUT was placed on the top of a rotating table 0.8 meters above the ground at a 10 meters open field site for below 1GHz test and 3 meters chamber room for above 1GHz test. The table was rotated 360 degrees to determine the position of the highest radiation.
- b. The EUT was set 3 meters away from the interference-receiving antenna, which was mounted on the top of a variable-height antenna tower.
- c. The antenna is a broadband antenna, and its height is varied from one meter to four meters above the ground to determine the maximum value of the field strength. Both horizontal and vertical polarizations of the antenna are set to make the measurement.
- d. For each suspected emission, the EUT was arranged to its worst case and then the antenna was tuned to heights from 1 meter to 4 meters and the rotatable table was turned from 0 degrees to 360 degrees to find the maximum reading.
- e. The test-receiver system was set to quasi-peak detect function and specified bandwidth with maximum hold mode when the test frequency is below 1 GHz.
- f. The test-receiver system was set to peak and average detect function and specified bandwidth with maximum hold mode when the test frequency is above 1 GHz. If the peak reading value also meets average limit, measurement with the average detector is unnecessary.

NOTE:

1. The resolution bandwidth and video bandwidth of test receiver/spectrum analyzer is 120kHz for Quasi-peak detection (QP) at frequency below 1GHz.
2. The resolution bandwidth is 1MHz and video bandwidth of test receiver/spectrum analyzer is 3MHz for Peak detection at frequency above 1GHz.
3. The resolution bandwidth of test receiver/spectrum analyzer is 1 MHz for Average detection (AV) at frequency above 1GHz.

4.2.4 DEVIATION FROM TEST STANDARD

No deviation

4.2.5 TEST SETUP

<Frequency Range below 1GHz>

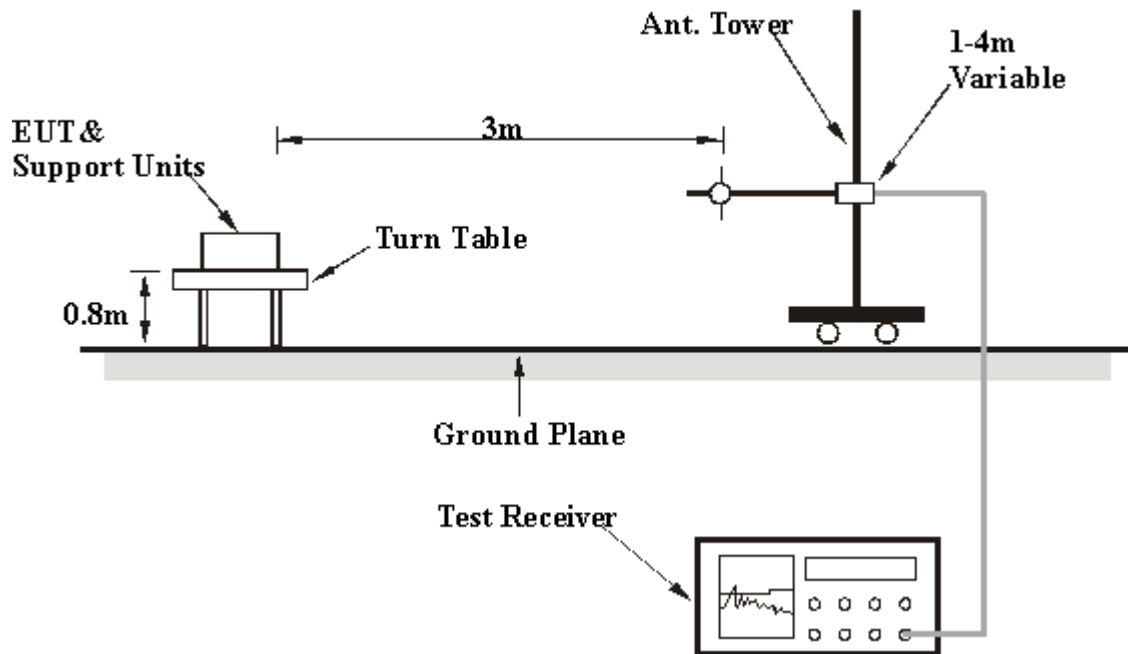

<Frequency Range above 1GHz>

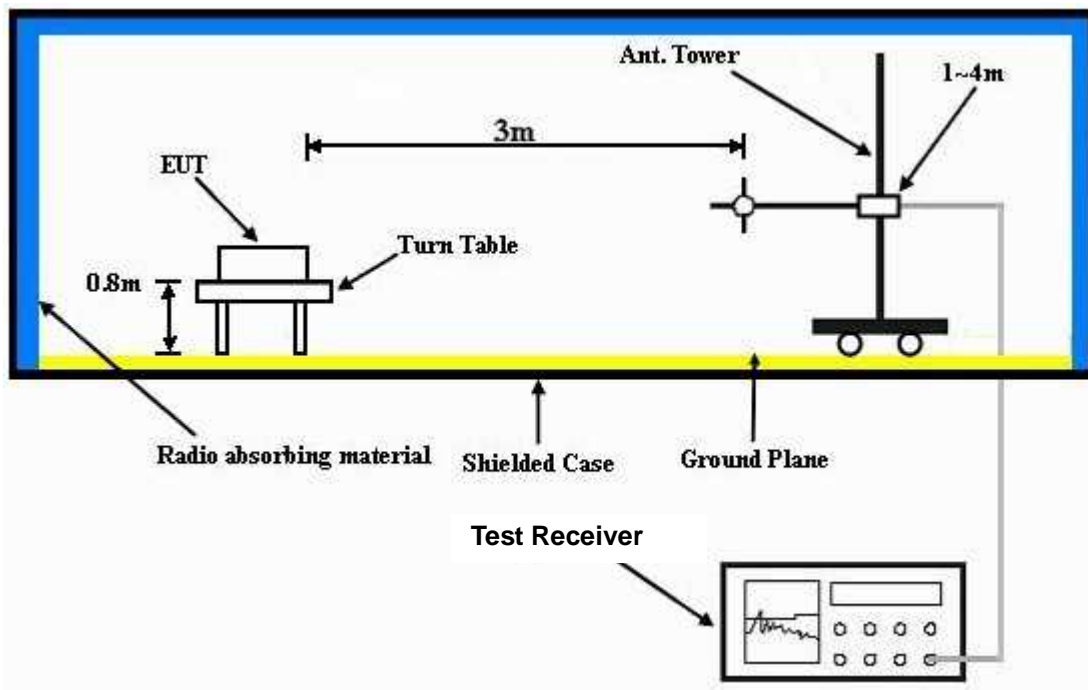

For the actual test configuration, please refer to the related item – Photographs of the Test Configuration.

4.2.6 EUT OPERATING CONDITIONS

1. Placed the EUT on testing table.
2. Prepared other computer systems (support units 1 ~ 2) to act as communication partners and placed them outside of testing area.
3. The communication partners ran test program “Console Broadcom command” to enable EUT under transmission/receiving condition continuously at specific channel frequency via one UTP cable and one coaxial cable.
4. The support units 4~5 (Telephone) called to each other via EUT.
5. Support unit 8 (iPod nano 1G) was connected to EUT via one USB cable to simulate real connection.



A D T

4.2.7 TEST RESULTS

BELOW 1GHz WORST-CASE DATA : 802.11n (20MHz) OFDM MODULATION

| EUT TEST CONDITION | | MEASUREMENT DETAIL | |
|--------------------------|-----------------------------|--------------------|---------------|
| CHANNEL | Channel 1 | FREQUENCY RANGE | Below 1000MHz |
| INPUT POWER (SYSTEM) | 120Vac, 60 Hz | DETECTOR FUNCTION | Quasi-Peak |
| ENVIRONMENTAL CONDITIONS | 26deg. C, 81%RH 1014 hPa | TESTED BY | Eagle Chen |

| ANTENNA POLARITY & TEST DISTANCE: HORIZONTAL AT 3 M | | | | | | | | |
|---|-------------|-------------------------|----------------|-------------|--------------------|----------------------|------------------|--------------------------|
| NO. | FREQ. (MHz) | EMISSION LEVEL (dBuV/m) | LIMIT (dBuV/m) | MARGIN (dB) | ANTENNA HEIGHT (m) | TABLE ANGLE (Degree) | RAW VALUE (dBuV) | CORRECTION FACTOR (dB/m) |
| 1 | 125.00 | 29.1 QP | 43.5 | -14.4 | 2.89 H | 352 | 15.53 | 13.58 |
| 2 | 220.00 | 30.8 QP | 46.0 | -15.2 | 2.97 H | 39 | 17.90 | 12.90 |
| 3 | 250.00 | 29.8 QP | 46.0 | -16.2 | 2.58 H | 359 | 16.12 | 13.65 |
| 4 | 396.61 | 29.8 QP | 46.0 | -16.3 | 2.53 H | 177 | 11.00 | 18.75 |
| 5 | 500.01 | 30.0 QP | 46.0 | -16.0 | 1.82 H | 30 | 8.58 | 21.45 |
| 6 | 875.02 | 31.2 QP | 46.0 | -14.8 | 1.00 H | 316 | 3.23 | 28.01 |
| 7 | 1000.00 | 42.8 QP | 54.0 | -11.2 | 1.00 H | 321 | 13.30 | 29.52 |
| ANTENNA POLARITY & TEST DISTANCE: VERTICAL AT 3 M | | | | | | | | |
| NO. | FREQ. (MHz) | EMISSION LEVEL (dBuV/m) | LIMIT (dBuV/m) | MARGIN (dB) | ANTENNA HEIGHT (m) | TABLE ANGLE (Degree) | RAW VALUE (dBuV) | CORRECTION FACTOR (dB/m) |
| 1 | 125.00 | 34.7 QP | 43.5 | -8.8 | 1.00 V | 29 | 21.10 | 13.58 |
| 2 | 220.00 | 31.5 QP | 46.0 | -14.5 | 1.00 V | 28 | 18.56 | 12.90 |
| 3 | 250.01 | 34.3 QP | 46.0 | -11.7 | 1.00 V | 355 | 20.61 | 13.65 |
| 4 | 375.01 | 33.7 QP | 46.0 | -12.3 | 1.00 V | 93 | 15.70 | 18.04 |
| 5 | 500.01 | 35.3 QP | 46.0 | -10.7 | 1.00 V | 32 | 13.82 | 21.45 |
| 6 | 875.00 | 34.5 QP | 46.0 | -11.5 | 2.55 V | 31 | 6.48 | 28.01 |
| 7 | 1000.00 | 38.2 QP | 54.0 | -15.8 | 2.20 V | 358 | 8.71 | 29.52 |

- REMARKS:**
1. Emission level (dBuV/m) = Raw Value (dBuV) + Correction Factor (dB/m).
 2. Correction Factor (dB/m) = Antenna Factor (dB/m) + Cable Factor (dB).
 3. The other emission levels were very low against the limit.
 4. Margin value = Emission level – Limit value.



A D T

ABOVE 1GHz WORST-CASE DATA

802.11b DSSS MODULATION

| EUT TEST CONDITION | | MEASUREMENT DETAIL | |
|--------------------------|-----------------------------|--------------------|---------------------------|
| CHANNEL | Channel 1 | FREQUENCY RANGE | 1 ~ 25GHz |
| INPUT POWER (SYSTEM) | 120Vac, 60 Hz | DETECTOR FUNCTION | Peak (PK) Average (AV) |
| ENVIRONMENTAL CONDITIONS | 26deg. C, 70%RH 1014 hPa | TESTED BY | Eric Lee |

ANTENNA POLARITY & TEST DISTANCE: HORIZONTAL AT 3 M

| NO. | FREQ. (MHz) | EMISSION LEVEL (dBuV/m) | LIMIT (dBuV/m) | MARGIN (dB) | ANTENNA HEIGHT (m) | TABLE ANGLE (Degree) | RAW VALUE (dBuV) | CORRECTION FACTOR (dB/m) |
|-----|-------------|-------------------------|----------------|-------------|--------------------|----------------------|------------------|--------------------------|
| 1 | 2387.30 | 61.5 PK | 74.0 | -12.5 | 1.16 H | 198 | 30.29 | 31.21 |
| 2 | 2387.30 | 52.7 AV | 54.0 | -1.3 | 1.16 H | 198 | 21.49 | 31.21 |
| 3 | *2412.00 | 110.8 PK | | | 1.15 H | 198 | 79.53 | 31.27 |
| 4 | *2412.00 | 108.1 AV | | | 1.15 H | 198 | 76.83 | 31.27 |
| 5 | 4824.00 | 54.4 PK | 74.0 | -19.6 | 1.09 H | 288 | 14.98 | 39.42 |
| 6 | 4824.00 | 49.9 AV | 54.0 | -4.1 | 1.09 H | 288 | 10.48 | 39.42 |

ANTENNA POLARITY & TEST DISTANCE: VERTICAL AT 3 M

| NO. | FREQ. (MHz) | EMISSION LEVEL (dBuV/m) | LIMIT (dBuV/m) | MARGIN (dB) | ANTENNA HEIGHT (m) | TABLE ANGLE (Degree) | RAW VALUE (dBuV) | CORRECTION FACTOR (dB/m) |
|-----|-------------|-------------------------|----------------|-------------|--------------------|----------------------|------------------|--------------------------|
| 1 | 2387.30 | 56.9 PK | 74.0 | -17.1 | 1.11 V | 109 | 25.69 | 31.21 |
| 2 | 2387.30 | 46.7 AV | 54.0 | -7.3 | 1.11 V | 109 | 15.49 | 31.21 |
| 3 | *2412.00 | 104.3 PK | | | 1.12 V | 104 | 73.03 | 31.27 |
| 4 | *2412.00 | 101.2 AV | | | 1.12 V | 104 | 69.93 | 31.27 |
| 5 | 4824.00 | 53.5 PK | 74.0 | -20.5 | 1.23 V | 293 | 14.08 | 39.42 |
| 6 | 4824.00 | 49.7 AV | 54.0 | -4.3 | 1.23 V | 293 | 10.28 | 39.42 |

- REMARKS:**
1. Emission level (dBuV/m) = Raw Value (dBuV) + Correction Factor (dB/m).
 2. Correction Factor (dB/m) = Antenna Factor (dB/m) + Cable Factor (dB).
 3. The other emission levels were very low against the limit.
 4. Margin value = Emission level – Limit value.
 5. “ * “: Fundamental frequency.



A D T

| EUT TEST CONDITION | | MEASUREMENT DETAIL | |
|--------------------------|-----------------------------|--------------------|---------------------------|
| CHANNEL | Channel 6 | FREQUENCY RANGE | 1 ~ 25GHz |
| INPUT POWER (SYSTEM) | 120Vac, 60 Hz | DETECTOR FUNCTION | Peak (PK) Average (AV) |
| ENVIRONMENTAL CONDITIONS | 26deg. C, 70%RH 1014 hPa | TESTED BY | Eric Lee |

| ANTENNA POLARITY & TEST DISTANCE: HORIZONTAL AT 3 M | | | | | | | | |
|---|-------------|-------------------------|----------------|-------------|--------------------|----------------------|------------------|--------------------------|
| NO. | FREQ. (MHz) | EMISSION LEVEL (dBuV/m) | LIMIT (dBuV/m) | MARGIN (dB) | ANTENNA HEIGHT (m) | TABLE ANGLE (Degree) | RAW VALUE (dBuV) | CORRECTION FACTOR (dB/m) |
| 1 | *2437.00 | 110.9 PK | | | 1.13 H | 201 | 79.56 | 31.34 |
| 2 | *2437.00 | 108.5 AV | | | 1.13 H | 201 | 77.16 | 31.34 |
| 3 | 4874.00 | 55.1 PK | 74.0 | -18.9 | 1.01 H | 191 | 15.48 | 39.62 |
| 4 | 4874.00 | 49.8 AV | 54.0 | -4.2 | 1.01 H | 191 | 10.18 | 39.62 |
| 5 | 7311.00 | 53.4 PK | 74.0 | -20.6 | 1.50 H | 135 | 9.30 | 44.10 |
| 6 | 7311.00 | 39.8 AV | 54.0 | -14.2 | 1.50 H | 135 | -4.30 | 44.10 |
| ANTENNA POLARITY & TEST DISTANCE: VERTICAL AT 3 M | | | | | | | | |
| NO. | FREQ. (MHz) | EMISSION LEVEL (dBuV/m) | LIMIT (dBuV/m) | MARGIN (dB) | ANTENNA HEIGHT (m) | TABLE ANGLE (Degree) | RAW VALUE (dBuV) | CORRECTION FACTOR (dB/m) |
| 1 | *2437.00 | 104.9 PK | | | 1.10 V | 111 | 73.56 | 31.34 |
| 2 | *2437.00 | 101.4 AV | | | 1.10 V | 111 | 70.06 | 31.34 |
| 3 | 4874.00 | 53.4 PK | 74.0 | -20.6 | 1.08 V | 320 | 13.78 | 39.62 |
| 4 | 4874.00 | 48.8 AV | 54.0 | -5.2 | 1.08 V | 320 | 9.18 | 39.62 |
| 5 | 7311.00 | 52.1 PK | 74.0 | -21.9 | 1.10 V | 131 | 8.00 | 44.10 |
| 6 | 7311.00 | 39.3 AV | 54.0 | -14.7 | 1.10 V | 131 | -4.80 | 44.10 |

- REMARKS:**
1. Emission level (dBuV/m) = Raw Value (dBuV) + Correction Factor (dB/m).
 2. Correction Factor (dB/m) = Antenna Factor (dB/m) + Cable Factor (dB).
 3. The other emission levels were very low against the limit.
 4. Margin value = Emission level – Limit value.
 5. “ * “: Fundamental frequency.



A D T

| EUT TEST CONDITION | | MEASUREMENT DETAIL | |
|--------------------------|-----------------------------|--------------------|---------------------------|
| CHANNEL | Channel 11 | FREQUENCY RANGE | 1 ~ 25GHz |
| INPUT POWER (SYSTEM) | 120Vac, 60 Hz | DETECTOR FUNCTION | Peak (PK) Average (AV) |
| ENVIRONMENTAL CONDITIONS | 26deg. C, 70%RH 1014 hPa | TESTED BY | Eric Lee |

| ANTENNA POLARITY & TEST DISTANCE: HORIZONTAL AT 3 M | | | | | | | | |
|---|-------------|-------------------------|----------------|-------------|--------------------|----------------------|------------------|--------------------------|
| NO. | FREQ. (MHz) | EMISSION LEVEL (dBuV/m) | LIMIT (dBuV/m) | MARGIN (dB) | ANTENNA HEIGHT (m) | TABLE ANGLE (Degree) | RAW VALUE (dBuV) | CORRECTION FACTOR (dB/m) |
| 1 | *2462.00 | 108.9 PK | | | 1.13 H | 196 | 77.50 | 31.40 |
| 2 | *2462.00 | 106.2 AV | | | 1.13 H | 196 | 74.80 | 31.40 |
| 3 | 2483.50 | 62.1 PK | 74.0 | -11.9 | 1.12 H | 193 | 30.64 | 31.46 |
| 4 | 2483.50 | 53.1 AV | 54.0 | -0.9 | 1.12 H | 193 | 21.64 | 31.46 |
| 5 | 4924.00 | 54.9 PK | 74.0 | -19.1 | 1.00 H | 186 | 15.08 | 39.82 |
| 6 | 4924.00 | 49.7 AV | 54.0 | -4.3 | 1.00 H | 186 | 9.88 | 39.82 |
| 7 | 7386.00 | 53.1 PK | 74.0 | -20.9 | 1.46 H | 134 | 8.92 | 44.18 |
| 8 | 7386.00 | 39.6 AV | 54.0 | -14.4 | 1.46 H | 134 | -4.58 | 44.18 |
| ANTENNA POLARITY & TEST DISTANCE: VERTICAL AT 3 M | | | | | | | | |
| NO. | FREQ. (MHz) | EMISSION LEVEL (dBuV/m) | LIMIT (dBuV/m) | MARGIN (dB) | ANTENNA HEIGHT (m) | TABLE ANGLE (Degree) | RAW VALUE (dBuV) | CORRECTION FACTOR (dB/m) |
| 1 | *2462.00 | 103.4 PK | | | 1.14 V | 108 | 72.00 | 31.40 |
| 2 | *2462.00 | 100.2 AV | | | 1.14 V | 108 | 68.80 | 31.40 |
| 3 | 2483.50 | 58.0 PK | 74.0 | -16.0 | 1.21 V | 131 | 26.54 | 31.46 |
| 4 | 2483.50 | 48.1 AV | 54.0 | -5.9 | 1.21 V | 131 | 16.64 | 31.46 |
| 5 | 4924.00 | 53.1 PK | 74.0 | -20.9 | 1.07 V | 317 | 13.28 | 39.82 |
| 6 | 4924.00 | 48.4 AV | 54.0 | -5.6 | 1.07 V | 317 | 8.57 | 39.82 |
| 7 | 7386.00 | 51.9 PK | 74.0 | -22.1 | 1.08 V | 126 | 7.72 | 44.18 |
| 8 | 7386.00 | 39.2 AV | 54.0 | -14.8 | 1.08 V | 126 | -4.98 | 44.18 |

- REMARKS:**
1. Emission level (dBuV/m) = Raw Value (dBuV) + Correction Factor (dB/m).
 2. Correction Factor (dB/m) = Antenna Factor (dB/m) + Cable Factor (dB).
 3. The other emission levels were very low against the limit.
 4. Margin value = Emission level – Limit value.
 5. “ * “: Fundamental frequency.



A D T

RESTRICTED BANDEDGE (802.11b MODE, CH1, HORIZONTAL)

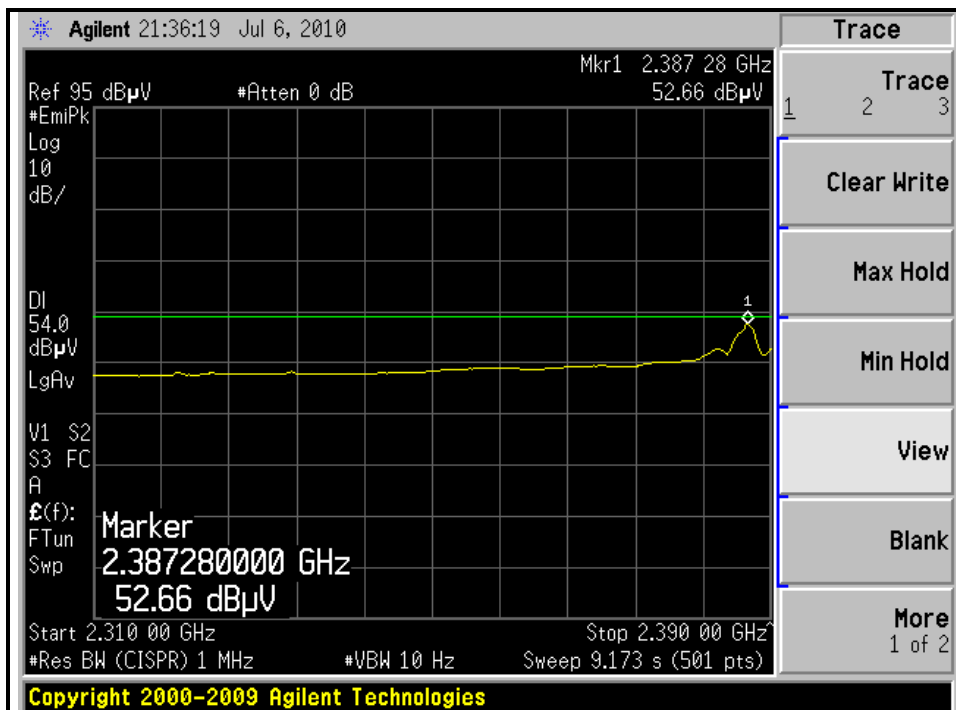
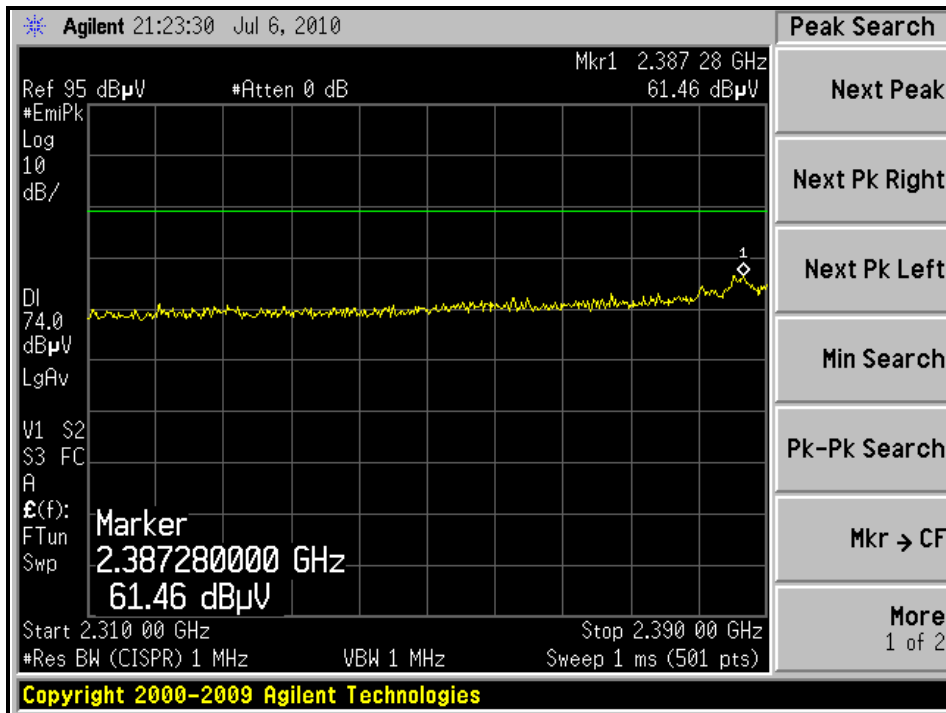



A D T

RESTRICTED BANDEDGE (802.11b MODE, CH1, VERTICAL)

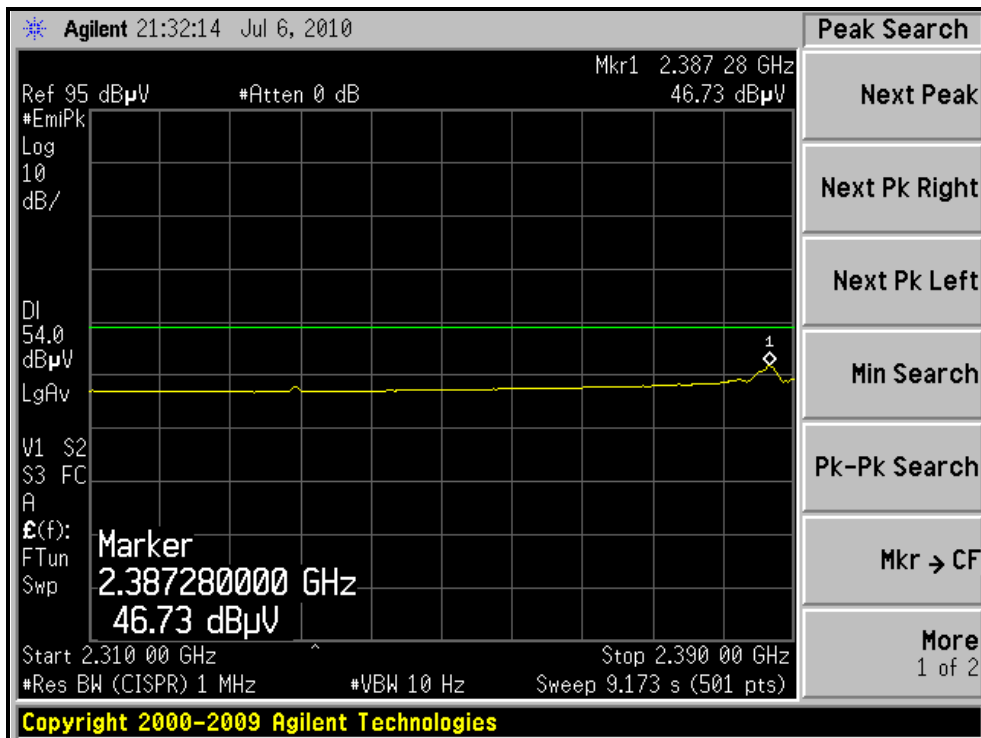
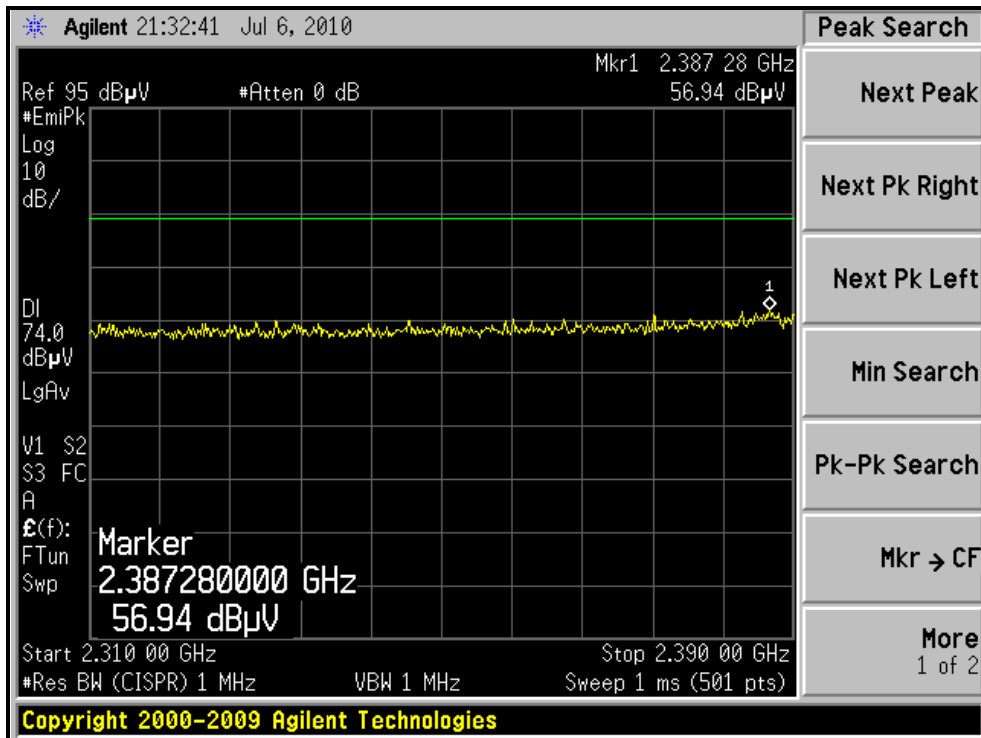



A D T

RESTRICTED BANDEDGE (802.11b MODE, CH11, HORIZONTAL)

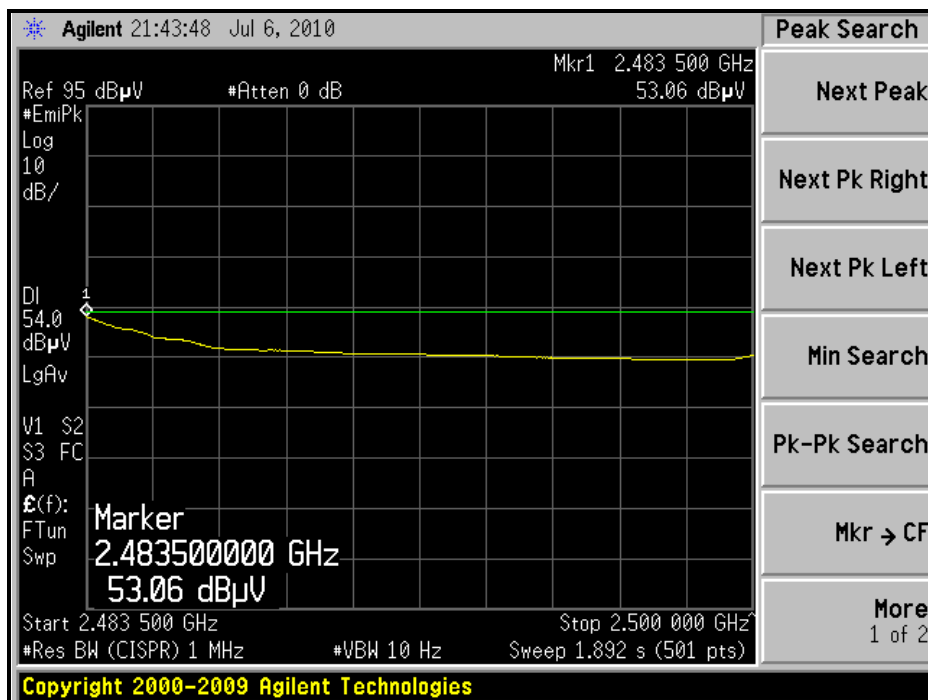
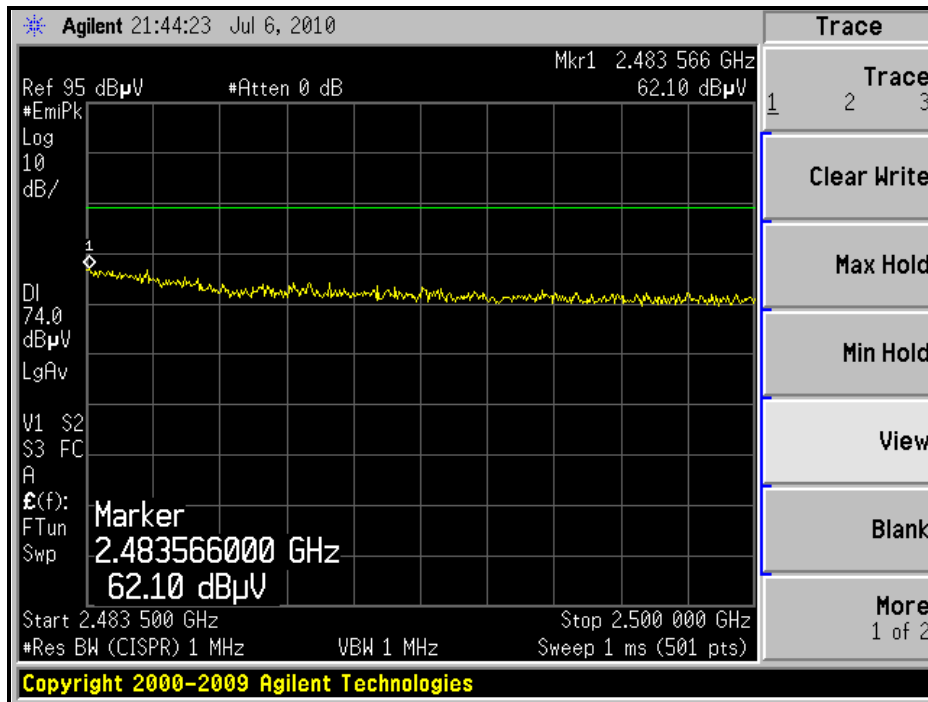



A D T

RESTRICTED BANDEDGE (802.11b MODE, CH11, VERTICAL)

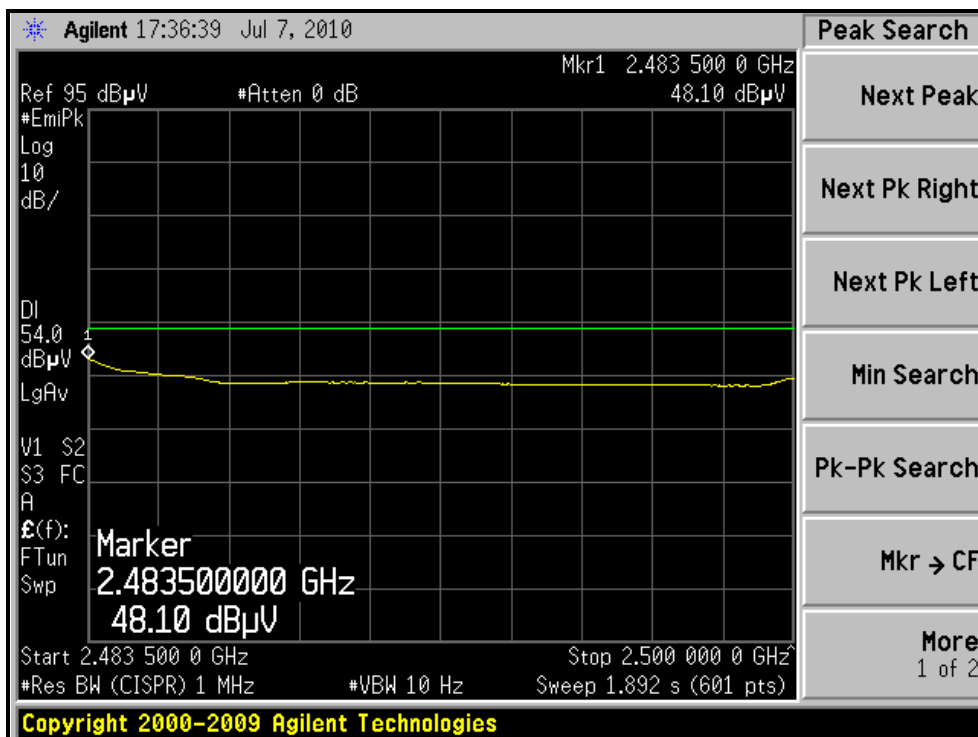
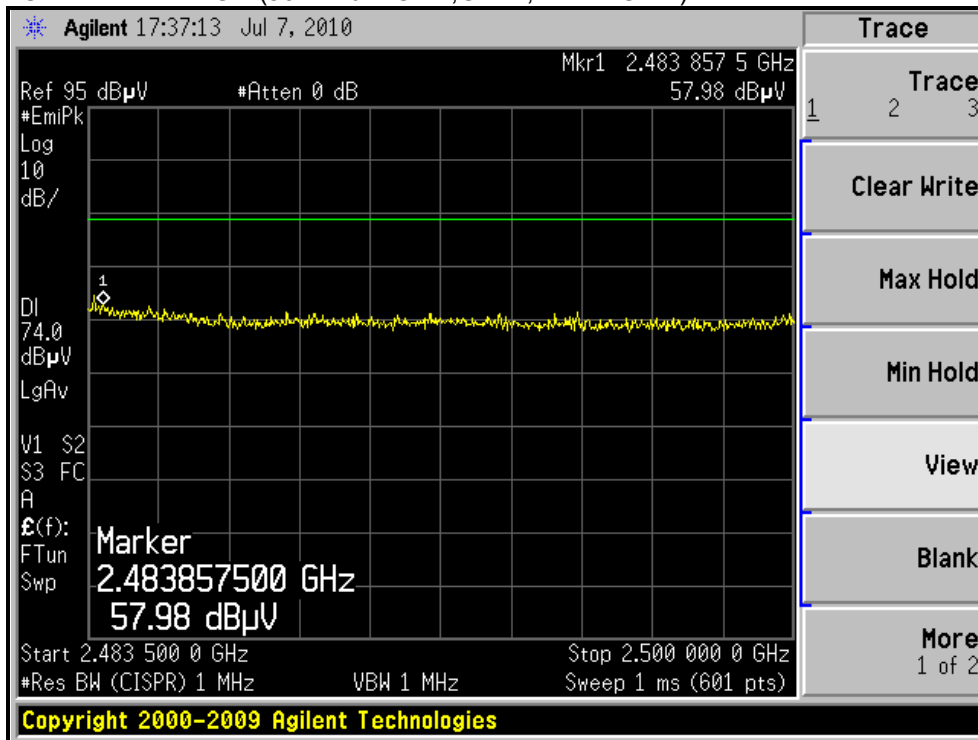



A D T

802.11g OFDM MODULATION

| EUT TEST CONDITION | | MEASUREMENT DETAIL | |
|--------------------------|-----------------------------|--------------------|---------------------------|
| CHANNEL | Channel 1 | FREQUENCY RANGE | 1 ~ 25GHz |
| INPUT POWER (SYSTEM) | 120Vac, 60 Hz | DETECTOR FUNCTION | Peak (PK) Average (AV) |
| ENVIRONMENTAL CONDITIONS | 26deg. C, 70%RH 1014 hPa | TESTED BY | Eric Lee |

ANTENNA POLARITY & TEST DISTANCE: HORIZONTAL AT 3 M

| NO. | FREQ. (MHz) | EMISSION LEVEL (dBuV/m) | LIMIT (dBuV/m) | MARGIN (dB) | ANTENNA HEIGHT (m) | TABLE ANGLE (Degree) | RAW VALUE (dBuV) | CORRECTION FACTOR (dB/m) |
|-----|-------------|-------------------------|----------------|-------------|--------------------|----------------------|------------------|--------------------------|
| 1 | 2390.00 | 73.0 PK | 74.0 | -1.0 | 1.14 H | 198 | 41.79 | 31.21 |
| 2 | 2390.00 | 52.1 AV | 54.0 | -1.9 | 1.14 H | 198 | 20.89 | 31.21 |
| 3 | *2412.00 | 108.5 PK | | | 1.13 H | 201 | 77.23 | 31.27 |
| 4 | *2412.00 | 97.5 AV | | | 1.13 H | 201 | 66.23 | 31.27 |
| 5 | 4824.00 | 48.6 PK | 74.0 | -25.4 | 1.01 H | 250 | 9.18 | 39.42 |
| 6 | 4824.00 | 34.1 AV | 54.0 | -19.9 | 1.01 H | 250 | -5.32 | 39.42 |

ANTENNA POLARITY & TEST DISTANCE: VERTICAL AT 3 M

| NO. | FREQ. (MHz) | EMISSION LEVEL (dBuV/m) | LIMIT (dBuV/m) | MARGIN (dB) | ANTENNA HEIGHT (m) | TABLE ANGLE (Degree) | RAW VALUE (dBuV) | CORRECTION FACTOR (dB/m) |
|-----|-------------|-------------------------|----------------|-------------|--------------------|----------------------|------------------|--------------------------|
| 1 | 2390.00 | 62.4 PK | 74.0 | -11.6 | 1.24 V | 121 | 31.19 | 31.21 |
| 2 | 2390.00 | 47.2 AV | 54.0 | -6.8 | 1.24 V | 121 | 15.99 | 31.21 |
| 3 | *2412.00 | 100.1 PK | | | 1.21 V | 130 | 68.83 | 31.27 |
| 4 | *2412.00 | 90.5 AV | | | 1.21 V | 130 | 59.23 | 31.27 |
| 5 | 4824.00 | 48.7 PK | 74.0 | -25.3 | 1.21 V | 291 | 9.28 | 39.42 |
| 6 | 4824.00 | 34.3 AV | 54.0 | -19.7 | 1.21 V | 291 | -5.12 | 39.42 |

- REMARKS:**
1. Emission level (dBuV/m) = Raw Value (dBuV) + Correction Factor (dB/m).
 2. Correction Factor (dB/m) = Antenna Factor (dB/m) + Cable Factor (dB).
 3. The other emission levels were very low against the limit.
 4. Margin value = Emission level – Limit value.
 5. “ * “: Fundamental frequency.



A D T

| EUT TEST CONDITION | | MEASUREMENT DETAIL | |
|--------------------------|-----------------------------|--------------------|---------------------------|
| CHANNEL | Channel 6 | FREQUENCY RANGE | 1 ~ 25GHz |
| INPUT POWER (SYSTEM) | 120Vac, 60 Hz | DETECTOR FUNCTION | Peak (PK) Average (AV) |
| ENVIRONMENTAL CONDITIONS | 26deg. C, 70%RH 1014 hPa | TESTED BY | Eric Lee |

| ANTENNA POLARITY & TEST DISTANCE: HORIZONTAL AT 3 M | | | | | | | | |
|---|-------------|-------------------------|----------------|-------------|--------------------|----------------------|------------------|--------------------------|
| NO. | FREQ. (MHz) | EMISSION LEVEL (dBuV/m) | LIMIT (dBuV/m) | MARGIN (dB) | ANTENNA HEIGHT (m) | TABLE ANGLE (Degree) | RAW VALUE (dBuV) | CORRECTION FACTOR (dB/m) |
| 1 | *2437.00 | 111.2 PK | | | 1.13 H | 204 | 79.86 | 31.34 |
| 2 | *2437.00 | 98.9 AV | | | 1.13 H | 204 | 67.56 | 31.34 |
| 3 | 4874.00 | 51.9 PK | 74.0 | -22.1 | 1.00 H | 243 | 12.28 | 39.62 |
| 4 | 4874.00 | 37.8 AV | 54.0 | -16.2 | 1.00 H | 243 | -1.82 | 39.62 |
| 5 | 7311.00 | 52.7 PK | 74.0 | -21.3 | 1.01 H | 222 | 8.60 | 44.10 |
| 6 | 7311.00 | 39.1 AV | 54.0 | -14.9 | 1.01 H | 222 | -5.00 | 44.10 |
| ANTENNA POLARITY & TEST DISTANCE: VERTICAL AT 3 M | | | | | | | | |
| NO. | FREQ. (MHz) | EMISSION LEVEL (dBuV/m) | LIMIT (dBuV/m) | MARGIN (dB) | ANTENNA HEIGHT (m) | TABLE ANGLE (Degree) | RAW VALUE (dBuV) | CORRECTION FACTOR (dB/m) |
| 1 | *2437.00 | 103.9 PK | | | 1.29 V | 155 | 72.56 | 31.34 |
| 2 | *2437.00 | 92.6 AV | | | 1.29 V | 155 | 61.26 | 31.34 |
| 3 | 4874.00 | 49.1 PK | 74.0 | -24.9 | 1.24 V | 281 | 9.48 | 39.62 |
| 4 | 4874.00 | 34.6 AV | 54.0 | -19.4 | 1.24 V | 281 | -5.02 | 39.62 |
| 5 | 7311.00 | 52.6 PK | 74.0 | -21.4 | 1.04 V | 325 | 8.50 | 44.10 |
| 6 | 7311.00 | 39.2 AV | 54.0 | -14.8 | 1.04 V | 325 | -4.90 | 44.10 |

- REMARKS:**
1. Emission level (dBuV/m) = Raw Value (dBuV) + Correction Factor (dB/m).
 2. Correction Factor (dB/m) = Antenna Factor (dB/m) + Cable Factor (dB).
 3. The other emission levels were very low against the limit.
 4. Margin value = Emission level – Limit value.
 5. “ * “: Fundamental frequency.



A D T

| EUT TEST CONDITION | | MEASUREMENT DETAIL | |
|--------------------------|-----------------------------|--------------------|---------------------------|
| CHANNEL | Channel 11 | FREQUENCY RANGE | 1 ~ 25GHz |
| INPUT POWER (SYSTEM) | 120Vac, 60 Hz | DETECTOR FUNCTION | Peak (PK) Average (AV) |
| ENVIRONMENTAL CONDITIONS | 26deg. C, 70%RH 1014 hPa | TESTED BY | Eric Lee |

| ANTENNA POLARITY & TEST DISTANCE: HORIZONTAL AT 3 M | | | | | | | | |
|---|----------------|-------------------------|----------------|-------------|--------------------|----------------------|------------------|--------------------------|
| NO. | FREQ. (MHz) | EMISSION LEVEL (dBuV/m) | LIMIT (dBuV/m) | MARGIN (dB) | ANTENNA HEIGHT (m) | TABLE ANGLE (Degree) | RAW VALUE (dBuV) | CORRECTION FACTOR (dB/m) |
| 1 | *2462.00 | 106.7 PK | | | 1.10 H | 199 | 75.30 | 31.40 |
| 2 | *2462.00 | 96.5 AV | | | 1.10 H | 199 | 65.10 | 31.40 |
| 3 | 2483.50 | 66.9 PK | 74.0 | -7.1 | 1.11 H | 202 | 35.44 | 31.46 |
| 4 | 2483.50 | 53.3 AV | 54.0 | -0.7 | 1.11 H | 202 | 21.84 | 31.46 |
| 5 | 4924.00 | 48.6 PK | 74.0 | -25.4 | 1.05 H | 261 | 8.78 | 39.82 |
| 6 | 4924.00 | 34.5 AV | 54.0 | -19.5 | 1.05 H | 261 | -5.32 | 39.82 |
| 7 | 7386.00 | 51.2 PK | 74.0 | -22.8 | 1.02 H | 251 | 7.02 | 44.18 |
| 8 | 7386.00 | 39.2 AV | 54.0 | -14.8 | 1.02 H | 251 | -4.98 | 44.18 |
| ANTENNA POLARITY & TEST DISTANCE: VERTICAL AT 3 M | | | | | | | | |
| NO. | FREQ. (MHz) | EMISSION LEVEL (dBuV/m) | LIMIT (dBuV/m) | MARGIN (dB) | ANTENNA HEIGHT (m) | TABLE ANGLE (Degree) | RAW VALUE (dBuV) | CORRECTION FACTOR (dB/m) |
| 1 | *2462.00 | 99.8 PK | | | 1.22 V | 140 | 68.40 | 31.40 |
| 2 | *2462.00 | 89.8 AV | | | 1.22 V | 140 | 58.40 | 31.40 |
| 3 | 2483.50 | 60.9 PK | 74.0 | -13.1 | 1.22 V | 137 | 29.44 | 31.46 |
| 4 | 2483.50 | 48.2 AV | 54.0 | -5.8 | 1.22 V | 137 | 16.74 | 31.46 |
| 5 | 4924.00 | 48.3 PK | 74.0 | -25.7 | 1.09 V | 277 | 8.48 | 39.82 |
| 6 | 4924.00 | 34.2 AV | 54.0 | -19.8 | 1.09 V | 277 | -5.62 | 39.82 |
| 7 | 7386.00 | 53.1 PK | 74.0 | -20.9 | 1.02 V | 341 | 8.92 | 44.18 |
| 8 | 7386.00 | 34.4 AV | 54.0 | -19.6 | 1.02 V | 341 | -9.78 | 44.18 |

- REMARKS:**
1. Emission level (dBuV/m) = Raw Value (dBuV) + Correction Factor (dB/m).
 2. Correction Factor (dB/m) = Antenna Factor (dB/m) + Cable Factor (dB).
 3. The other emission levels were very low against the limit.
 4. Margin value = Emission level – Limit value.
 5. “ * “: Fundamental frequency.



A D T

RESTRICTED BANDEDGE (802.11g MODE, CH1, HORIZONTAL)

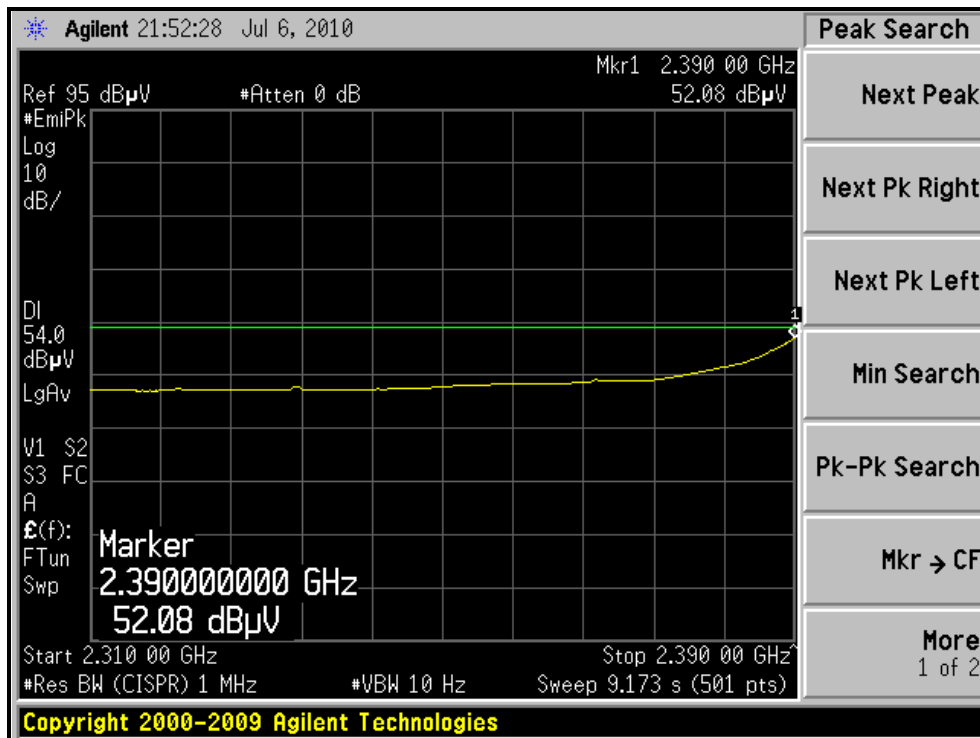
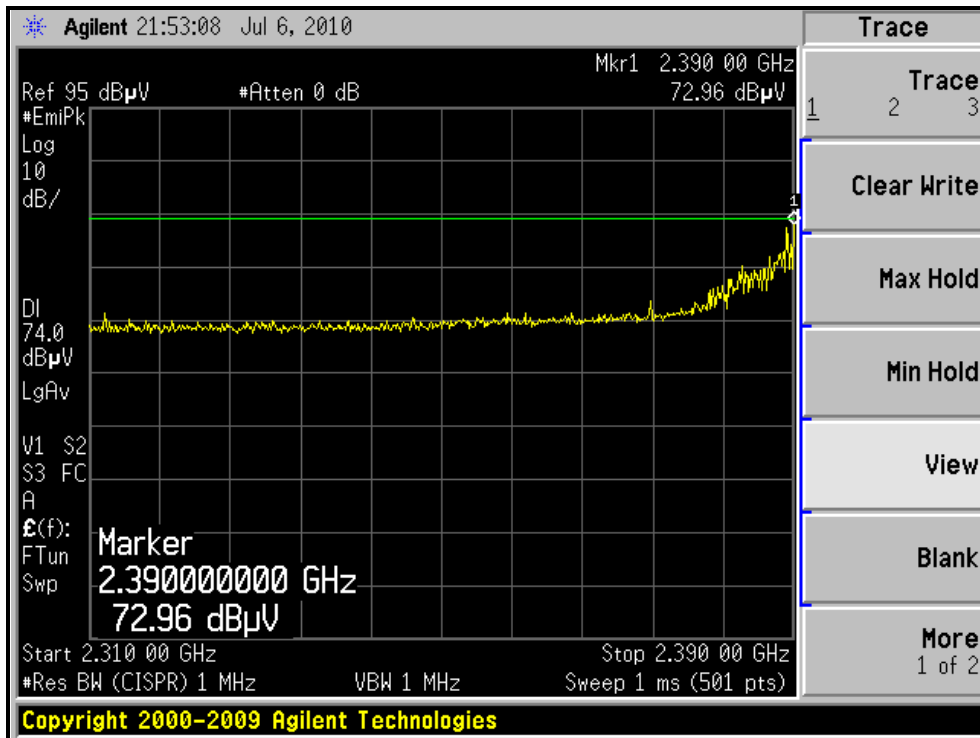



A D T

RESTRICTED BANDEDGE (802.11g MODE, CH1, VERTICAL)

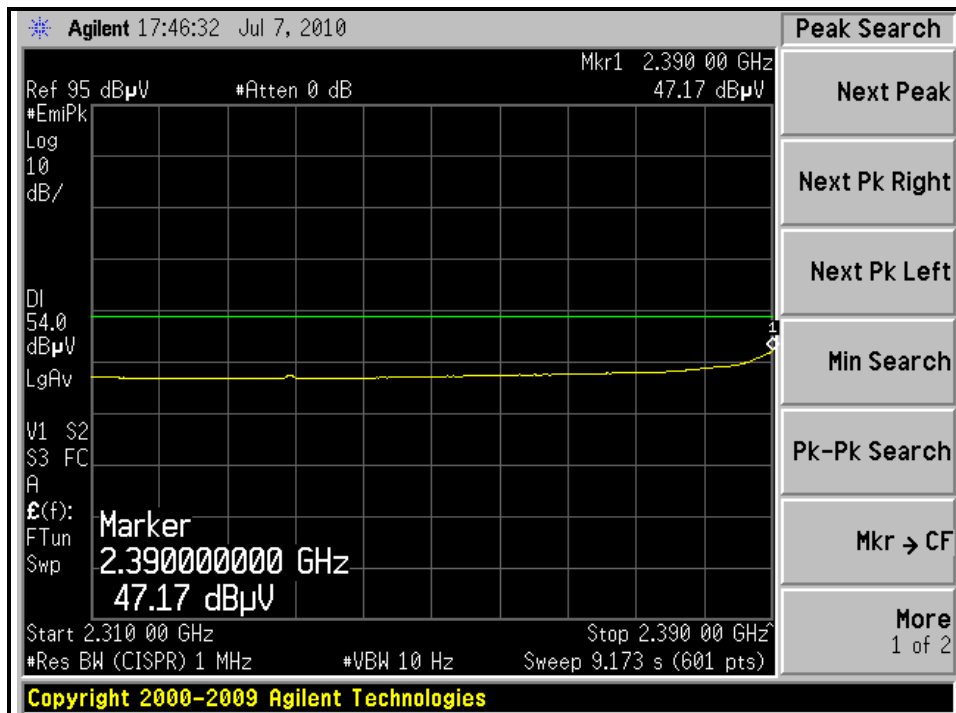
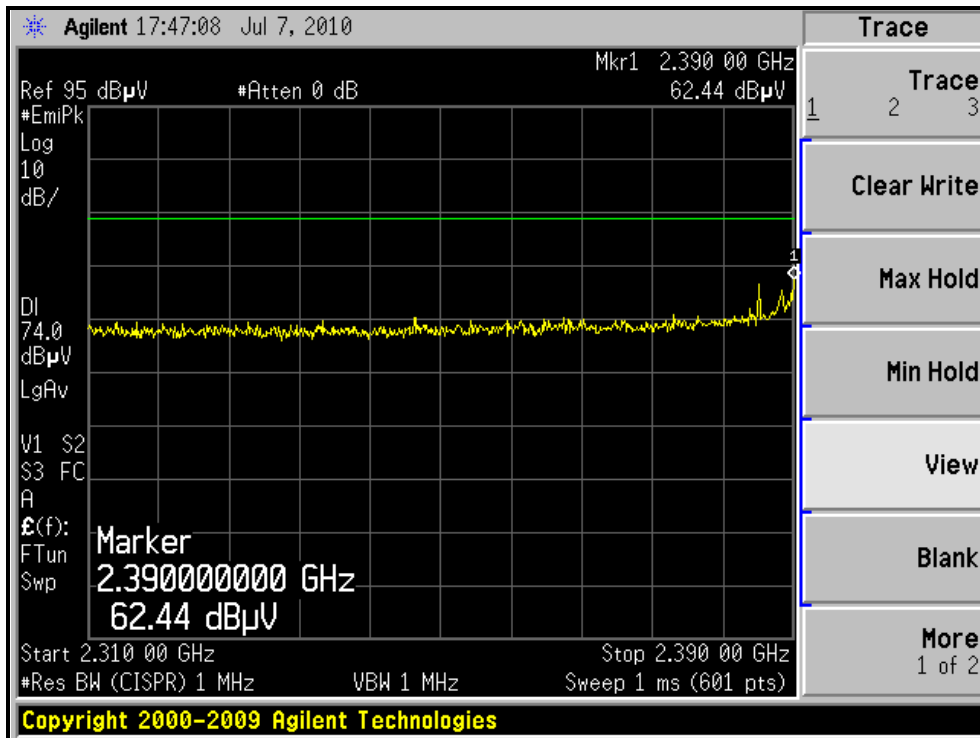



A D T

RESTRICTED BANDEDGE (802.11g MODE, CH11, HORIZONTAL)

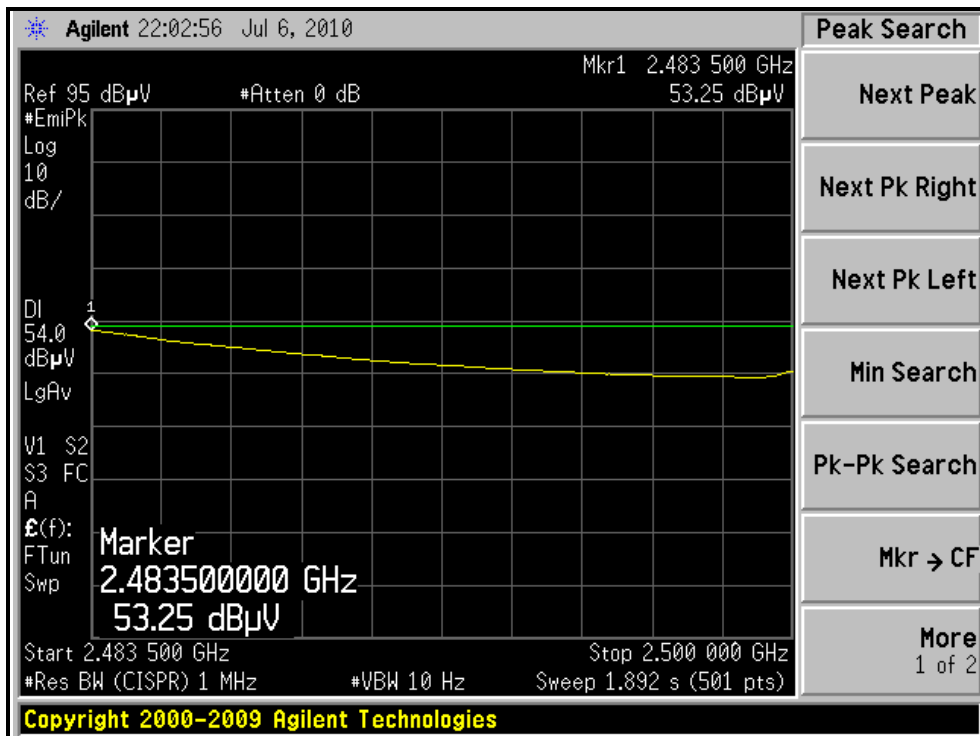
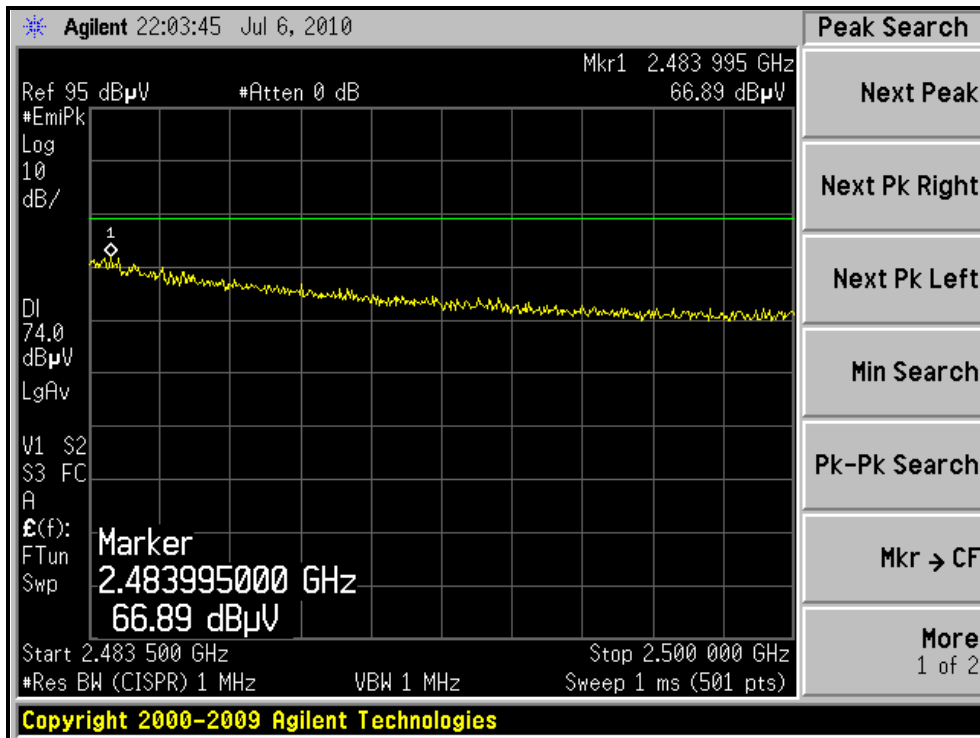



A D T

RESTRICTED BANDEDGE (802.11g MODE, CH11, VERTICAL)

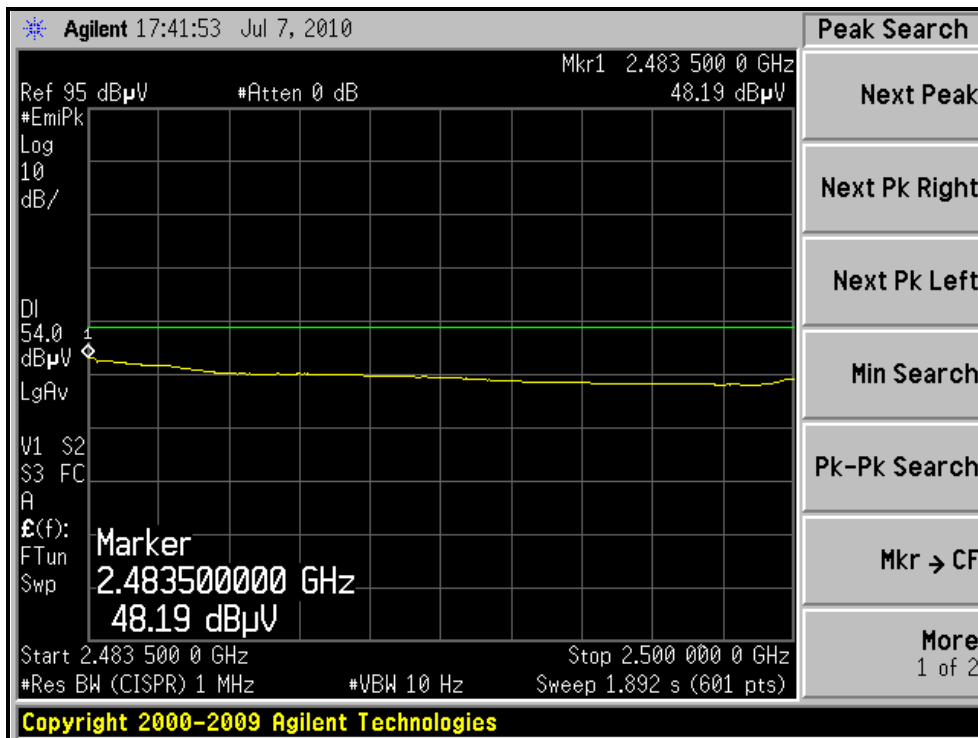
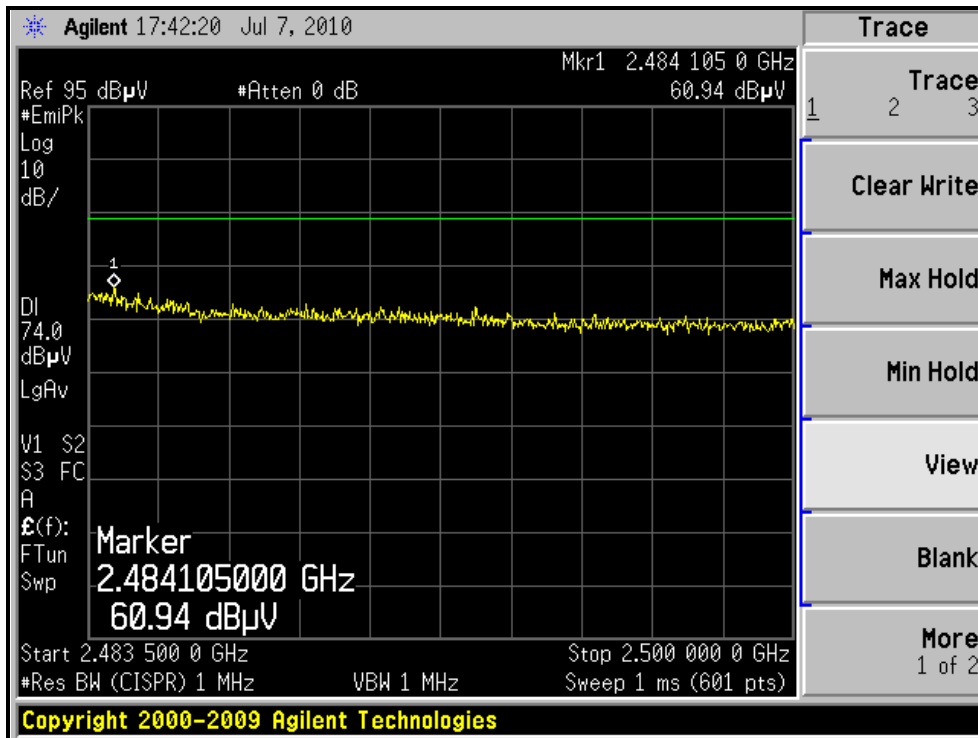



A D T

802.11n (20MHz) OFDM MODULATION

| EUT TEST CONDITION | | MEASUREMENT DETAIL | |
|--------------------------|-----------------------------|--------------------|---------------------------|
| CHANNEL | Channel 1 | FREQUENCY RANGE | 1 ~ 25GHz |
| INPUT POWER (SYSTEM) | 120Vac, 60 Hz | DETECTOR FUNCTION | Peak (PK) Average (AV) |
| ENVIRONMENTAL CONDITIONS | 26deg. C, 70%RH 1014 hPa | TESTED BY | Eric Lee |

| ANTENNA POLARITY & TEST DISTANCE: HORIZONTAL AT 3 M | | | | | | | | |
|---|-------------|-------------------------|----------------|-------------|--------------------|----------------------|------------------|--------------------------|
| NO. | FREQ. (MHz) | EMISSION LEVEL (dBuV/m) | LIMIT (dBuV/m) | MARGIN (dB) | ANTENNA HEIGHT (m) | TABLE ANGLE (Degree) | RAW VALUE (dBuV) | CORRECTION FACTOR (dB/m) |
| 1 | 2390.00 | 72.1 PK | 74.0 | -1.9 | 1.38 H | 189 | 40.89 | 31.21 |
| 2 | 2390.00 | 50.4 AV | 54.0 | -3.6 | 1.38 H | 189 | 19.19 | 31.21 |
| 3 | *2412.00 | 108.9 PK | | | 1.12 H | 200 | 77.63 | 31.27 |
| 4 | *2412.00 | 90.1 AV | | | 1.12 H | 200 | 58.83 | 31.27 |
| 5 | 4824.00 | 51.3 PK | 74.0 | -22.7 | 1.02 H | 244 | 11.88 | 39.42 |
| 6 | 4824.00 | 34.1 AV | 54.0 | -19.9 | 1.02 H | 244 | -5.32 | 39.42 |
| ANTENNA POLARITY & TEST DISTANCE: VERTICAL AT 3 M | | | | | | | | |
| NO. | FREQ. (MHz) | EMISSION LEVEL (dBuV/m) | LIMIT (dBuV/m) | MARGIN (dB) | ANTENNA HEIGHT (m) | TABLE ANGLE (Degree) | RAW VALUE (dBuV) | CORRECTION FACTOR (dB/m) |
| 1 | 2389.70 | 67.9 PK | 74.0 | -6.1 | 1.21 V | 280 | 36.69 | 31.21 |
| 2 | 2389.70 | 49.9 AV | 54.0 | -4.1 | 1.21 V | 280 | 18.69 | 31.21 |
| 3 | *2412.00 | 108.8 PK | | | 1.19 V | 360 | 77.53 | 31.27 |
| 4 | *2412.00 | 89.6 AV | | | 1.19 V | 360 | 58.33 | 31.27 |
| 5 | 4824.00 | 48.6 PK | 74.0 | -25.4 | 1.29 V | 265 | 9.18 | 39.42 |
| 6 | 4824.00 | 34.4 AV | 54.0 | -19.6 | 1.29 V | 265 | -5.02 | 39.42 |

- REMARKS:**
1. Emission level (dBuV/m) = Raw Value (dBuV) + Correction Factor (dB/m).
 2. Correction Factor (dB/m) = Antenna Factor (dB/m) + Cable Factor (dB).
 3. The other emission levels were very low against the limit.
 4. Margin value = Emission level – Limit value.
 5. “ * “: Fundamental frequency.



A D T

| EUT TEST CONDITION | | MEASUREMENT DETAIL | |
|--------------------------|-----------------------------|--------------------|---------------------------|
| CHANNEL | Channel 6 | FREQUENCY RANGE | 1 ~ 25GHz |
| INPUT POWER (SYSTEM) | 120Vac, 60 Hz | DETECTOR FUNCTION | Peak (PK) Average (AV) |
| ENVIRONMENTAL CONDITIONS | 26deg. C, 70%RH 1014 hPa | TESTED BY | Eric Lee |

ANTENNA POLARITY & TEST DISTANCE: HORIZONTAL AT 3 M

| NO. | FREQ. (MHz) | EMISSION LEVEL (dBuV/m) | LIMIT (dBuV/m) | MARGIN (dB) | ANTENNA HEIGHT (m) | TABLE ANGLE (Degree) | RAW VALUE (dBuV) | CORRECTION FACTOR (dB/m) |
|-----|-------------|-------------------------|----------------|-------------|--------------------|----------------------|------------------|--------------------------|
| 1 | 2390.00 | 71.0 PK | 74.0 | -3.0 | 1.40 H | 211 | 39.79 | 31.21 |
| 2 | 2390.00 | 48.5 AV | 54.0 | -5.5 | 1.40 H | 211 | 17.29 | 31.21 |
| 3 | *2437.00 | 114.2 PK | | | 1.38 H | 204 | 82.86 | 31.34 |
| 4 | *2437.00 | 96.1 AV | | | 1.38 H | 204 | 64.76 | 31.34 |
| 5 | 4874.00 | 51.0 PK | 74.0 | -23.0 | 1.03 H | 248 | 11.38 | 39.62 |
| 6 | 4874.00 | 36.7 AV | 54.0 | -17.3 | 1.03 H | 248 | -2.92 | 39.62 |
| 7 | 7311.00 | 49.7 PK | 74.0 | -24.3 | 1.04 H | 244 | 5.60 | 44.10 |
| 8 | 7311.00 | 39.7 AV | 54.0 | -14.3 | 1.04 H | 244 | -4.40 | 44.10 |

ANTENNA POLARITY & TEST DISTANCE: VERTICAL AT 3 M

| NO. | FREQ. (MHz) | EMISSION LEVEL (dBuV/m) | LIMIT (dBuV/m) | MARGIN (dB) | ANTENNA HEIGHT (m) | TABLE ANGLE (Degree) | RAW VALUE (dBuV) | CORRECTION FACTOR (dB/m) |
|-----|-------------|-------------------------|----------------|-------------|--------------------|----------------------|------------------|--------------------------|
| 1 | 2390.00 | 69.0 PK | 74.0 | -5.0 | 1.22 V | 280 | 37.79 | 31.21 |
| 2 | 2390.00 | 47.0 AV | 54.0 | -7.0 | 1.22 V | 280 | 15.79 | 31.21 |
| 3 | *2437.00 | 113.5 PK | | | 1.22 V | 279 | 82.16 | 31.34 |
| 4 | *2437.00 | 95.9 AV | | | 1.22 V | 279 | 64.56 | 31.34 |
| 5 | 4874.00 | 50.3 PK | 74.0 | -23.7 | 1.24 V | 251 | 10.68 | 39.62 |
| 6 | 4874.00 | 36.2 AV | 54.0 | -17.8 | 1.24 V | 251 | -3.42 | 39.62 |
| 7 | 7311.00 | 53.1 PK | 74.0 | -20.9 | 1.02 V | 311 | 9.00 | 44.10 |
| 8 | 7311.00 | 39.5 AV | 54.0 | -14.5 | 1.02 V | 311 | -4.60 | 44.10 |

- REMARKS:**
1. Emission level (dBuV/m) = Raw Value (dBuV) + Correction Factor (dB/m).
 2. Correction Factor (dB/m) = Antenna Factor (dB/m) + Cable Factor (dB).
 3. The other emission levels were very low against the limit.
 4. Margin value = Emission level – Limit value.
 5. “ * “: Fundamental frequency.



A D T

| EUT TEST CONDITION | | MEASUREMENT DETAIL | |
|--------------------------|-----------------------------|--------------------|---------------------------|
| CHANNEL | Channel 11 | FREQUENCY RANGE | 1 ~ 25GHz |
| INPUT POWER (SYSTEM) | 120Vac, 60 Hz | DETECTOR FUNCTION | Peak (PK) Average (AV) |
| ENVIRONMENTAL CONDITIONS | 26deg. C, 70%RH 1014 hPa | TESTED BY | Eric Lee |

| ANTENNA POLARITY & TEST DISTANCE: HORIZONTAL AT 3 M | | | | | | | | |
|---|-------------|-------------------------|----------------|-------------|--------------------|----------------------|------------------|--------------------------|
| NO. | FREQ. (MHz) | EMISSION LEVEL (dBuV/m) | LIMIT (dBuV/m) | MARGIN (dB) | ANTENNA HEIGHT (m) | TABLE ANGLE (Degree) | RAW VALUE (dBuV) | CORRECTION FACTOR (dB/m) |
| 1 | *2462.00 | 108.1 PK | | | 1.08 H | 211 | 76.70 | 31.40 |
| 2 | *2462.00 | 91.2 AV | | | 1.08 H | 211 | 59.80 | 31.40 |
| 3 | 2483.70 | 69.4 PK | 74.0 | -4.6 | 1.09 H | 205 | 37.94 | 31.46 |
| 4 | 2483.70 | 53.1 AV | 54.0 | -0.9 | 1.09 H | 205 | 21.64 | 31.46 |
| 5 | 4924.00 | 48.9 PK | 74.0 | -25.1 | 1.02 H | 257 | 9.08 | 39.82 |
| 6 | 4924.00 | 34.7 AV | 54.0 | -19.3 | 1.02 H | 257 | -5.12 | 39.82 |
| 7 | 7386.00 | 51.4 PK | 74.0 | -22.6 | 1.03 H | 235 | 7.22 | 44.18 |
| 8 | 7386.00 | 39.5 AV | 54.0 | -14.5 | 1.03 H | 235 | -4.68 | 44.18 |
| ANTENNA POLARITY & TEST DISTANCE: VERTICAL AT 3 M | | | | | | | | |
| NO. | FREQ. (MHz) | EMISSION LEVEL (dBuV/m) | LIMIT (dBuV/m) | MARGIN (dB) | ANTENNA HEIGHT (m) | TABLE ANGLE (Degree) | RAW VALUE (dBuV) | CORRECTION FACTOR (dB/m) |
| 1 | *2462.00 | 107.8 PK | | | 1.21 V | 284 | 76.40 | 31.40 |
| 2 | *2462.00 | 90.3 AV | | | 1.21 V | 284 | 58.90 | 31.40 |
| 3 | 2483.60 | 69.2 PK | 74.0 | -4.8 | 1.21 V | 281 | 37.74 | 31.46 |
| 4 | 2483.60 | 50.7 AV | 54.0 | -3.3 | 1.21 V | 281 | 19.24 | 31.46 |
| 5 | 4924.00 | 48.6 PK | 74.0 | -25.4 | 1.26 V | 269 | 8.78 | 39.82 |
| 6 | 4924.00 | 34.3 AV | 54.0 | -19.7 | 1.26 V | 269 | -5.52 | 39.82 |
| 7 | 7386.00 | 53.2 PK | 74.0 | -20.8 | 1.04 V | 344 | 9.02 | 44.18 |
| 8 | 7386.00 | 39.6 AV | 54.0 | -14.4 | 1.04 V | 344 | -4.58 | 44.18 |

- REMARKS:**
1. Emission level (dBuV/m) = Raw Value (dBuV) + Correction Factor (dB/m).
 2. Correction Factor (dB/m) = Antenna Factor (dB/m) + Cable Factor (dB).
 3. The other emission levels were very low against the limit.
 4. Margin value = Emission level – Limit value.
 5. “ * “: Fundamental frequency.



A D T

RESTRICTED BANDEDGE (802.11n (20MHz) MODE,CH1, HORIZONTAL)

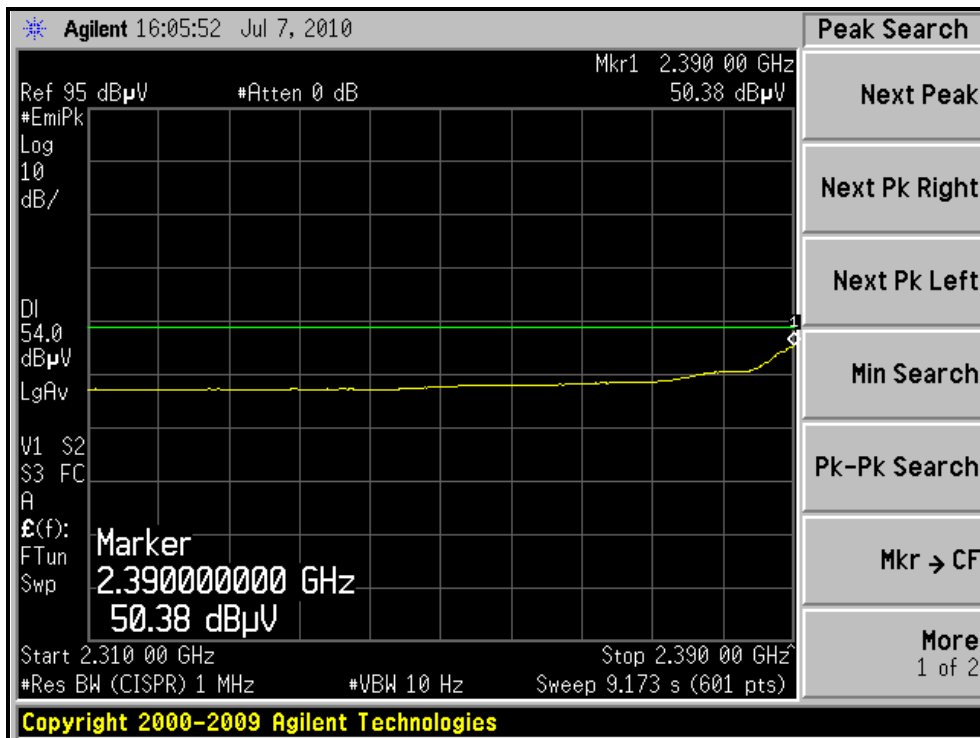
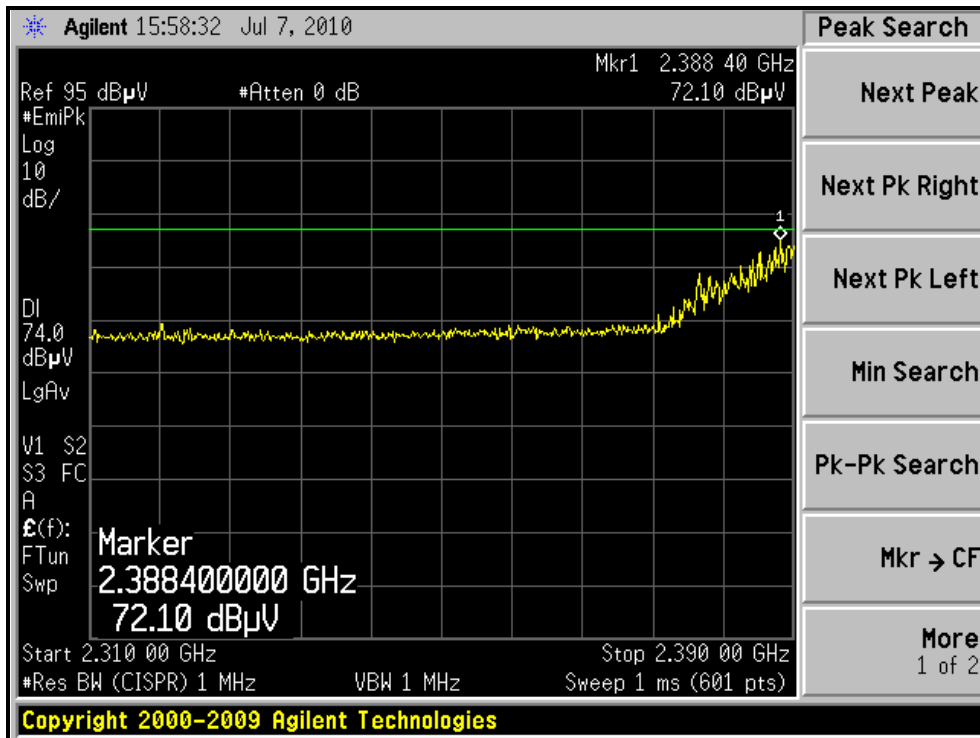



A D T

RESTRICTED BANDEDGE (802.11n (20MHz) MODE,CH1, VERTICAL)

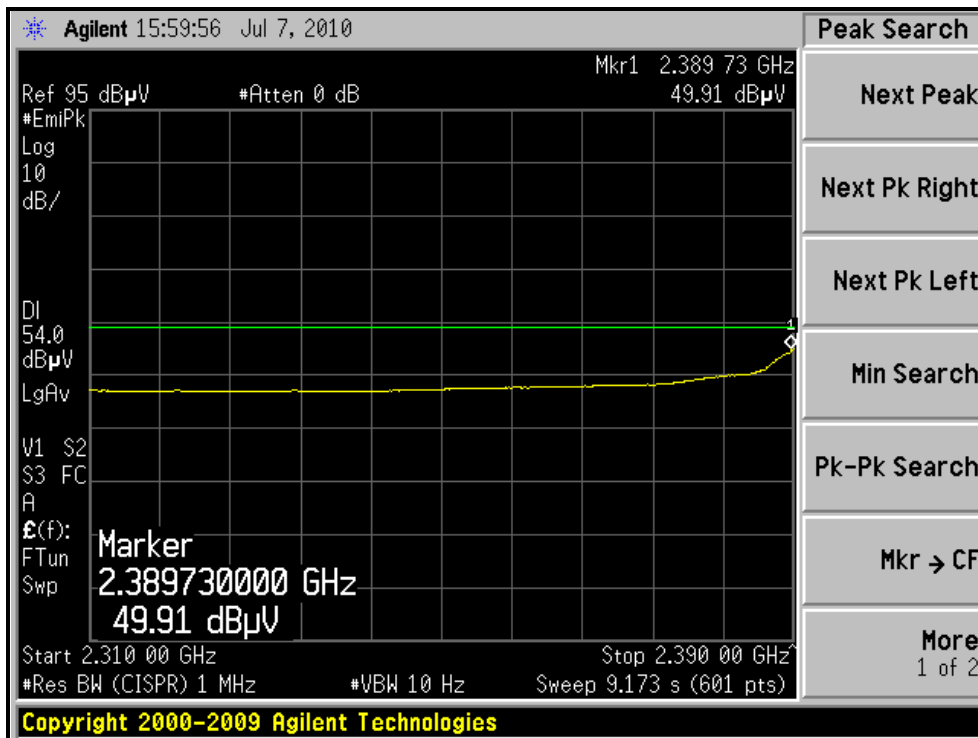
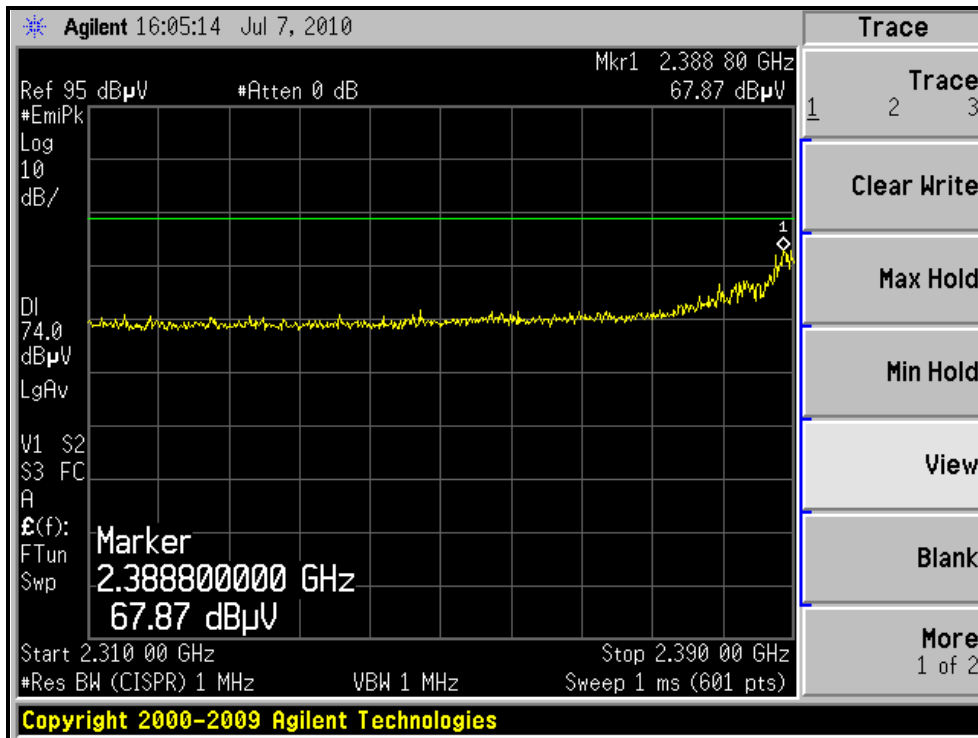



A D T

RESTRICTED BANDEDGE (802.11n (20MHz) MODE, CH11, HORIZONTAL)

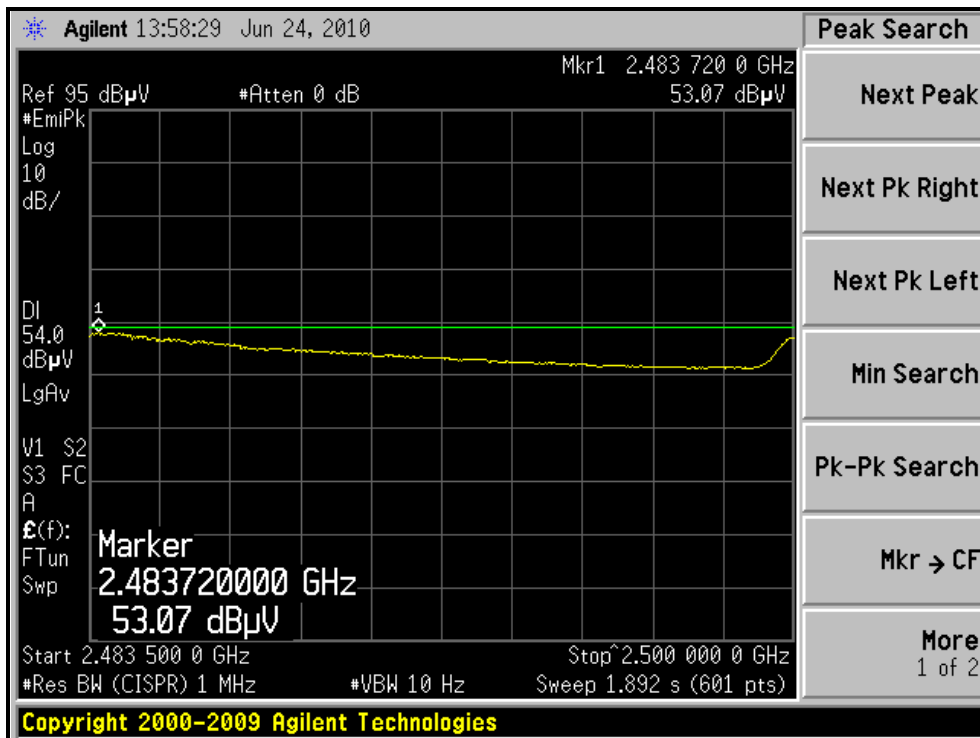
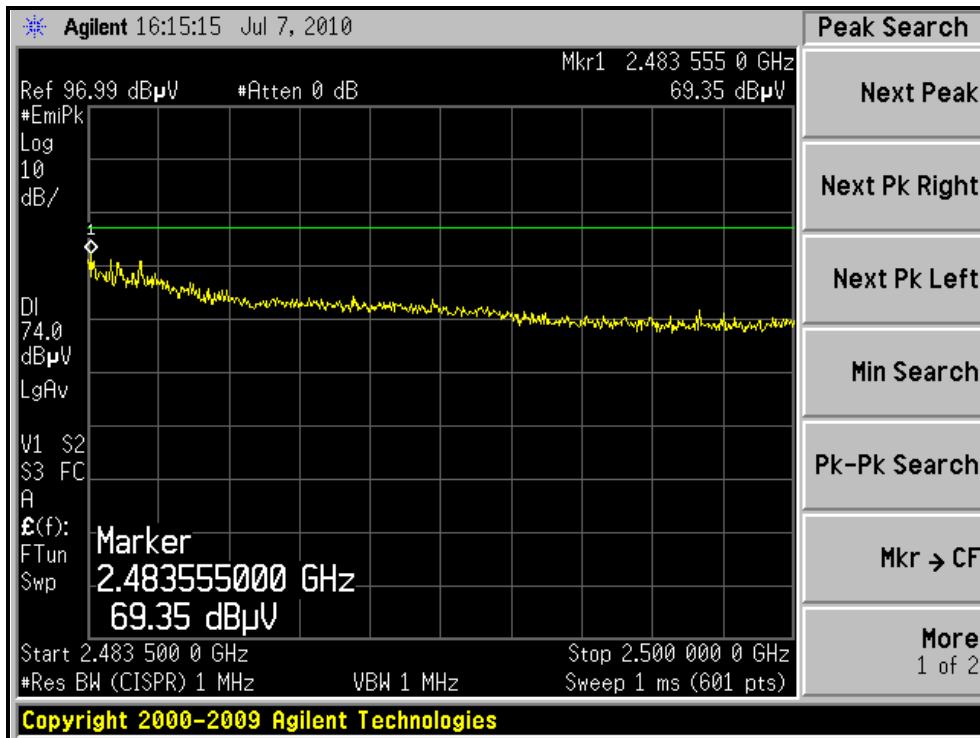



A D T

RESTRICTED BANDEDGE (802.11n (20MHz) MODE,CH11, VERTICAL)

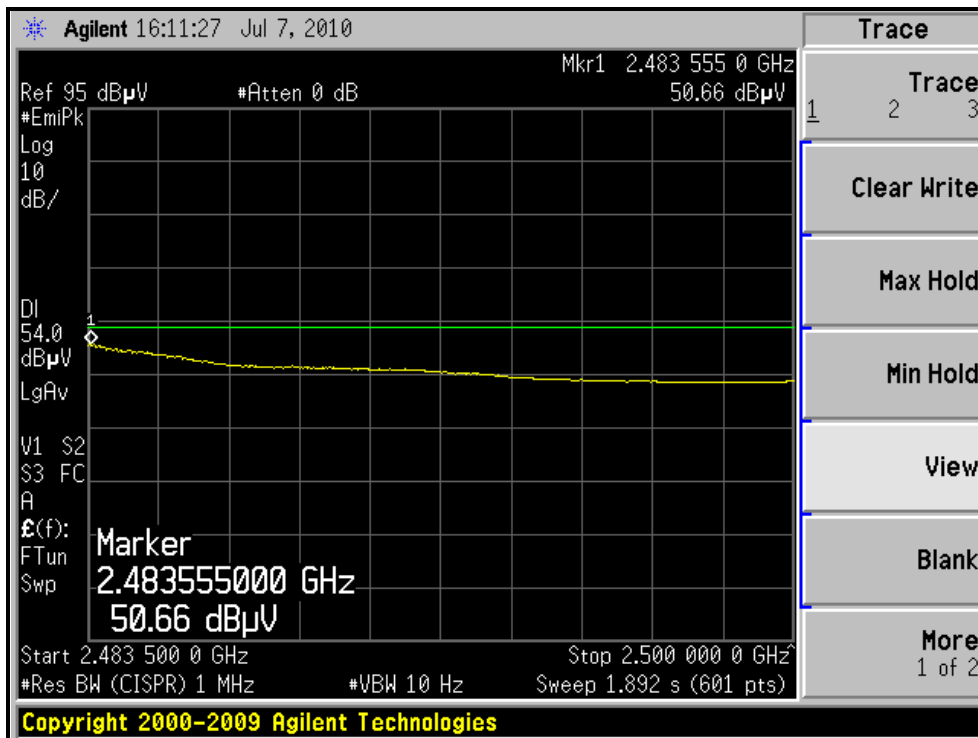
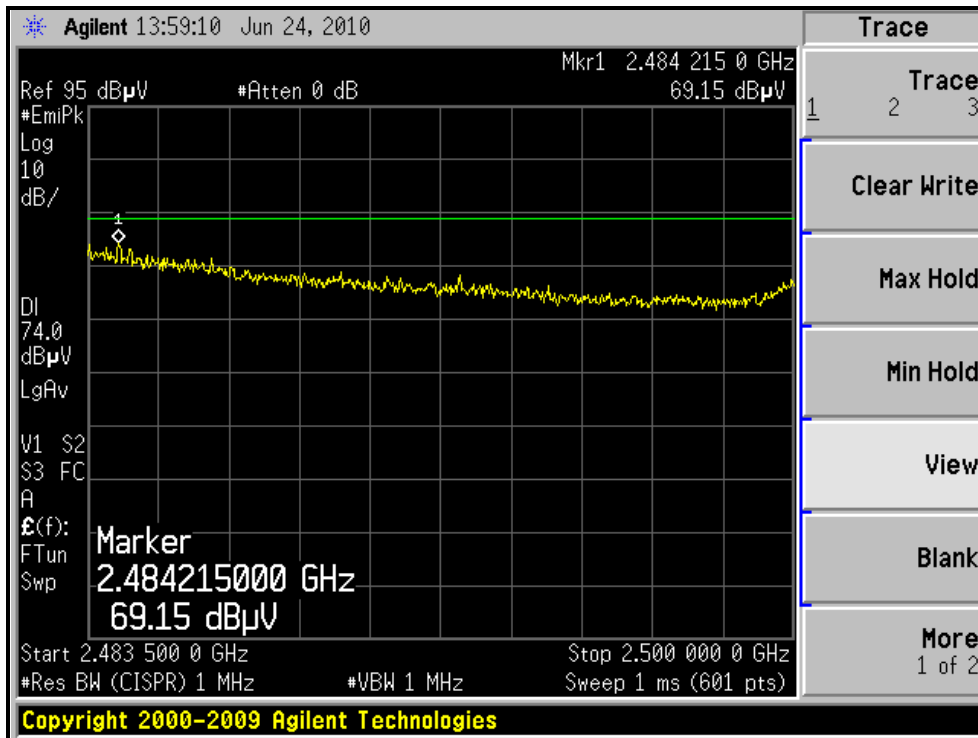



A D T

802.11n (40MHz) OFDM MODULATION

| EUT TEST CONDITION | | MEASUREMENT DETAIL | |
|--------------------------|-----------------------------|--------------------|---------------------------|
| CHANNEL | Channel 1 | FREQUENCY RANGE | 1 ~ 25GHz |
| INPUT POWER (SYSTEM) | 120Vac, 60 Hz | DETECTOR FUNCTION | Peak (PK) Average (AV) |
| ENVIRONMENTAL CONDITIONS | 26deg. C, 70%RH 1014 hPa | TESTED BY | Eric Lee |

| ANTENNA POLARITY & TEST DISTANCE: HORIZONTAL AT 3 M | | | | | | | | |
|---|-------------|-------------------------|----------------|-------------|--------------------|----------------------|------------------|--------------------------|
| NO. | FREQ. (MHz) | EMISSION LEVEL (dBuV/m) | LIMIT (dBuV/m) | MARGIN (dB) | ANTENNA HEIGHT (m) | TABLE ANGLE (Degree) | RAW VALUE (dBuV) | CORRECTION FACTOR (dB/m) |
| 1 | 2388.80 | 72.6 PK | 74.0 | -1.4 | 1.37 H | 208 | 41.39 | 31.21 |
| 2 | 2388.80 | 49.2 AV | 54.0 | -4.8 | 1.37 H | 208 | 17.99 | 31.21 |
| 3 | *2422.00 | 106.3 PK | | | 1.36 H | 210 | 75.00 | 31.30 |
| 4 | *2422.00 | 78.4 AV | | | 1.36 H | 210 | 47.10 | 31.30 |
| 5 | 4844.00 | 48.2 PK | 74.0 | -25.8 | 1.02 H | 249 | 8.70 | 39.50 |
| 6 | 4844.00 | 34.4 AV | 54.0 | -19.6 | 1.02 H | 249 | -5.10 | 39.50 |
| 7 | 7266.00 | 53.9 PK | 74.0 | -20.1 | 1.03 H | 251 | 9.84 | 44.06 |
| 8 | 7266.00 | 39.1 AV | 54.0 | -14.9 | 1.03 H | 251 | -4.96 | 44.06 |
| ANTENNA POLARITY & TEST DISTANCE: VERTICAL AT 3 M | | | | | | | | |
| NO. | FREQ. (MHz) | EMISSION LEVEL (dBuV/m) | LIMIT (dBuV/m) | MARGIN (dB) | ANTENNA HEIGHT (m) | TABLE ANGLE (Degree) | RAW VALUE (dBuV) | CORRECTION FACTOR (dB/m) |
| 1 | 2389.30 | 70.3 PK | 74.0 | -3.7 | 1.23 V | 278 | 39.09 | 31.21 |
| 2 | 2389.30 | 48.7 AV | 54.0 | -5.3 | 1.23 V | 278 | 17.49 | 31.21 |
| 3 | *2422.00 | 106.7 PK | | | 1.19 V | 291 | 75.40 | 31.30 |
| 4 | *2422.00 | 78.3 AV | | | 1.19 V | 291 | 47.00 | 31.30 |
| 5 | 4844.00 | 48.3 PK | 74.0 | -25.7 | 1.29 V | 243 | 8.80 | 39.50 |
| 6 | 4844.00 | 34.1 AV | 54.0 | -19.9 | 1.29 V | 243 | -5.40 | 39.50 |
| 7 | 7266.00 | 53.4 PK | 74.0 | -20.6 | 1.03 V | 344 | 9.34 | 44.06 |
| 8 | 7266.00 | 39.2 AV | 54.0 | -14.8 | 1.03 V | 344 | -4.86 | 44.06 |

- REMARKS:**
1. Emission level (dBuV/m) = Raw Value (dBuV) + Correction Factor (dB/m).
 2. Correction Factor (dB/m) = Antenna Factor (dB/m) + Cable Factor (dB).
 3. The other emission levels were very low against the limit.
 4. Margin value = Emission level – Limit value.
 5. “ * “: Fundamental frequency.



A D T

| EUT TEST CONDITION | | MEASUREMENT DETAIL | |
|--------------------------|-----------------------------|--------------------|---------------------------|
| CHANNEL | Channel 4 | FREQUENCY RANGE | 1 ~ 25GHz |
| INPUT POWER (SYSTEM) | 120Vac, 60 Hz | DETECTOR FUNCTION | Peak (PK) Average (AV) |
| ENVIRONMENTAL CONDITIONS | 26deg. C, 70%RH 1014 hPa | TESTED BY | Eric Lee |

| ANTENNA POLARITY & TEST DISTANCE: HORIZONTAL AT 3 M | | | | | | | | |
|---|-------------|-------------------------|----------------|-------------|--------------------|----------------------|------------------|--------------------------|
| NO. | FREQ. (MHz) | EMISSION LEVEL (dBuV/m) | LIMIT (dBuV/m) | MARGIN (dB) | ANTENNA HEIGHT (m) | TABLE ANGLE (Degree) | RAW VALUE (dBuV) | CORRECTION FACTOR (dB/m) |
| 1 | 2390.00 | 72.1 PK | 74.0 | -1.9 | 1.02 H | 75 | 40.89 | 31.21 |
| 2 | 2390.00 | 50.0 AV | 54.0 | -4.0 | 1.02 H | 75 | 18.79 | 31.21 |
| 3 | *2437.00 | 108.4 PK | | | 1.40 H | 211 | 77.06 | 31.34 |
| 4 | *2437.00 | 81.4 AV | | | 1.40 H | 211 | 50.06 | 31.34 |
| 5 | 4874.00 | 50.6 PK | 74.0 | -23.4 | 1.31 H | 241 | 10.98 | 39.62 |
| 6 | 4874.00 | 36.4 AV | 54.0 | -17.6 | 1.31 H | 241 | -3.22 | 39.62 |
| 7 | 7311.00 | 53.8 PK | 74.0 | -20.2 | 1.04 H | 244 | 9.70 | 44.10 |
| 8 | 7311.00 | 39.3 AV | 54.0 | -14.7 | 1.04 H | 244 | -4.80 | 44.10 |
| ANTENNA POLARITY & TEST DISTANCE: VERTICAL AT 3 M | | | | | | | | |
| NO. | FREQ. (MHz) | EMISSION LEVEL (dBuV/m) | LIMIT (dBuV/m) | MARGIN (dB) | ANTENNA HEIGHT (m) | TABLE ANGLE (Degree) | RAW VALUE (dBuV) | CORRECTION FACTOR (dB/m) |
| 1 | 2390.00 | 69.9 PK | 74.0 | -4.1 | 1.20 V | 269 | 38.69 | 31.21 |
| 2 | 2390.00 | 47.0 AV | 54.0 | -7.0 | 1.20 V | 269 | 15.79 | 31.21 |
| 3 | *2437.00 | 107.5 PK | | | 1.23 V | 278 | 76.16 | 31.34 |
| 4 | *2437.00 | 80.1 AV | | | 1.23 V | 278 | 48.76 | 31.34 |
| 5 | 4874.00 | 50.2 PK | 74.0 | -23.8 | 1.21 V | 251 | 10.58 | 39.62 |
| 6 | 4874.00 | 36.1 AV | 54.0 | -17.9 | 1.21 V | 251 | -3.52 | 39.62 |
| 7 | 7311.00 | 53.7 PK | 74.0 | -20.3 | 1.04 V | 345 | 9.60 | 44.10 |
| 8 | 7311.00 | 39.3 AV | 54.0 | -14.7 | 1.04 V | 345 | -4.76 | 44.10 |

- REMARKS:**
1. Emission level (dBuV/m) = Raw Value (dBuV) + Correction Factor (dB/m).
 2. Correction Factor (dB/m) = Antenna Factor (dB/m) + Cable Factor (dB).
 3. The other emission levels were very low against the limit.
 4. Margin value = Emission level – Limit value.
 5. “ * “: Fundamental frequency.



A D T

| EUT TEST CONDITION | | MEASUREMENT DETAIL | |
|--------------------------|-----------------------------|--------------------|---------------------------|
| CHANNEL | Channel 7 | FREQUENCY RANGE | 1 ~ 25GHz |
| INPUT POWER (SYSTEM) | 120Vac, 60 Hz | DETECTOR FUNCTION | Peak (PK) Average (AV) |
| ENVIRONMENTAL CONDITIONS | 26deg. C, 70%RH 1014 hPa | TESTED BY | Eric Lee |

ANTENNA POLARITY & TEST DISTANCE: HORIZONTAL AT 3 M

| NO. | FREQ. (MHz) | EMISSION LEVEL (dBuV/m) | LIMIT (dBuV/m) | MARGIN (dB) | ANTENNA HEIGHT (m) | TABLE ANGLE (Degree) | RAW VALUE (dBuV) | CORRECTION FACTOR (dB/m) |
|-----|-------------|-------------------------|----------------|-------------|--------------------|----------------------|------------------|--------------------------|
| 1 | *2452.00 | 107.9 PK | | | 1.29 H | 211 | 76.52 | 31.38 |
| 2 | *2452.00 | 79.9 AV | | | 1.29 H | 211 | 48.52 | 31.38 |
| 3 | 2490.90 | 70.7 PK | 74.0 | -3.3 | 1.33 H | 209 | 39.22 | 31.48 |
| 4 | 2490.90 | 49.0 AV | 54.0 | -5.0 | 1.33 H | 209 | 17.52 | 31.48 |
| 5 | 4904.00 | 48.3 PK | 74.0 | -25.7 | 1.04 H | 239 | 8.56 | 39.74 |
| 6 | 4904.00 | 34.1 AV | 54.0 | -19.9 | 1.04 H | 239 | -5.64 | 39.74 |
| 7 | 7356.00 | 51.4 PK | 74.0 | -22.6 | 1.01 H | 239 | 7.25 | 44.15 |
| 8 | 7356.00 | 39.4 AV | 54.0 | -14.6 | 1.01 H | 239 | -4.75 | 44.15 |

ANTENNA POLARITY & TEST DISTANCE: VERTICAL AT 3 M

| NO. | FREQ. (MHz) | EMISSION LEVEL (dBuV/m) | LIMIT (dBuV/m) | MARGIN (dB) | ANTENNA HEIGHT (m) | TABLE ANGLE (Degree) | RAW VALUE (dBuV) | CORRECTION FACTOR (dB/m) |
|-----|-------------|-------------------------|----------------|-------------|--------------------|----------------------|------------------|--------------------------|
| 1 | *2452.00 | 107.3 PK | | | 1.20 V | 271 | 75.92 | 31.38 |
| 2 | *2452.00 | 79.6 AV | | | 1.20 V | 271 | 48.22 | 31.38 |
| 3 | 2489.60 | 70.2 PK | 74.0 | -3.8 | 1.21 V | 280 | 38.73 | 31.47 |
| 4 | 2489.60 | 47.4 AV | 54.0 | -6.6 | 1.21 V | 280 | 15.93 | 31.47 |
| 5 | 4904.00 | 48.1 PK | 74.0 | -25.9 | 1.24 V | 263 | 8.36 | 39.74 |
| 6 | 4904.00 | 34.3 AV | 54.0 | -19.7 | 1.24 V | 263 | -5.44 | 39.74 |
| 7 | 7356.00 | 53.9 PK | 74.0 | -20.1 | 1.03 V | 342 | 9.75 | 44.15 |
| 8 | 7356.00 | 39.2 AV | 54.0 | -14.8 | 1.03 V | 342 | -4.95 | 44.15 |

- REMARKS:**
1. Emission level (dBuV/m) = Raw Value (dBuV) + Correction Factor (dB/m).
 2. Correction Factor (dB/m) = Antenna Factor (dB/m) + Cable Factor (dB).
 3. The other emission levels were very low against the limit.
 4. Margin value = Emission level – Limit value.
 5. “ * “: Fundamental frequency.



A D T

RESTRICTED BANDEDGE (802.11n (40MHz) MODE, CH1, HORIZONTAL)

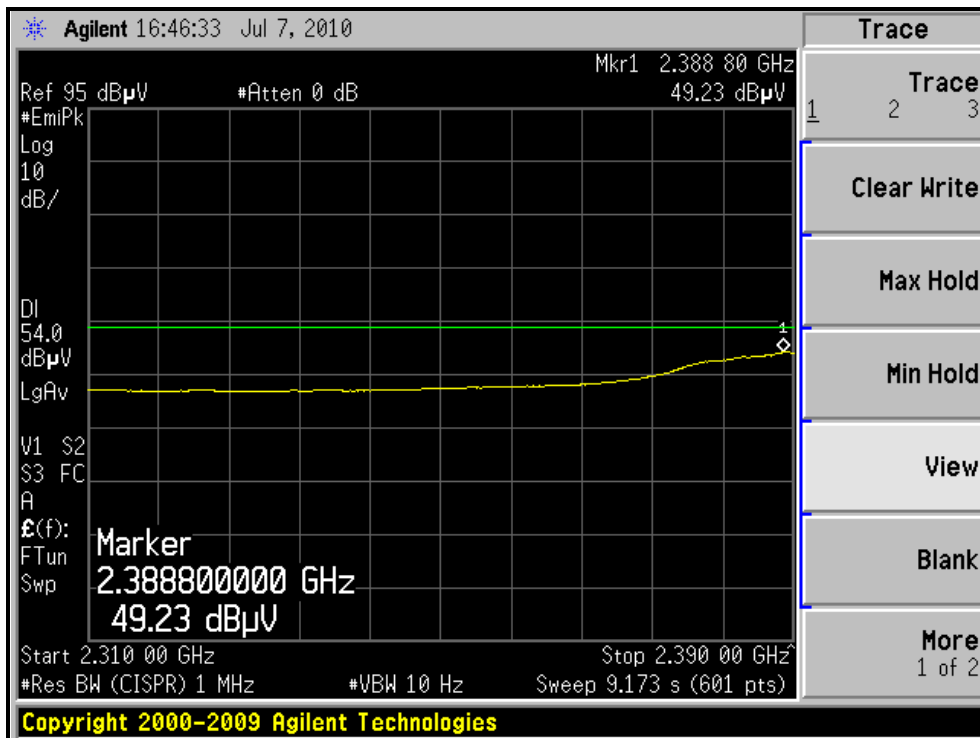
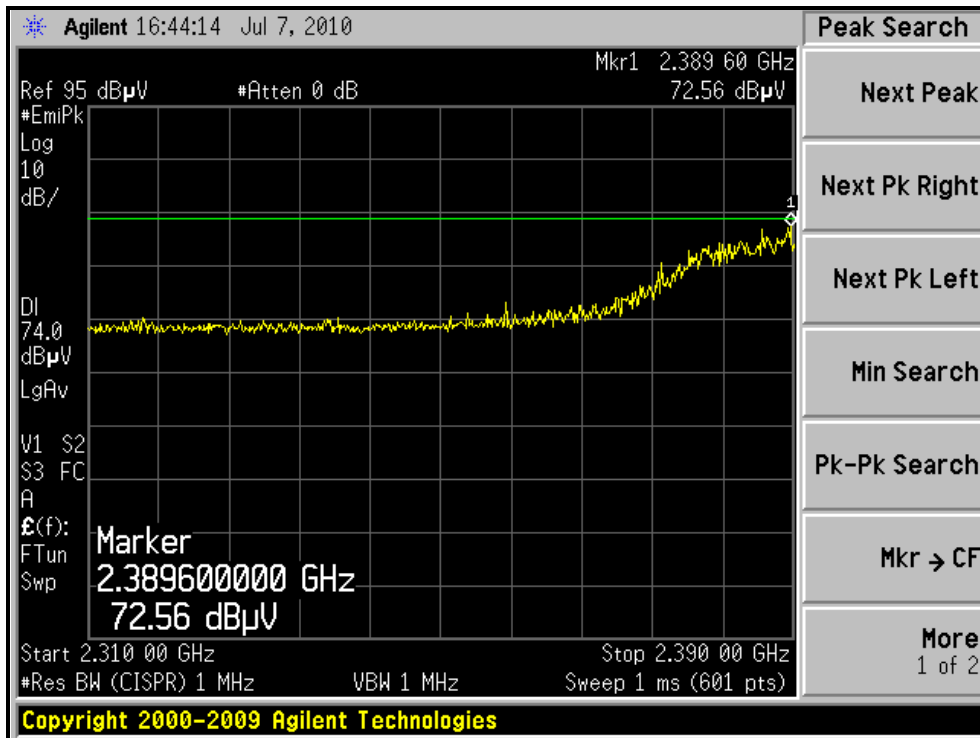



A D T

RESTRICTED BANDEDGE (802.11n (40MHz) MODE,CH1, VERTICAL)

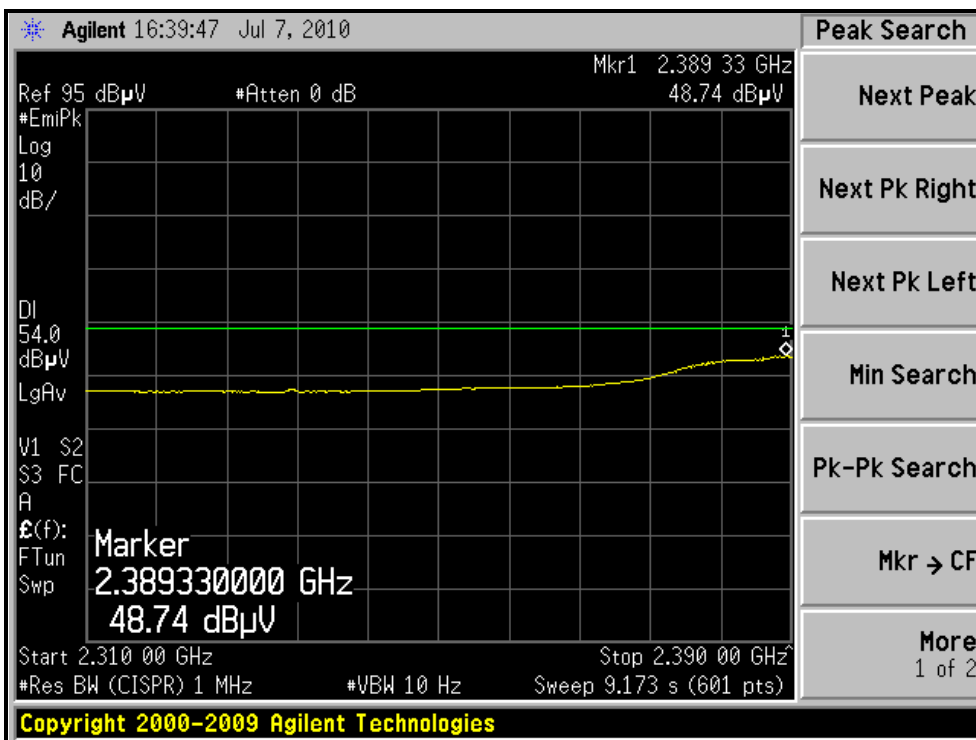
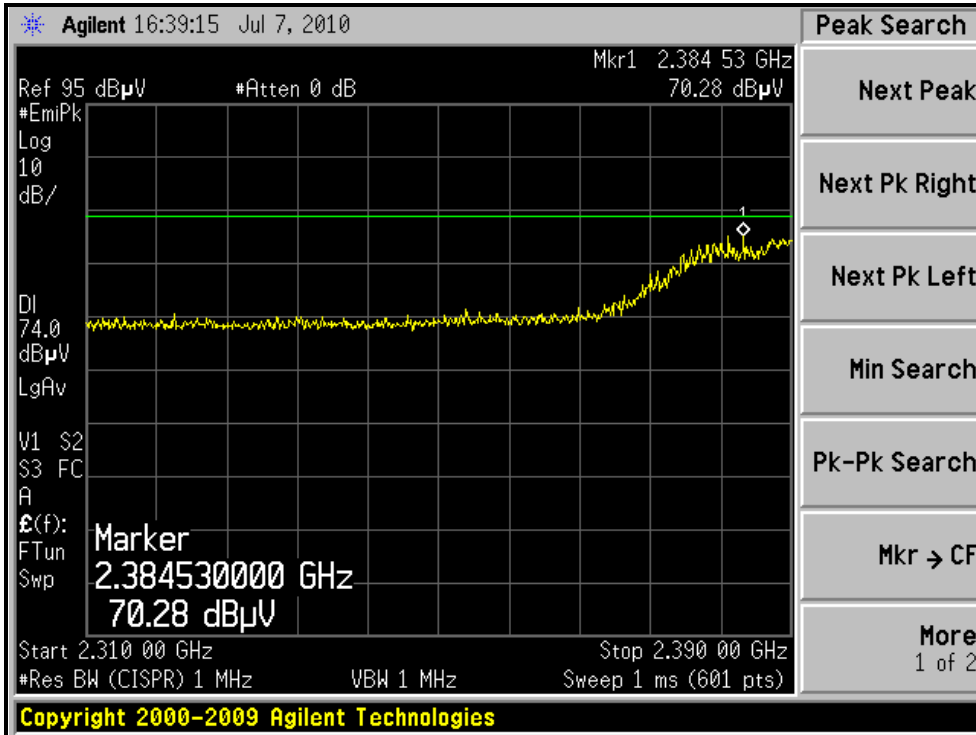



A D T

RESTRICTED BANDEDGE (802.11n (40MHz) MODE,CH7, HORIZONTAL)

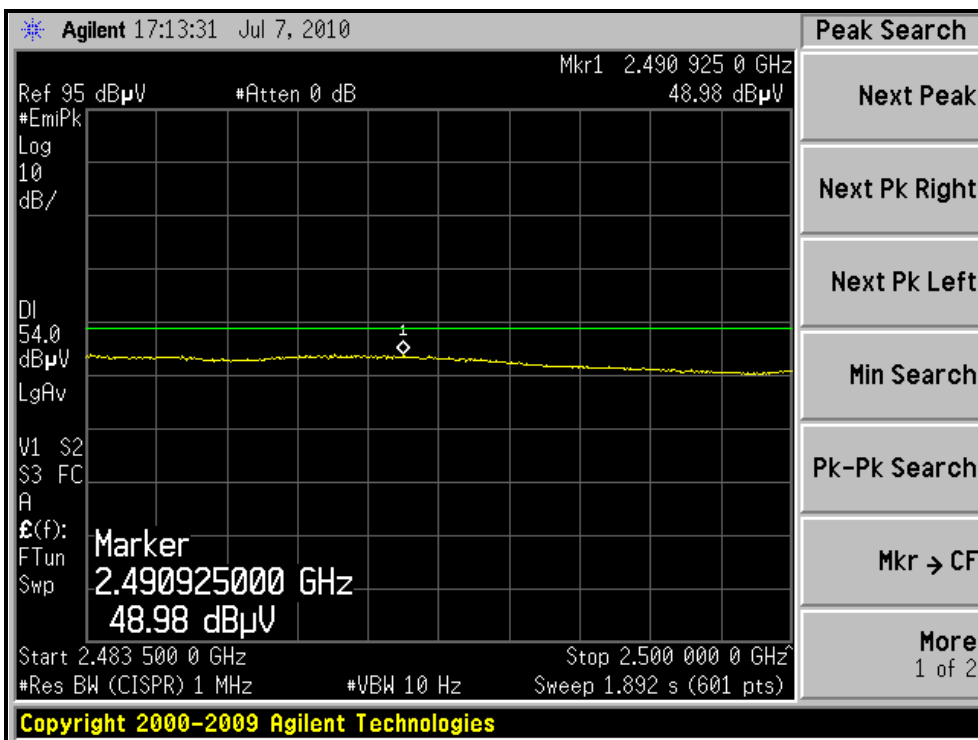
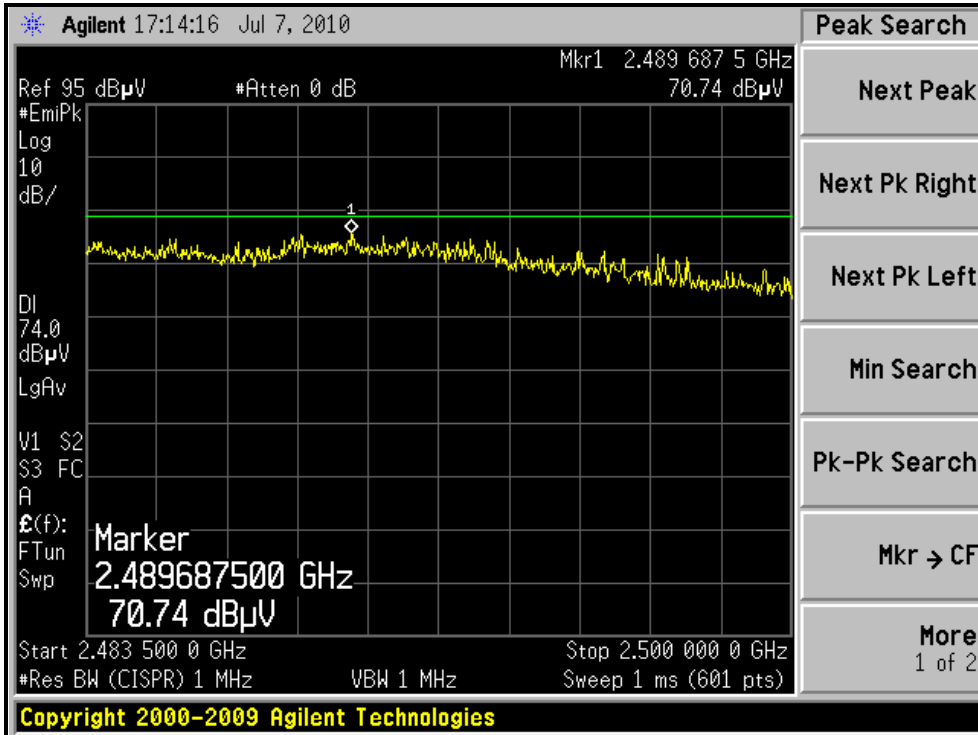



A D T

RESTRICTED BANDEDGE (802.11n (40MHz) MODE,CH7, VERTICAL)

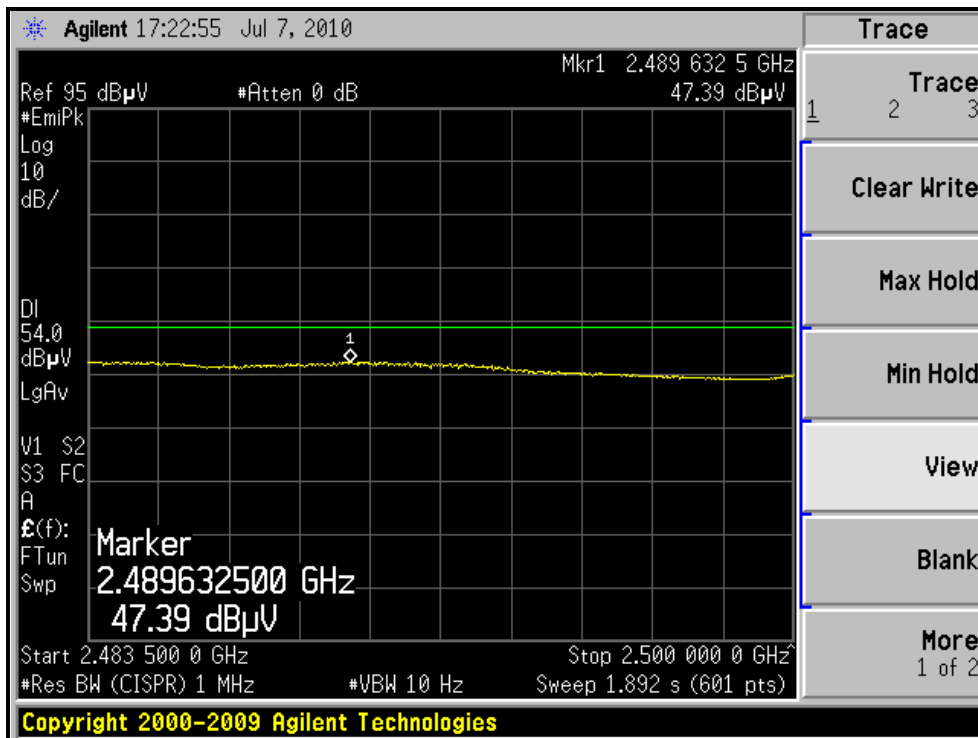
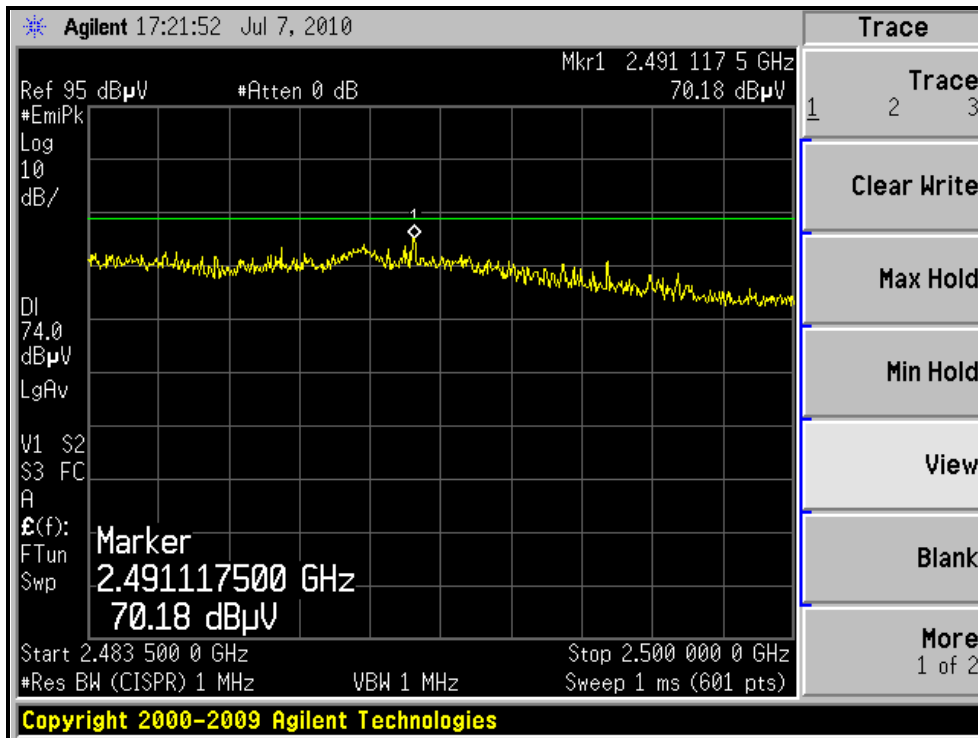

4.3 6dB BANDWIDTH MEASUREMENT

4.3.1 LIMITS OF 6dB BANDWIDTH MEASUREMENT

The minimum of 6dB Bandwidth Measurement is 0.5 MHz.

4.3.2 TEST INSTRUMENTS

| DESCRIPTION & MANUFACTURER | MODEL NO. | SERIAL NO. | CALIBRATED DATE | CALIBRATED UNTIL |
|----------------------------|-----------|------------|-----------------|------------------|
| R&S SPECTRUM ANALYZER | FSP40 | 100037 | Aug. 03, 2009 | Aug. 02, 2010 |

NOTE:

1. The calibration interval of the above test instruments is 12 months and the calibrations are traceable to NML/ROC and NIST/USA.

4.3.3 TEST PROCEDURE

The transmitter output was connected to the spectrum analyzer through an attenuator. The bandwidth of the fundamental frequency was measured by spectrum analyzer with 100kHz RBW and 100kHz VBW. The 6dB bandwidth is defined as the total spectrum the power of which is higher than peak power minus 6dB.

4.3.4 DEVIATION FROM TEST STANDARD

No deviation

4.3.5 TEST SETUP



4.3.6 EUT OPERATING CONDITIONS

The software provided by client to enable the EUT under transmission condition continuously at lowest, middle and highest channel frequencies individually.



A D T

4.3.7 TEST RESULTS

802.11b DSSS MODULATION:

| CHANNEL | CHANNEL FREQUENCY (MHz) | 6dB BANDWIDTH (MHz) | MINIMUM LIMIT (MHz) | PASS / FAIL |
|---------|-------------------------|---------------------|---------------------|-------------|
| 1 | 2412 | 8.08 | 0.5 | PASS |
| 6 | 2437 | 8.36 | 0.5 | PASS |
| 11 | 2462 | 8.22 | 0.5 | PASS |

CH6

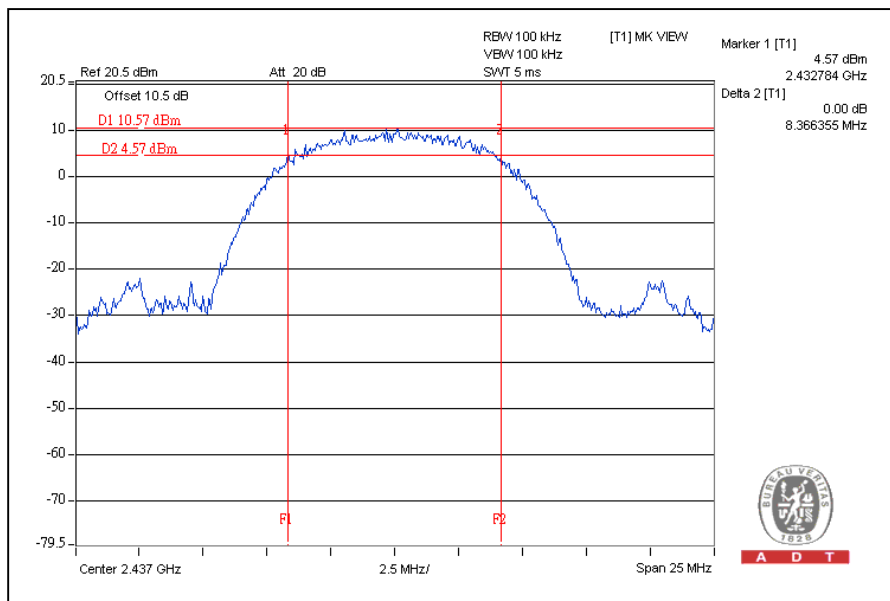



A D T

802.11g OFDM MODULATION:

| CHANNEL | CHANNEL FREQUENCY (MHz) | 6dB BANDWIDTH (MHz) | MINIMUM LIMIT (MHz) | PASS / FAIL |
|---------|-------------------------|---------------------|---------------------|-------------|
| 1 | 2412 | 14.12 | 0.5 | PASS |
| 6 | 2437 | 15.13 | 0.5 | PASS |
| 11 | 2462 | 14.53 | 0.5 | PASS |

CH6





A D T

802.11n (20MHz) OFDM MODULATION:

| CHANNEL | CHANNEL FREQUENCY (MHz) | 6dB BANDWIDTH (MHz) | MINIMUM LIMIT (MHz) | PASS / FAIL |
|---------|-------------------------|---------------------|---------------------|-------------|
| 1 | 2412 | 15.17 | 0.5 | PASS |
| 6 | 2437 | 15.05 | 0.5 | PASS |
| 11 | 2462 | 15.16 | 0.5 | PASS |

CH1

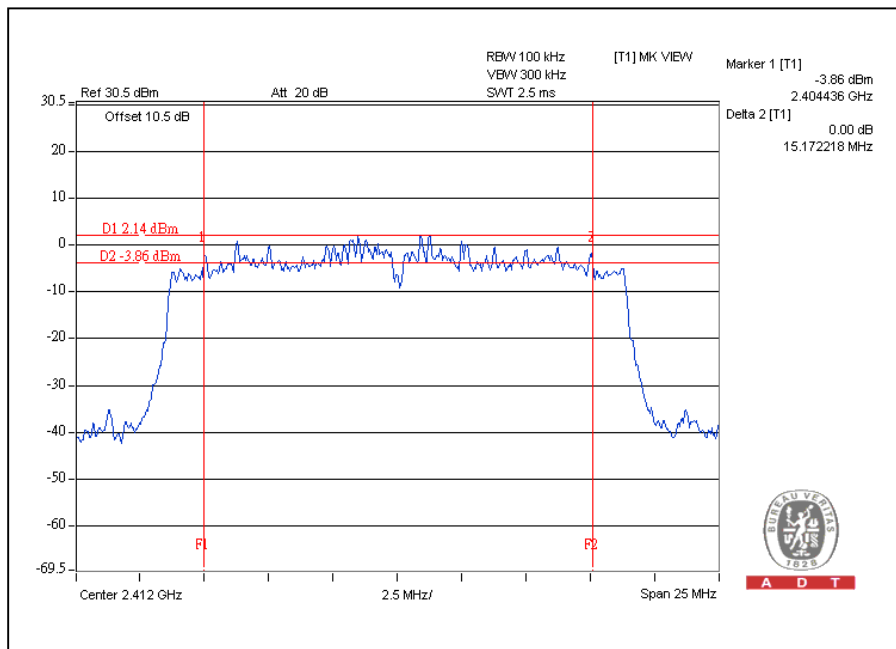



A D T

802.11n (40MHz) OFDM MODULATION:

| CHANNEL | CHANNEL FREQUENCY (MHz) | 6dB BANDWIDTH (MHz) | MINIMUM LIMIT (MHz) | PASS / FAIL |
|---------|-------------------------|---------------------|---------------------|-------------|
| 1 | 2422 | 35.71 | 0.5 | PASS |
| 4 | 2437 | 36.44 | 0.5 | PASS |
| 7 | 2452 | 36.46 | 0.5 | PASS |

CH7

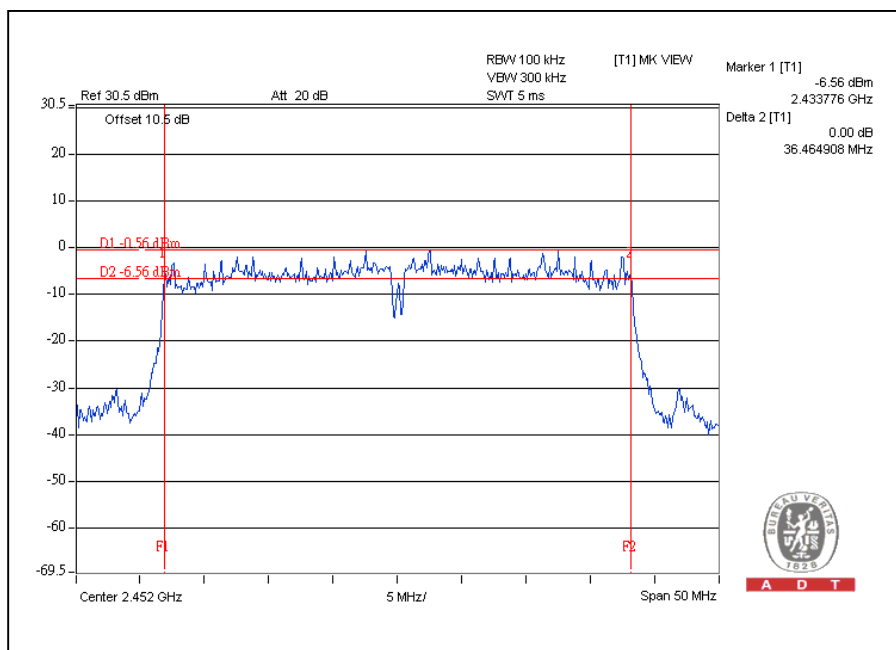

4.4 MAXIMUM PEAK OUTPUT POWER

4.4.1 LIMITS OF MAXIMUM PEAK OUTPUT POWER MEASUREMENT

The Maximum Peak Output Power Measurement is 30dBm.

4.4.2 INSTRUMENTS

| DESCRIPTION & MANUFACTURER | MODEL NO. | SERIAL NO. | CALIBRATED DATE | CALIBRATED UNTIL |
|----------------------------|-----------|------------|-----------------|------------------|
| Anritsu Power Meter | ML2495A | 0824006 | April 24, 2010 | April 23, 2011 |
| Pulse Power Sensor | MA2411B | 0738172 | April 24, 2010 | April 23, 2011 |

NOTE:

The calibration interval of the above test instruments is 12 months and the calibrations are traceable to NML/ROC and NIST/USA.

4.4.3 TEST PROCEDURES

1. The transmitter output was connected to the power meter through an attenuator; the bandwidth of the fundamental frequency was measured with the power meter.
2. Record the power level.

4.4.4 DEVIATION FROM TEST STANDARD

No deviation

4.4.5 TEST SETUP

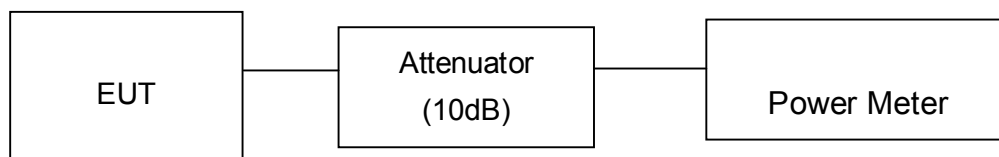

4.4.6 EUT OPERATING CONDITIONS

Same as Item 4.3.6



4.4.7 TEST RESULTS

802.11b DSSS MODULATION:

| CHANNEL | CHANNEL FREQUENCY (MHz) | PEAK POWER OUTPUT (dBm) | PEAK POWER OUTPUT (mW) | PEAK POWER LIMIT (dBm) | PASS / FAIL |
|---------|-------------------------|-------------------------|------------------------|------------------------|-------------|
| 1 | 2412 | 23.4 | 218.8 | 30 | PASS |
| 6 | 2437 | 23.3 | 213.8 | 30 | PASS |
| 11 | 2462 | 22.9 | 195.0 | 30 | PASS |

802.11g OFDM MODULATION:

| CHANNEL | CHANNEL FREQUENCY (MHz) | PEAK POWER OUTPUT (dBm) | PEAK POWER OUTPUT (mW) | PEAK POWER LIMIT (dBm) | PASS / FAIL |
|---------|-------------------------|-------------------------|------------------------|------------------------|-------------|
| 1 | 2412 | 22.8 | 190.5 | 30 | PASS |
| 6 | 2437 | 25.4 | 346.7 | 30 | PASS |
| 11 | 2462 | 21.2 | 131.8 | 30 | PASS |

802.11n (20MHz) OFDM MODULATION:

| CHANNEL | CHANNEL FREQUENCY (MHz) | PEAK POWER OUTPUT (dBm) | | TOTAL PEAK POWER (mW) | TOTAL PEAK POWER (dBm) | PEAK POWER LIMIT (dBm) | PASS / FAIL |
|---------|-------------------------|-------------------------|----------|-----------------------|------------------------|------------------------|-------------|
| | | CHAIN(0) | CHAIN(1) | | | | |
| 1 | 2412 | 21.7 | 22.1 | 310.1 | 24.9 | 30 | PASS |
| 6 | 2437 | 25.0 | 25.2 | 647.4 | 28.1 | 30 | PASS |
| 11 | 2462 | 21.8 | 22.9 | 346.3 | 25.4 | 30 | PASS |



A D T

802.11n (40MHz) OFDM MODULATION:

| CHANNEL | CHANNEL FREQUENCY (MHz) | PEAK POWER OUTPUT (dBm) | | TOTAL PEAK POWER (mW) | TOTAL PEAK POWER (dBm) | PEAK POWER LIMIT (dBm) | PASS / FAIL |
|---------|-------------------------|-------------------------|----------|-----------------------|------------------------|------------------------|-------------|
| | | CHAIN(0) | CHAIN(1) | | | | |
| 1 | 2422 | 20.4 | 22.2 | 275.6 | 24.4 | 30 | PASS |
| 4 | 2437 | 22.6 | 20.8 | 302.2 | 24.8 | 30 | PASS |
| 7 | 2452 | 22.0 | 23.5 | 382.4 | 25.8 | 30 | PASS |

4.5 POWER SPECTRAL DENSITY MEASUREMENT

4.5.1 LIMITS OF POWER SPECTRAL DENSITY MEASUREMENT

The Maximum of Power Spectral Density Measurement is 8dBm.

4.5.2 TEST INSTRUMENTS

| DESCRIPTION & MANUFACTURER | MODEL NO. | SERIAL NO. | CALIBRATED DATE | CALIBRATED UNTIL |
|----------------------------|-----------|------------|-----------------|------------------|
| R&S SPECTRUM ANALYZER | FSP40 | 100037 | Aug. 03, 2009 | Aug. 02, 2010 |

NOTE:

1. The calibration interval of the above test instruments is 12 months and the calibrations are traceable to NML/ROC and NIST/USA.

4.5.3 TEST PROCEDURE

The transmitter output was connected to the spectrum analyzer through an attenuator, the bandwidth of the fundamental frequency was measured with the spectrum analyzer using 3kHz RBW and 30kHz VBW, set sweep time = span/3kHz. The power spectral density was measured and recorded.

The sweep time is allowed to be longer than span/3kHz for a full response of the mixer in the spectrum analyzer.

4.5.4 DEVIATION FROM TEST STANDARD

No deviation

4.5.5 TEST SETUP

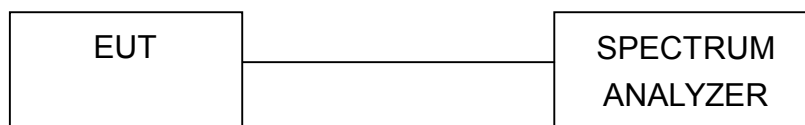

4.5.6 EUT OPERATING CONDITION

Same as Item 4.3.6



A D T

4.5.7 TEST RESULTS

802.11b DSSS MODULATION:

| CHANNEL | CHANNEL FREQUENCY (MHz) | RF POWER LEVEL IN 3kHz BW (dBm) | MAXIMUM LIMIT (dBm) | PASS / FAIL |
|---------|--------------------------|---------------------------------|---------------------|-------------|
| 1 | 2412 | -4.0 | 8 | PASS |
| 6 | 2437 | -3.8 | 8 | PASS |
| 11 | 2462 | -4.9 | 8 | PASS |

CH6

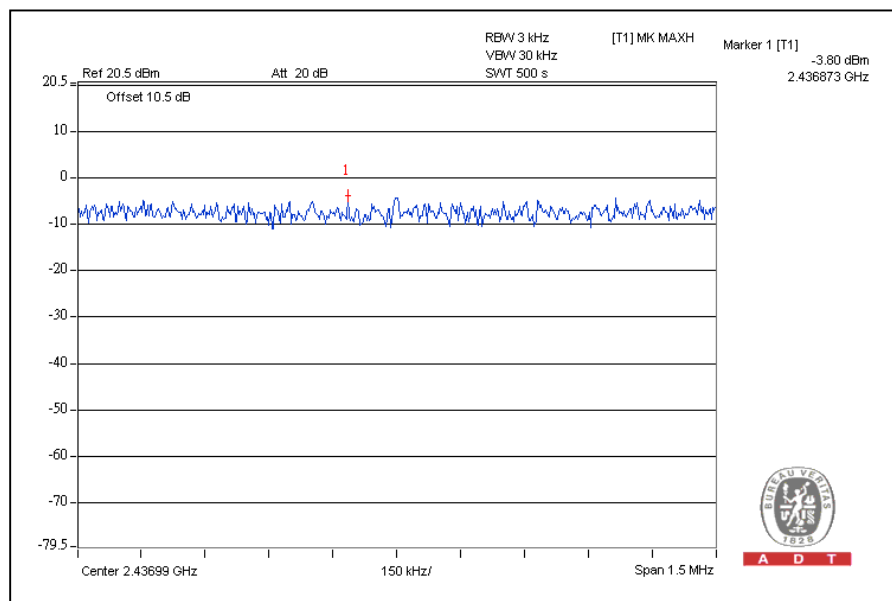



A D T

802.11g OFDM MODULATION:

| CHANNEL | CHANNEL FREQUENCY (MHz) | RF POWER LEVEL IN 3kHz BW (dBm) | MAXIMUM LIMIT (dBm) | PASS / FAIL |
|---------|-------------------------|---------------------------------|---------------------|-------------|
| 1 | 2412 | -6.6 | 8 | PASS |
| 6 | 2437 | -6.1 | 8 | PASS |
| 11 | 2462 | -13.2 | 8 | PASS |

CH6

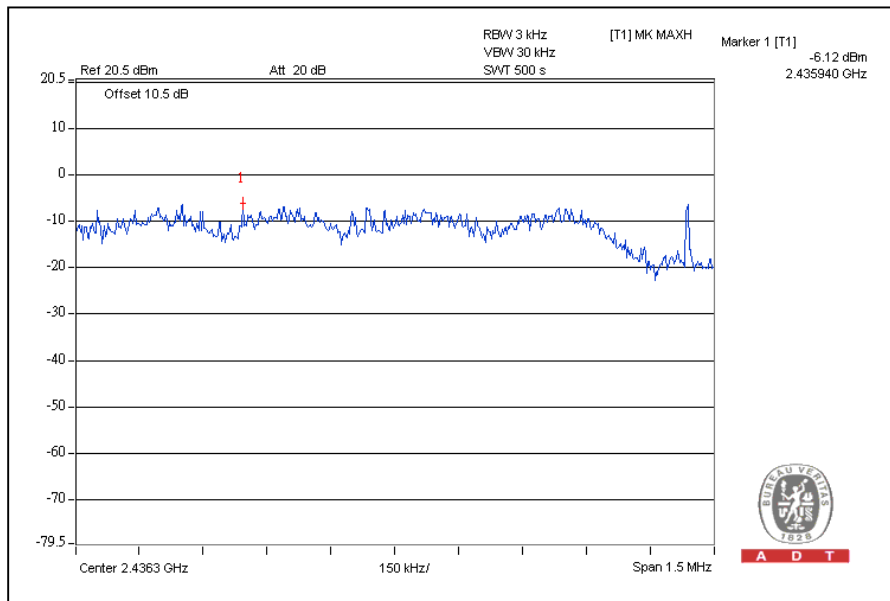

802.11n (20MHz) OFDM MODULATION:

| CHANNEL | CHANNEL FREQUENCY (MHz) | RF POWER LEVEL IN 3kHz BW (dBm) | | TOTAL POWER DENSITY (dBm) | MAXIMUM LIMIT (dBm) | PASS / FAIL |
|---------|-------------------------|---------------------------------|----------|---------------------------|---------------------|-------------|
| | | CHAIN(0) | CHAIN(1) | | | |
| 1 | 2412 | -12.3 | -12.1 | -9.2 | 8 | PASS |
| 6 | 2437 | -6.3 | -7.3 | -3.8 | 8 | PASS |
| 11 | 2462 | -10.8 | -12.4 | -8.5 | 8 | PASS |

For Chain(0): CH6

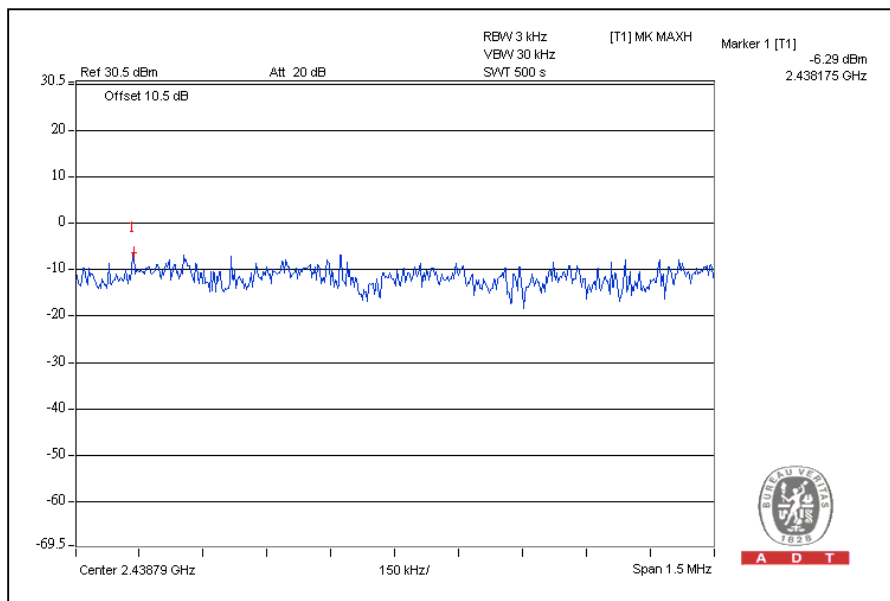

802.11n (40MHz) OFDM MODULATION:

| CHANNEL | CHANNEL FREQUENCY (MHz) | RF POWER LEVEL IN 3kHz BW (dBm) | | TOTAL POWER DENSITY (dBm) | MAXIMUM LIMIT (dBm) | PASS / FAIL |
|---------|-------------------------|---------------------------------|----------|---------------------------|---------------------|-------------|
| | | CHAIN(0) | CHAIN(1) | | | |
| 1 | 2422 | -12.5 | -12.4 | -9.4 | 8 | PASS |
| 4 | 2437 | -11.4 | -13.6 | -9.4 | 8 | PASS |
| 7 | 2452 | -10.8 | -10.7 | -7.7 | 8 | PASS |

For Chain (1): CH7

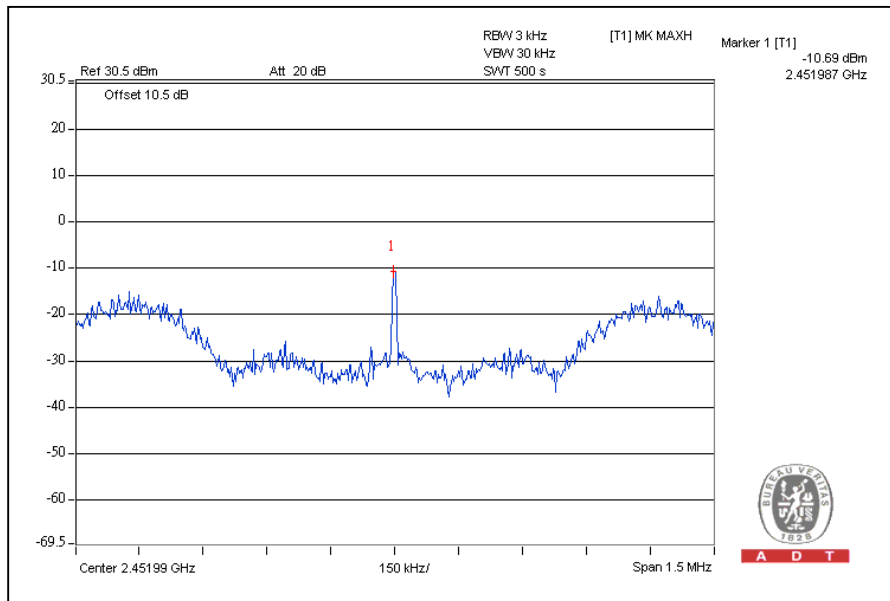



A D T

4.6 CONDUCTED OUT-BAND EMISSION MEASUREMENT

4.6.1 LIMITS OF CONDUCTED OUT-BAND EMISSION MEASUREMENT

Below -20dB of the highest emission level of operating band (in 100kHz Resolution Bandwidth).

4.6.2 TEST INSTRUMENTS

| DESCRIPTION & MANUFACTURER | MODEL NO. | SERIAL NO. | CALIBRATED DATE | CALIBRATED UNTIL |
|----------------------------|-----------|------------|-----------------|------------------|
| R&S SPECTRUM ANALYZER | FSP40 | 100037 | Aug. 03, 2009 | Aug. 02, 2010 |

NOTE:

1. The calibration interval of the above test instruments is 12 months and the calibrations are traceable to NML/ROC and NIST/USA.

4.6.3 TEST PROCEDURE

The transmitter output was connected to the spectrum analyzer via a low loss cable. Set RBW of spectrum analyzer to 100kHz and VBW of spectrum analyzer to 300kHz with suitable frequency span including 100 MHz bandwidth from band edge. The band edges was measured and recorded.

The spectrum plots (RBW = 100kHz, VBW = 300kHz) are attached on the following pages.

4.6.4 DEVIATION FROM TEST STANDARD

No deviation

4.6.5 EUT OPERATING CONDITION

Same as Item 4.3.6

4.6.6 TEST RESULTS

The spectrum plots are attached on the following images. D1 line indicates the highest level, and D2 line indicates the 20dB offset below D1. It shows compliance with the requirement in part 15.247(d).

802.11b DSSS MODULATION:

CH1

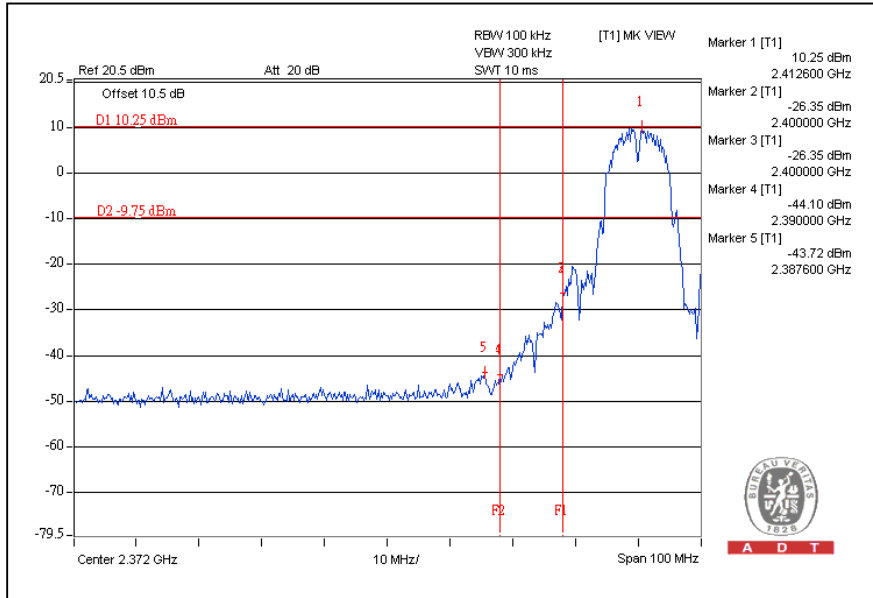

CH11

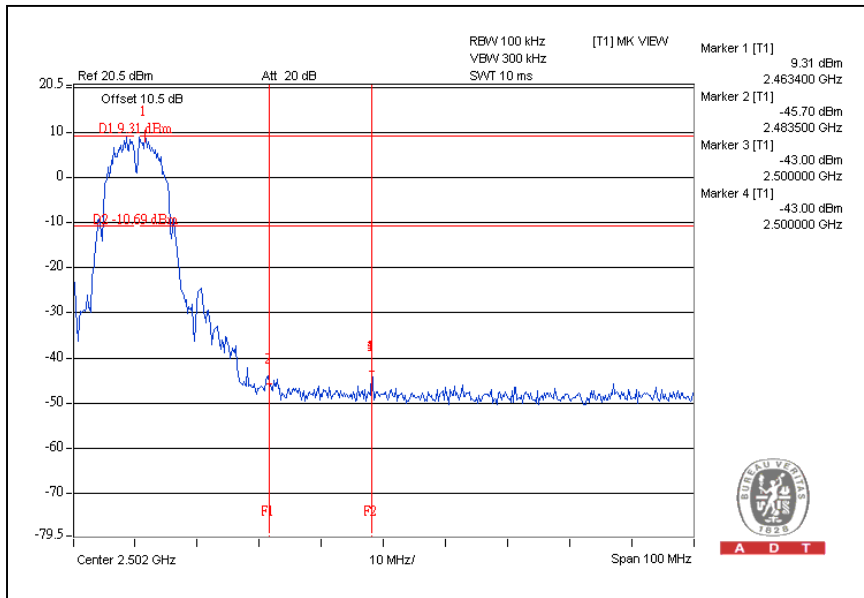



A D T

CH1

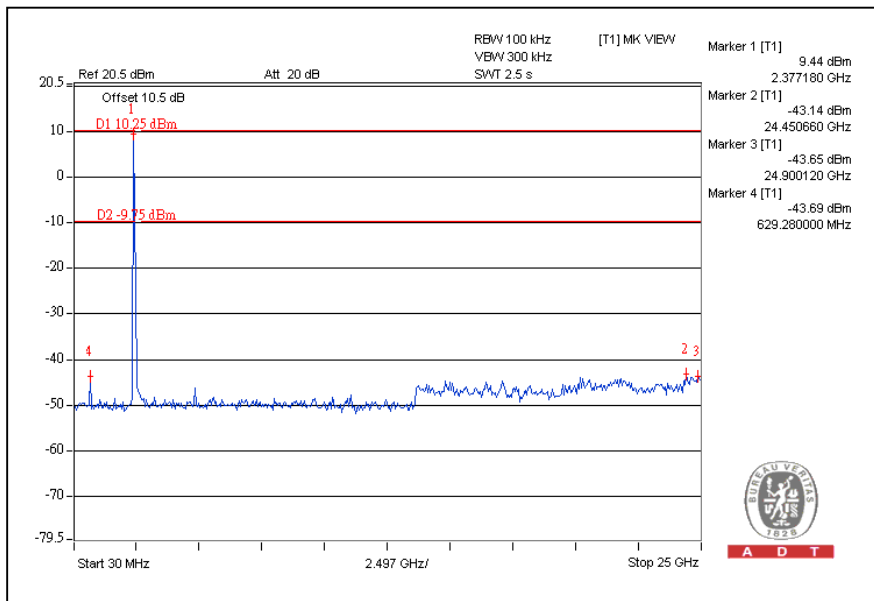

CH11

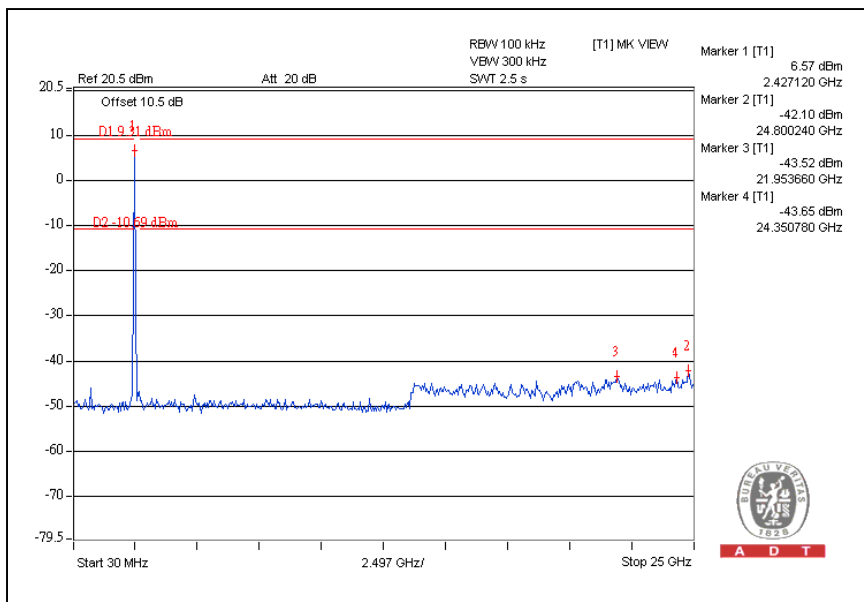

802.11g OFDM MODULATION:

CH1

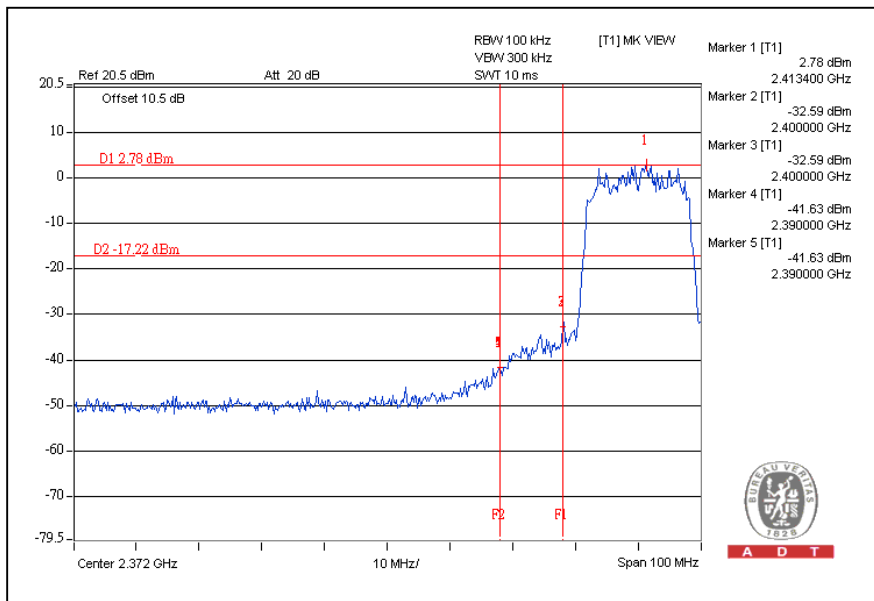

CH11

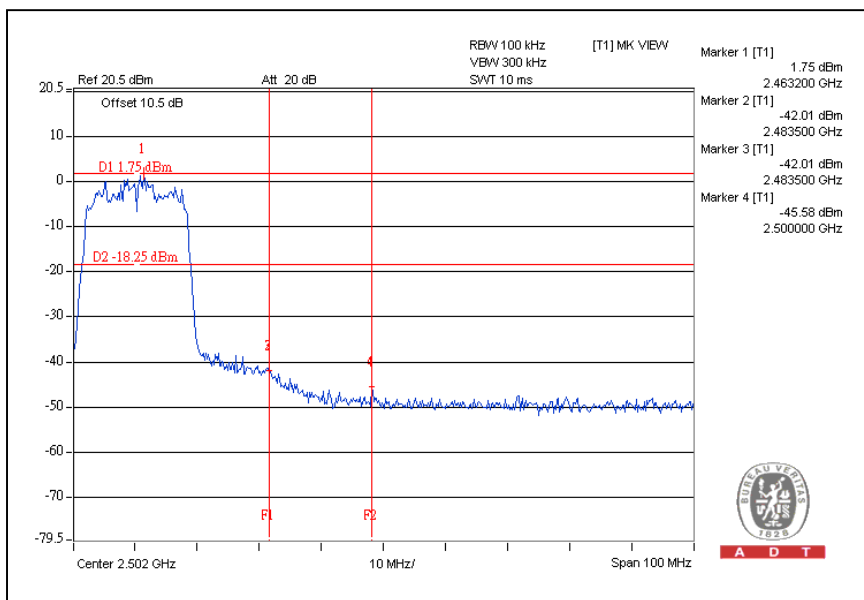

CH1

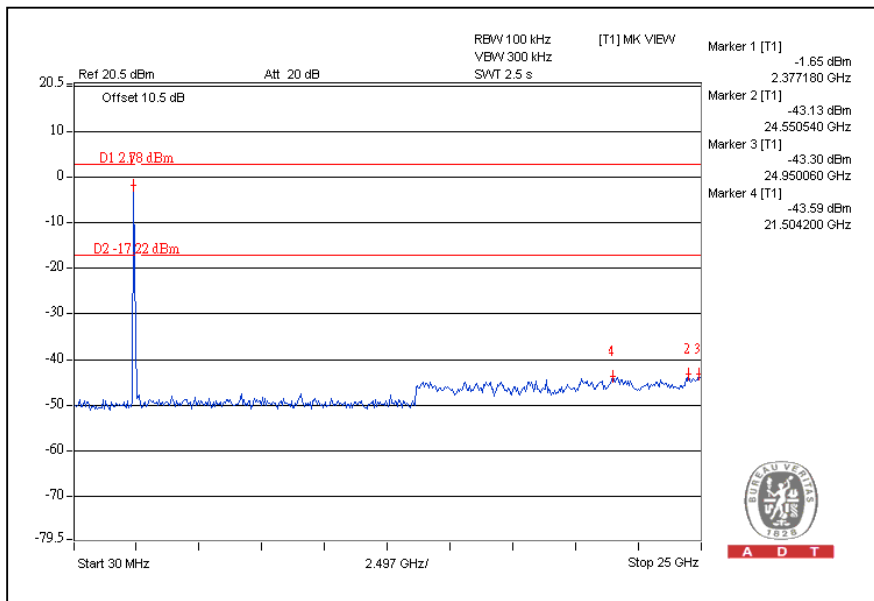

CH11

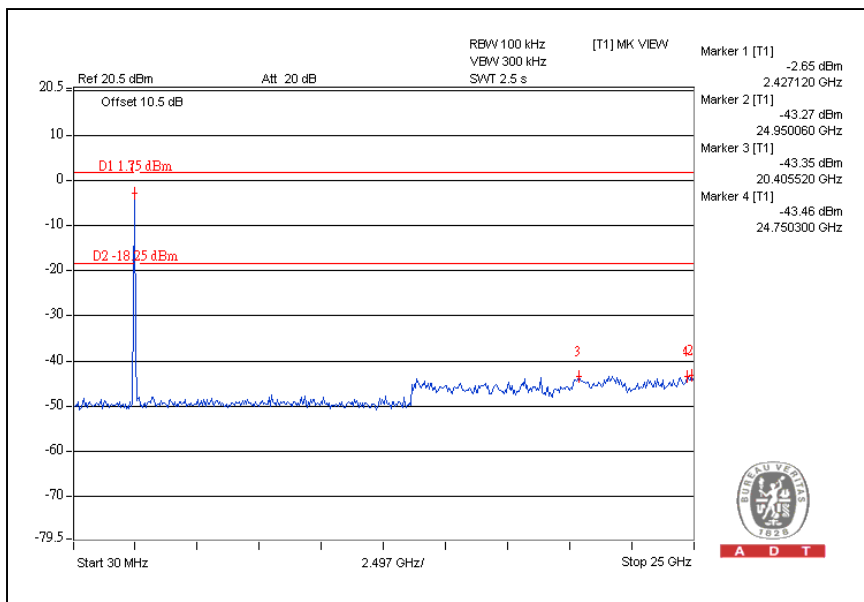

802.11n (20MHz) OFDM MODULATION:

CH1

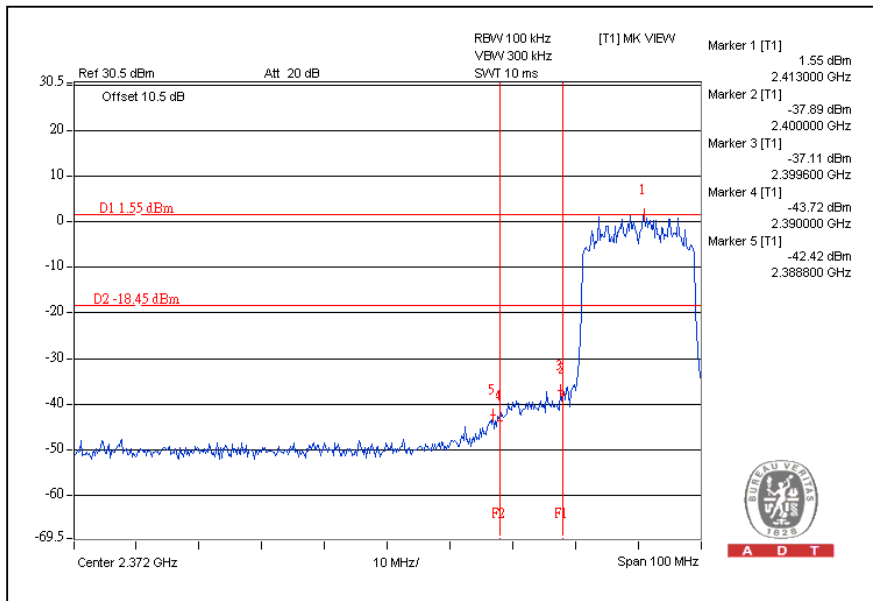

CH11

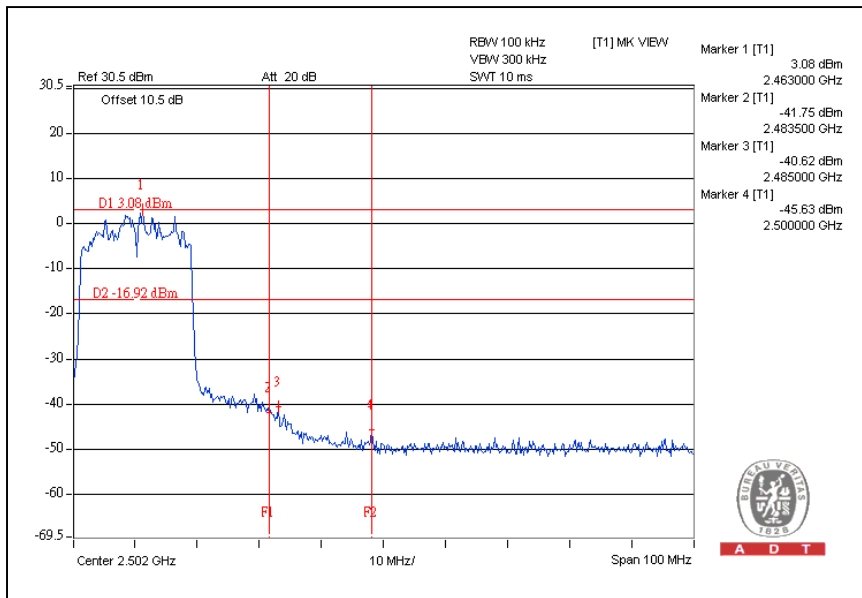



A D T

CH1

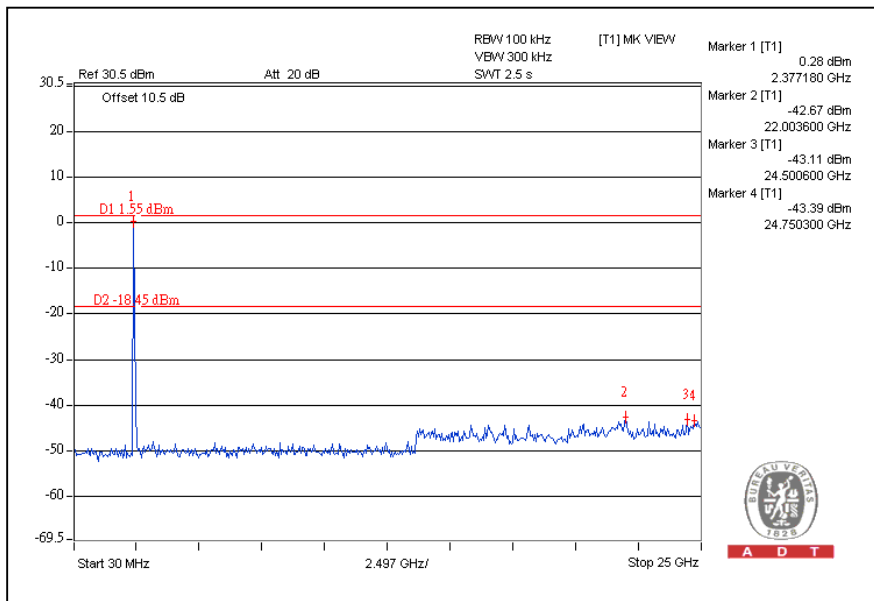

CH11

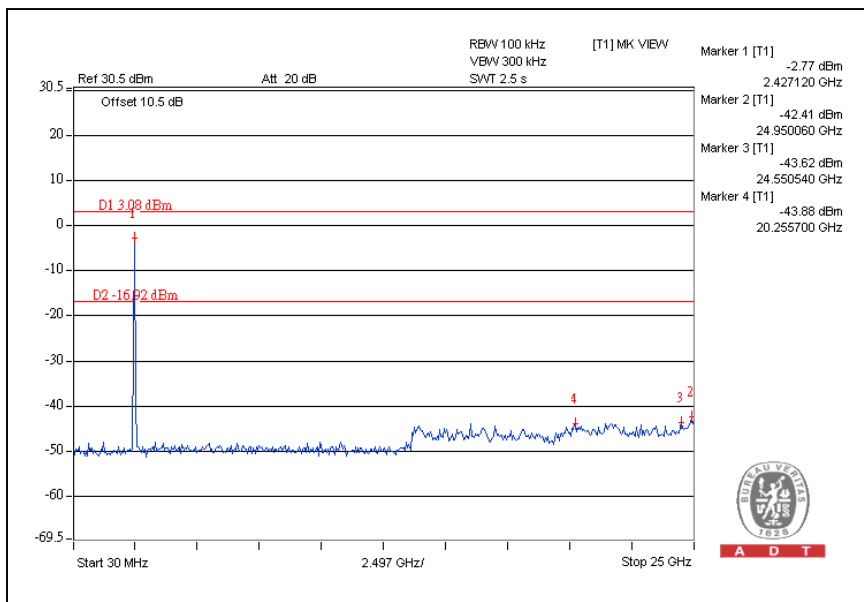

802.11n (40MHz) OFDM MODULATION:

CH1

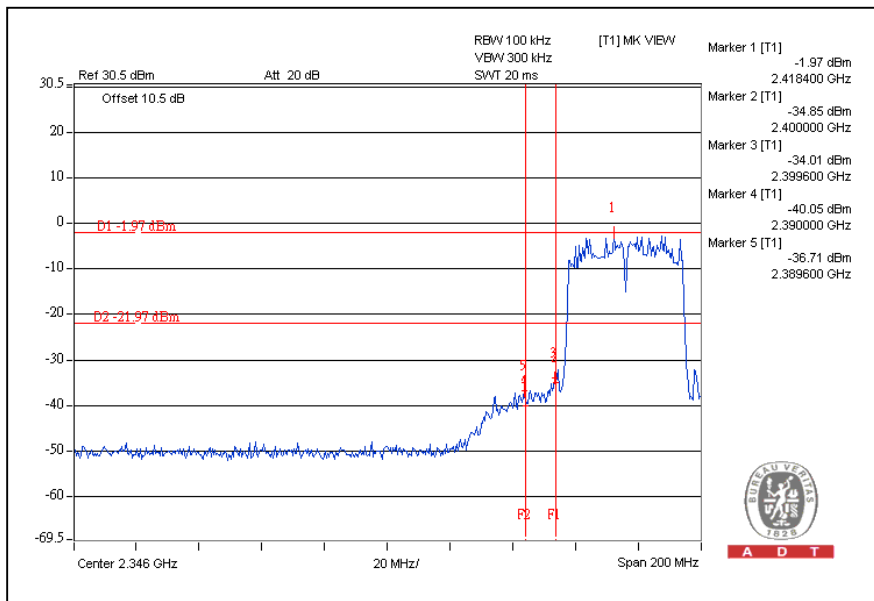

CH7

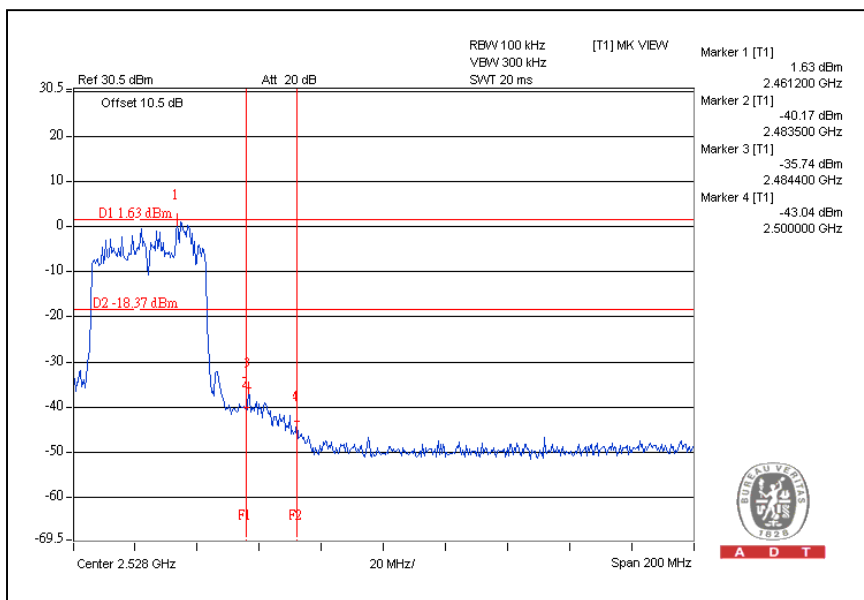



A D T

CH1

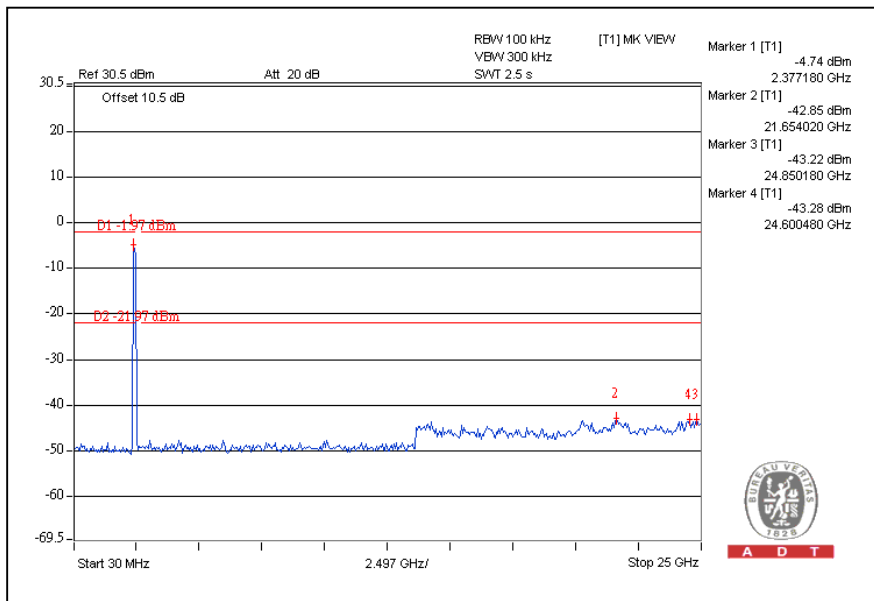

CH7

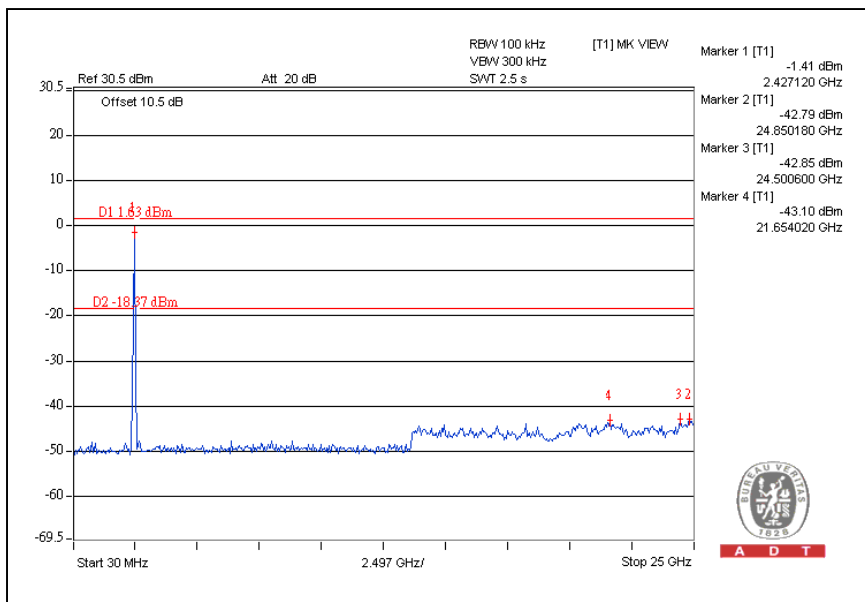



A D T

5. TEST TYPES AND RESULTS (802.11a, 5725~5850MHz Band)

5.1 CONDUCTED EMISSION MEASUREMENT

5.1.1 LIMITS OF CONDUCTED EMISSION MEASUREMENT

| FREQUENCY OF EMISSION (MHz) | CONDUCTED LIMIT (dBµV) | |
|-----------------------------|------------------------|----------|
| | Quasi-peak | Average |
| 0.15-0.5 | 66 to 56 | 56 to 46 |
| 0.5-5 | 56 | 46 |
| 5-30 | 60 | 50 |

- NOTE:**
1. The lower limit shall apply at the transition frequencies.
 2. The limit decreases in line with the logarithm of the frequency in the range of 0.15 to 0.50 MHz.
 3. All emanations from a class A/B digital device or system, including any network of conductors and apparatus connected thereto, shall not exceed the level of field strengths specified above.

5.1.2 TEST INSTRUMENTS

| DESCRIPTION & MANUFACTURER | MODEL NO. | SERIAL NO. | CALIBRATED DATE | CALIBRATED UNTIL |
|---|------------------------|------------|-----------------|------------------|
| ROHDE & SCHWARZ Test Receiver | ESCS 30 | 100287 | Mar. 01, 2010 | Feb. 28, 2011 |
| Line-Impedance Stabilization Network (for EUT) | NSLK 8127 | 8127-523 | Sep. 23, 2009 | Sep. 22, 2010 |
| Line-Impedance Stabilization Network (for Peripheral) | ENV-216 | 100072 | June 11, 2010 | June 10, 2011 |
| RF Cable (JYEBAO) | 5DFB | COACAB-001 | Dec. 14, 2009 | Dec. 13, 2010 |
| 50 ohms Terminator | 50 | 3 | Oct. 28, 2009 | Oct. 27, 2010 |
| Software | BV ADT_ Cond_V7.3.7 | NA | NA | NA |

Note:

1. The calibration interval of the above test instruments is 12 months and the calibrations are traceable to NML/ROC and NIST/USA.
2. The test was performed in Shielded Room No. A.
3. The VCCI Con A Registration No. is C-817.

5.1.3 TEST PROCEDURES

- a. The EUT was placed 0.4 meters from the conducting wall of the shielded room with EUT being connected to the power mains through a line impedance stabilization network (LISN). Other support units were connected to the power mains through another LISN. The two LISNs provide 50 ohm/ 50uH of coupling impedance for the measuring instrument.
- b. Both lines of the power mains connected to the EUT were checked for maximum conducted interference.
- c. The frequency range from 150kHz to 30MHz was searched. Emission levels under (Limit – 20dB) were not recorded.

5.1.4 DEVIATION FROM TEST STANDARD

No deviation

5.1.5 TEST SETUP

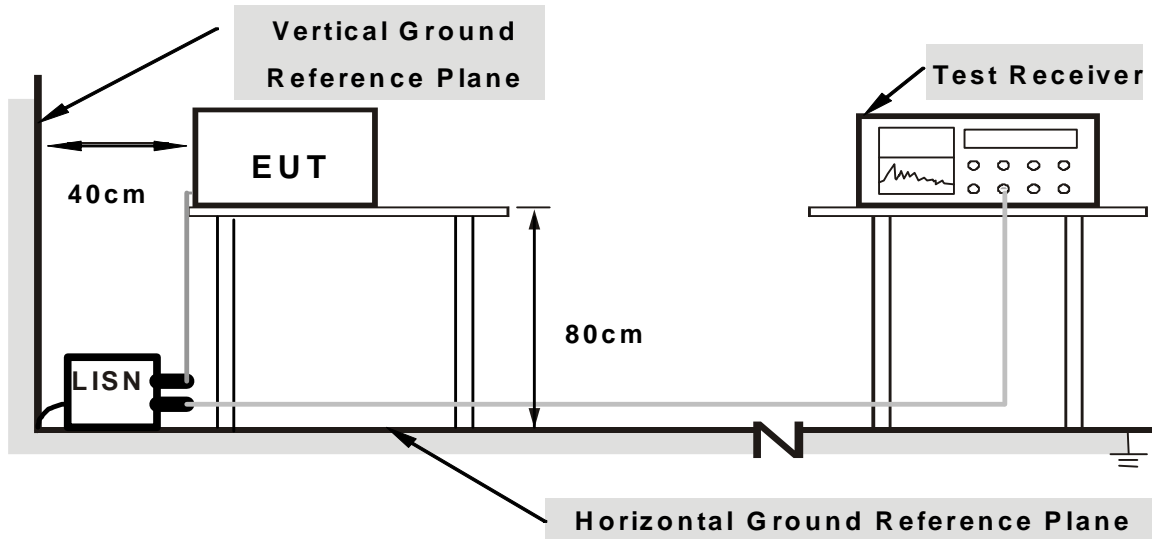

Note: 1. Support units were connected to second LISN.

2. Both of LISNs (AMN) are 80 cm from EUT and at least 80 from other units and other metal planes

For the actual test configuration, please refer to the related item – Photographs of the Test Configuration.

5.1.6 EUT OPERATING CONDITIONS

Same as the 4.1.6

5.1.7 TEST RESULTS

802.11n (20MHz) OFDM MODULATION:

| | | | |
|------------------|------------------------------|----------------------|-------|
| PHASE | Line (L) | 6dB BANDWIDTH | 9 kHz |
| TEST MODE | With Internal power supply 1 | | |

| No | Freq. [MHz] | Corr. Factor (dB) | Reading Value [dB (uV)] | | Emission Level [dB (uV)] | | Limit [dB (uV)] | | Margin (dB) | |
|----|-------------|-------------------|-------------------------|-------|--------------------------|-------|-----------------|-------|-------------|--------|
| | | | Q.P. | AV. | Q.P. | AV. | Q.P. | AV. | Q.P. | AV. |
| 1 | 0.150 | 0.03 | 46.95 | - | 46.98 | - | 66.00 | 56.00 | -19.02 | - |
| 2 | 0.205 | 0.04 | 46.24 | - | 46.28 | - | 63.42 | 53.42 | -17.14 | - |
| 3 | 0.826 | 0.16 | 42.66 | - | 42.82 | - | 56.00 | 46.00 | -13.18 | - |
| 4 | 2.535 | 0.22 | 45.42 | - | 45.64 | - | 56.00 | 46.00 | -10.36 | - |
| 5 | 2.895 | 0.21 | 45.85 | 32.82 | 46.06 | 33.03 | 56.00 | 46.00 | -9.94 | -12.97 |
| 6 | 12.574 | 0.52 | 41.94 | - | 42.46 | - | 60.00 | 50.00 | -17.54 | - |

- REMARKS:**
1. Q.P. and AV. are abbreviations of quasi-peak and average individually.
 2. "-": The Quasi-peak reading value also meets average limit and measurement with the average detector is unnecessary.
 3. The emission levels of other frequencies were very low against the limit.
 4. Margin value = Emission level - Limit value
 5. Correction factor = Insertion loss + Cable loss
 6. Emission Level = Correction Factor + Reading Value.

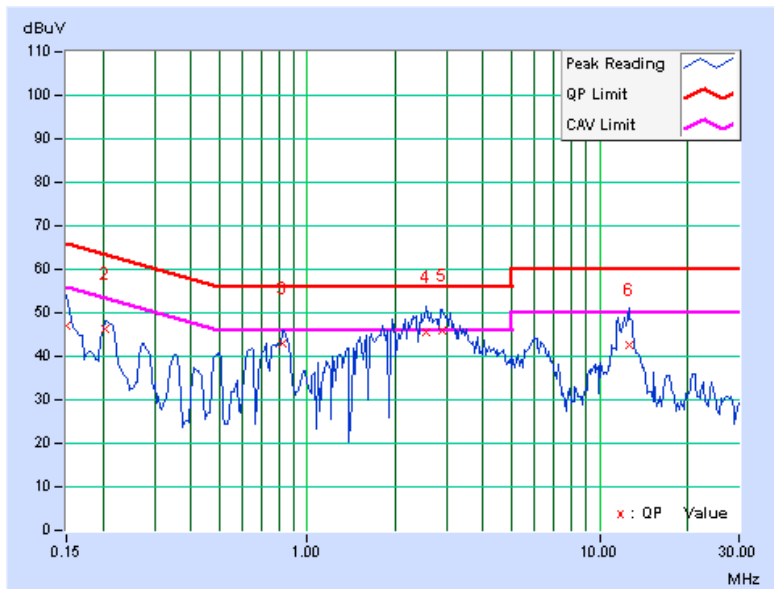

| | | | |
|------------------|------------------------------|----------------------|-------|
| PHASE | Neutral (N) | 6dB BANDWIDTH | 9 kHz |
| TEST MODE | With Internal power supply 1 | | |

| No | Freq. | Corr. | Reading Value | | Emission Level | | Limit | | Margin | |
|----------|--------------|-------------|---------------|--------------|----------------|--------------|--------------|--------------|--------------|---------------|
| | [MHz] | Factor | [dB (uV)] | | [dB (uV)] | | [dB (uV)] | | (dB) | |
| | | (dB) | Q.P. | AV. | Q.P. | AV. | Q.P. | AV. | Q.P. | AV. |
| 1 | 0.150 | 0.04 | 45.98 | - | 46.02 | - | 66.00 | 56.00 | -19.98 | - |
| 2 | 0.642 | 0.12 | 40.83 | - | 40.95 | - | 56.00 | 46.00 | -15.05 | - |
| 3 | 0.834 | 0.18 | 43.77 | - | 43.95 | - | 56.00 | 46.00 | -12.05 | - |
| 4 | 2.371 | 0.23 | 45.84 | 32.78 | 46.07 | 33.01 | 56.00 | 46.00 | -9.93 | -12.99 |
| 5 | 2.973 | 0.23 | 45.79 | 31.63 | 46.02 | 31.86 | 56.00 | 46.00 | -9.98 | -14.14 |
| 6 | 12.047 | 0.54 | 40.68 | - | 41.22 | - | 60.00 | 50.00 | -18.78 | - |

- REMARKS:**
1. Q.P. and AV. are abbreviations of quasi-peak and average individually.
 2. "-": The Quasi-peak reading value also meets average limit and measurement with the average detector is unnecessary.
 3. The emission levels of other frequencies were very low against the limit.
 4. Margin value = Emission level - Limit value
 5. Correction factor = Insertion loss + Cable loss
 6. Emission Level = Correction Factor + Reading Value.

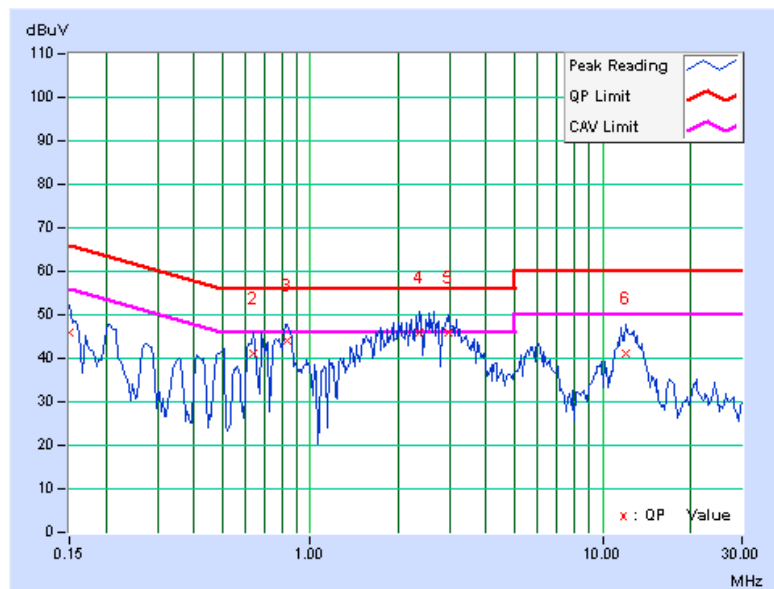

| | | | |
|------------------|------------------------------|----------------------|-------|
| PHASE | Line (L) | 6dB BANDWIDTH | 9 kHz |
| TEST MODE | With Internal power supply 2 | | |

| No | Freq. [MHz] | Corr. Factor (dB) | Reading Value | | Emission Level | | Limit | | Margin | |
|----|----------------|-------------------------|---------------|-----|----------------|-----|-----------|-------|--------|-----|
| | | | [dB (uV)] | | [dB (uV)] | | [dB (uV)] | | (dB) | |
| | | | Q.P. | AV. | Q.P. | AV. | Q.P. | AV. | Q.P. | AV. |
| 1 | 0.177 | 0.04 | 52.26 | - | 52.30 | - | 64.60 | 54.60 | -12.31 | - |
| 2 | 0.240 | 0.04 | 45.57 | - | 45.61 | - | 62.10 | 52.10 | -16.49 | - |
| 3 | 0.869 | 0.17 | 22.94 | - | 23.11 | - | 56.00 | 46.00 | -32.89 | - |
| 4 | 2.562 | 0.22 | 29.48 | - | 29.70 | - | 56.00 | 46.00 | -26.30 | - |
| 5 | 15.395 | 0.46 | 37.47 | - | 37.93 | - | 60.00 | 50.00 | -22.07 | - |
| 6 | 17.641 | 0.53 | 35.42 | - | 35.95 | - | 60.00 | 50.00 | -24.05 | - |
| 7 | 22.746 | 0.63 | 34.26 | - | 34.89 | - | 60.00 | 50.00 | -25.11 | - |

- REMARKS:**
1. Q.P. and AV. are abbreviations of quasi-peak and average individually.
 2. "-": The Quasi-peak reading value also meets average limit and measurement with the average detector is unnecessary.
 3. The emission levels of other frequencies were very low against the limit.
 4. Margin value = Emission level - Limit value
 5. Correction factor = Insertion loss + Cable loss
 6. Emission Level = Correction Factor + Reading Value.

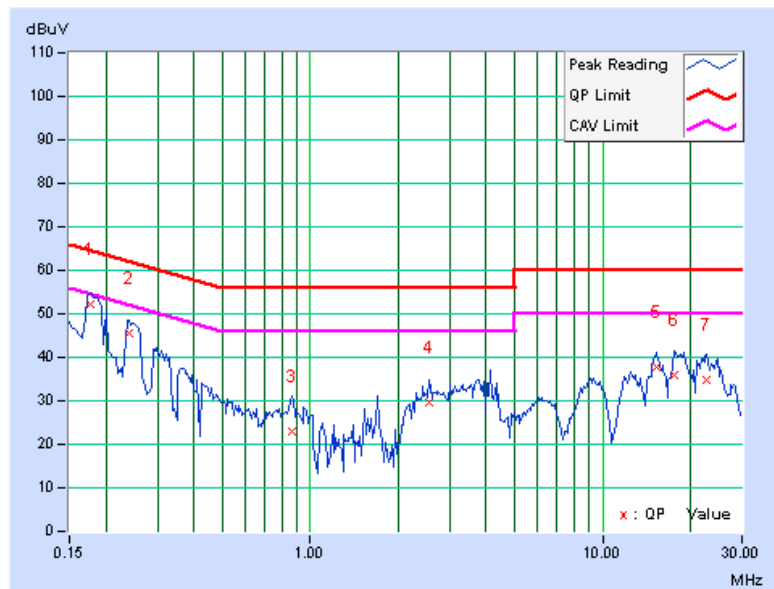

| | | | |
|------------------|------------------------------|----------------------|-------|
| PHASE | Neutral (N) | 6dB BANDWIDTH | 9 kHz |
| TEST MODE | With Internal power supply 2 | | |

| No | Freq. [MHz] | Corr. Factor (dB) | Reading Value [dB (uV)] | | Emission Level [dB (uV)] | | Limit [dB (uV)] | | Margin (dB) | |
|----|----------------|-------------------------|----------------------------|-----|-----------------------------|-----|--------------------|-------|----------------|-----|
| | | | Q.P. | AV. | Q.P. | AV. | Q.P. | AV. | Q.P. | AV. |
| 1 | 0.178 | 0.05 | 53.26 | - | 53.31 | - | 64.60 | 54.60 | -11.29 | - |
| 2 | 0.235 | 0.05 | 46.63 | - | 46.68 | - | 62.26 | 52.26 | -15.58 | - |
| 3 | 3.926 | 0.21 | 31.74 | - | 31.95 | - | 56.00 | 46.00 | -24.05 | - |
| 4 | 15.356 | 0.47 | 39.69 | - | 40.16 | - | 60.00 | 50.00 | -19.84 | - |
| 5 | 18.203 | 0.56 | 37.26 | - | 37.82 | - | 60.00 | 50.00 | -22.18 | - |
| 6 | 21.836 | 0.64 | 35.27 | - | 35.91 | - | 60.00 | 50.00 | -24.09 | - |

- REMARKS:**
1. Q.P. and AV. are abbreviations of quasi-peak and average individually.
 2. "-": The Quasi-peak reading value also meets average limit and measurement with the average detector is unnecessary.
 3. The emission levels of other frequencies were very low against the limit.
 4. Margin value = Emission level - Limit value
 5. Correction factor = Insertion loss + Cable loss
 6. Emission Level = Correction Factor + Reading Value.

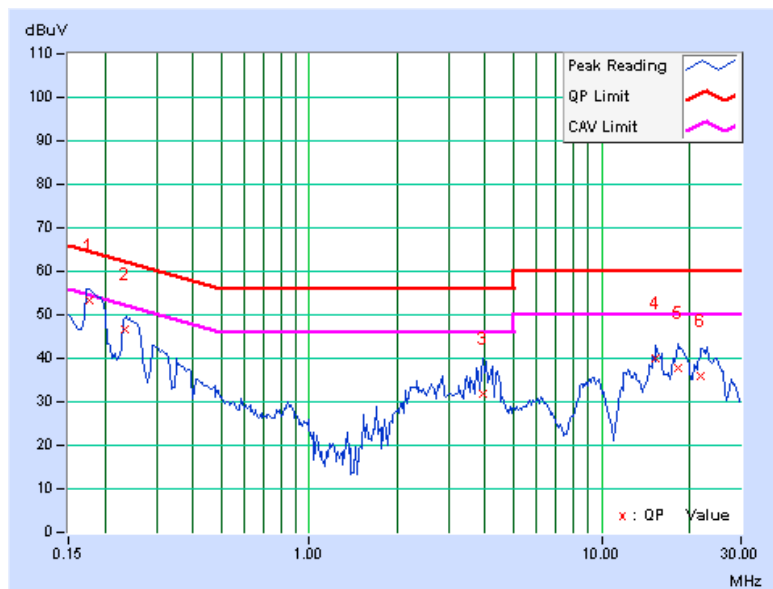

5.2 RADIATED EMISSION MEASUREMENT

5.2.1 LIMITS OF RADIATED EMISSION MEASUREMENT

Emissions radiated outside of the specified bands, shall be according to the general radiated limits in 15.209 as following:

| Frequencies (MHz) | Field strength (microvolts/meter) | Measurement distance (meters) |
|-------------------|-----------------------------------|-------------------------------|
| 0.009-0.490 | 2400/F(kHz) | 300 |
| 0.490-1.705 | 24000/F(kHz) | 30 |
| 1.705-30.0 | 30 | 30 |
| 30-88 | 100 | 3 |
| 88-216 | 150 | 3 |
| 216-960 | 200 | 3 |
| Above 960 | 500 | 3 |

NOTE:

1. The lower limit shall apply at the transition frequencies.
2. Emission level (dBuV/m) = 20 log Emission level (uV/m).
3. As shown in 15.35(b), for frequencies above 1000MHz, the field strength limits are based on average detector, however, the peak field strength of any emission shall not exceed the maximum permitted average limits, specified above by more than 20dB under any condition of modulation.



A D T

5.2.2 TEST INSTRUMENTS

Below 1GHz test

| DESCRIPTION & MANUFACTURER | MODEL NO. | SERIAL NO. | CALIBRATED DATE | CALIBRATED UNTIL |
|-------------------------------|--------------------------|---------------------------|-----------------|------------------|
| ADVANTEST Spectrum Analyzer | U3751 | 170100022 | Nov. 18, 2009 | Nov. 17, 2010 |
| PSA Sevies Spectrum Analyzer | E4446A | MY46180622 111 115 UK6 | May 12, 2010 | May 11, 2011 |
| HP Pre_Amplifier | 8449B | 3008A01922 | Sep. 25, 2009 | Sep. 24, 2010 |
| ROHDE & SCHWARZ Test Receiver | ESCS 30 | 100375 | Mar. 09, 2010 | Mar. 08, 2011 |
| SCHWARZBECK Broadband Antenna | VULB-9168 | 263 | Apr. 28, 2010 | Apr. 27, 2011 |
| Schwarzbeck Horn_Antenna | BBHA9120 | D123 | Sep. 21, 2009 | Sep. 20, 2010 |
| Schwarzbeck Horn_Antenna | BBHA 9170 | BBHA9170153 | Jan. 23, 2010 | Jan. 22, 2011 |
| RF Switches | EM-H-01-1 | 1009 | Aug. 10, 2009 | Aug. 08, 2010 |
| RF Cable | 8DFB | STACAB-30M-1GHz-091 | Nov. 20, 2009 | Nov. 19, 2010 |
| Software | ADT_Radiated_V7.6.15.9.2 | NA | NA | NA |
| CT Antenna Tower & Turn Table | TT100 | ADT01 | NA | NA |
| CORCOM AC Filter | MRI2030 | 107/108 | NA | NA |

- Note: 1. The calibration interval of the above test instruments is 12 months and the calibrations are traceable to NML/ROC and NIST/USA.
2. The horn antenna, preamplifier (model: 8449B) and Spectrum Analyzer (model: E4446A) are used only for the measurement of emission frequency above 1GHz if tested.
3. The test was performed in Open Site No. A.
4. The VCCI Site Registration No. is R-782.
5. The FCC Site Registration No. is 91097.
6. The CANADA Site Registration No. is IC 7450G-1.



A D T

Above 1GHz test

| DESCRIPTION & MANUFACTURER | MODEL NO. | SERIAL NO. | CALIBRATED DATE | CALIBRATED UNTIL |
|--------------------------------------|-----------------------------|-------------------------------------|-----------------|------------------|
| Agilent Spectrum Analyzer | E4446A | MY48250254 | Aug. 03, 2009 | Aug. 02, 2010 |
| Agilent Pre-Selector | N9039A | MY46520310 | Aug. 18, 2009 | Aug. 17, 2010 |
| Agilent Signal Generator | N5181A | MY49060347 | July 18, 2009 | July 17, 2010 |
| LIG NEX1 Test Receiver | ER-265 | L09068005 | Aug. 31, 2009 | Aug. 30, 2010 |
| Mini-Circuits Pre-Amplifier | ZFL-1000VH2B | AMP-ZFL-04 | Nov. 18, 2009 | Nov. 17, 2010 |
| Agilent Pre-Amplifier | 8449B | 3008A02465 | Mar. 01, 2010 | Feb. 28, 2011 |
| Miteq Pre-Amplifier | AFS33-1800265 0-30-8P-44 | 881786 | NA | NA |
| SCHWARZBECK Trilog Broadband Antenna | VULB 9168 | 9168-361 | Sep. 30, 2009 | Sep. 29, 2010 |
| AISI Horn_Antenna | AIH.8018 | 0000220091110 | Nov. 16, 2009 | Nov. 15, 2010 |
| SCHWARZBECK Horn_Antenna | BBHA 9170 | 9170-424 | Sep. 30, 2009 | Sep. 29, 2010 |
| RF CABLE | NA | RF104-205 RF104-207 RF104-208 | Dec. 24, 2009 | Dec. 23, 2010 |
| RF Cable | NA | CHHCAB_001 | NA | NA |
| Software | ADT_Radiated_V8.7.05 | NA | NA | NA |
| CT Antenna Tower & Turn Table | NA | NA | NA | NA |

- Note: 1. The calibration interval of the above test instruments is 12 months and the calibrations are traceable to NML/ROC and NIST/USA.
2. The horn antenna, preamplifier (model: 8449B) are used only for the measurement of emission frequency above 1GHz if tested.
3. The test was performed in 966 Chamber No. H.
4. The FCC Site Registration No. is 797305.
5. The CANADA Site Registration No. is IC 7450H-3.

5.2.3 TEST PROCEDURES

- a. The EUT was placed on the top of a rotating table 0.8 meters above the ground at a 10 meters open field site for below 1GHz test and 3 meters chamber room for above 1GHz test. The table was rotated 360 degrees to determine the position of the highest radiation.
- b. The EUT was set 3 meters away from the interference-receiving antenna, which was mounted on the top of a variable-height antenna tower.
- c. The antenna is a broadband antenna, and its height is varied from one meter to four meters above the ground to determine the maximum value of the field strength. Both horizontal and vertical polarizations of the antenna are set to make the measurement.
- d. For each suspected emission, the EUT was arranged to its worst case and then the antenna was tuned to heights from 1 meter to 4 meters and the rotatable table was turned from 0 degrees to 360 degrees to find the maximum reading.
- e. The test-receiver system was set to Peak Detect Function and Specified Bandwidth with Maximum Hold Mode.
- f. If the emission level of the EUT in peak mode was 10dB lower than the limit specified, then testing could be stopped and the peak values of the EUT would be reported. Otherwise the emissions that did not have 10dB margin would be re-tested one by one using peak, quasi-peak or average method as specified and then reported in a data sheet.

NOTE:

1. The resolution bandwidth and video bandwidth of test receiver/spectrum analyzer is 120kHz for Peak detection (PK) and Quasi-peak detection (QP) at frequency below 1GHz.
2. The resolution bandwidth of test receiver/spectrum analyzer is 1 MHz and the video bandwidth is 3 MHz for Peak detection (PK) at frequency above 1GHz.
3. The resolution bandwidth of test receiver/spectrum analyzer is 1 MHz and the video bandwidth is 10 Hz for Average detection (AV) at frequency above 1GHz.

5.2.4 DEVIATION FROM TEST STANDARD

No deviation

5.2.5 TEST SETUP

<Frequency Range below 1GHz>

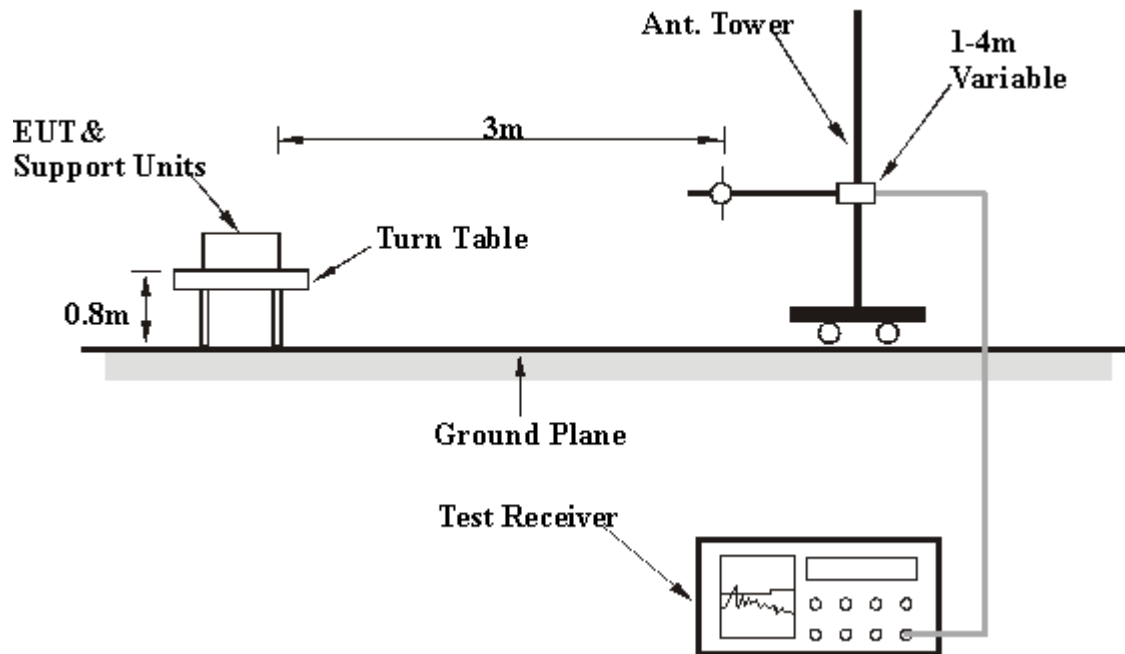

<Frequency Range above 1GHz>

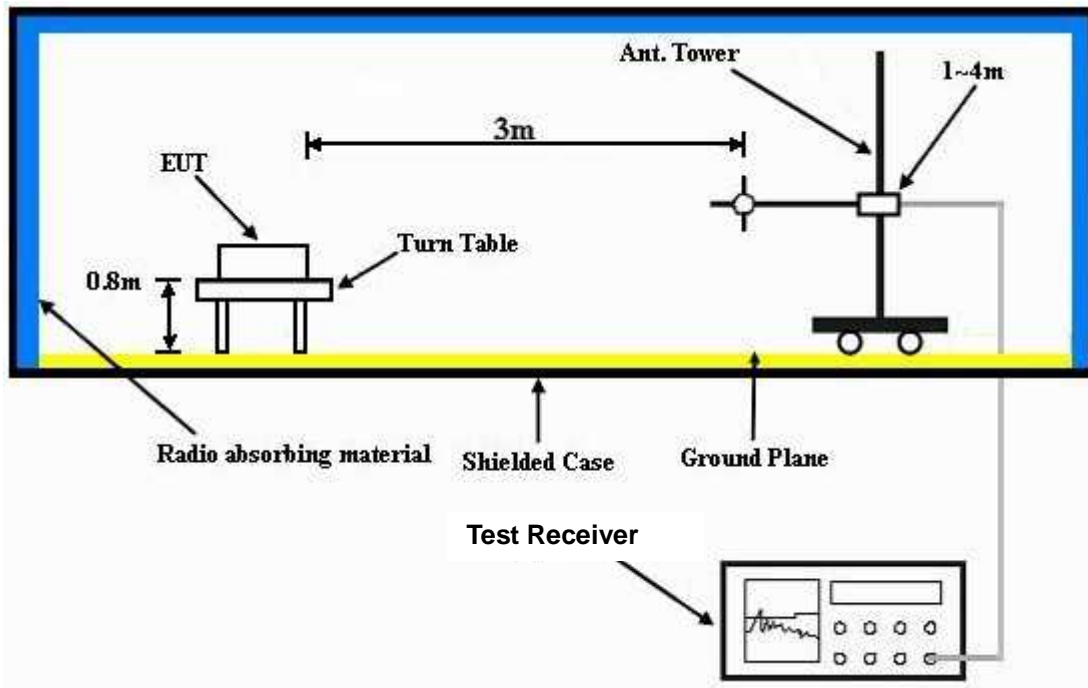

For the actual test configuration, please refer to the related item – Photographs of the Test Configuration.

5.2.6 EUT OPERATING CONDITIONS

Same as the 4.2.6



A D T

5.2.7 TEST RESULTS

BELOW 1GHz WORST-CASE DATA : 802.11n (20MHz) OFDM MODULATION

| EUT TEST CONDITION | | MEASUREMENT DETAIL | |
|--------------------------|-----------------------------|--------------------|---------------|
| CHANNEL | Channel 157 | FREQUENCY RANGE | Below 1000MHz |
| INPUT POWER (SYSTEM) | 120Vac, 60 Hz | DETECTOR FUNCTION | Quasi-Peak |
| ENVIRONMENTAL CONDITIONS | 26deg. C, 81%RH 1014 hPa | TESTED BY | Eagle Chen |

ANTENNA POLARITY & TEST DISTANCE: HORIZONTAL AT 3 M

| NO. | FREQ. (MHz) | EMISSION LEVEL (dBuV/m) | LIMIT (dBuV/m) | MARGIN (dB) | ANTENNA HEIGHT (m) | TABLE ANGLE (Degree) | RAW VALUE (dBuV) | CORRECTION FACTOR (dB/m) |
|-----|-------------|-------------------------|----------------|-------------|--------------------|----------------------|------------------|--------------------------|
| 1 | 125.00 | 29.5 QP | 43.5 | -14.0 | 2.75 H | 341 | 15.88 | 13.58 |
| 2 | 220.00 | 30.7 QP | 46.0 | -15.3 | 2.87 H | 35 | 17.78 | 12.90 |
| 3 | 250.00 | 29.6 QP | 46.0 | -16.4 | 2.57 H | 341 | 15.96 | 13.65 |
| 4 | 396.61 | 29.8 QP | 46.0 | -16.3 | 2.49 H | 177 | 11.00 | 18.75 |
| 5 | 500.01 | 30.3 QP | 46.0 | -15.7 | 1.87 H | 49 | 8.82 | 21.45 |
| 6 | 875.02 | 31.5 QP | 46.0 | -14.5 | 1.00 H | 307 | 3.51 | 28.01 |
| 7 | 1000.00 | 42.6 QP | 54.0 | -11.4 | 1.00 H | 329 | 13.11 | 29.52 |

ANTENNA POLARITY & TEST DISTANCE: VERTICAL AT 3 M

| NO. | FREQ. (MHz) | EMISSION LEVEL (dBuV/m) | LIMIT (dBuV/m) | MARGIN (dB) | ANTENNA HEIGHT (m) | TABLE ANGLE (Degree) | RAW VALUE (dBuV) | CORRECTION FACTOR (dB/m) |
|-----|-------------|-------------------------|----------------|-------------|--------------------|----------------------|------------------|--------------------------|
| 1 | 125.00 | 34.5 QP | 43.5 | -9.0 | 1.00 V | 25 | 20.96 | 13.58 |
| 2 | 220.00 | 31.4 QP | 46.0 | -14.6 | 1.00 V | 24 | 18.48 | 12.90 |
| 3 | 250.01 | 34.3 QP | 46.0 | -11.7 | 1.00 V | 354 | 20.67 | 13.65 |
| 4 | 375.01 | 33.7 QP | 46.0 | -12.3 | 1.00 V | 99 | 15.63 | 18.04 |
| 5 | 500.01 | 35.4 QP | 46.0 | -10.6 | 1.00 V | 38 | 13.92 | 21.45 |
| 6 | 875.00 | 34.4 QP | 46.0 | -11.6 | 2.51 V | 35 | 6.42 | 28.01 |
| 7 | 1000.00 | 38.2 QP | 54.0 | -15.8 | 2.13 V | 346 | 8.64 | 29.52 |

- REMARKS:**
1. Emission level (dBuV/m) = Raw Value (dBuV) + Correction Factor (dB/m).
 2. Correction Factor (dB/m) = Antenna Factor (dB/m) + Cable Factor (dB).
 3. The other emission levels were very low against the limit.
 4. Margin value = Emission level – Limit value.



A D T

ABOVE 1GHz DATA

802.11a OFDM MODULATION

| EUT TEST CONDITION | | MEASUREMENT DETAIL | |
|--------------------------|-----------------------------|--------------------|---------------------------|
| CHANNEL | Channel 149 | FREQUENCY RANGE | 1 ~ 40GHz |
| INPUT POWER (SYSTEM) | 120Vac, 60 Hz | DETECTOR FUNCTION | Peak (PK) Average (AV) |
| ENVIRONMENTAL CONDITIONS | 26deg. C, 70%RH 1014 hPa | TESTED BY | Eric Lee |

ANTENNA POLARITY & TEST DISTANCE: HORIZONTAL AT 3 M

| NO. | FREQ. (MHz) | EMISSION LEVEL (dBuV/m) | LIMIT (dBuV/m) | MARGIN (dB) | ANTENNA HEIGHT (m) | TABLE ANGLE (Degree) | RAW VALUE (dBuV) | CORRECTION FACTOR (dB/m) |
|-----|-------------|-------------------------|----------------|-------------|--------------------|----------------------|------------------|--------------------------|
| 1 | *5745.00 | 106.9 PK | | | 1.04 H | 2 | 65.56 | 41.34 |
| 2 | *5745.00 | 98.9 AV | | | 1.04 H | 2 | 57.56 | 41.34 |
| 3 | 11490.00 | 57.2 PK | 74.0 | -16.8 | 1.09 H | 14 | 9.78 | 47.42 |
| 4 | 11490.00 | 46.3 AV | 54.0 | -7.7 | 1.09 H | 14 | -1.12 | 47.42 |

ANTENNA POLARITY & TEST DISTANCE: VERTICAL AT 3 M

| NO. | FREQ. (MHz) | EMISSION LEVEL (dBuV/m) | LIMIT (dBuV/m) | MARGIN (dB) | ANTENNA HEIGHT (m) | TABLE ANGLE (Degree) | RAW VALUE (dBuV) | CORRECTION FACTOR (dB/m) |
|-----|-------------|-------------------------|----------------|-------------|--------------------|----------------------|------------------|--------------------------|
| 1 | *5745.00 | 114.3 PK | | | 1.41 V | 276 | 72.96 | 41.34 |
| 2 | *5745.00 | 103.4 AV | | | 1.41 V | 276 | 62.06 | 41.34 |
| 3 | 11490.00 | 56.1 PK | 74.0 | -17.9 | 1.14 V | 59 | 8.68 | 47.42 |
| 4 | 11490.00 | 45.3 AV | 54.0 | -8.7 | 1.14 V | 59 | -2.12 | 47.42 |

- REMARKS:**
1. Emission level (dBuV/m) = Raw Value (dBuV) + Correction Factor (dB/m).
 2. Correction Factor (dB/m) = Antenna Factor (dB/m) + Cable Factor (dB).
 3. The other emission levels were very low against the limit.
 4. Margin value = Emission level – Limit value.
 5. “ * “: Fundamental frequency.
 6. The limit value is defined as per 15.247.



A D T

| EUT TEST CONDITION | | MEASUREMENT DETAIL | |
|--------------------------|-----------------------------|--------------------|---------------------------|
| CHANNEL | Channel 157 | FREQUENCY RANGE | 1 ~ 40GHz |
| INPUT POWER (SYSTEM) | 120Vac, 60 Hz | DETECTOR FUNCTION | Peak (PK) Average (AV) |
| ENVIRONMENTAL CONDITIONS | 26deg. C, 70%RH 1014 hPa | TESTED BY | Eric Lee |

| ANTENNA POLARITY & TEST DISTANCE: HORIZONTAL AT 3 M | | | | | | | | |
|---|-------------|-------------------------|----------------|-------------|--------------------|----------------------|------------------|--------------------------|
| NO. | FREQ. (MHz) | EMISSION LEVEL (dBuV/m) | LIMIT (dBuV/m) | MARGIN (dB) | ANTENNA HEIGHT (m) | TABLE ANGLE (Degree) | RAW VALUE (dBuV) | CORRECTION FACTOR (dB/m) |
| 1 | *5785.00 | 108.4 PK | | | 1.05 H | 12 | 67.00 | 41.40 |
| 2 | *5785.00 | 98.6 AV | | | 1.05 H | 12 | 57.20 | 41.40 |
| 3 | 11570.00 | 57.4 PK | 74.0 | -16.6 | 1.04 H | 29 | 9.91 | 47.49 |
| 4 | 11570.00 | 46.4 AV | 54.0 | -7.6 | 1.04 H | 29 | -1.09 | 47.49 |
| ANTENNA POLARITY & TEST DISTANCE: VERTICAL AT 3 M | | | | | | | | |
| NO. | FREQ. (MHz) | EMISSION LEVEL (dBuV/m) | LIMIT (dBuV/m) | MARGIN (dB) | ANTENNA HEIGHT (m) | TABLE ANGLE (Degree) | RAW VALUE (dBuV) | CORRECTION FACTOR (dB/m) |
| 1 | *5785.00 | 115.9 PK | | | 1.37 V | 269 | 74.50 | 41.40 |
| 2 | *5785.00 | 104.7 AV | | | 1.37 V | 269 | 63.30 | 41.40 |
| 3 | 11570.00 | 56.7 PK | 74.0 | -17.3 | 1.13 V | 62 | 9.21 | 47.49 |
| 4 | 11570.00 | 45.7 AV | 54.0 | -8.3 | 1.13 V | 62 | -1.79 | 47.49 |

- REMARKS:**
1. Emission level (dBuV/m) = Raw Value (dBuV) + Correction Factor (dB/m).
 2. Correction Factor (dB/m) = Antenna Factor (dB/m) + Cable Factor (dB).
 3. The other emission levels were very low against the limit.
 4. Margin value = Emission level – Limit value.
 5. “ * “: Fundamental frequency.
 6. The limit value is defined as per 15.247.



A D T

| EUT TEST CONDITION | | MEASUREMENT DETAIL | |
|--------------------------|-----------------------------|--------------------|---------------------------|
| CHANNEL | Channel 165 | FREQUENCY RANGE | 1 ~ 40GHz |
| INPUT POWER (SYSTEM) | 120Vac, 60 Hz | DETECTOR FUNCTION | Peak (PK) Average (AV) |
| ENVIRONMENTAL CONDITIONS | 26deg. C, 70%RH 1014 hPa | TESTED BY | Eric Lee |

| ANTENNA POLARITY & TEST DISTANCE: HORIZONTAL AT 3 M | | | | | | | | |
|---|-------------|-------------------------|----------------|-------------|--------------------|----------------------|------------------|--------------------------|
| NO. | FREQ. (MHz) | EMISSION LEVEL (dBuV/m) | LIMIT (dBuV/m) | MARGIN (dB) | ANTENNA HEIGHT (m) | TABLE ANGLE (Degree) | RAW VALUE (dBuV) | CORRECTION FACTOR (dB/m) |
| 1 | *5825.00 | 109.6 PK | | | 1.06 H | 17 | 68.15 | 41.45 |
| 2 | *5825.00 | 99.2 AV | | | 1.06 H | 17 | 57.75 | 41.45 |
| 3 | 11650.00 | 59.7 PK | 74.0 | -14.3 | 1.04 H | 24 | 12.14 | 47.56 |
| 4 | 11650.00 | 46.7 AV | 54.0 | -7.3 | 1.04 H | 24 | -0.86 | 47.56 |
| ANTENNA POLARITY & TEST DISTANCE: VERTICAL AT 3 M | | | | | | | | |
| NO. | FREQ. (MHz) | EMISSION LEVEL (dBuV/m) | LIMIT (dBuV/m) | MARGIN (dB) | ANTENNA HEIGHT (m) | TABLE ANGLE (Degree) | RAW VALUE (dBuV) | CORRECTION FACTOR (dB/m) |
| 1 | *5825.00 | 116.1 PK | | | 1.42 V | 263 | 74.65 | 41.45 |
| 2 | *5825.00 | 105.9 AV | | | 1.42 V | 263 | 64.45 | 41.45 |
| 3 | 11650.00 | 58.2 PK | 74.0 | -15.8 | 1.17 V | 59 | 10.64 | 47.56 |
| 4 | 11650.00 | 45.9 AV | 54.0 | -8.1 | 1.17 V | 59 | -1.66 | 47.56 |

- REMARKS:**
1. Emission level (dBuV/m) = Raw Value (dBuV) + Correction Factor (dB/m).
 2. Correction Factor (dB/m) = Antenna Factor (dB/m) + Cable Factor (dB).
 3. The other emission levels were very low against the limit.
 4. Margin value = Emission level – Limit value.
 5. “ * “: Fundamental frequency.
 6. The limit value is defined as per 15.247.



A D T

802.11n (20MHz) OFDM MODULATION

| EUT TEST CONDITION | | MEASUREMENT DETAIL | |
|--------------------------|-----------------------------|--------------------|---------------------------|
| CHANNEL | Channel 149 | FREQUENCY RANGE | 1 ~ 40GHz |
| INPUT POWER (SYSTEM) | 120Vac, 60 Hz | DETECTOR FUNCTION | Peak (PK) Average (AV) |
| ENVIRONMENTAL CONDITIONS | 26deg. C, 70%RH 1014 hPa | TESTED BY | Eric Lee |

| ANTENNA POLARITY & TEST DISTANCE: HORIZONTAL AT 3 M | | | | | | | | |
|---|-------------|-------------------------|----------------|-------------|--------------------|----------------------|------------------|--------------------------|
| NO. | FREQ. (MHz) | EMISSION LEVEL (dBuV/m) | LIMIT (dBuV/m) | MARGIN (dB) | ANTENNA HEIGHT (m) | TABLE ANGLE (Degree) | RAW VALUE (dBuV) | CORRECTION FACTOR (dB/m) |
| 1 | *5745.00 | 112.7 PK | | | 1.04 H | 253 | 71.36 | 41.34 |
| 2 | *5745.00 | 92.4 AV | | | 1.04 H | 253 | 51.06 | 41.34 |
| 3 | 11490.00 | 60.4 PK | 74.0 | -13.6 | 1.07 H | 179 | 12.98 | 47.42 |
| 4 | 11490.00 | 46.4 AV | 54.0 | -7.6 | 1.07 H | 179 | -1.02 | 47.42 |
| ANTENNA POLARITY & TEST DISTANCE: VERTICAL AT 3 M | | | | | | | | |
| NO. | FREQ. (MHz) | EMISSION LEVEL (dBuV/m) | LIMIT (dBuV/m) | MARGIN (dB) | ANTENNA HEIGHT (m) | TABLE ANGLE (Degree) | RAW VALUE (dBuV) | CORRECTION FACTOR (dB/m) |
| 1 | *5745.00 | 116.3 PK | | | 1.03 V | 284 | 74.96 | 41.34 |
| 2 | *5745.00 | 95.4 AV | | | 1.03 V | 284 | 54.06 | 41.34 |
| 3 | 11490.00 | 59.6 PK | 74.0 | -14.4 | 1.42 V | 73 | 12.18 | 47.42 |
| 4 | 11490.00 | 45.7 AV | 54.0 | -8.3 | 1.42 V | 73 | -1.72 | 47.42 |

- REMARKS:**
1. Emission level (dBuV/m) = Raw Value (dBuV) + Correction Factor (dB/m).
 2. Correction Factor (dB/m) = Antenna Factor (dB/m) + Cable Factor (dB).
 3. The other emission levels were very low against the limit.
 4. Margin value = Emission level – Limit value.
 5. “ * “: Fundamental frequency.
 6. The limit value is defined as per 15.247.



A D T

| EUT TEST CONDITION | | MEASUREMENT DETAIL | |
|--------------------------|-----------------------------|--------------------|---------------------------|
| CHANNEL | Channel 157 | FREQUENCY RANGE | 1 ~ 40GHz |
| INPUT POWER (SYSTEM) | 120Vac, 60 Hz | DETECTOR FUNCTION | Peak (PK) Average (AV) |
| ENVIRONMENTAL CONDITIONS | 26deg. C, 70%RH 1014 hPa | TESTED BY | Eric Lee |

| ANTENNA POLARITY & TEST DISTANCE: HORIZONTAL AT 3 M | | | | | | | | |
|---|-------------|-------------------------|----------------|-------------|--------------------|----------------------|------------------|--------------------------|
| NO. | FREQ. (MHz) | EMISSION LEVEL (dBuV/m) | LIMIT (dBuV/m) | MARGIN (dB) | ANTENNA HEIGHT (m) | TABLE ANGLE (Degree) | RAW VALUE (dBuV) | CORRECTION FACTOR (dB/m) |
| 1 | *5785.00 | 113.4 PK | | | 1.01 H | 211 | 72.00 | 41.40 |
| 2 | *5785.00 | 93.6 AV | | | 1.01 H | 211 | 52.20 | 41.40 |
| 3 | 11570.00 | 61.7 PK | 74.0 | -12.3 | 1.34 H | 181 | 14.21 | 47.49 |
| 4 | 11570.00 | 46.9 AV | 54.0 | -7.1 | 1.34 H | 181 | -0.59 | 47.49 |
| ANTENNA POLARITY & TEST DISTANCE: VERTICAL AT 3 M | | | | | | | | |
| NO. | FREQ. (MHz) | EMISSION LEVEL (dBuV/m) | LIMIT (dBuV/m) | MARGIN (dB) | ANTENNA HEIGHT (m) | TABLE ANGLE (Degree) | RAW VALUE (dBuV) | CORRECTION FACTOR (dB/m) |
| 1 | *5785.00 | 117.4 PK | | | 1.04 V | 276 | 76.00 | 41.40 |
| 2 | *5785.00 | 96.2 AV | | | 1.04 V | 276 | 54.80 | 41.40 |
| 3 | 11570.00 | 60.4 PK | 74.0 | -13.6 | 1.45 V | 89 | 12.91 | 47.49 |
| 4 | 11570.00 | 46.2 AV | 54.0 | -7.8 | 1.45 V | 89 | -1.29 | 47.49 |

- REMARKS:**
1. Emission level (dBuV/m) = Raw Value (dBuV) + Correction Factor (dB/m).
 2. Correction Factor (dB/m) = Antenna Factor (dB/m) + Cable Factor (dB).
 3. The other emission levels were very low against the limit.
 4. Margin value = Emission level – Limit value.
 5. “ * “: Fundamental frequency.
 6. The limit value is defined as per 15.247.



A D T

| EUT TEST CONDITION | | MEASUREMENT DETAIL | |
|--------------------------|-----------------------------|--------------------|---------------------------|
| CHANNEL | Channel 165 | FREQUENCY RANGE | 1 ~ 40GHz |
| INPUT POWER (SYSTEM) | 120Vac, 60 Hz | DETECTOR FUNCTION | Peak (PK) Average (AV) |
| ENVIRONMENTAL CONDITIONS | 26deg. C, 70%RH 1014 hPa | TESTED BY | Eric Lee |

| ANTENNA POLARITY & TEST DISTANCE: HORIZONTAL AT 3 M | | | | | | | | |
|---|-------------|-------------------------|----------------|-------------|--------------------|----------------------|------------------|--------------------------|
| NO. | FREQ. (MHz) | EMISSION LEVEL (dBuV/m) | LIMIT (dBuV/m) | MARGIN (dB) | ANTENNA HEIGHT (m) | TABLE ANGLE (Degree) | RAW VALUE (dBuV) | CORRECTION FACTOR (dB/m) |
| 1 | *5825.00 | 114.2 PK | | | 1.07 H | 249 | 72.75 | 41.45 |
| 2 | *5825.00 | 94.3 AV | | | 1.07 H | 249 | 52.85 | 41.45 |
| 3 | 11650.00 | 62.1 PK | 74.0 | -11.9 | 1.45 H | 163 | 14.54 | 47.56 |
| 4 | 11650.00 | 47.3 AV | 54.0 | -6.7 | 1.45 H | 163 | -0.26 | 47.56 |

| ANTENNA POLARITY & TEST DISTANCE: VERTICAL AT 3 M | | | | | | | | |
|---|-------------|-------------------------|----------------|-------------|--------------------|----------------------|------------------|--------------------------|
| NO. | FREQ. (MHz) | EMISSION LEVEL (dBuV/m) | LIMIT (dBuV/m) | MARGIN (dB) | ANTENNA HEIGHT (m) | TABLE ANGLE (Degree) | RAW VALUE (dBuV) | CORRECTION FACTOR (dB/m) |
| 1 | *5825.00 | 117.9 PK | | | 1.07 V | 269 | 76.45 | 41.45 |
| 2 | *5825.00 | 97.4 AV | | | 1.07 V | 269 | 55.95 | 41.45 |
| 3 | 11650.00 | 60.9 PK | 74.0 | -13.1 | 1.49 V | 73 | 13.34 | 47.56 |
| 4 | 11650.00 | 46.8 AV | 54.0 | -7.2 | 1.49 V | 73 | -0.76 | 47.56 |

- REMARKS:**
1. Emission level (dBuV/m) = Raw Value (dBuV) + Correction Factor (dB/m).
 2. Correction Factor (dB/m) = Antenna Factor (dB/m) + Cable Factor (dB).
 3. The other emission levels were very low against the limit.
 4. Margin value = Emission level – Limit value.
 5. “ * “: Fundamental frequency.
 6. The limit value is defined as per 15.247.



A D T

802.11n (40MHz) OFDM MODULATION

| EUT TEST CONDITION | | MEASUREMENT DETAIL | |
|--------------------------|-----------------------------|--------------------|---------------------------|
| CHANNEL | Channel 151 | FREQUENCY RANGE | 1 ~ 40GHz |
| INPUT POWER (SYSTEM) | 120Vac, 60 Hz | DETECTOR FUNCTION | Peak (PK) Average (AV) |
| ENVIRONMENTAL CONDITIONS | 26deg. C, 70%RH 1014 hPa | TESTED BY | Eric Lee |

| ANTENNA POLARITY & TEST DISTANCE: HORIZONTAL AT 3 M | | | | | | | | |
|---|-------------|-------------------------|----------------|-------------|--------------------|----------------------|------------------|--------------------------|
| NO. | FREQ. (MHz) | EMISSION LEVEL (dBuV/m) | LIMIT (dBuV/m) | MARGIN (dB) | ANTENNA HEIGHT (m) | TABLE ANGLE (Degree) | RAW VALUE (dBuV) | CORRECTION FACTOR (dB/m) |
| 1 | *5755.00 | 110.6 PK | | | 1.00 H | 56 | 69.24 | 41.36 |
| 2 | *5755.00 | 73.4 AV | | | 1.00 H | 56 | 32.04 | 41.36 |
| 3 | 11510.00 | 55.4 PK | 74.0 | -18.6 | 1.23 H | 179 | 7.96 | 47.44 |
| 4 | 11510.00 | 41.3 AV | 54.0 | -12.7 | 1.23 H | 179 | -6.14 | 47.44 |
| ANTENNA POLARITY & TEST DISTANCE: VERTICAL AT 3 M | | | | | | | | |
| NO. | FREQ. (MHz) | EMISSION LEVEL (dBuV/m) | LIMIT (dBuV/m) | MARGIN (dB) | ANTENNA HEIGHT (m) | TABLE ANGLE (Degree) | RAW VALUE (dBuV) | CORRECTION FACTOR (dB/m) |
| 1 | *5755.00 | 114.3 PK | | | 1.04 V | 313 | 72.94 | 41.36 |
| 2 | *5755.00 | 75.4 AV | | | 1.04 V | 313 | 34.04 | 41.36 |
| 3 | 11510.00 | 54.3 PK | 74.0 | -19.7 | 1.01 V | 319 | 6.86 | 47.44 |
| 4 | 11510.00 | 41.6 AV | 54.0 | -12.4 | 1.01 V | 319 | -5.84 | 47.44 |

- REMARKS:**
1. Emission level (dBuV/m) = Raw Value (dBuV) + Correction Factor (dB/m).
 2. Correction Factor (dB/m) = Antenna Factor (dB/m) + Cable Factor (dB).
 3. The other emission levels were very low against the limit.
 4. Margin value = Emission level – Limit value.
 5. “ * “: Fundamental frequency.
 6. The limit value is defined as per 15.247.



A D T

| EUT TEST CONDITION | | MEASUREMENT DETAIL | |
|--------------------------|-----------------------------|--------------------|---------------------------|
| CHANNEL | Channel 159 | FREQUENCY RANGE | 1 ~ 40GHz |
| INPUT POWER (SYSTEM) | 120Vac, 60 Hz | DETECTOR FUNCTION | Peak (PK) Average (AV) |
| ENVIRONMENTAL CONDITIONS | 26deg. C, 70%RH 1014 hPa | TESTED BY | Eric Lee |

| ANTENNA POLARITY & TEST DISTANCE: HORIZONTAL AT 3 M | | | | | | | | |
|---|-------------|-------------------------|----------------|-------------|--------------------|----------------------|------------------|--------------------------|
| NO. | FREQ. (MHz) | EMISSION LEVEL (dBuV/m) | LIMIT (dBuV/m) | MARGIN (dB) | ANTENNA HEIGHT (m) | TABLE ANGLE (Degree) | RAW VALUE (dBuV) | CORRECTION FACTOR (dB/m) |
| 1 | *5795.00 | 110.6 PK | | | 1.04 H | 48 | 69.19 | 41.41 |
| 2 | *5795.00 | 73.1 AV | | | 1.04 H | 48 | 31.69 | 41.41 |
| 3 | 11590.00 | 57.6 PK | 74.0 | -16.4 | 1.27 H | 89 | 10.10 | 47.50 |
| 4 | 11590.00 | 43.7 AV | 54.0 | -10.3 | 1.27 H | 89 | -3.80 | 47.50 |
| ANTENNA POLARITY & TEST DISTANCE: VERTICAL AT 3 M | | | | | | | | |
| NO. | FREQ. (MHz) | EMISSION LEVEL (dBuV/m) | LIMIT (dBuV/m) | MARGIN (dB) | ANTENNA HEIGHT (m) | TABLE ANGLE (Degree) | RAW VALUE (dBuV) | CORRECTION FACTOR (dB/m) |
| 1 | *5795.00 | 115.4 PK | | | 1.04 V | 319 | 73.99 | 41.41 |
| 2 | *5795.00 | 75.6 AV | | | 1.04 V | 319 | 34.19 | 41.41 |
| 3 | 11590.00 | 55.6 PK | 74.0 | -18.4 | 1.51 V | 76 | 8.10 | 47.50 |
| 4 | 11590.00 | 43.2 AV | 54.0 | -10.8 | 1.51 V | 76 | -4.30 | 47.50 |

- REMARKS:**
1. Emission level (dBuV/m) = Raw Value (dBuV) + Correction Factor (dB/m).
 2. Correction Factor (dB/m) = Antenna Factor (dB/m) + Cable Factor (dB).
 3. The other emission levels were very low against the limit.
 4. Margin value = Emission level – Limit value.
 5. “ * “: Fundamental frequency.
 6. The limit value is defined as per 15.247.

5.3 6dB BANDWIDTH MEASUREMENT

5.3.1 LIMITS OF 6dB BANDWIDTH MEASUREMENT

The minimum of 6dB Bandwidth Measurement is 0.5 MHz.

5.3.2 TEST INSTRUMENTS

| DESCRIPTION & MANUFACTURER | MODEL NO. | SERIAL NO. | CALIBRATED DATE | CALIBRATED UNTIL |
|----------------------------|-----------|------------|-----------------|------------------|
| R&S SPECTRUM ANALYZER | FSP40 | 100037 | Aug. 03, 2009 | Aug. 02, 2010 |

NOTE:

- 1.The calibration interval of the above test instruments is 12 months and the calibrations are traceable to NML/ROC and NIST/USA.

5.3.3 TEST PROCEDURE

The transmitter output was connected to the spectrum analyzer through an attenuator. The bandwidth of the fundamental frequency was measured by spectrum analyzer with 100kHz RBW and 100kHz VBW. The 6dB bandwidth is defined as the total spectrum the power of which is higher than peak power minus 6dB.

5.3.4 DEVIATION FROM TEST STANDARD

No deviation

5.3.5 TEST SETUP

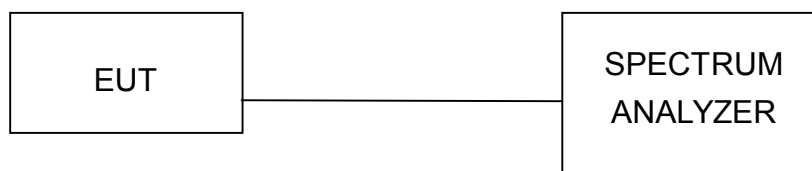

5.3.6 EUT OPERATING CONDITIONS

The software provided by client to enable the EUT under transmission condition continuously at lowest, middle and highest channel frequencies individually.



A D T

5.3.7 TEST RESULTS

802.11a OFDM MODULATION:

| CHANNEL | CHANNEL FREQUENCY (MHz) | 6dB BANDWIDTH (MHz) | MINIMUM LIMIT (MHz) | PASS / FAIL |
|---------|-------------------------|---------------------|---------------------|-------------|
| 149 | 5745 | 15.17 | 0.5 | PASS |
| 157 | 5785 | 15.14 | 0.5 | PASS |
| 165 | 5825 | 15.17 | 0.5 | PASS |

CH165

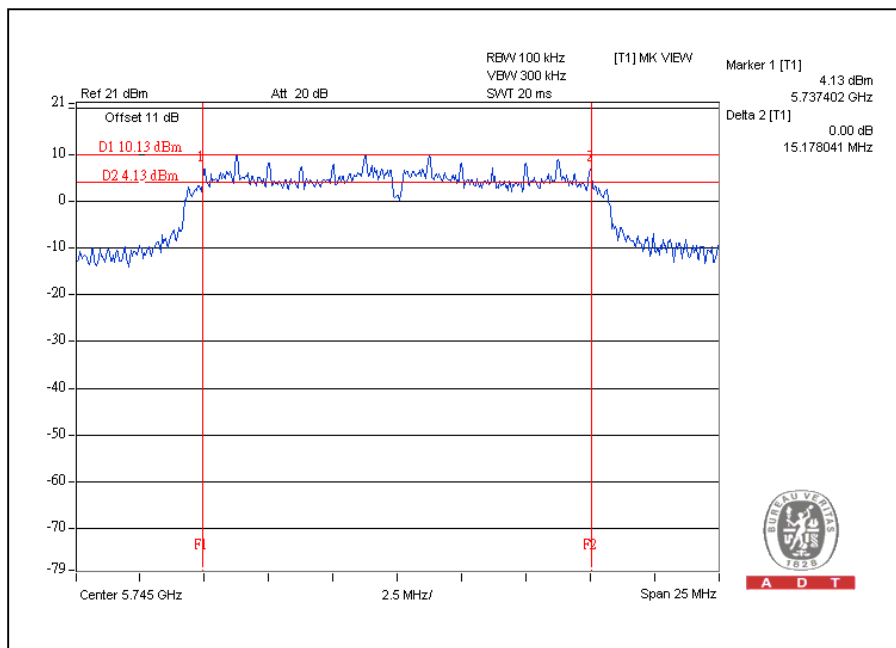



A D T

802.11n (20MHz) OFDM MODULATION:

| CHANNEL | CHANNEL FREQUENCY (MHz) | 6dB BANDWIDTH (MHz) | MINIMUM LIMIT (MHz) | PASS / FAIL |
|---------|-------------------------|---------------------|---------------------|-------------|
| 149 | 5745 | 15.14 | 0.5 | PASS |
| 157 | 5785 | 15.12 | 0.5 | PASS |
| 165 | 5825 | 15.17 | 0.5 | PASS |

CH165

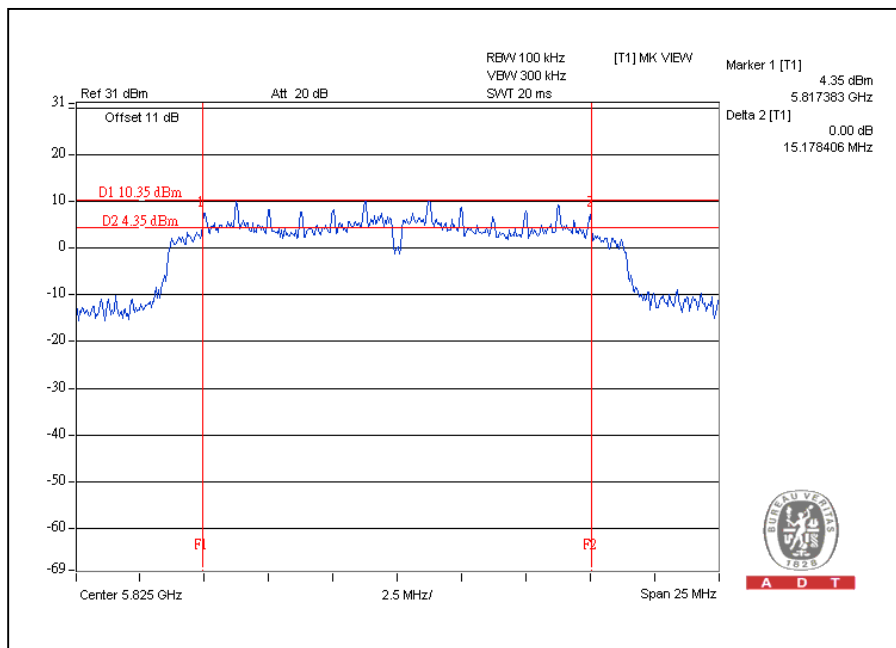



A D T

802.11n (40MHz) OFDM MODULATION:

| CHANNEL | CHANNEL FREQUENCY (MHz) | 6dB BANDWIDTH (MHz) | MINIMUM LIMIT (MHz) | PASS / FAIL |
|---------|-------------------------|---------------------|---------------------|-------------|
| 151 | 5755 | 35.18 | 0.5 | PASS |
| 159 | 5795 | 35.11 | 0.5 | PASS |

CH151

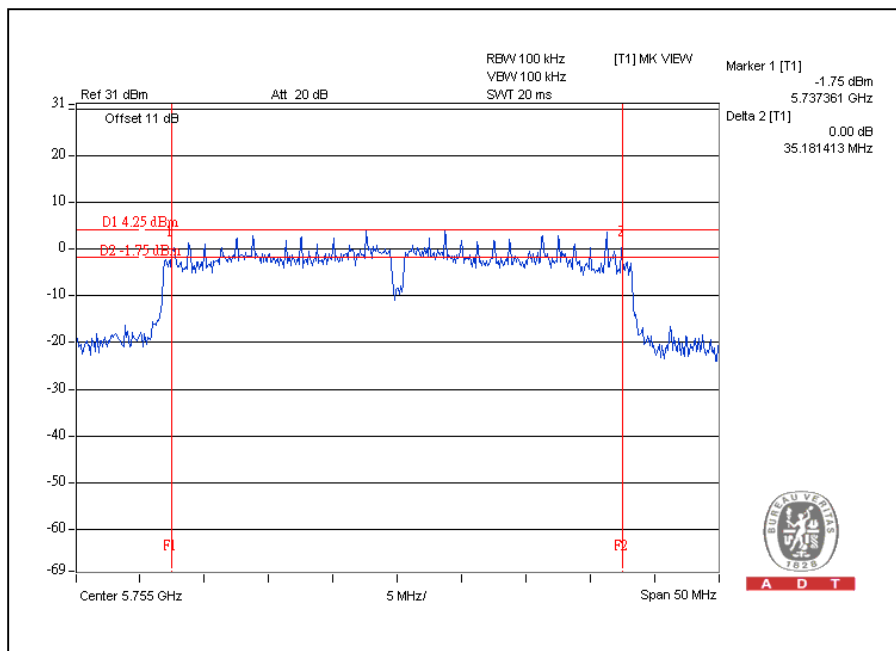

5.4 MAXIMUM PEAK OUTPUT POWER

5.4.1 LIMITS OF MAXIMUM PEAK OUTPUT POWER MEASUREMENT

The Maximum Peak Output Power Measurement is 30dBm.

5.4.2 INSTRUMENTS

| DESCRIPTION & MANUFACTURER | MODEL NO. | SERIAL NO. | CALIBRATED DATE | CALIBRATED UNTIL |
|----------------------------|-----------|------------|-----------------|------------------|
| Anritsu Power Meter | ML2495A | 0824006 | April 24, 2010 | April 23, 2011 |
| Pulse Power Sensor | MA2411B | 0738172 | April 24, 2010 | April 23, 2011 |

NOTE:

The calibration interval of the above test instruments is 12 months and the calibrations are traceable to NML/ROC and NIST/USA.

5.4.3 TEST PROCEDURES

1. The transmitter output was connected to the power meter through an attenuator; the bandwidth of the fundamental frequency was measured with the power meter.
2. Record the power level.

5.4.4 DEVIATION FROM TEST STANDARD

No deviation

5.4.5 TEST SETUP

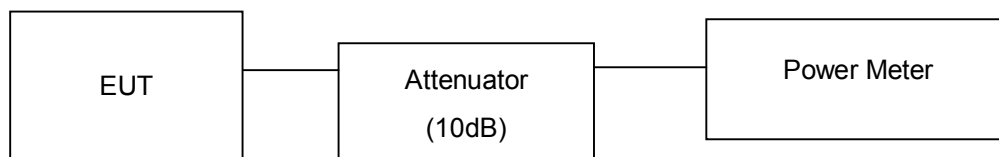

5.4.6 EUT OPERATING CONDITIONS

Same as Item 4.3.6



A D T

5.4.7 TEST RESULTS

802.11a OFDM MODULATION

| CHANNEL | CHANNEL FREQUENCY (MHz) | PEAK POWER OUTPUT (dBm) | PEAK POWER OUTPUT (mW) | PEAK POWER LIMIT (dBm) | PASS / FAIL |
|---------|-------------------------|-------------------------|------------------------|------------------------|-------------|
| 149 | 5745 | 23.4 | 218.8 | 30 | PASS |
| 157 | 5785 | 23.4 | 218.8 | 30 | PASS |
| 165 | 5825 | 23.5 | 223.9 | 30 | PASS |

802.11n (20MHz) OFDM MODULATION:

| CHANNEL | CHANNEL FREQUENCY (MHz) | PEAK POWER OUTPUT (dBm) | | TOTAL PEAK POWER (mW) | TOTAL PEAK POWER (dBm) | PEAK POWER LIMIT (dBm) | PASS / FAIL |
|---------|-------------------------|-------------------------|----------|-----------------------|------------------------|------------------------|-------------|
| | | CHAIN(0) | CHAIN(1) | | | | |
| 149 | 5745 | 23.5 | 22.8 | 414.4 | 26.2 | 30 | PASS |
| 157 | 5785 | 23.6 | 23.6 | 458.2 | 26.6 | 30 | PASS |
| 165 | 5825 | 23.2 | 23.5 | 432.8 | 26.4 | 30 | PASS |

802.11n (40MHz) OFDM MODULATION:

| CHANNEL | CHANNEL FREQUENCY (MHz) | PEAK POWER OUTPUT (dBm) | | TOTAL PEAK POWER (mW) | TOTAL PEAK POWER (dBm) | PEAK POWER LIMIT (dBm) | PASS / FAIL |
|---------|-------------------------|-------------------------|----------|-----------------------|------------------------|------------------------|-------------|
| | | CHAIN(0) | CHAIN(1) | | | | |
| 151 | 5755 | 22.3 | 22.4 | 343.6 | 25.4 | 30 | PASS |
| 159 | 5795 | 23.3 | 23.1 | 418.0 | 26.2 | 30 | PASS |

5.5 POWER SPECTRAL DENSITY MEASUREMENT

5.5.1 LIMITS OF POWER SPECTRAL DENSITY MEASUREMENT

The Maximum of Power Spectral Density Measurement is 8dBm.

5.5.2 TEST INSTRUMENTS

| DESCRIPTION & MANUFACTURER | MODEL NO. | SERIAL NO. | CALIBRATED DATE | CALIBRATED UNTIL |
|----------------------------|-----------|------------|-----------------|------------------|
| R&S SPECTRUM ANALYZER | FSP40 | 100037 | Aug. 03, 2009 | Aug. 02, 2010 |

NOTE:

1. The calibration interval of the above test instruments is 12 months and the calibrations are traceable to NML/ROC and NIST/USA.

5.5.3 TEST PROCEDURE

The transmitter output was connected to the spectrum analyzer through an attenuator, the bandwidth of the fundamental frequency was measured with the spectrum analyzer using 3 kHz RBW and 30 kHz VBW, set sweep time = span/3 kHz. The power spectral density was measured and recorded.

The sweep time is allowed to be longer than span/3 kHz for a full response of the mixer in the spectrum analyzer.

5.5.4 DEVIATION FROM TEST STANDARD

No deviation

5.5.5 TEST SETUP



5.5.6 EUT OPERATING CONDITION

Same as Item 4.3.6



A D T

5.5.7 TEST RESULTS

802.11a OFDM MODULATION

| CHANNEL | CHANNEL FREQUENCY (MHz) | RF POWER LEVEL IN 3kHz BW (dBm) | MAXIMUM LIMIT (dBm) | PASS / FAIL |
|---------|-------------------------|---------------------------------|---------------------|-------------|
| 149 | 5745 | -4.7 | 8 | PASS |
| 157 | 5785 | -4.4 | 8 | PASS |
| 165 | 5825 | -2.9 | 8 | PASS |

CH165

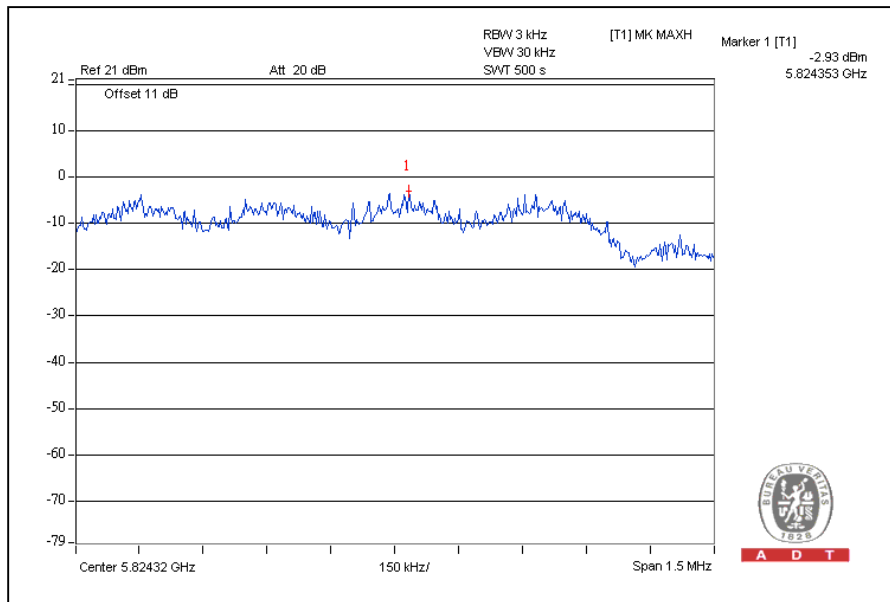



A D T

802.11n (20MHz) OFDM MODULATION:

| CHANNEL | CHANNEL FREQUENCY (MHz) | RF POWER LEVEL IN 3kHz BW (dBm) | | TOTAL POWER DENSITY (dBm) | MAXIMUM LIMIT (dBm) | PASS / FAIL |
|---------|-------------------------|---------------------------------|----------|---------------------------|---------------------|-------------|
| | | CHAIN(0) | CHAIN(1) | | | |
| 149 | 5745 | -5.4 | -4.8 | -2.1 | 8 | PASS |
| 157 | 5785 | -4.5 | -3.5 | -1.0 | 8 | PASS |
| 165 | 5825 | -5.2 | -4.8 | -2.0 | 8 | PASS |

For Chain(1): CH157

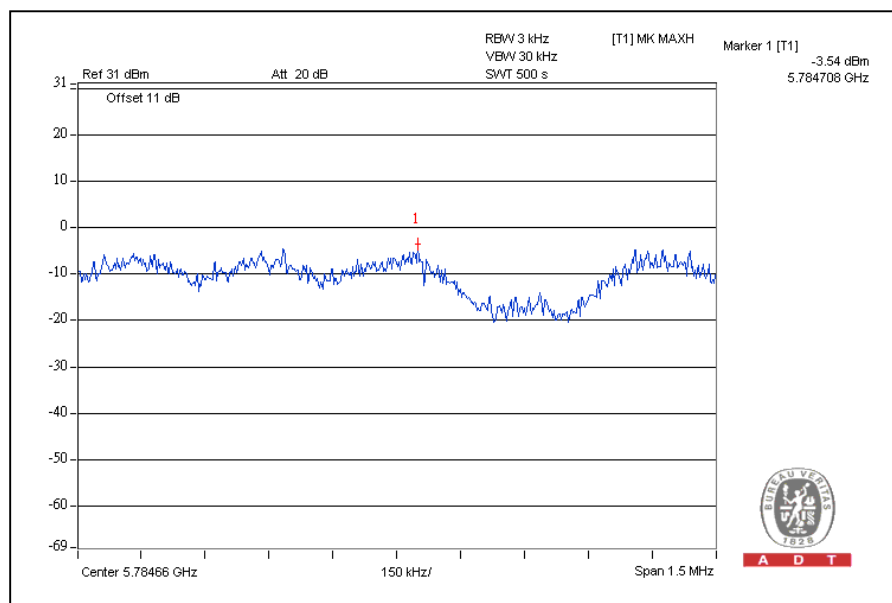



A D T

802.11n (40MHz) OFDM MODULATION:

| CHANNEL | CHANNEL FREQUENCY (MHz) | RF POWER LEVEL IN 3kHz BW (dBm) | | TOTAL POWER DENSITY (dBm) | MAXIMUM LIMIT (dBm) | PASS / FAIL |
|---------|-------------------------|---------------------------------|----------|---------------------------|---------------------|-------------|
| | | CHAIN(0) | CHAIN(1) | | | |
| 151 | 5755 | -11.4 | -12.1 | -8.7 | 8 | PASS |
| 159 | 5795 | -7.1 | -7.7 | -4.4 | 8 | PASS |

For Chain(0): CH159

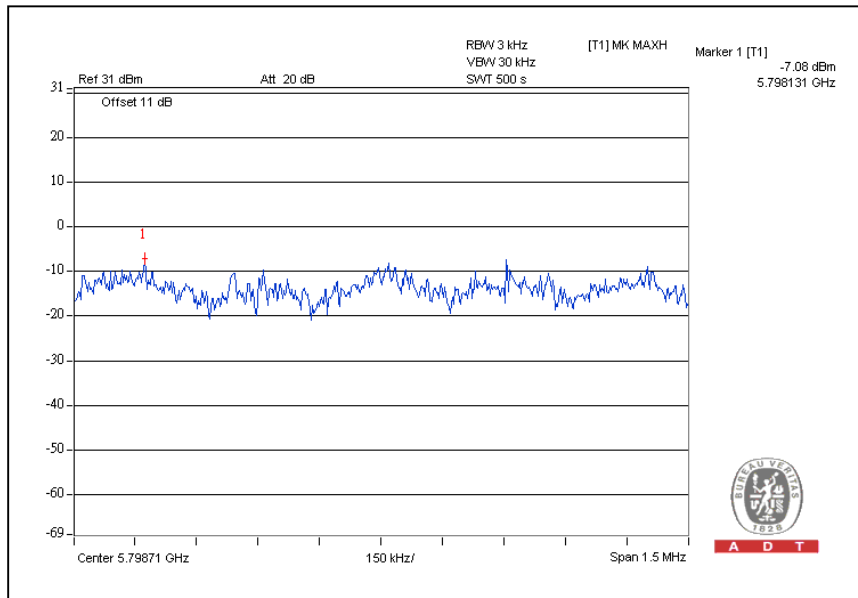

5.6 CONDUCTED OUT-BAND EMISSION MEASUREMENT

5.6.1 LIMITS OF CONDUCTED OUT-BAND EMISSION MEASUREMENT

Below -20dB of the highest emission level of operating band (in 100kHz Resolution Bandwidth).

5.6.2 TEST INSTRUMENTS

| DESCRIPTION & MANUFACTURER | MODEL NO. | SERIAL NO. | CALIBRATED DATE | CALIBRATED UNTIL |
|----------------------------|-----------|------------|-----------------|------------------|
| R&S SPECTRUM ANALYZER | FSP40 | 100037 | Aug. 03, 2009 | Aug. 02, 2010 |

NOTE:

1. The calibration interval of the above test instruments is 12 months and the calibrations are traceable to NML/ROC and NIST/USA.

5.6.3 TEST PROCEDURE

The transmitter output was connected to the spectrum analyzer via a low loss cable. Set RBW of spectrum analyzer to 100 kHz with suitable frequency span including 100 MHz bandwidth from band edge. The band edges was measured and recorded.

5.6.4 DEVIATION FROM TEST STANDARD

No deviation

5.6.5 EUT OPERATING CONDITION

Same as Item 4.3.6

5.6.6 TEST RESULTS

The spectrum plots are attached on the following pages. D2 line indicates the highest level, D1 line indicates the 20dB offset below D2. It shows compliance with the requirement in part 15.247(d).



A D T

CH149

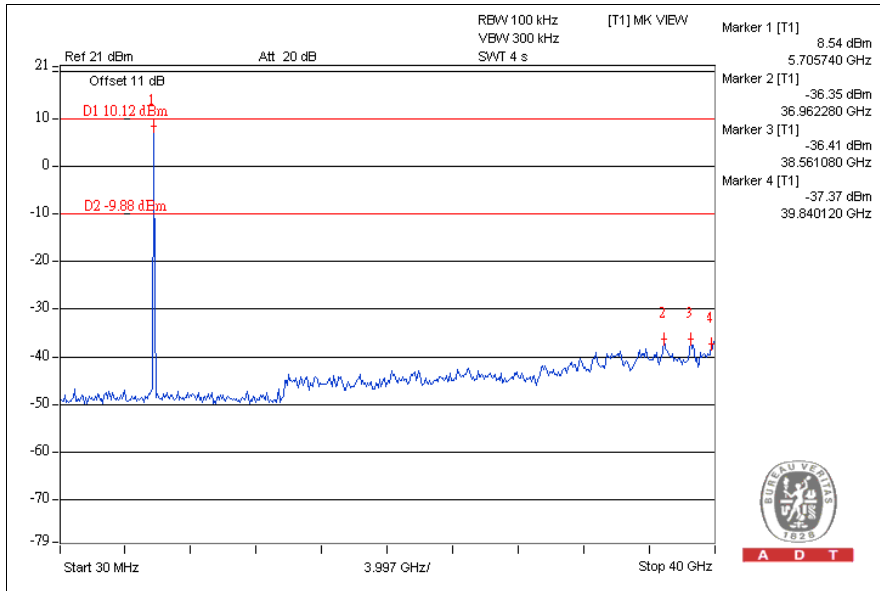

CH165

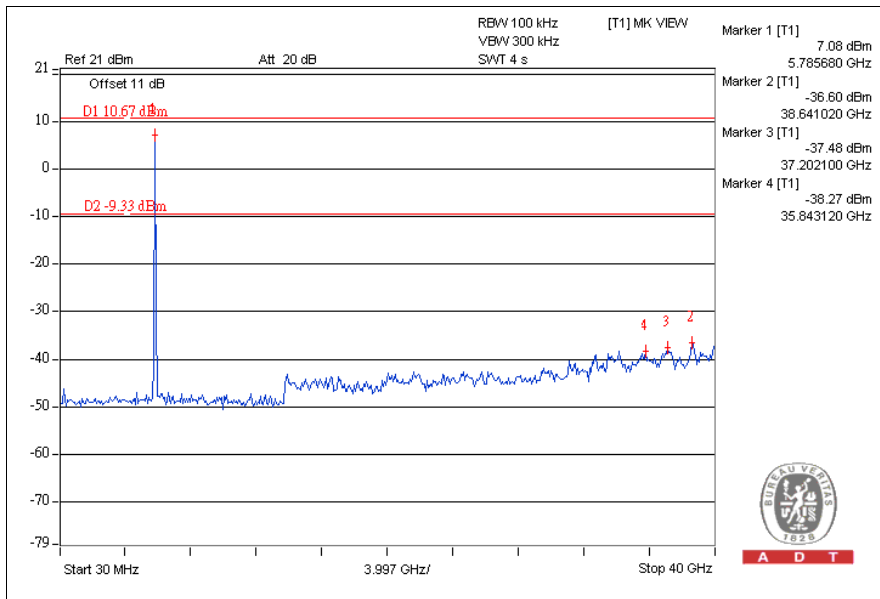



A D T

802.11n (20MHz) OFDM MODULATION:

CH149

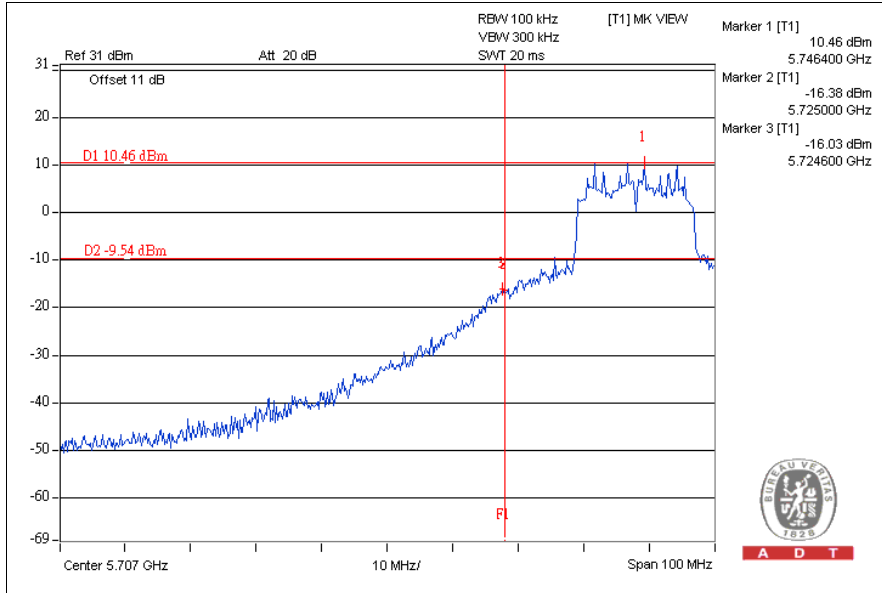

CH165

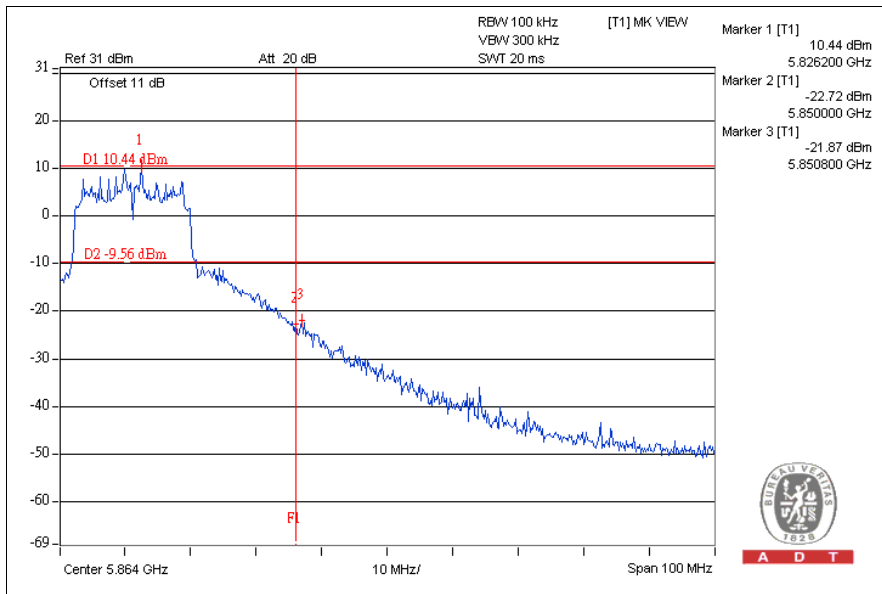



A D T

CH149

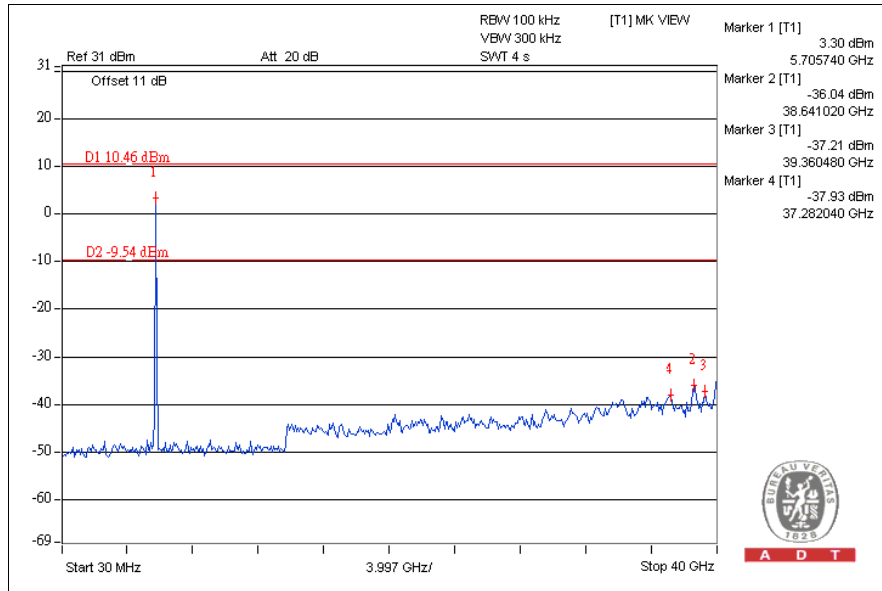

CH165

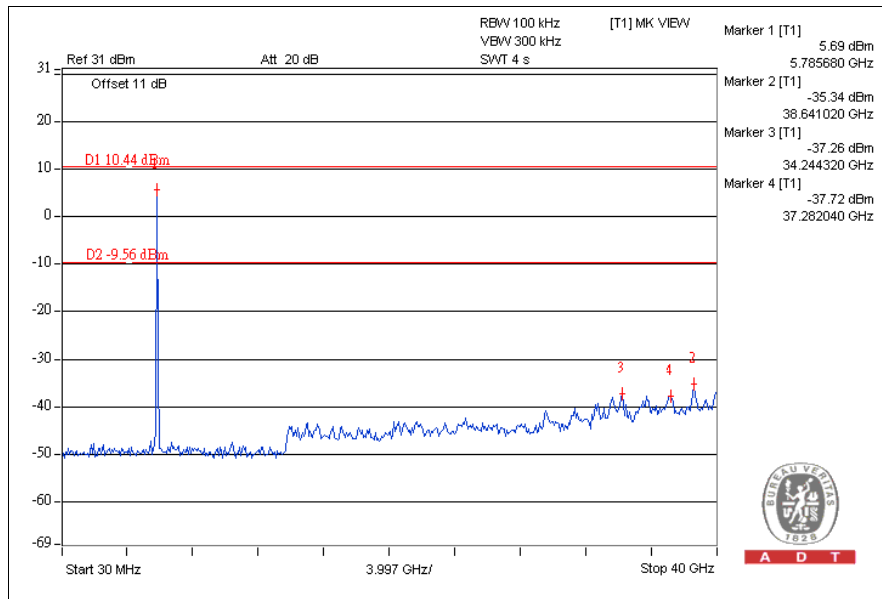



A D T

802.11n (40MHz) OFDM MODULATION:

CH151

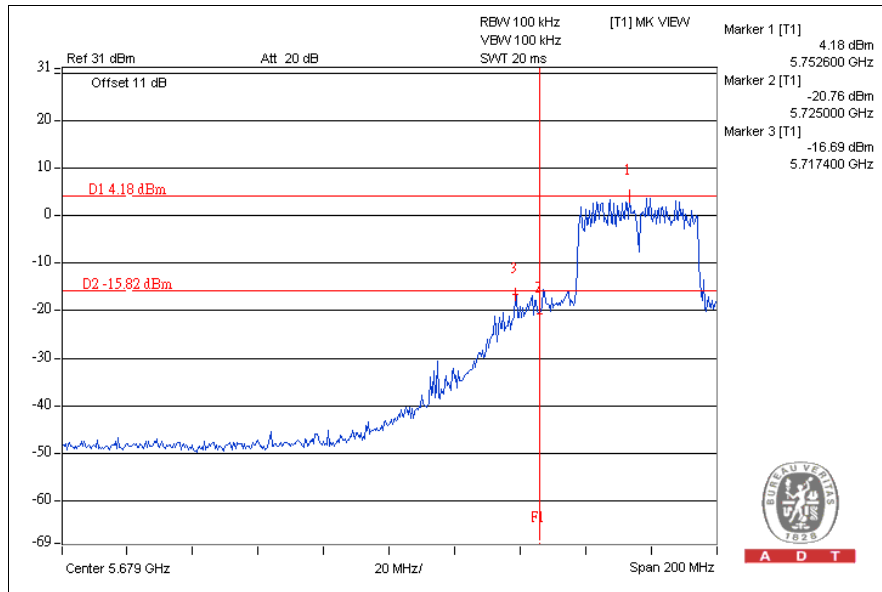

CH159

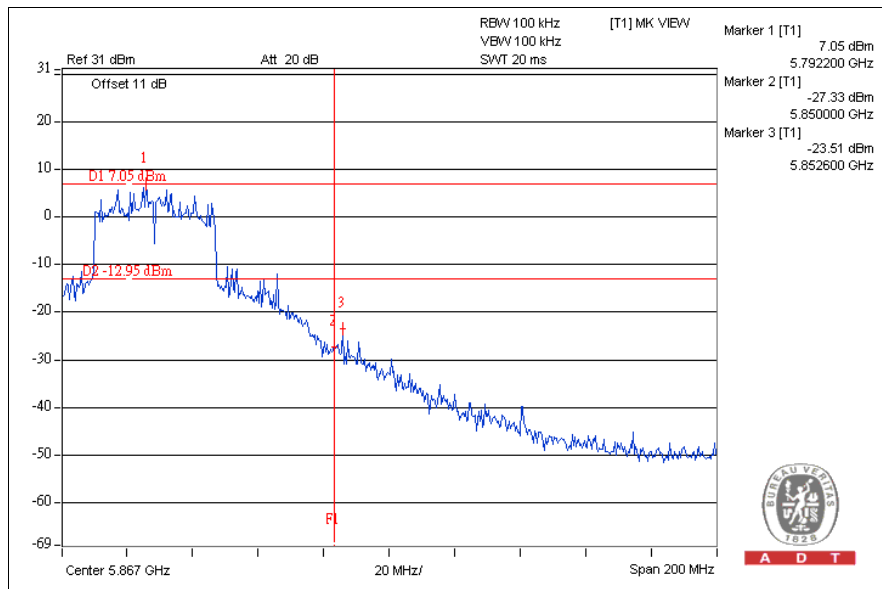



A D T

CH151

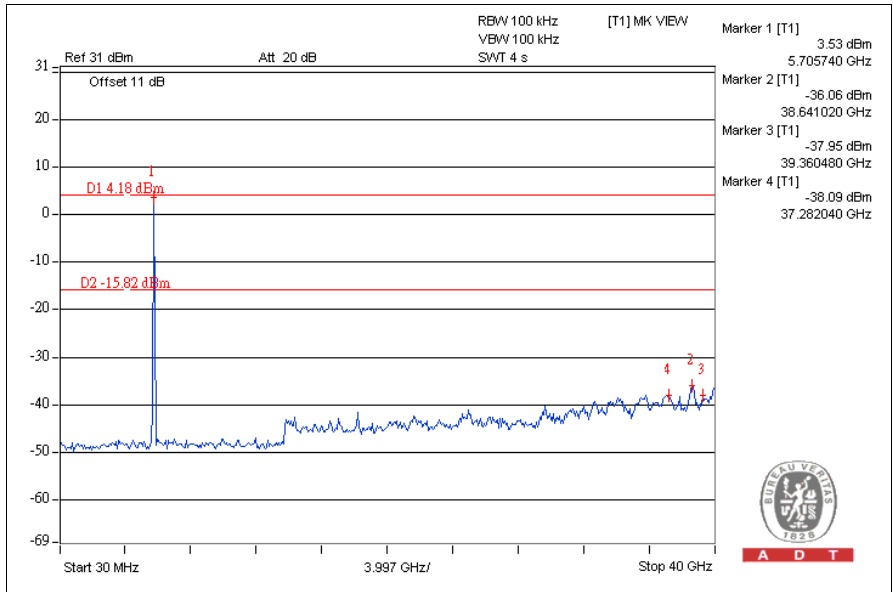

CH159

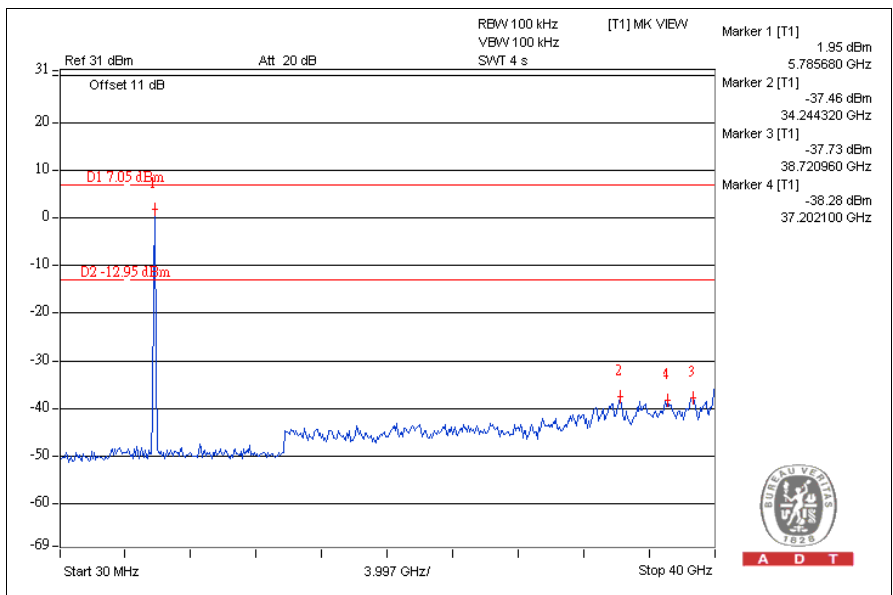



6. INFORMATION ON THE TESTING LABORATORIES

We, Bureau Veritas Consumer Products Services (H.K.) Ltd., Taoyuan Branch, were founded in 1988 to provide our best service in EMC, Radio, Telecom and Safety consultation. Our laboratories are accredited and approved according to ISO/IEC 17025:

Copies of accreditation certificates of our laboratories obtained from approval agencies can be downloaded from our web site:
www.adt.com.tw/index.5/phtml. If you have any comments, please feel free to contact us at the following:

Linko EMC/RF Lab:

Tel: 886-2-26052180

Fax: 886-2-26052943

Hsin Chu EMC/RF Lab:

Tel: 886-3-5935343

Fax: 886-3-5935342

Hwa Ya EMC/RF/Safety Telecom Lab:

Tel: 886-3-3183232

Fax: 886-3-3185050

Web Site: www.adt.com.tw

The address and road map of all our labs can be found in our web site also



A D T

7.APPENDIX A - MODIFICATIONS RECORDERS FOR ENGINEERING CHANGES TO THE EUT BY THE LAB

No any modifications are made to the EUT by the lab during the test.

--- END ---