

RF Test Report

Applicant : Askey Computer Corp

Product Name : Wi-Fi 6 Router

Trade Name : Askey

Model Number : EAI2326

Applicable Standard : FCC 47 CFR PART 15 SUBPART E
ANSI C63.10:2013

Received Date : Aug. 17, 2023

Test Period : Oct 16 ~ Nov. 14, 2021

Issued Date : Aug. 30, 2023

Issued by

Eurofins E&E Wireless Taiwan Co., Ltd.
No. 140-1, Changan Street, Bade District,
Taoyuan City 334025, Taiwan (R.O.C.)
Tel : +886-3-2710188 / Fax : +886-3-2710190



Taiwan Accreditation Foundation accreditation number: 1330
Frequency Range : 9 kHz to 40 GHz
Test Firm Registration Number: 226252 (Bade test site)
Test Firm Registration Number: 191812 (Wugu test site)

Note:

1. The test results are valid only for samples provided by customers and under the test conditions described in this report.
2. This report shall not be reproduced except in full, without the written approval of Eurofins E&E Wireless Taiwan Co., Ltd.
3. The relevant information is provided by customers in this test report. According to the correctness, appropriateness or completeness of the information provided by the customer, if there is any doubt or error in the information which affects the validity of the test results, the laboratory does not take the responsibility.

Revision History

Version	Issued Date	Revisions	Revised By
00	Aug. 30, 2023	Initial Issue	Nicole Chu

Verification of Compliance

Applicant : Askey Computer Corp

Product Name : Wi-Fi 6 Router

Trade Name : Askey

Model Number : EAI2326

FCC ID : H8NEAI2326

Applicable Standard : FCC 47 CFR PART 15 SUBPART E
ANSI C63.10:2013

Test Result : Complied

Performing Lab. : Eurofins E&E Wireless Taiwan Co., Ltd.
No. 140-1, Changan Street, Bade District,
Taoyuan City 334025, Taiwan (R.O.C.)
Tel : +886-3-2710188 / Fax : +886-3-2710190
Taiwan Accreditation Foundation accreditation number: 1330



Eurofins E&E Wireless Taiwan Co., Ltd. tested the above equipment in accordance with the requirements set forth in the above standards. All indications of Pass/Fail in this report are opinions expressed by Eurofins E&E Wireless Taiwan Co., Ltd. based on interpretations and/or observations of test results. The test results show that the equipment tested is capable of demonstrating compliance with the requirements as documented in this report.

Approved By : _____

TABLE OF CONTENTS

1	General Information.....	5
	1.1. Summary of Test Result.....	5
	1.2. Testing Location.....	6
	1.3. Measurement Uncertainty.....	6
2	EUT Description.....	7
3	Test Methodology.....	12
	3.1. Mode of Operation.....	12
	3.2. EUT Test Step.....	14
	3.3. Test Site Environment.....	6
	3.4. Configuration of Test System Details.....	15
	3.5. Test Instruments.....	16
4	Measurement Procedure.....	20
	4.1. AC Power Conducted Emission Measurement.....	20
	4.2. Transmitter Radiated Emissions Measurement.....	22
	4.3. Maximum Conducted Output Power and Transmit power control Measurement.....	27
	4.4. 26 dB RF Bandwidth Measurement.....	29
	4.5. 6 dB RF Bandwidth Measurement.....	30
	4.6. Maximum Power Spectral Density Measurement.....	31
	4.7. Automatically discontinue transmission.....	33
	4.8. Antenna Requirement.....	33
5	Test Results.....	36
	5.1. Conducted Emission.....	36
	5.2. Radiated Emission Measurement.....	38
	5.3. Conducted Test Results.....	420

Appendix A. Test Setup Photographs

1 General Information

1.1. Summary of Test Result

Standard	Item	Result	Remark
15.407(b)(9) 15.207	AC Power Conducted Emission	PASS	---
15.407(b) 15.205 / 15.209	Transmitter Radiated Emissions	PASS	---
15.407(a)	Maximum Conducted Output Power	PASS	---
15.407(a)	26 dB RF Bandwidth	Reference	---
15.407(e)	6 dB RF Bandwidth	PASS	---
15.407(a)	Maximum Power Spectral Density	PASS	---
15.407(c)	Automatically discontinue transmission	PASS	---
15.407(a) 15.203	Antenna Requirement	PASS	---

Decision Rule

- Uncertainty is not included.
- Uncertainty is included.

Standard	Description
CFR47, Part 15, Subpart C	Intentional Radiators
CFR47, Part 15, Subpart E	Unlicensed National Information Infrastructure Devices
ANSI C63. 10: 2013	American National Standard of Procedures for Compliance Testing of Unlicensed Wireless Devices
KDB789033: D02	Guidelines for Compliance Testing of Unlicensed National Information Infrastructure (U-NII) Devices Part 15, Subpart E
KDB 662911 D01 v02r01	Emissions Testing of Transmitters with Multiple Outputs in the Same Band (e.g., MIMO, Smart Antenna, etc)

1.2. Testing Location

Lab Name: Eurofins E&E Wireless Taiwan Co., Ltd.

Site Address: No. 140-1, Changan Street, Bade District, Taoyuan City 334025, Taiwan (R.O.C.)

Site Address: No. 2, Wuquan 5th Rd. Wugu Dist., New Taipei City, Taiwan (R.O.C.)

1.3. Measurement Uncertainty

Test Item	Frequency Range	Uncertainty
Conducted Emission	150 kHz ~ 30 MHz	2.7 dB
Radiated Emission	9 kHz ~ 30 MHz	2.2 dB
	30 MHz ~ 1000 MHz	5.1 dB
	1000 MHz ~ 18000 MHz	5.2 dB
	18000 MHz ~ 26500 MHz	4.6 dB
	26500 MHz ~ 40000 MHz	4.6 dB
Conducted Output Power		1.1 dB
RF Bandwidth		4.7 %
Power Spectral Density		1.1 dB
Frequency Stability		1.3×10^{-7}
Duty Cycle		1.1 %
Time Occupancy		1.5 %

1.4. Test Site Environment

Items	Required (IEC 60068-1)	Interval(*)
Temperature (°C)	15-35	20-30
Humidity (%RH)	25-75	45-75

(*)The measurement ambient temperature is within this range.

2 EUT Description

The product specifications of the EUT presented in the report are declared by the manufacturer who shall take full responsibility for the authenticity(except Max. RF Output Power).

Applicant	Askey Computer Corp 10F, No. 119, JIANKANG RD. ZHONGHE DIST, NEW TAIPEI CITY, Taiwan		
Product Name	Wi-Fi 6 Router		
Trade Name	Askey		
Model Number	EAI2326		
FCC ID	H8NEAI2326		
Operate Frequency	Frequency Band		Frequency Range (MHz)
	IEEE 802.11a	U-NII Band I	5180 – 5240
		U-NII Band II-A	5260 – 5320
		U-NII Band II-C	5500 – 5700
		U-NII Band III	5745 – 5825
	IEEE 802.11n 5 GHz 20 MHz / IEEE 802.11ac 20 MHz/ IEEE 802.11ax 20 MHz	U-NII Band I	5180 – 5240
		U-NII Band II-A	5260 – 5320
		U-NII Band II-C	5500 – 5700
		U-NII Band III	5745 – 5825
	IEEE 802.11n 5 GHz 40 MHz / IEEE 802.11ac 40 MHz/ IEEE 802.11ax 40 MHz	U-NII Band I	5190 – 5230
		U-NII Band II-A	5270 – 5310
		U-NII Band II-C	5510 – 5670
		U-NII Band III	5755 – 5795
	IEEE 802.11ac 80 MHz/ IEEE 802.11ax 80 MHz	U-NII Band I	5210
		U-NII Band II-A	5290
		U-NII Band II-C	5530
U-NII Band III		5775	
Modulation Type	OFDM/OFDMA		

	Antenna	Model	Type	Max. Gain (dBi)	
Antenna information	ANT-0	N03AKANF-T-PK1-E140U	PCB Antenna	U-NII Band I	5.9
				U-NII Band II-A	5.8
				U-NII Band II-C	4.6
				U-NII Band III	5.1
	ANT-1	N03AKANG-T-PK1-K195U	PCB Antenna	U-NII Band I	5.6
				U-NII Band II-A	5.6
				U-NII Band II-C	4.8
				U-NII Band III	5.1
	ANT-2	N03AKANH-T-PK1-P85U	PCB Antenna	U-NII Band I	4.3
				U-NII Band II-A	4.6
				U-NII Band II-C	4.4
				U-NII Band III	4.5
	ANT-3	N03AKANJ-T-PK1-R65U	PCB Antenna	U-NII Band I	5.3
				U-NII Band II-A	5.0
				U-NII Band II-C	4.8
				U-NII Band III	5.4
Antenna Delivery	Reference section 3.1				
Operate Temp. Range	0 ~ 40 °C				
EUT Power Rating	DC 12.0 V, 3.0 A				

EUT Modify Description :

Modify Description:

For the purpose of marketing, a new FCC ID: H8NEAI2326 is established for the changes on the product name and trade name and model number, the layout and electronic characteristics are same.

The differences won't influence the test results. Therefore, all test items don't need to be re-evaluated.

The test data refer to the original report and showed in this report and renew external photos.

Original Report : 2111FR17

Modify: USRC238169002

Frequency Band		RF Output Power (W)
IEEE 802.11a	U-NII Band I	0.174
	U-NII Band II-A	0.050
	U-NII Band II-C	0.049
	U-NII Band III	0.932
IEEE 802.11n 5 GHz 20 MHz	U-NII Band I	0.167
	U-NII Band II-A	0.049
	U-NII Band II-C	0.055
	U-NII Band III	0.851
IEEE 802.11n 5 GHz 40 MHz	U-NII Band I	0.339
	U-NII Band II-A	0.083
	U-NII Band II-C	0.085
	U-NII Band III	0.880
IEEE 802.11ac 20 MHz	U-NII Band I	0.169
	U-NII Band II-A	0.049
	U-NII Band II-C	0.055
	U-NII Band III	0.892
IEEE 802.11ac 40 MHz	U-NII Band I	0.348
	U-NII Band II-A	0.085
	U-NII Band II-C	0.088
	U-NII Band III	0.914
IEEE 802.11ac 80 MHz	U-NII Band I	0.212
	U-NII Band II-A	0.138
	U-NII Band II-C	0.167
	U-NII Band III	0.647
IEEE 802.11ax 20 MHz	U-NII Band I	0.172
	U-NII Band II-A	0.050
	U-NII Band II-C	0.056
	U-NII Band III	0.954
IEEE 802.11ax 40 MHz	U-NII Band I	0.356
	U-NII Band II-A	0.086
	U-NII Band II-C	0.093
	U-NII Band III	0.974
IEEE 802.11ax 80 MHz	U-NII Band I	0.216
	U-NII Band II-A	0.148
	U-NII Band II-C	0.177
	U-NII Band III	0.674

Beamforming on

Frequency Band		RF Output Power (W)
IEEE 802.11n 5 GHz 20 MHz	U-NII Band I	0.179
	U-NII Band II-A	0.047
	U-NII Band II-C	0.054
	U-NII Band III	0.237
IEEE 802.11n 5 GHz 40 MHz	U-NII Band I	0.223
	U-NII Band II-A	0.063
	U-NII Band II-C	0.076
	U-NII Band III	0.266
IEEE 802.11ac 20 MHz	U-NII Band I	0.185
	U-NII Band II-A	0.057
	U-NII Band II-C	0.057
	U-NII Band III	0.246
IEEE 802.11ac 40 MHz	U-NII Band I	0.234
	U-NII Band II-A	0.065
	U-NII Band II-C	0.078
	U-NII Band III	0.278
IEEE 802.11ac 80 MHz	U-NII Band I	0.197
	U-NII Band II-A	0.066
	U-NII Band II-C	0.078
	U-NII Band III	0.263
IEEE 802.11ax 20 MHz	U-NII Band I	0.199
	U-NII Band II-A	0.052
	U-NII Band II-C	0.060
	U-NII Band III	0.263
IEEE 802.11ax 40 MHz	U-NII Band I	0.250
	U-NII Band II-A	0.069
	U-NII Band II-C	0.083
	U-NII Band III	0.298
IEEE 802.11ax 80 MHz	U-NII Band I	0.211
	U-NII Band II-A	0.070
	U-NII Band II-C	0.083
	U-NII Band III	0.282

Equipment Type		
Outdoor access point	point-to-point	---
	point-to-multipoint	---
Indoor access point		V
Fixed point-to-point access points		---
Client devices		---

WIFI 5G

5150 MHz ~5250 MHz(UNII-1):

BW 20M	CH	36	40	44	48
	Freq. (MHz)	5180	5200	5220	5240
BW 40M	CH	38		46	
	Freq. (MHz)	5190		5230	
BW 80M	CH	42			
	Freq. (MHz)	5210			

5250 MHz ~5350 MHz(UNII-2A):

BW 20M	CH	52	56	60	64
	Freq. (MHz)	5260	5280	5300	5320
BW 40M	CH	54		62	
	Freq. (MHz)	5270		5310	
BW 80M	CH	58			
	Freq. (MHz)	5290			

5470 MHz ~5725 MHz(UNII-2C):

BW 20M	CH	100	104	108	112	116	120	124	128	132	136	140	---
	Freq. (MHz)	5500	5520	5540	5560	5580	5600	5620	5640	5660	5680	5700	---
BW 40M	CH	102		110		118		126		134		---	
	Freq. (MHz)	5510		5550		5590		5630		5670		---	
BW 80M	CH	106				---				---			
	Freq. (MHz)	5530				---				---			

5725 MHz ~5850 MHz(UNII-3):

BW 20M	CH	149			153	157	161	165
	Freq. (MHz)	5745		5765	5785		5805	5825
BW 40M	CH	151			159			NA
	Freq. (MHz)	5755			5795			
BW 80M	CH	155						
	Freq. (MHz)	5775						

Note: Operating in 5600~5650MHz is prohibited in Canada for Master device.

3 Test Methodology

3.1. Mode of Operation

Decision of Test Eurofins has verified the construction and function in typical operation. All the test modes were carried out with the EUT in normal operation, which was shown in this test report and defined as:

Pre-Test Mode
Mode 1: Transmit mode
Mode 2: IEEE 802.11a Continuous TX mode
Mode 3: IEEE 802.11n 5 GHz 20 MHz Continuous TX mode
Mode 4: IEEE 802.11n 5 GHz 40 MHz Continuous TX mode
Mode 5: IEEE 802.11ac 20 MHz Continuous TX mode
Mode 6: IEEE 802.11ac 40 MHz Continuous TX mode
Mode 7: IEEE 802.11ac 80 MHz Continuous TX mode
Mode 8: IEEE 802.11ax 20 MHz Continuous TX mode
Mode 9: IEEE 802.11ax 40 MHz Continuous TX mode
Mode 10: IEEE 802.11ax 80 MHz Continuous TX mode

Final-Test Mode
Mode 1: Transmit mode
Mode 2: IEEE 802.11a Continuous TX mode
Mode 8: IEEE 802.11ax 20 MHz Continuous TX mode
Mode 9: IEEE 802.11ax 40 MHz Continuous TX mode
Mode 10: IEEE 802.11ax 80 MHz Continuous TX mode

Software used to control the EUT for staying in continuous transmitting mode was programmed.

After verification, all tests were carried out with the worst case test modes.

Note 1: Investigation has been done on all the possible configurations for searching the worst cases (HE20/HE40/HE80 covers VHT20/VHT40/VHT80 & HT20/HT40). The table is a list of the test modes show in this test report.

Note 2: IEEE 802.11ax only support the Full RU.

Test Mode	ANT-0	ANT-1	ANT-2	ANT-3	ANT-0+1+2+3
Mode 2	V	V	V	V	V
Mode 3	V	V	V	V	V
Mode 4	V	V	V	V	V
Mode 5	V	V	V	V	V
Mode 6	V	V	V	V	V
Mode 7	V	V	V	V	V
Mode 8	V	V	V	V	V
Mode 9	V	V	V	V	V
Mode 10	V	V	V	V	V

Test Mode	Antenna Delivery	Data Rate (Mbps)	Band	Test Channel
Mode 2	4TX (CDD)	6	U-NII Band I	36, 40, 48
			U-NII Band II-A	52, 56, 64
			U-NII Band II-C	100, 112, 140
			U-NII Band III	149, 157, 165
Mode 3	4TX (CDD/Beamforming on)	26	U-NII Band I	36, 40, 48
			U-NII Band II-A	52, 56, 64
			U-NII Band II-C	100, 112, 140
Mode 4	4TX (CDD/Beamforming on)	54	U-NII Band I	38, 46
			U-NII Band II-A	54, 62
			U-NII Band II-C	102, 110, 134
			U-NII Band III	151, 159
Mode 5	4TX (MIMO/Beamforming on)	26	U-NII Band I	36, 40, 48
			U-NII Band II-A	52, 56, 64
			U-NII Band II-C	100, 112, 140
			U-NII Band III	149, 157, 165
Mode 6	4TX (CDD/Beamforming on)	54	U-NII Band I	38, 46
			U-NII Band II-A	54, 62
			U-NII Band II-C	102, 110, 134
			U-NII Band III	151, 159
Mode 7	4TX (CDD/Beamforming on)	117.2	U-NII Band I	42
			U-NII Band II-A	52, 58
			U-NII Band II-C	106
			U-NII Band III	155
Mode 8	4TX (CDD/Beamforming on)	MCS 0	U-NII Band I	36, 40, 48
			U-NII Band II-A	52, 56, 64
			U-NII Band II-C	100, 112, 140
			U-NII Band III	149, 157, 165
Mode 9	4TX (CDD/Beamforming on)	MCS 0	U-NII Band I	38, 46
			U-NII Band II-A	54, 62
			U-NII Band II-C	102, 110, 134
			U-NII Band III	151, 159
Mode 10	4TX (CDD/Beamforming on)	MCS 0	U-NII Band I	42
			U-NII Band II-A	52, 58
			U-NII Band II-C	106
			U-NII Band III	155

3.2. EUT Test Step

The EUT is operated in the engineering mode to fix the TX frequency for the purposes of measurement. According to its specifications, the EUT must comply with the requirements of Section 15.407 under the FCC Rules Part 15 Subpart E.

1.	Setup the EUT shown on "Configuration of Test System Details".
2.	Turn on the power of all equipment.
3.	Turn on TX function.
4.	EUT run test program.

Measurement Software			
No.	Description	Software	Version
1	Conducted Emission	EZ EMC	1.1.4.3
2	Radiated Emission	EZ EMC	1.1.4.4

3.3. Configuration of Test System Details

Conducted Emissions

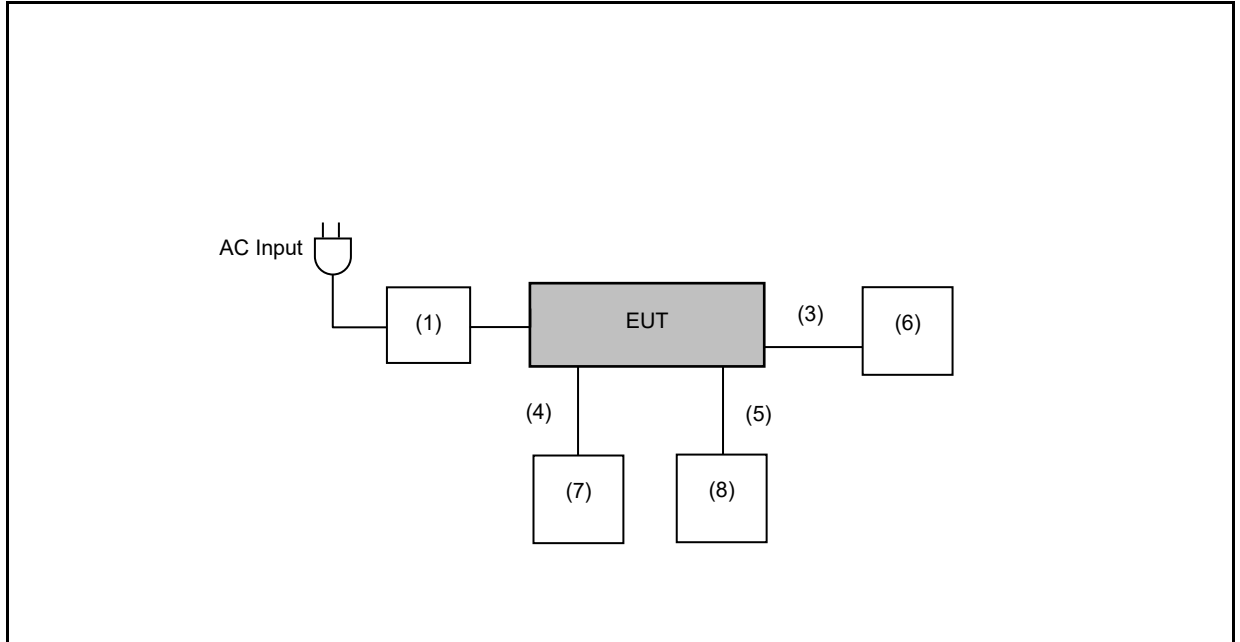

Radiated Emission

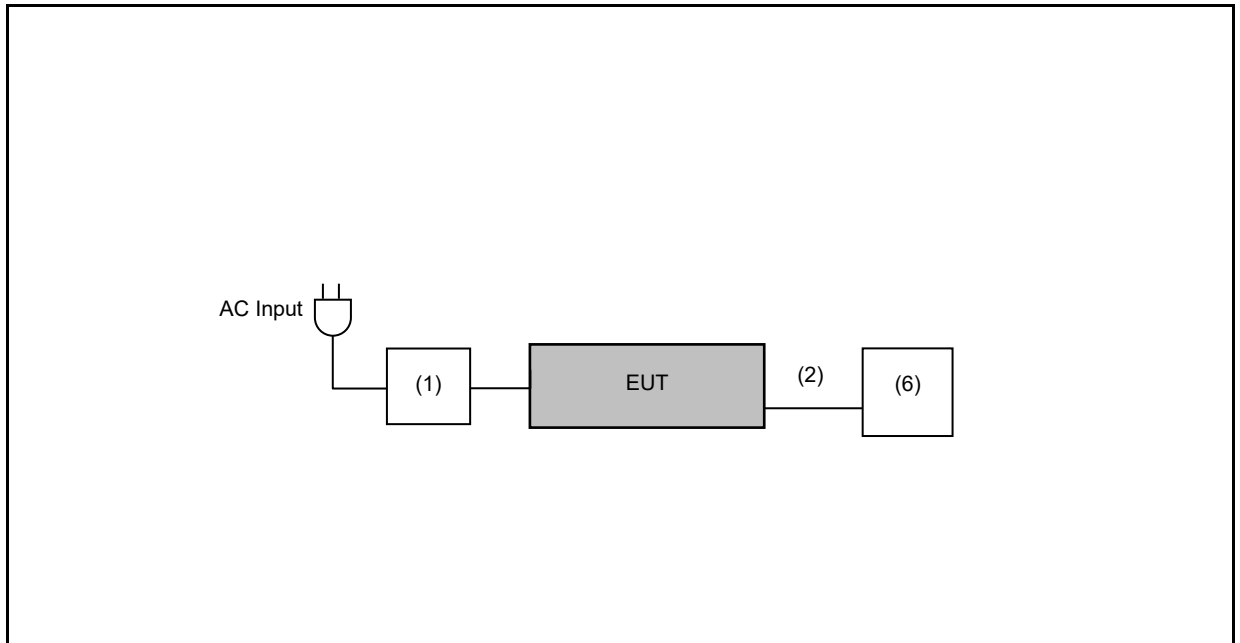

Devices Description					
	Product	Manufacturer	Model Number	Serial Number	Remark
(1)	AC Adapter	Sunny	SYS1618-3612-W2	---	I/P: 100-240 VAC, 50-60 Hz, 1.5 A O/P: 12.0 VDC, 3.0 A
(2)	Lan Cable	TATUNG	CAT5E	---	---
(3)	Lan Cable	LIYOU YUANE	SP-YX-MF-860	---	---
(4)	Lan Cable	LIYOU YUANE	SP-YX-MF-860	---	---
(5)	Lan Cable	HUAWEI	UL2464	---	---
(6)	Notebook	HP	TPN-I130	---	---
(7)	Notebook	ASUS	P2430U	---	---
(8)	Notebook	ASUS	P1448U	---	---

3.4. Test Instruments

For Conducted Emission

Test Period: Oct. 30, 2021

Testing Engineer: Louis Shen

Use	Equipment	Manufacturer	Model Number	Serial Number	Cal. Date	Cal. Period
<input checked="" type="checkbox"/>	Test Receiver	R&S	ESCI	100367	05/21/2021	1 year
<input checked="" type="checkbox"/>	LISN	R&S	ENV216	101040	03/29/2021	1 year
<input checked="" type="checkbox"/>	LISN	R&S	ENV216	101041	04/08/2021	1 year
<input checked="" type="checkbox"/>	RF Cable	Woken	00100D1380194M	TE-02-03	05/28/2021	1 year

For Conducted

Test Period: Oct. 12 ~ Nov. 14, 2021

Testing Engineer: Brain Lin, Andy Lu, Peter Shui

Use	Equipment	Manufacturer	Model Number	Serial Number	Cal. Date	Cal. Period
<input checked="" type="checkbox"/>	Power Sensor	Anritsu	MA2411B	1126022	09/03/2021	1 year
<input checked="" type="checkbox"/>	Power Meter	Anritsu	ML2495A	1135009	09/03/2021	1 year
<input checked="" type="checkbox"/>	Spectrum Analyzer (20 Hz~26.5 GHz)	Agilent	N9020A	US47520902	09/09/2021	1 year
<input checked="" type="checkbox"/>	Signal Generator	Keysight	N5182B	MY53052569	04/20/2021	1 year
<input checked="" type="checkbox"/>	Signal Generator	Keysight	N5182BX07	MY59360221	04/20/2021	1 year

Note: N.C.R. = No Calibration Request.

For Radiated Emissions

Test Period: Oct. 16 ~ Oct. 21, 2021

Testing Engineer: Pink Li, Marc Yeh

Use	Equipment	Manufacturer	Model Number	Serial Number	Cal. Date	Cal. Period
<input checked="" type="checkbox"/>	Spectrum Analyzer (2 Hz~50 GHz)	Keysight	N9030B	MY57143537	04/19/2021	1 year
<input checked="" type="checkbox"/>	Amplifier (100 kHz~1.3 GHz)	Agilent	8447D	2944A11119	01/15/2021	1 year
<input checked="" type="checkbox"/>	Broadband Amplifier (1 GHz~26.5 GHz)	Titan	T0912E01263025A 1F	002	07/26/2021	1 year
<input checked="" type="checkbox"/>	Preamplifier (26.5 GHz~40 GHz)	EMCI	EMC2654045	980028	08/19/2021	1 year
<input checked="" type="checkbox"/>	Loop Antenna (9 kHz~30 MHz)	COM-POWER CORPORATION	AL-130	121014	04/07/2021	1 year
<input checked="" type="checkbox"/>	Trilog Broadband Antenna (30 kHz~1 GHz)	Schwarzbeck Mess- Elektronik	VULB9168	01146	07/19/2021	1 year
<input checked="" type="checkbox"/>	Broadband Horn Antenna (1 GHz~18 GHz)	Schwarzbeck Mess- Elektronik	9120D	02207	07/09/2021	1 year
<input checked="" type="checkbox"/>	Broadband Horn Antenna (18 GHz~40 GHz)	Schwarzbeck Mess- Elektronik	9170	9170-320	08/24/2021	1 year

Note: N.C.R. = No Calibration Request.

Use	Equipment	Manufacturer	Model Number	Serial Number	Cal. Date	Cal. Period
<input checked="" type="checkbox"/>	Coaxial Cable	Titan	T0710AT327A10A1 00	J11005	08/06/2021	1 year
<input checked="" type="checkbox"/>	Coaxial Cable	Titan	T0710AT327A10A9 00	J11004	08/06/2021	1 year
<input checked="" type="checkbox"/>	Coaxial Cable	Titan	CFD400NL-LW	001	08/06/2021	1 year

Note: N.C.R. = No Calibration Request.

4 Measurement Procedure

4.1. AC Power Conducted Emission Measurement

■ Limit

Frequency (MHz)	Quasi-peak	Average
0.15 - 0.5	66 to 56	56 to 46
0.50 - 5.0	56	46
5.0 - 30.0	60	50

■ Test Setup

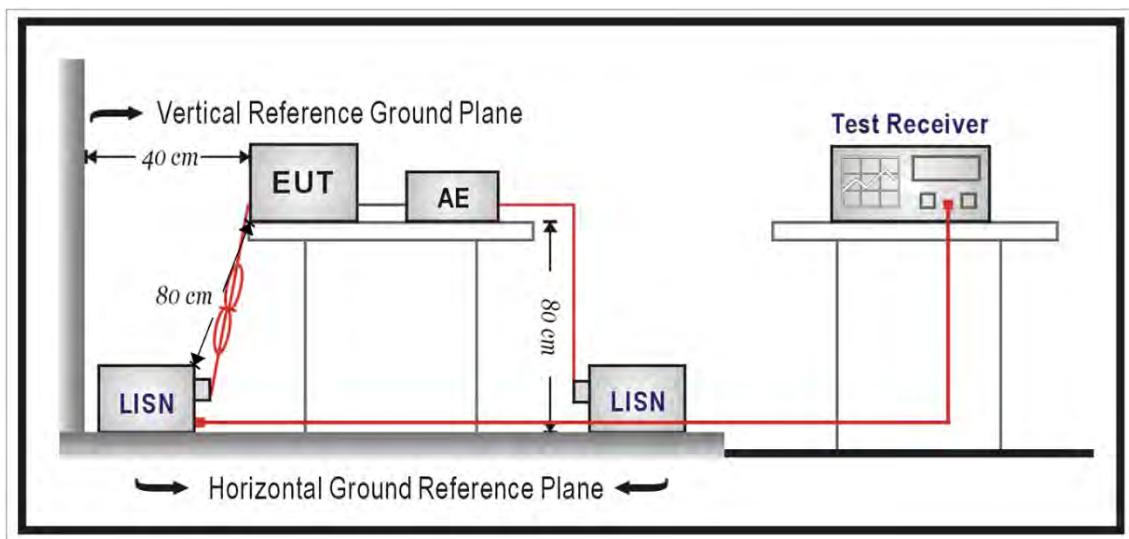

■ Test Procedure

The EUT and simulators are connected to the main power through a line impedance stabilization network (L.I.S.N.). This provides a $50 \Omega // 50 \mu\text{H}$ coupling impedance for the measuring equipment. The peripheral devices are also connected to the main power through a LISN that provides a $50 \Omega // 50 \mu\text{H}$ coupling impedance with 50 ohm termination.

Tabletop device shall be placed on a non-conducting platform, of nominal size 1 m by 1.5 m, raised 80 cm above the reference ground plane. The wall of screened room shall be located 40 cm to the rear of the EUT. Other surfaces of tabletop or floor standing EUT shall be at least 80 cm from any other ground conducting surface including one or more LISNs. For floor-standing device shall be placed under the EUT with a 12 mm insulating material.

Conducted emissions were investigated over the frequency range from 0.15 MHz to 30 MHz using a resolution bandwidth of 9 kHz. The equipment under test (EUT) shall be meet the limits in section 4.1, as applicable, including the average limit and the quasi-peak limit when using respectively, an average detector and quasi-peak detector measured in accordance with the methods described of related standard. When all of peak value were complied with quasi-peak and average limit from 150 kHz to 30 MHz then quasi-peak and average measurement was unnecessary.

The AMN shall be placed 0.8 m from the boundary of the unit under test and bonded to a ground reference plane for AMNs mounted on top of the ground reference plane. This distance is between the closest points of the AMN and the EUT. All other units of the EUT and associated equipment shall be at least 0.8 m from the AMN. If the mains power cable is longer than 1 m then the cable shall be folded back and forth at the centre of the lead to form a bundle no longer than 0.4 m. All of interconnecting cables that hang closer than 40 cm to the ground plane shall be folded back and forth in the center forming a bundle 30 cm to 40 cm long. All of EUT and AE shall be separate place more than 0.1 m. All 50Ω ports of the LISN shall be resistively terminated into 50Ω loads when not connected to the measuring instrument.

If the reading of the measuring receiver shows fluctuations close to the limit, the reading shall be observed for at least 15 s at each measurement frequency; the higher reading shall be recorded with the exception of any brief isolated high reading which shall be ignored

4.2. Transmitter Radiated Emissions Measurement

■ Limit

(1)Undesirable emission limits. Except as shown in paragraph (b)(9) of this section, the maximum emissions outside of the frequency bands of operation shall be attenuated in accordance with the following limits:

(a)For transmitters operating in the 5.15-5.25 GHz band: All emissions outside of the 5.15-5.35 GHz band shall not exceed an e.i.r.p. of -27 dBm/MHz.

(b)For transmitters operating in the 5.25-5.35 GHz band: All emissions outside of the 5.15-5.35 GHz band shall not exceed an e.i.r.p. of -27 dBm/MHz.

(c)For transmitters operating in the 5.47-5.725 GHz band: All emissions outside of the 5.47-5.725 GHz band shall not exceed an e.i.r.p. of -27 dBm/MHz.

(d)For transmitters operating in the 5.725-5.85 GHz band:

(i)All emissions shall be limited to a level of -27 dBm/MHz at 75 MHz or more above or below the band edge increasing linearly to 10 dBm/MHz at 25 MHz above or below the band edge, and from 25 MHz above or below the band edge increasing linearly to a level of 15.6 dBm/MHz at 5 MHz above or below the band edge, and from 5 MHz above or below the band edge increasing linearly to a level of 27 dBm/MHz at the band edge.

EIRP (dBm)	Field Strength at 3 m(dBuV/m)
-27	68.3

(2)Limits of Radiated Emission Measurement

Emissions radiated outside of the specified bands, shall be according to the general radiated limits in 15.209 as following:

Frequency Range (MHz)	Field Strength (microvolts/meter)	Measurement Distance (meters)
0.009 ~ 0.490	2400/F(kHz)	300
0.490 ~ 1.705	24000/F(kHz)	30
1.705 ~ 30.0	30	30
30 ~ 88	10	3
88 ~ 216	150	3
216 ~ 960	200	3
Above 960	500	3

- Note:
1. The lower limit shall apply at the transition frequencies.
 2. Emission level (dBuV/m) = 20 log Emission level (uV/m).
 3. As shown in 15.35(b), for frequencies above 1000 MHz, the field strength limits are based on average detector, however, the peak field strength of any emission shall not exceed the maximum permitted average limits, specified above by more than 20 dB under any condition of modulation.

■ Setup

9 kHz ~ 30 MHz

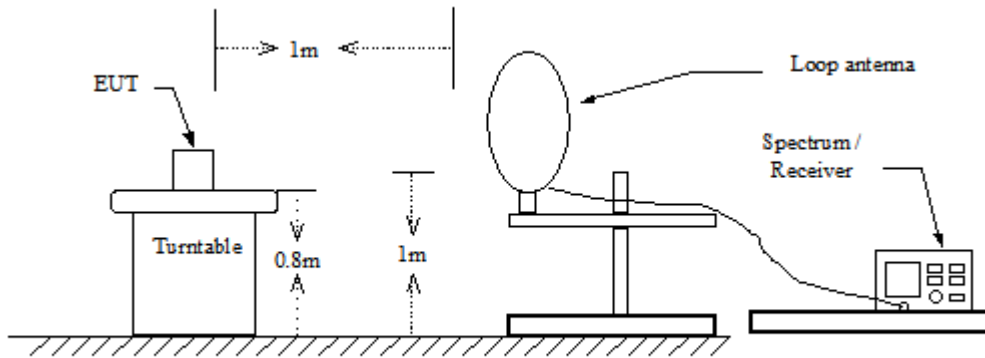

30 MHz ~ 1 GHz

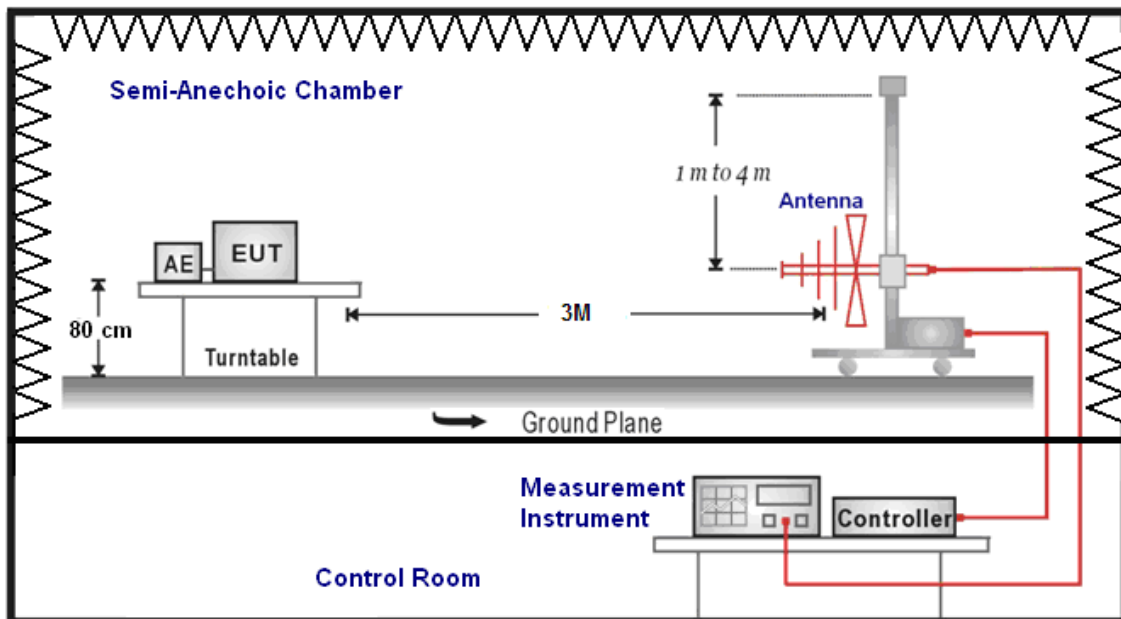

Above 1 GHz

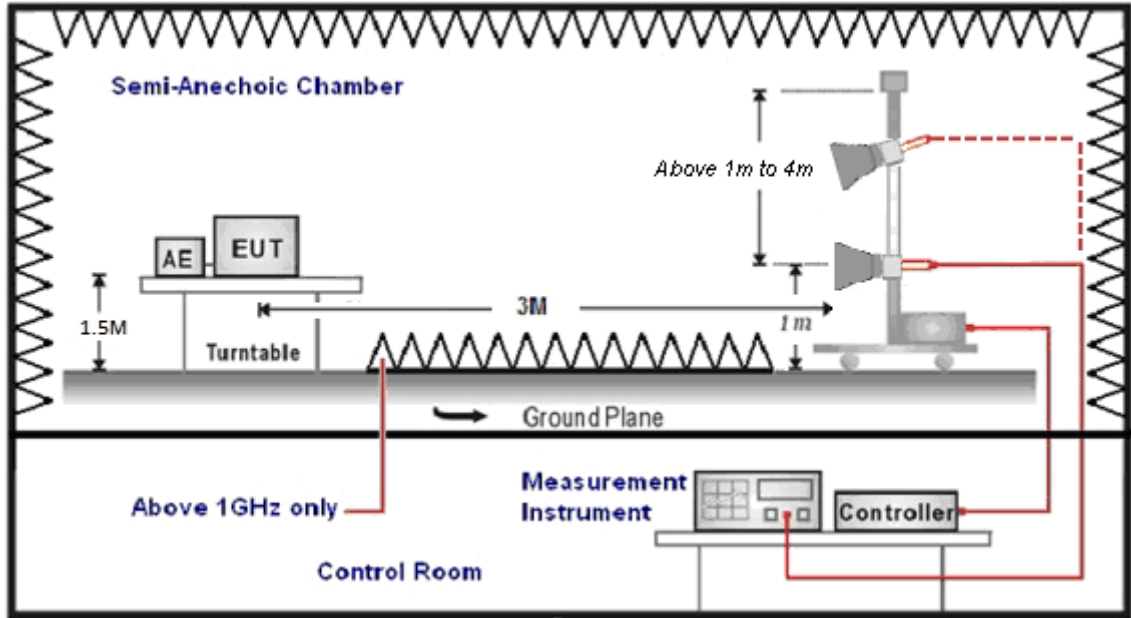

■ Test Procedure

Final radiation measurements were made on a three-meter, Semi Anechoic Chamber. The EUT system was placed on a nonconductive turntable which is 0.8 or 1.5 meters height (below 1 GHz use 0.8 m turntable / above 1 GHz use 1.5 m turntable), top surface 1.0 x 1.5 meter. The spectrum was examined from 250 MHz to 2.5 GHz in order to cover the whole spectrum below 10th harmonic which could generate from the EUT. During the test, EUT was set to transmit continuously & Measurements spectrum range from 9 kHz to 40 GHz is investigated.

For measurements below 30 MHz the resolution bandwidth is set to 10 kHz for peak detection measurements or 9 kHz for quasi-peak detection measurements. The video bandwidth is 3 times of the resolution bandwidth.

For measurements below 1 GHz the resolution bandwidth is set to 100 kHz for peak detection measurements or 120 kHz for quasi-peak detection measurements. Peak detection is used unless otherwise noted as quasi-peak.

For restricted measurements above 1 GHz the resolution bandwidth is set to 1 MHz, and then the video bandwidth is set to 3 MHz for peak measurements and 10 Hz for average measurements when Duty cycle > 0.98 / 1/T for average measurements when Duty cycle < 0.98.

For out of band measurements above 1 GHz the resolution bandwidth is set to 1 MHz, and then the video bandwidth is set to 3 MHz for peak measurements.

A nonconductive material surrounded the EUT to supporting the EUT for standing on three orthogonal planes. At each condition, the EUT was rotated 360 degrees, and the antenna was raised and lowered from one to four meters to find the maximum emission levels. Measurements were taken using both horizontal and vertical antenna polarization. SCHWARZBECK MESS-ELEKTRONIK Trilog-Broadband Antenna at 3 Meter and the ETS-Lindgren Double-Ridged Waveguide Horn antenna Schwarzbeck Mess-Elektronik Broadband Horn Antenna was used in frequencies 1 – 40 GHz at a distance of 3 meter. The antenna at an angle toward the source of the emission. All test results were extrapolated to equivalent signal at 3 meters utilizing an inverse linear distance extrapolation Factor (20 dB/decade).

For testing above 1 GHz, the emission level of the EUT in peak mode was 20 dB lower than average limit (that means the emission level in peak mode also complies with the limit in average mode), then testing will be stopped and peak values of EUT will be reported, otherwise, the emissions will be measured in average mode again and reported.

Appropriate preamplifiers were used for improving sensitivity and precautions were taken to avoid overloading or desensitizing the spectrum analyzer. No post – detector video filters were used in the test.

The spectrum analyzer's 6 dB bandwidth was set to 1 MHz, and the analyzer was operated in the peak detection mode, for frequencies both below and up 1 GHz. The average levels were obtained by subtracting the duty cycle correction factor from the peak readings.

The following procedures were used to convert the emission levels measured in decibels referenced to 1 microvolt (dBuV) into field intensity in micro volts per meter (uV/m).

The actual field intensity in decibels referenced to 1 microvolt in to field intensity in micro volts per meter (dBuV/m).

Data of measurement within this frequency range without mark in the table above means the reading of emissions are attenuated more than 20 dB below the permissible limits or the field strength is too small to be measured.

The actual field intensity in referenced to 1 microvolt per meter (dBuV/m) is determined by algebraically adding the measured reading in dBuV, the antenna factor (dB), and cable loss (dB) and Subtracting the gain of preamplifier (dB) is auto calculate in spectrum analyzer.

(1) $\text{Amplitude (dBuV/m)} = \text{FI (dBuV)} + \text{AF (dBuV)} + \text{CL (dBuV)} - \text{Gain (dB)}$

FI= Reading of the field intensity.

AF= Antenna factor.

CL= Cable loss.

P.S Amplitude is auto calculate in spectrum analyzer.

(2) $\text{Actual Amplitude (dBuV/m)} = \text{Amplitude (dBuV)} - \text{Dis(dB)}$

The FCC specified emission limits were calculated according the EUT operating frequency and by following linear interpolation equations:

(a) For fundamental frequency : Transmitter Output < +30 dBm

(b) For spurious frequency : Spurious emission limits = fundamental emission limit /10

Measuring Instruments and setting

The following table is the setting of spectrum analyzer and receiver.

Spectrum Parameter	Setting
Attenuation	Auto
Start Frequency	1000 MHz
Stop Frequency	40 GHz
RBW/VBW(Emission in restricted band)	1 MHz / 3 MHz for Peak 1 MHz / (1/T) for Average
RBW/VBW(Emission in non-restricted band)	1 MHz / 3 MHz for Peak

4.3. Maximum Conducted Output Power and Transmit power control Measurement

■ Limit

Frequency Range (MHz)	FCC Maximum Conducted Output Power Limit
	Master
5.150 ~ 5.250 GHz	The lesser of 1 W (30 dBm)
5.250 ~ 5.350 GHz	The lesser of 250 mW (24 dBm) or 11 dBm + 10 log (B)
5.470 ~ 5.725 GHz	The lesser of 250 mW (24 dBm) or 11 dBm + 10 log (B)
5.725 ~ 5.850 GHz	The lesser of 1 W (30 dBm)

Frequency Range (MHz)	5.850 ~ 5.895 GHz or spans across 5.725-5.895 GHz	
Device Type	EIRP Limit	
<input checked="" type="checkbox"/> indoor access point	The maximum e.i.r.p. over the frequency band of operation must not exceed 36 dBm. Indoor access points operating on a channel that spans the 5.725-5.850 GHz and 5.850-5.895 GHz bands must not exceed an e.i.r.p. of 36 dBm.	
<input type="checkbox"/> subordinate	The maximum e.i.r.p. over the frequency band of operation must not exceed 36 dBm.	
<input type="checkbox"/> client	The maximum e.i.r.p. over the frequency band of operation must not exceed 30 dBm. Client devices operating on a channel that spans the 5.725-5.850 GHz and 5.850-5.895 GHz bands must not exceed an e.i.r.p. of 30 dBm.	

According FCC KDB 662911 D01 v02r01 – for power measurements on IEEE802.11 devices,

CDD Mode:

IEEE 802.11a

Band II-A :

* Directional Gain = $10 \cdot \log\left\{\frac{10^{G1/10} + 10^{G2/10} + \dots + 10^{Gn/10}}{NANT}\right\} = 5.28 \text{ dBi} < 6 \text{ dBi}$

* Power Limit = $11 + 10 \cdot \log 18.94 = 23.77 \text{ dBm}$

Band II-C :

* Directional Gain = $10 \cdot \log\left\{\frac{10^{G1/10} + 10^{G2/10} + \dots + 10^{Gn/10}}{NANT}\right\} = 4.65 \text{ dBi} < 6 \text{ dBi}$

* Power Limit = $11 + 10 \cdot \log 18.71 = 23.72 \text{ dBm}$

IEEE 802.11n 5 GHz 20 MHz

Band II-C :

* Directional Gain = $10 \cdot \log\left\{\frac{10^{G1/10} + 10^{G2/10} + \dots + 10^{Gn/10}}{NANT}\right\} = 4.65 \text{ dBi} < 6 \text{ dBi}$

* Power Limit = $11 + 10 \cdot \log 19.89 = 23.99 \text{ dBm}$

BF mode:

IEEE 802.11n 5 GHz 20 MHz / IEEE 802.11ac 20 MHz / IEEE 802.11ax 20 MHz / IEEE 802.11n 5 GHz 40 MHz / IEEE 802.11ac 40 / IEEE 802.11ax 40 MHz / IEEE 802.11ac 80 / IEEE 802.11ax 80 MHz

Band I :

- * Directional Gain = $10 \cdot \log\{[10^{(G1/20)} + 10^{(G2/20)} + \dots + 10^{(Gn/20)}]^2 / NANT\}$ = 11.32 dBi > 6 dBi
- * Power Limit = 30 – 5.32 = 24.68 dBm

Band II-A :

- * Directional Gain = $10 \cdot \log\{[10^{(G1/20)} + 10^{(G2/20)} + \dots + 10^{(Gn/20)}]^2 / NANT\}$ = 11.28 dBi > 6 dBi
- * Power Limit = 24 – 5.28 = 18.72 dBm

Band II-C :

- * Directional Gain = $10 \cdot \log\{[10^{(G1/20)} + 10^{(G2/20)} + \dots + 10^{(Gn/20)}]^2 / NANT\}$ = 10.67 dBi > 6 dBi
- * Power Limit = 24 – 4.67 = 19.33 dBm

Band III :

- * Directional Gain = $10 \cdot \log\{[10^{(G1/20)} + 10^{(G2/20)} + \dots + 10^{(Gn/20)}]^2 / NANT\}$ = 11.05 dBi > 6 dBi
- * Power Limit = 30 – 5.05 = 24.95 dBm

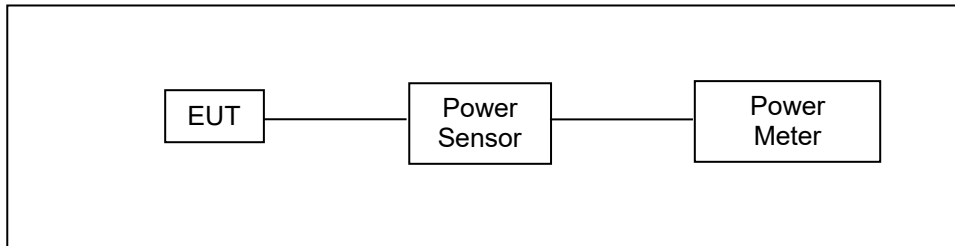
■ Test Setup

■ Test Procedure

The test is performed in accordance with ANSI C63.10:2013 section 12.3.3.2, Guidelines for Compliance Testing of Unlicensed National Information Infrastructure (U-NII) Devices

Section (E) Maximum Conducted Output Power

3. Measurement using a Power Meter (PM)

b) Method PM-G (Measurement using a gated RF average power meter)

4.4. 26 dB RF Bandwidth Measurement

■ Limit

N/A

■ Test Setup

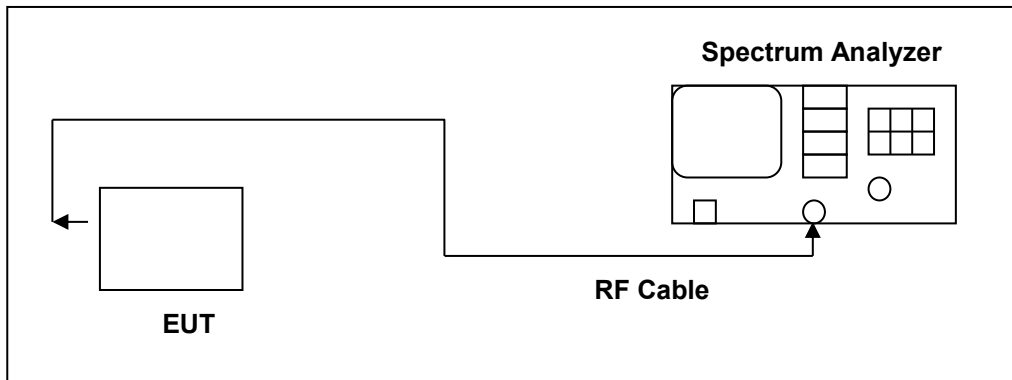

■ Test Procedure

The test is performed in accordance with ANSI C63.10:2013 section 12.4.1, Guidelines for Compliance Testing of Unlicensed National Information Infrastructure (U-NII) Devices - Part 15, Subpart E.

Spectrum Parameter	Setting
Attenuation	Auto
Span Frequency	>26 dB Bandwidth
RBW	Approximately 1 % of the emission bandwidth
VBW	VBW > RBW
Detector	Peak
Trace	Max Hold
Sweep Time	Auto

4.5. 6 dB RF Bandwidth Measurement

■ **Limit**

6 dB RF Bandwidth

Systems using digital modulation techniques may operate in the 5725~5825 MHz bands. The minimum 6 dB bandwidth shall be at least 500 kHz.

■ **Test Setup**

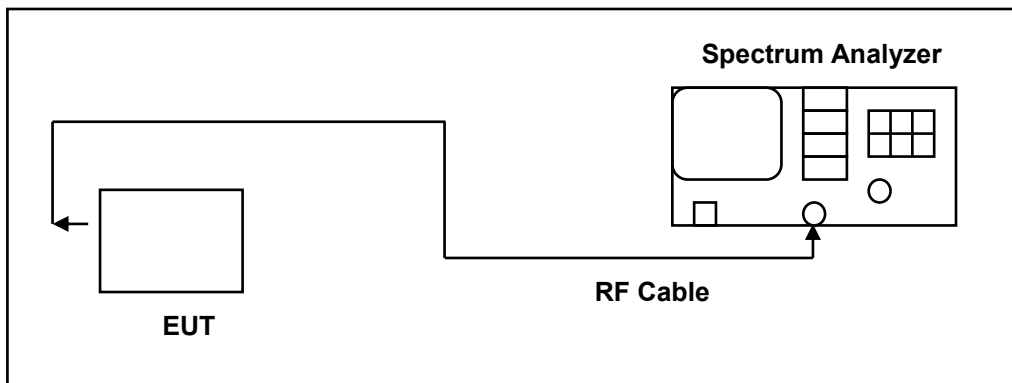

■ **Test Procedure**

6 dB RF Bandwidth

The EUT tested to UNII test procedure of ANSI C63.10:2013 section 6.9.2 for compliance to FCC 47CFR 15.407 requirements.

The antenna port of the EUT was connected to the input of a spectrum analyzer. Analyzer RES BW was set to 100 kHz. For each RF output channel investigated, the spectrum analyzer center frequency was set to the channel carrier. A peak output reading was taken, a DISPLAY line was drawn 6 dB lower than peak level. The 6 dB bandwidth was determined from where the channel output spectrum intersected the display line.

The test was performed at 3 channels.

4.6. Maximum Power Spectral Density Measurement

■ Limit

Frequency Range (MHz)	FCC Limit
	Master
5.150 ~ 5.250 GHz	17 dBm/MHz
5.250 ~ 5.350 GHz	11 dBm/MHz
5.470 ~ 5.725 GHz	11 dBm/MHz
5.725 ~ 5.850 GHz	30 dBm/500 kHz

According FCC KDB 662911 D01 v02r01 – for power spectral density measurements on IEEE802.11 devices,

CDD/BF mode:

Band I :

* Directional Gain = $10 \cdot \log\{[10^{(G1/20)} + 10^{(G2/20)} + \dots + 10^{(Gn/20)}]^2 / NANT\}$ = 11.32 dBi > 6 dBi

* Conducted Power Spectral Density Limit = 17 – 5.32 = 11.68 dBm/MHz

Band II-A :

* Directional Gain = $10 \cdot \log\{[10^{(G1/20)} + 10^{(G2/20)} + \dots + 10^{(Gn/20)}]^2 / NANT\}$ = 11.28 dBi > 6 dBi

* Conducted Power Spectral Density Limit = 11 – 5.28 = 5.72 dBm/MHz

Band II-C :

* Directional Gain = $10 \cdot \log\{[10^{(G1/20)} + 10^{(G2/20)} + \dots + 10^{(Gn/20)}]^2 / NANT\}$ = 10.67 dBi > 6 dBi

* Conducted Power Spectral Density Limit = 11 – 4.67 = 6.33 dBm/MHz

Band III :

* Directional Gain = $10 \cdot \log\{[10^{(G1/20)} + 10^{(G2/20)} + \dots + 10^{(Gn/20)}]^2 / NANT\}$ = 11.05 dBi > 6 dBi

* Conducted Power Spectral Density Limit = 30 – 5.05 = 24.95 dBm/MHz

■ Test Setup

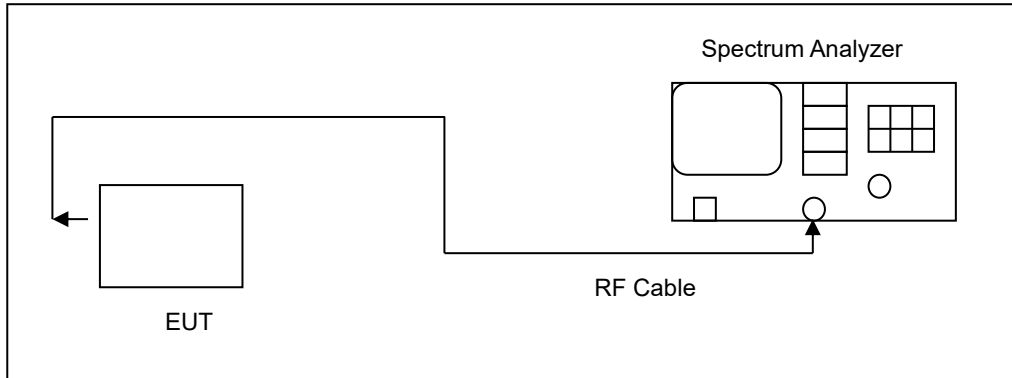

■ Test Procedure

The test is performed in accordance with ANSI C63.10:2013 section 12.5, Guidelines for Compliance Testing of Unlicensed National Information Infrastructure (U-NII) Devices - Part 15, Subpart E.

Spectrum Parameter	Setting
Attenuation	Auto
Span Frequency	Encompass the entire emissions bandwidth (EBW) of the signal
RBW	1 MHz (5725 ~ 5850 MHz use 100 kHz)
VBW	3 MHz (5725 ~ 5850 MHz use 300 kHz)
Detector	RMS
Trace	AVERAGE
Sweep Time	Auto
Trace Average	100 times
Note: If measurement bandwidth of Maximum PSD is specified in 500 kHz, add $10 \log(500 \text{ kHz}/100 \text{ kHz})$ to the measured result.	

4.7. Automatically discontinue transmission

The device shall automatically discontinue transmission in case of either absence of information to transmit or operational failure. These provisions are not intended to preclude the transmission of control or signalling information or the use of repetitive codes used by certain digital technologies to complete frame or burst intervals. Applicants shall include in their application for equipment authorization a description of how this requirement is met.

- **Declare**

While the EUT is not transmitting any information, the EUT can automatically discontinue transmission and become standby mode for power saving.

The EUT can detect the controlling signal of ACK message transmitting from remote device and verify whether it shall resend or discontinue transmission.

4.8. Antenna Requirement

- **Requirement**

For intentional device, according to 15.203, an intentional radiator shall be designed to ensure that no antenna other than that furnished by the responsible party shall be used with the device.

And According to 15.407 (a), if transmitting antennas of directional gain greater than 6 dBi are used, the power shall be reduced by the amount in dB that the directional gain of the antenna exceeds 6 dBi.

- **Antenna Connector Construction**

See section 2 – antenna information.

Directional Gain Calculated

Operate Freq. Band		Directional Gain (dBi)
IEEE 802.11a	U-NII Band I	5.32
	U-NII Band II-A	5.28
	U-NII Band II-C	4.65
	U-NII Band III	5.04
IEEE 802.11n 5 GHz 20 MHz	U-NII Band I	5.32
	U-NII Band II-A	5.28
	U-NII Band II-C	4.65
	U-NII Band III	5.04
IEEE 802.11n 5 GHz 40 MHz	U-NII Band I	5.32
	U-NII Band II-A	5.28
	U-NII Band II-C	4.65
	U-NII Band III	5.04
IEEE 802.11ac 20 MHz	U-NII Band I	5.32
	U-NII Band II-A	5.28
	U-NII Band II-C	4.65
	U-NII Band III	5.04
IEEE 802.11ac 40 MHz	U-NII Band I	5.32
	U-NII Band II-A	5.28
	U-NII Band II-C	4.65
	U-NII Band III	5.04
IEEE 802.11ac 80 MHz	U-NII Band I	5.32
	U-NII Band II-A	5.28
	U-NII Band II-C	4.65
	U-NII Band III	5.04
IEEE 802.11ax 20 MHz	U-NII Band I	5.32
	U-NII Band II-A	5.28
	U-NII Band II-C	4.65
	U-NII Band III	5.04
IEEE 802.11ax 40 MHz	U-NII Band I	5.32
	U-NII Band II-A	5.28
	U-NII Band II-C	4.65
	U-NII Band III	5.04
IEEE 802.11ax 80 MHz	U-NII Band I	5.32
	U-NII Band II-A	5.28
	U-NII Band II-C	4.65
	U-NII Band III	5.04

Beamforming on

Operate Freq. Band		Directional Gain (dBi)
IEEE 802.11n 5 GHz 20 MHz	U-NII Band I	11.32
	U-NII Band II-A	11.28
	U-NII Band II-C	10.67
	U-NII Band III	11.05
IEEE 802.11n 5 GHz 40 MHz	U-NII Band I	11.32
	U-NII Band II-A	11.28
	U-NII Band II-C	10.67
	U-NII Band III	11.05
IEEE 802.11ac 20 MHz	U-NII Band I	11.32
	U-NII Band II-A	11.28
	U-NII Band II-C	10.67
	U-NII Band III	11.05
IEEE 802.11ac 40 MHz	U-NII Band I	11.32
	U-NII Band II-A	11.28
	U-NII Band II-C	10.67
	U-NII Band III	11.05
IEEE 802.11ac 80 MHz	U-NII Band I	11.32
	U-NII Band II-A	11.28
	U-NII Band II-C	10.67
	U-NII Band III	11.05
IEEE 802.11ax 20 MHz	U-NII Band I	11.32
	U-NII Band II-A	11.28
	U-NII Band II-C	10.67
	U-NII Band III	11.05
IEEE 802.11ax 40 MHz	U-NII Band I	11.32
	U-NII Band II-A	11.28
	U-NII Band II-C	10.67
	U-NII Band III	11.05
IEEE 802.11ax 80 MHz	U-NII Band I	11.32
	U-NII Band II-A	11.28
	U-NII Band II-C	10.67
	U-NII Band III	11.05

5 Test Results

5.1. Conducted Emission

Standard:	FCC Part 15.407	Line:	L1
Test item:	Conducted Emission	Power:	AC 120 V/60 Hz
Test Mode:	Mode 1		
Description:			

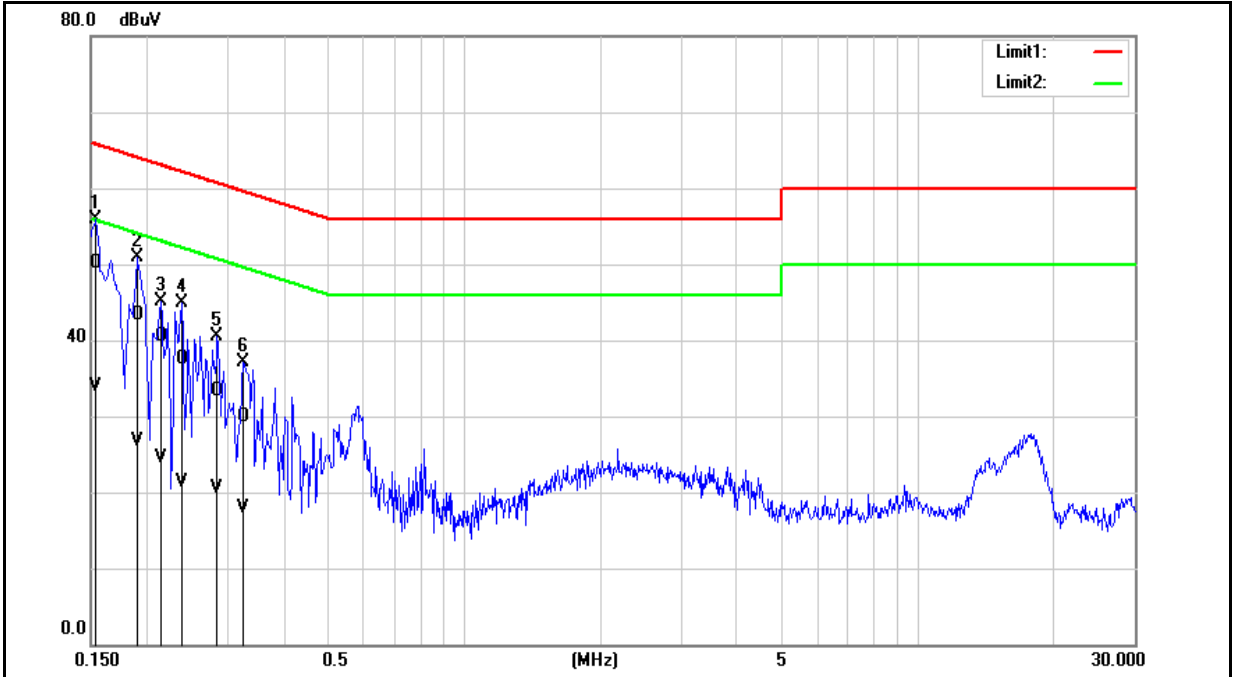

No.	Frequency (MHz)	QP reading (dBuV)	AVG reading (dBuV)	Correction factor (dB)	QP result (dBuV)	AVG result (dBuV)	QP limit (dBuV)	AVG limit (dBuV)	QP margin (dB)	AVG margin (dB)	Remark
1	0.1540	40.28	24.14	9.74	50.02	33.88	65.78	55.78	-15.76	-21.90	Pass
2	0.1900	33.56	16.93	9.74	43.30	26.67	64.04	54.04	-20.74	-27.37	Pass
3	0.2140	30.69	14.71	9.74	40.43	24.45	63.05	53.05	-22.62	-28.60	Pass
4	0.2380	27.76	11.64	9.74	37.50	21.38	62.17	52.17	-24.67	-30.79	Pass
5	0.2860	23.47	10.82	9.74	33.21	20.56	60.64	50.64	-27.43	-30.08	Pass
6	0.3260	20.16	8.14	9.73	29.89	17.87	59.55	49.55	-29.66	-31.68	Pass

Note: 1. Result (dBuV) = Correction factor (dB) + Reading(dBuV).

2. Correction factor (dB) = Cable loss (dB) + L.I.S.N. factor (dB).

Standard:	FCC Part 15.407	Line:	N
Test item:	Conducted Emission	Power:	AC 120 V/60 Hz
Test Mode:	Mode 1		
Description:			

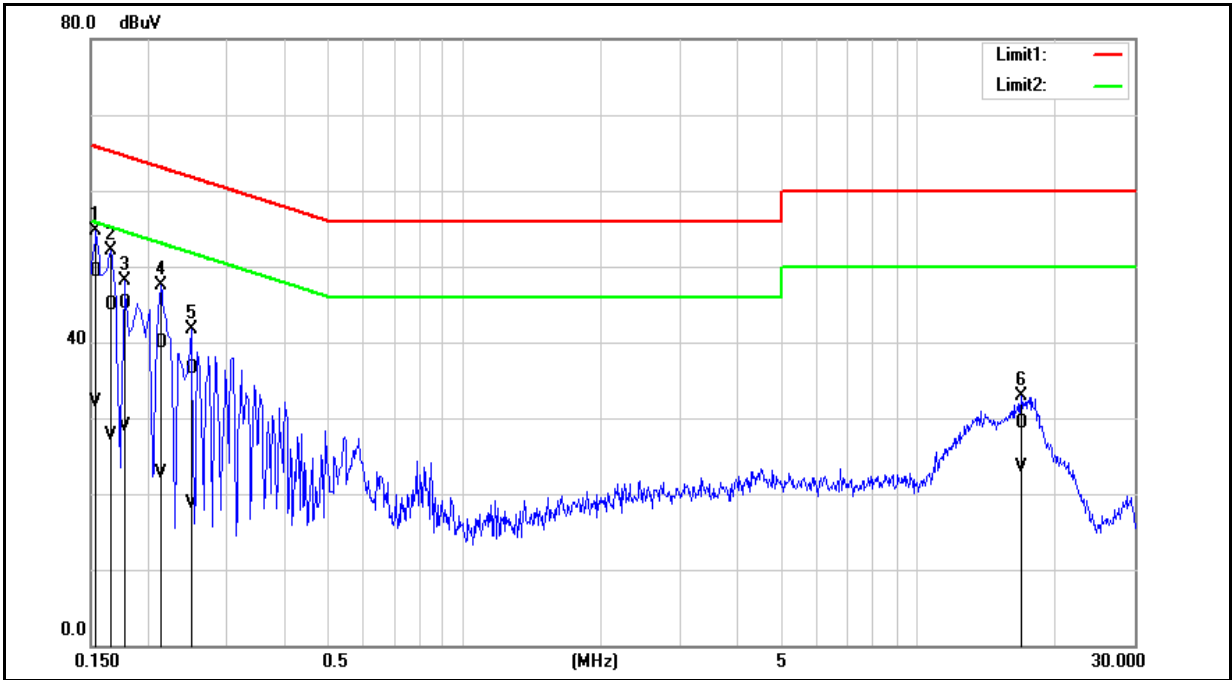

No.	Frequency (MHz)	QP reading (dBuV)	AVG reading (dBuV)	Correction factor (dB)	QP result (dBuV)	AVG result (dBuV)	QP limit (dBuV)	AVG limit (dBuV)	QP margin (dB)	AVG margin (dB)	Remark
1	0.1540	39.58	22.40	9.74	49.32	32.14	65.78	55.78	-16.46	-23.64	Pass
2	0.1660	35.13	17.99	9.74	44.87	27.73	65.16	55.16	-20.29	-27.43	Pass
3	0.1780	35.38	19.20	9.73	45.11	28.93	64.58	54.58	-19.47	-25.65	Pass
4	0.2140	30.25	12.95	9.73	39.98	22.68	63.05	53.05	-23.07	-30.37	Pass
5	0.2500	26.72	8.92	9.73	36.45	18.65	61.76	51.76	-25.31	-33.11	Pass
6	16.8860	19.14	13.37	10.14	29.28	23.51	60.00	50.00	-30.72	-26.49	Pass

Note: 1. Result (dBuV) = Correction factor (dB) + Reading(dBuV).

2. Correction factor (dB) = Cable loss (dB) + L.I.S.N. factor (dB).

5.2. Radiated Emission Measurement

Below 1 GHz

Standard:	FCC Part 15.407	Test Distance:	3 m
Test item:	Radiated Emission		
Mode:	Mode 1		
Ant.Polar.:	Horizontal		

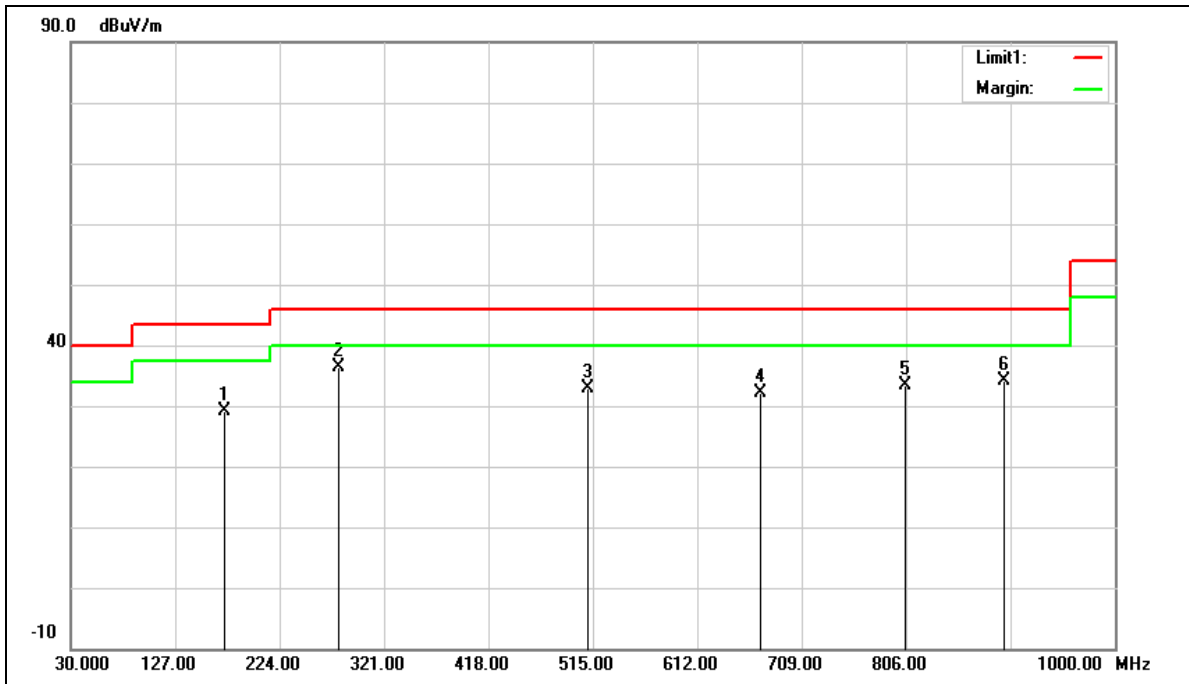

No.	Frequency (MHz)	Reading (dBuV)	Correct Factor (dB/m)	Result (dBuV/m)	Limit (dBuV/m)	Margin (dB)	Remark
1	172.5900	36.22	-7.02	29.20	43.50	-14.30	QP
2	279.2900	42.34	-5.95	36.39	46.00	-9.61	QP
3	510.1500	34.48	-1.69	32.79	46.00	-13.21	QP
4	671.1700	30.46	1.60	32.06	46.00	-13.94	QP
5	805.0300	29.38	4.05	33.43	46.00	-12.57	QP
6	897.1800	28.85	5.39	34.24	46.00	-11.76	QP

Note: 1. Result (dBuV/m) = Correct Factor (dB/m) + Reading (dBuV).

Example: 29.20 = -7.02 + 36.22.

2. Correction factor (dB/m) = Antenna Factor (dB/m) + Cable loss (dB) - Pre-Amplifier gain (dB).

3. When the peak results are less than average limit, so not need to evaluate the average.

Standard:	FCC Part 15.407	Test Distance:	3 m
Test item:	Radiated Emission		
Mode:	Mode 1		
Ant.Polar.:	Horizontal		

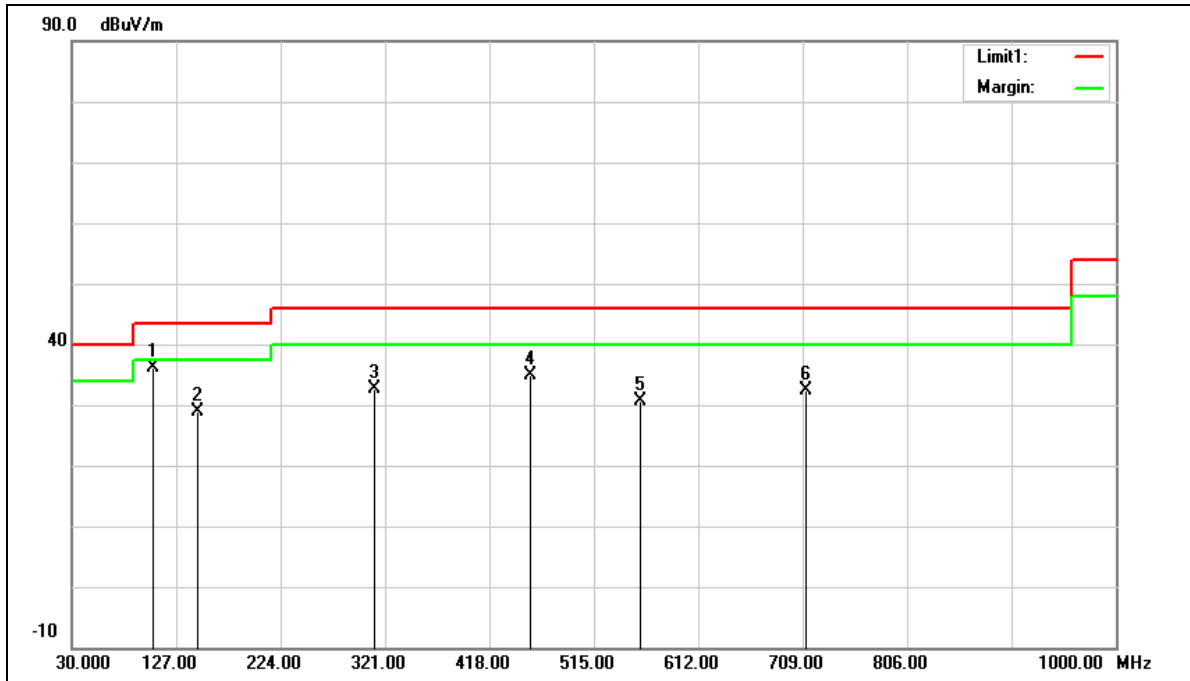

No.	Frequency (MHz)	Reading (dBuV)	Correct Factor (dB/m)	Result (dBuV/m)	Limit (dBuV/m)	Margin (dB)	Remark
1	105.6600	47.07	-11.02	36.05	43.50	-7.45	QP
2	147.3700	35.69	-6.83	28.86	43.50	-14.64	QP
3	311.3000	37.97	-5.27	32.70	46.00	-13.30	QP
4	455.8300	37.46	-2.47	34.99	46.00	-11.01	QP
5	557.6800	31.25	-0.66	30.59	46.00	-15.41	QP
6	711.9100	29.97	2.39	32.36	46.00	-13.64	QP

Note:1.Result (dBuV/m) = Correct Factor (dB/m) + Reading(dBuV).

Example: 36.05= -11.02+47.07.

2.Correction factor (dB/m) = Antenna Factor (dB/m) + Cable loss (dB) – Pre-Amplifier gain (dB).

3.When the peak results are less than average limit, so not need to evaluate the average.

Harmonic

Above 1 GHz

Standard:	FCC Part 15.407	Test Distance:	3 m
Test item:	Harmonic		
Frequency:	5180 MHz		
Mode:	Mode 2		
Ant.Polar.:	Horizontal		

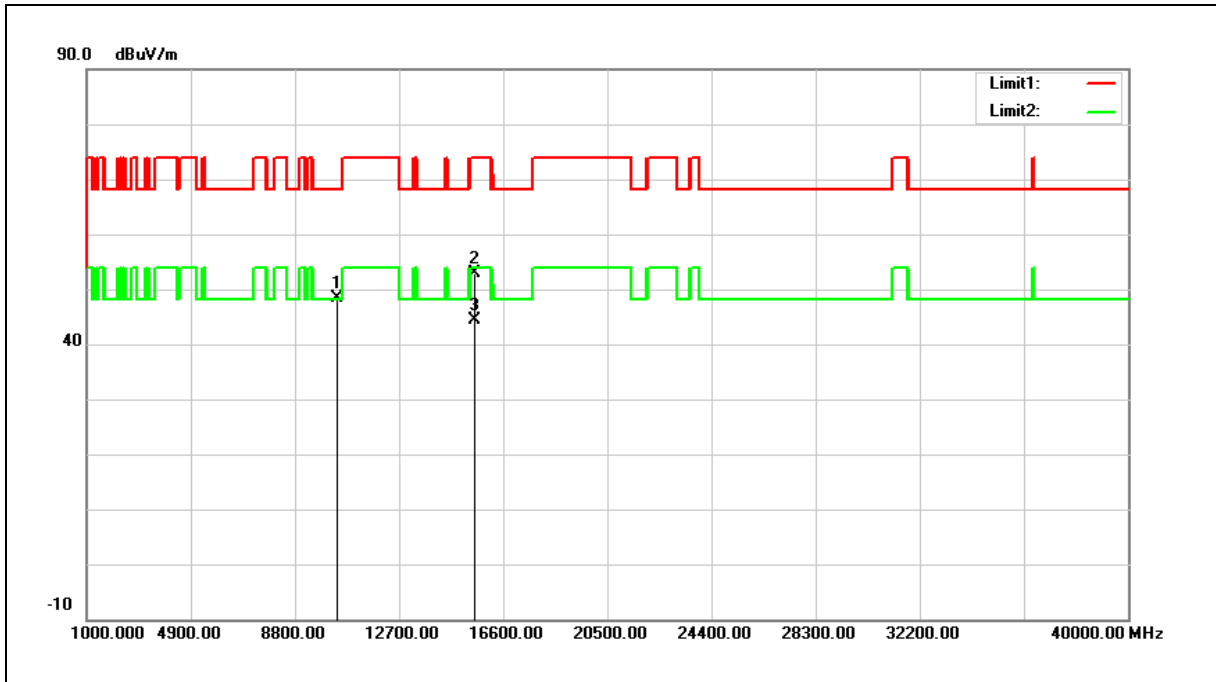

No.	Frequency (MHz)	Reading (dBuV)	Correct Factor (dB/m)	Result (dBuV/m)	Limit (dBuV/m)	Margin (dB)	Remark
1	10360.000	34.17	14.29	48.46	68.20	-19.74	peak
2	15540.000	35.94	16.86	52.80	74.00	-21.20	peak
3	15540.000	27.45	16.86	44.31	54.00	-9.69	AVG

Note:1.Result (dBuV/m) = Correct Factor (dB/m) + Reading(dBuV).

2.Correction factor (dB/m) = Antenna Factor (dB/m) + Cable loss (dB) – Pre-Amplifier gain (dB).

3.When the peak results are less than average limit, so not need to evaluate the average.

Standard:	FCC Part 15.407	Test Distance:	3 m
Test item:	Harmonic		
Frequency:	5180 MHz		
Mode:	Mode 2		
Ant.Polar.:	Vertical		

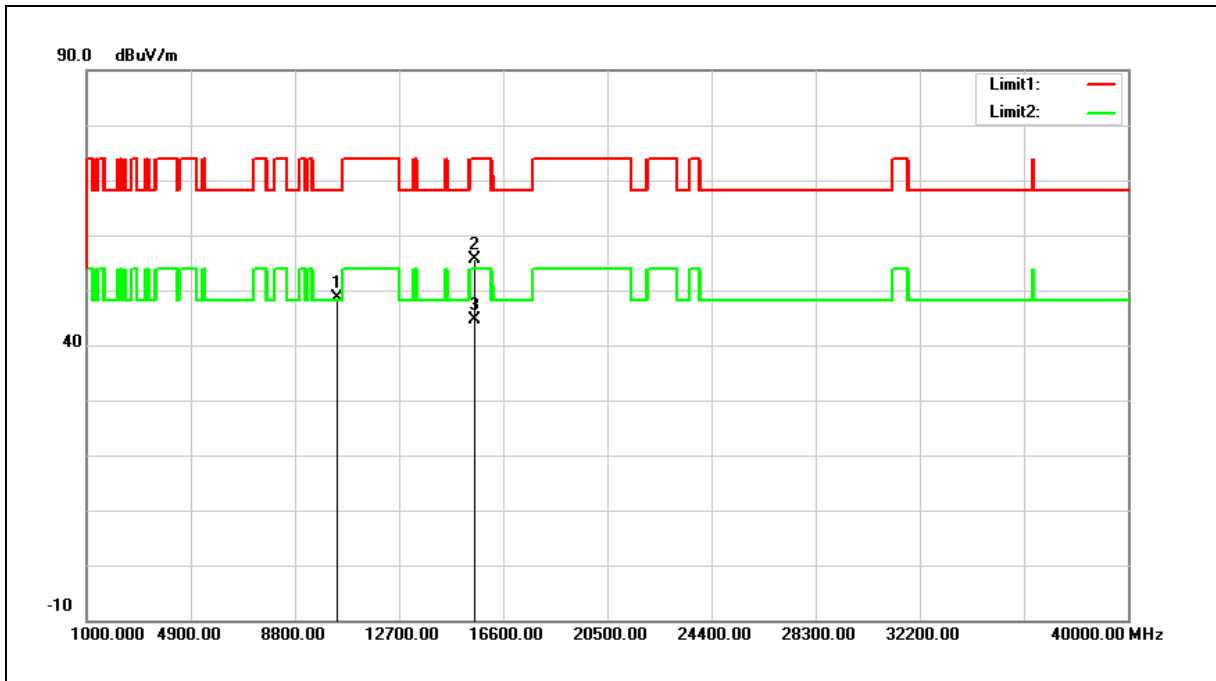

No.	Frequency (MHz)	Reading (dBuV)	Correct Factor (dB/m)	Result (dBuV/m)	Limit (dBuV/m)	Margin (dB)	Remark
1	10360.000	34.40	14.29	48.69	68.20	-19.51	peak
2	15540.000	38.76	16.86	55.62	74.00	-18.38	peak
3	15540.000	27.86	16.86	44.72	54.00	-9.28	AVG

Note:1.Result (dBuV/m) = Correct Factor (dB/m) + Reading(dBuV).

2.Correction factor (dB/m) = Antenna Factor (dB/m) + Cable loss (dB) – Pre-Amplifier gain (dB).

3.When the peak results are less than average limit, so not need to evaluate the average.

Standard:	FCC Part 15.407	Test Distance:	3 m
Test item:	Harmonic		
Frequency:	5200 MHz		
Mode:	Mode 2		
Ant.Polar.:	Horizontal		

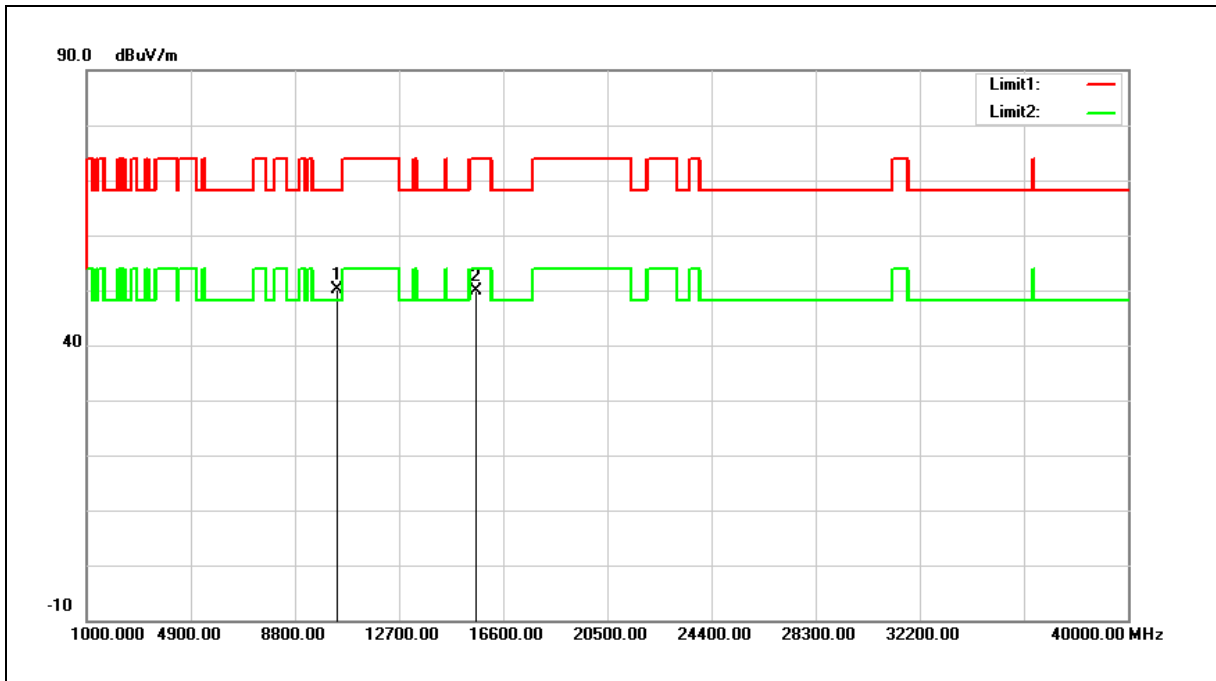

No.	Frequency (MHz)	Reading (dBuV)	Correct Factor (dB/m)	Result (dBuV/m)	Limit (dBuV/m)	Margin (dB)	Remark
1	10400.000	35.71	14.38	50.09	68.20	-18.11	peak
2	15600.000	33.20	16.65	49.85	74.00	-24.15	peak

Note:1.Result (dBuV/m) = Correct Factor (dB/m) + Reading(dBuV).

2.Correction factor (dB/m) = Antenna Factor (dB/m) + Cable loss (dB) – Pre-Amplifier gain (dB).

3.When the peak results are less than average limit, so not need to evaluate the average.

Standard:	FCC Part 15.407	Test Distance:	3 m
Test item:	Harmonic		
Frequency:	5200 MHz		
Mode:	Mode 2		
Ant.Polar.:	Vertical		

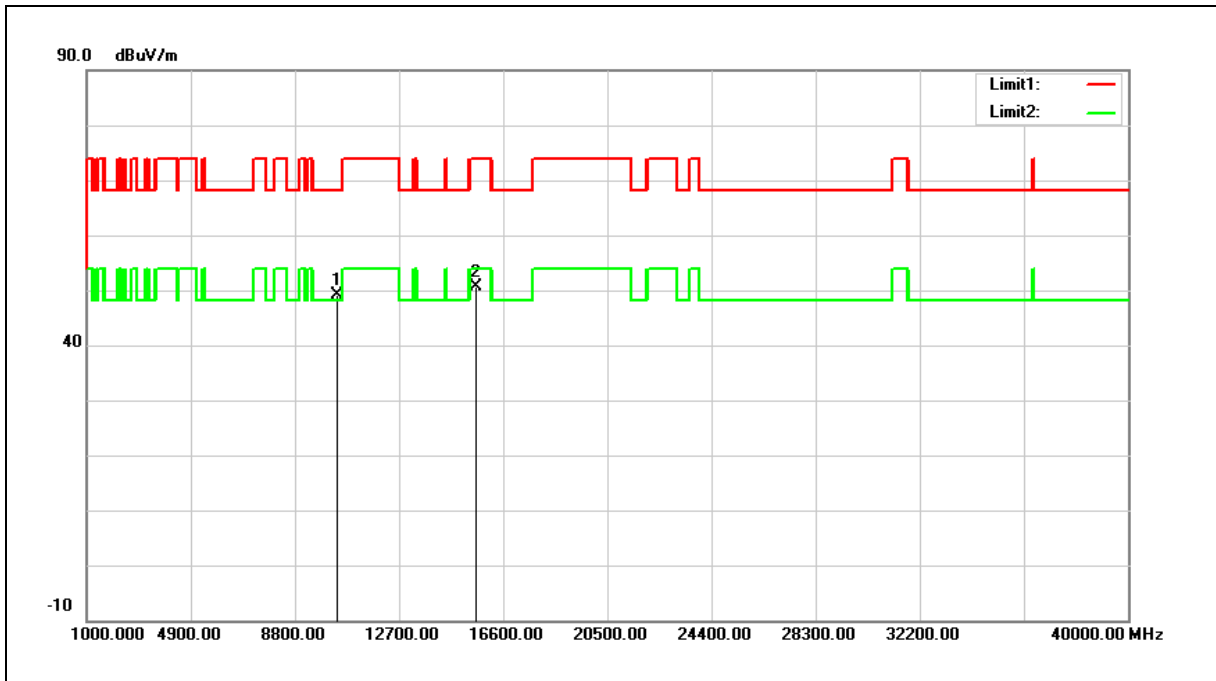

No.	Frequency (MHz)	Reading (dBuV)	Correct Factor (dB/m)	Result (dBuV/m)	Limit (dBuV/m)	Margin (dB)	Remark
1	10400.000	34.72	14.38	49.10	68.20	-19.10	peak
2	15600.000	34.07	16.65	50.72	74.00	-23.28	peak

Note:1.Result (dBuV/m) = Correct Factor (dB/m) + Reading(dBuV).

2.Correction factor (dB/m) = Antenna Factor (dB/m) + Cable loss (dB) – Pre-Amplifier gain (dB).

3.When the peak results are less than average limit, so not need to evaluate the average.

Standard:	FCC Part 15.407	Test Distance:	3 m
Test item:	Harmonic		
Frequency:	5240 MHz		
Mode:	Mode 2		
Ant.Polar.:	Horizontal		

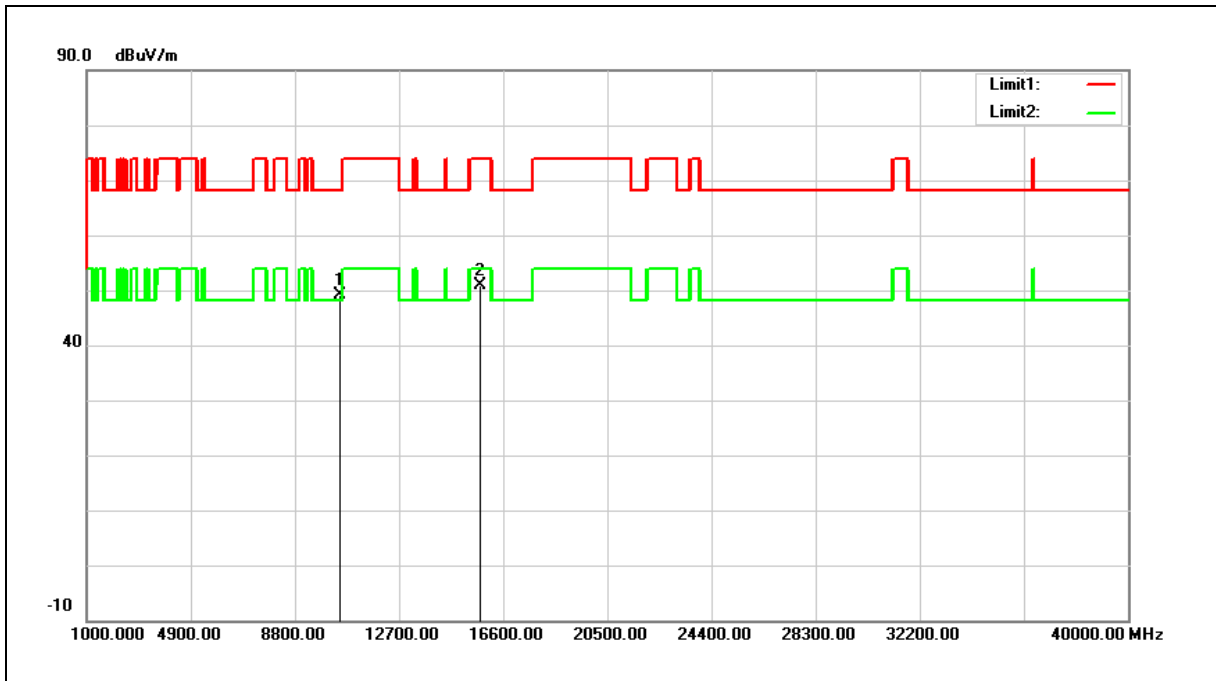

No.	Frequency (MHz)	Reading (dBuV)	Correct Factor (dB/m)	Result (dBuV/m)	Limit (dBuV/m)	Margin (dB)	Remark
1	10480.000	34.52	14.55	49.07	68.20	-19.13	peak
2	15720.000	34.53	16.24	50.77	74.00	-23.23	peak

Note:1.Result (dBuV/m) = Correct Factor (dB/m) + Reading(dBuV).

2.Correction factor (dB/m) = Antenna Factor (dB/m) + Cable loss (dB) – Pre-Amplifier gain (dB).

3.When the peak results are less than average limit, so not need to evaluate the average.

Standard:	FCC Part 15.407	Test Distance:	3 m
Test item:	Harmonic		
Frequency:	5240 MHz		
Mode:	Mode 2		
Ant.Polar.:	Vertical		

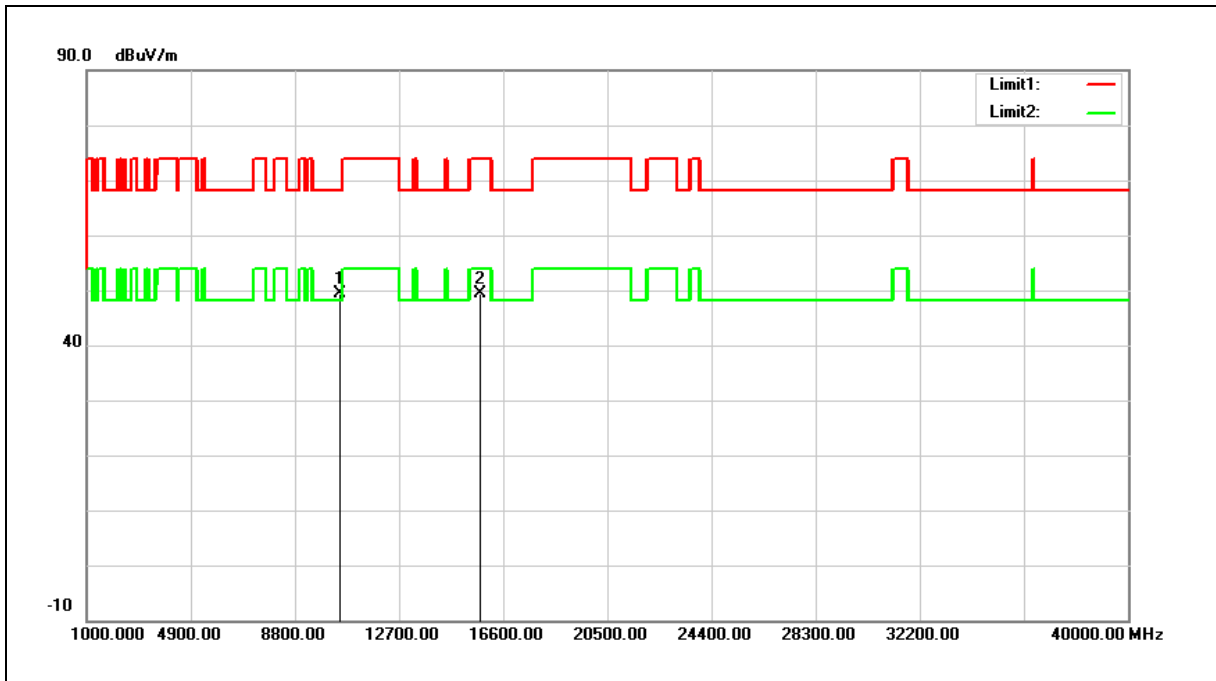

No.	Frequency (MHz)	Reading (dBuV)	Correct Factor (dB/m)	Result (dBuV/m)	Limit (dBuV/m)	Margin (dB)	Remark
1	10480.000	34.79	14.55	49.34	68.20	-18.86	peak
2	15720.000	33.24	16.24	49.48	74.00	-24.52	peak

Note:1.Result (dBuV/m) = Correct Factor (dB/m) + Reading(dBuV).

2.Correction factor (dB/m) = Antenna Factor (dB/m) + Cable loss (dB) – Pre-Amplifier gain (dB).

3.When the peak results are less than average limit, so not need to evaluate the average.

Standard:	FCC Part 15.407	Test Distance:	3 m
Test item:	Harmonic		
Frequency:	5260 MHz		
Mode:	Mode 2		
Ant.Polar.:	Horizontal		

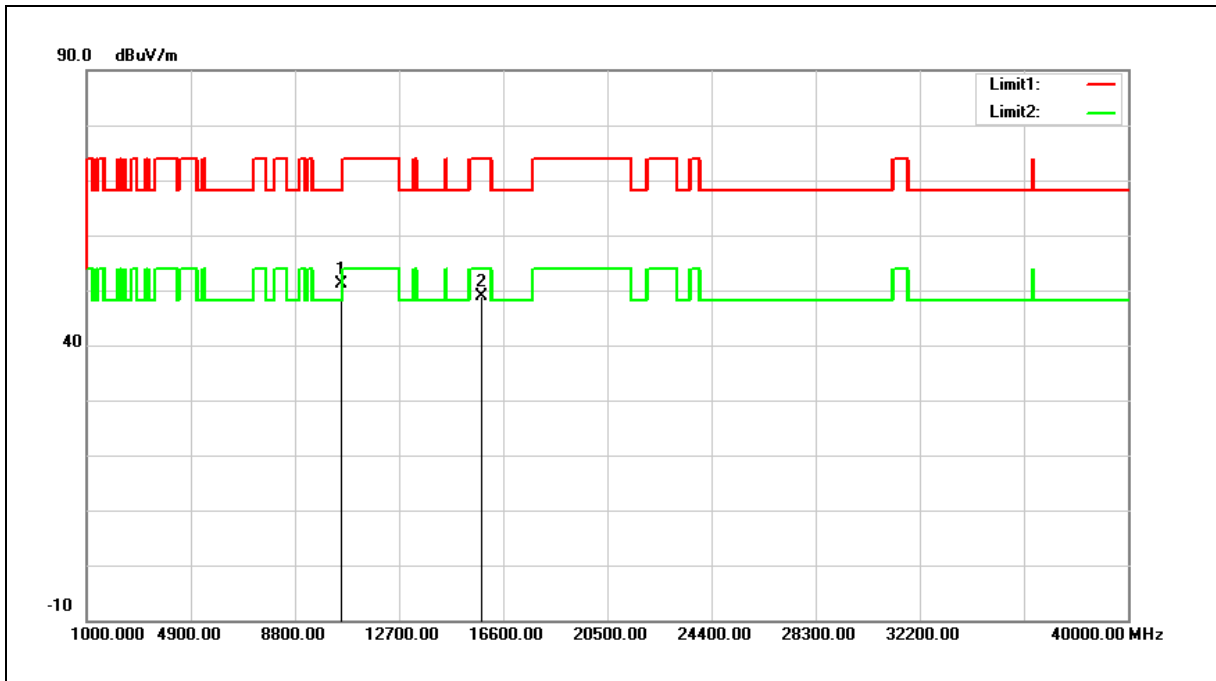

No.	Frequency (MHz)	Reading (dBuV)	Correct Factor (dB/m)	Result (dBuV/m)	Limit (dBuV/m)	Margin (dB)	Remark
1	10520.000	36.51	14.59	51.10	68.20	-17.10	peak
2	15780.000	32.77	16.06	48.83	74.00	-25.17	peak

Note:1.Result (dBuV/m) = Correct Factor (dB/m) + Reading(dBuV).

2.Correction factor (dB/m) = Antenna Factor (dB/m) + Cable loss (dB) – Pre-Amplifier gain (dB).

3.When the peak results are less than average limit, so not need to evaluate the average.

Standard:	FCC Part 15.407	Test Distance:	3 m
Test item:	Harmonic		
Frequency:	5260 MHz		
Mode:	Mode 2		
Ant.Polar.:	Vertical		

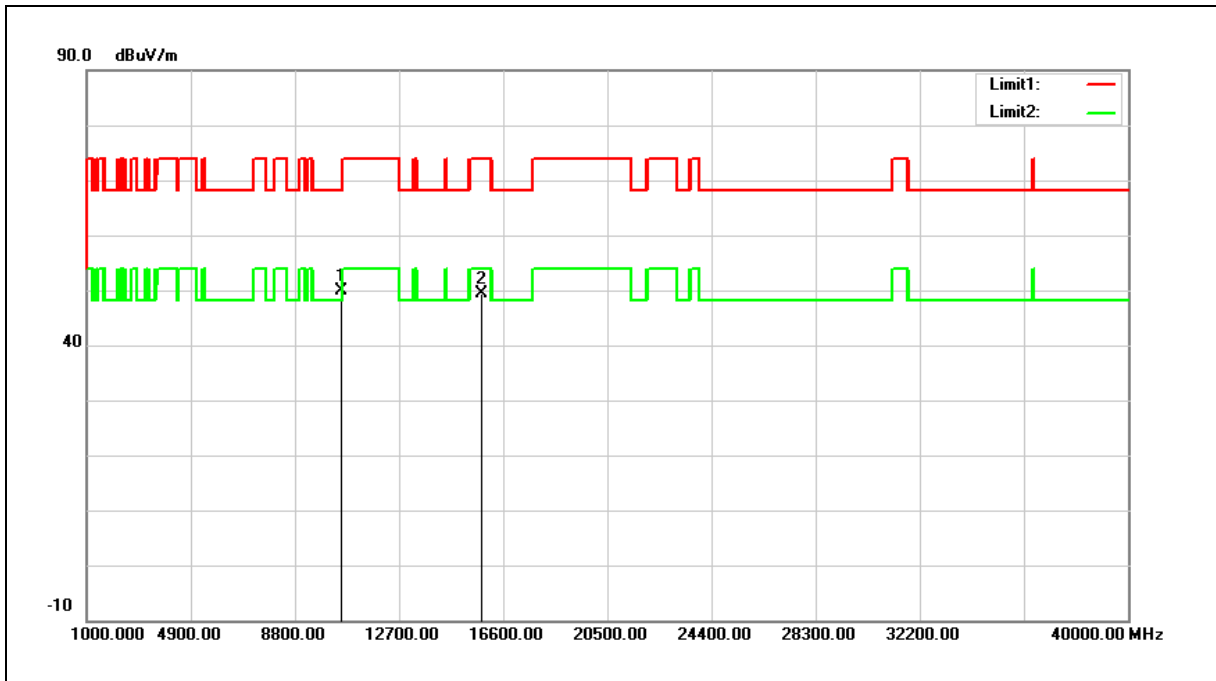

No.	Frequency (MHz)	Reading (dBuV)	Correct Factor (dB/m)	Result (dBuV/m)	Limit (dBuV/m)	Margin (dB)	Remark
1	10520.000	35.26	14.59	49.85	68.20	-18.35	peak
2	15780.000	33.28	16.06	49.34	74.00	-24.66	peak

Note:1.Result (dBuV/m) = Correct Factor (dB/m) + Reading(dBuV).

2.Correction factor (dB/m) = Antenna Factor (dB/m) + Cable loss (dB) – Pre-Amplifier gain (dB).

3.When the peak results are less than average limit, so not need to evaluate the average.

Standard:	FCC Part 15.407	Test Distance:	3 m
Test item:	Harmonic		
Frequency:	5280 MHz		
Mode:	Mode 2		
Ant.Polar.:	Horizontal		

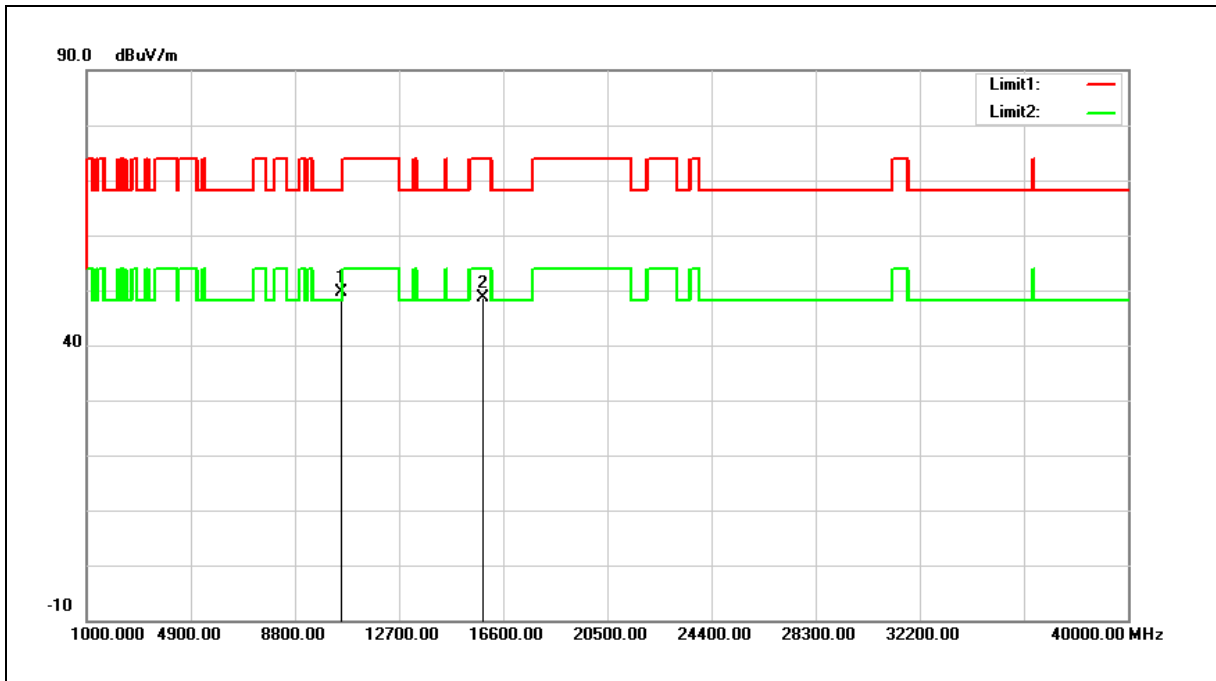

No.	Frequency (MHz)	Reading (dBuV)	Correct Factor (dB/m)	Result (dBuV/m)	Limit (dBuV/m)	Margin (dB)	Remark
1	10560.000	35.06	14.58	49.64	68.20	-18.56	peak
2	15840.000	32.82	15.85	48.67	74.00	-25.33	peak

Note:1.Result (dBuV/m) = Correct Factor (dB/m) + Reading(dBuV).

2.Correction factor (dB/m) = Antenna Factor (dB/m) + Cable loss (dB) – Pre-Amplifier gain (dB).

3.When the peak results are less than average limit, so not need to evaluate the average.

Standard:	FCC Part 15.407	Test Distance:	3 m
Test item:	Harmonic		
Frequency:	5280 MHz		
Mode:	Mode 2		
Ant.Polar.:	Vertical		

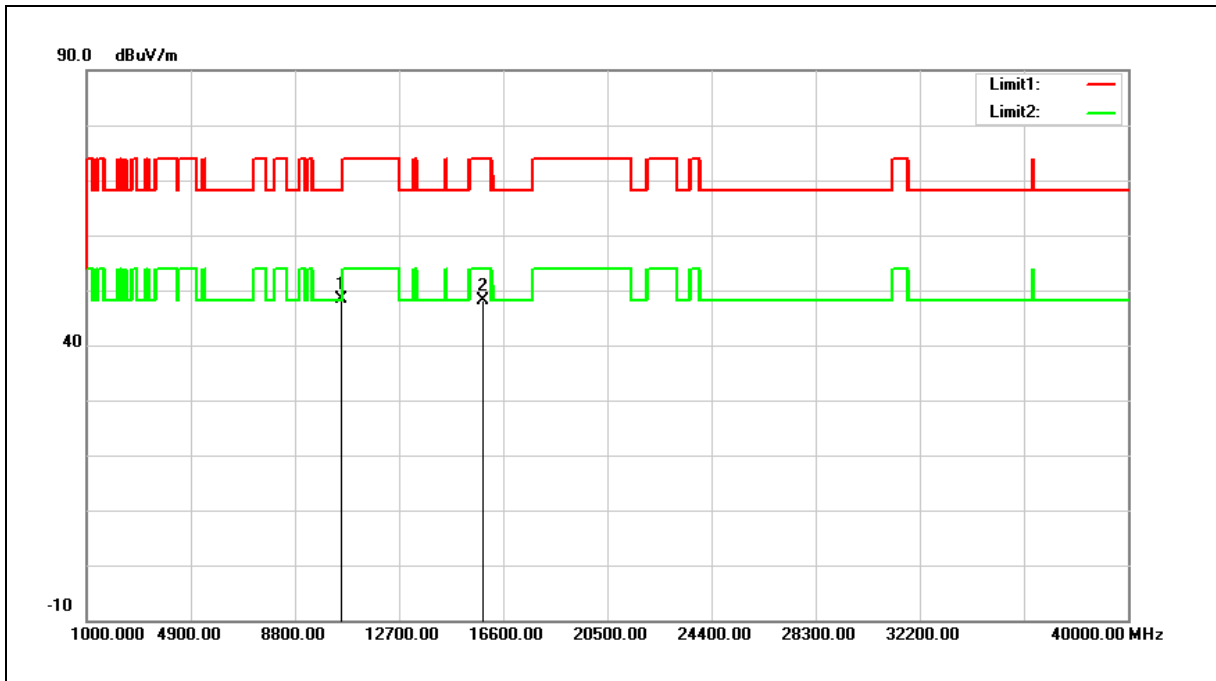

No.	Frequency (MHz)	Reading (dBuV)	Correct Factor (dB/m)	Result (dBuV/m)	Limit (dBuV/m)	Margin (dB)	Remark
1	10560.000	33.84	14.58	48.42	68.20	-19.78	peak
2	15840.000	32.40	15.85	48.25	74.00	-25.75	peak

Note:1.Result (dBuV/m) = Correct Factor (dB/m) + Reading(dBuV).

2.Correction factor (dB/m) = Antenna Factor (dB/m) + Cable loss (dB) – Pre-Amplifier gain (dB).

3.When the peak results are less than average limit, so not need to evaluate the average.

Standard:	FCC Part 15.407	Test Distance:	3 m
Test item:	Harmonic		
Frequency:	5320 MHz		
Mode:	Mode 2		
Ant.Polar.:	Horizontal		

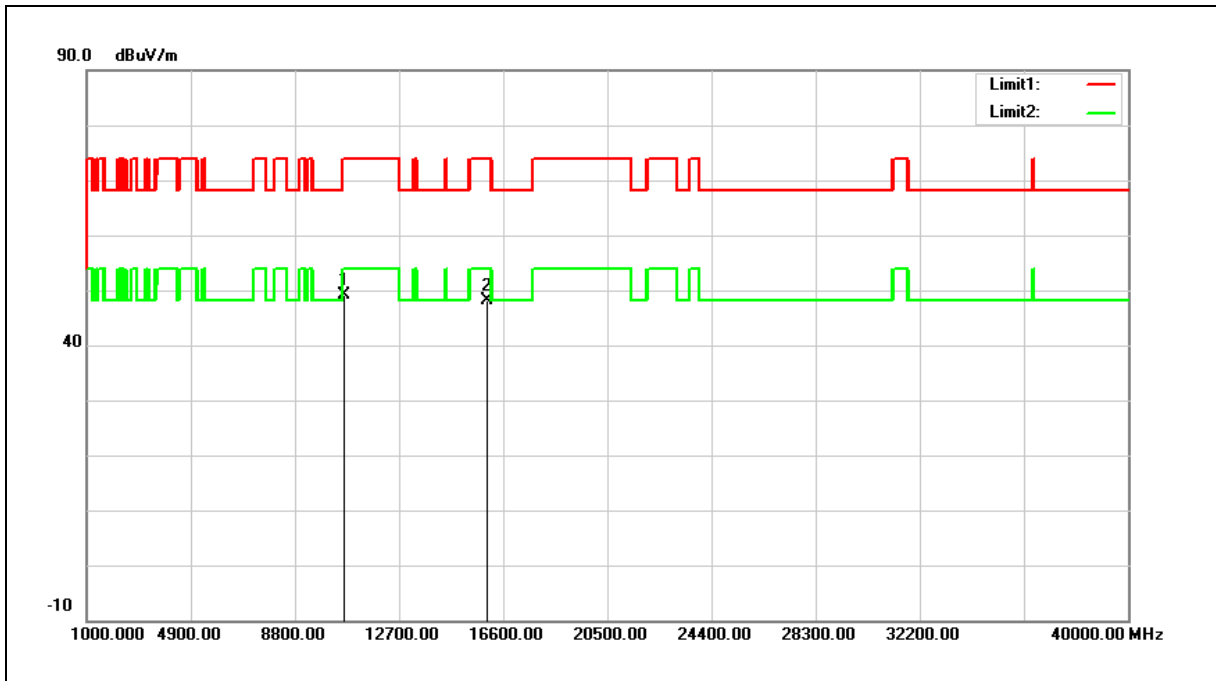

No.	Frequency (MHz)	Reading (dBuV)	Correct Factor (dB/m)	Result (dBuV/m)	Limit (dBuV/m)	Margin (dB)	Remark
1	10640.000	34.57	14.56	49.13	74.00	-24.87	peak
2	15960.000	32.80	15.44	48.24	74.00	-25.76	peak

Note:1.Result (dBuV/m) = Correct Factor (dB/m) + Reading(dBuV).

2.Correction factor (dB/m) = Antenna Factor (dB/m) + Cable loss (dB) – Pre-Amplifier gain (dB).

3.When the peak results are less than average limit, so not need to evaluate the average.

Standard:	FCC Part 15.407	Test Distance:	3 m
Test item:	Harmonic		
Frequency:	5320 MHz		
Mode:	Mode 2		
Ant.Polar.:	Vertical		

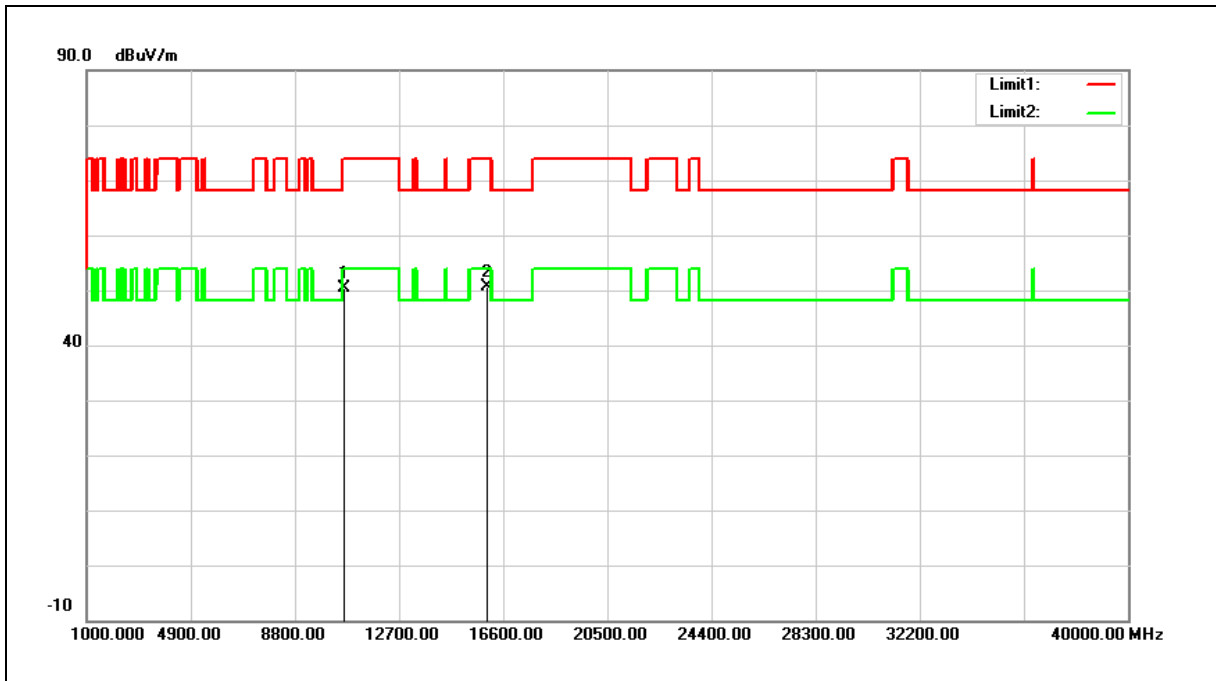

No.	Frequency (MHz)	Reading (dBuV)	Correct Factor (dB/m)	Result (dBuV/m)	Limit (dBuV/m)	Margin (dB)	Remark
1	10640.000	35.82	14.56	50.38	74.00	-23.62	peak
2	15960.000	35.27	15.44	50.71	74.00	-23.29	peak

Note:1.Result (dBuV/m) = Correct Factor (dB/m) + Reading(dBuV).

2.Correction factor (dB/m) = Antenna Factor (dB/m) + Cable loss (dB) – Pre-Amplifier gain (dB).

3.When the peak results are less than average limit, so not need to evaluate the average.

Standard:	FCC Part 15.407	Test Distance:	3 m
Test item:	Harmonic		
Frequency:	5500 MHz		
Mode:	Mode 2		
Ant.Polar.:	Horizontal		

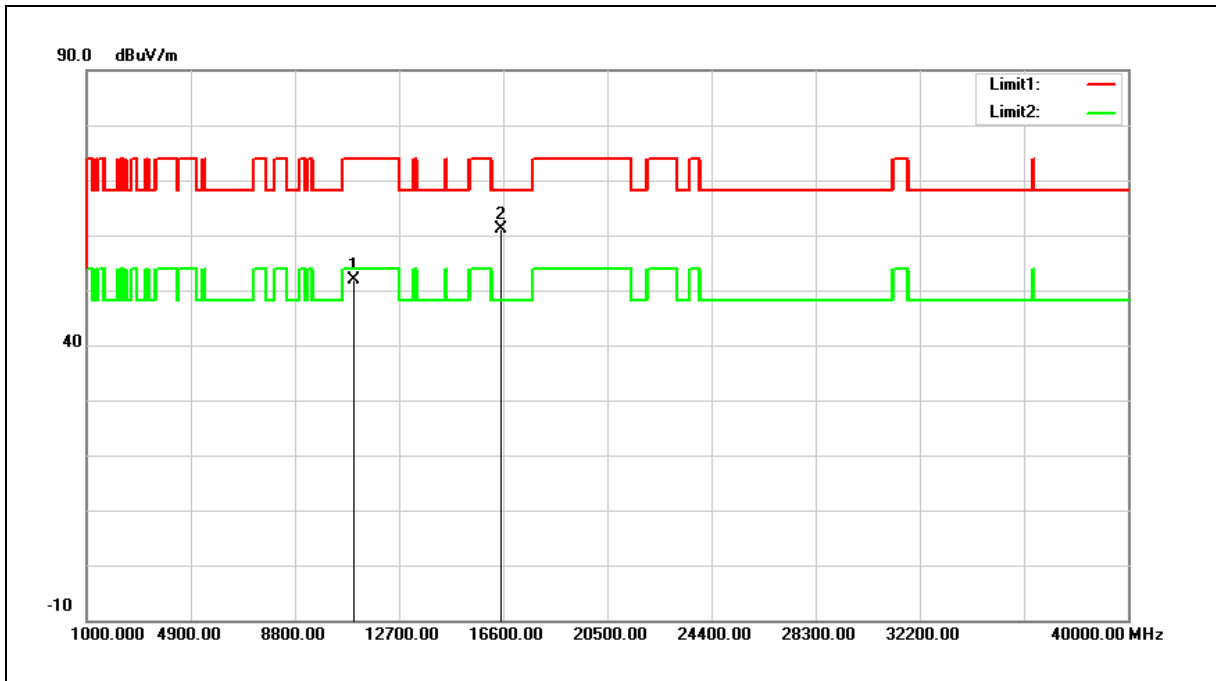

No.	Frequency (MHz)	Reading (dBuV)	Correct Factor (dB/m)	Result (dBuV/m)	Limit (dBuV/m)	Margin (dB)	Remark
1	11000.000	37.36	14.47	51.83	74.00	-22.17	peak
2	16500.000	44.58	16.63	61.21	68.20	-6.99	peak

Note:1.Result (dBuV/m) = Correct Factor (dB/m) + Reading(dBuV).

2.Correction factor (dB/m) = Antenna Factor (dB/m) + Cable loss (dB) – Pre-Amplifier gain (dB).

3.When the peak results are less than average limit, so not need to evaluate the average.

Standard:	FCC Part 15.407	Test Distance:	3 m
Test item:	Harmonic		
Frequency:	5500 MHz		
Mode:	Mode 2		
Ant.Polar.:	Vertical		

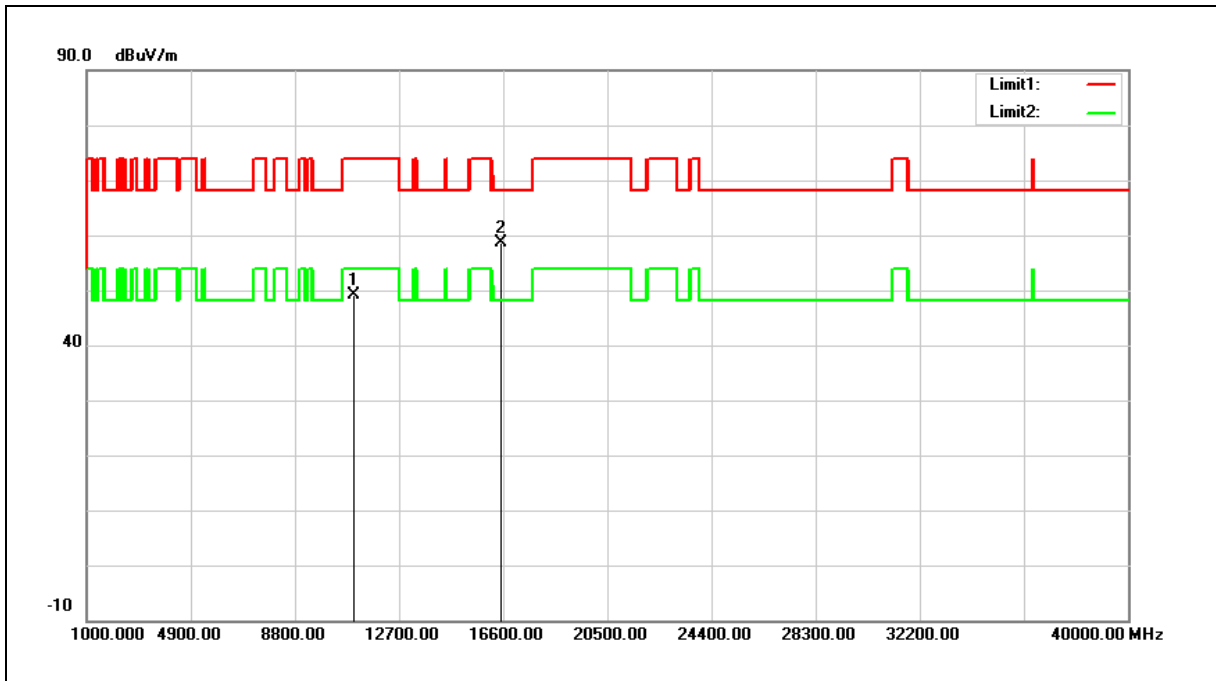

No.	Frequency (MHz)	Reading (dBuV)	Correct Factor (dB/m)	Result (dBuV/m)	Limit (dBuV/m)	Margin (dB)	Remark
1	11000.000	34.56	14.47	49.03	74.00	-24.97	peak
2	16500.000	41.90	16.63	58.53	68.20	-9.67	peak

Note:1.Result (dBuV/m) = Correct Factor (dB/m) + Reading(dBuV).

2.Correction factor (dB/m) = Antenna Factor (dB/m) + Cable loss (dB) – Pre-Amplifier gain (dB).

3.When the peak results are less than average limit, so not need to evaluate the average.

Standard:	FCC Part 15.407	Test Distance:	3 m
Test item:	Harmonic		
Frequency:	5560 MHz		
Mode:	Mode 2		
Ant.Polar.:	Horizontal		

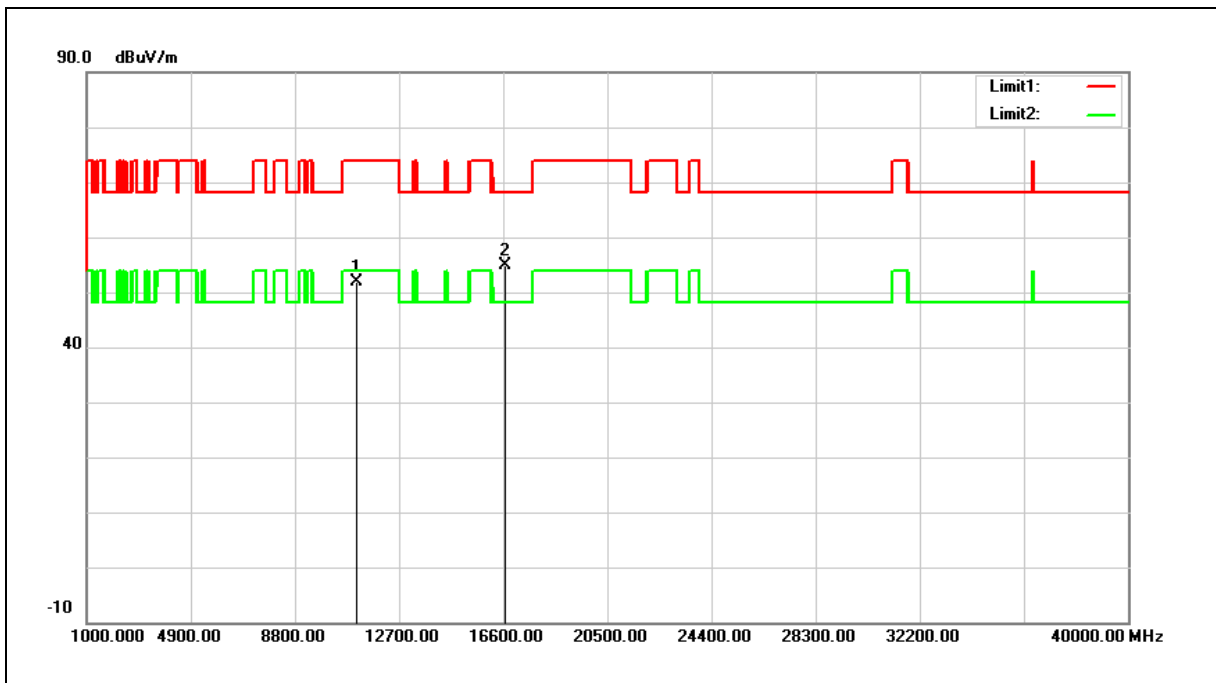

No.	Frequency (MHz)	Reading (dBuV)	Correct Factor (dB/m)	Result (dBuV/m)	Limit (dBuV/m)	Margin (dB)	Remark
1	11120.000	37.19	14.70	51.89	74.00	-22.11	peak
2	16680.000	37.02	17.95	54.97	68.20	-13.23	peak

Note:1.Result (dBuV/m) = Correct Factor (dB/m) + Reading(dBuV).

2.Correction factor (dB/m) = Antenna Factor (dB/m) + Cable loss (dB) – Pre-Amplifier gain (dB).

3.When the peak results are less than average limit, so not need to evaluate the average.

Standard:	FCC Part 15.407	Test Distance:	3 m
Test item:	Harmonic		
Frequency:	5560 MHz		
Mode:	Mode 2		
Ant.Polar.:	Vertical		

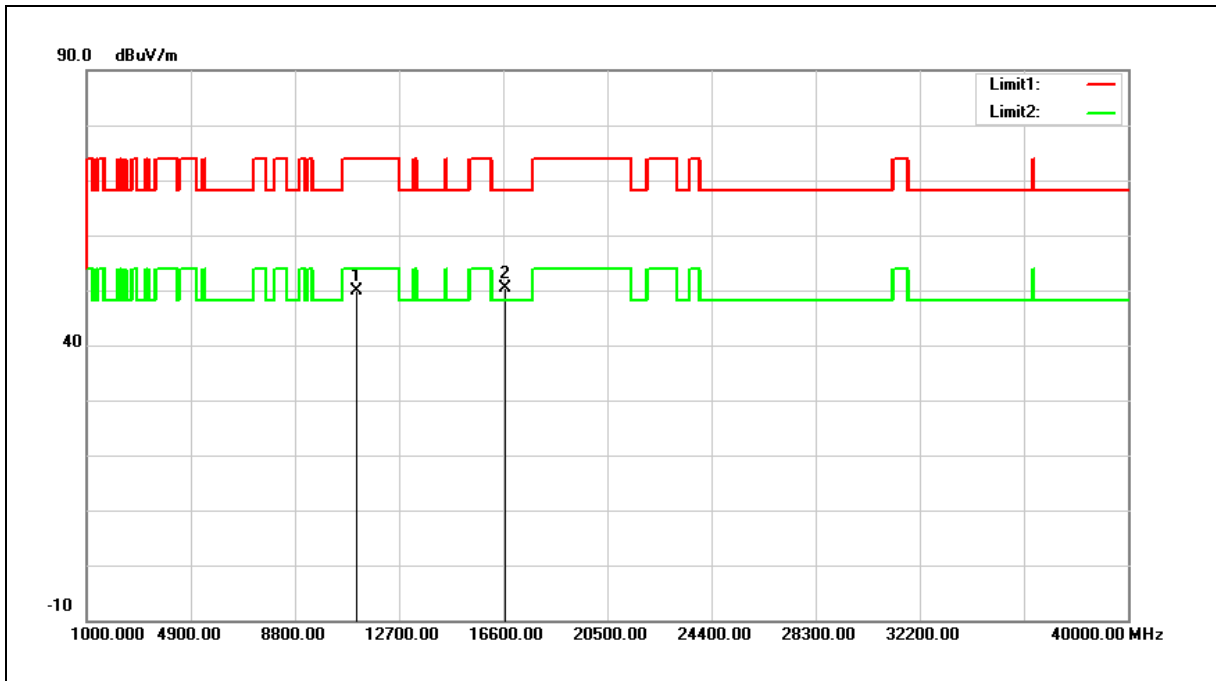

No.	Frequency (MHz)	Reading (dBuV)	Correct Factor (dB/m)	Result (dBuV/m)	Limit (dBuV/m)	Margin (dB)	Remark
1	11120.000	35.10	14.70	49.80	74.00	-24.20	peak
2	16680.000	32.37	17.95	50.32	68.20	-17.88	peak

Note:1.Result (dBuV/m) = Correct Factor (dB/m) + Reading(dBuV).

2.Correction factor (dB/m) = Antenna Factor (dB/m) + Cable loss (dB) – Pre-Amplifier gain (dB).

3.When the peak results are less than average limit, so not need to evaluate the average.

Standard:	FCC Part 15.407	Test Distance:	3 m
Test item:	Harmonic		
Frequency:	5700 MHz		
Mode:	Mode 2		
Ant.Polar.:	Horizontal		

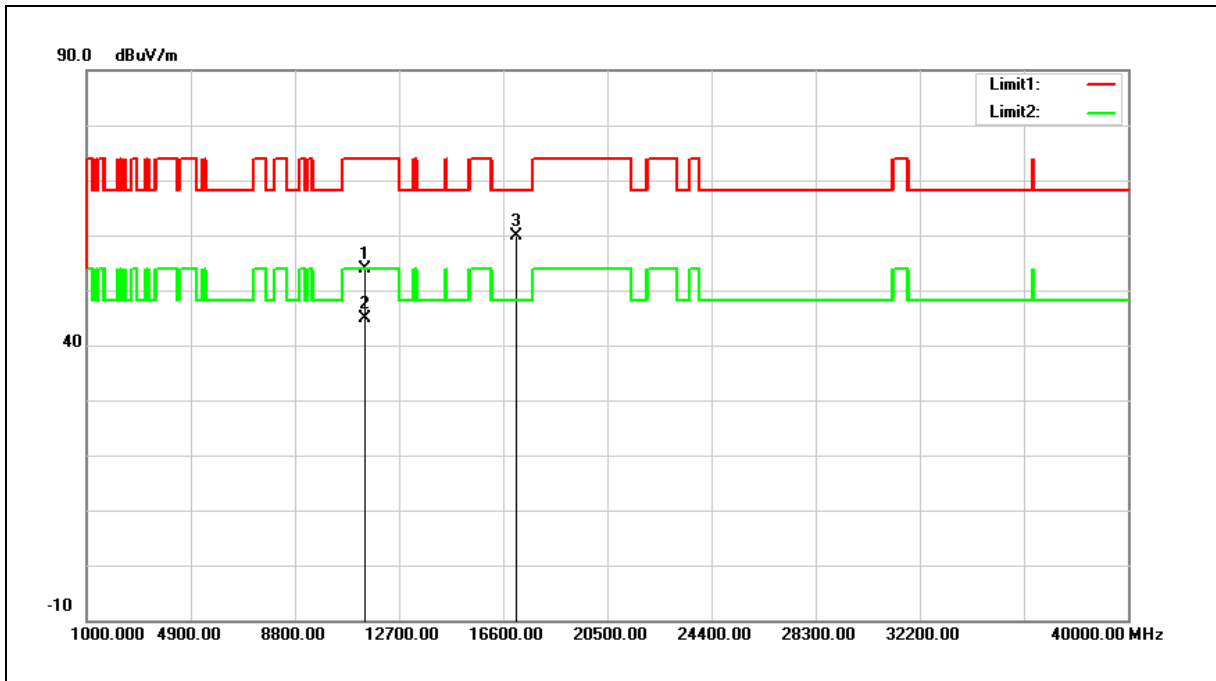

No.	Frequency (MHz)	Reading (dBuV)	Correct Factor (dB/m)	Result (dBuV/m)	Limit (dBuV/m)	Margin (dB)	Remark
1	11400.000	38.60	15.22	53.82	74.00	-20.18	peak
2	11400.000	29.67	15.22	44.89	54.00	-9.11	AVG
3	17100.000	39.00	20.89	59.89	68.20	-8.31	peak

Note:1.Result (dBuV/m) = Correct Factor (dB/m) + Reading(dBuV).

2.Correction factor (dB/m) = Antenna Factor (dB/m) + Cable loss (dB) – Pre-Amplifier gain (dB).

3.When the peak results are less than average limit, so not need to evaluate the average.

Standard:	FCC Part 15.407	Test Distance:	3 m
Test item:	Harmonic		
Frequency:	5700 MHz		
Mode:	Mode 2		
Ant.Polar.:	Vertical		

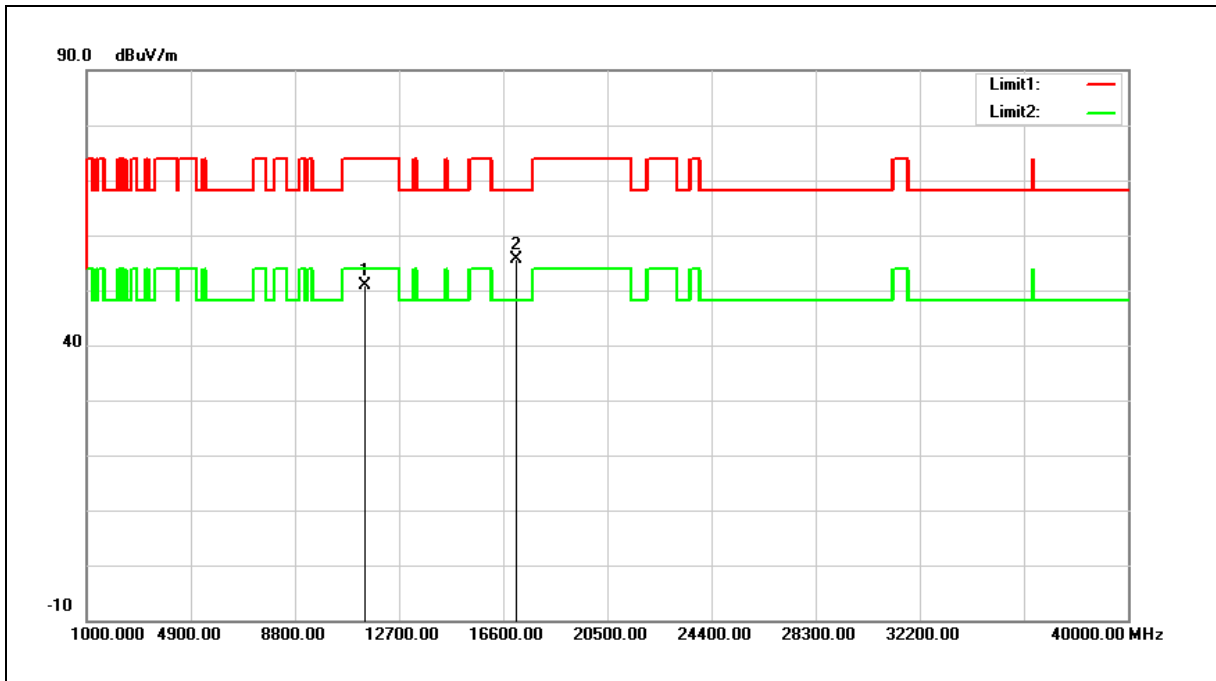

No.	Frequency (MHz)	Reading (dBuV)	Correct Factor (dB/m)	Result (dBuV/m)	Limit (dBuV/m)	Margin (dB)	Remark
1	11400.000	35.62	15.22	50.84	74.00	-23.16	peak
2	17100.000	34.73	20.89	55.62	68.20	-12.58	peak

Note:1.Result (dBuV/m) = Correct Factor (dB/m) + Reading(dBuV).

2.Correction factor (dB/m) = Antenna Factor (dB/m) + Cable loss (dB) – Pre-Amplifier gain (dB).

3.When the peak results are less than average limit, so not need to evaluate the average.

Standard:	FCC Part 15.407	Test Distance:	3 m
Test item:	Harmonic		
Frequency:	5745 MHz		
Mode:	Mode 2		
Ant.Polar.:	Horizontal		

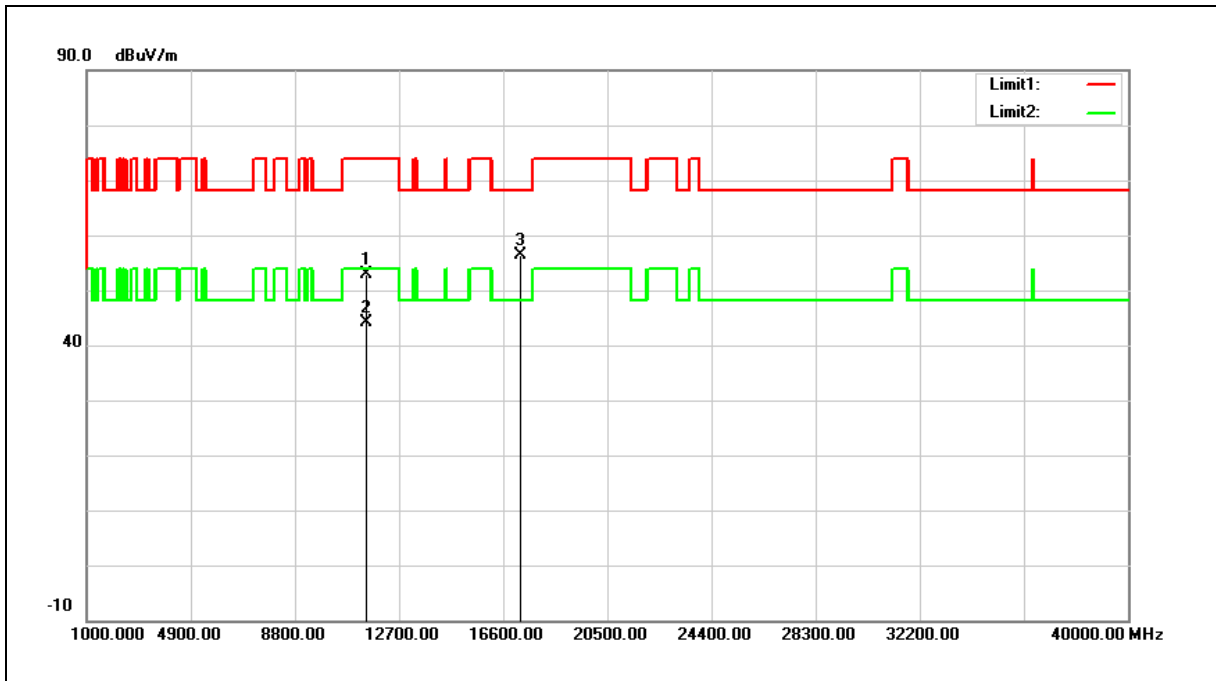

No.	Frequency (MHz)	Reading (dBuV)	Correct Factor (dB/m)	Result (dBuV/m)	Limit (dBuV/m)	Margin (dB)	Remark
1	11490.000	37.57	15.39	52.96	74.00	-21.04	peak
2	11490.000	28.76	15.39	44.15	54.00	-9.85	AVG
3	17235.000	34.71	21.71	56.42	68.20	-11.78	peak

Note:1.Result (dBuV/m) = Correct Factor (dB/m) + Reading(dBuV).

2.Correction factor (dB/m) = Antenna Factor (dB/m) + Cable loss (dB) – Pre-Amplifier gain (dB).

3.When the peak results are less than average limit, so not need to evaluate the average.

Standard:	FCC Part 15.407	Test Distance:	3 m
Test item:	Harmonic		
Frequency:	5745 MHz		
Mode:	Mode 2		
Ant.Polar.:	Vertical		

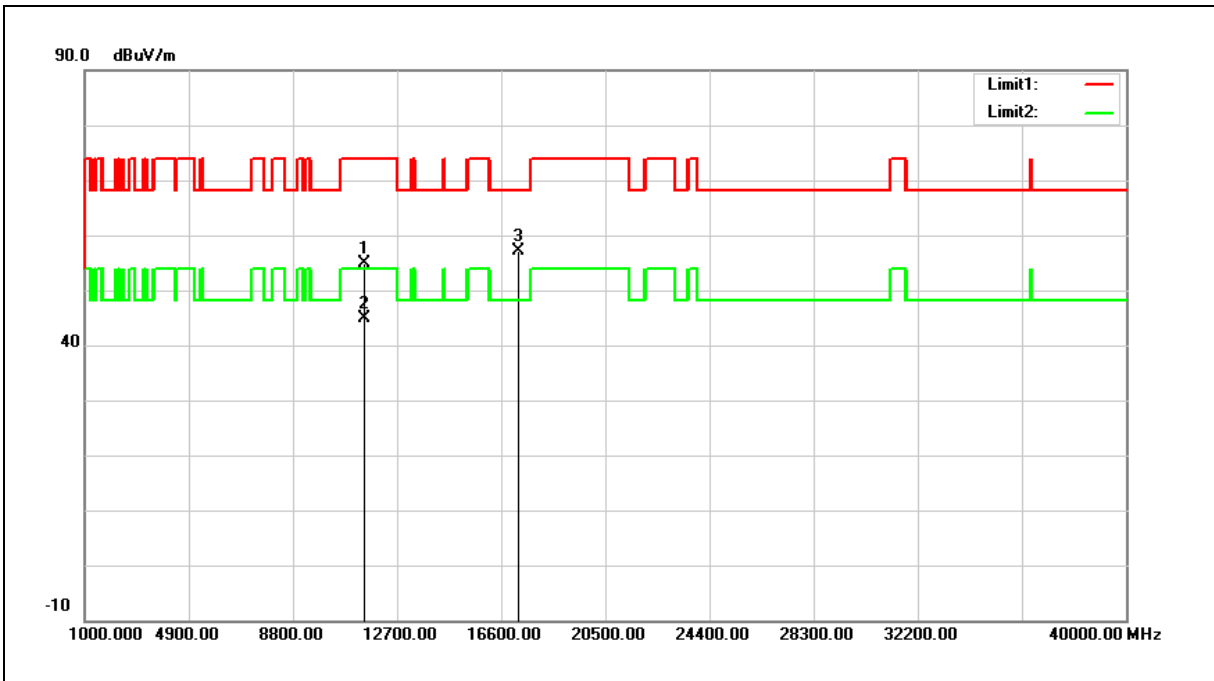

No.	Frequency (MHz)	Reading (dBuV)	Correct Factor (dB/m)	Result (dBuV/m)	Limit (dBuV/m)	Margin (dB)	Remark
1	11490.000	39.53	15.39	54.92	74.00	-19.08	peak
2	11490.000	29.42	15.39	44.81	54.00	-9.19	AVG
3	17235.000	35.34	21.71	57.05	68.20	-11.15	peak

Note:1.Result (dBuV/m) = Correct Factor (dB/m) + Reading(dBuV).

2.Correction factor (dB/m) = Antenna Factor (dB/m) + Cable loss (dB) – Pre-Amplifier gain (dB).

3.When the peak results are less than average limit, so not need to evaluate the average.

Standard:	FCC Part 15.407	Test Distance:	3 m
Test item:	Harmonic		
Frequency:	5785 MHz		
Mode:	Mode 2		
Ant.Polar.:	Horizontal		

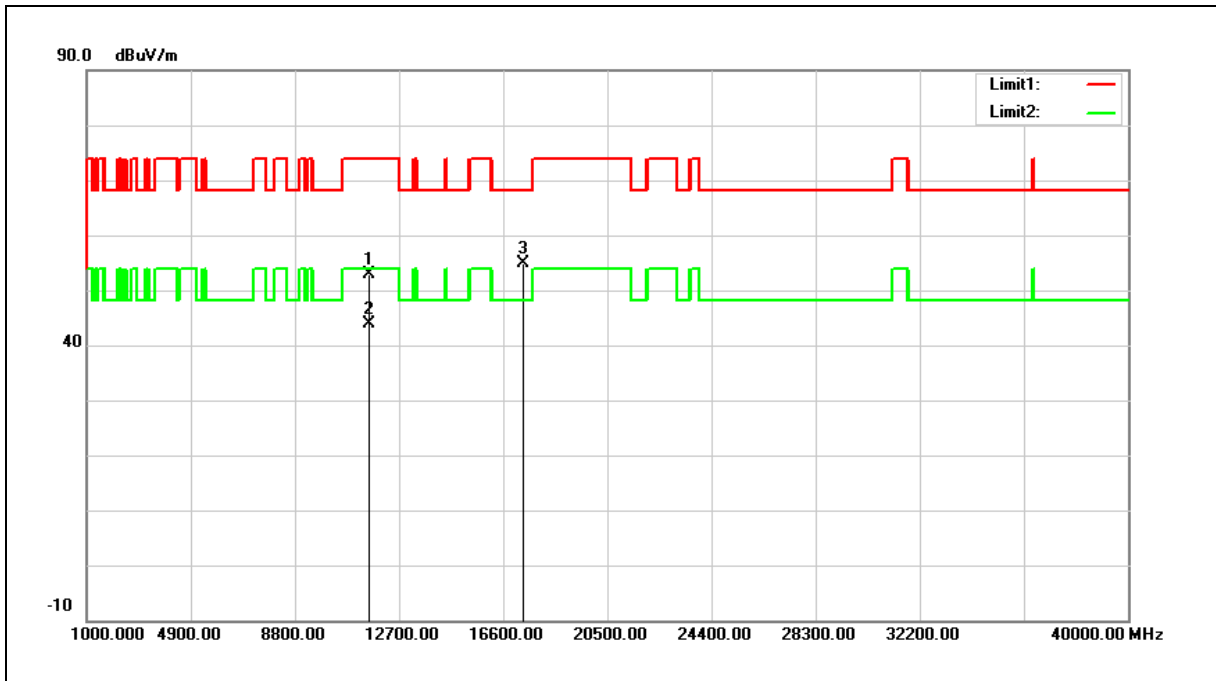

No.	Frequency (MHz)	Reading (dBuV)	Correct Factor (dB/m)	Result (dBuV/m)	Limit (dBuV/m)	Margin (dB)	Remark
1	11570.000	37.68	15.25	52.93	74.00	-21.07	peak
2	11570.000	28.71	15.25	43.96	54.00	-10.04	AVG
3	17355.000	32.37	22.42	54.79	68.20	-13.41	peak

Note:1.Result (dBuV/m) = Correct Factor (dB/m) + Reading(dBuV).

2.Correction factor (dB/m) = Antenna Factor (dB/m) + Cable loss (dB) – Pre-Amplifier gain (dB).

3.When the peak results are less than average limit, so not need to evaluate the average.

Standard:	FCC Part 15.407	Test Distance:	3 m
Test item:	Harmonic		
Frequency:	5785 MHz		
Mode:	Mode 2		
Ant.Polar.:	Vertical		

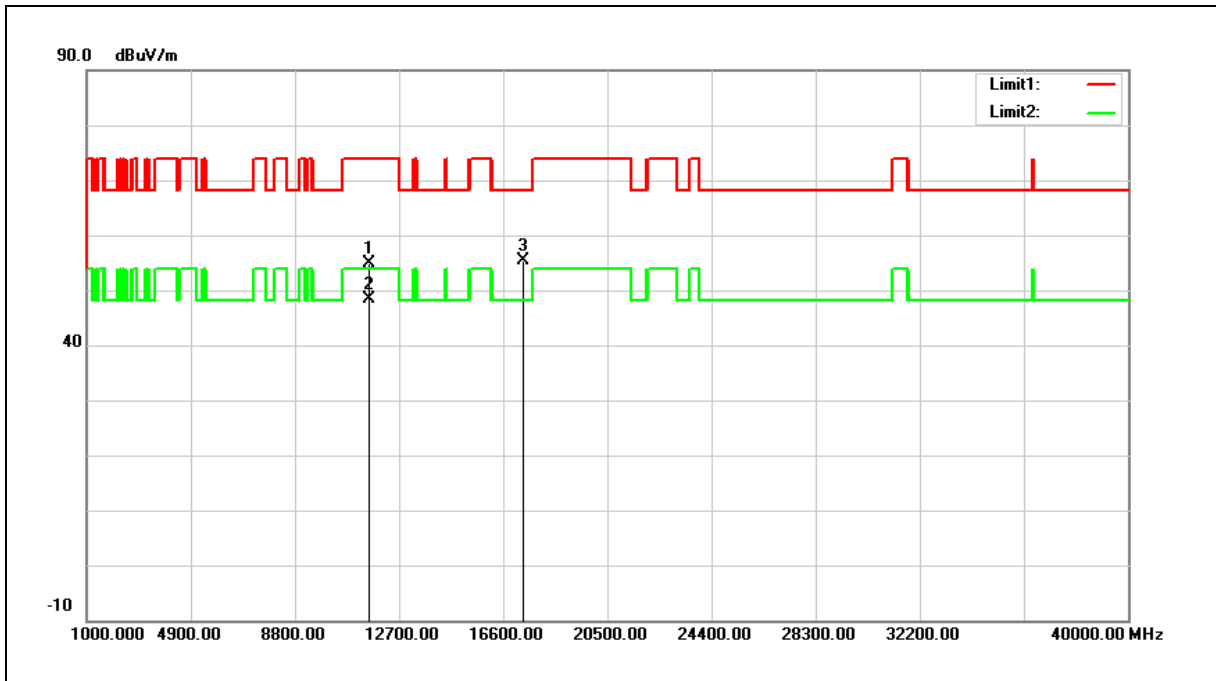

No.	Frequency (MHz)	Reading (dBuV)	Correct Factor (dB/m)	Result (dBuV/m)	Limit (dBuV/m)	Margin (dB)	Remark
1	11570.000	39.73	15.25	54.98	74.00	-19.02	peak
2	11570.000	33.06	15.25	48.31	54.00	-5.69	AVG
3	17355.000	33.03	22.42	55.45	68.20	-12.75	peak

Note:1.Result (dBuV/m) = Correct Factor (dB/m) + Reading(dBuV).

2.Correction factor (dB/m) = Antenna Factor (dB/m) + Cable loss (dB) – Pre-Amplifier gain (dB).

3.When the peak results are less than average limit, so not need to evaluate the average.

Standard:	FCC Part 15.407	Test Distance:	3 m
Test item:	Harmonic		
Frequency:	5825 MHz		
Mode:	Mode 2		
Ant.Polar.:	Horizontal		

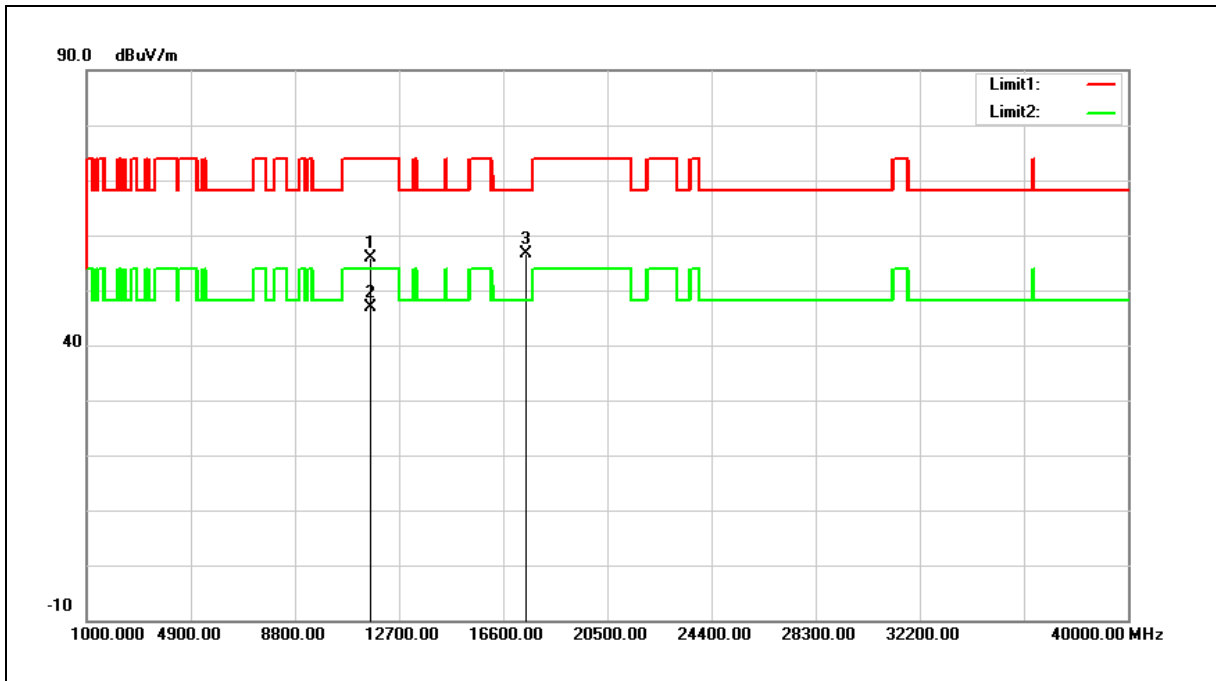

No.	Frequency (MHz)	Reading (dBuV)	Correct Factor (dB/m)	Result (dBuV/m)	Limit (dBuV/m)	Margin (dB)	Remark
1	11650.000	40.83	15.08	55.91	74.00	-18.09	peak
2	11650.000	31.68	15.08	46.76	54.00	-7.24	AVG
3	17475.000	33.60	23.13	56.73	68.20	-11.47	peak

Note:1.Result (dBuV/m) = Correct Factor (dB/m) + Reading(dBuV).

2.Correction factor (dB/m) = Antenna Factor (dB/m) + Cable loss (dB) – Pre-Amplifier gain (dB).

3.When the peak results are less than average limit, so not need to evaluate the average.

Standard:	FCC Part 15.407	Test Distance:	3 m
Test item:	Harmonic		
Frequency:	5825 MHz		
Mode:	Mode 2		
Ant.Polar.:	Vertical		

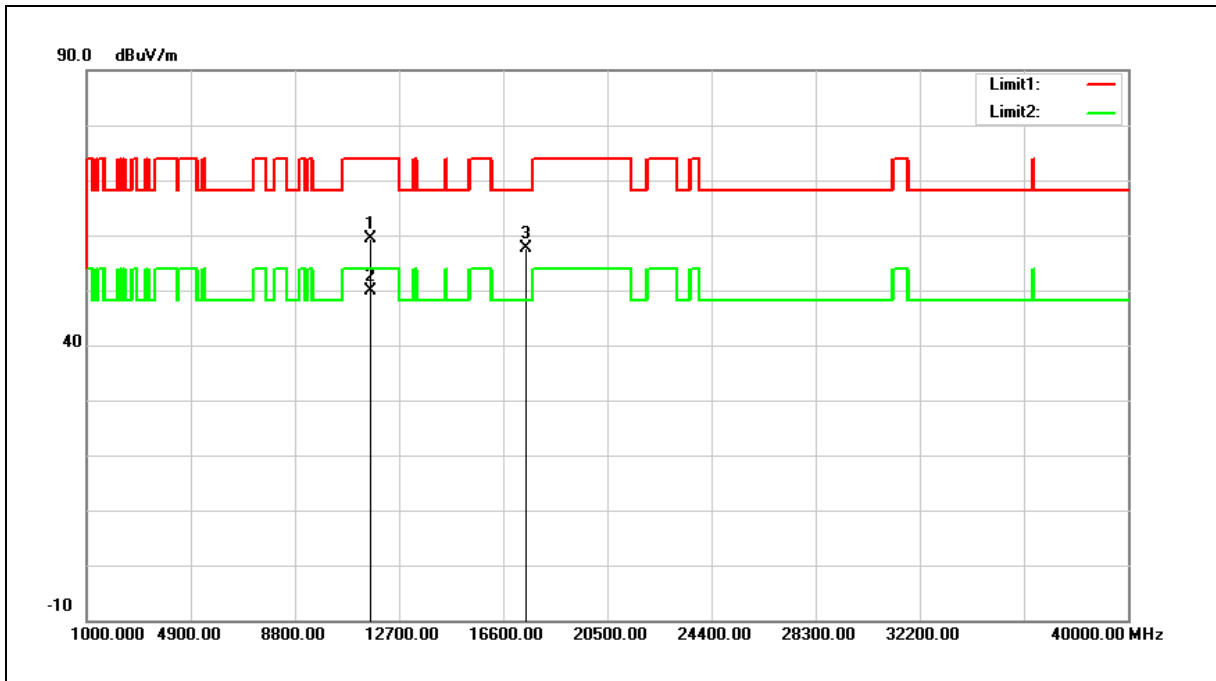

No.	Frequency (MHz)	Reading (dBuV)	Correct Factor (dB/m)	Result (dBuV/m)	Limit (dBuV/m)	Margin (dB)	Remark
1	11650.000	44.22	15.08	59.30	74.00	-14.70	peak
2	11650.000	34.85	15.08	49.93	54.00	-4.07	AVG
3	17475.000	34.42	23.13	57.55	68.20	-10.65	peak

Note:1.Result (dBuV/m) = Correct Factor (dB/m) + Reading(dBuV).

2.Correction factor (dB/m) = Antenna Factor (dB/m) + Cable loss (dB) – Pre-Amplifier gain (dB).

3.When the peak results are less than average limit, so not need to evaluate the average.

Standard:	FCC Part 15.407	Test Distance:	3 m
Test item:	Harmonic		
Frequency:	5180 MHz		
Mode:	Mode 8		
Ant.Polar.:	Horizontal		

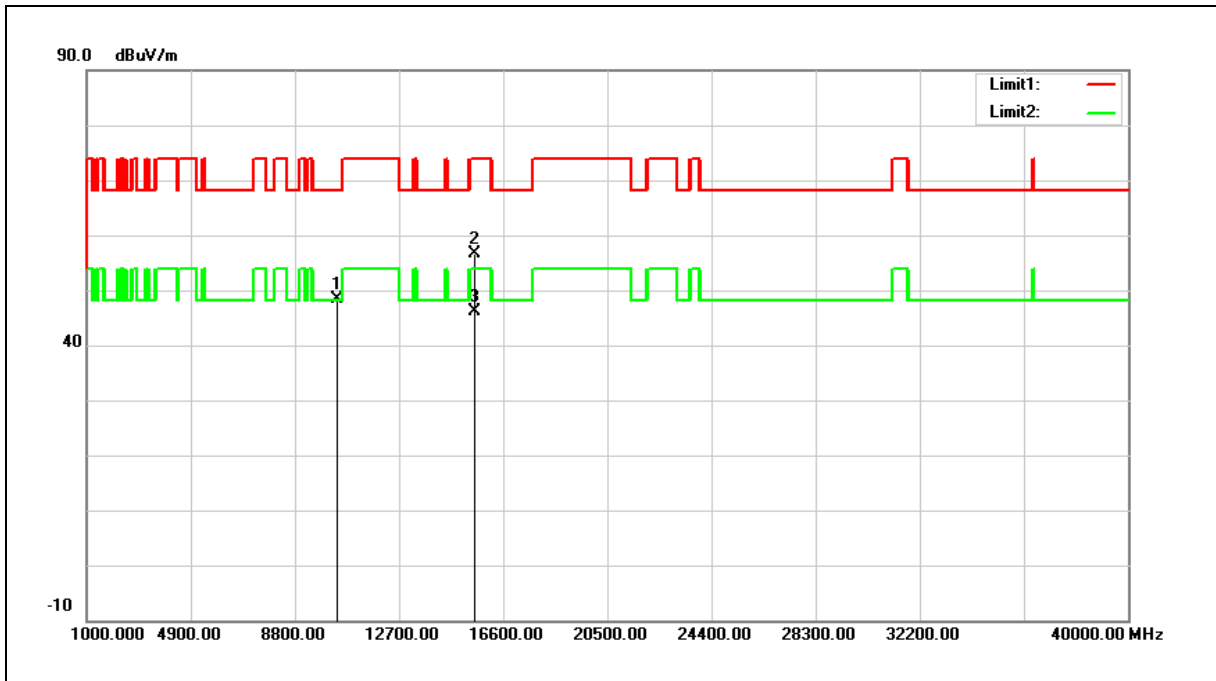

No.	Frequency (MHz)	Reading (dBuV)	Correct Factor (dB/m)	Result (dBuV/m)	Limit (dBuV/m)	Margin (dB)	Remark
1	10360.000	34.08	14.29	48.37	68.20	-19.83	peak
2	15540.000	39.83	16.86	56.69	74.00	-17.31	peak
3	15540.000	29.22	16.86	46.08	54.00	-7.92	AVG

Note:1.Result (dBuV/m) = Correct Factor (dB/m) + Reading(dBuV).

2.Correction factor (dB/m) = Antenna Factor (dB/m) + Cable loss (dB) – Pre-Amplifier gain (dB).

3.When the peak results are less than average limit, so not need to evaluate the average.

Standard:	FCC Part 15.407	Test Distance:	3 m
Test item:	Harmonic		
Frequency:	5180 MHz		
Mode:	Mode 8		
Ant.Polar.:	Vertical		

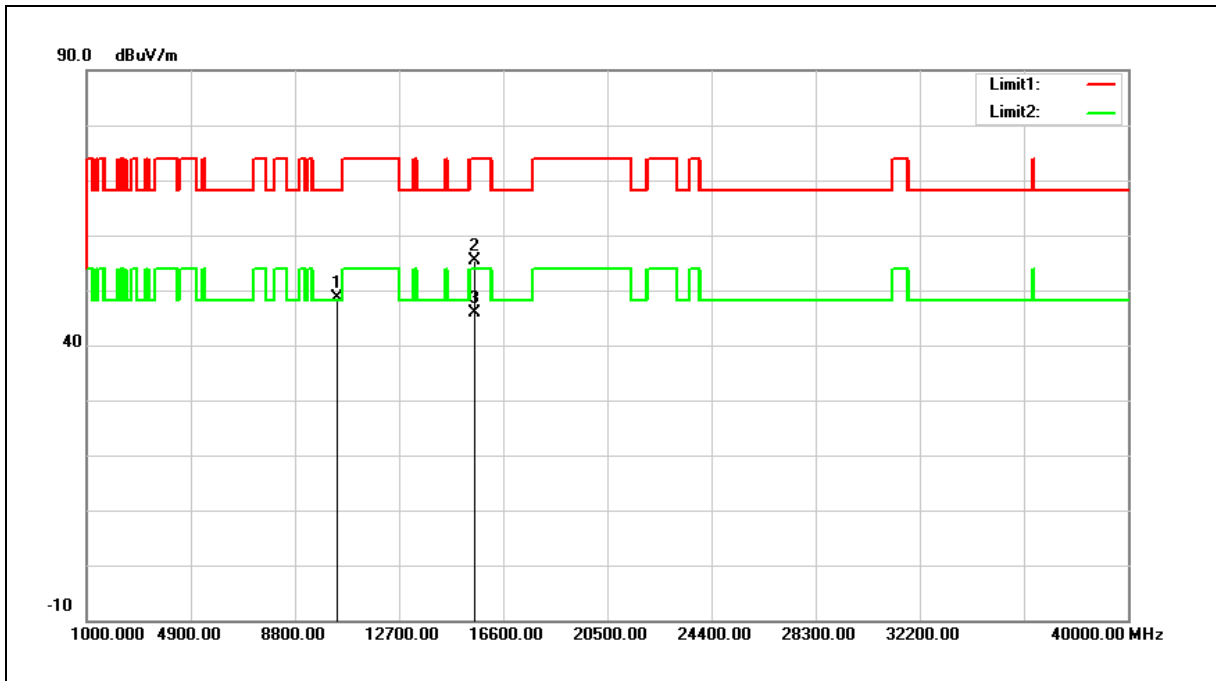

No.	Frequency (MHz)	Reading (dBuV)	Correct Factor (dB/m)	Result (dBuV/m)	Limit (dBuV/m)	Margin (dB)	Remark
1	10360.000	34.29	14.29	48.58	68.20	-19.62	peak
2	15540.000	38.54	16.86	55.40	74.00	-18.60	peak
3	15540.000	29.11	16.86	45.97	54.00	-8.03	AVG

Note:1.Result (dBuV/m) = Correct Factor (dB/m) + Reading(dBuV).

2.Correction factor (dB/m) = Antenna Factor (dB/m) + Cable loss (dB) – Pre-Amplifier gain (dB).

3.When the peak results are less than average limit, so not need to evaluate the average.

Standard:	FCC Part 15.407	Test Distance:	3 m
Test item:	Harmonic		
Frequency:	5200 MHz		
Mode:	Mode 8		
Ant.Polar.:	Horizontal		

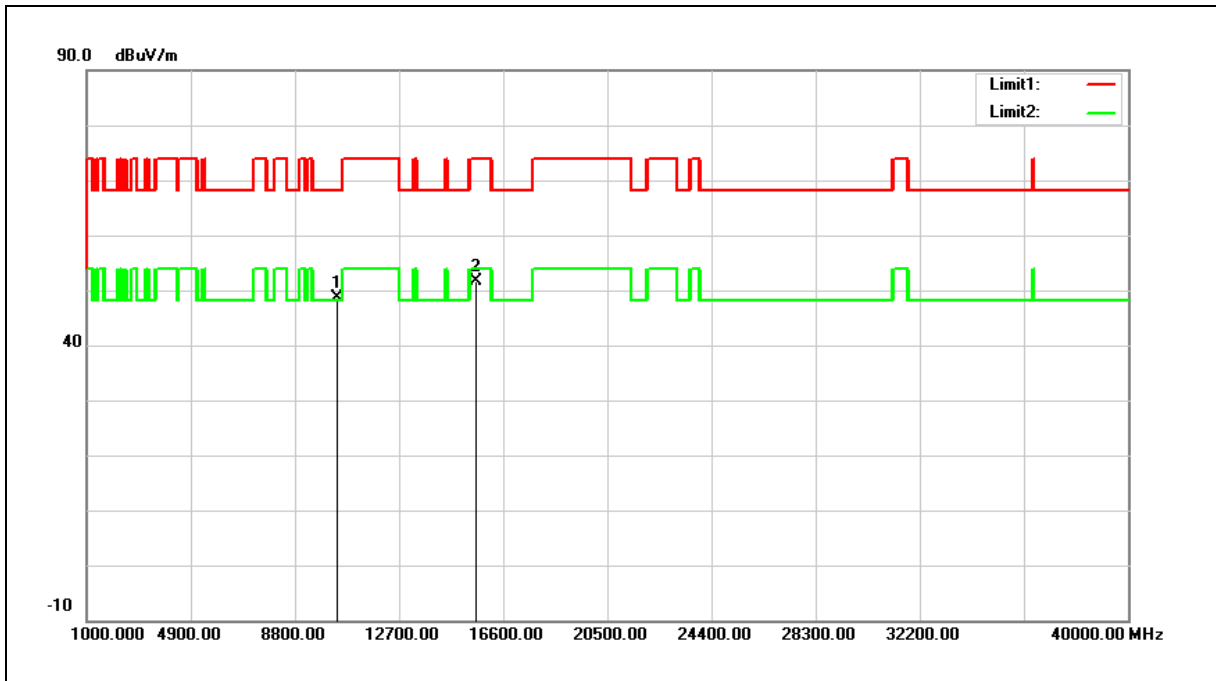

No.	Frequency (MHz)	Reading (dBuV)	Correct Factor (dB/m)	Result (dBuV/m)	Limit (dBuV/m)	Margin (dB)	Remark
1	10400.000	34.34	14.38	48.72	68.20	-19.48	peak
2	15600.000	35.06	16.65	51.71	74.00	-22.29	peak

Note:1.Result (dBuV/m) = Correct Factor (dB/m) + Reading(dBuV).

2.Correction factor (dB/m) = Antenna Factor (dB/m) + Cable loss (dB) – Pre-Amplifier gain (dB).

3.When the peak results are less than average limit, so not need to evaluate the average.

Standard:	FCC Part 15.407	Test Distance:	3 m
Test item:	Harmonic		
Frequency:	5200 MHz		
Mode:	Mode 8		
Ant.Polar.:	Vertical		

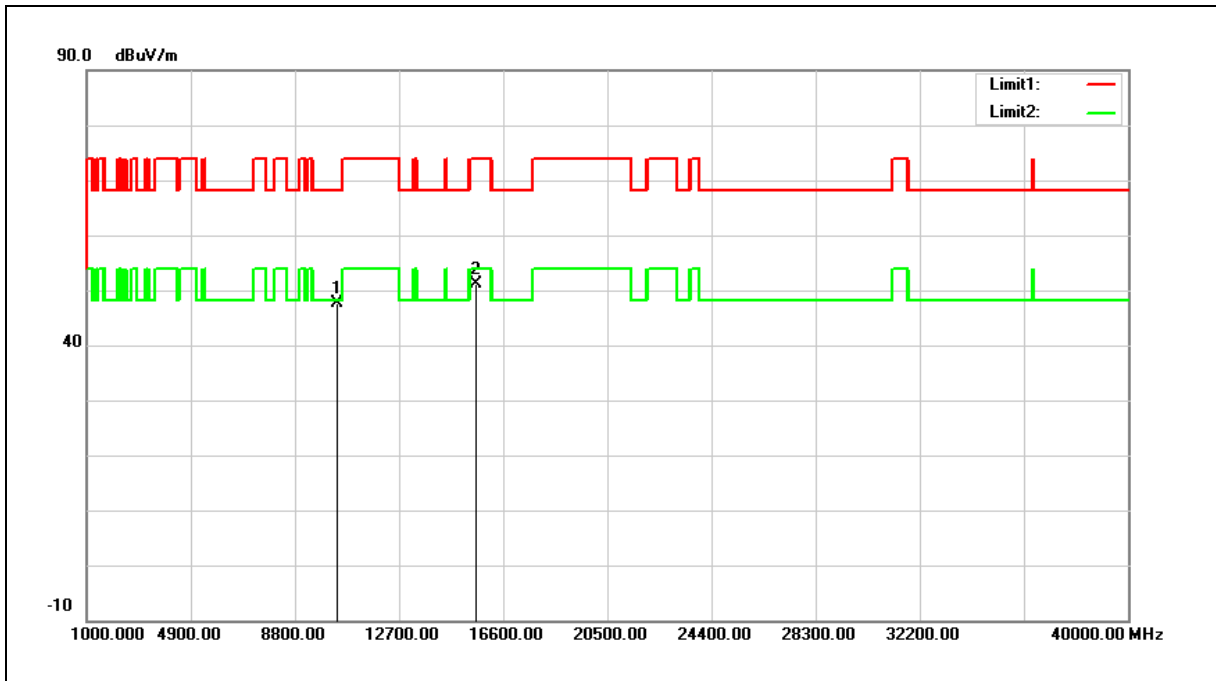

No.	Frequency (MHz)	Reading (dBuV)	Correct Factor (dB/m)	Result (dBuV/m)	Limit (dBuV/m)	Margin (dB)	Remark
1	10400.000	33.34	14.38	47.72	68.20	-20.48	peak
2	15600.000	34.38	16.65	51.03	74.00	-22.97	peak

Note:1.Result (dBuV/m) = Correct Factor (dB/m) + Reading(dBuV).

2.Correction factor (dB/m) = Antenna Factor (dB/m) + Cable loss (dB) – Pre-Amplifier gain (dB).

3.When the peak results are less than average limit, so not need to evaluate the average.

Standard:	FCC Part 15.407	Test Distance:	3 m
Test item:	Harmonic		
Frequency:	5240 MHz		
Mode:	Mode 8		
Ant.Polar.:	Horizontal		

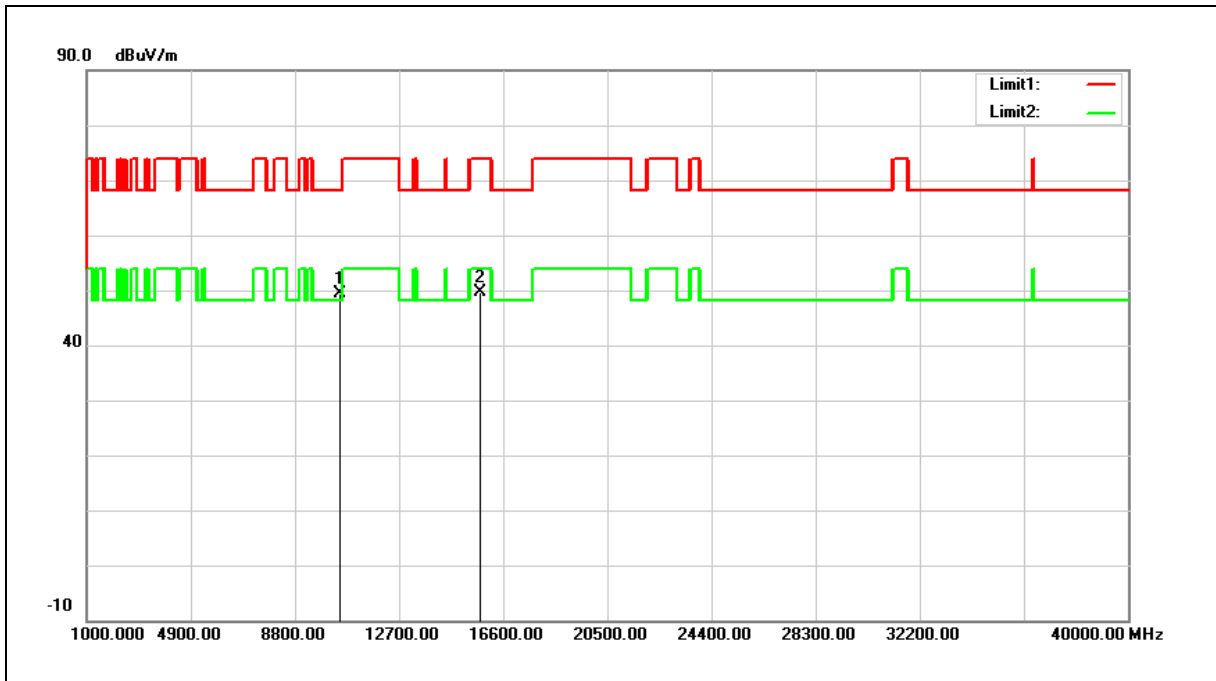

No.	Frequency (MHz)	Reading (dBuV)	Correct Factor (dB/m)	Result (dBuV/m)	Limit (dBuV/m)	Margin (dB)	Remark
1	10480.000	34.93	14.55	49.48	68.20	-18.72	peak
2	15720.000	33.44	16.24	49.68	74.00	-24.32	peak

Note:1.Result (dBuV/m) = Correct Factor (dB/m) + Reading(dBuV).

2.Correction factor (dB/m) = Antenna Factor (dB/m) + Cable loss (dB) – Pre-Amplifier gain (dB).

3.When the peak results are less than average limit, so not need to evaluate the average.

Standard:	FCC Part 15.407	Test Distance:	3 m
Test item:	Harmonic		
Frequency:	5240 MHz		
Mode:	Mode 8		
Ant.Polar.:	Vertical		

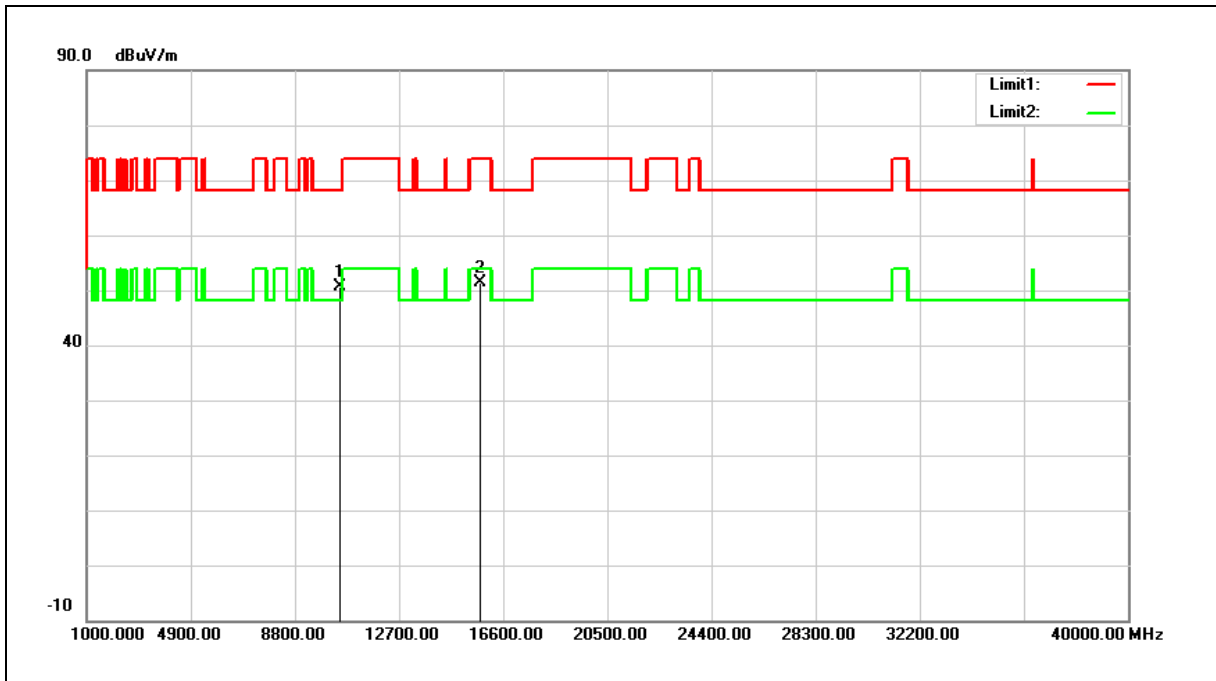

No.	Frequency (MHz)	Reading (dBuV)	Correct Factor (dB/m)	Result (dBuV/m)	Limit (dBuV/m)	Margin (dB)	Remark
1	10480.000	35.96	14.55	50.51	68.20	-17.69	peak
2	15720.000	35.05	16.24	51.29	74.00	-22.71	peak

Note:1.Result (dBuV/m) = Correct Factor (dB/m) + Reading(dBuV).

2.Correction factor (dB/m) = Antenna Factor (dB/m) + Cable loss (dB) – Pre-Amplifier gain (dB).

3.When the peak results are less than average limit, so not need to evaluate the average.

Standard:	FCC Part 15.407	Test Distance:	3 m
Test item:	Harmonic		
Frequency:	5260 MHz		
Mode:	Mode 8		
Ant.Polar.:	Horizontal		

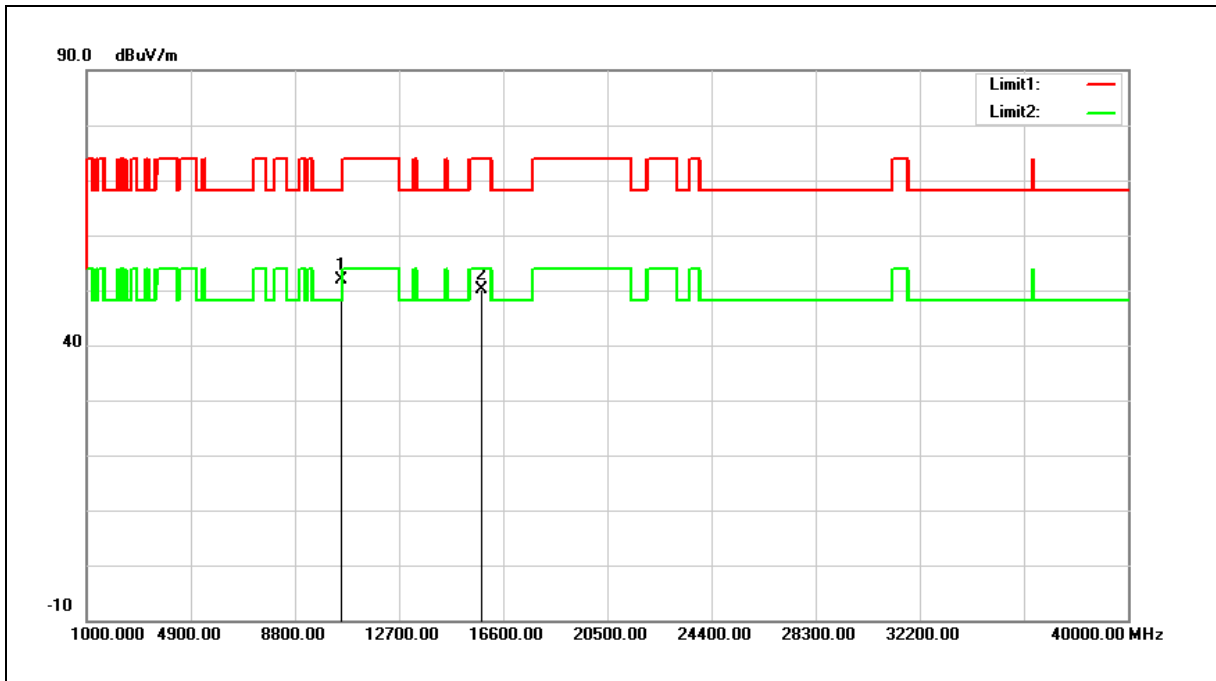

No.	Frequency (MHz)	Reading (dBuV)	Correct Factor (dB/m)	Result (dBuV/m)	Limit (dBuV/m)	Margin (dB)	Remark
1	10520.000	37.27	14.59	51.86	68.20	-16.34	peak
2	15780.000	34.19	16.06	50.25	74.00	-23.75	peak

Note:1.Result (dBuV/m) = Correct Factor (dB/m) + Reading(dBuV).

2.Correction factor (dB/m) = Antenna Factor (dB/m) + Cable loss (dB) – Pre-Amplifier gain (dB).

3.When the peak results are less than average limit, so not need to evaluate the average.

Standard:	FCC Part 15.407	Test Distance:	3 m
Test item:	Harmonic		
Frequency:	5260 MHz		
Mode:	Mode 8		
Ant.Polar.:	Vertical		

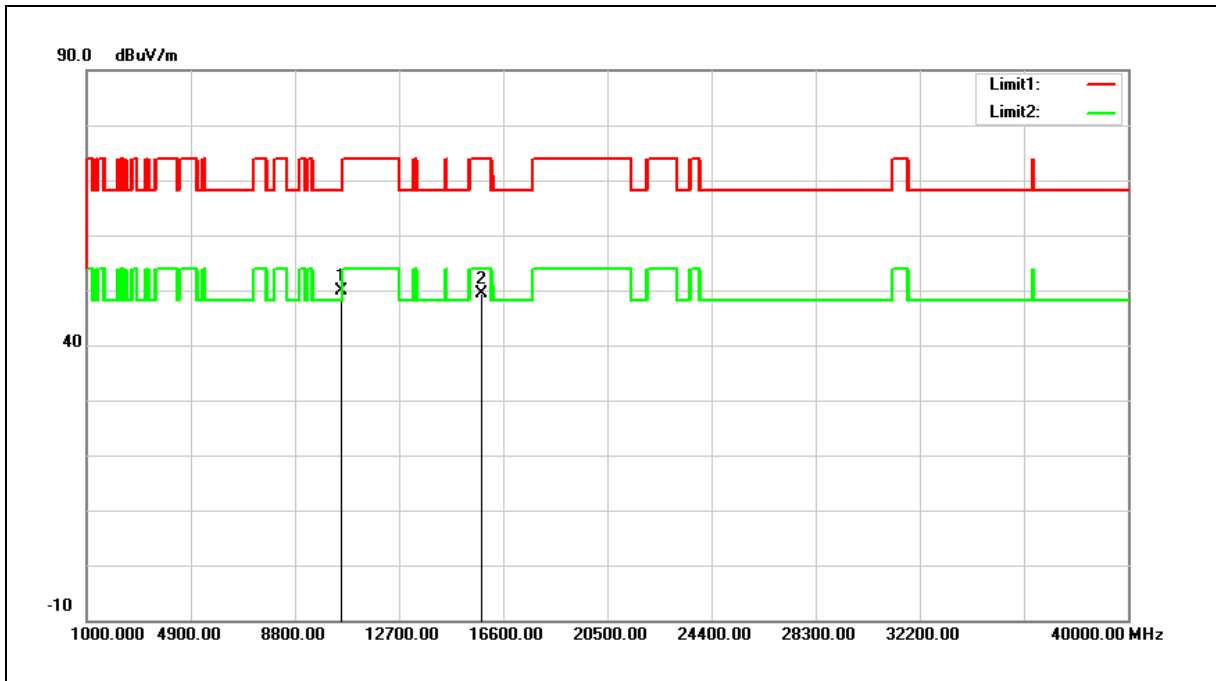

No.	Frequency (MHz)	Reading (dBuV)	Correct Factor (dB/m)	Result (dBuV/m)	Limit (dBuV/m)	Margin (dB)	Remark
1	10520.000	35.20	14.59	49.79	68.20	-18.41	peak
2	15780.000	33.31	16.06	49.37	74.00	-24.63	peak

Note:1.Result (dBuV/m) = Correct Factor (dB/m) + Reading(dBuV).

2.Correction factor (dB/m) = Antenna Factor (dB/m) + Cable loss (dB) – Pre-Amplifier gain (dB).

3.When the peak results are less than average limit, so not need to evaluate the average.

Standard:	FCC Part 15.407	Test Distance:	3 m
Test item:	Harmonic		
Frequency:	5280 MHz		
Mode:	Mode 8		
Ant.Polar.:	Horizontal		

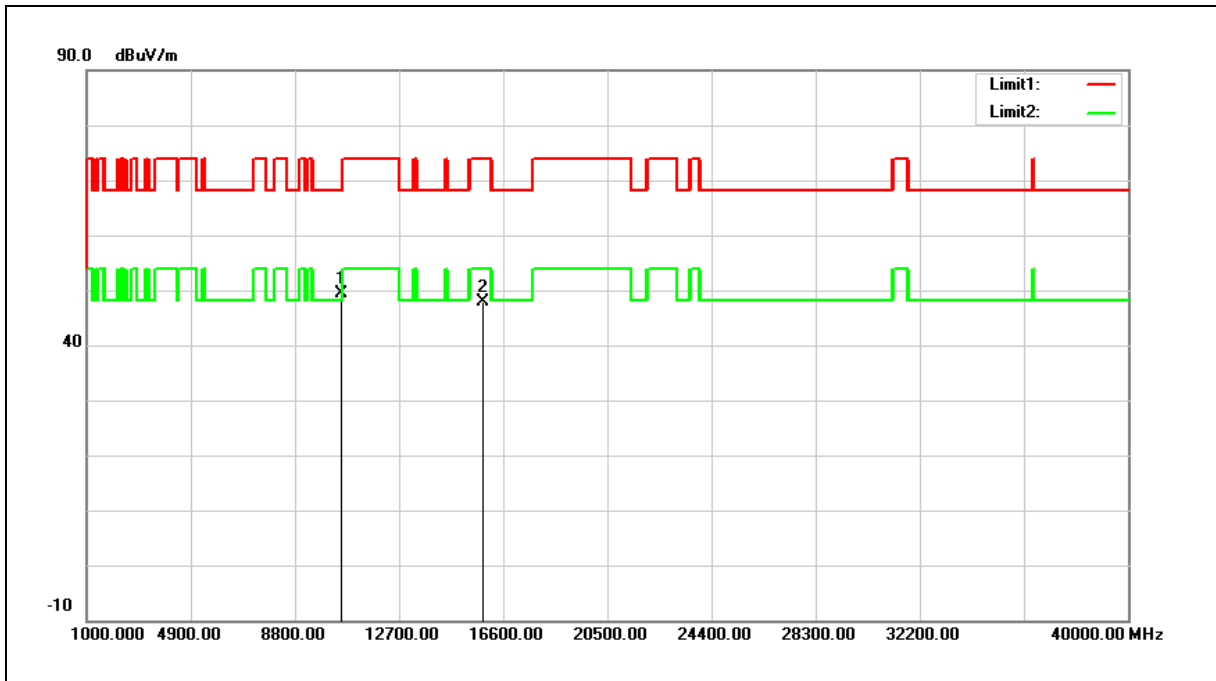

No.	Frequency (MHz)	Reading (dBuV)	Correct Factor (dB/m)	Result (dBuV/m)	Limit (dBuV/m)	Margin (dB)	Remark
1	10560.000	34.82	14.58	49.40	68.20	-18.80	peak
2	15840.000	32.05	15.85	47.90	74.00	-26.10	peak

Note: 1. Result (dBuV/m) = Correct Factor (dB/m) + Reading (dBuV).

2. Correction factor (dB/m) = Antenna Factor (dB/m) + Cable loss (dB) – Pre-Amplifier gain (dB).

3. When the peak results are less than average limit, so not need to evaluate the average.

Standard:	FCC Part 15.407	Test Distance:	3 m
Test item:	Harmonic		
Frequency:	5280 MHz		
Mode:	Mode 8		
Ant.Polar.:	Vertical		

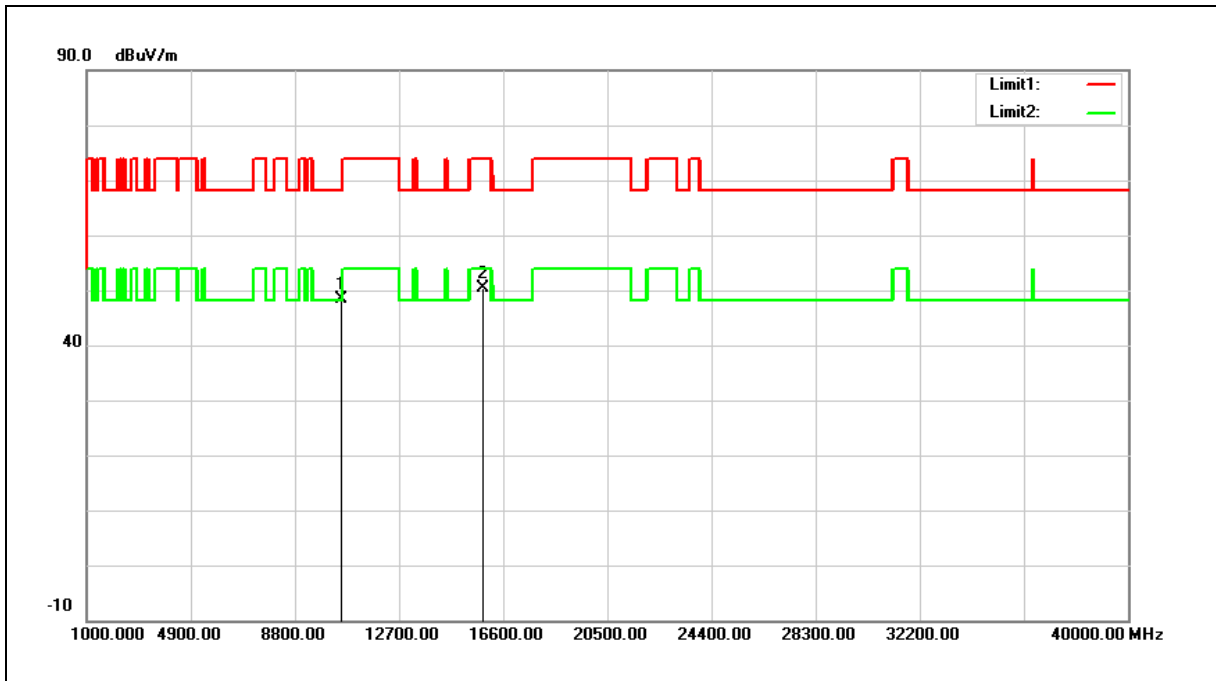

No.	Frequency (MHz)	Reading (dBuV)	Correct Factor (dB/m)	Result (dBuV/m)	Limit (dBuV/m)	Margin (dB)	Remark
1	10560.000	33.90	14.58	48.48	68.20	-19.72	peak
2	15840.000	34.50	15.85	50.35	74.00	-23.65	peak

Note:1.Result (dBuV/m) = Correct Factor (dB/m) + Reading(dBuV).

2.Correction factor (dB/m) = Antenna Factor (dB/m) + Cable loss (dB) – Pre-Amplifier gain (dB).

3.When the peak results are less than average limit, so not need to evaluate the average.

Standard:	FCC Part 15.407	Test Distance:	3 m
Test item:	Harmonic		
Frequency:	5320 MHz		
Mode:	Mode 8		
Ant.Polar.:	Horizontal		

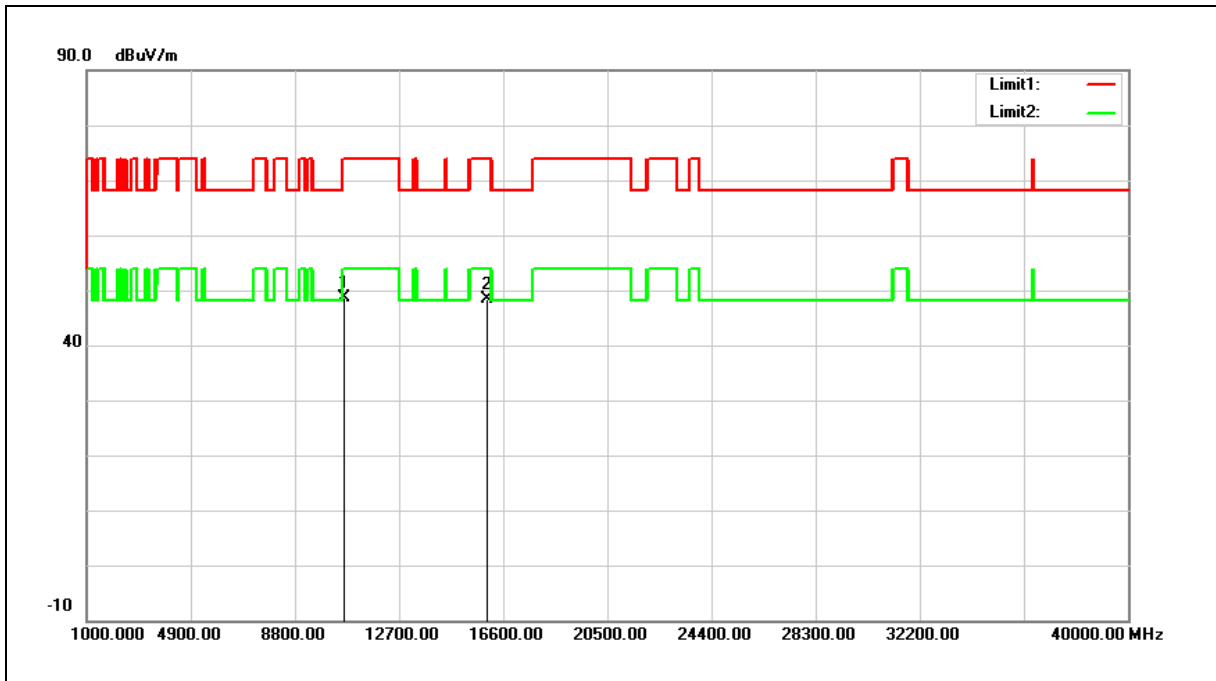

No.	Frequency (MHz)	Reading (dBuV)	Correct Factor (dB/m)	Result (dBuV/m)	Limit (dBuV/m)	Margin (dB)	Remark
1	10640.000	33.97	14.56	48.53	74.00	-25.47	peak
2	15960.000	32.85	15.44	48.29	74.00	-25.71	peak

Note:1.Result (dBuV/m) = Correct Factor (dB/m) + Reading(dBuV).

2.Correction factor (dB/m) = Antenna Factor (dB/m) + Cable loss (dB) – Pre-Amplifier gain (dB).

3.When the peak results are less than average limit, so not need to evaluate the average.

Standard:	FCC Part 15.407	Test Distance:	3 m
Test item:	Harmonic		
Frequency:	5320 MHz		
Mode:	Mode 8		
Ant.Polar.:	Vertical		

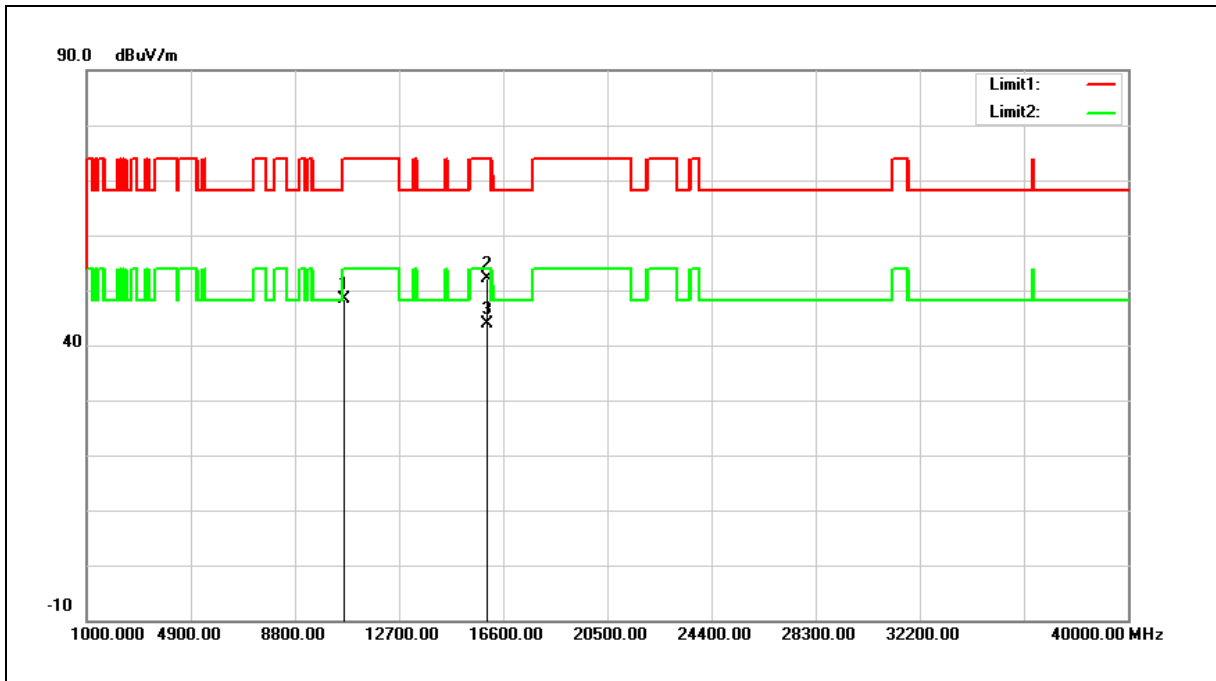

No.	Frequency (MHz)	Reading (dBuV)	Correct Factor (dB/m)	Result (dBuV/m)	Limit (dBuV/m)	Margin (dB)	Remark
1	10640.000	33.78	14.56	48.34	74.00	-25.66	peak
2	15960.000	36.74	15.44	52.18	74.00	-21.82	peak
3	15960.000	28.37	15.44	43.81	54.00	-10.19	AVG

Note:1.Result (dBuV/m) = Correct Factor (dB/m) + Reading(dBuV).

2.Correction factor (dB/m) = Antenna Factor (dB/m) + Cable loss (dB) – Pre-Amplifier gain (dB).

3.When the peak results are less than average limit, so not need to evaluate the average.

Standard:	FCC Part 15.407	Test Distance:	3 m
Test item:	Harmonic		
Frequency:	5500 MHz		
Mode:	Mode 8		
Ant.Polar.:	Horizontal		

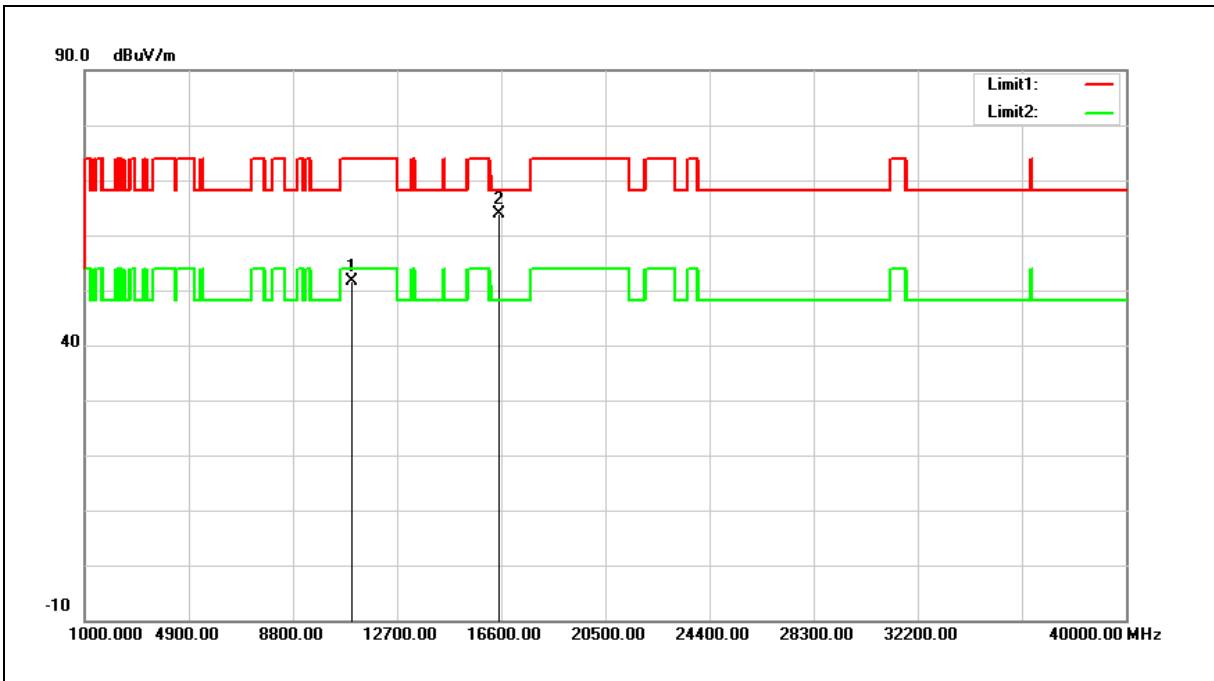

No.	Frequency (MHz)	Reading (dBuV)	Correct Factor (dB/m)	Result (dBuV/m)	Limit (dBuV/m)	Margin (dB)	Remark
1	11000.000	37.05	14.47	51.52	74.00	-22.48	peak
2	16500.000	47.37	16.63	64.00	68.20	-4.20	peak

Note:1.Result (dBuV/m) = Correct Factor (dB/m) + Reading(dBuV).

2.Correction factor (dB/m) = Antenna Factor (dB/m) + Cable loss (dB) – Pre-Amplifier gain (dB).

3.When the peak results are less than average limit, so not need to evaluate the average.

Standard:	FCC Part 15.407	Test Distance:	3 m
Test item:	Harmonic		
Frequency:	5500 MHz		
Mode:	Mode 8		
Ant.Polar.:	Vertical		

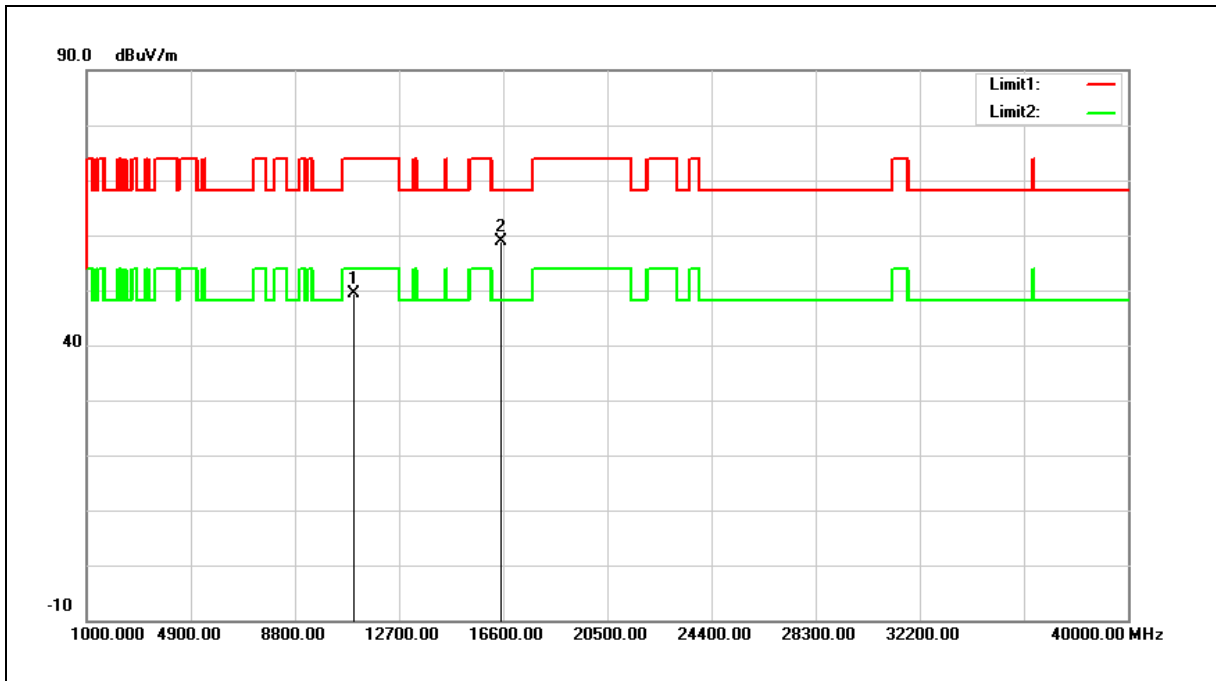

No.	Frequency (MHz)	Reading (dBuV)	Correct Factor (dB/m)	Result (dBuV/m)	Limit (dBuV/m)	Margin (dB)	Remark
1	11000.000	34.82	14.47	49.29	74.00	-24.71	peak
2	16500.000	42.16	16.63	58.79	68.20	-9.41	peak

Note:1.Result (dBuV/m) = Correct Factor (dB/m) + Reading(dBuV).

2.Correction factor (dB/m) = Antenna Factor (dB/m) + Cable loss (dB) – Pre-Amplifier gain (dB).

3.When the peak results are less than average limit, so not need to evaluate the average.

Standard:	FCC Part 15.407	Test Distance:	3 m
Test item:	Harmonic		
Frequency:	5560 MHz		
Mode:	Mode 8		
Ant.Polar.:	Horizontal		

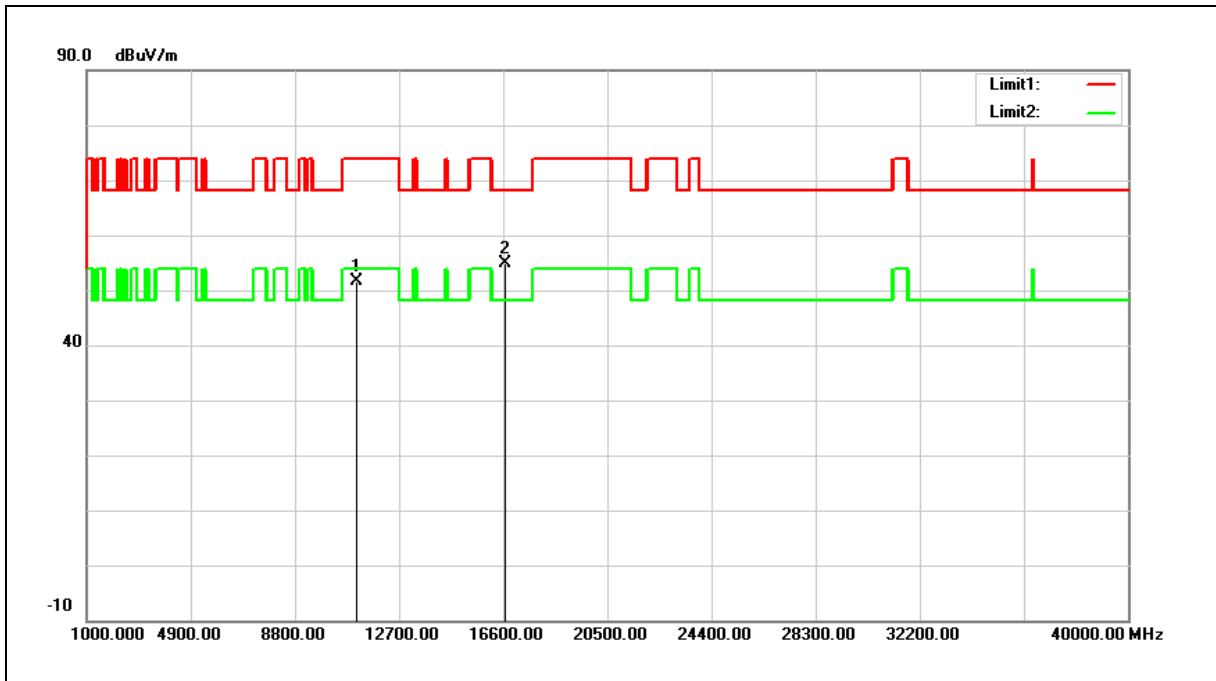

No.	Frequency (MHz)	Reading (dBuV)	Correct Factor (dB/m)	Result (dBuV/m)	Limit (dBuV/m)	Margin (dB)	Remark
1	11120.000	36.87	14.70	51.57	74.00	-22.43	peak
2	16680.000	36.99	17.95	54.94	68.20	-13.26	peak

Note:1.Result (dBuV/m) = Correct Factor (dB/m) + Reading(dBuV).

2.Correction factor (dB/m) = Antenna Factor (dB/m) + Cable loss (dB) – Pre-Amplifier gain (dB).

3.When the peak results are less than average limit, so not need to evaluate the average.

Standard:	FCC Part 15.407	Test Distance:	3 m
Test item:	Harmonic		
Frequency:	5560 MHz		
Mode:	Mode 8		
Ant.Polar.:	Vertical		

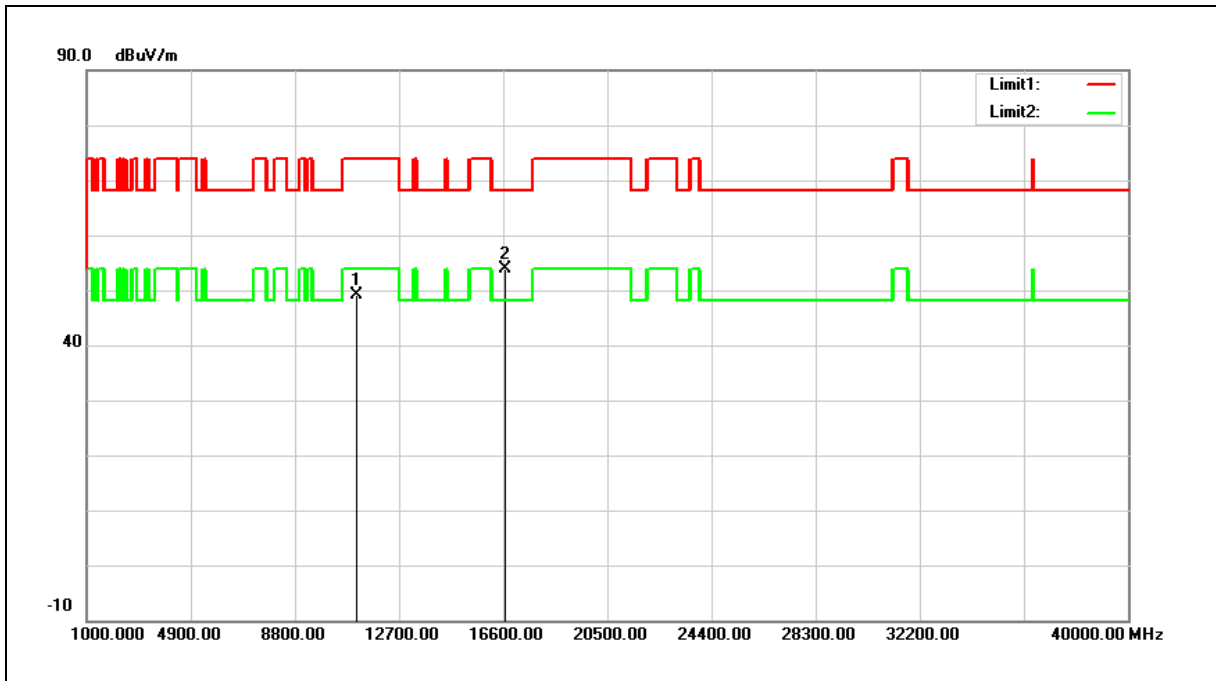

No.	Frequency (MHz)	Reading (dBuV)	Correct Factor (dB/m)	Result (dBuV/m)	Limit (dBuV/m)	Margin (dB)	Remark
1	11120.000	34.48	14.70	49.18	74.00	-24.82	peak
2	16680.000	35.83	17.95	53.78	68.20	-14.42	peak

Note:1.Result (dBuV/m) = Correct Factor (dB/m) + Reading(dBuV).

2.Correction factor (dB/m) = Antenna Factor (dB/m) + Cable loss (dB) – Pre-Amplifier gain (dB).

3.When the peak results are less than average limit, so not need to evaluate the average.

Standard:	FCC Part 15.407	Test Distance:	3 m
Test item:	Harmonic		
Frequency:	5700 MHz		
Mode:	Mode 8		
Ant.Polar.:	Horizontal		

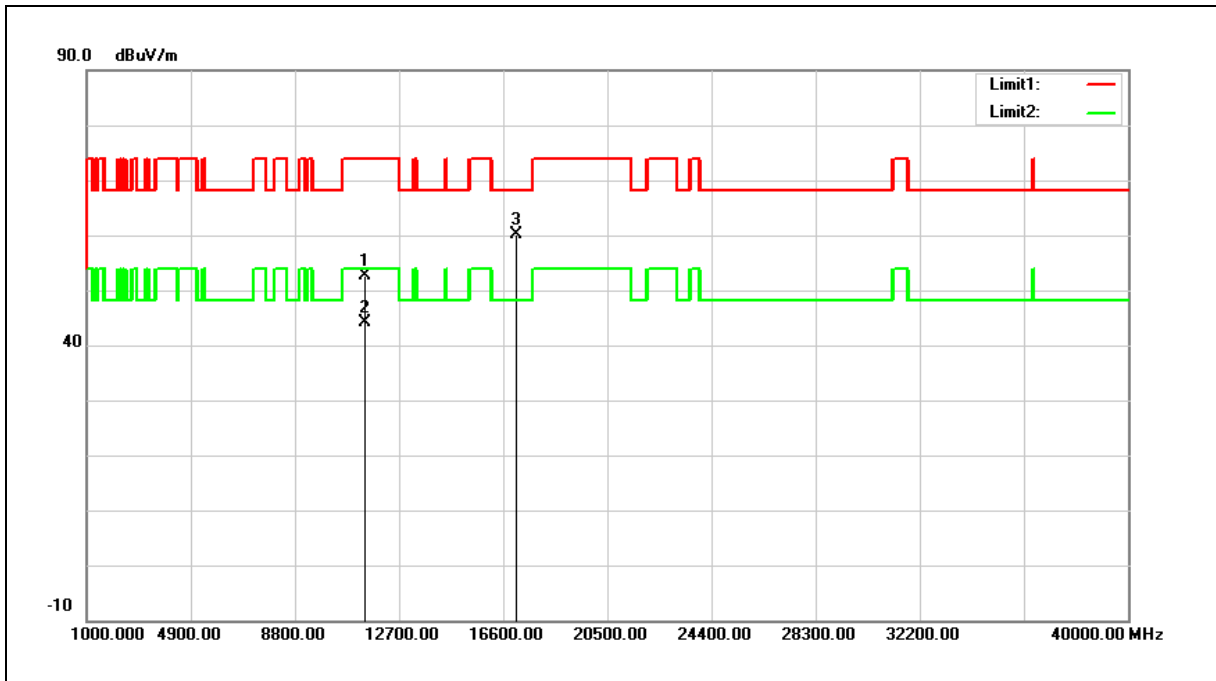

No.	Frequency (MHz)	Reading (dBuV)	Correct Factor (dB/m)	Result (dBuV/m)	Limit (dBuV/m)	Margin (dB)	Remark
1	11400.000	37.53	15.22	52.75	74.00	-21.25	peak
2	11400.000	28.86	15.22	44.08	54.00	-9.92	AVG
3	17100.000	39.29	20.89	60.18	68.20	-8.02	peak

Note:1.Result (dBuV/m) = Correct Factor (dB/m) + Reading(dBuV).

2.Correction factor (dB/m) = Antenna Factor (dB/m) + Cable loss (dB) – Pre-Amplifier gain (dB).

3.When the peak results are less than average limit, so not need to evaluate the average.

Standard:	FCC Part 15.407	Test Distance:	3 m
Test item:	Harmonic		
Frequency:	5700 MHz		
Mode:	Mode 8		
Ant.Polar.:	Vertical		

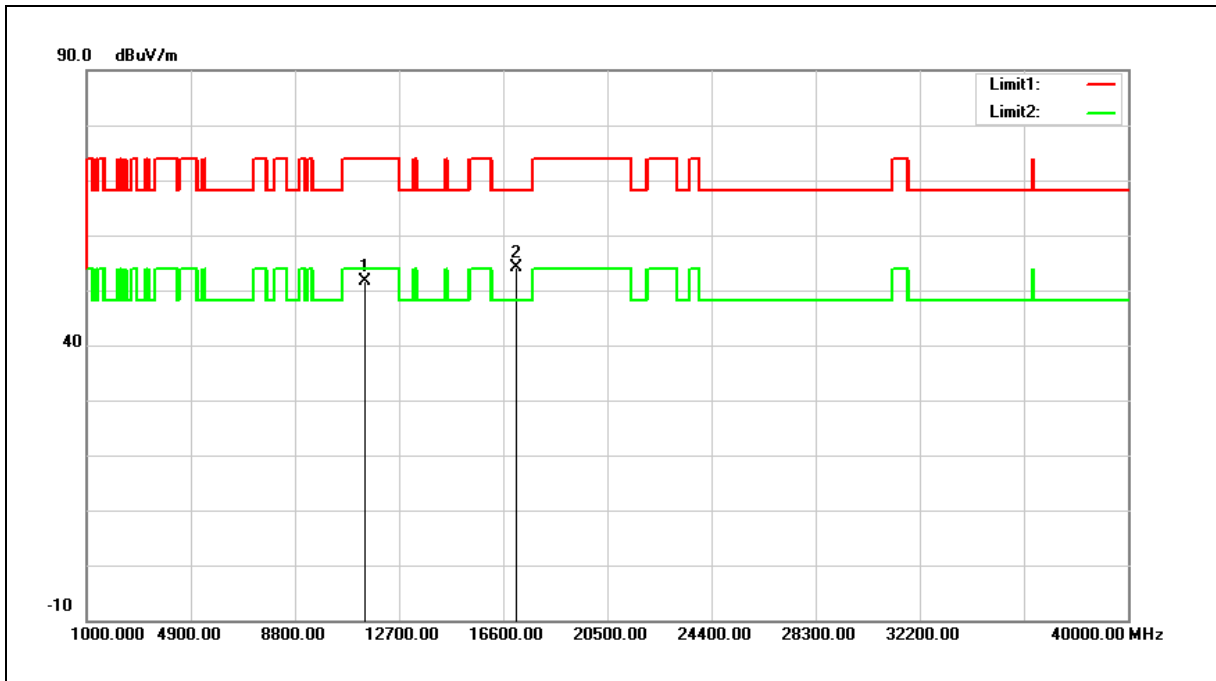

No.	Frequency (MHz)	Reading (dBuV)	Correct Factor (dB/m)	Result (dBuV/m)	Limit (dBuV/m)	Margin (dB)	Remark
1	11400.000	36.52	15.22	51.74	74.00	-22.26	peak
2	17100.000	33.29	20.89	54.18	68.20	-14.02	peak

Note:1.Result (dBuV/m) = Correct Factor (dB/m) + Reading(dBuV).

2.Correction factor (dB/m) = Antenna Factor (dB/m) + Cable loss (dB) – Pre-Amplifier gain (dB).

3.When the peak results are less than average limit, so not need to evaluate the average.

Standard:	FCC Part 15.407	Test Distance:	3 m
Test item:	Harmonic		
Frequency:	5745 MHz		
Mode:	Mode 8		
Ant.Polar.:	Horizontal		

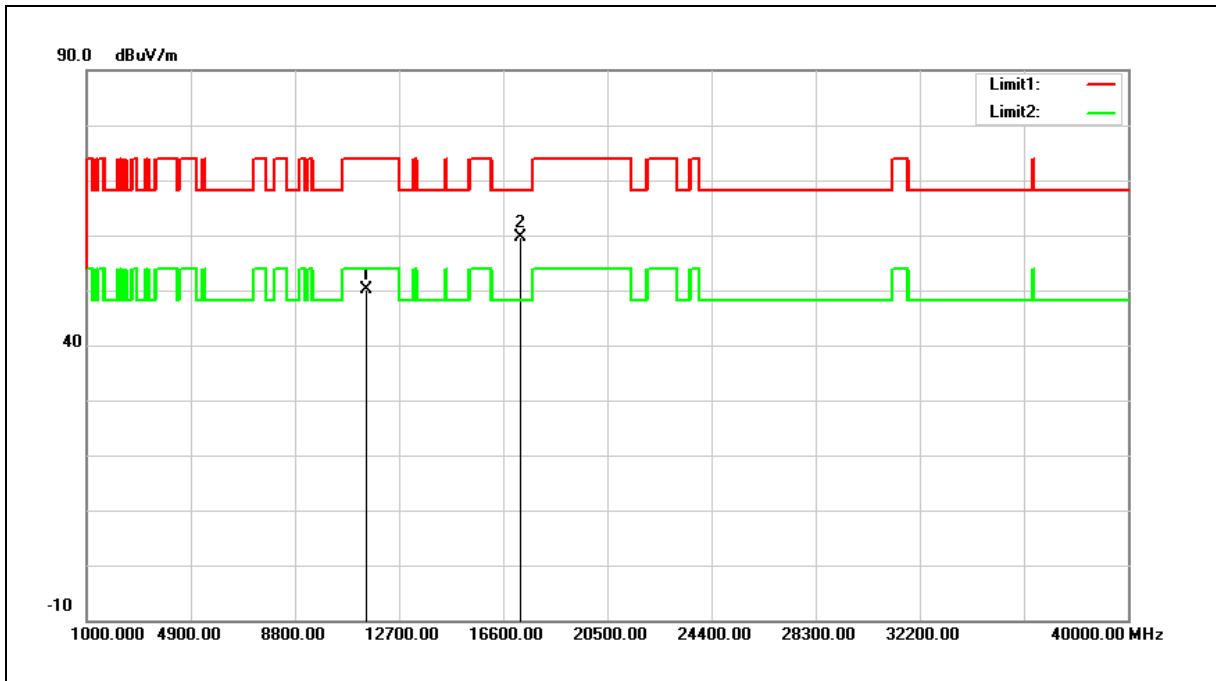

No.	Frequency (MHz)	Reading (dBuV)	Correct Factor (dB/m)	Result (dBuV/m)	Limit (dBuV/m)	Margin (dB)	Remark
1	11490.000	34.65	15.39	50.04	74.00	-23.96	peak
2	17235.000	37.84	21.71	59.55	68.20	-8.65	peak

Note:1.Result (dBuV/m) = Correct Factor (dB/m) + Reading(dBuV).

2.Correction factor (dB/m) = Antenna Factor (dB/m) + Cable loss (dB) – Pre-Amplifier gain (dB).

3.When the peak results are less than average limit, so not need to evaluate the average.

Standard:	FCC Part 15.407	Test Distance:	3 m
Test item:	Harmonic		
Frequency:	5745 MHz		
Mode:	Mode 8		
Ant.Polar.:	Vertical		

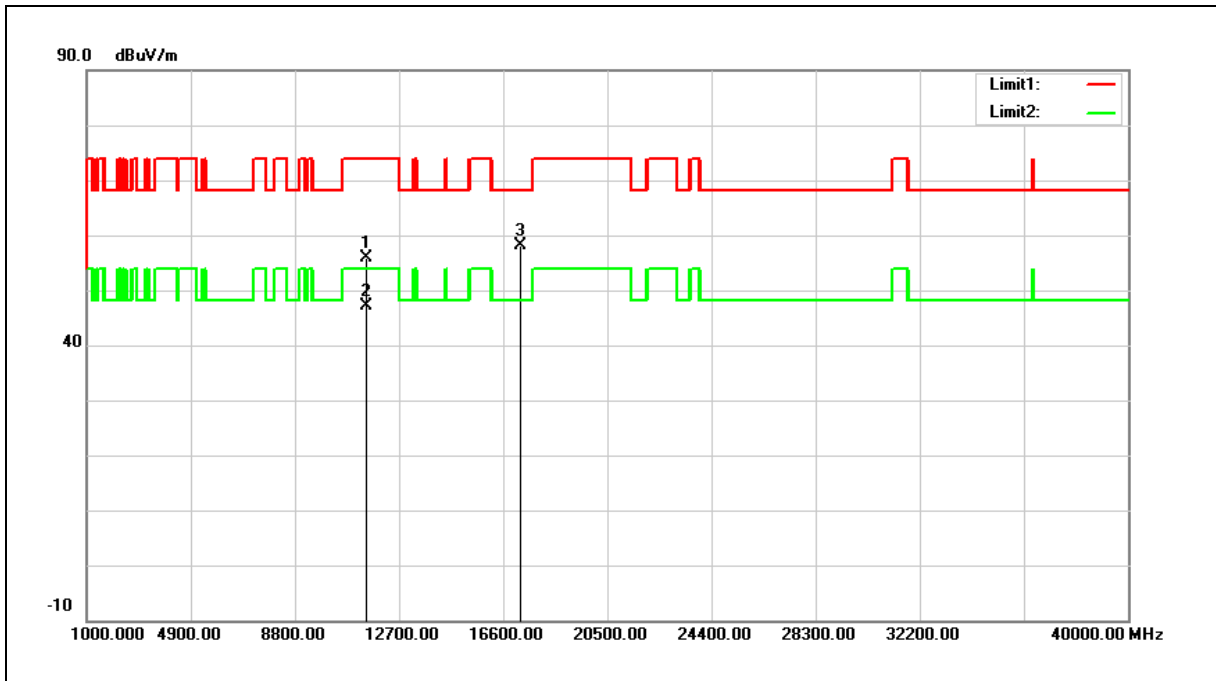

No.	Frequency (MHz)	Reading (dBuV)	Correct Factor (dB/m)	Result (dBuV/m)	Limit (dBuV/m)	Margin (dB)	Remark
1	11490.000	40.58	15.39	55.97	74.00	-18.03	peak
2	11490.000	31.78	15.39	47.17	54.00	-6.83	AVG
3	17235.000	36.32	21.71	58.03	68.20	-10.17	peak

Note:1.Result (dBuV/m) = Correct Factor (dB/m) + Reading(dBuV).

2.Correction factor (dB/m) = Antenna Factor (dB/m) + Cable loss (dB) – Pre-Amplifier gain (dB).

3.When the peak results are less than average limit, so not need to evaluate the average.

Standard:	FCC Part 15.407	Test Distance:	3 m
Test item:	Harmonic		
Frequency:	5785 MHz		
Mode:	Mode 8		
Ant.Polar.:	Horizontal		

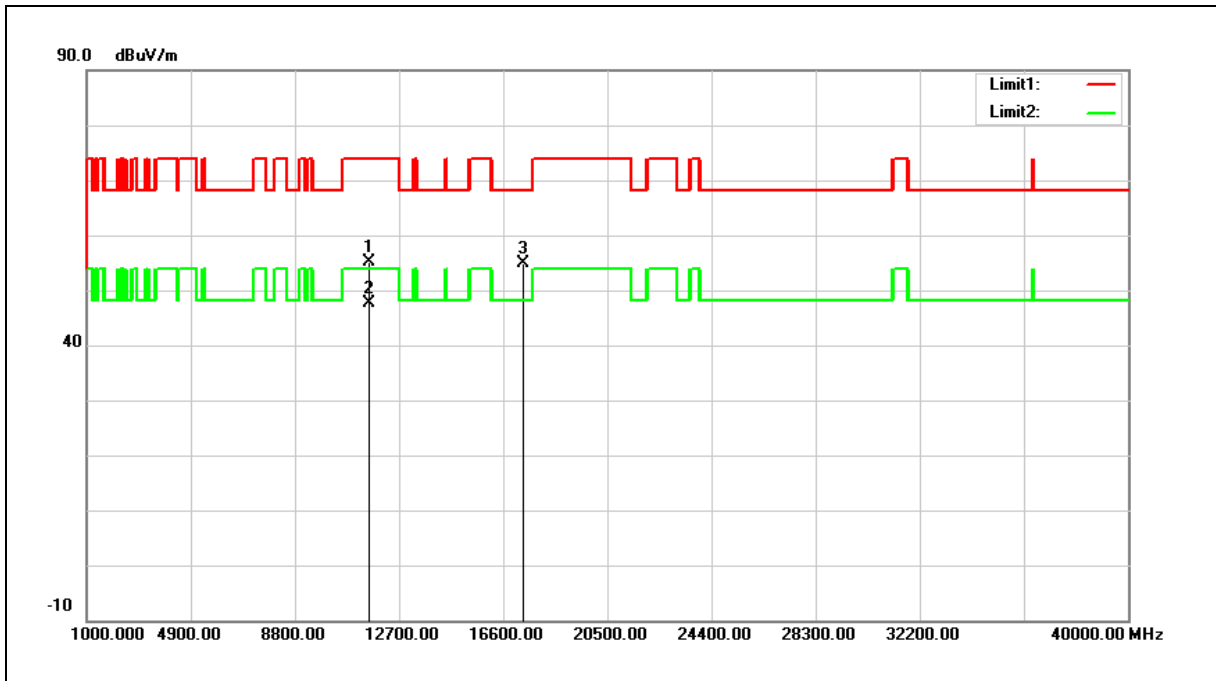

No.	Frequency (MHz)	Reading (dBuV)	Correct Factor (dB/m)	Result (dBuV/m)	Limit (dBuV/m)	Margin (dB)	Remark
1	11570.000	39.87	15.25	55.12	74.00	-18.88	peak
2	11570.000	32.48	15.25	47.73	54.00	-6.27	AVG
3	17355.000	32.35	22.42	54.77	68.20	-13.43	peak

Note:1.Result (dBuV/m) = Correct Factor (dB/m) + Reading(dBuV).

2.Correction factor (dB/m) = Antenna Factor (dB/m) + Cable loss (dB) – Pre-Amplifier gain (dB).

3.When the peak results are less than average limit, so not need to evaluate the average.

Standard:	FCC Part 15.407	Test Distance:	3 m
Test item:	Harmonic		
Frequency:	5785 MHz		
Mode:	Mode 8		
Ant.Polar.:	Vertical		

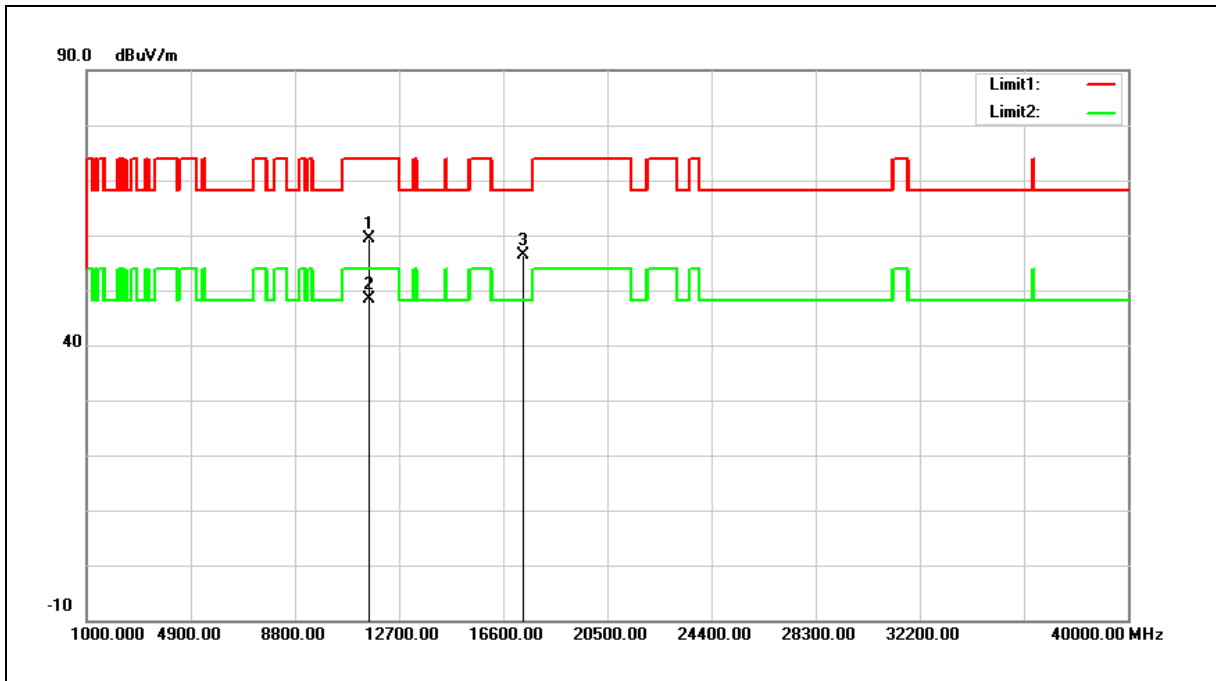

No.	Frequency (MHz)	Reading (dBuV)	Correct Factor (dB/m)	Result (dBuV/m)	Limit (dBuV/m)	Margin (dB)	Remark
1	11570.000	44.14	15.25	59.39	74.00	-14.61	peak
2	11570.000	33.15	15.25	48.40	54.00	-5.60	AVG
3	17355.000	33.87	22.42	56.29	68.20	-11.91	peak

Note:1.Result (dBuV/m) = Correct Factor (dB/m) + Reading(dBuV).

2.Correction factor (dB/m) = Antenna Factor (dB/m) + Cable loss (dB) – Pre-Amplifier gain (dB).

3.When the peak results are less than average limit, so not need to evaluate the average.

Standard:	FCC Part 15.407	Test Distance:	3 m
Test item:	Harmonic		
Frequency:	5825 MHz		
Mode:	Mode 8		
Ant.Polar.:	Horizontal		

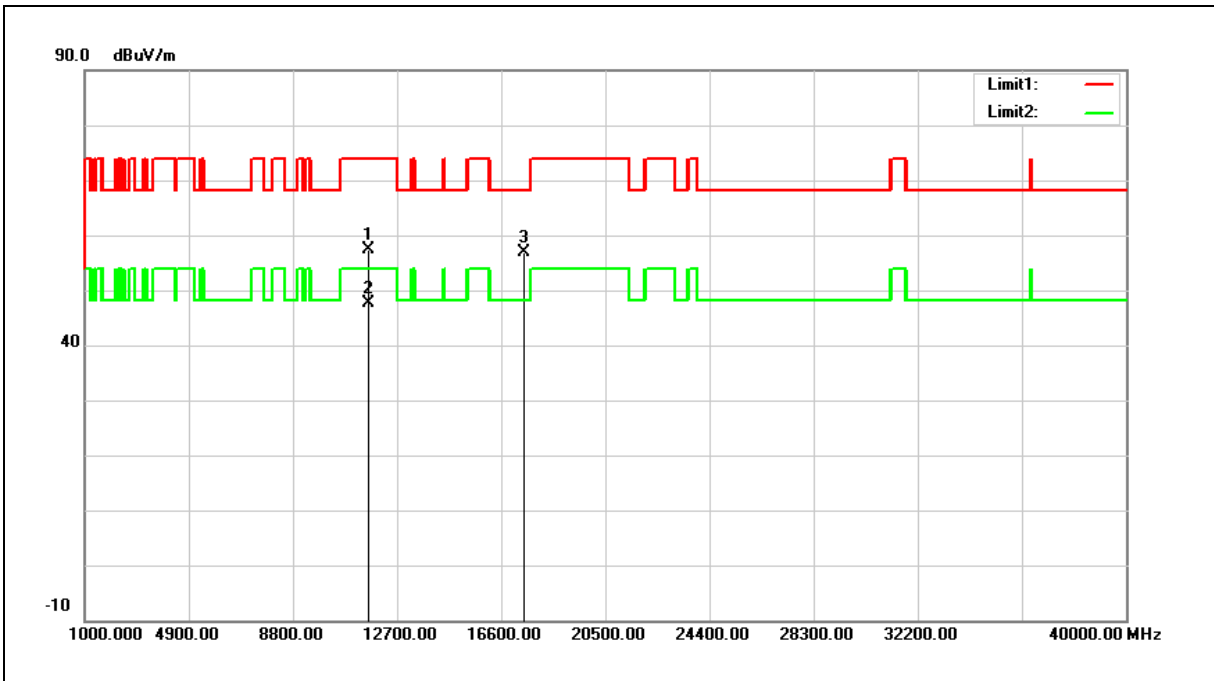

No.	Frequency (MHz)	Reading (dBuV)	Correct Factor (dB/m)	Result (dBuV/m)	Limit (dBuV/m)	Margin (dB)	Remark
1	11650.000	42.40	15.08	57.48	74.00	-16.52	peak
2	11650.000	32.57	15.08	47.65	54.00	-6.35	AVG
3	17475.000	33.75	23.13	56.88	68.20	-11.32	peak

Note:1.Result (dBuV/m) = Correct Factor (dB/m) + Reading(dBuV).

2.Correction factor (dB/m) = Antenna Factor (dB/m) + Cable loss (dB) – Pre-Amplifier gain (dB).

3.When the peak results are less than average limit, so not need to evaluate the average.

Standard:	FCC Part 15.407	Test Distance:	3 m
Test item:	Harmonic		
Frequency:	5825 MHz		
Mode:	Mode 8		
Ant.Polar.:	Vertical		

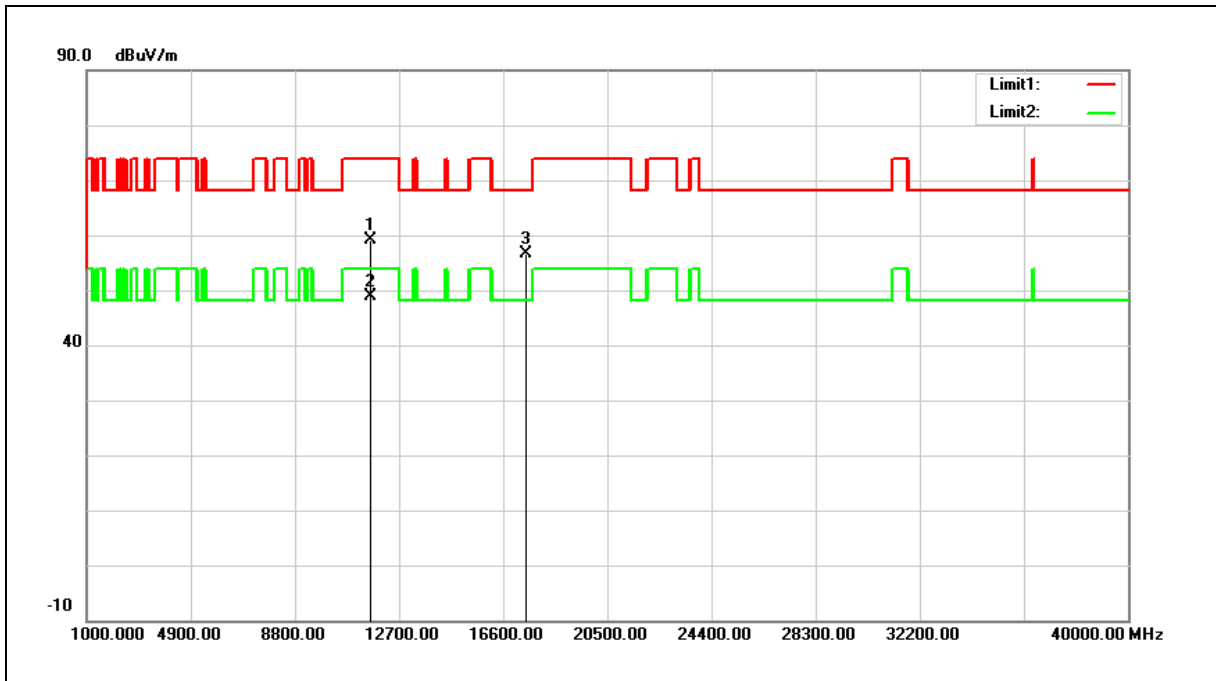

No.	Frequency (MHz)	Reading (dBuV)	Correct Factor (dB/m)	Result (dBuV/m)	Limit (dBuV/m)	Margin (dB)	Remark
1	11650.000	44.17	15.08	59.25	74.00	-14.75	peak
2	11650.000	33.69	15.08	48.77	54.00	-5.23	AVG
3	17475.000	33.55	23.13	56.68	68.20	-11.52	peak

Note:1.Result (dBuV/m) = Correct Factor (dB/m) + Reading(dBuV).

2.Correction factor (dB/m) = Antenna Factor (dB/m) + Cable loss (dB) – Pre-Amplifier gain (dB).

3.When the peak results are less than average limit, so not need to evaluate the average.

Standard:	FCC Part 15.407	Test Distance:	3 m
Test item:	Harmonic		
Frequency:	5190 MHz		
Mode:	Mode 9		
Ant.Polar.:	Horizontal		

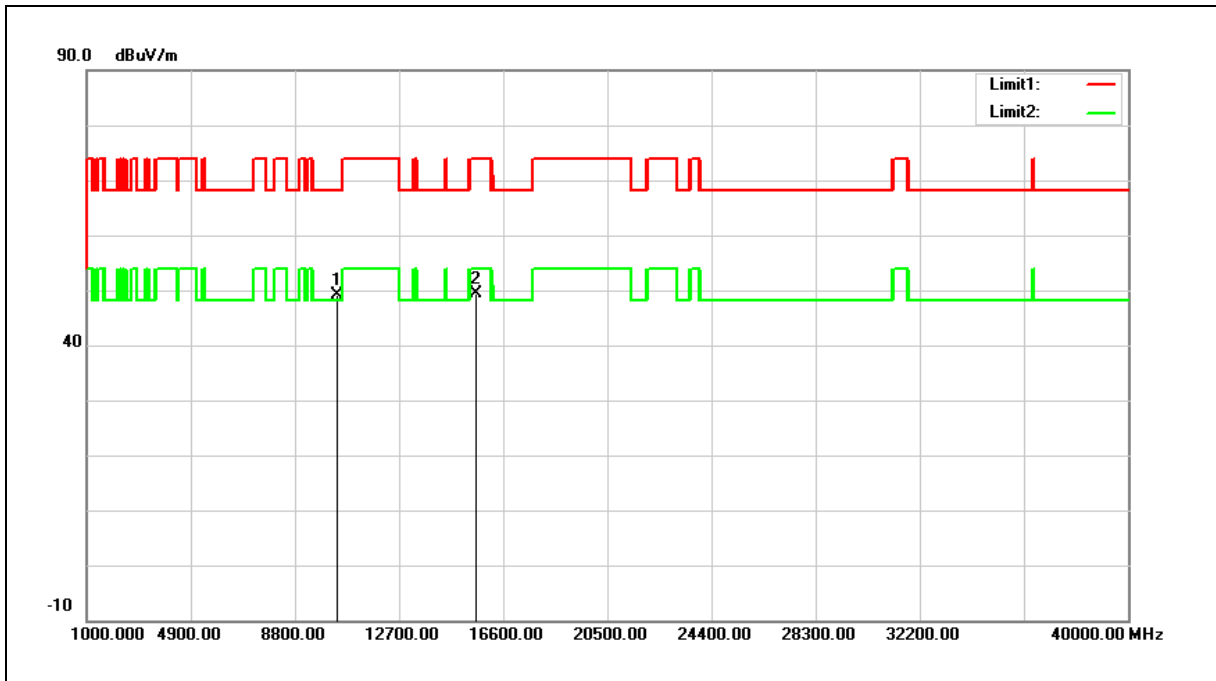

No.	Frequency (MHz)	Reading (dBuV)	Correct Factor (dB/m)	Result (dBuV/m)	Limit (dBuV/m)	Margin (dB)	Remark
1	10380.000	34.77	14.35	49.12	68.20	-19.08	peak
2	15570.000	32.65	16.75	49.40	74.00	-24.60	peak

Note:1.Result (dBuV/m) = Correct Factor (dB/m) + Reading(dBuV).

2.Correction factor (dB/m) = Antenna Factor (dB/m) + Cable loss (dB) – Pre-Amplifier gain (dB).

3.When the peak results are less than average limit, so not need to evaluate the average.

Standard:	FCC Part 15.407	Test Distance:	3 m
Test item:	Harmonic		
Frequency:	5190 MHz		
Mode:	Mode 9		
Ant.Polar.:	Vertical		

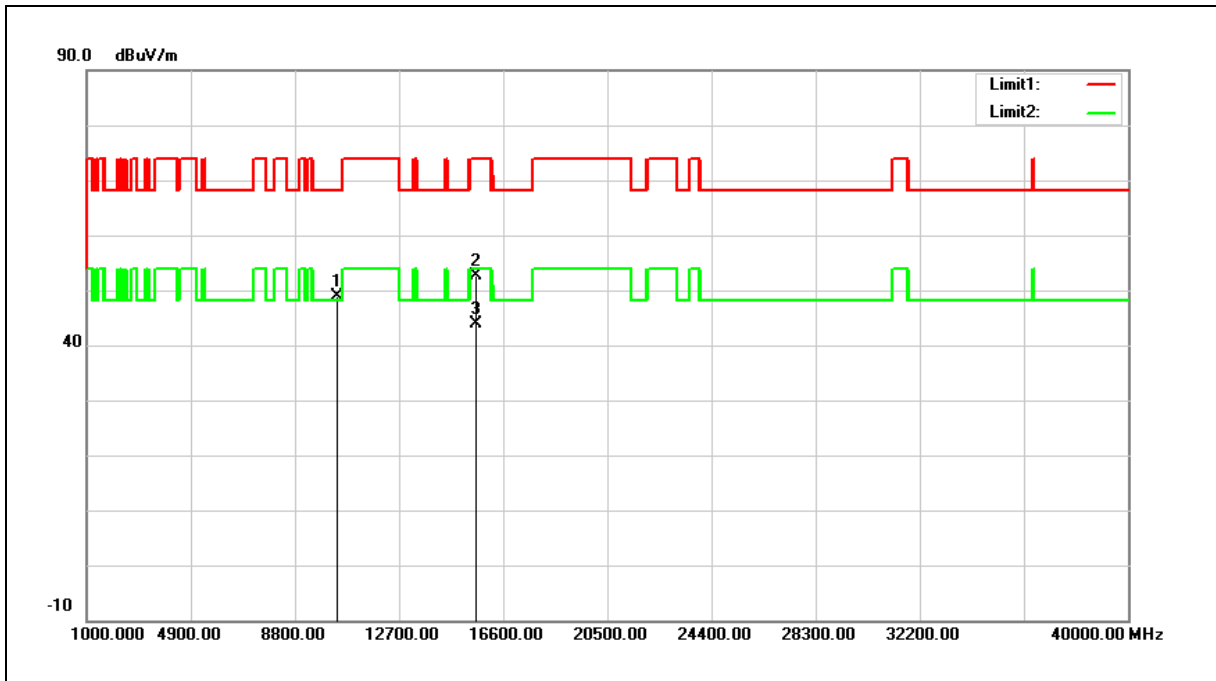

No.	Frequency (MHz)	Reading (dBuV)	Correct Factor (dB/m)	Result (dBuV/m)	Limit (dBuV/m)	Margin (dB)	Remark
1	10380.000	34.52	14.35	48.87	68.20	-19.33	peak
2	15570.000	35.90	16.75	52.65	74.00	-21.35	peak
3	15570.000	27.21	16.75	43.96	54.00	-10.04	AVG

Note:1.Result (dBuV/m) = Correct Factor (dB/m) + Reading(dBuV).

2.Correction factor (dB/m) = Antenna Factor (dB/m) + Cable loss (dB) – Pre-Amplifier gain (dB).

3.When the peak results are less than average limit, so not need to evaluate the average.

Standard:	FCC Part 15.407	Test Distance:	3 m
Test item:	Harmonic		
Frequency:	5230 MHz		
Mode:	Mode 9		
Ant.Polar.:	Horizontal		

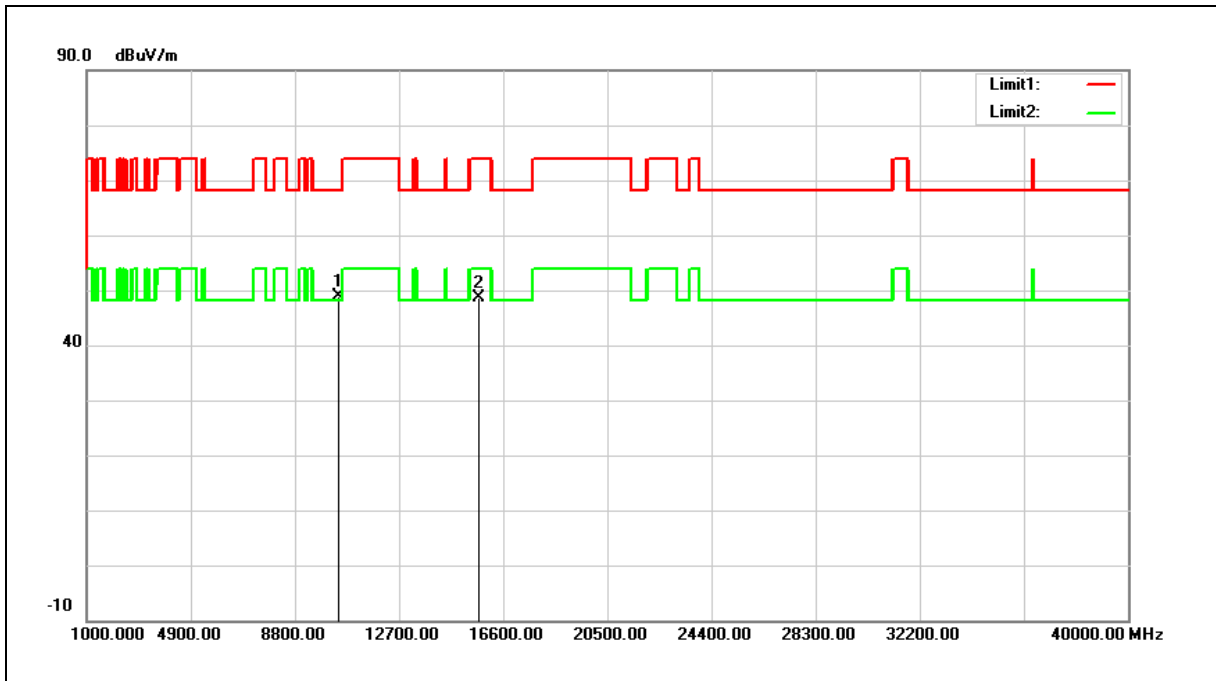

No.	Frequency (MHz)	Reading (dBuV)	Correct Factor (dB/m)	Result (dBuV/m)	Limit (dBuV/m)	Margin (dB)	Remark
1	10460.000	34.33	14.51	48.84	68.20	-19.36	peak
2	15690.000	32.23	16.35	48.58	74.00	-25.42	peak

Note:1.Result (dBuV/m) = Correct Factor (dB/m) + Reading(dBuV).

2.Correction factor (dB/m) = Antenna Factor (dB/m) + Cable loss (dB) – Pre-Amplifier gain (dB).

3.When the peak results are less than average limit, so not need to evaluate the average.

Standard:	FCC Part 15.407	Test Distance:	3 m
Test item:	Harmonic		
Frequency:	5230 MHz		
Mode:	Mode 9		
Ant.Polar.:	Vertical		

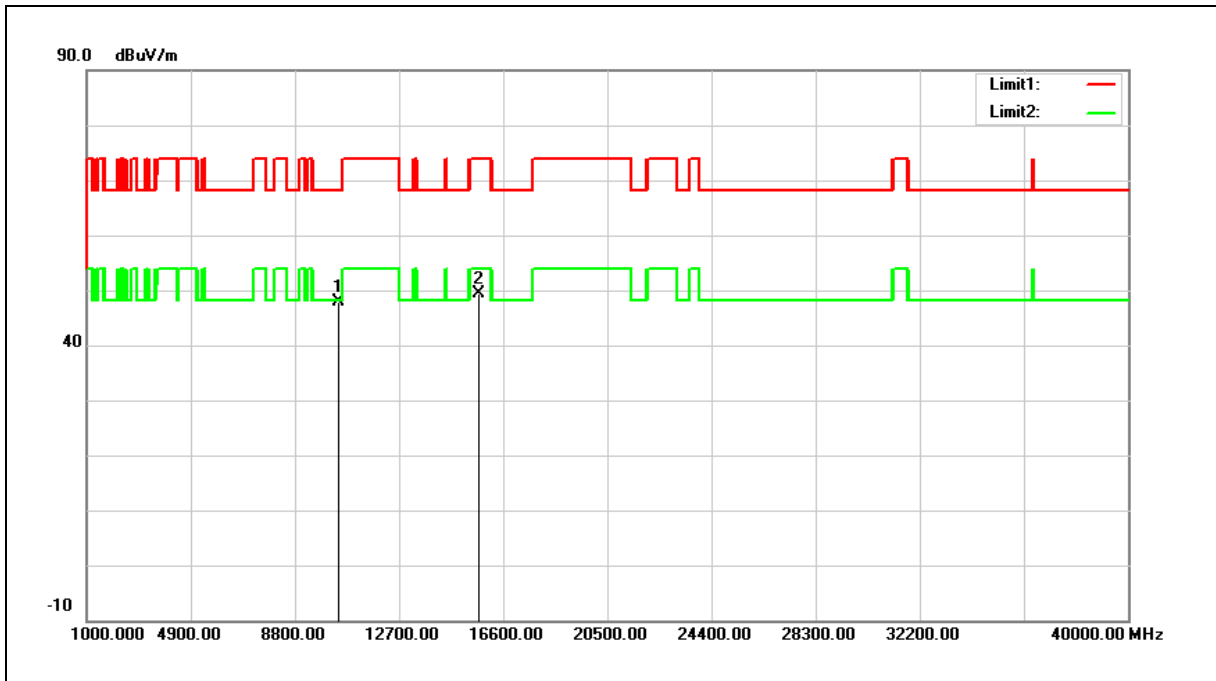

No.	Frequency (MHz)	Reading (dBuV)	Correct Factor (dB/m)	Result (dBuV/m)	Limit (dBuV/m)	Margin (dB)	Remark
1	10460.000	33.47	14.51	47.98	68.20	-20.22	peak
2	15690.000	32.95	16.35	49.30	74.00	-24.70	peak

Note:1.Result (dBuV/m) = Correct Factor (dB/m) + Reading(dBuV).

2.Correction factor (dB/m) = Antenna Factor (dB/m) + Cable loss (dB) – Pre-Amplifier gain (dB).

3.When the peak results are less than average limit, so not need to evaluate the average.

Standard:	FCC Part 15.407	Test Distance:	3 m
Test item:	Harmonic		
Frequency:	5270 MHz		
Mode:	Mode 9		
Ant.Polar.:	Horizontal		

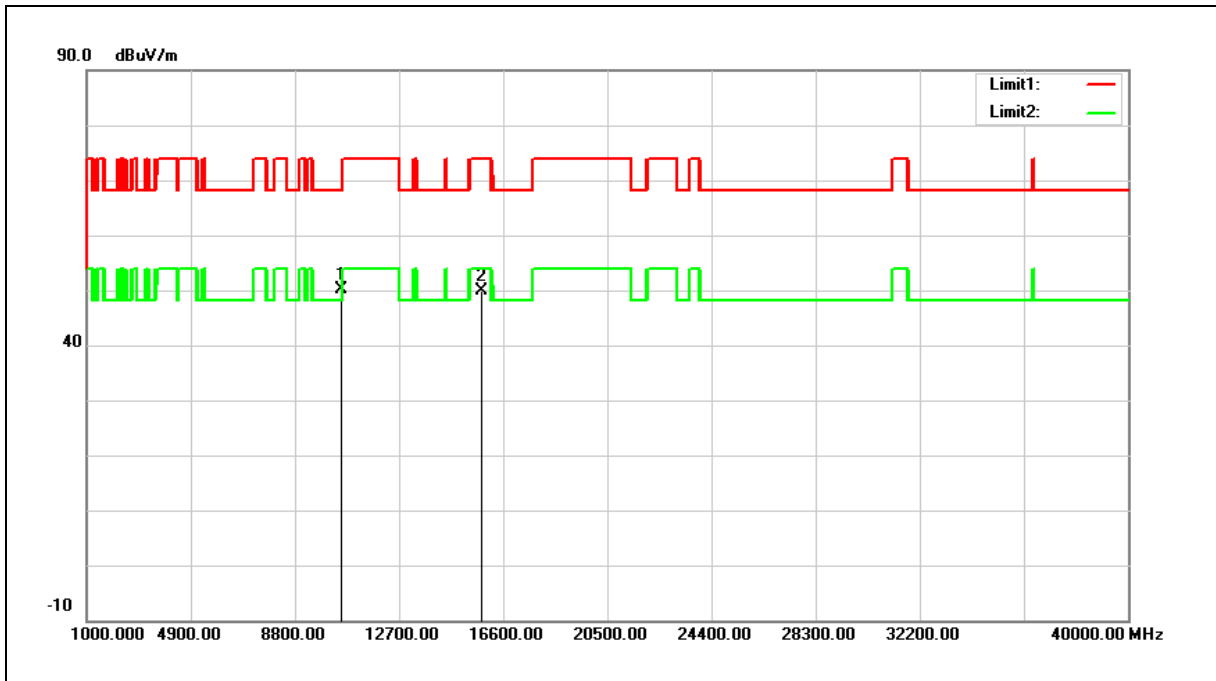

No.	Frequency (MHz)	Reading (dBuV)	Correct Factor (dB/m)	Result (dBuV/m)	Limit (dBuV/m)	Margin (dB)	Remark
1	10540.000	35.61	14.58	50.19	68.20	-18.01	peak
2	15810.000	33.99	15.95	49.94	74.00	-24.06	peak

Note:1.Result (dBuV/m) = Correct Factor (dB/m) + Reading(dBuV).

2.Correction factor (dB/m) = Antenna Factor (dB/m) + Cable loss (dB) – Pre-Amplifier gain (dB).

3.When the peak results are less than average limit, so not need to evaluate the average.

Standard:	FCC Part 15.407	Test Distance:	3 m
Test item:	Harmonic		
Frequency:	5270 MHz		
Mode:	Mode 9		
Ant.Polar.:	Vertical		

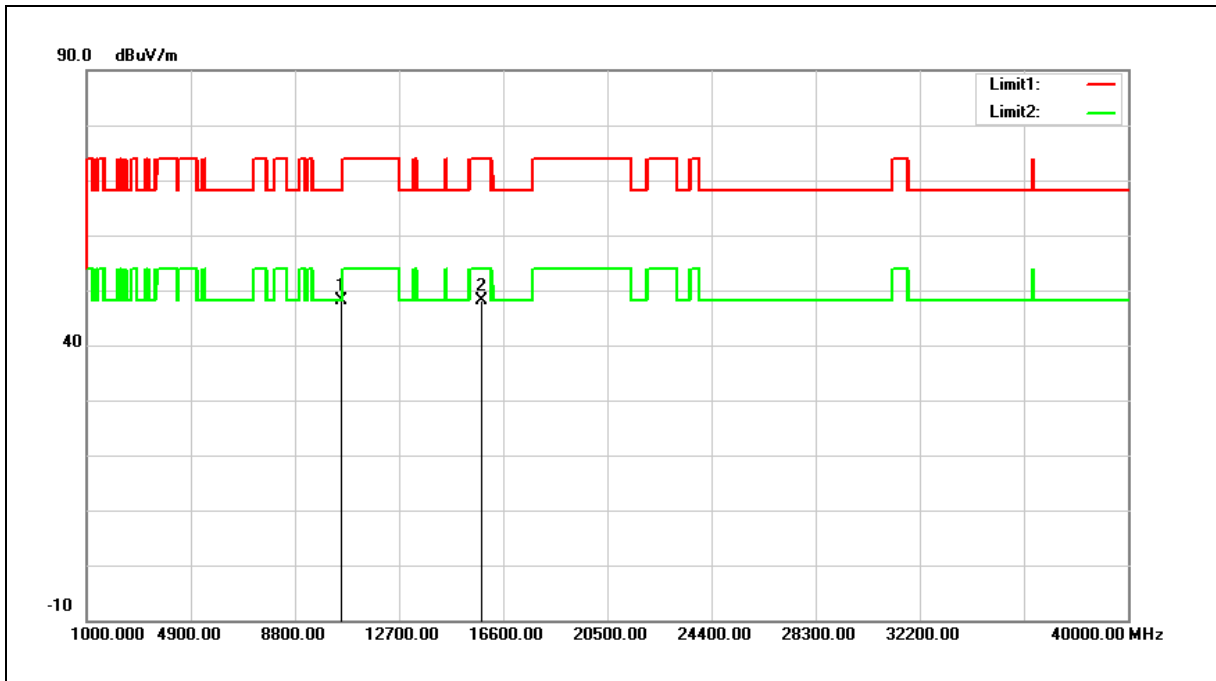

No.	Frequency (MHz)	Reading (dBuV)	Correct Factor (dB/m)	Result (dBuV/m)	Limit (dBuV/m)	Margin (dB)	Remark
1	10540.000	33.49	14.58	48.07	68.20	-20.13	peak
2	15810.000	32.25	15.95	48.20	74.00	-25.80	peak

Note:1.Result (dBuV/m) = Correct Factor (dB/m) + Reading(dBuV).

2.Correction factor (dB/m) = Antenna Factor (dB/m) + Cable loss (dB) – Pre-Amplifier gain (dB).

3.When the peak results are less than average limit, so not need to evaluate the average.

Standard:	FCC Part 15.407	Test Distance:	3 m
Test item:	Harmonic		
Frequency:	5310 MHz		
Mode:	Mode 9		
Ant.Polar.:	Horizontal		

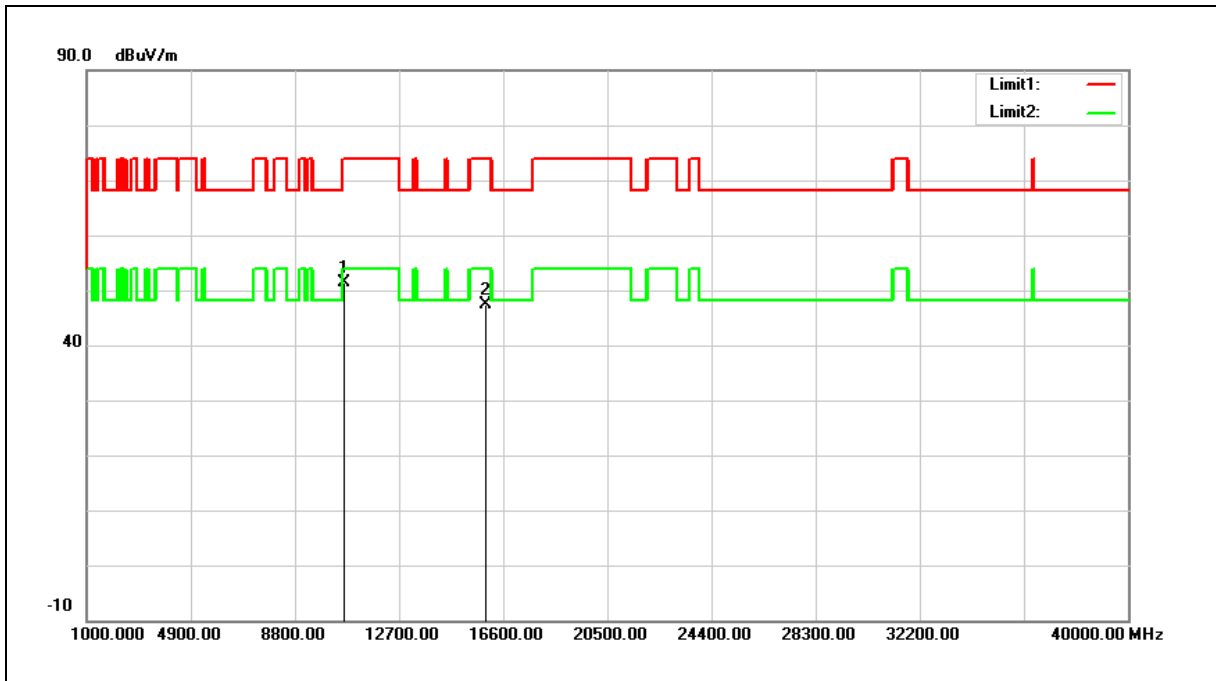

No.	Frequency (MHz)	Reading (dBuV)	Correct Factor (dB/m)	Result (dBuV/m)	Limit (dBuV/m)	Margin (dB)	Remark
1	10620.000	36.90	14.56	51.46	74.00	-22.54	peak
2	15930.000	31.80	15.55	47.35	74.00	-26.65	peak

Note:1.Result (dBuV/m) = Correct Factor (dB/m) + Reading(dBuV).

2.Correction factor (dB/m) = Antenna Factor (dB/m) + Cable loss (dB) – Pre-Amplifier gain (dB).

3.When the peak results are less than average limit, so not need to evaluate the average.

Standard:	FCC Part 15.407	Test Distance:	3 m
Test item:	Harmonic		
Frequency:	5310 MHz		
Mode:	Mode 9		
Ant.Polar.:	Vertical		

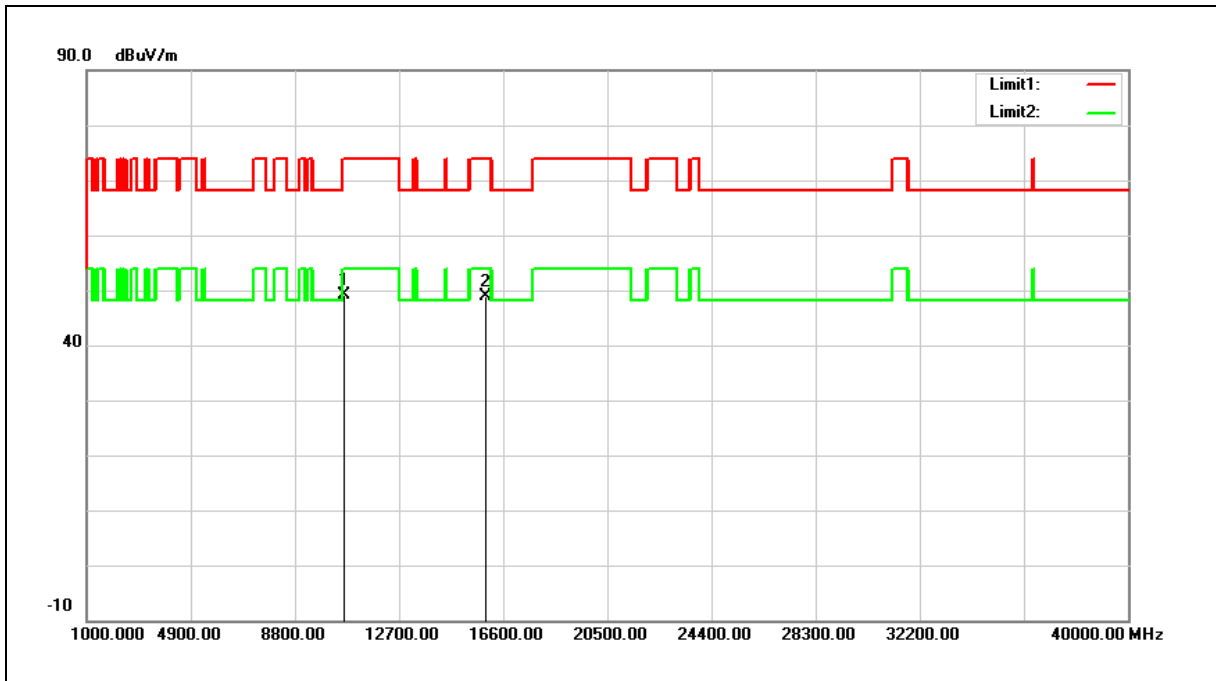

No.	Frequency (MHz)	Reading (dBuV)	Correct Factor (dB/m)	Result (dBuV/m)	Limit (dBuV/m)	Margin (dB)	Remark
1	10620.000	34.51	14.56	49.07	74.00	-24.93	peak
2	15930.000	33.29	15.55	48.84	74.00	-25.16	peak

Note:1.Result (dBuV/m) = Correct Factor (dB/m) + Reading(dBuV).

2.Correction factor (dB/m) = Antenna Factor (dB/m) + Cable loss (dB) – Pre-Amplifier gain (dB).

3.When the peak results are less than average limit, so not need to evaluate the average.

Standard:	FCC Part 15.407	Test Distance:	3 m
Test item:	Harmonic		
Frequency:	5510 MHz		
Mode:	Mode 9		
Ant.Polar.:	Horizontal		

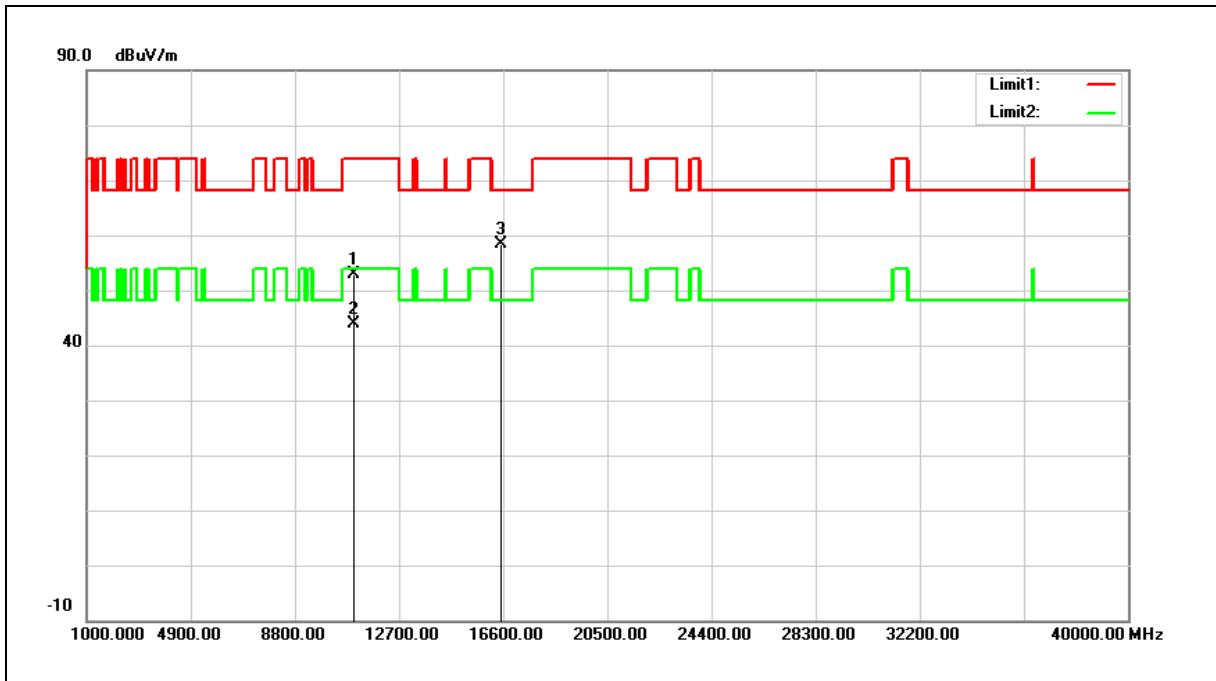

No.	Frequency (MHz)	Reading (dBuV)	Correct Factor (dB/m)	Result (dBuV/m)	Limit (dBuV/m)	Margin (dB)	Remark
1	11020.000	38.31	14.51	52.82	74.00	-21.18	peak
2	11020.000	29.48	14.51	43.99	54.00	-10.01	AVG
3	16530.000	41.57	16.85	58.42	68.20	-9.78	peak

Note:1.Result (dBuV/m) = Correct Factor (dB/m) + Reading(dBuV).

2.Correction factor (dB/m) = Antenna Factor (dB/m) + Cable loss (dB) – Pre-Amplifier gain (dB).

3.When the peak results are less than average limit, so not need to evaluate the average.

Standard:	FCC Part 15.407	Test Distance:	3 m
Test item:	Harmonic		
Frequency:	5510 MHz		
Mode:	Mode 9		
Ant.Polar.:	Vertical		

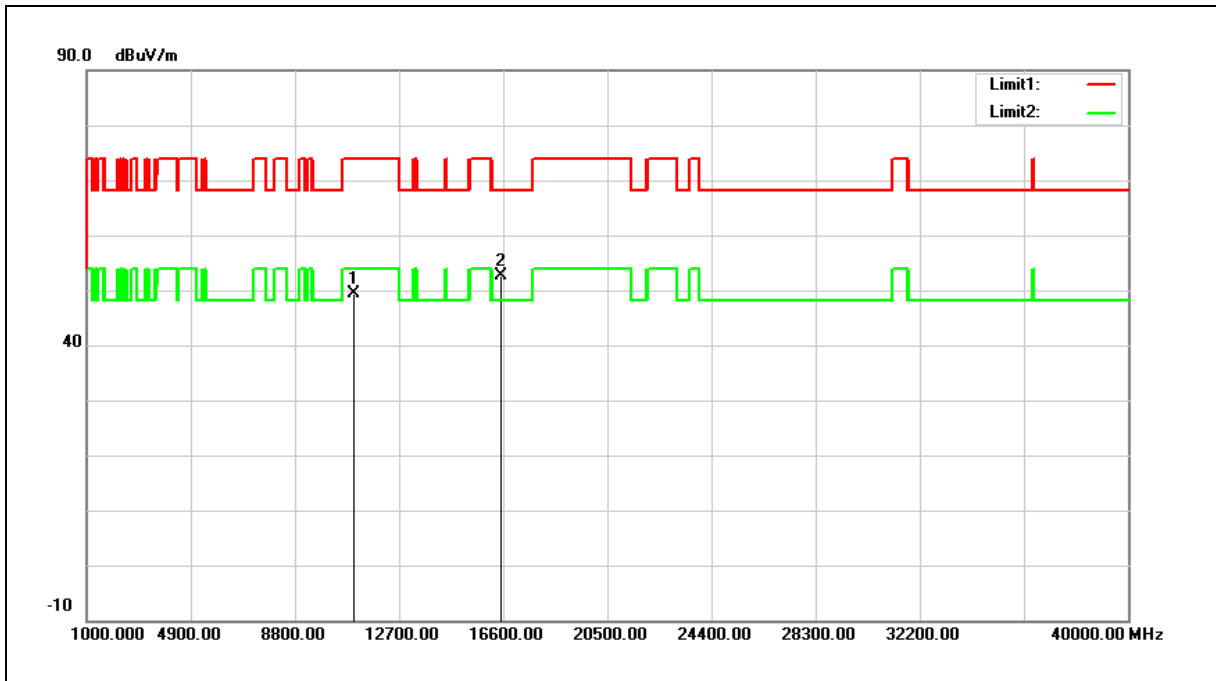

No.	Frequency (MHz)	Reading (dBuV)	Correct Factor (dB/m)	Result (dBuV/m)	Limit (dBuV/m)	Margin (dB)	Remark
1	11020.000	34.80	14.51	49.31	74.00	-24.69	peak
2	16530.000	35.86	16.85	52.71	68.20	-15.49	peak

Note:1.Result (dBuV/m) = Correct Factor (dB/m) + Reading(dBuV).

2.Correction factor (dB/m) = Antenna Factor (dB/m) + Cable loss (dB) – Pre-Amplifier gain (dB).

3.When the peak results are less than average limit, so not need to evaluate the average.

Standard:	FCC Part 15.407	Test Distance:	3 m
Test item:	Harmonic		
Frequency:	5550 MHz		
Mode:	Mode 9		
Ant.Polar.:	Horizontal		

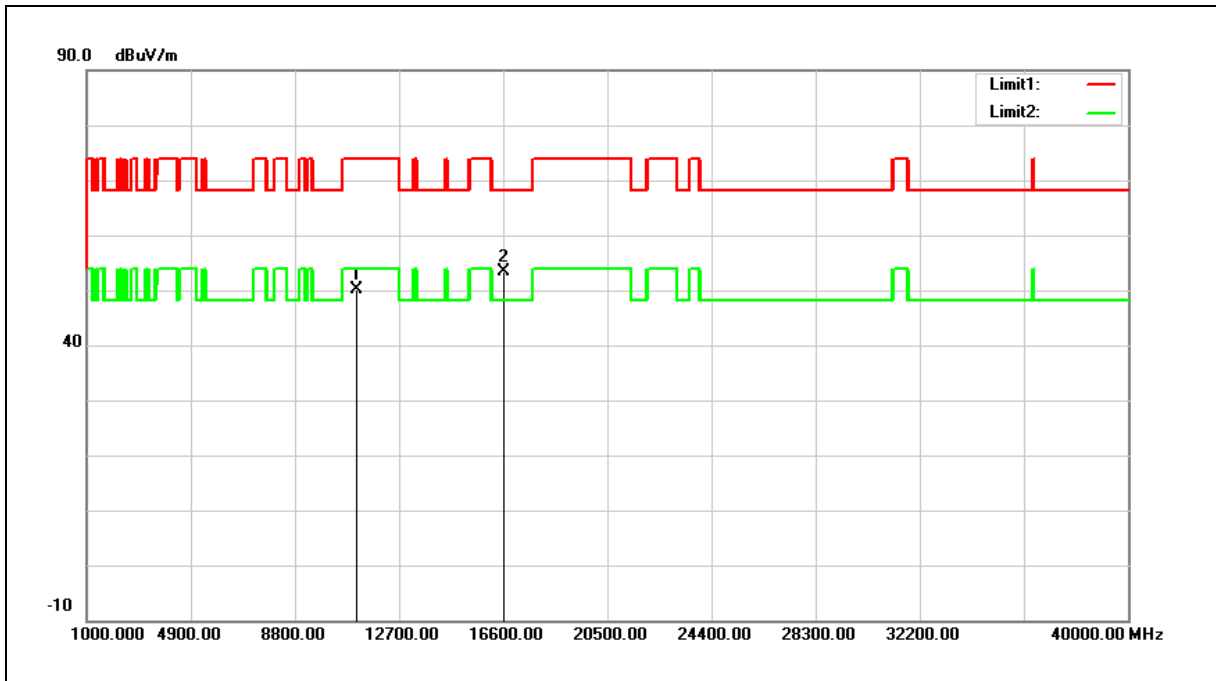

No.	Frequency (MHz)	Reading (dBuV)	Correct Factor (dB/m)	Result (dBuV/m)	Limit (dBuV/m)	Margin (dB)	Remark
1	11100.000	35.35	14.66	50.01	74.00	-23.99	peak
2	16650.000	35.72	17.73	53.45	68.20	-14.75	peak

Note:1.Result (dBuV/m) = Correct Factor (dB/m) + Reading(dBuV).

2.Correction factor (dB/m) = Antenna Factor (dB/m) + Cable loss (dB) – Pre-Amplifier gain (dB).

3.When the peak results are less than average limit, so not need to evaluate the average.

Standard:	FCC Part 15.407	Test Distance:	3 m
Test item:	Harmonic		
Frequency:	5550 MHz		
Mode:	Mode 9		
Ant.Polar.:	Vertical		

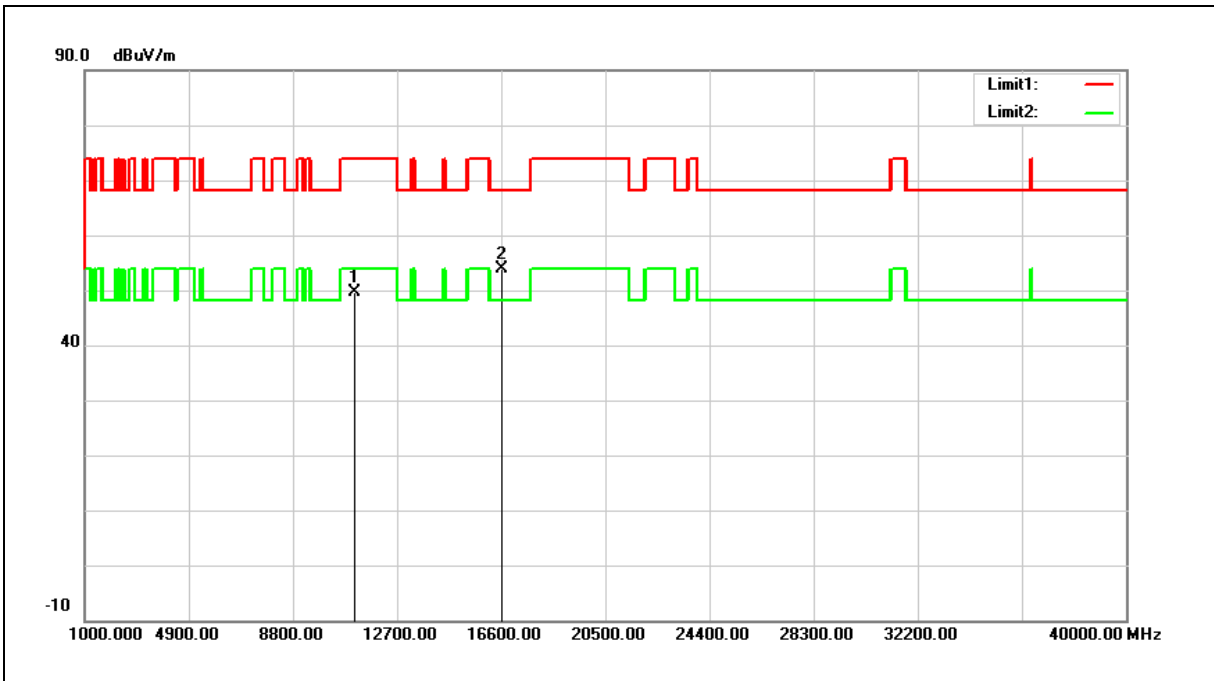

No.	Frequency (MHz)	Reading (dBuV)	Correct Factor (dB/m)	Result (dBuV/m)	Limit (dBuV/m)	Margin (dB)	Remark
1	11100.000	34.87	14.66	49.53	74.00	-24.47	peak
2	16650.000	36.11	17.73	53.84	68.20	-14.36	peak

Note:1.Result (dBuV/m) = Correct Factor (dB/m) + Reading(dBuV).

2.Correction factor (dB/m) = Antenna Factor (dB/m) + Cable loss (dB) – Pre-Amplifier gain (dB).

3.When the peak results are less than average limit, so not need to evaluate the average.

Standard:	FCC Part 15.407	Test Distance:	3 m
Test item:	Harmonic		
Frequency:	5670 MHz		
Mode:	Mode 9		
Ant.Polar.:	Horizontal		

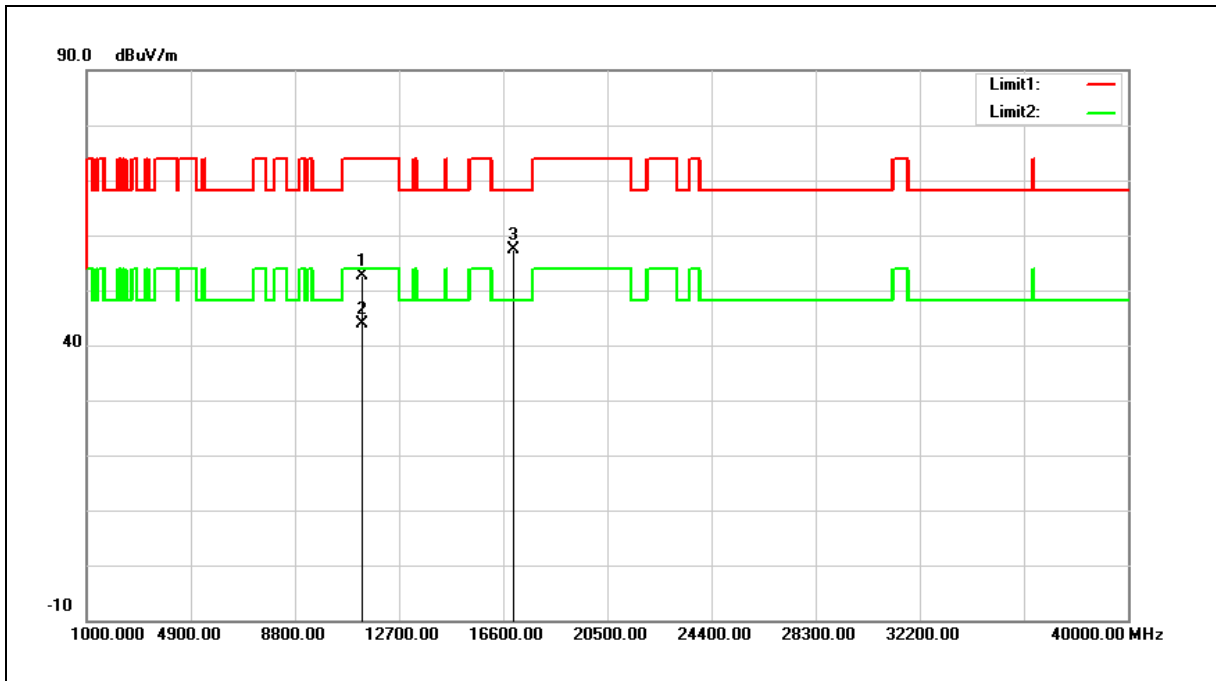

No.	Frequency (MHz)	Reading (dBuV)	Correct Factor (dB/m)	Result (dBuV/m)	Limit (dBuV/m)	Margin (dB)	Remark
1	11340.000	37.49	15.11	52.60	74.00	-21.40	peak
2	11340.000	28.68	15.11	43.79	54.00	-10.21	AVG
3	17010.000	37.02	20.36	57.38	68.20	-10.82	peak

Note:1.Result (dBuV/m) = Correct Factor (dB/m) + Reading(dBuV).

2.Correction factor (dB/m) = Antenna Factor (dB/m) + Cable loss (dB) – Pre-Amplifier gain (dB).

3.When the peak results are less than average limit, so not need to evaluate the average.

Standard:	FCC Part 15.407	Test Distance:	3 m
Test item:	Harmonic		
Frequency:	5670 MHz		
Mode:	Mode 9		
Ant.Polar.:	Vertical		

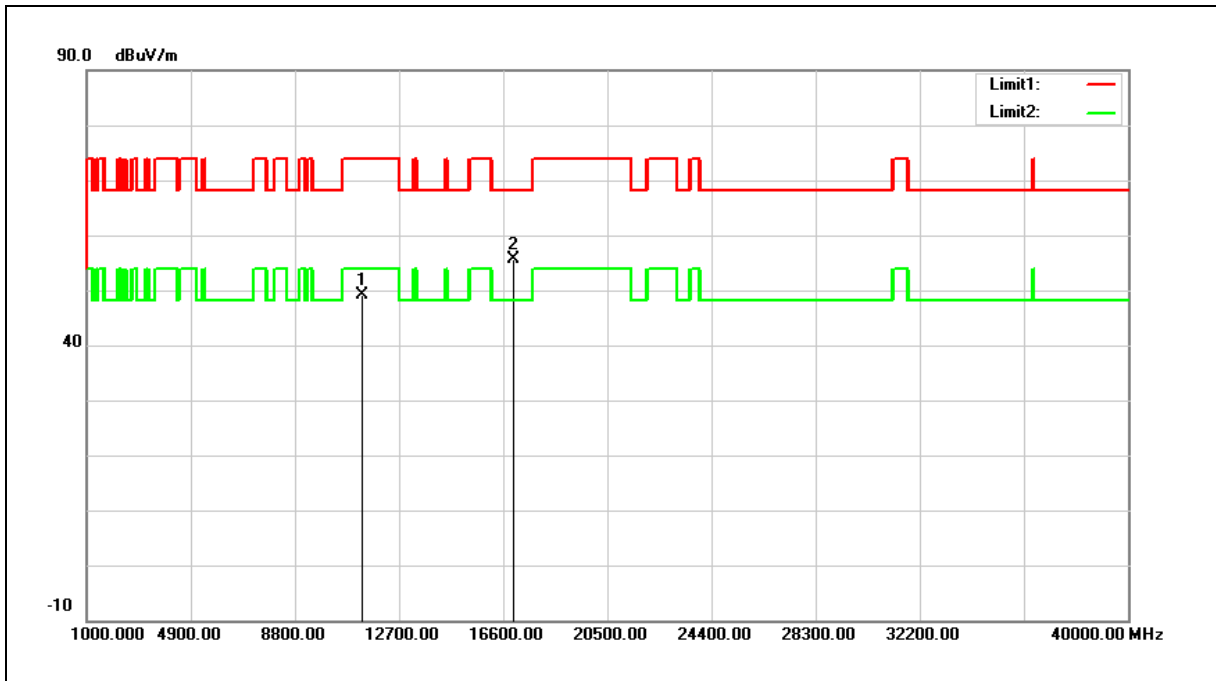

No.	Frequency (MHz)	Reading (dBuV)	Correct Factor (dB/m)	Result (dBuV/m)	Limit (dBuV/m)	Margin (dB)	Remark
1	11340.000	33.98	15.11	49.09	74.00	-24.91	peak
2	17010.000	35.18	20.36	55.54	68.20	-12.66	peak

Note:1.Result (dBuV/m) = Correct Factor (dB/m) + Reading(dBuV).

2.Correction factor (dB/m) = Antenna Factor (dB/m) + Cable loss (dB) – Pre-Amplifier gain (dB).

3.When the peak results are less than average limit, so not need to evaluate the average.

Standard:	FCC Part 15.407	Test Distance:	3 m
Test item:	Harmonic		
Frequency:	5755 MHz		
Mode:	Mode 9		
Ant.Polar.:	Horizontal		

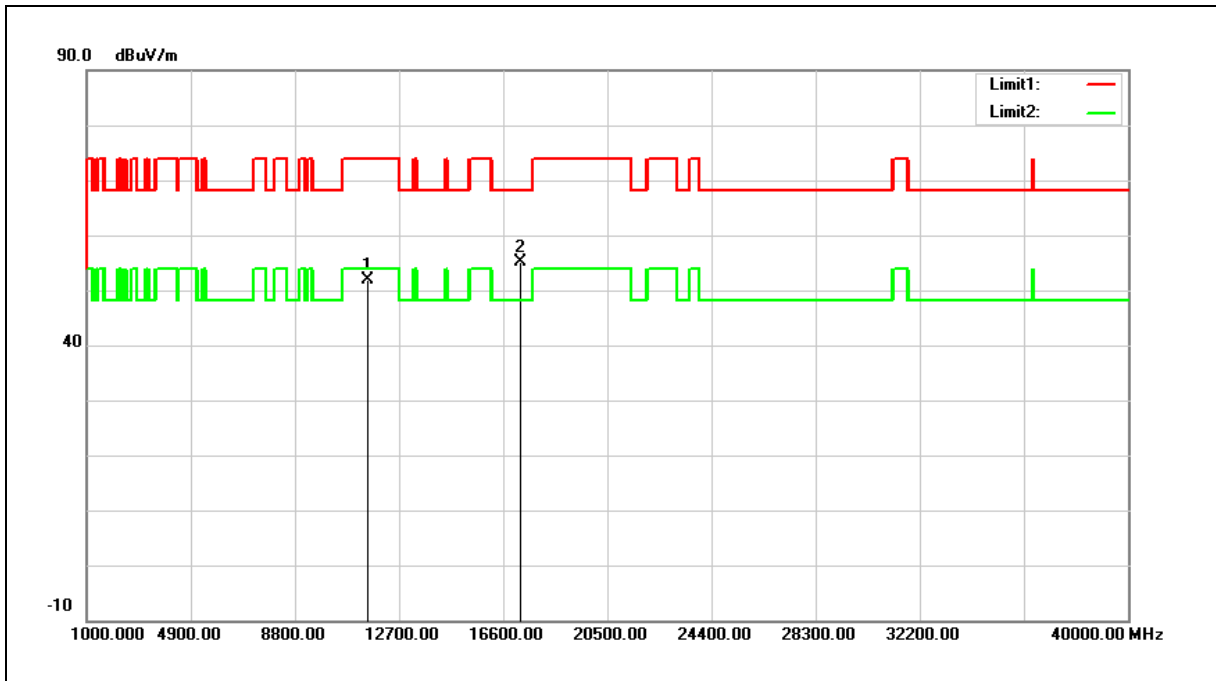

No.	Frequency (MHz)	Reading (dBuV)	Correct Factor (dB/m)	Result (dBuV/m)	Limit (dBuV/m)	Margin (dB)	Remark
1	11510.000	36.52	15.38	51.90	74.00	-22.10	peak
2	17265.000	33.13	21.88	55.01	68.20	-13.19	peak

Note:1.Result (dBuV/m) = Correct Factor (dB/m) + Reading(dBuV).

2.Correction factor (dB/m) = Antenna Factor (dB/m) + Cable loss (dB) – Pre-Amplifier gain (dB).

3.When the peak results are less than average limit, so not need to evaluate the average.

Standard:	FCC Part 15.407	Test Distance:	3 m
Test item:	Harmonic		
Frequency:	5755 MHz		
Mode:	Mode 9		
Ant.Polar.:	Vertical		

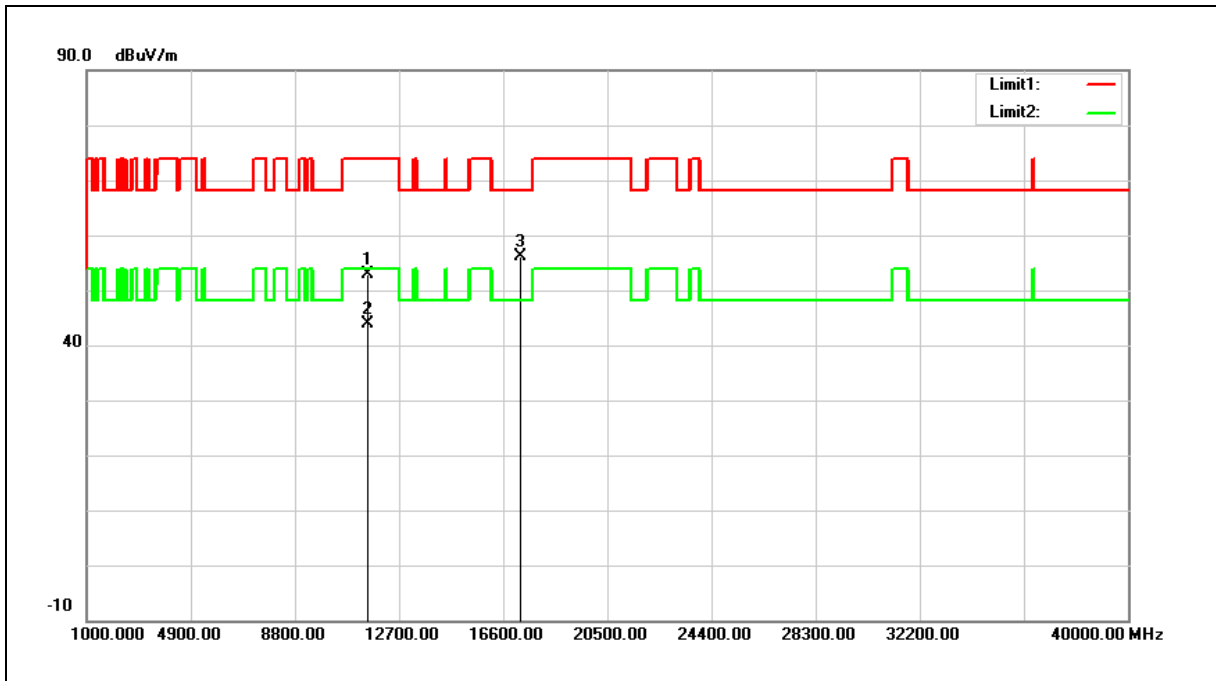

No.	Frequency (MHz)	Reading (dBuV)	Correct Factor (dB/m)	Result (dBuV/m)	Limit (dBuV/m)	Margin (dB)	Remark
1	11510.000	37.40	15.38	52.78	74.00	-21.22	peak
2	11510.000	28.47	15.38	43.85	54.00	-10.15	AVG
3	17265.000	34.28	21.88	56.16	68.20	-12.04	peak

Note:1.Result (dBuV/m) = Correct Factor (dB/m) + Reading(dBuV).

2.Correction factor (dB/m) = Antenna Factor (dB/m) + Cable loss (dB) – Pre-Amplifier gain (dB).

3.When the peak results are less than average limit, so not need to evaluate the average.

Standard:	FCC Part 15.407	Test Distance:	3 m
Test item:	Harmonic		
Frequency:	5795 MHz		
Mode:	Mode 9		
Ant.Polar.:	Horizontal		

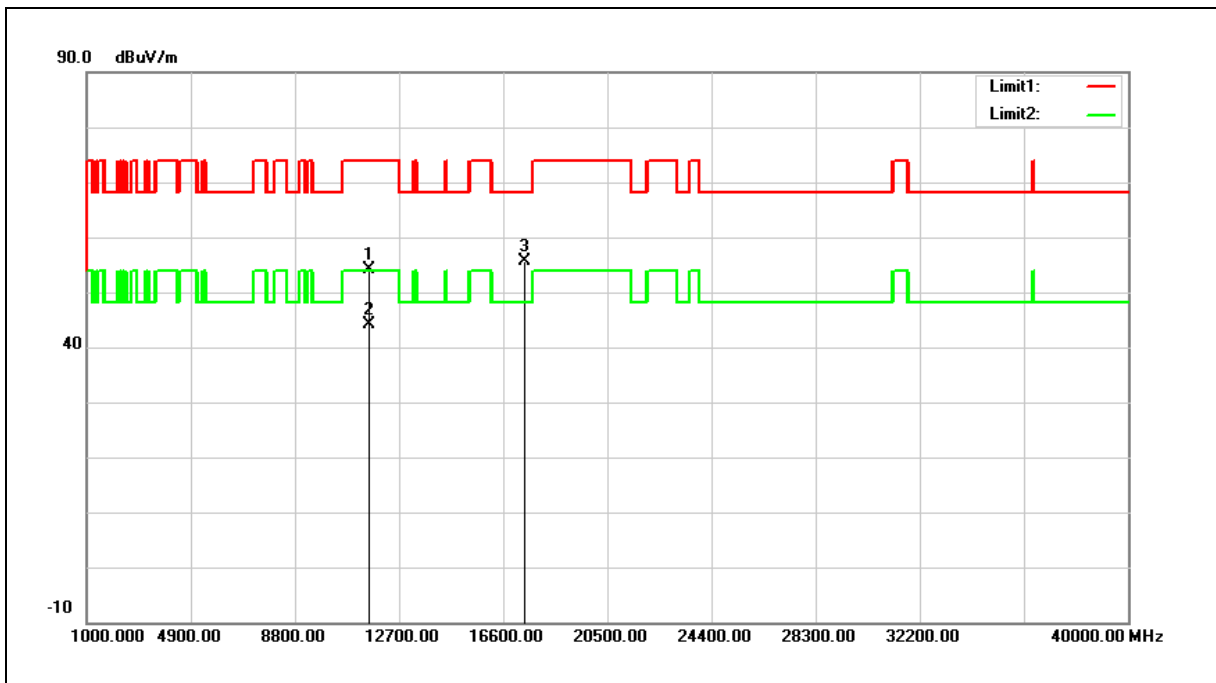

No.	Frequency (MHz)	Reading (dBuV)	Correct Factor (dB/m)	Result (dBuV/m)	Limit (dBuV/m)	Margin (dB)	Remark
1	11590.000	38.99	15.20	54.19	74.00	-19.81	peak
2	11590.000	29.01	15.20	44.21	54.00	-9.79	AVG
3	17385.000	32.93	22.60	55.53	68.20	-12.67	peak

Note:1.Result (dBuV/m) = Correct Factor (dB/m) + Reading(dBuV).

2.Correction factor (dB/m) = Antenna Factor (dB/m) + Cable loss (dB) – Pre-Amplifier gain (dB).

3.When the peak results are less than average limit, so not need to evaluate the average.

Standard:	FCC Part 15.407	Test Distance:	3 m
Test item:	Harmonic		
Frequency:	5795 MHz		
Mode:	Mode 9		
Ant.Polar.:	Vertical		

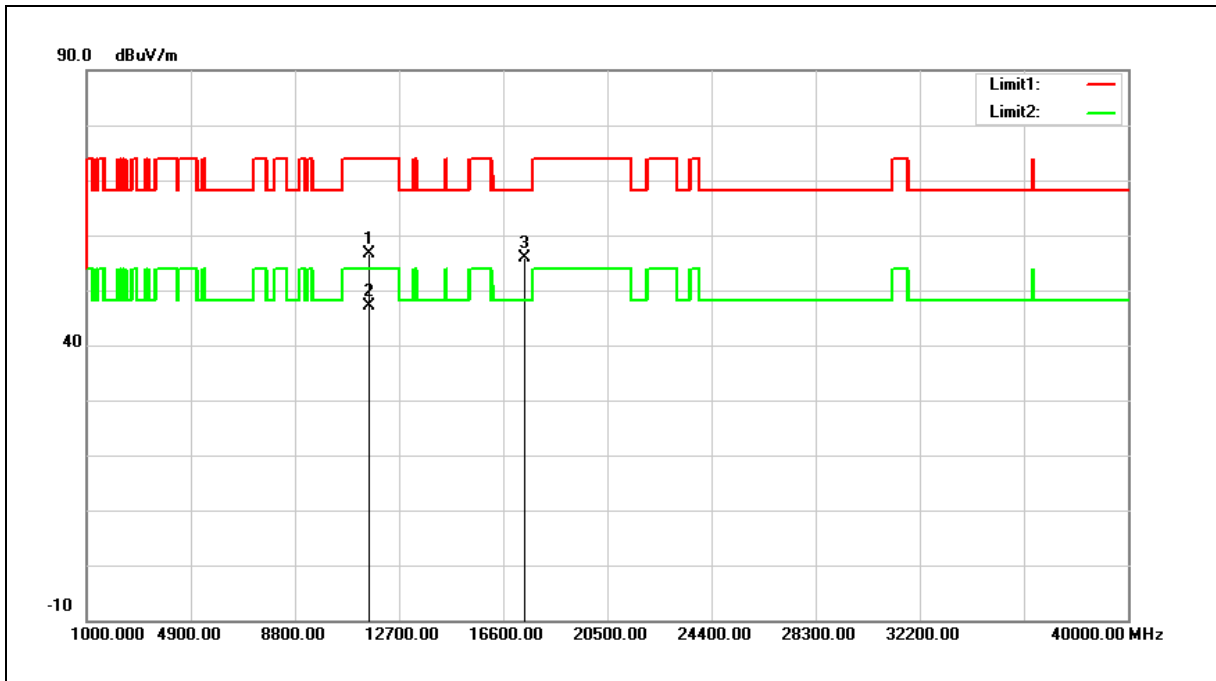

No.	Frequency (MHz)	Reading (dBuV)	Correct Factor (dB/m)	Result (dBuV/m)	Limit (dBuV/m)	Margin (dB)	Remark
1	11590.000	41.53	15.20	56.73	74.00	-17.27	peak
2	11590.000	31.88	15.20	47.08	54.00	-6.92	AVG
3	17385.000	33.37	22.60	55.97	68.20	-12.23	peak

Note:1.Result (dBuV/m) = Correct Factor (dB/m) + Reading(dBuV).

2.Correction factor (dB/m) = Antenna Factor (dB/m) + Cable loss (dB) – Pre-Amplifier gain (dB).

3.When the peak results are less than average limit, so not need to evaluate the average.

Standard:	FCC Part 15.407	Test Distance:	3 m
Test item:	Harmonic		
Frequency:	5210 MHz		
Mode:	Mode 10		
Ant.Polar.:	Horizontal		

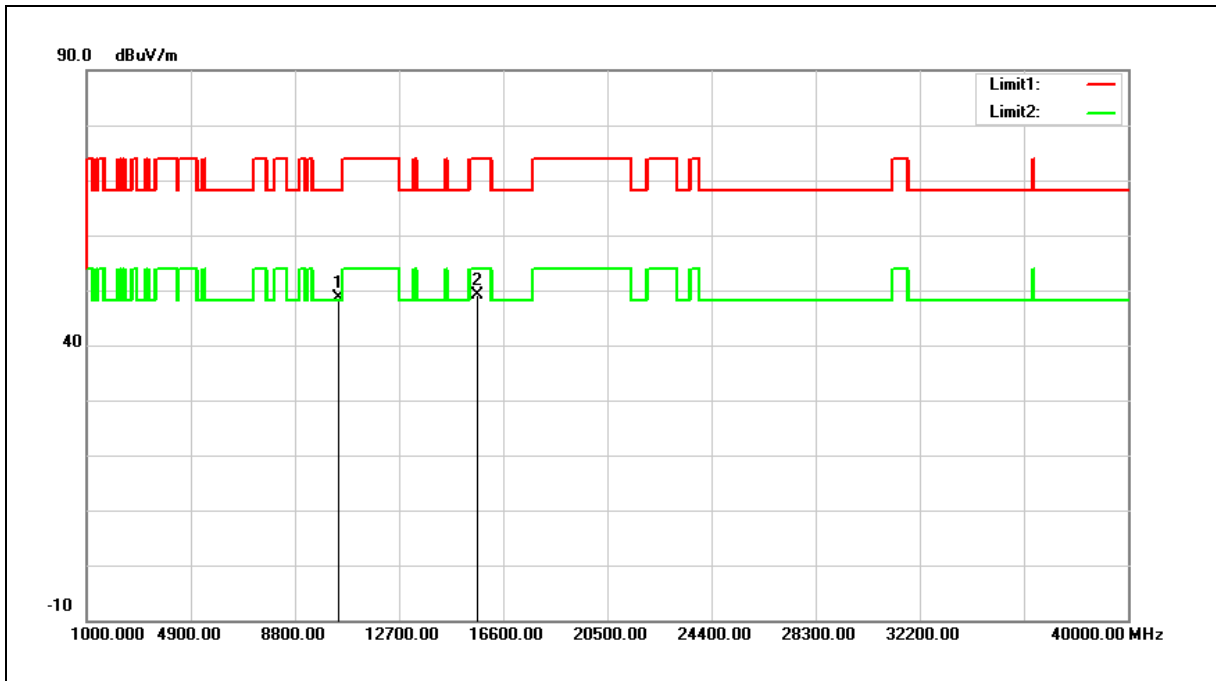

No.	Frequency (MHz)	Reading (dBuV)	Correct Factor (dB/m)	Result (dBuV/m)	Limit (dBuV/m)	Margin (dB)	Remark
1	10420.000	34.14	14.42	48.56	68.20	-19.64	peak
2	15630.000	32.51	16.56	49.07	74.00	-24.93	peak

Note:1.Result (dBuV/m) = Correct Factor (dB/m) + Reading(dBuV).

2.Correction factor (dB/m) = Antenna Factor (dB/m) + Cable loss (dB) – Pre-Amplifier gain (dB).

3.When the peak results are less than average limit, so not need to evaluate the average.

Standard:	FCC Part 15.407	Test Distance:	3 m
Test item:	Harmonic		
Frequency:	5210 MHz		
Mode:	Mode 10		
Ant.Polar.:	Vertical		

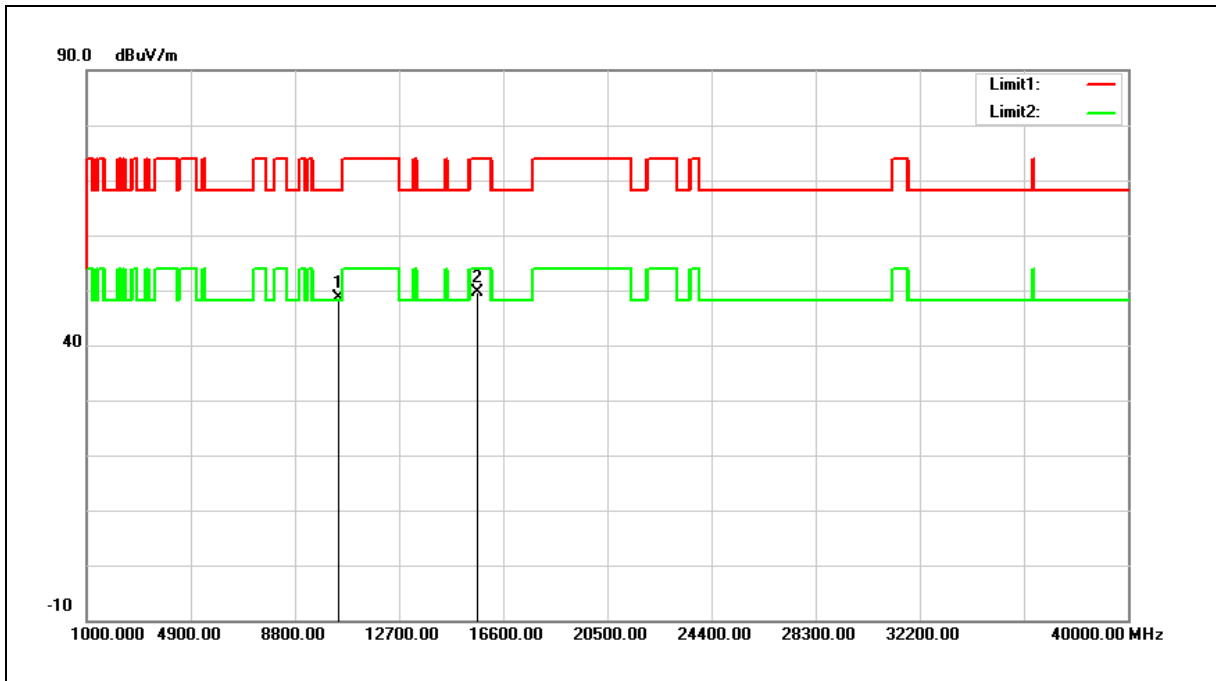

No.	Frequency (MHz)	Reading (dBuV)	Correct Factor (dB/m)	Result (dBuV/m)	Limit (dBuV/m)	Margin (dB)	Remark
1	10420.000	34.12	14.42	48.54	68.20	-19.66	peak
2	15630.000	32.97	16.56	49.53	74.00	-24.47	peak

Note:1.Result (dBuV/m) = Correct Factor (dB/m) + Reading(dBuV).

2.Correction factor (dB/m) = Antenna Factor (dB/m) + Cable loss (dB) – Pre-Amplifier gain (dB).

3.When the peak results are less than average limit, so not need to evaluate the average.

Standard:	FCC Part 15.407	Test Distance:	3 m
Test item:	Harmonic		
Frequency:	5290 MHz		
Mode:	Mode 10		
Ant.Polar.:	Horizontal		

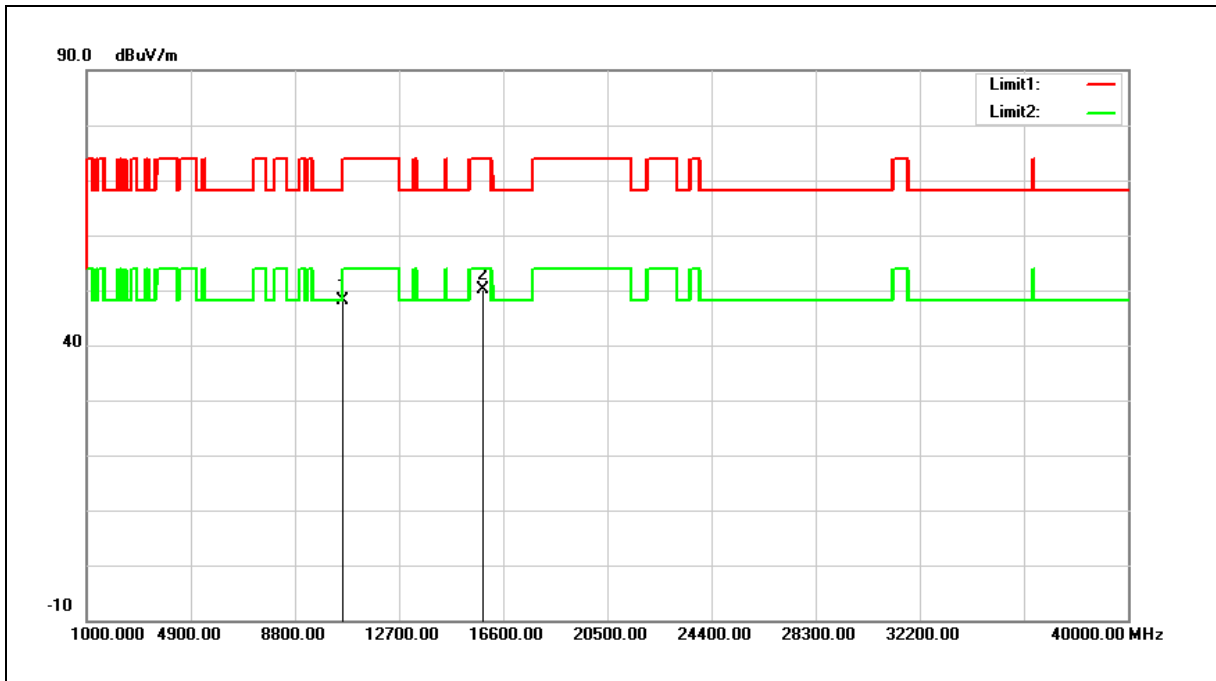

No.	Frequency (MHz)	Reading (dBuV)	Correct Factor (dB/m)	Result (dBuV/m)	Limit (dBuV/m)	Margin (dB)	Remark
1	10580.000	33.52	14.57	48.09	68.20	-20.11	peak
2	15870.000	34.42	15.74	50.16	74.00	-23.84	peak

Note:1.Result (dBuV/m) = Correct Factor (dB/m) + Reading(dBuV).

2.Correction factor (dB/m) = Antenna Factor (dB/m) + Cable loss (dB) – Pre-Amplifier gain (dB).

3.When the peak results are less than average limit, so not need to evaluate the average.

Standard:	FCC Part 15.407	Test Distance:	3 m
Test item:	Harmonic		
Frequency:	5290 MHz		
Mode:	Mode 10		
Ant.Polar.:	Vertical		

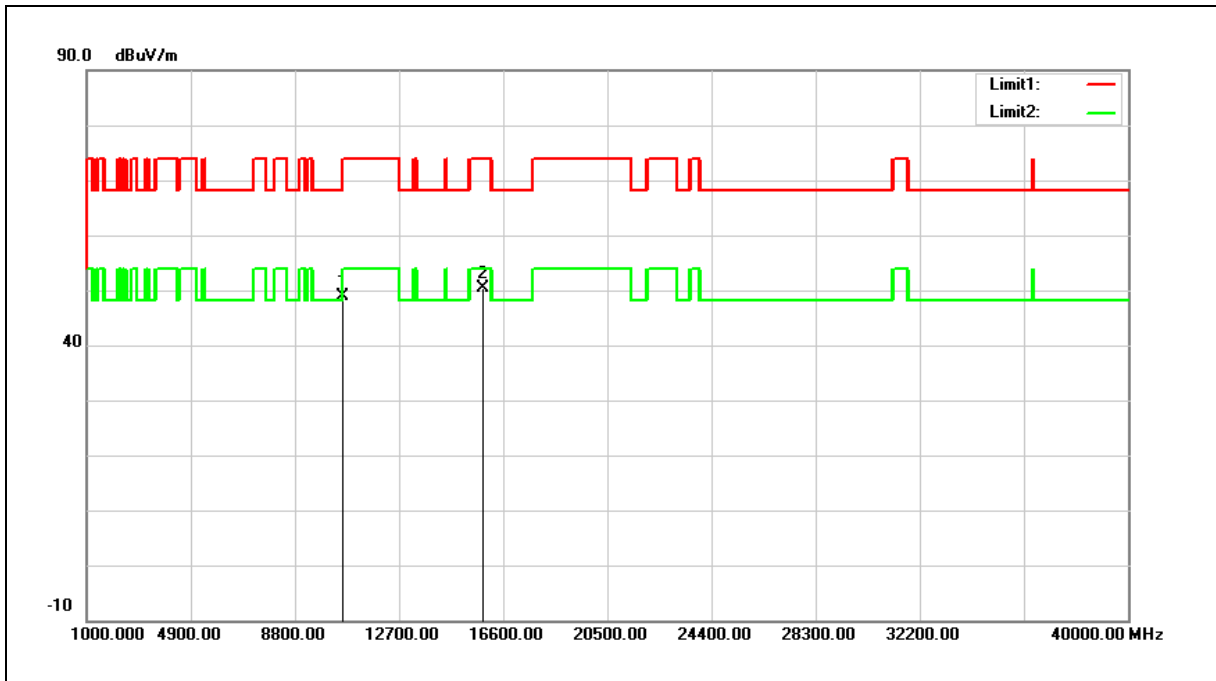

No.	Frequency (MHz)	Reading (dBuV)	Correct Factor (dB/m)	Result (dBuV/m)	Limit (dBuV/m)	Margin (dB)	Remark
1	10580.000	34.33	14.57	48.90	68.20	-19.30	peak
2	15870.000	34.57	15.74	50.31	74.00	-23.69	peak

Note:1.Result (dBuV/m) = Correct Factor (dB/m) + Reading(dBuV).

2.Correction factor (dB/m) = Antenna Factor (dB/m) + Cable loss (dB) – Pre-Amplifier gain (dB).

3.When the peak results are less than average limit, so not need to evaluate the average.

Standard:	FCC Part 15.407	Test Distance:	3 m
Test item:	Harmonic		
Frequency:	5530 MHz		
Mode:	Mode 10		
Ant.Polar.:	Horizontal		

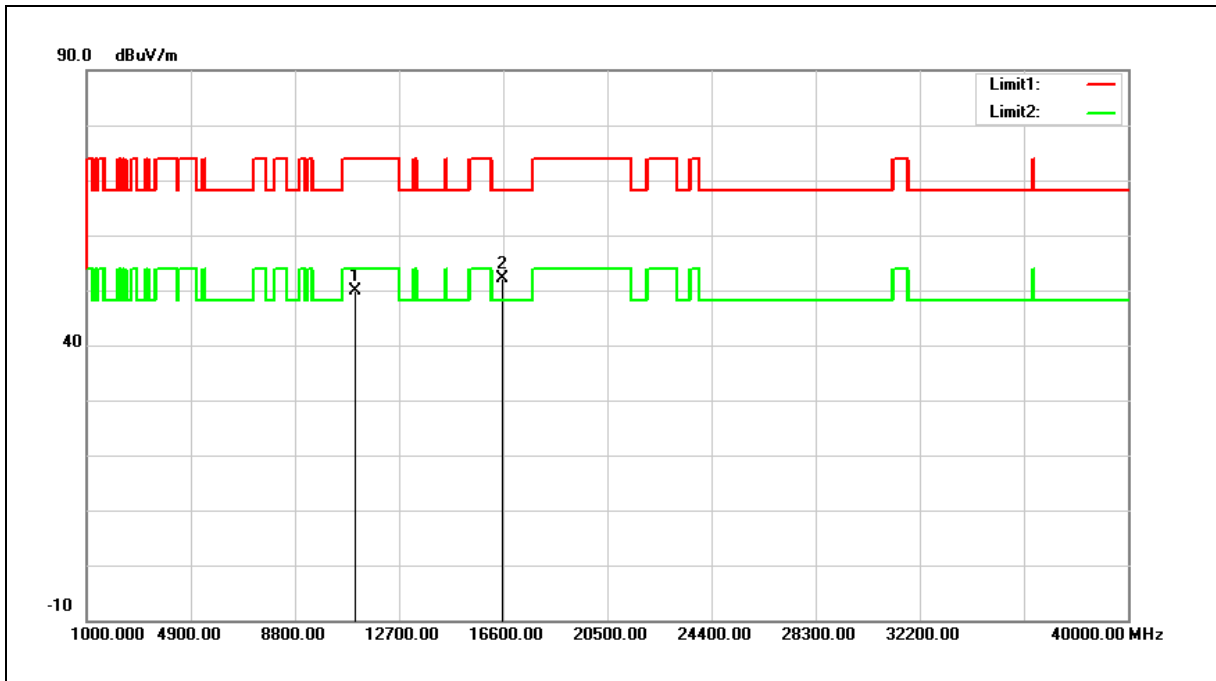

No.	Frequency (MHz)	Reading (dBuV)	Correct Factor (dB/m)	Result (dBuV/m)	Limit (dBuV/m)	Margin (dB)	Remark
1	11060.000	35.36	14.58	49.94	74.00	-24.06	peak
2	16590.000	34.89	17.29	52.18	68.20	-16.02	peak

Note:1.Result (dBuV/m) = Correct Factor (dB/m) + Reading(dBuV).

2.Correction factor (dB/m) = Antenna Factor (dB/m) + Cable loss (dB) – Pre-Amplifier gain (dB).

3.When the peak results are less than average limit, so not need to evaluate the average.

Standard:	FCC Part 15.407	Test Distance:	3 m
Test item:	Harmonic		
Frequency:	5530 MHz		
Mode:	Mode 10		
Ant.Polar.:	Vertical		

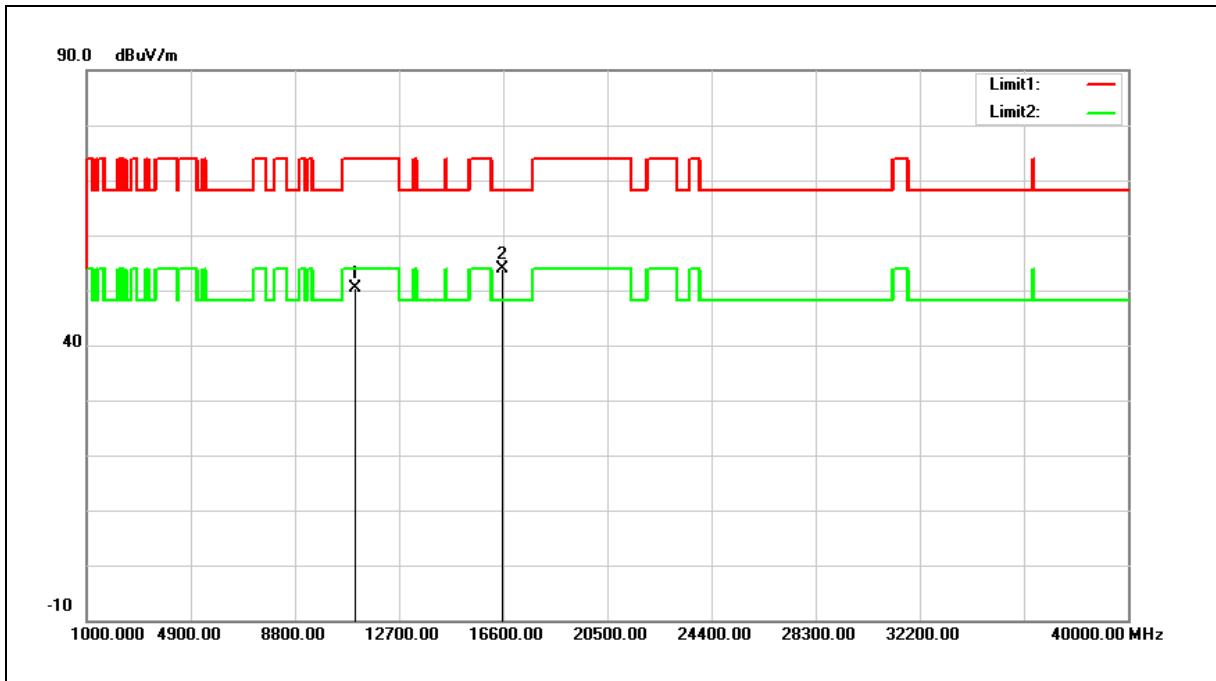

No.	Frequency (MHz)	Reading (dBuV)	Correct Factor (dB/m)	Result (dBuV/m)	Limit (dBuV/m)	Margin (dB)	Remark
1	11060.000	35.77	14.58	50.35	74.00	-23.65	peak
2	16590.000	36.60	17.29	53.89	68.20	-14.31	peak

Note:1.Result (dBuV/m) = Correct Factor (dB/m) + Reading(dBuV).

2.Correction factor (dB/m) = Antenna Factor (dB/m) + Cable loss (dB) – Pre-Amplifier gain (dB).

3.When the peak results are less than average limit, so not need to evaluate the average.

Standard:	FCC Part 15.407	Test Distance:	3 m
Test item:	Harmonic		
Frequency:	5775 MHz		
Mode:	Mode 10		
Ant.Polar.:	Horizontal		

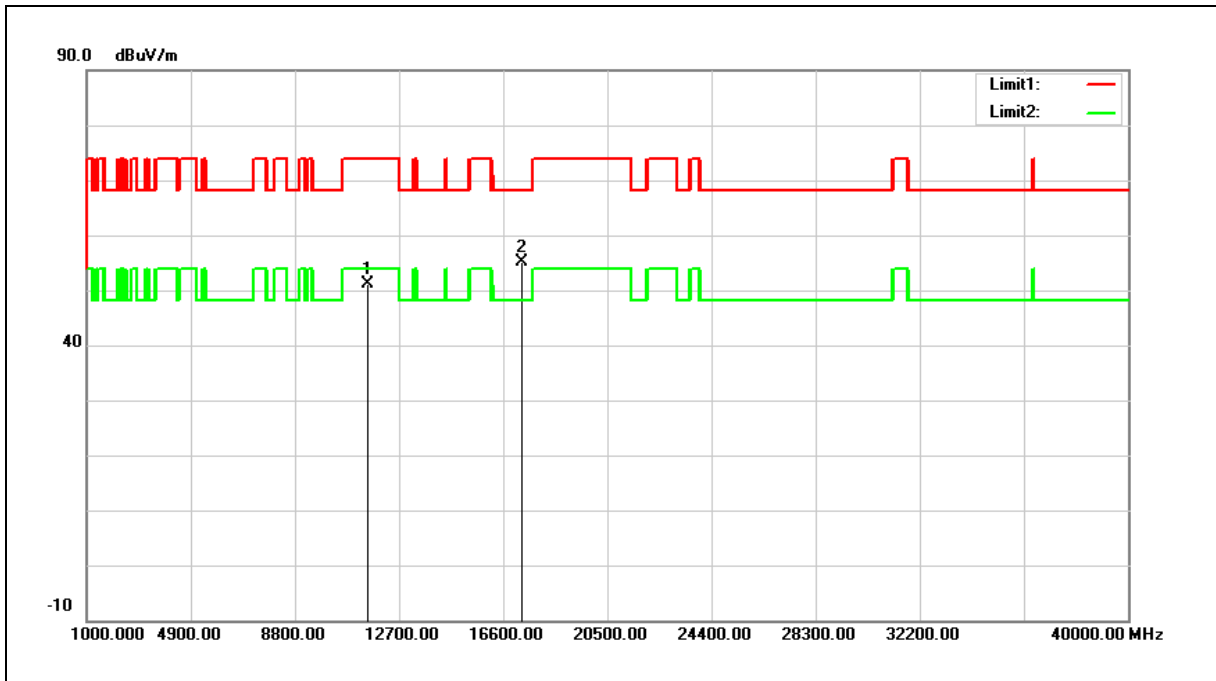

No.	Frequency (MHz)	Reading (dBuV)	Correct Factor (dB/m)	Result (dBuV/m)	Limit (dBuV/m)	Margin (dB)	Remark
1	11550.000	35.82	15.29	51.11	74.00	-22.89	peak
2	17325.000	32.98	22.24	55.22	68.20	-12.98	peak

Note:1.Result (dBuV/m) = Correct Factor (dB/m) + Reading(dBuV).

2.Correction factor (dB/m) = Antenna Factor (dB/m) + Cable loss (dB) – Pre-Amplifier gain (dB).

3.When the peak results are less than average limit, so not need to evaluate the average.

Standard:	FCC Part 15.407	Test Distance:	3 m
Test item:	Harmonic		
Frequency:	5775 MHz		
Mode:	Mode 10		
Ant.Polar.:	Vertical		

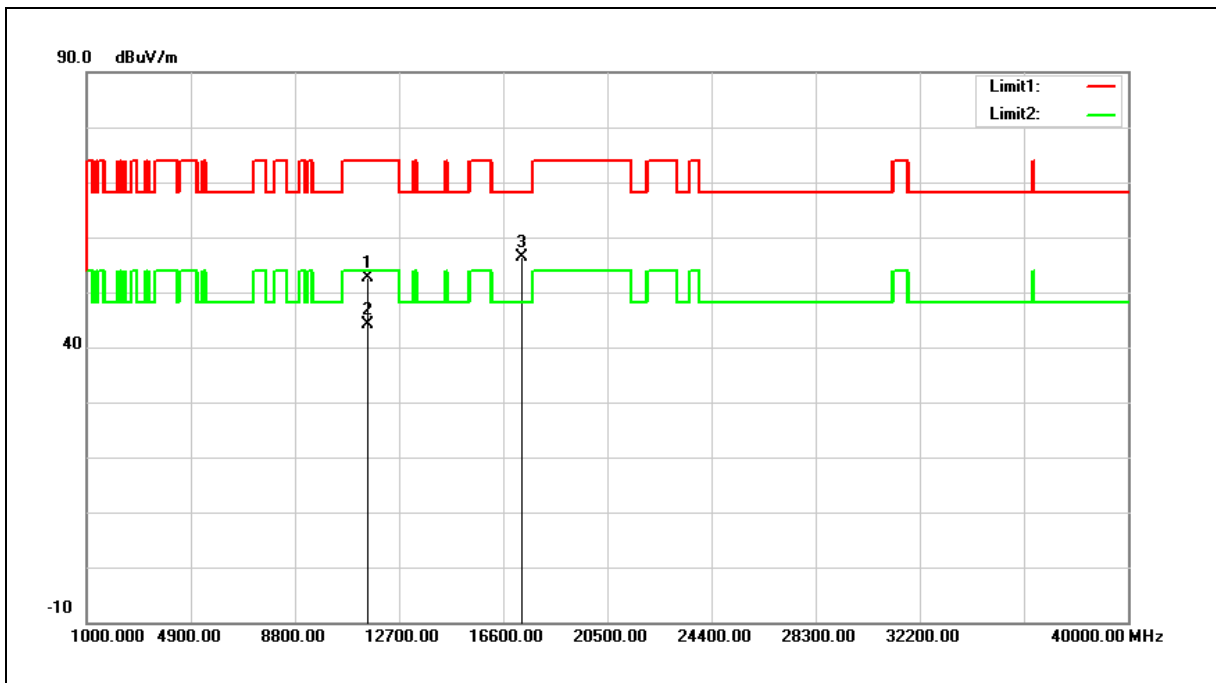

No.	Frequency (MHz)	Reading (dBuV)	Correct Factor (dB/m)	Result (dBuV/m)	Limit (dBuV/m)	Margin (dB)	Remark
1	11550.000	37.44	15.29	52.73	74.00	-21.27	peak
2	11550.000	28.91	15.29	44.20	54.00	-9.80	AVG
3	17325.000	34.13	22.24	56.37	68.20	-11.83	peak

Note:1.Result (dBuV/m) = Correct Factor (dB/m) + Reading(dBuV).

2.Correction factor (dB/m) = Antenna Factor (dB/m) + Cable loss (dB) – Pre-Amplifier gain (dB).

3.When the peak results are less than average limit, so not need to evaluate the average.

Standard:	FCC Part 15.407	Test Distance:	3 m
Test item:	Transmitter Unwanted Emissions		
Test Mode:	Simultaneous Transmitting (WLAN 2.4 GHz + 5 GHz)		
Ant.Polar.:	Horizontal		

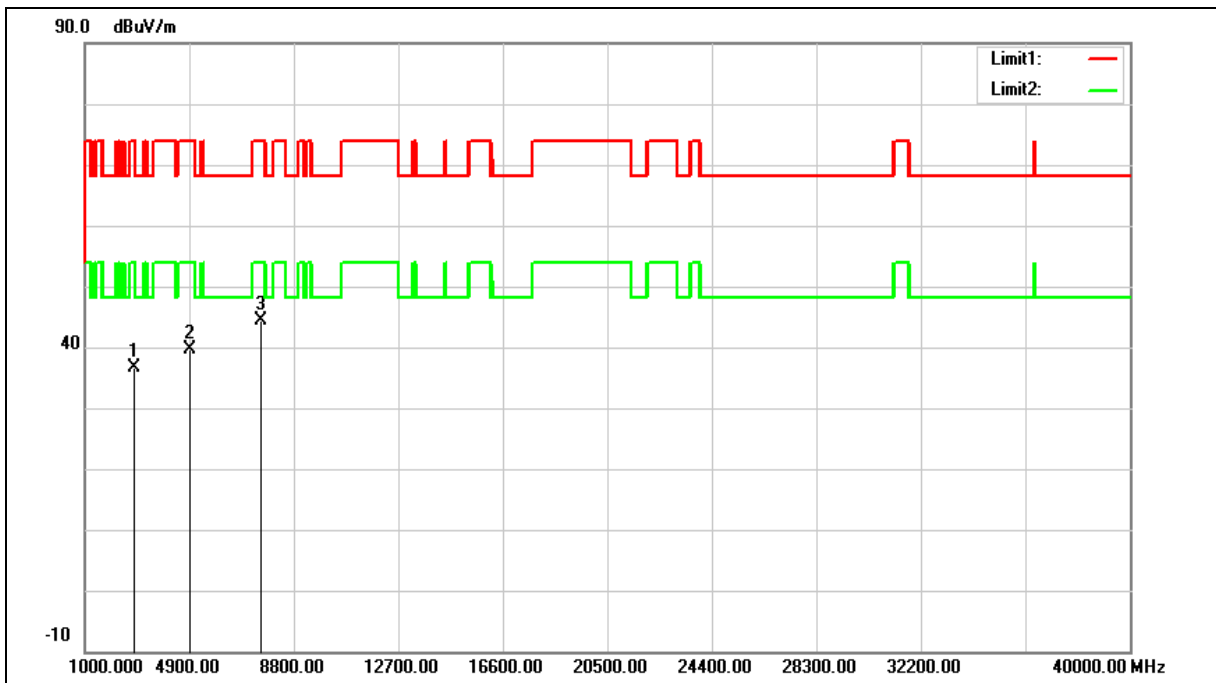

No.	Frequency (MHz)	Reading (dBuV)	Correct Factor (dB/m)	Result (dBuV/m)	Limit (dBuV/m)	Margin (dB)	Remark
1	2802.000	42.45	-5.94	36.51	74.00	-37.49	peak
2	4893.000	40.25	-0.73	39.52	74.00	-34.48	peak
3	7579.000	37.05	7.37	44.42	74.00	-29.58	peak

Note:1.Result (dBuV/m) = Correct Factor (dB/m) + Reading(dBuV).

2.Correction factor (dB/m) = Antenna Factor (dB/m) + Cable loss (dB) – Pre-Amplifier gain (dB).

3.When the peak results are less than average limit, so not need to evaluate the average.

Standard:	FCC Part 15.407	Test Distance:	3 m
Test item:	Transmitter Unwanted Emissions		
Test Mode:	Simultaneous Transmitting (WLAN 2.4 GHz + 5 GHz)		
Ant.Polar.:	Vertical		

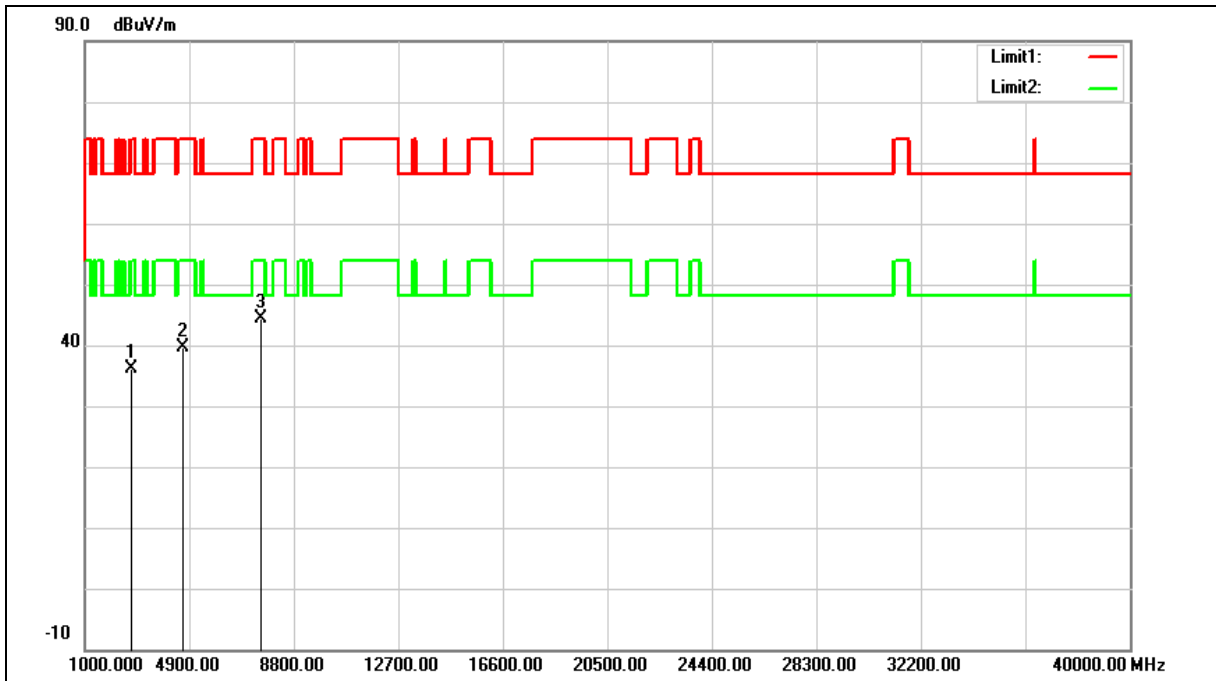

No.	Frequency (MHz)	Reading (dBuV)	Correct Factor (dB/m)	Result (dBuV/m)	Limit (dBuV/m)	Margin (dB)	Remark
1	2734.000	42.38	-6.15	36.23	74.00	-37.77	peak
2	4638.000	41.15	-1.61	39.54	74.00	-34.46	peak
3	7562.000	37.16	7.33	44.49	74.00	-29.51	peak

Note:1.Result (dBuV/m) = Correct Factor (dB/m) + Reading(dBuV).

2.Correction factor (dB/m) = Antenna Factor (dB/m) + Cable loss (dB) – Pre-Amplifier gain (dB).

3.When the peak results are less than average limit, so not need to evaluate the average.

Band Edge

Peak

Standard:	FCC Part 15.407	Test Distance:	3 m
Test item:	Band edge		
Frequency:	5180 MHz		
Mode:	Mode 2		
Ant.Polar.:	Horizontal		

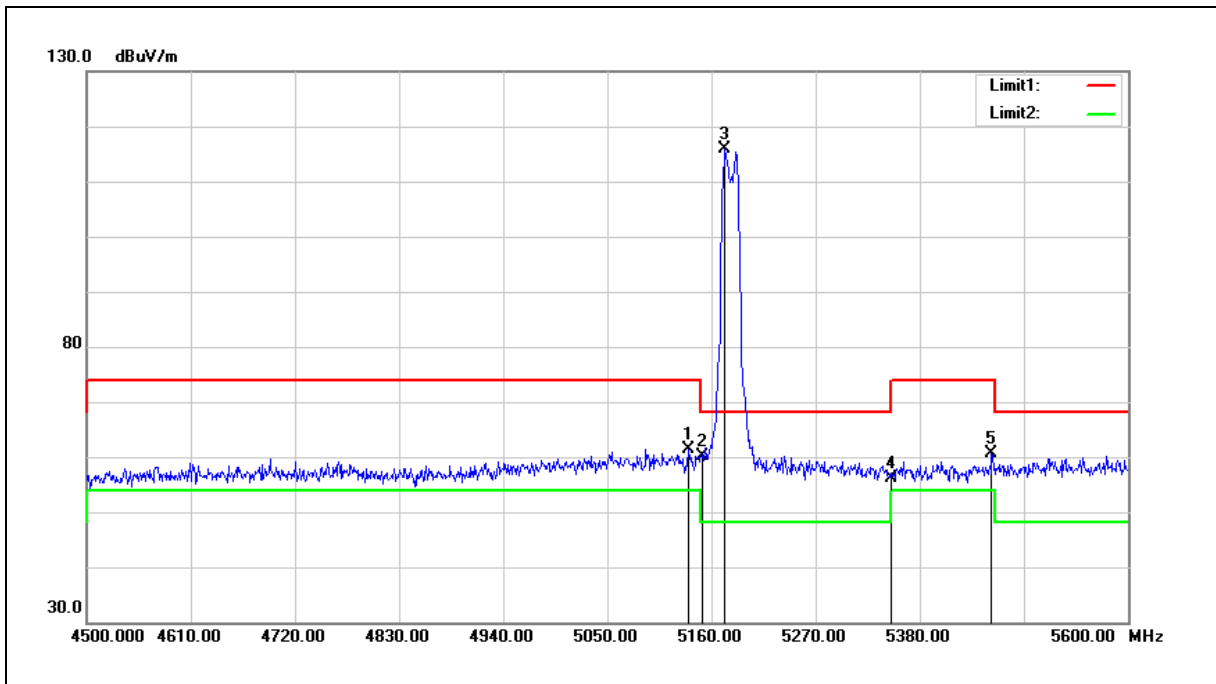

No.	Frequency (MHz)	Reading (dBuV)	Correct Factor (dB/m)	Result (dBuV/m)	Limit (dBuV/m)	Margin (dB)	Remark
1	5135.800	61.37	-0.10	61.27	74.00	-12.73	peak
2	5150.000	60.12	-0.08	60.04	74.00	-13.96	peak
3	5174.300	115.91	-0.03	115.88	--	--	peak
4	5350.000	55.73	0.30	56.03	74.00	-17.97	peak
5	5455.900	60.05	0.49	60.54	74.00	-13.46	peak

Note:1.Result (dBuV/m) = Correct Factor (dB/m) + Reading(dBuV).

2.Correction factor (dB/m) = Antenna Factor (dB/m) + Cable loss (dB) – Pre-Amplifier gain (dB).

3.When the peak results are less than average limit, so not need to evaluate the average.

Standard:	FCC Part 15.407	Test Distance:	3 m
Test item:	Band edge		
Frequency:	5180 MHz		
Mode:	Mode 2		
Ant.Polar.:	Vertical		

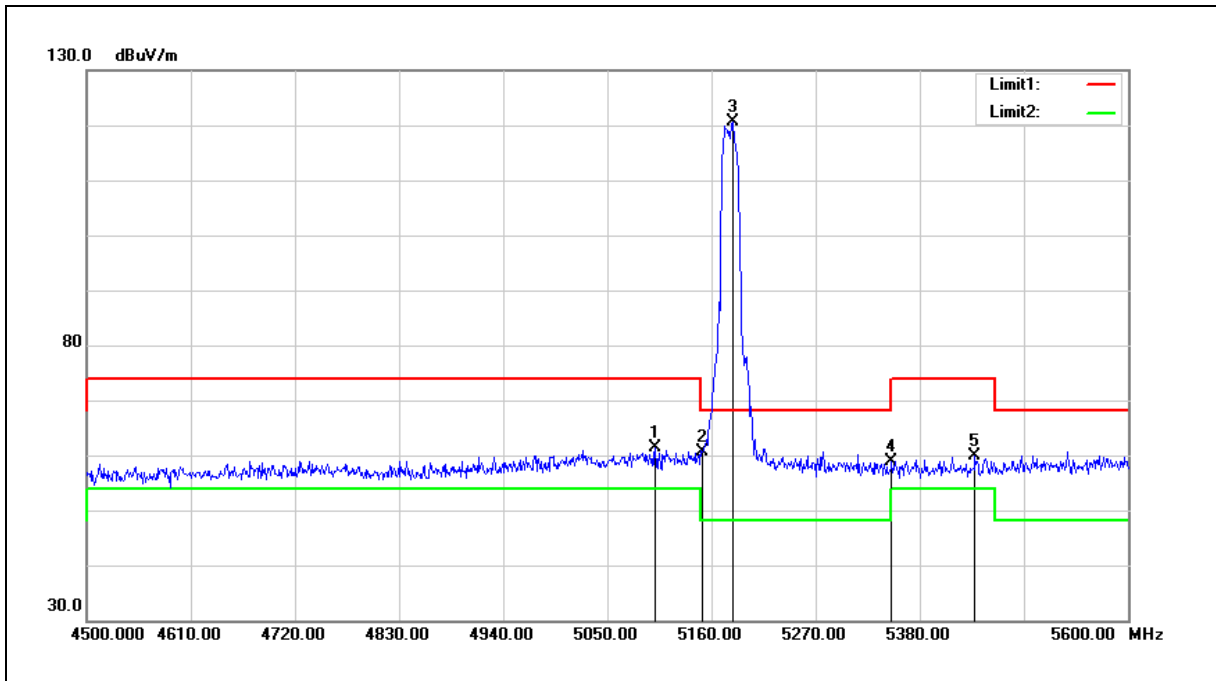

No.	Frequency (MHz)	Reading (dBuV)	Correct Factor (dB/m)	Result (dBuV/m)	Limit (dBuV/m)	Margin (dB)	Remark
1	5100.600	61.45	-0.18	61.27	74.00	-12.73	peak
2	5150.000	60.66	-0.08	60.58	74.00	-13.42	peak
3	5183.100	120.70	-0.02	120.68	--	--	peak
4	5350.000	58.70	0.30	59.00	74.00	-15.00	peak
5	5438.300	59.38	0.46	59.84	74.00	-14.16	peak

Note:1.Result (dBuV/m) = Correct Factor (dB/m) + Reading(dBuV).

2.Correction factor (dB/m) = Antenna Factor (dB/m) + Cable loss (dB) – Pre-Amplifier gain (dB).

3.When the peak results are less than average limit, so not need to evaluate the average.

Standard:	FCC Part 15.407	Test Distance:	3 m
Test item:	Band edge		
Frequency:	5200 MHz		
Mode:	Mode 2		
Ant.Polar.:	Horizontal		

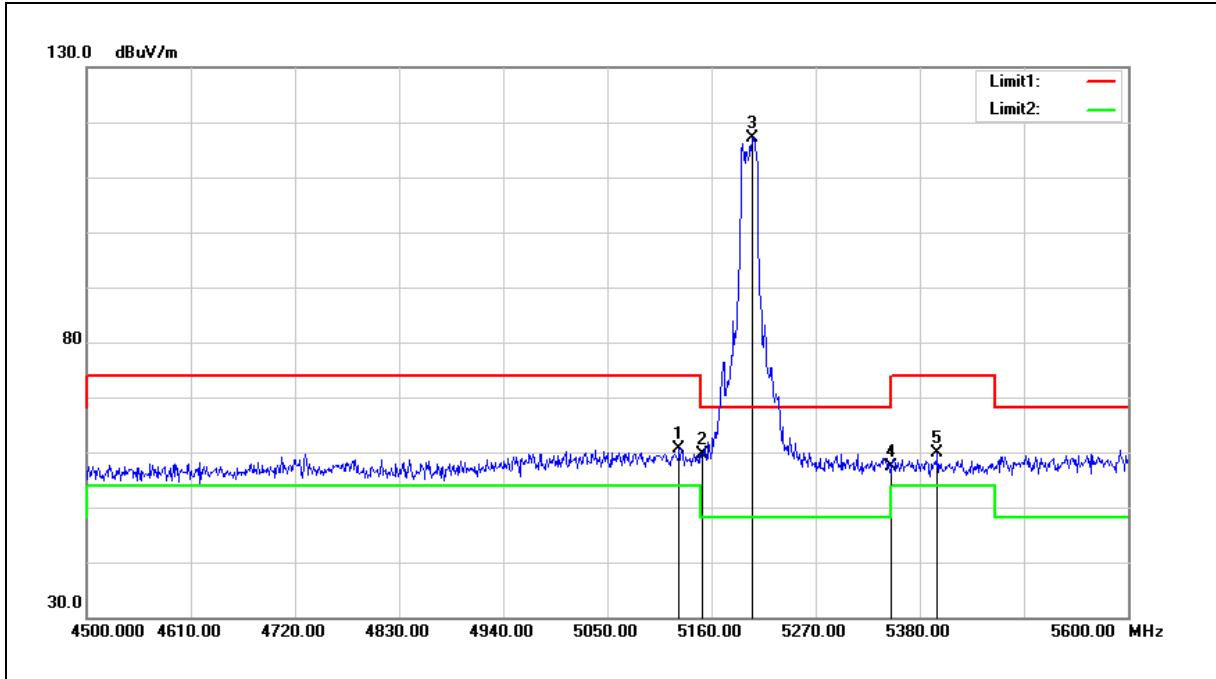

No.	Frequency (MHz)	Reading (dBuV)	Correct Factor (dB/m)	Result (dBuV/m)	Limit (dBuV/m)	Margin (dB)	Remark
1	5125.900	60.80	-0.13	60.67	74.00	-13.33	peak
2	5150.000	59.70	-0.08	59.62	74.00	-14.38	peak
3	5202.900	117.11	0.02	117.13	--	--	peak
4	5350.000	57.15	0.30	57.45	74.00	-16.55	peak
5	5398.700	59.42	0.39	59.81	74.00	-14.19	peak

Note:1.Result (dBuV/m) = Correct Factor (dB/m) + Reading(dBuV).

2.Correction factor (dB/m) = Antenna Factor (dB/m) + Cable loss (dB) – Pre-Amplifier gain (dB).

3.When the peak results are less than average limit, so not need to evaluate the average.

Standard:	FCC Part 15.407	Test Distance:	3 m
Test item:	Band edge		
Frequency:	5200 MHz		
Mode:	Mode 2		
Ant.Polar.:	Vertical		

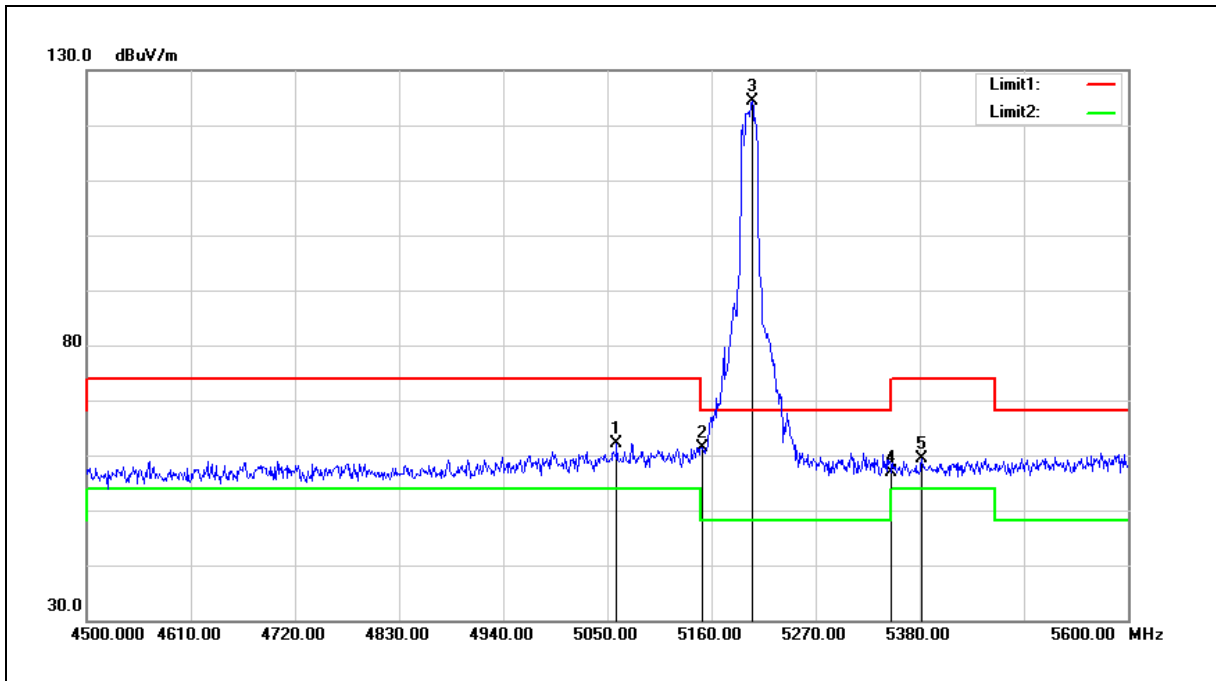

No.	Frequency (MHz)	Reading (dBuV)	Correct Factor (dB/m)	Result (dBuV/m)	Limit (dBuV/m)	Margin (dB)	Remark
1	5059.900	62.42	-0.25	62.17	74.00	-11.83	peak
2	5150.000	61.50	-0.08	61.42	74.00	-12.58	peak
3	5202.900	124.32	0.02	124.34	--	--	peak
4	5350.000	56.65	0.30	56.95	74.00	-17.05	peak
5	5382.200	59.02	0.36	59.38	74.00	-14.62	peak

Note:1.Result (dBuV/m) = Correct Factor (dB/m) + Reading(dBuV).

2.Correction factor (dB/m) = Antenna Factor (dB/m) + Cable loss (dB) – Pre-Amplifier gain (dB).

3.When the peak results are less than average limit, so not need to evaluate the average.

Standard:	FCC Part 15.407	Test Distance:	3 m
Test item:	Band edge		
Frequency:	5240 MHz		
Mode:	Mode 2		
Ant.Polar.:	Horizontal		

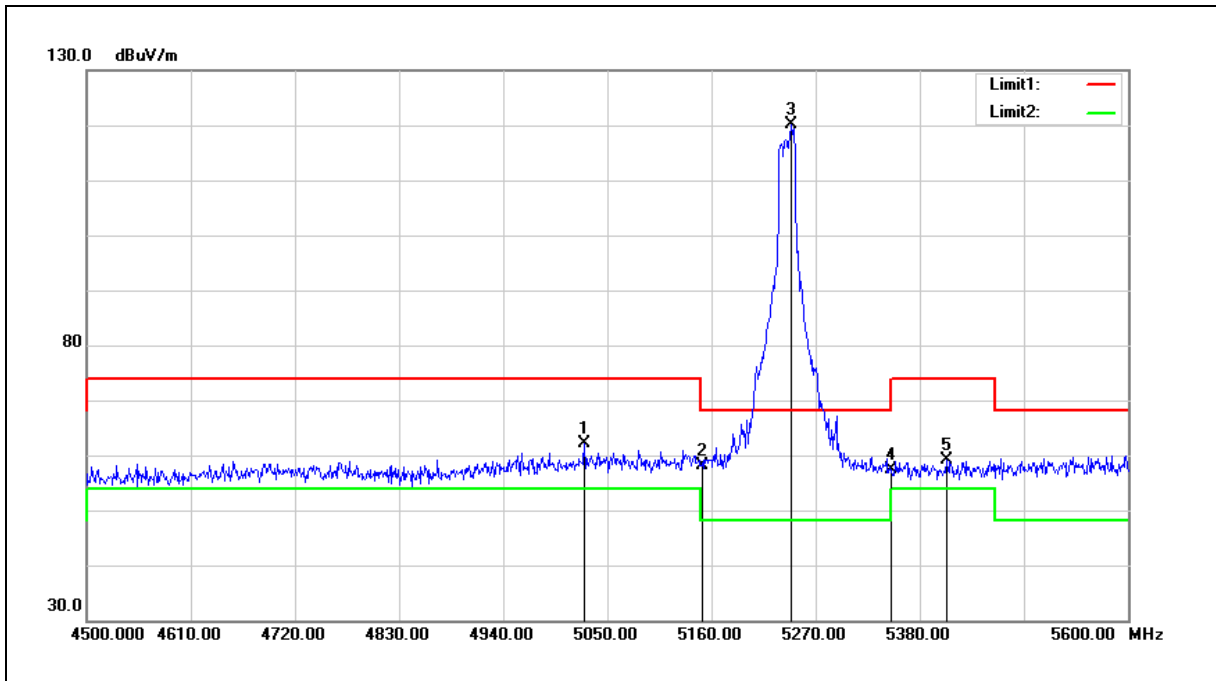

No.	Frequency (MHz)	Reading (dBuV)	Correct Factor (dB/m)	Result (dBuV/m)	Limit (dBuV/m)	Margin (dB)	Remark
1	5025.800	62.32	-0.31	62.01	74.00	-11.99	peak
2	5150.000	58.24	-0.08	58.16	74.00	-15.84	peak
3	5244.700	119.93	0.10	120.03	--	--	peak
4	5350.000	57.11	0.30	57.41	74.00	-16.59	peak
5	5408.600	58.71	0.41	59.12	74.00	-14.88	peak

Note:1.Result (dBuV/m) = Correct Factor (dB/m) + Reading(dBuV).

2.Correction factor (dB/m) = Antenna Factor (dB/m) + Cable loss (dB) – Pre-Amplifier gain (dB).

3.When the peak results are less than average limit, so not need to evaluate the average.

Standard:	FCC Part 15.407	Test Distance:	3 m
Test item:	Band edge		
Frequency:	5240 MHz		
Mode:	Mode 2		
Ant.Polar.:	Vertical		

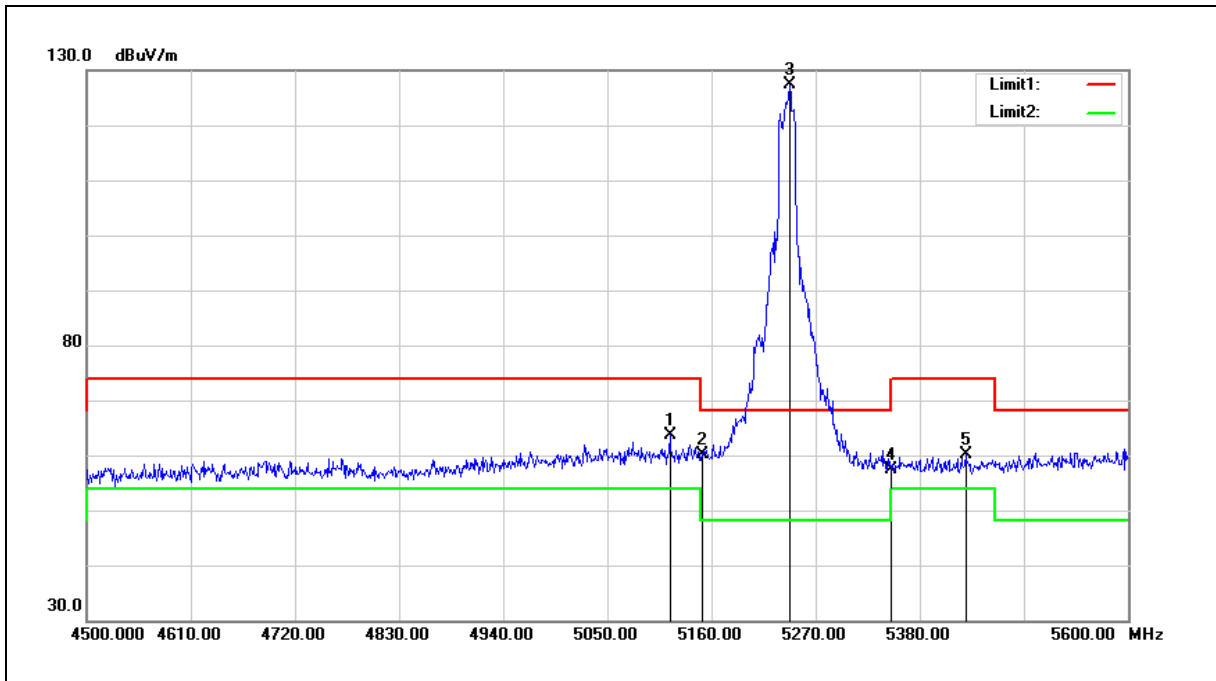

No.	Frequency (MHz)	Reading (dBuV)	Correct Factor (dB/m)	Result (dBuV/m)	Limit (dBuV/m)	Margin (dB)	Remark
1	5116.000	63.70	-0.15	63.55	74.00	-10.45	peak
2	5150.000	60.30	-0.08	60.22	74.00	-13.78	peak
3	5242.500	127.35	0.09	127.44	--	--	peak
4	5350.000	57.02	0.30	57.32	74.00	-16.68	peak
5	5428.400	59.75	0.44	60.19	74.00	-13.81	peak

Note:1.Result (dBuV/m) = Correct Factor (dB/m) + Reading(dBuV).

2.Correction factor (dB/m) = Antenna Factor (dB/m) + Cable loss (dB) – Pre-Amplifier gain (dB).

3.When the peak results are less than average limit, so not need to evaluate the average.

Standard:	FCC Part 15.407	Test Distance:	3 m
Test item:	Band edge		
Frequency:	5260 MHz		
Mode:	Mode 2		
Ant.Polar.:	Horizontal		

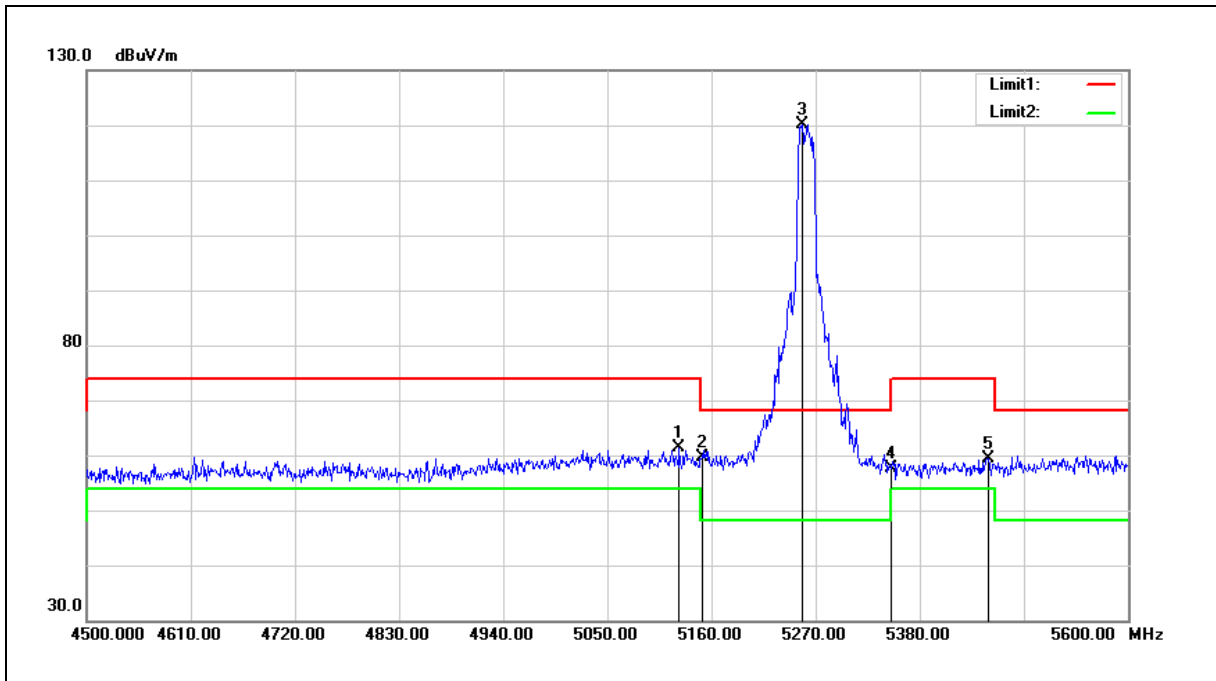

No.	Frequency (MHz)	Reading (dBuV)	Correct Factor (dB/m)	Result (dBuV/m)	Limit (dBuV/m)	Margin (dB)	Remark
1	5125.900	61.56	-0.13	61.43	74.00	-12.57	peak
2	5150.000	59.81	-0.08	59.73	74.00	-14.27	peak
3	5255.700	120.12	0.12	120.24	--	--	peak
4	5350.000	57.34	0.30	57.64	74.00	-16.36	peak
5	5452.600	58.93	0.48	59.41	74.00	-14.59	peak

Note:1.Result (dBuV/m) = Correct Factor (dB/m) + Reading(dBuV).

2.Correction factor (dB/m) = Antenna Factor (dB/m) + Cable loss (dB) – Pre-Amplifier gain (dB).

3.When the peak results are less than average limit, so not need to evaluate the average.

Standard:	FCC Part 15.407	Test Distance:	3 m
Test item:	Band edge		
Frequency:	5260 MHz		
Mode:	Mode 2		
Ant.Polar.:	Vertical		

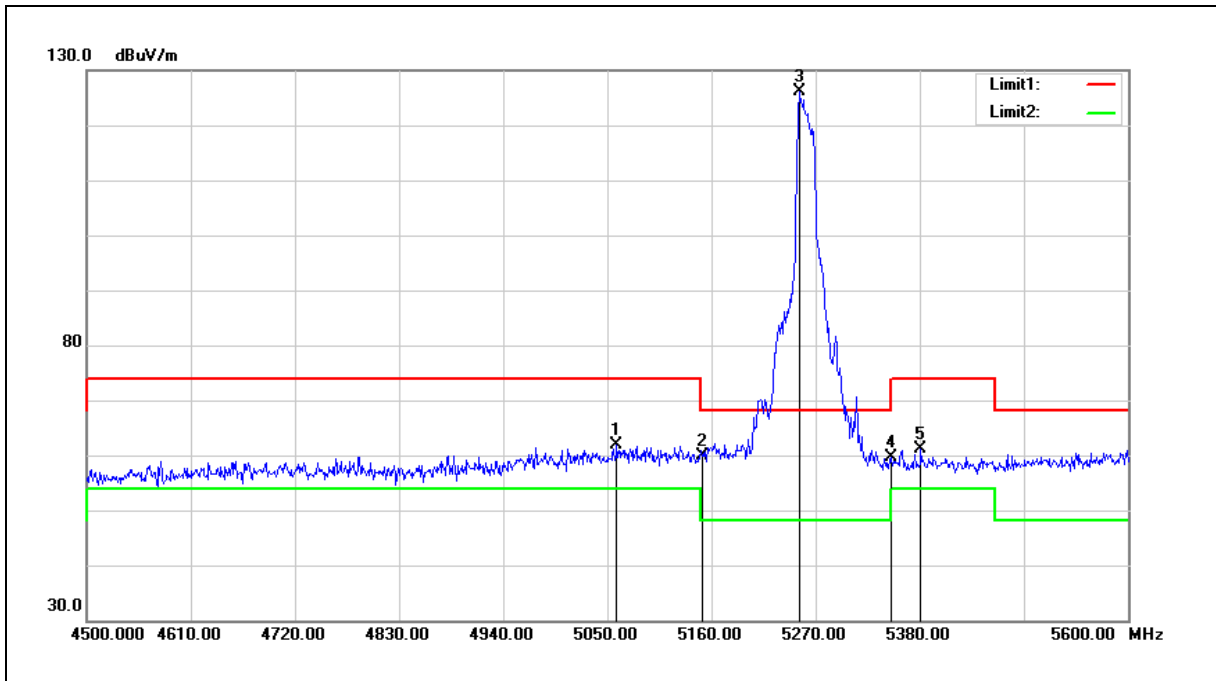

No.	Frequency (MHz)	Reading (dBuV)	Correct Factor (dB/m)	Result (dBuV/m)	Limit (dBuV/m)	Margin (dB)	Remark
1	5059.900	62.08	-0.25	61.83	74.00	-12.17	peak
2	5150.000	59.92	-0.08	59.84	74.00	-14.16	peak
3	5252.400	126.13	0.11	126.24	--	--	peak
4	5350.000	59.28	0.30	59.58	74.00	-14.42	peak
5	5381.100	60.77	0.35	61.12	74.00	-12.88	peak

Note:1.Result (dBuV/m) = Correct Factor (dB/m) + Reading(dBuV).

2.Correction factor (dB/m) = Antenna Factor (dB/m) + Cable loss (dB) – Pre-Amplifier gain (dB).

3.When the peak results are less than average limit, so not need to evaluate the average.

Standard:	FCC Part 15.407	Test Distance:	3 m
Test item:	Band edge		
Frequency:	5280 MHz		
Mode:	Mode 2		
Ant.Polar.:	Horizontal		

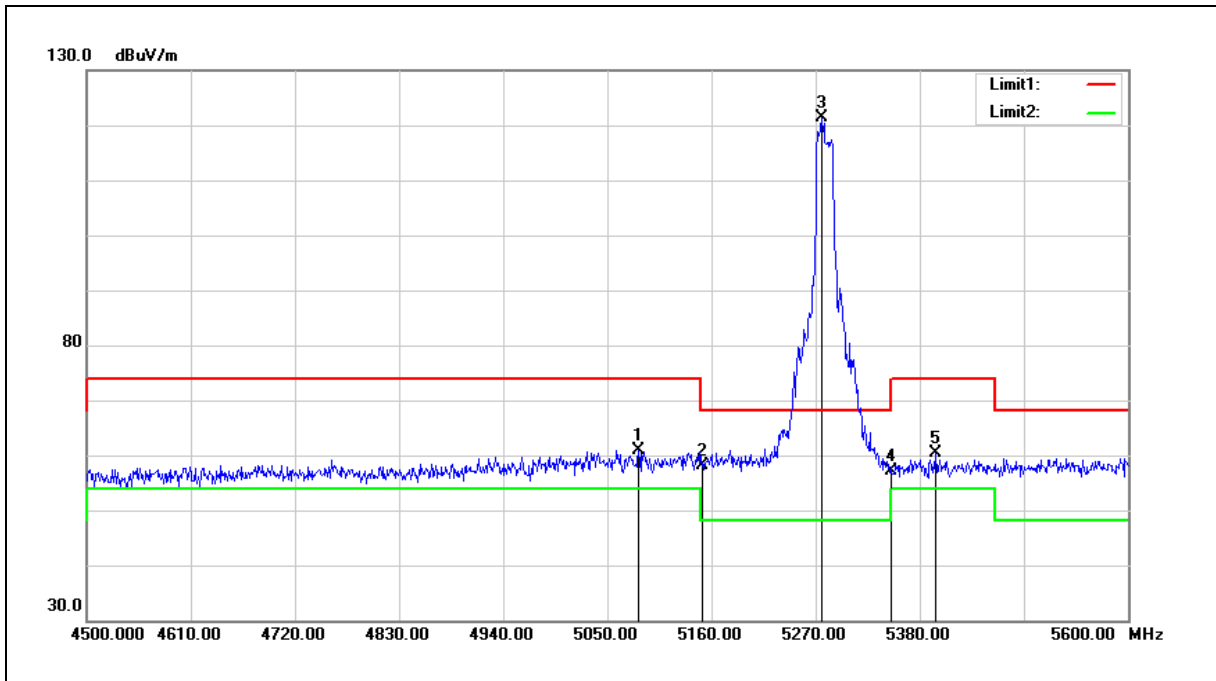

No.	Frequency (MHz)	Reading (dBuV)	Correct Factor (dB/m)	Result (dBuV/m)	Limit (dBuV/m)	Margin (dB)	Remark
1	5083.000	61.01	-0.20	60.81	74.00	-13.19	peak
2	5150.000	58.15	-0.08	58.07	74.00	-15.93	peak
3	5276.600	121.18	0.15	121.33	--	--	peak
4	5350.000	56.83	0.30	57.13	74.00	-16.87	peak
5	5396.500	60.07	0.38	60.45	74.00	-13.55	peak

Note:1.Result (dBuV/m) = Correct Factor (dB/m) + Reading(dBuV).

2.Correction factor (dB/m) = Antenna Factor (dB/m) + Cable loss (dB) – Pre-Amplifier gain (dB).

3.When the peak results are less than average limit, so not need to evaluate the average.

Standard:	FCC Part 15.407	Test Distance:	3 m
Test item:	Band edge		
Frequency:	5280 MHz		
Mode:	Mode 2		
Ant.Polar.:	Vertical		

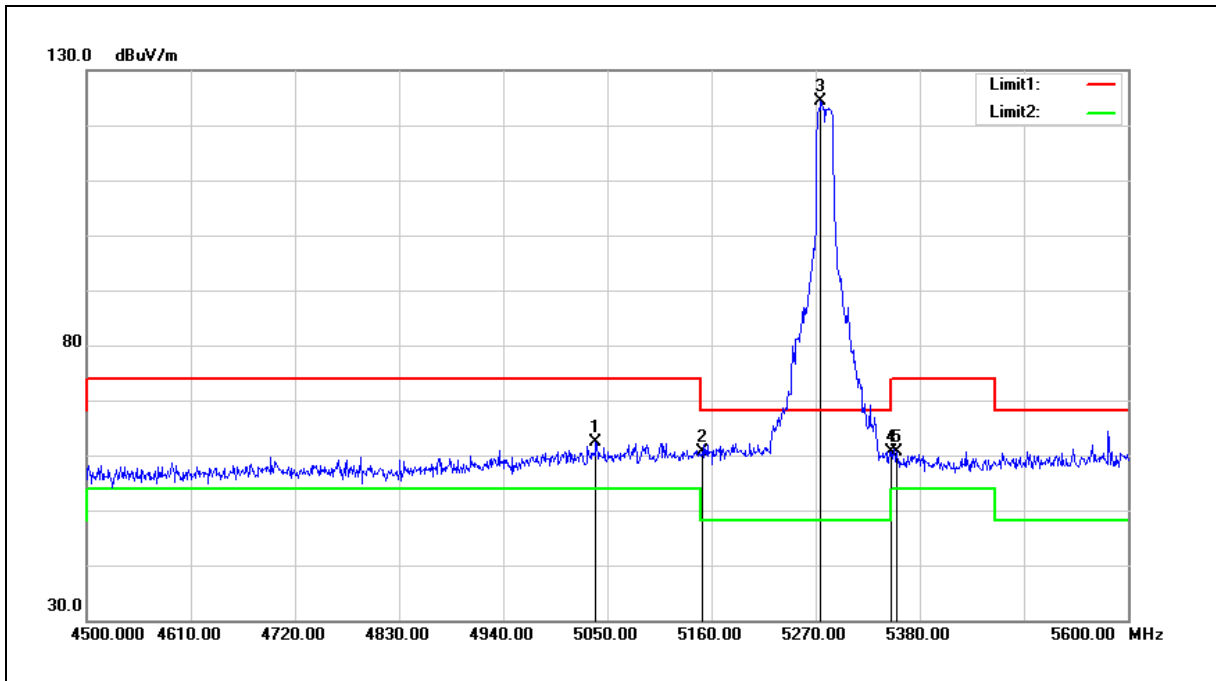

No.	Frequency (MHz)	Reading (dBuV)	Correct Factor (dB/m)	Result (dBuV/m)	Limit (dBuV/m)	Margin (dB)	Remark
1	5037.900	62.64	-0.29	62.35	74.00	-11.65	peak
2	5150.000	60.72	-0.08	60.64	74.00	-13.36	peak
3	5275.500	124.24	0.15	124.39	--	--	peak
4	5350.000	60.37	0.30	60.67	74.00	-13.33	peak
5	5355.800	60.38	0.30	60.68	74.00	-13.32	peak

Note:1.Result (dBuV/m) = Correct Factor (dB/m) + Reading(dBuV).

2.Correction factor (dB/m) = Antenna Factor (dB/m) + Cable loss (dB) – Pre-Amplifier gain (dB).

3.When the peak results are less than average limit, so not need to evaluate the average.

Standard:	FCC Part 15.407	Test Distance:	3 m
Test item:	Band edge		
Frequency:	5320 MHz		
Mode:	Mode 2		
Ant.Polar.:	Horizontal		

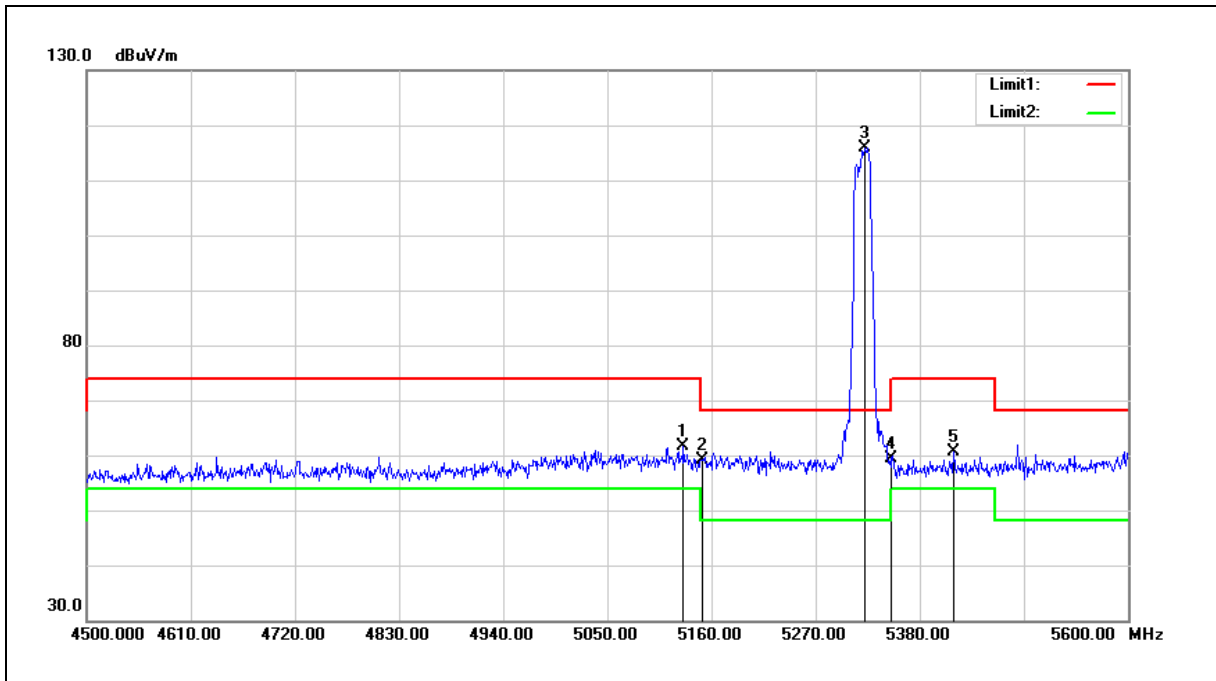

No.	Frequency (MHz)	Reading (dBuV)	Correct Factor (dB/m)	Result (dBuV/m)	Limit (dBuV/m)	Margin (dB)	Remark
1	5130.300	61.81	-0.12	61.69	74.00	-12.31	peak
2	5150.000	59.24	-0.08	59.16	74.00	-14.84	peak
3	5321.700	115.61	0.24	115.85	--	--	peak
4	5350.000	59.09	0.30	59.39	74.00	-14.61	peak
5	5416.300	60.14	0.41	60.55	74.00	-13.45	peak

Note:1.Result (dBuV/m) = Correct Factor (dB/m) + Reading(dBuV).

2.Correction factor (dB/m) = Antenna Factor (dB/m) + Cable loss (dB) – Pre-Amplifier gain (dB).

3.When the peak results are less than average limit, so not need to evaluate the average.

Standard:	FCC Part 15.407	Test Distance:	3 m
Test item:	Band edge		
Frequency:	5320 MHz		
Mode:	Mode 2		
Ant.Polar.:	Vertical		

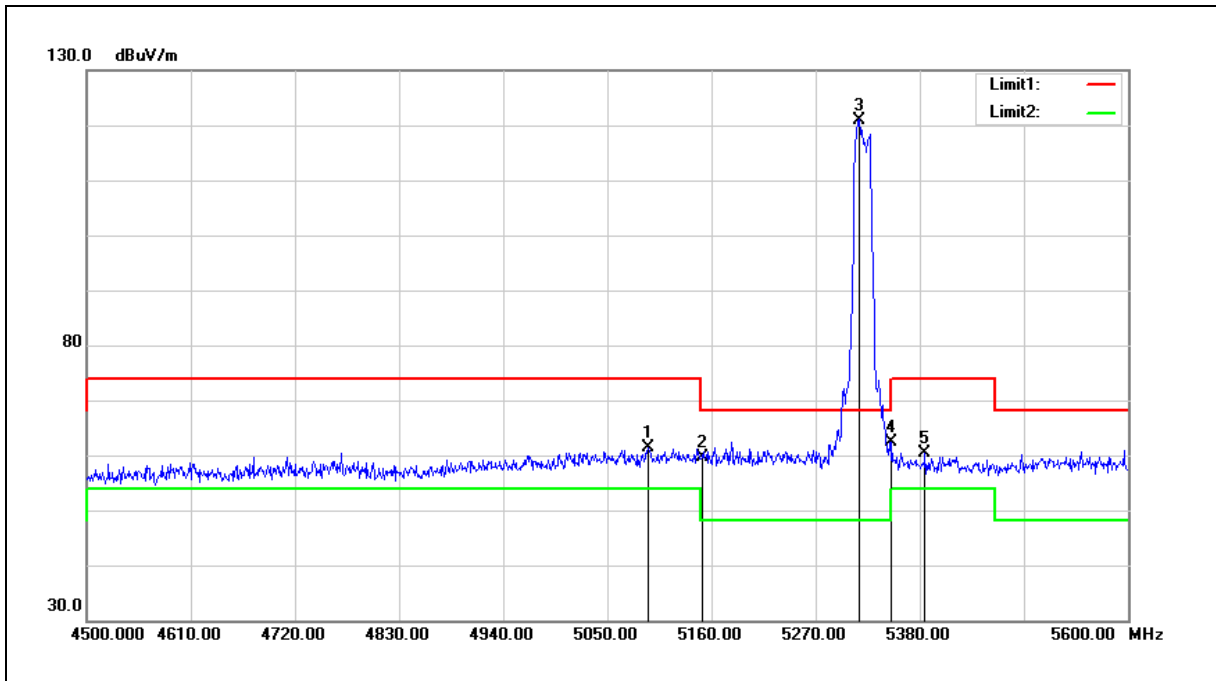

No.	Frequency (MHz)	Reading (dBuV)	Correct Factor (dB/m)	Result (dBuV/m)	Limit (dBuV/m)	Margin (dB)	Remark
1	5092.900	61.47	-0.19	61.28	74.00	-12.72	peak
2	5150.000	59.76	-0.08	59.68	74.00	-14.32	peak
3	5316.200	120.77	0.23	121.00	--	--	peak
4	5350.000	62.18	0.30	62.48	74.00	-11.52	peak
5	5385.500	60.09	0.36	60.45	74.00	-13.55	peak

Note:1.Result (dBuV/m) = Correct Factor (dB/m) + Reading(dBuV).

2.Correction factor (dB/m) = Antenna Factor (dB/m) + Cable loss (dB) – Pre-Amplifier gain (dB).

3.When the peak results are less than average limit, so not need to evaluate the average.

Standard:	FCC Part 15.407	Test Distance:	3 m
Test item:	Band edge		
Frequency:	5500 MHz		
Mode:	Mode 2		
Ant.Polar.:	Horizontal		

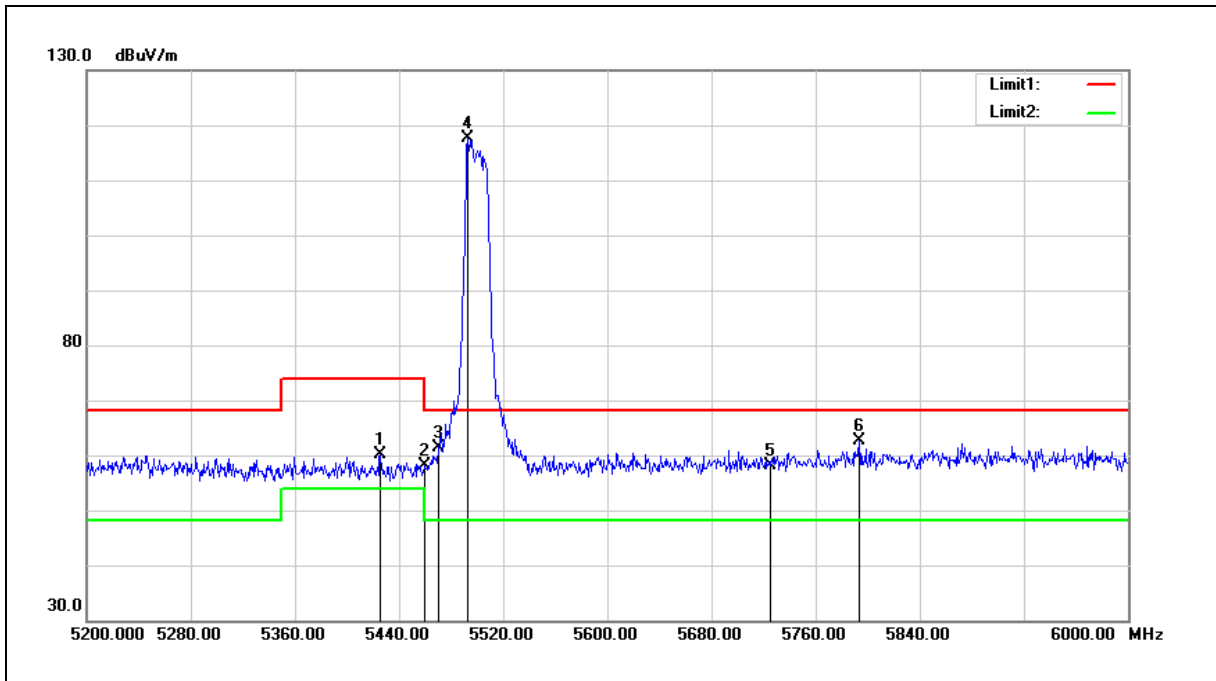

No.	Frequency (MHz)	Reading (dBuV)	Correct Factor (dB/m)	Result (dBuV/m)	Limit (dBuV/m)	Margin (dB)	Remark
1	5425.600	59.81	0.43	60.24	74.00	-13.76	peak
2	5460.000	57.58	0.51	58.09	74.00	-15.91	peak
3	5470.000	60.79	0.52	61.31	68.20	-6.89	peak
4	5492.800	117.03	0.56	117.59	--	--	peak
5	5725.000	56.85	1.18	58.03	68.20	-10.17	peak
6	5793.600	61.17	1.36	62.53	68.20	-5.67	peak

Note: 1. Result (dBuV/m) = Correct Factor (dB/m) + Reading(dBuV).

2. Correction factor (dB/m) = Antenna Factor (dB/m) + Cable loss (dB) – Pre-Amplifier gain (dB).

3. When the peak results are less than average limit, so not need to evaluate the average.

Standard:	FCC Part 15.407	Test Distance:	3 m
Test item:	Band edge		
Frequency:	5500 MHz		
Mode:	Mode 2		
Ant.Polar.:	Vertical		

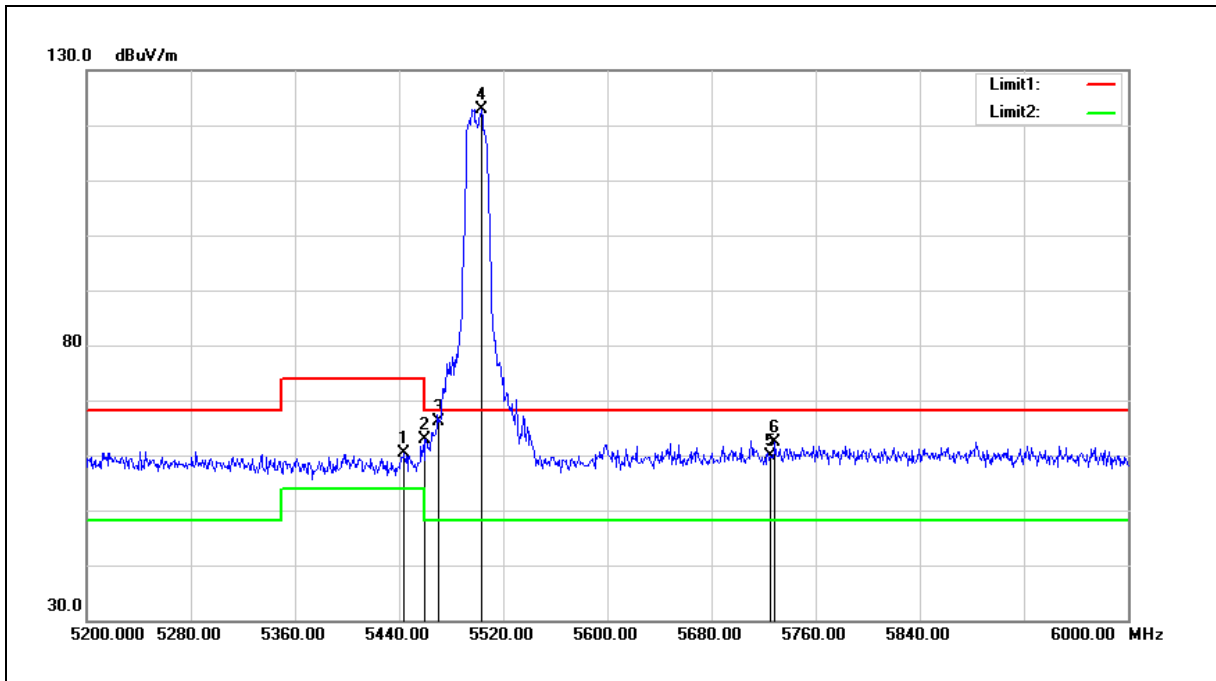

No.	Frequency (MHz)	Reading (dBuV)	Correct Factor (dB/m)	Result (dBuV/m)	Limit (dBuV/m)	Margin (dB)	Remark
1	5444.000	59.94	0.47	60.41	74.00	-13.59	peak
2	5460.000	62.28	0.51	62.79	74.00	-11.21	peak
3	5470.000	65.62	0.52	66.14	68.20	-2.06	peak
4	5503.200	122.35	0.58	122.93	--	--	peak
5	5725.000	58.71	1.18	59.89	68.20	-8.31	peak
6	5728.800	61.20	1.18	62.38	68.20	-5.82	peak

Note:1.Result (dBuV/m) = Correct Factor (dB/m) + Reading(dBuV).

2.Correction factor (dB/m) = Antenna Factor (dB/m) + Cable loss (dB) – Pre-Amplifier gain (dB).

3.When the peak results are less than average limit, so not need to evaluate the average.

Standard:	FCC Part 15.407	Test Distance:	3 m
Test item:	Band edge		
Frequency:	5560 MHz		
Mode:	Mode 2		
Ant.Polar.:	Horizontal		

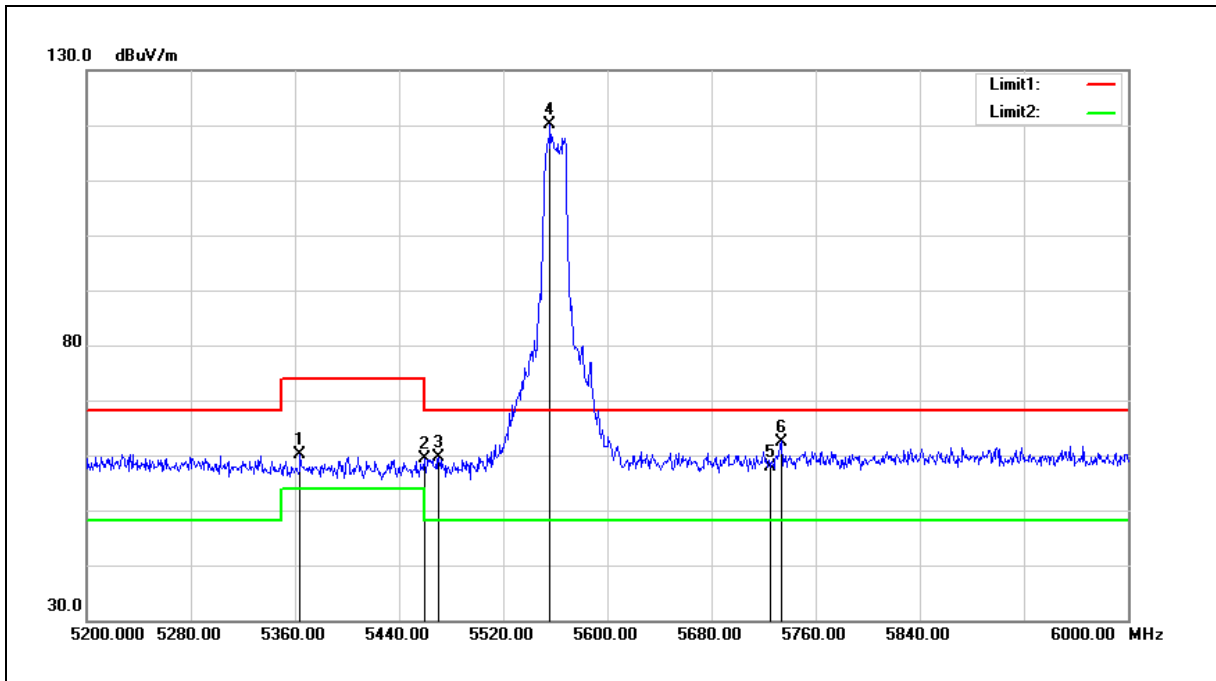

No.	Frequency (MHz)	Reading (dBuV)	Correct Factor (dB/m)	Result (dBuV/m)	Limit (dBuV/m)	Margin (dB)	Remark
1	5364.000	59.79	0.32	60.11	74.00	-13.89	peak
2	5460.000	58.75	0.51	59.26	74.00	-14.74	peak
3	5470.000	59.16	0.52	59.68	68.20	-8.52	peak
4	5556.000	119.50	0.73	120.23	--	--	peak
5	5725.000	56.61	1.18	57.79	68.20	-10.41	peak
6	5733.600	61.29	1.21	62.50	68.20	-5.70	peak

Note: 1. Result (dBuV/m) = Correct Factor (dB/m) + Reading(dBuV).

2. Correction factor (dB/m) = Antenna Factor (dB/m) + Cable loss (dB) – Pre-Amplifier gain (dB).

3. When the peak results are less than average limit, so not need to evaluate the average.

Standard:	FCC Part 15.407	Test Distance:	3 m
Test item:	Band edge		
Frequency:	5560 MHz		
Mode:	Mode 2		
Ant.Polar.:	Vertical		

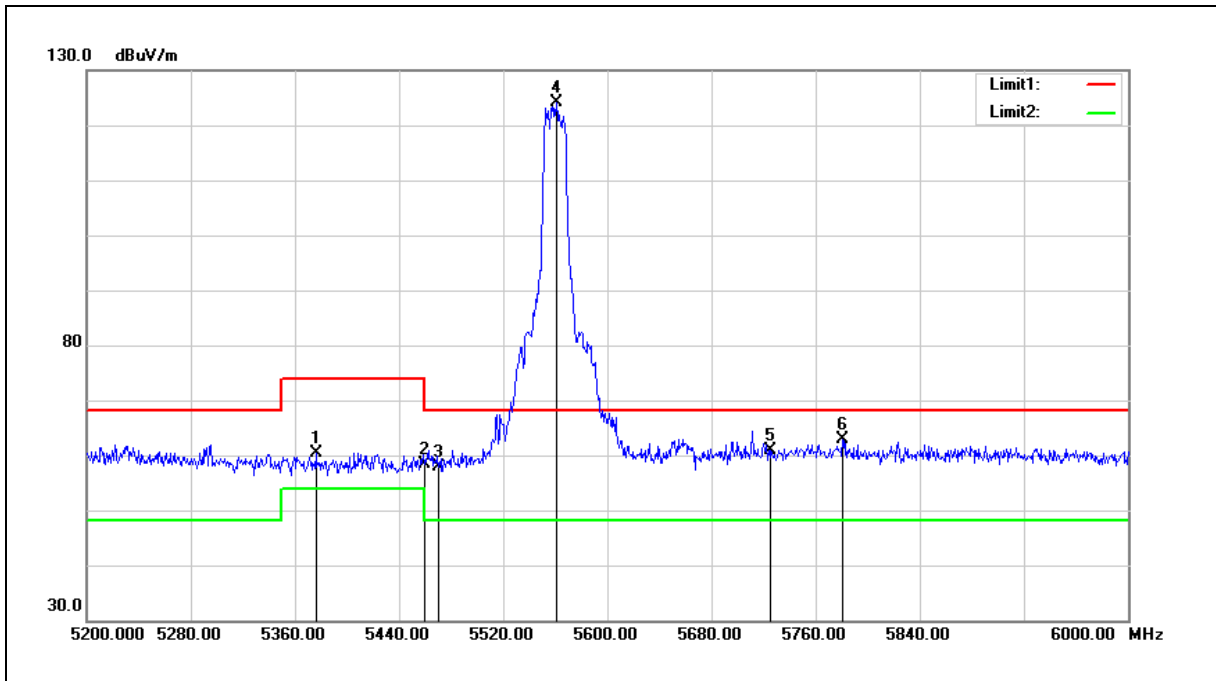

No.	Frequency (MHz)	Reading (dBuV)	Correct Factor (dB/m)	Result (dBuV/m)	Limit (dBuV/m)	Margin (dB)	Remark
1	5376.000	60.13	0.34	60.47	74.00	-13.53	peak
2	5460.000	57.82	0.51	58.33	74.00	-15.67	peak
3	5470.000	57.47	0.52	57.99	68.20	-10.21	peak
4	5560.800	123.36	0.74	124.10	--	--	peak
5	5725.000	59.81	1.18	60.99	68.20	-7.21	peak
6	5780.800	61.53	1.33	62.86	68.20	-5.34	peak

Note: 1. Result (dBuV/m) = Correct Factor (dB/m) + Reading(dBuV).

2. Correction factor (dB/m) = Antenna Factor (dB/m) + Cable loss (dB) – Pre-Amplifier gain (dB).

3. When the peak results are less than average limit, so not need to evaluate the average.

Standard:	FCC Part 15.407	Test Distance:	3 m
Test item:	Band edge		
Frequency:	5700 MHz		
Mode:	Mode 2		
Ant.Polar.:	Horizontal		

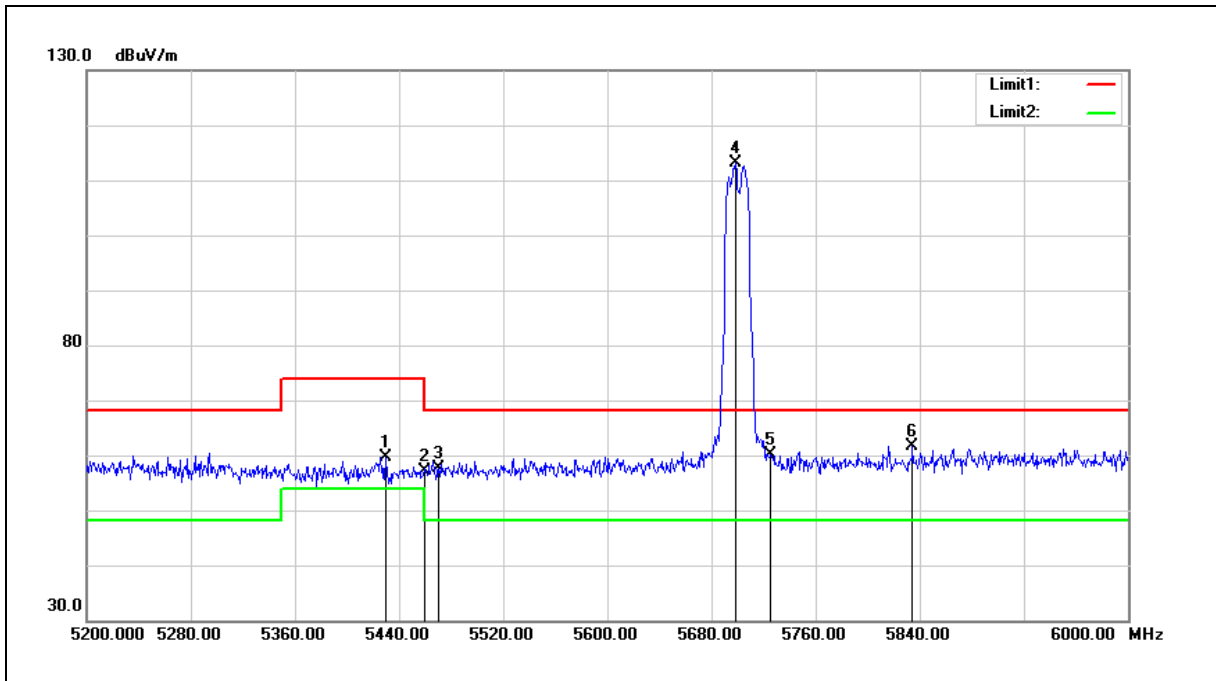

No.	Frequency (MHz)	Reading (dBuV)	Correct Factor (dB/m)	Result (dBuV/m)	Limit (dBuV/m)	Margin (dB)	Remark
1	5429.600	59.30	0.44	59.74	74.00	-14.26	peak
2	5460.000	56.60	0.51	57.11	74.00	-16.89	peak
3	5470.000	57.11	0.52	57.63	68.20	-10.57	peak
4	5698.400	112.13	1.11	113.24	--	--	peak
5	5725.000	58.93	1.18	60.11	68.20	-8.09	peak
6	5834.400	60.26	1.47	61.73	68.20	-6.47	peak

Note: 1. Result (dBuV/m) = Correct Factor (dB/m) + Reading(dBuV).

2. Correction factor (dB/m) = Antenna Factor (dB/m) + Cable loss (dB) – Pre-Amplifier gain (dB).

3. When the peak results are less than average limit, so not need to evaluate the average.

Standard:	FCC Part 15.407	Test Distance:	3 m
Test item:	Band edge		
Frequency:	5700 MHz		
Mode:	Mode 2		
Ant.Polar.:	Vertical		

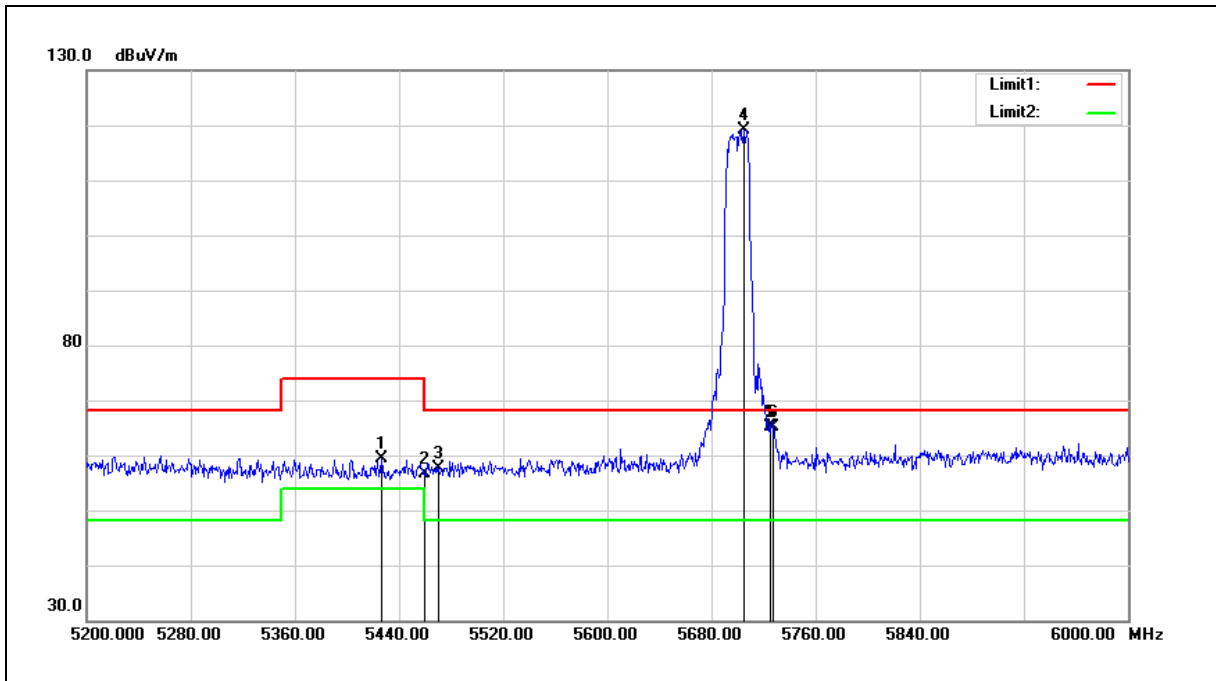

No.	Frequency (MHz)	Reading (dBuV)	Correct Factor (dB/m)	Result (dBuV/m)	Limit (dBuV/m)	Margin (dB)	Remark
1	5426.400	58.85	0.43	59.28	74.00	-14.72	peak
2	5460.000	56.15	0.51	56.66	74.00	-17.34	peak
3	5470.000	57.10	0.52	57.62	68.20	-10.58	peak
4	5704.800	118.09	1.13	119.22	--	--	peak
5	5725.000	63.97	1.18	65.15	68.20	-3.05	peak
6	5727.200	63.93	1.18	65.11	68.20	-3.09	peak

Note: 1. Result (dBuV/m) = Correct Factor (dB/m) + Reading(dBuV).

2. Correction factor (dB/m) = Antenna Factor (dB/m) + Cable loss (dB) – Pre-Amplifier gain (dB).

3. When the peak results are less than average limit, so not need to evaluate the average.

Standard:	FCC Part 15.407	Test Distance:	3 m
Test item:	Band edge		
Frequency:	5745 MHz		
Mode:	Mode 2		
Ant.Polar.:	Horizontal		

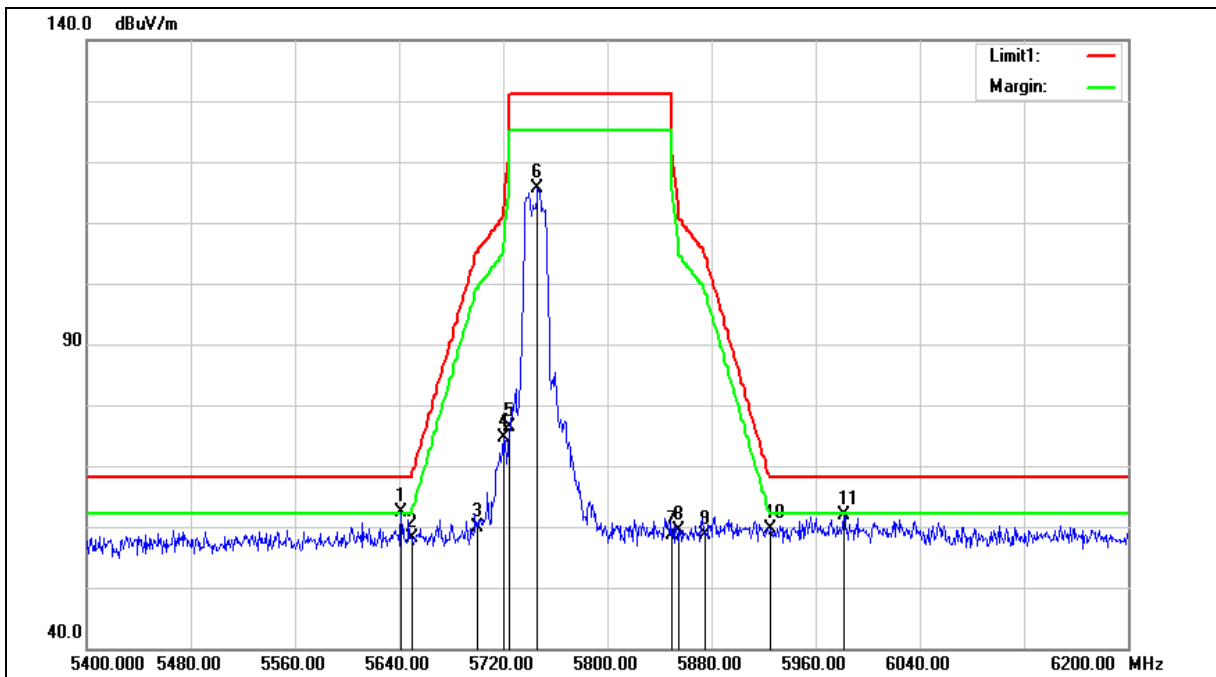

Standard:	FCC Part 15.407	Test Distance:	3 m
Test item:	Band edge		
Frequency:	5745 MHz		
Mode:	Mode 2		
Ant.Polar.:	Horizontal		

No.	Frequency (MHz)	Reading (dBuV)	Correct Factor (dB/m)	Result (dBuV/m)	Limit (dBuV/m)	Margin (dB)	Remark
1	5641.600	61.35	0.96	62.31	68.20	-5.89	peak
2	5650.000	57.28	0.97	58.25	68.20	-9.95	peak
3	5700.000	58.86	1.11	59.97	105.20	-45.23	peak
4	5720.000	73.34	1.17	74.51	110.80	-36.29	peak
5	5725.000	75.25	1.18	76.43	122.20	-45.77	peak
6	5746.400	114.41	1.24	115.65	--	--	peak
7	5850.000	57.03	1.52	58.55	122.20	-63.65	peak
8	5855.000	57.91	1.53	59.44	110.80	-51.36	peak
9	5875.000	56.97	1.59	58.56	105.20	-46.64	peak
10	5925.000	57.81	1.72	59.53	68.20	-8.67	peak
11	5981.600	59.97	1.88	61.85	68.20	-6.35	peak

Note:1.Result (dBuV/m) = Correct Factor (dB/m) + Reading(dBuV).

2.Correction factor (dB/m) = Antenna Factor (dB/m) + Cable loss (dB) – Pre-Amplifier gain (dB).

3.When the peak results are less than average limit, so not need to evaluate the average.

Standard:	FCC Part 15.407	Test Distance:	3 m
Test item:	Band edge		
Frequency:	5745 MHz		
Mode:	Mode 2		
Ant.Polar.:	Vertical		

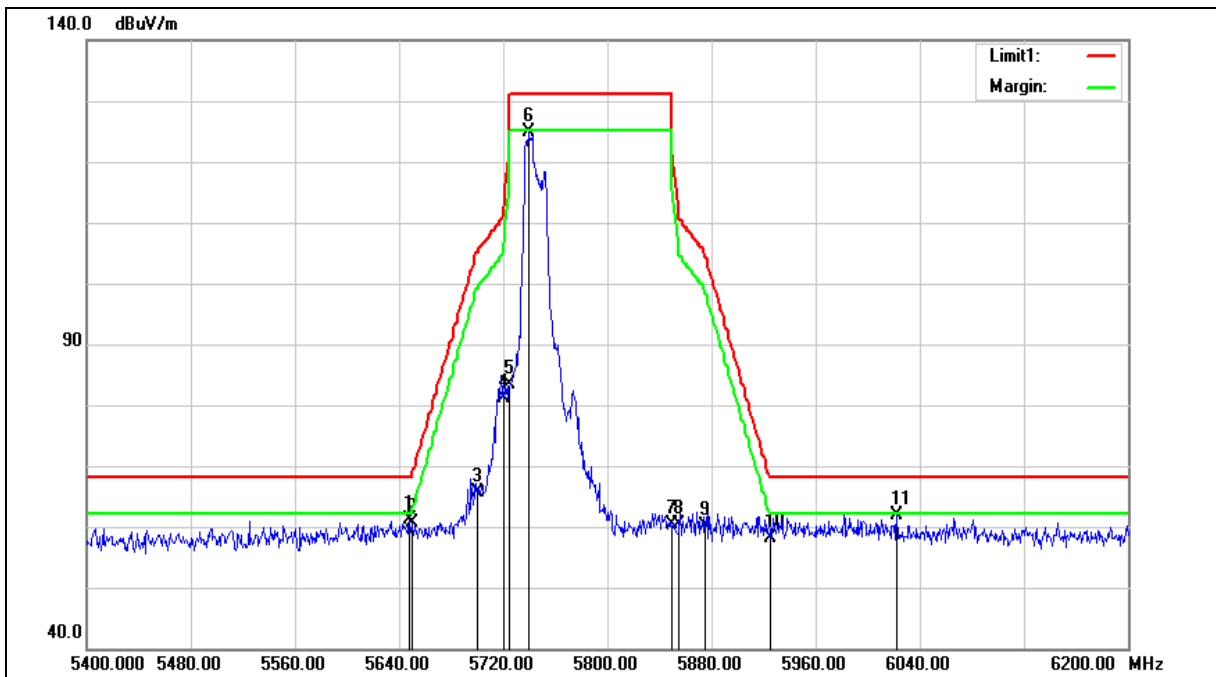

Standard:	FCC Part 15.407	Test Distance:	3 m
Test item:	Band edge		
Frequency:	5745 MHz		
Mode:	Mode 2		
Ant.Polar.:	Vertical		

No.	Frequency (MHz)	Reading (dBuV)	Correct Factor (dB/m)	Result (dBuV/m)	Limit (dBuV/m)	Margin (dB)	Remark
1	5648.000	60.09	0.97	61.06	68.20	-7.14	peak
2	5650.000	59.58	0.97	60.55	68.20	-7.65	peak
3	5700.000	64.53	1.11	65.64	105.20	-39.56	peak
4	5720.000	79.97	1.17	81.14	110.80	-29.66	peak
5	5725.000	82.32	1.18	83.50	122.20	-38.70	peak
6	5739.200	123.56	1.22	124.78	--	--	peak
7	5850.000	58.86	1.52	60.38	122.20	-61.82	peak
8	5855.000	58.86	1.53	60.39	110.80	-50.41	peak
9	5875.000	58.50	1.59	60.09	105.20	-45.11	peak
10	5925.000	56.33	1.72	58.05	68.20	-10.15	peak
11	6022.400	59.98	2.01	61.99	68.20	-6.21	peak

Note:1.Result (dBuV/m) = Correct Factor (dB/m) + Reading(dBuV).

2.Correction factor (dB/m) = Antenna Factor (dB/m) + Cable loss (dB) – Pre-Amplifier gain (dB).

3.When the peak results are less than average limit, so not need to evaluate the average.

Standard:	FCC Part 15.407	Test Distance:	3 m
Test item:	Band edge		
Frequency:	5785 MHz		
Mode:	Mode 2		
Ant.Polar.:	Horizontal		

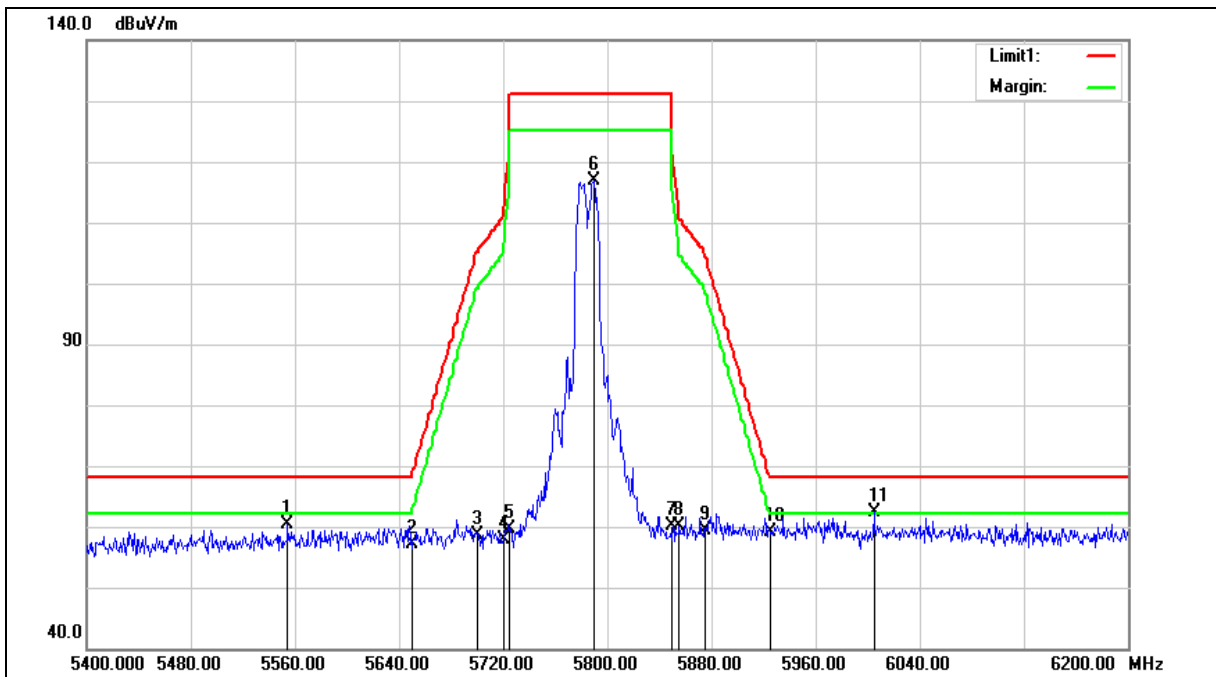

Standard:	FCC Part 15.407	Test Distance:	3 m
Test item:	Band edge		
Frequency:	5785 MHz		
Mode:	Mode 2		
Ant.Polar.:	Horizontal		

No.	Frequency (MHz)	Reading (dBuV)	Correct Factor (dB/m)	Result (dBuV/m)	Limit (dBuV/m)	Margin (dB)	Remark
1	5554.400	59.75	0.72	60.47	68.20	-7.73	peak
2	5650.000	56.13	0.97	57.10	68.20	-11.10	peak
3	5700.000	57.50	1.11	58.61	105.20	-46.59	peak
4	5720.000	56.66	1.17	57.83	110.80	-52.97	peak
5	5725.000	58.51	1.18	59.69	122.20	-62.51	peak
6	5789.600	115.40	1.36	116.76	--	--	peak
7	5850.000	58.49	1.52	60.01	122.20	-62.19	peak
8	5855.000	58.59	1.53	60.12	110.80	-50.68	peak
9	5875.000	57.75	1.59	59.34	105.20	-45.86	peak
10	5925.000	57.37	1.72	59.09	68.20	-9.11	peak
11	6004.800	60.45	1.93	62.38	68.20	-5.82	peak

Note:1.Result (dBuV/m) = Correct Factor (dB/m) + Reading(dBuV).

2.Correction factor (dB/m) = Antenna Factor (dB/m) + Cable loss (dB) – Pre-Amplifier gain (dB).

3.When the peak results are less than average limit, so not need to evaluate the average.

Standard:	FCC Part 15.407	Test Distance:	3 m
Test item:	Band edge		
Frequency:	5785 MHz		
Mode:	Mode 2		
Ant.Polar.:	Vertical		

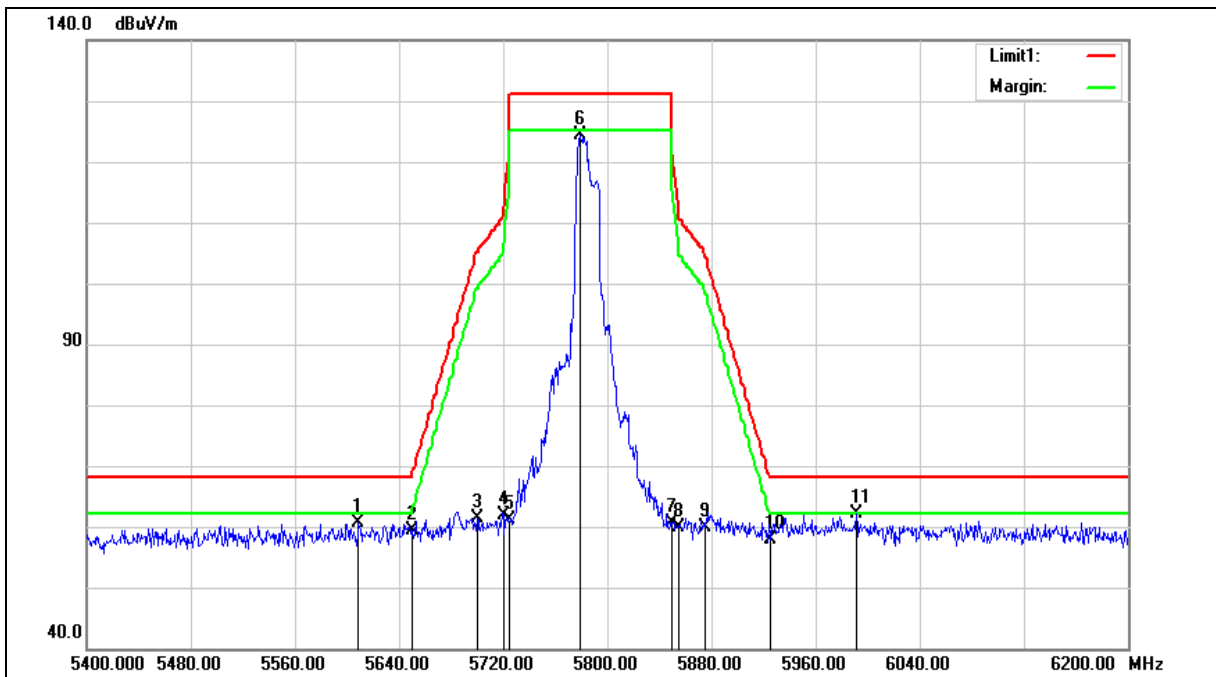

Standard:	FCC Part 15.407	Test Distance:	3 m
Test item:	Band edge		
Frequency:	5785 MHz		
Mode:	Mode 2		
Ant.Polar.:	Vertical		

No.	Frequency (MHz)	Reading (dBuV)	Correct Factor (dB/m)	Result (dBuV/m)	Limit (dBuV/m)	Margin (dB)	Remark
1	5608.800	59.84	0.86	60.70	68.20	-7.50	peak
2	5650.000	58.45	0.97	59.42	68.20	-8.78	peak
3	5700.000	60.19	1.11	61.30	105.20	-43.90	peak
4	5720.000	60.67	1.17	61.84	110.80	-48.96	peak
5	5725.000	60.05	1.18	61.23	122.20	-60.97	peak
6	5779.200	122.97	1.33	124.30	--	--	peak
7	5850.000	59.16	1.52	60.68	122.20	-61.52	peak
8	5855.000	58.32	1.53	59.85	110.80	-50.95	peak
9	5875.000	58.25	1.59	59.84	105.20	-45.36	peak
10	5925.000	56.04	1.72	57.76	68.20	-10.44	peak
11	5991.200	60.28	1.89	62.17	68.20	-6.03	peak

Note:1.Result (dBuV/m) = Correct Factor (dB/m) + Reading(dBuV).

2.Correction factor (dB/m) = Antenna Factor (dB/m) + Cable loss (dB) – Pre-Amplifier gain (dB).

3.When the peak results are less than average limit, so not need to evaluate the average.

Standard:	FCC Part 15.407	Test Distance:	3 m
Test item:	Band edge		
Frequency:	5825 MHz		
Mode:	Mode 2		
Ant.Polar.:	Horizontal		

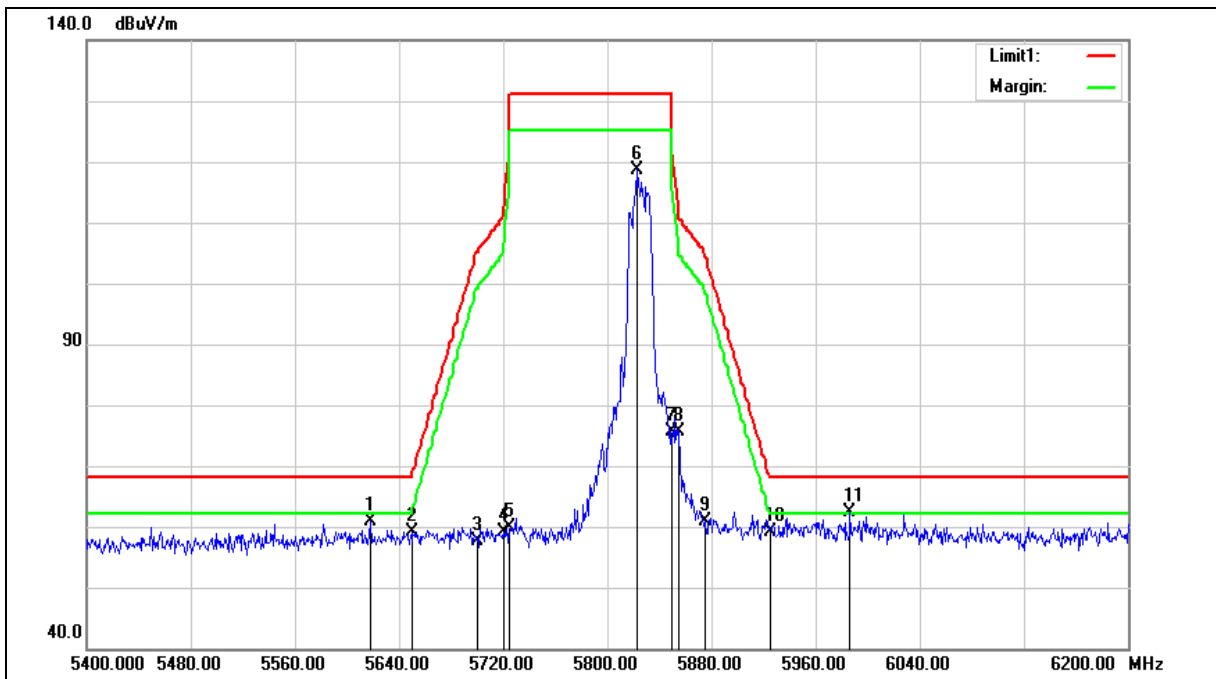

Standard:	FCC Part 15.407	Test Distance:	3 m
Test item:	Band edge		
Frequency:	5825 MHz		
Mode:	Mode 2		
Ant.Polar.:	Horizontal		

No.	Frequency (MHz)	Reading (dBuV)	Correct Factor (dB/m)	Result (dBuV/m)	Limit (dBuV/m)	Margin (dB)	Remark
1	5617.600	60.05	0.89	60.94	68.20	-7.26	peak
2	5650.000	58.06	0.97	59.03	68.20	-9.17	peak
3	5700.000	56.56	1.11	57.67	105.20	-47.53	peak
4	5720.000	57.97	1.17	59.14	110.80	-51.66	peak
5	5725.000	58.65	1.18	59.83	122.20	-62.37	peak
6	5822.400	117.06	1.45	118.51	--	--	peak
7	5850.000	74.11	1.52	75.63	122.20	-46.57	peak
8	5855.000	73.99	1.53	75.52	110.80	-35.28	peak
9	5875.000	59.37	1.59	60.96	105.20	-44.24	peak
10	5925.000	57.48	1.72	59.20	68.20	-9.00	peak
11	5986.400	60.61	1.88	62.49	68.20	-5.71	peak

Note:1.Result (dBuV/m) = Correct Factor (dB/m) + Reading(dBuV).

2.Correction factor (dB/m) = Antenna Factor (dB/m) + Cable loss (dB) – Pre-Amplifier gain (dB).

3.When the peak results are less than average limit, so not need to evaluate the average.

Standard:	FCC Part 15.407	Test Distance:	3 m
Test item:	Band edge		
Frequency:	5825 MHz		
Mode:	Mode 2		
Ant.Polar.:	Vertical		

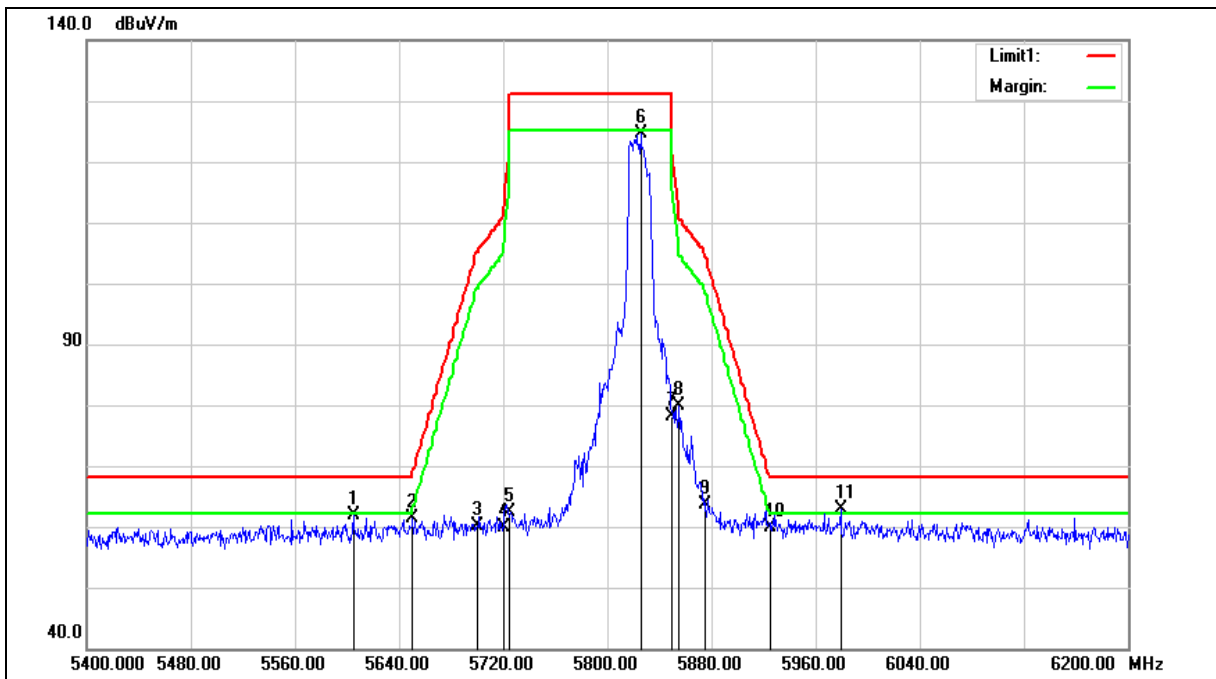

Standard:	FCC Part 15.407	Test Distance:	3 m
Test item:	Band edge		
Frequency:	5825 MHz		
Mode:	Mode 2		
Ant.Polar.:	Vertical		

No.	Frequency (MHz)	Reading (dBuV)	Correct Factor (dB/m)	Result (dBuV/m)	Limit (dBuV/m)	Margin (dB)	Remark
1	5604.800	60.95	0.86	61.81	68.20	-6.39	peak
2	5650.000	60.30	0.97	61.27	68.20	-6.93	peak
3	5700.000	58.92	1.11	60.03	105.20	-45.17	peak
4	5720.000	58.70	1.17	59.87	110.80	-50.93	peak
5	5725.000	61.16	1.18	62.34	122.20	-59.86	peak
6	5825.600	123.08	1.45	124.53	--	--	peak
7	5850.000	76.73	1.52	78.25	122.20	-43.95	peak
8	5855.000	78.38	1.53	79.91	110.80	-30.89	peak
9	5875.000	62.05	1.59	63.64	105.20	-41.56	peak
10	5925.000	58.22	1.72	59.94	68.20	-8.26	peak
11	5979.200	61.02	1.86	62.88	68.20	-5.32	peak

Note:1.Result (dBuV/m) = Correct Factor (dB/m) + Reading(dBuV).

2.Correction factor (dB/m) = Antenna Factor (dB/m) + Cable loss (dB) – Pre-Amplifier gain (dB).

3.When the peak results are less than average limit, so not need to evaluate the average.

Standard:	FCC Part 15.407	Test Distance:	3 m
Test item:	Band edge		
Frequency:	5180 MHz		
Mode:	Mode 8		
Ant.Polar.:	Horizontal		

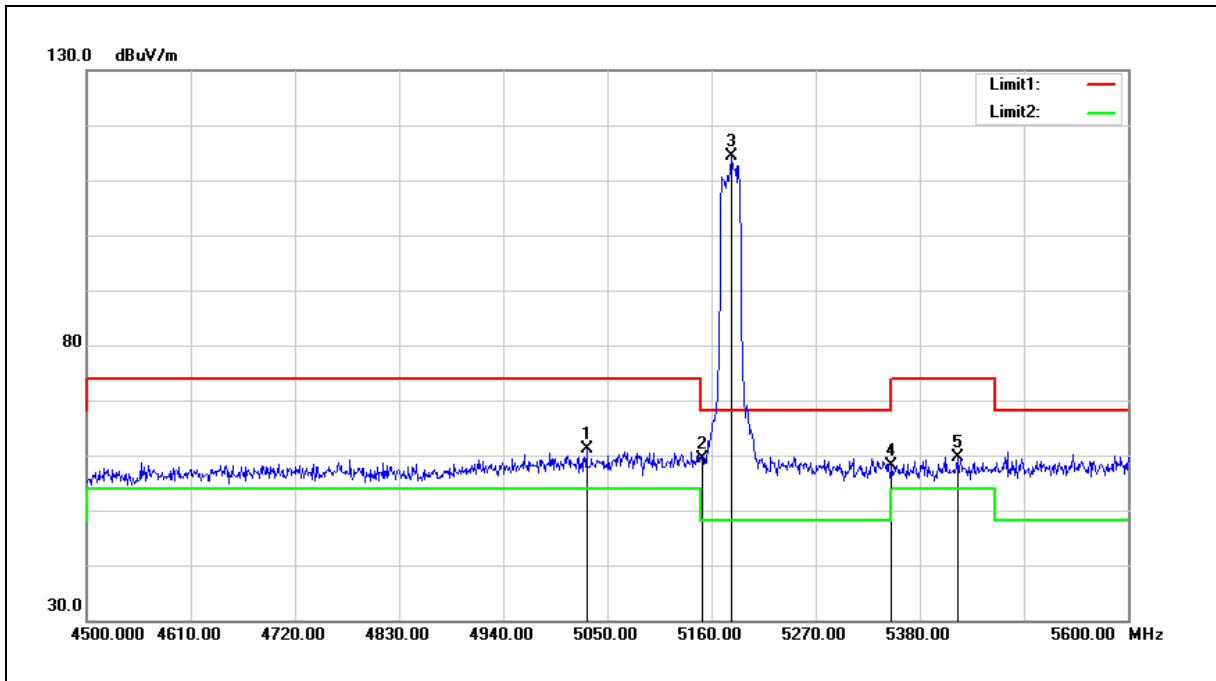

No.	Frequency (MHz)	Reading (dBuV)	Correct Factor (dB/m)	Result (dBuV/m)	Limit (dBuV/m)	Margin (dB)	Remark
1	5028.000	61.53	-0.31	61.22	74.00	-12.78	peak
2	5150.000	59.39	-0.08	59.31	74.00	-14.69	peak
3	5180.900	114.38	-0.03	114.35	--	--	peak
4	5350.000	57.88	0.30	58.18	74.00	-15.82	peak
5	5419.600	59.15	0.43	59.58	74.00	-14.42	peak

Note:1.Result (dBuV/m) = Correct Factor (dB/m) + Reading(dBuV).

2.Correction factor (dB/m) = Antenna Factor (dB/m) + Cable loss (dB) – Pre-Amplifier gain (dB).

3.When the peak results are less than average limit, so not need to evaluate the average.

Standard:	FCC Part 15.407	Test Distance:	3 m
Test item:	Band edge		
Frequency:	5180 MHz		
Mode:	Mode 8		
Ant.Polar.:	Vertical		

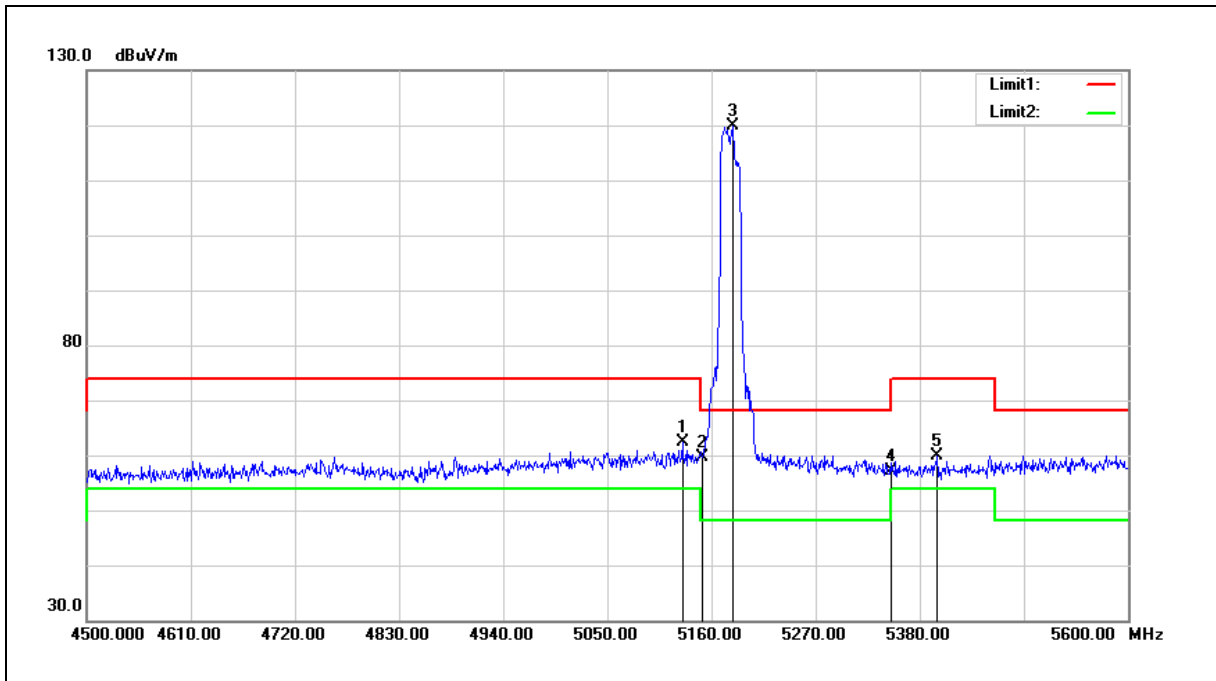

No.	Frequency (MHz)	Reading (dBuV)	Correct Factor (dB/m)	Result (dBuV/m)	Limit (dBuV/m)	Margin (dB)	Remark
1	5129.200	62.54	-0.13	62.41	74.00	-11.59	peak
2	5150.000	59.68	-0.08	59.60	74.00	-14.40	peak
3	5183.100	119.79	-0.02	119.77	--	--	peak
4	5350.000	56.82	0.30	57.12	74.00	-16.88	peak
5	5398.700	59.46	0.39	59.85	74.00	-14.15	peak

Note:1.Result (dBuV/m) = Correct Factor (dB/m) + Reading(dBuV).

2.Correction factor (dB/m) = Antenna Factor (dB/m) + Cable loss (dB) – Pre-Amplifier gain (dB).

3.When the peak results are less than average limit, so not need to evaluate the average.

Standard:	FCC Part 15.407	Test Distance:	3 m
Test item:	Band edge		
Frequency:	5200 MHz		
Mode:	Mode 8		
Ant.Polar.:	Horizontal		

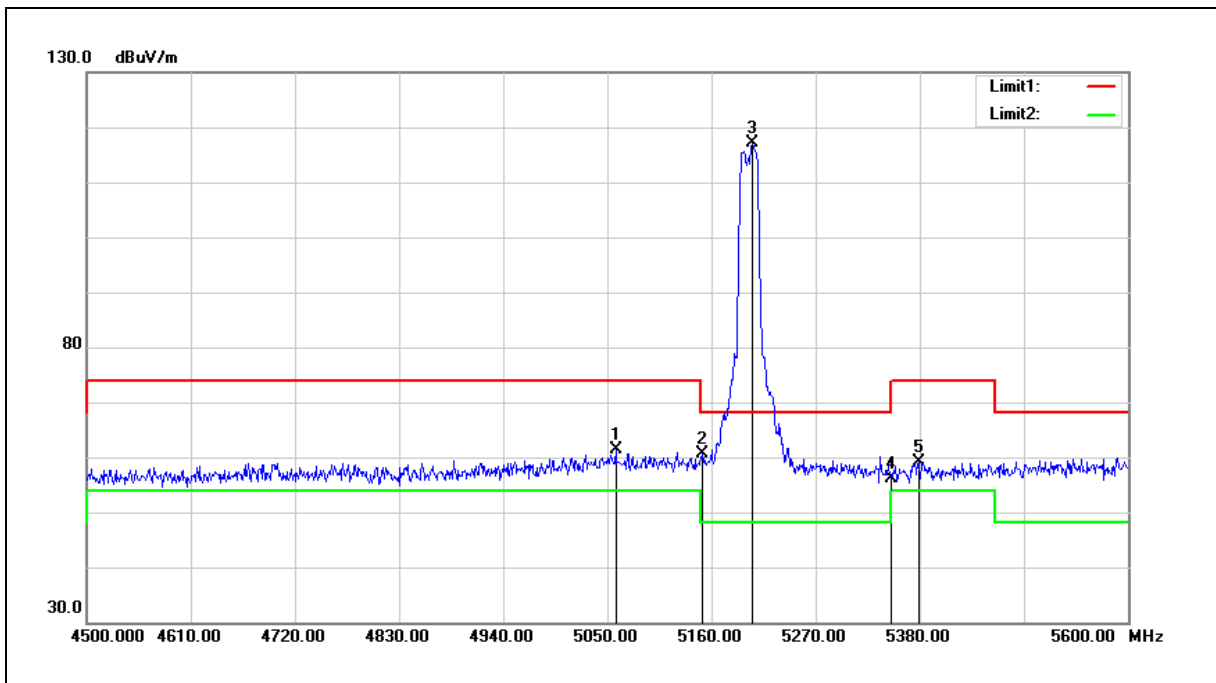

No.	Frequency (MHz)	Reading (dBuV)	Correct Factor (dB/m)	Result (dBuV/m)	Limit (dBuV/m)	Margin (dB)	Remark
1	5058.800	61.64	-0.25	61.39	74.00	-12.61	peak
2	5150.000	60.66	-0.08	60.58	74.00	-13.42	peak
3	5202.900	117.00	0.02	117.02	--	--	peak
4	5350.000	55.76	0.30	56.06	74.00	-17.94	peak
5	5378.900	58.66	0.35	59.01	74.00	-14.99	peak

Note:1.Result (dBuV/m) = Correct Factor (dB/m) + Reading(dBuV).

2.Correction factor (dB/m) = Antenna Factor (dB/m) + Cable loss (dB) – Pre-Amplifier gain (dB).

3.When the peak results are less than average limit, so not need to evaluate the average.

Standard:	FCC Part 15.407	Test Distance:	3 m
Test item:	Band edge		
Frequency:	5200 MHz		
Mode:	Mode 8		
Ant.Polar.:	Vertical		

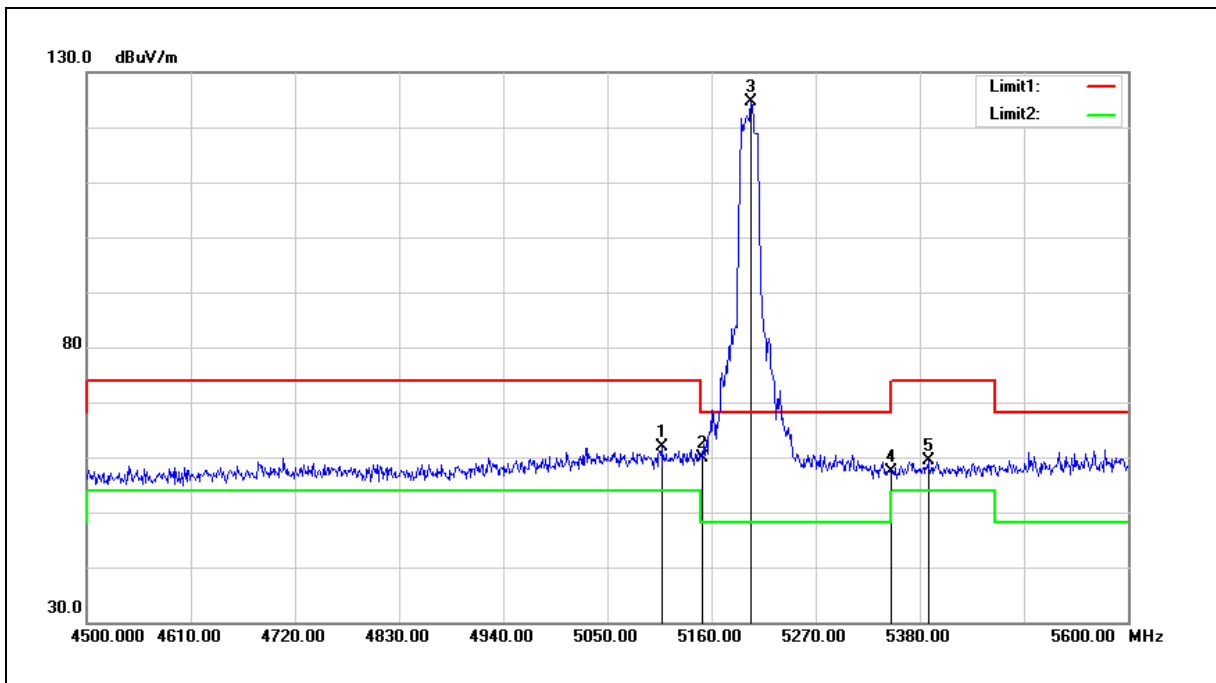

No.	Frequency (MHz)	Reading (dBuV)	Correct Factor (dB/m)	Result (dBuV/m)	Limit (dBuV/m)	Margin (dB)	Remark
1	5107.200	62.01	-0.15	61.86	74.00	-12.14	peak
2	5150.000	59.94	-0.08	59.86	74.00	-14.14	peak
3	5201.800	124.63	0.02	124.65	--	--	peak
4	5350.000	57.19	0.30	57.49	74.00	-16.51	peak
5	5388.800	59.08	0.36	59.44	74.00	-14.56	peak

Note:1.Result (dBuV/m) = Correct Factor (dB/m) + Reading(dBuV).

2.Correction factor (dB/m) = Antenna Factor (dB/m) + Cable loss (dB) – Pre-Amplifier gain (dB).

3.When the peak results are less than average limit, so not need to evaluate the average.

Standard:	FCC Part 15.407	Test Distance:	3 m
Test item:	Band edge		
Frequency:	5240 MHz		
Mode:	Mode 8		
Ant.Polar.:	Horizontal		

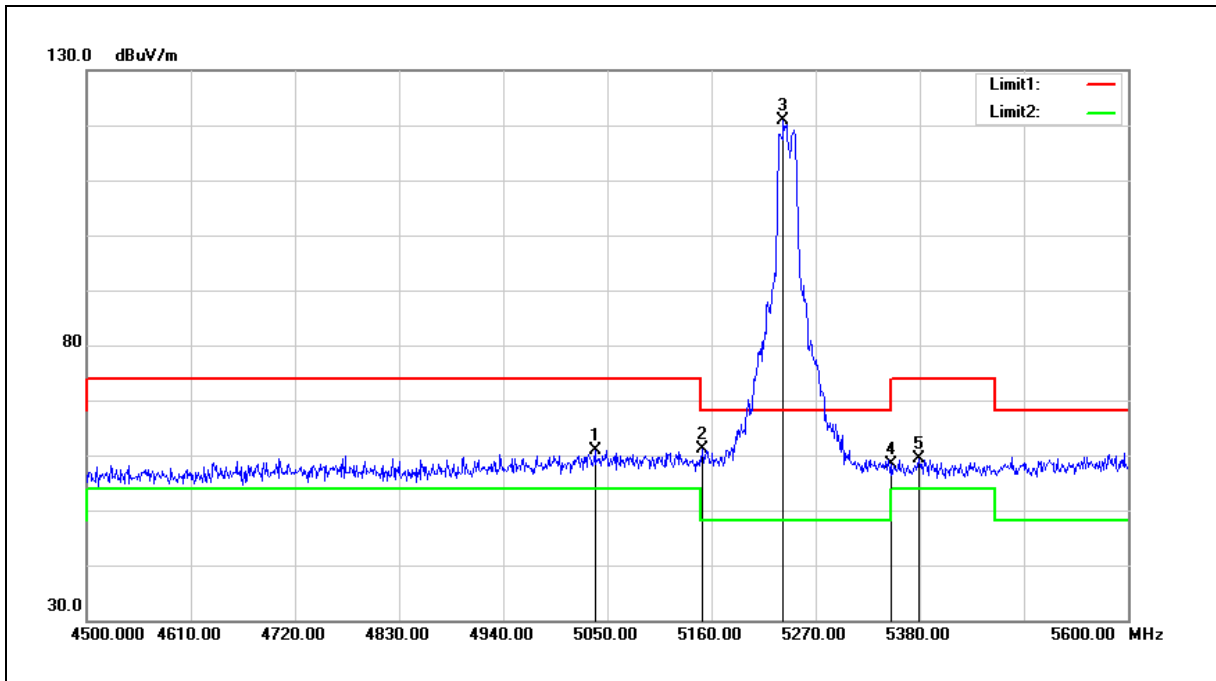

No.	Frequency (MHz)	Reading (dBuV)	Correct Factor (dB/m)	Result (dBuV/m)	Limit (dBuV/m)	Margin (dB)	Remark
1	5036.800	61.19	-0.29	60.90	74.00	-13.10	peak
2	5150.000	61.26	-0.08	61.18	74.00	-12.82	peak
3	5235.900	120.73	0.08	120.81	--	--	peak
4	5350.000	57.98	0.30	58.28	74.00	-15.72	peak
5	5378.900	58.92	0.35	59.27	74.00	-14.73	peak

Note:1.Result (dBuV/m) = Correct Factor (dB/m) + Reading(dBuV).

2.Correction factor (dB/m) = Antenna Factor (dB/m) + Cable loss (dB) – Pre-Amplifier gain (dB).

3.When the peak results are less than average limit, so not need to evaluate the average.

Standard:	FCC Part 15.407	Test Distance:	3 m
Test item:	Band edge		
Frequency:	5240 MHz		
Mode:	Mode 8		
Ant.Polar.:	Vertical		

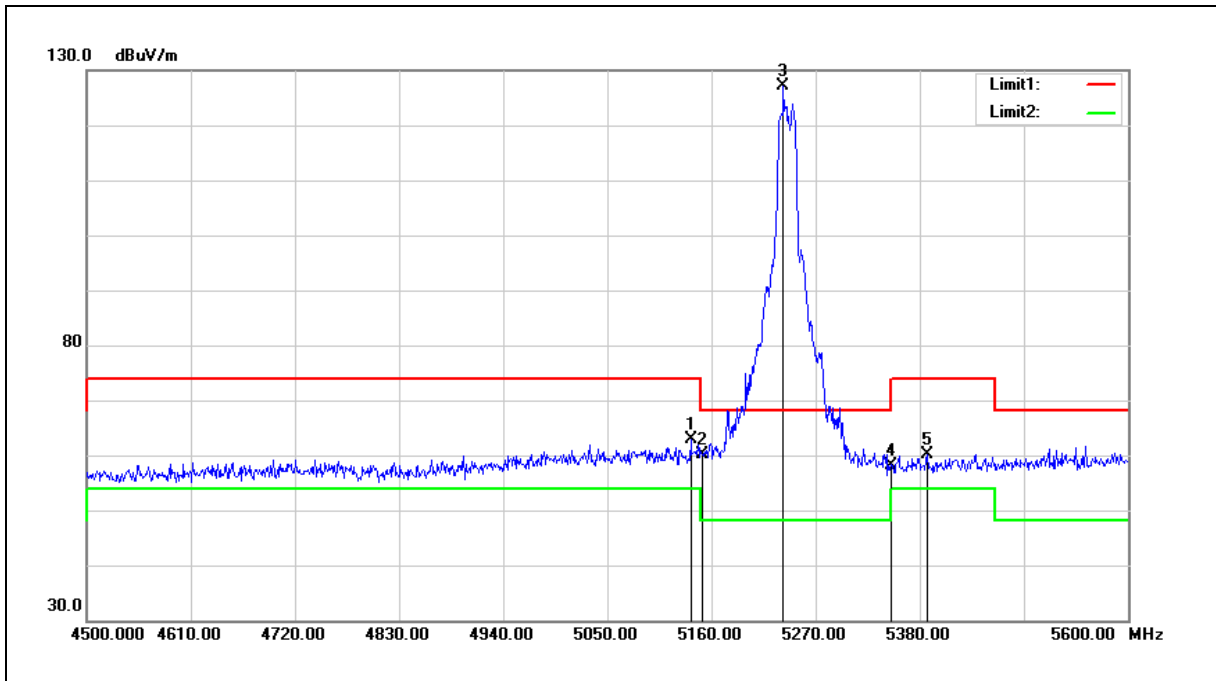

No.	Frequency (MHz)	Reading (dBuV)	Correct Factor (dB/m)	Result (dBuV/m)	Limit (dBuV/m)	Margin (dB)	Remark
1	5138.000	62.97	-0.10	62.87	74.00	-11.13	peak
2	5150.000	60.18	-0.08	60.10	74.00	-13.90	peak
3	5235.900	127.07	0.08	127.15	--	--	peak
4	5350.000	57.89	0.30	58.19	74.00	-15.81	peak
5	5387.700	59.76	0.36	60.12	74.00	-13.88	peak

Note:1.Result (dBuV/m) = Correct Factor (dB/m) + Reading(dBuV).

2.Correction factor (dB/m) = Antenna Factor (dB/m) + Cable loss (dB) – Pre-Amplifier gain (dB).

3.When the peak results are less than average limit, so not need to evaluate the average.

Standard:	FCC Part 15.407	Test Distance:	3 m
Test item:	Band edge		
Frequency:	5260 MHz		
Mode:	Mode 8		
Ant.Polar.:	Horizontal		

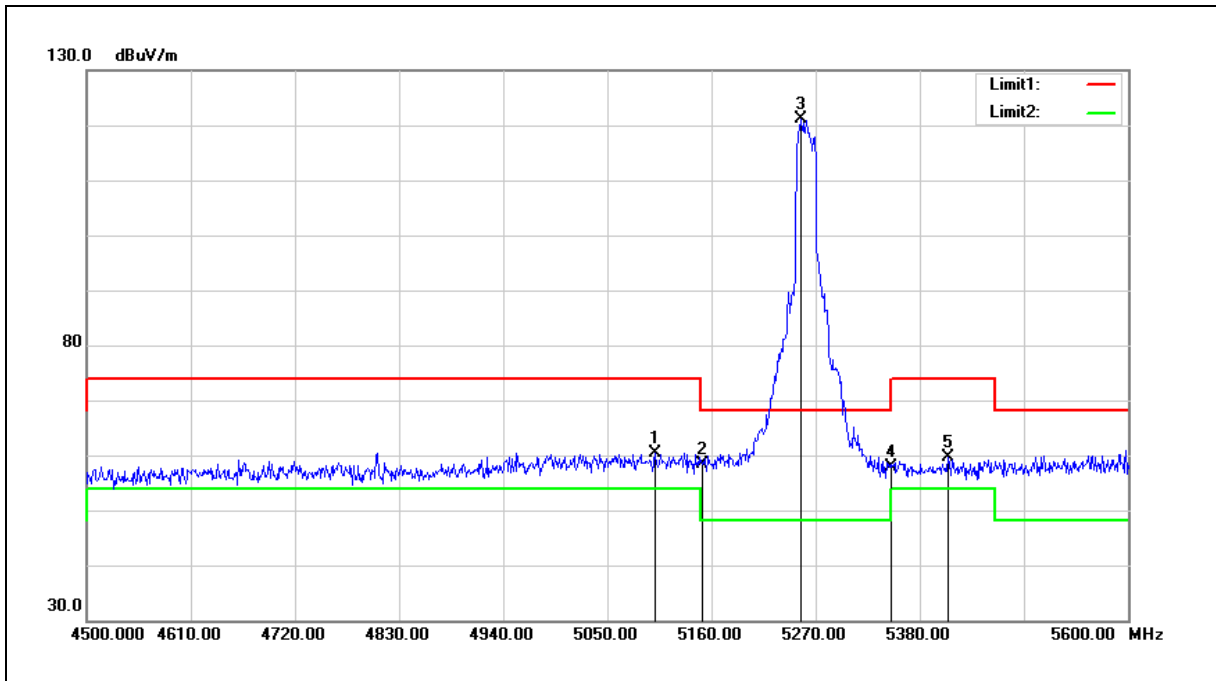

No.	Frequency (MHz)	Reading (dBuV)	Correct Factor (dB/m)	Result (dBuV/m)	Limit (dBuV/m)	Margin (dB)	Remark
1	5100.600	60.59	-0.18	60.41	74.00	-13.59	peak
2	5150.000	58.48	-0.08	58.40	74.00	-15.60	peak
3	5254.600	120.89	0.12	121.01	--	--	peak
4	5350.000	57.48	0.30	57.78	74.00	-16.22	peak
5	5409.700	59.18	0.41	59.59	74.00	-14.41	peak

Note:1.Result (dBuV/m) = Correct Factor (dB/m) + Reading(dBuV).

2.Correction factor (dB/m) = Antenna Factor (dB/m) + Cable loss (dB) – Pre-Amplifier gain (dB).

3.When the peak results are less than average limit, so not need to evaluate the average.

Standard:	FCC Part 15.407	Test Distance:	3 m
Test item:	Band edge		
Frequency:	5260 MHz		
Mode:	Mode 8		
Ant.Polar.:	Vertical		

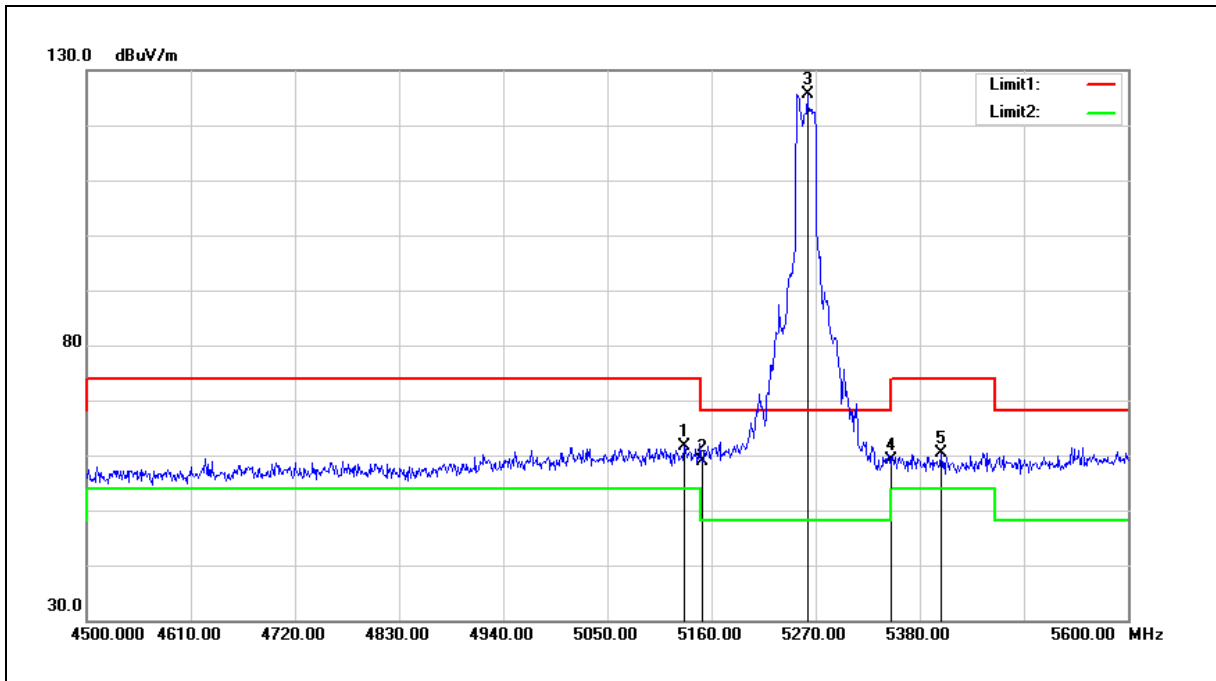

No.	Frequency (MHz)	Reading (dBuV)	Correct Factor (dB/m)	Result (dBuV/m)	Limit (dBuV/m)	Margin (dB)	Remark
1	5131.400	61.81	-0.11	61.70	74.00	-12.30	peak
2	5150.000	58.86	-0.08	58.78	74.00	-15.22	peak
3	5261.200	125.42	0.13	125.55	--	--	peak
4	5350.000	58.89	0.30	59.19	74.00	-14.81	peak
5	5402.000	60.02	0.39	60.41	74.00	-13.59	peak

Note:1.Result (dBuV/m) = Correct Factor (dB/m) + Reading(dBuV).

2.Correction factor (dB/m) = Antenna Factor (dB/m) + Cable loss (dB) – Pre-Amplifier gain (dB).

3.When the peak results are less than average limit, so not need to evaluate the average.

Standard:	FCC Part 15.407	Test Distance:	3 m
Test item:	Band edge		
Frequency:	5280 MHz		
Mode:	Mode 8		
Ant.Polar.:	Horizontal		

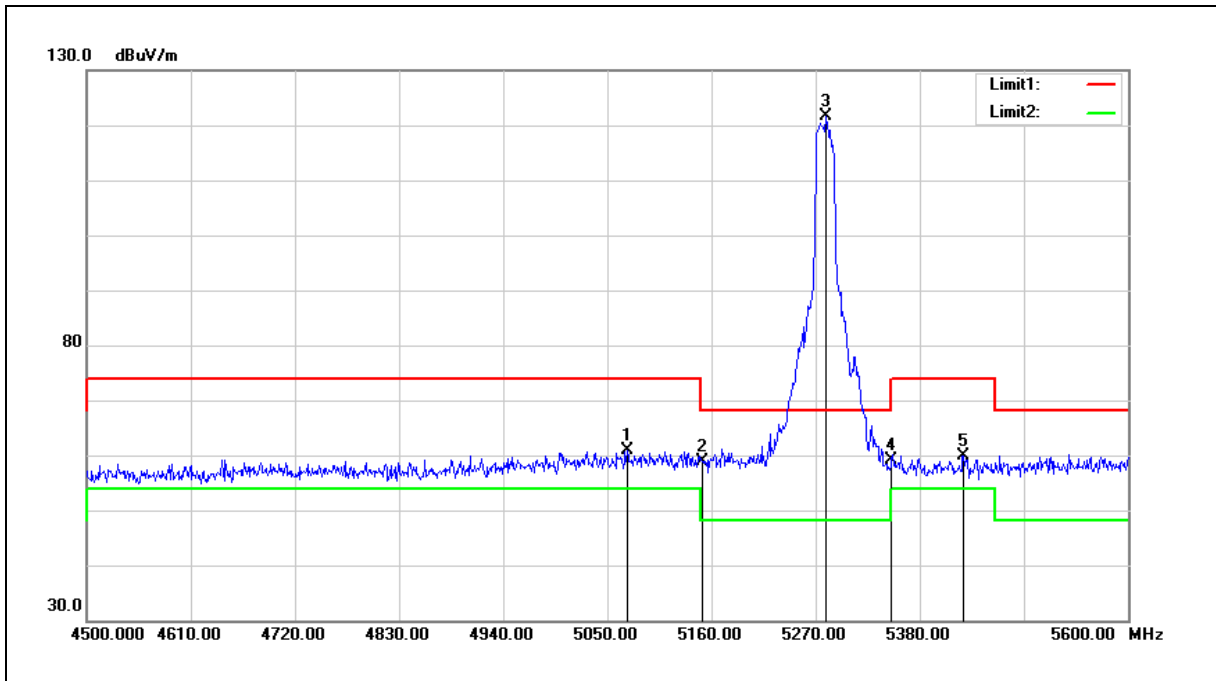

No.	Frequency (MHz)	Reading (dBuV)	Correct Factor (dB/m)	Result (dBuV/m)	Limit (dBuV/m)	Margin (dB)	Remark
1	5070.900	61.16	-0.23	60.93	74.00	-13.07	peak
2	5150.000	58.93	-0.08	58.85	74.00	-15.15	peak
3	5281.000	121.36	0.17	121.53	--	--	peak
4	5350.000	58.76	0.30	59.06	74.00	-14.94	peak
5	5426.200	59.49	0.43	59.92	74.00	-14.08	peak

Note:1.Result (dBuV/m) = Correct Factor (dB/m) + Reading(dBuV).

2.Correction factor (dB/m) = Antenna Factor (dB/m) + Cable loss (dB) – Pre-Amplifier gain (dB).

3.When the peak results are less than average limit, so not need to evaluate the average.

Standard:	FCC Part 15.407	Test Distance:	3 m
Test item:	Band edge		
Frequency:	5280 MHz		
Mode:	Mode 8		
Ant.Polar.:	Vertical		

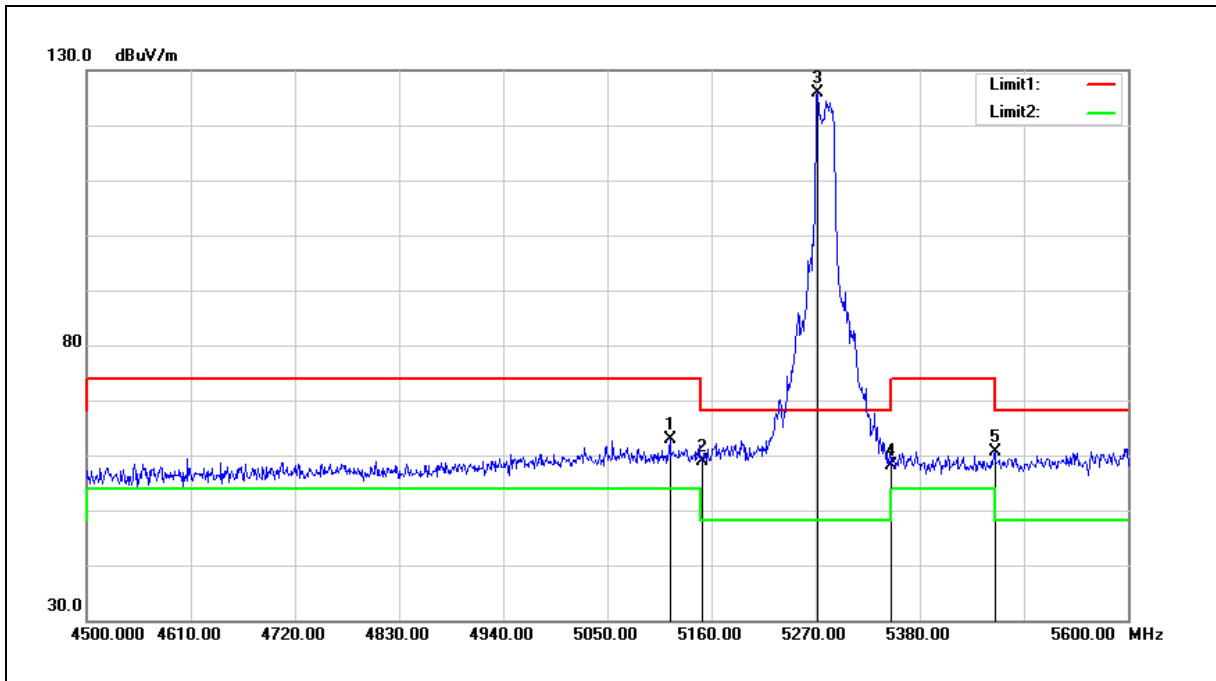

No.	Frequency (MHz)	Reading (dBuV)	Correct Factor (dB/m)	Result (dBuV/m)	Limit (dBuV/m)	Margin (dB)	Remark
1	5116.000	63.00	-0.15	62.85	74.00	-11.15	peak
2	5150.000	58.95	-0.08	58.87	74.00	-15.13	peak
3	5272.200	125.83	0.15	125.98	--	--	peak
4	5350.000	57.77	0.30	58.07	74.00	-15.93	peak
5	5459.200	60.23	0.51	60.74	74.00	-13.26	peak

Note:1.Result (dBuV/m) = Correct Factor (dB/m) + Reading(dBuV).

2.Correction factor (dB/m) = Antenna Factor (dB/m) + Cable loss (dB) – Pre-Amplifier gain (dB).

3.When the peak results are less than average limit, so not need to evaluate the average.

Standard:	FCC Part 15.407	Test Distance:	3 m
Test item:	Band edge		
Frequency:	5320 MHz		
Mode:	Mode 8		
Ant.Polar.:	Horizontal		

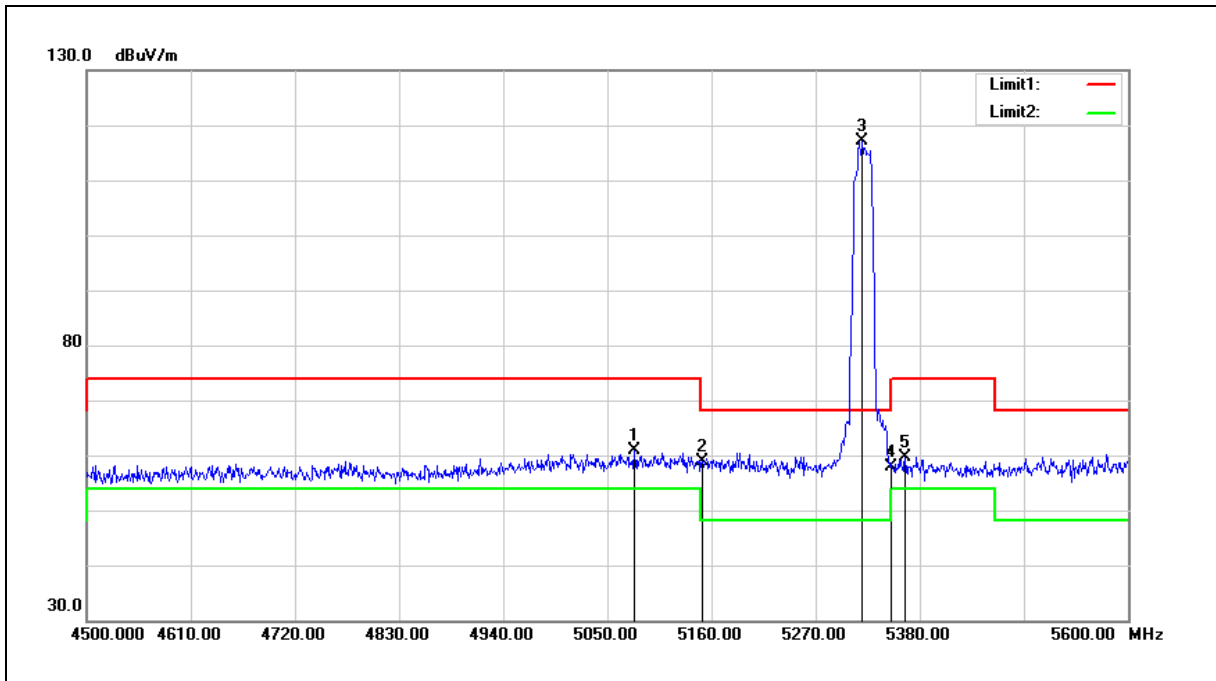

No.	Frequency (MHz)	Reading (dBuV)	Correct Factor (dB/m)	Result (dBuV/m)	Limit (dBuV/m)	Margin (dB)	Remark
1	5078.600	61.19	-0.21	60.98	74.00	-13.02	peak
2	5150.000	59.05	-0.08	58.97	74.00	-15.03	peak
3	5319.500	116.92	0.24	117.16	--	--	peak
4	5350.000	57.61	0.30	57.91	74.00	-16.09	peak
5	5364.600	59.41	0.32	59.73	74.00	-14.27	peak

Note:1.Result (dBuV/m) = Correct Factor (dB/m) + Reading(dBuV).

2.Correction factor (dB/m) = Antenna Factor (dB/m) + Cable loss (dB) – Pre-Amplifier gain (dB).

3.When the peak results are less than average limit, so not need to evaluate the average.

Standard:	FCC Part 15.407	Test Distance:	3 m
Test item:	Band edge		
Frequency:	5320 MHz		
Mode:	Mode 8		
Ant.Polar.:	Vertical		

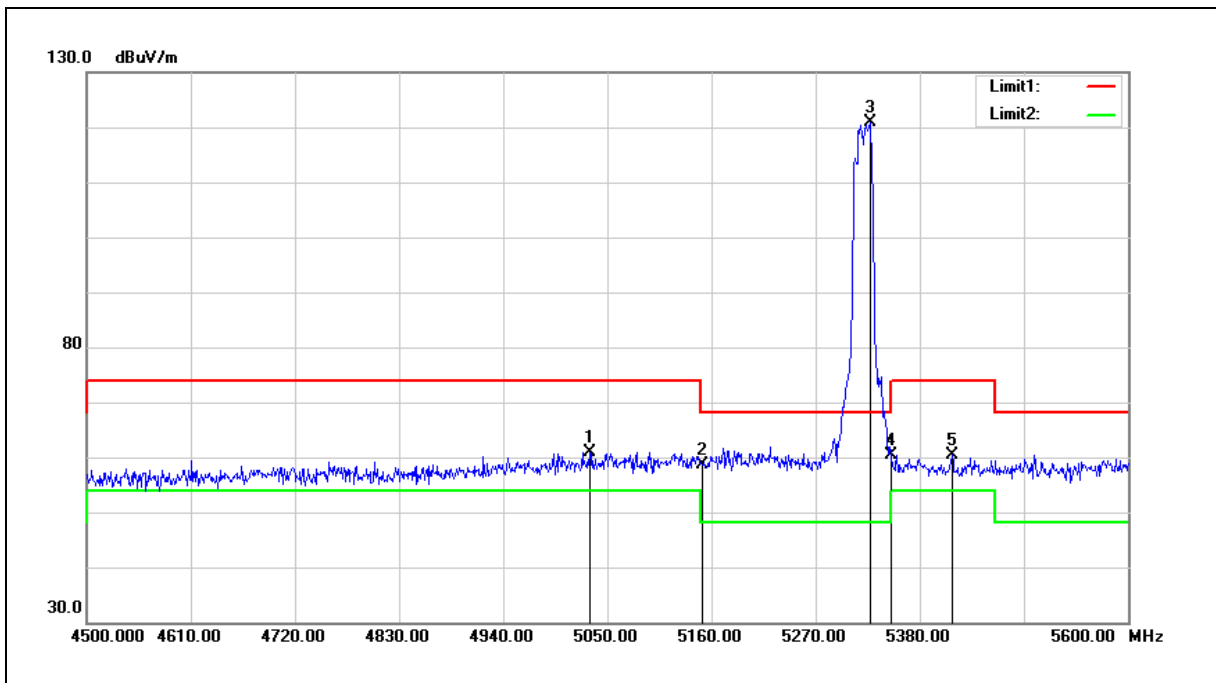

No.	Frequency (MHz)	Reading (dBuV)	Correct Factor (dB/m)	Result (dBuV/m)	Limit (dBuV/m)	Margin (dB)	Remark
1	5031.300	61.28	-0.30	60.98	74.00	-13.02	peak
2	5150.000	58.73	-0.08	58.65	74.00	-15.35	peak
3	5327.200	120.53	0.25	120.78	--	--	peak
4	5350.000	60.07	0.30	60.37	74.00	-13.63	peak
5	5414.100	59.91	0.41	60.32	74.00	-13.68	peak

Note:1.Result (dBuV/m) = Correct Factor (dB/m) + Reading(dBuV).

2.Correction factor (dB/m) = Antenna Factor (dB/m) + Cable loss (dB) – Pre-Amplifier gain (dB).

3.When the peak results are less than average limit, so not need to evaluate the average.

Standard:	FCC Part 15.407	Test Distance:	3 m
Test item:	Band edge		
Frequency:	5500 MHz		
Mode:	Mode 8		
Ant.Polar.:	Horizontal		

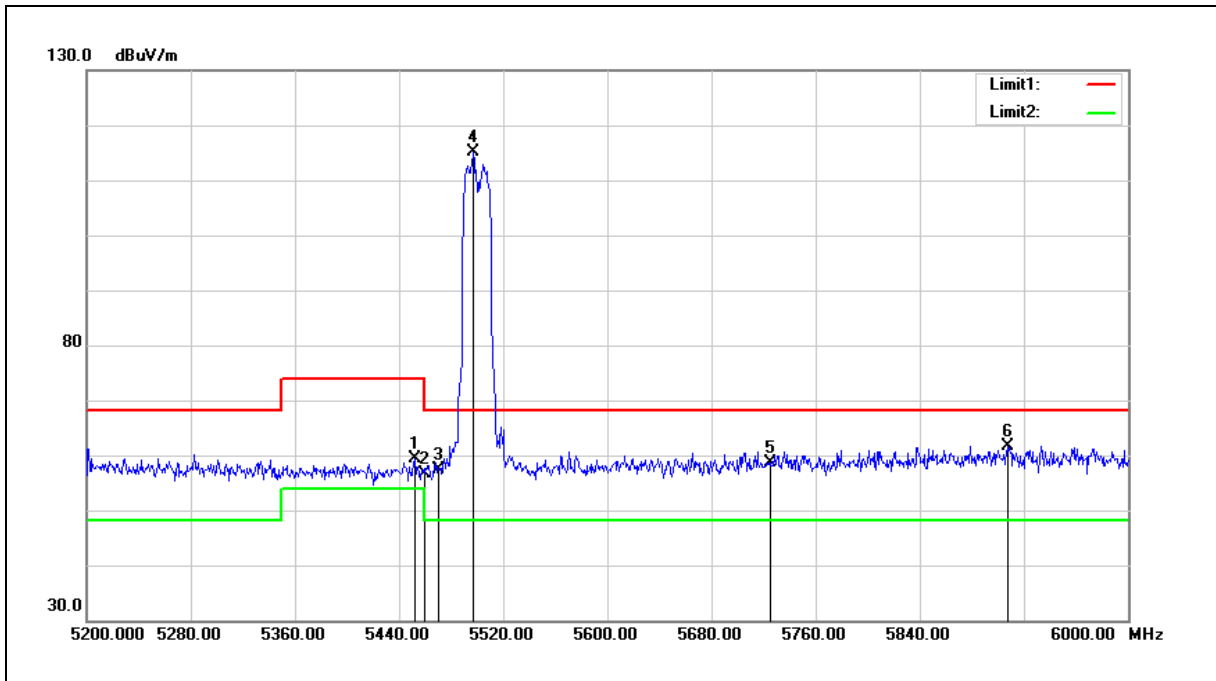

No.	Frequency (MHz)	Reading (dBuV)	Correct Factor (dB/m)	Result (dBuV/m)	Limit (dBuV/m)	Margin (dB)	Remark
1	5452.000	58.79	0.48	59.27	74.00	-14.73	peak
2	5460.000	56.17	0.51	56.68	74.00	-17.32	peak
3	5470.000	56.79	0.52	57.31	68.20	-10.89	peak
4	5496.800	114.47	0.57	115.04	--	--	peak
5	5725.000	57.36	1.18	58.54	68.20	-9.66	peak
6	5908.000	60.01	1.67	61.68	68.20	-6.52	peak

Note: 1. Result (dBuV/m) = Correct Factor (dB/m) + Reading(dBuV).

2. Correction factor (dB/m) = Antenna Factor (dB/m) + Cable loss (dB) – Pre-Amplifier gain (dB).

3. When the peak results are less than average limit, so not need to evaluate the average.

Standard:	FCC Part 15.407	Test Distance:	3 m
Test item:	Band edge		
Frequency:	5500 MHz		
Mode:	Mode 8		
Ant.Polar.:	Vertical		

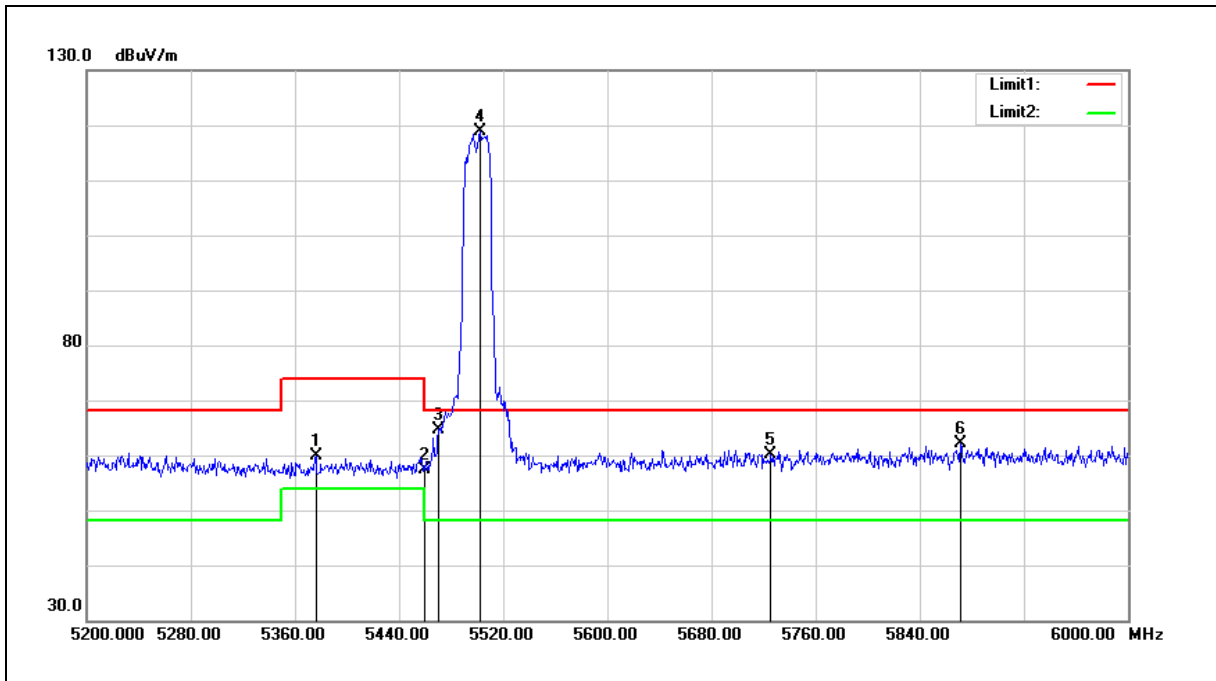

No.	Frequency (MHz)	Reading (dBuV)	Correct Factor (dB/m)	Result (dBuV/m)	Limit (dBuV/m)	Margin (dB)	Remark
1	5376.000	59.48	0.34	59.82	74.00	-14.18	peak
2	5460.000	56.91	0.51	57.42	74.00	-16.58	peak
3	5470.000	64.12	0.52	64.64	68.20	-3.56	peak
4	5502.400	118.40	0.58	118.98	--	--	peak
5	5725.000	58.89	1.18	60.07	68.20	-8.13	peak
6	5871.200	60.65	1.58	62.23	68.20	-5.97	peak

Note:1.Result (dBuV/m) = Correct Factor (dB/m) + Reading(dBuV).

2.Correction factor (dB/m) = Antenna Factor (dB/m) + Cable loss (dB) – Pre-Amplifier gain (dB).

3.When the peak results are less than average limit, so not need to evaluate the average.

Standard:	FCC Part 15.407	Test Distance:	3 m
Test item:	Band edge		
Frequency:	5560 MHz		
Mode:	Mode 8		
Ant.Polar.:	Horizontal		

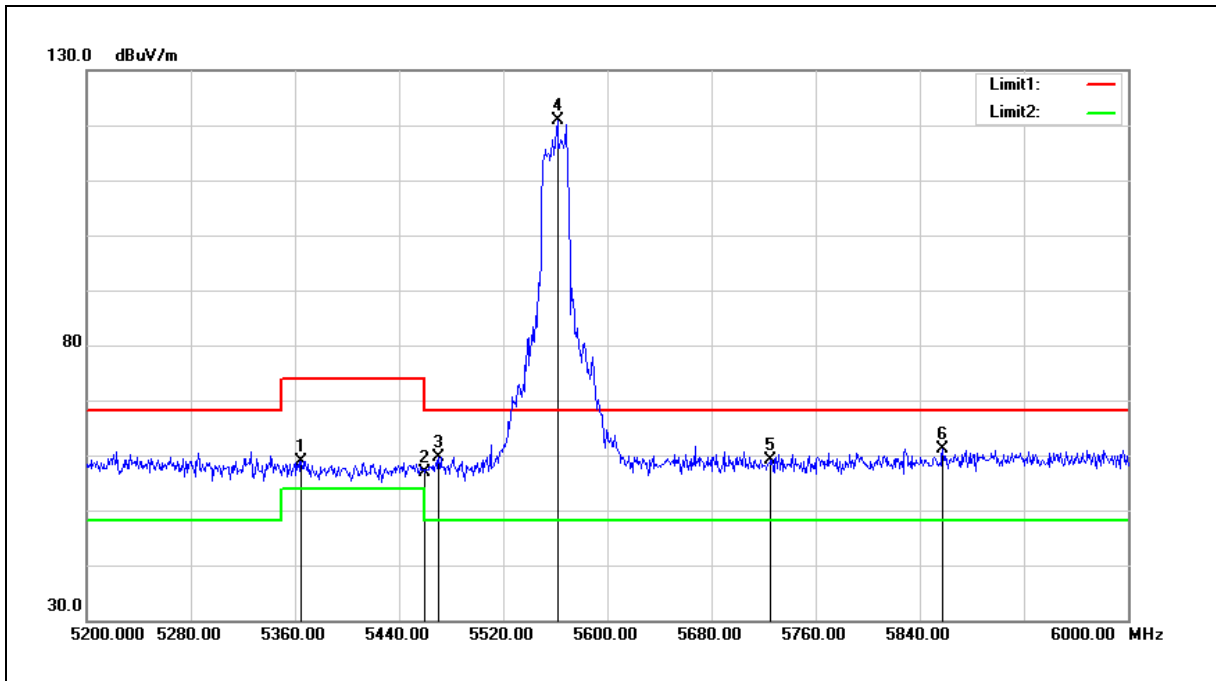

No.	Frequency (MHz)	Reading (dBuV)	Correct Factor (dB/m)	Result (dBuV/m)	Limit (dBuV/m)	Margin (dB)	Remark
1	5364.800	58.65	0.32	58.97	74.00	-15.03	peak
2	5460.000	56.41	0.51	56.92	74.00	-17.08	peak
3	5470.000	59.11	0.52	59.63	68.20	-8.57	peak
4	5561.600	120.15	0.74	120.89	--	--	peak
5	5725.000	58.05	1.18	59.23	68.20	-8.97	peak
6	5857.600	59.66	1.54	61.20	68.20	-7.00	peak

Note: 1. Result (dBuV/m) = Correct Factor (dB/m) + Reading(dBuV).

2. Correction factor (dB/m) = Antenna Factor (dB/m) + Cable loss (dB) – Pre-Amplifier gain (dB).

3. When the peak results are less than average limit, so not need to evaluate the average.

Standard:	FCC Part 15.407	Test Distance:	3 m
Test item:	Band edge		
Frequency:	5560 MHz		
Mode:	Mode 8		
Ant.Polar.:	Vertical		

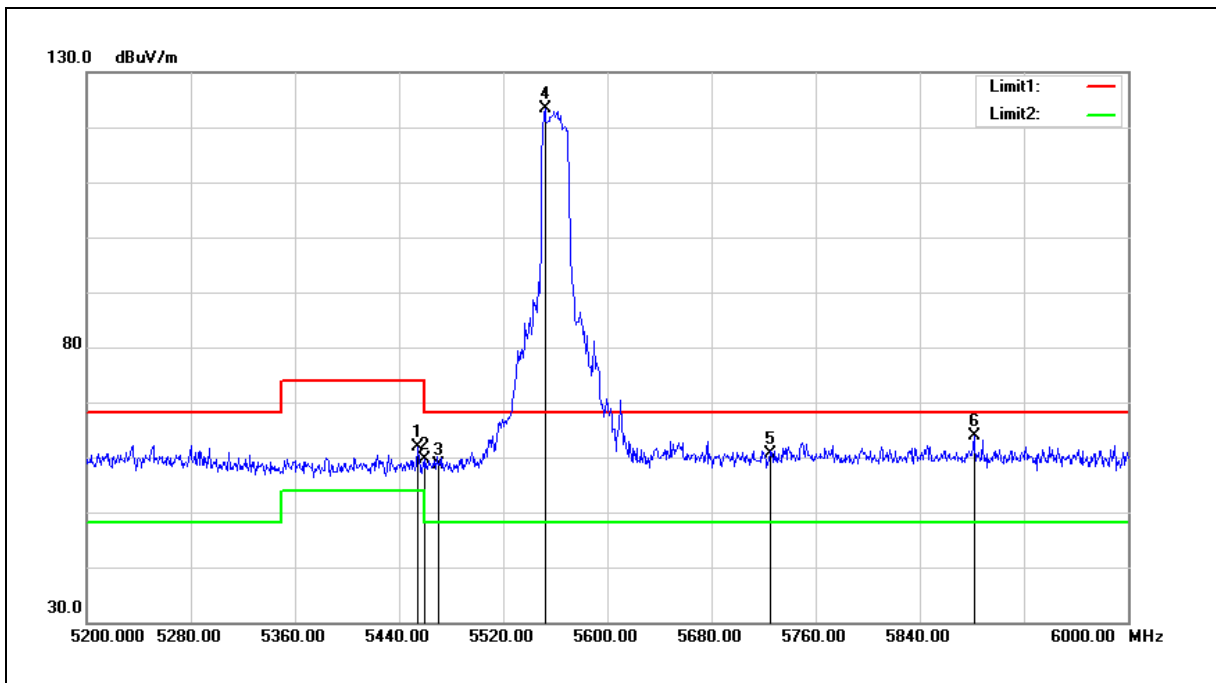

No.	Frequency (MHz)	Reading (dBuV)	Correct Factor (dB/m)	Result (dBuV/m)	Limit (dBuV/m)	Margin (dB)	Remark
1	5454.400	61.34	0.48	61.82	74.00	-12.18	peak
2	5460.000	59.22	0.51	59.73	74.00	-14.27	peak
3	5470.000	58.17	0.52	58.69	68.20	-9.51	peak
4	5552.000	122.56	0.71	123.27	--	--	peak
5	5725.000	59.38	1.18	60.56	68.20	-7.64	peak
6	5881.600	62.36	1.60	63.96	68.20	-4.24	peak

Note: 1. Result (dBuV/m) = Correct Factor (dB/m) + Reading(dBuV).

2. Correction factor (dB/m) = Antenna Factor (dB/m) + Cable loss (dB) – Pre-Amplifier gain (dB).

3. When the peak results are less than average limit, so not need to evaluate the average.

Standard:	FCC Part 15.407	Test Distance:	3 m
Test item:	Band edge		
Frequency:	5700 MHz		
Mode:	Mode 8		
Ant.Polar.:	Horizontal		

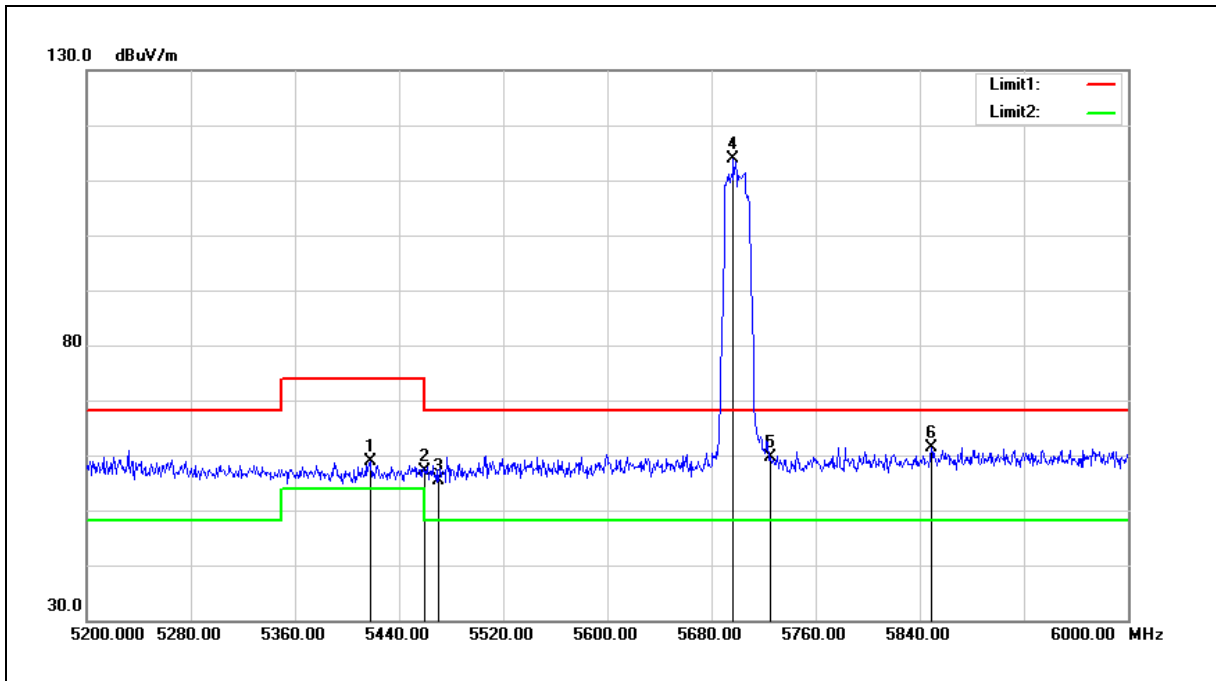

No.	Frequency (MHz)	Reading (dBuV)	Correct Factor (dB/m)	Result (dBuV/m)	Limit (dBuV/m)	Margin (dB)	Remark
1	5417.600	58.49	0.41	58.90	74.00	-15.10	peak
2	5460.000	56.60	0.51	57.11	74.00	-16.89	peak
3	5470.000	54.95	0.52	55.47	68.20	-12.73	peak
4	5696.800	112.72	1.11	113.83	--	--	peak
5	5725.000	58.54	1.18	59.72	68.20	-8.48	peak
6	5848.800	59.95	1.52	61.47	68.20	-6.73	peak

Note: 1. Result (dBuV/m) = Correct Factor (dB/m) + Reading(dBuV).

2. Correction factor (dB/m) = Antenna Factor (dB/m) + Cable loss (dB) – Pre-Amplifier gain (dB).

3. When the peak results are less than average limit, so not need to evaluate the average.

Standard:	FCC Part 15.407	Test Distance:	3 m
Test item:	Band edge		
Frequency:	5700 MHz		
Mode:	Mode 8		
Ant.Polar.:	Vertical		

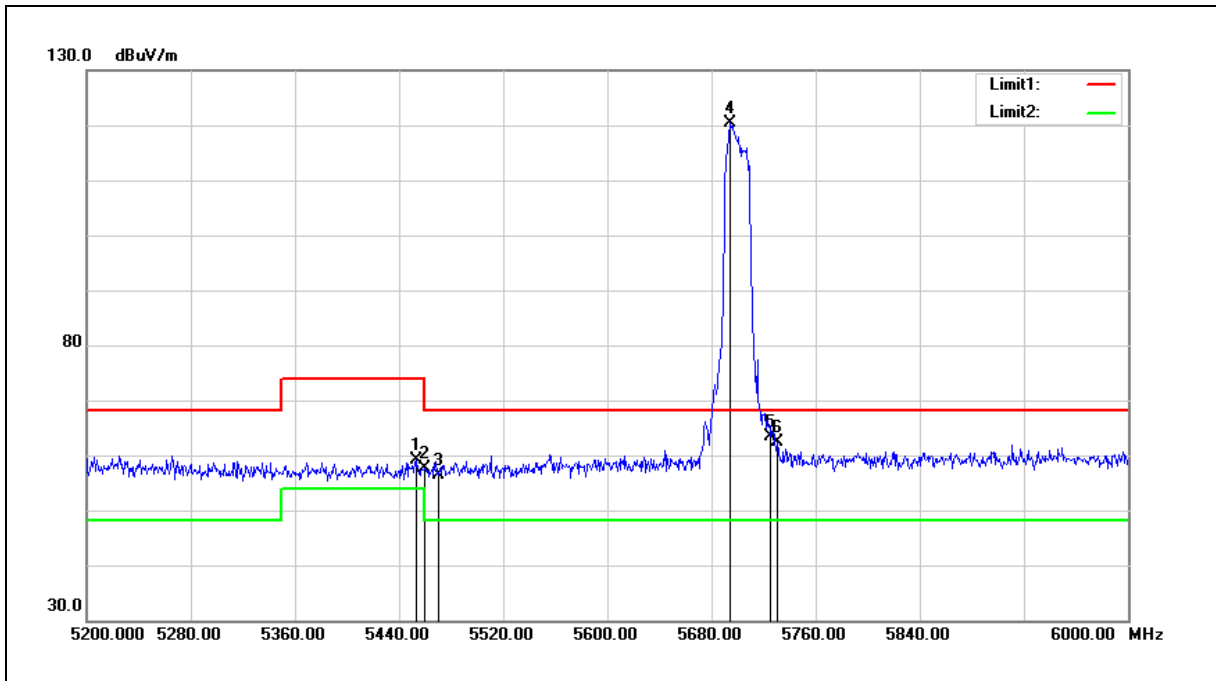

No.	Frequency (MHz)	Reading (dBuV)	Correct Factor (dB/m)	Result (dBuV/m)	Limit (dBuV/m)	Margin (dB)	Remark
1	5453.600	58.69	0.48	59.17	74.00	-14.83	peak
2	5460.000	57.14	0.51	57.65	74.00	-16.35	peak
3	5470.000	55.86	0.52	56.38	68.20	-11.82	peak
4	5694.400	119.30	1.10	120.40	--	--	peak
5	5725.000	62.28	1.18	63.46	68.20	-4.74	peak
6	5730.400	61.07	1.20	62.27	68.20	-5.93	peak

Note: 1. Result (dBuV/m) = Correct Factor (dB/m) + Reading(dBuV).

2. Correction factor (dB/m) = Antenna Factor (dB/m) + Cable loss (dB) – Pre-Amplifier gain (dB).

3. When the peak results are less than average limit, so not need to evaluate the average.

Standard:	FCC Part 15.407	Test Distance:	3 m
Test item:	Band edge		
Frequency:	5745 MHz		
Mode:	Mode 8		
Ant.Polar.:	Horizontal		

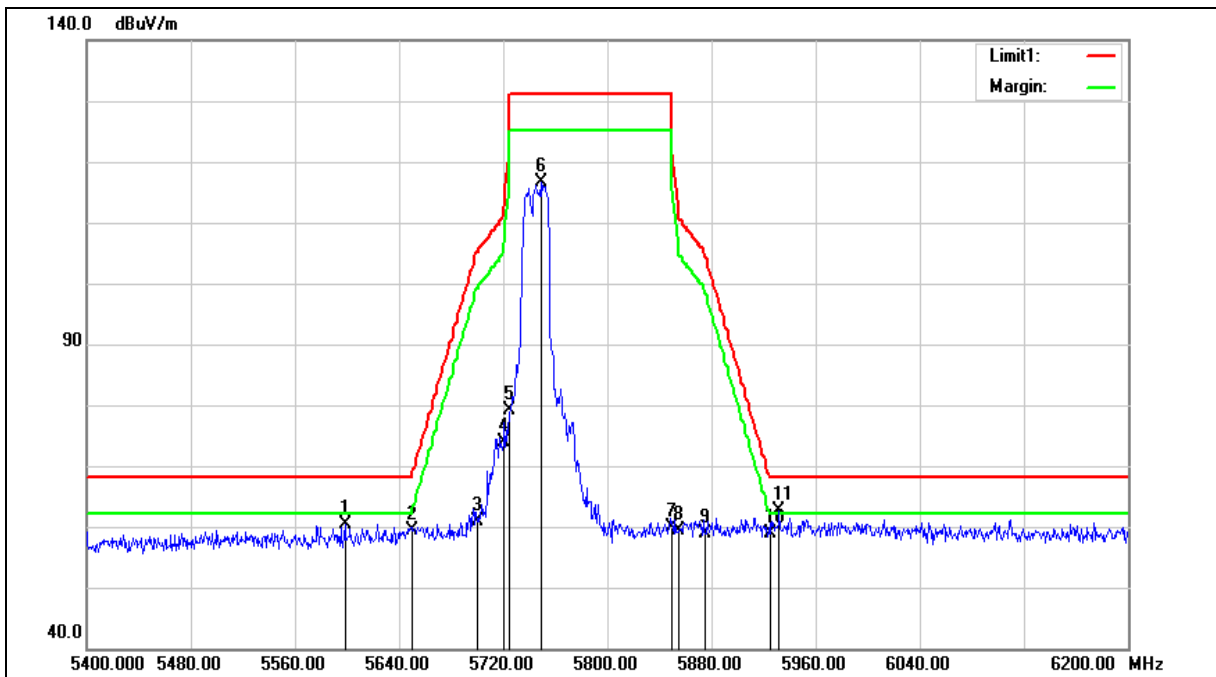

Standard:	FCC Part 15.407	Test Distance:	3 m
Test item:	Band edge		
Frequency:	5745 MHz		
Mode:	Mode 8		
Ant.Polar.:	Horizontal		

No.	Frequency (MHz)	Reading (dBuV)	Correct Factor (dB/m)	Result (dBuV/m)	Limit (dBuV/m)	Margin (dB)	Remark
1	5598.400	59.58	0.84	60.42	68.20	-7.78	peak
2	5650.000	58.41	0.97	59.38	68.20	-8.82	peak
3	5700.000	59.83	1.11	60.94	105.20	-44.26	peak
4	5720.000	72.67	1.17	73.84	110.80	-36.96	peak
5	5725.000	77.97	1.18	79.15	122.20	-43.05	peak
6	5748.800	115.49	1.25	116.74	--	--	peak
7	5850.000	58.30	1.52	59.82	122.20	-62.38	peak
8	5855.000	57.76	1.53	59.29	110.80	-51.51	peak
9	5875.000	57.27	1.59	58.86	105.20	-46.34	peak
10	5925.000	57.26	1.72	58.98	68.20	-9.22	peak
11	5932.000	60.83	1.74	62.57	68.20	-5.63	peak

Note:1.Result (dBuV/m) = Correct Factor (dB/m) + Reading(dBuV).

2.Correction factor (dB/m) = Antenna Factor (dB/m) + Cable loss (dB) – Pre-Amplifier gain (dB).

3.When the peak results are less than average limit, so not need to evaluate the average.

Standard:	FCC Part 15.407	Test Distance:	3 m
Test item:	Band edge		
Frequency:	5745 MHz		
Mode:	Mode 8		
Ant.Polar.:	Vertical		

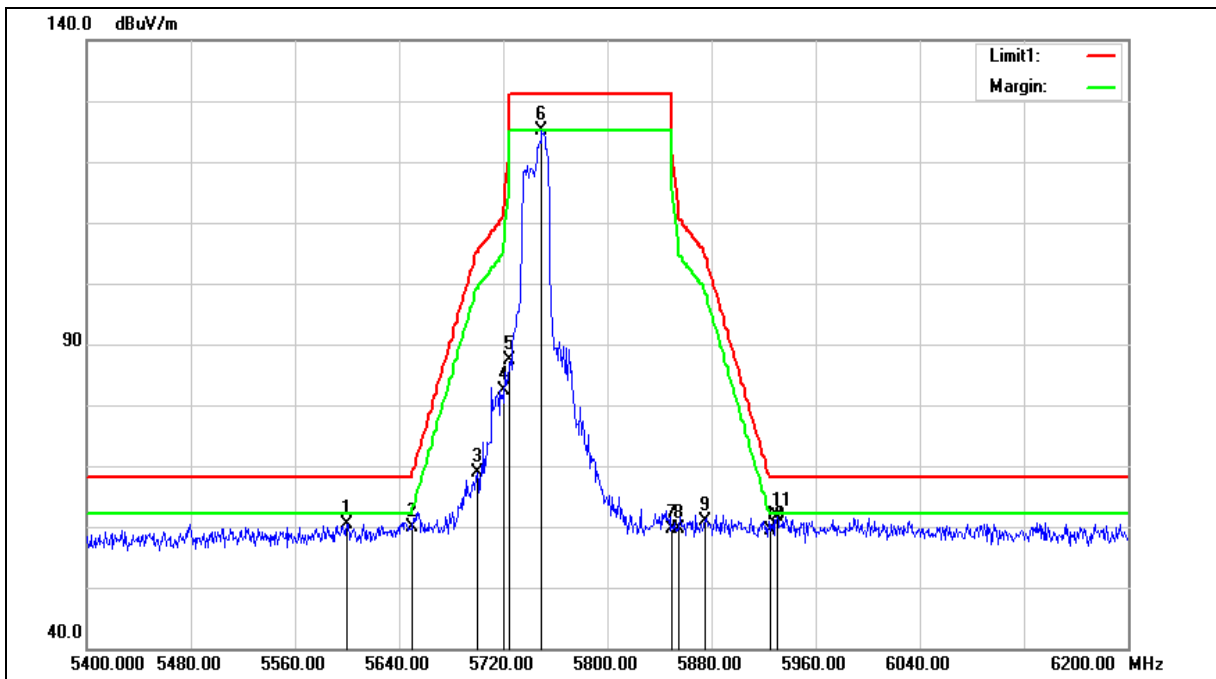

Standard:	FCC Part 15.407	Test Distance:	3 m
Test item:	Band edge		
Frequency:	5745 MHz		
Mode:	Mode 8		
Ant.Polar.:	Vertical		

No.	Frequency (MHz)	Reading (dBuV)	Correct Factor (dB/m)	Result (dBuV/m)	Limit (dBuV/m)	Margin (dB)	Remark
1	5600.000	59.58	0.85	60.43	68.20	-7.77	peak
2	5650.000	58.93	0.97	59.90	68.20	-8.30	peak
3	5700.000	67.79	1.11	68.90	105.20	-36.30	peak
4	5720.000	81.15	1.17	82.32	110.80	-28.48	peak
5	5725.000	86.30	1.18	87.48	122.20	-34.72	peak
6	5749.600	123.93	1.25	125.18	--	--	peak
7	5850.000	58.16	1.52	59.68	122.20	-62.52	peak
8	5855.000	58.15	1.53	59.68	110.80	-51.12	peak
9	5875.000	59.28	1.59	60.87	105.20	-44.33	peak
10	5925.000	57.54	1.72	59.26	68.20	-8.94	peak
11	5930.400	60.01	1.74	61.75	68.20	-6.45	peak

Note:1.Result (dBuV/m) = Correct Factor (dB/m) + Reading(dBuV).

2.Correction factor (dB/m) = Antenna Factor (dB/m) + Cable loss (dB) – Pre-Amplifier gain (dB).

3.When the peak results are less than average limit, so not need to evaluate the average.

Standard:	FCC Part 15.407	Test Distance:	3 m
Test item:	Band edge		
Frequency:	5785 MHz		
Mode:	Mode 8		
Ant.Polar.:	Horizontal		

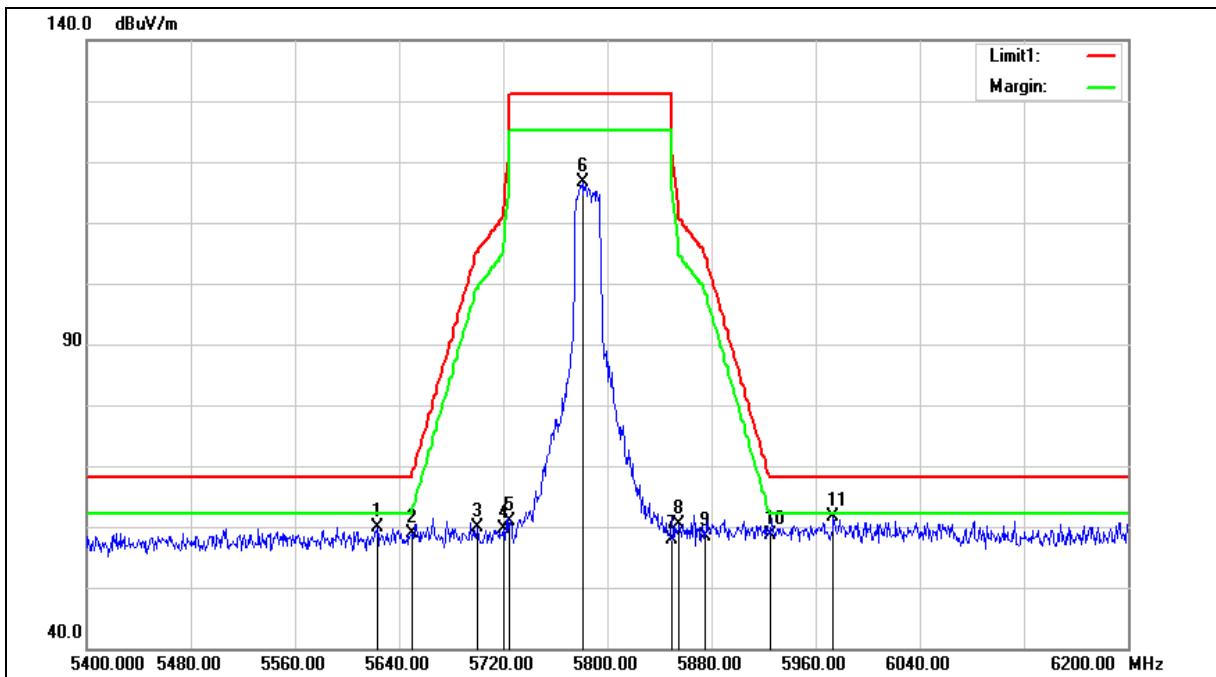

Standard:	FCC Part 15.407	Test Distance:	3 m
Test item:	Band edge		
Frequency:	5785 MHz		
Mode:	Mode 8		
Ant.Polar.:	Horizontal		

No.	Frequency (MHz)	Reading (dBuV)	Correct Factor (dB/m)	Result (dBuV/m)	Limit (dBuV/m)	Margin (dB)	Remark
1	5623.200	58.91	0.90	59.81	68.20	-8.39	peak
2	5650.000	57.87	0.97	58.84	68.20	-9.36	peak
3	5700.000	58.80	1.11	59.91	105.20	-45.29	peak
4	5720.000	58.52	1.17	59.69	110.80	-51.11	peak
5	5725.000	59.59	1.18	60.77	122.20	-61.43	peak
6	5780.800	115.27	1.33	116.60	--	--	peak
7	5850.000	56.43	1.52	57.95	122.20	-64.25	peak
8	5855.000	58.74	1.53	60.27	110.80	-50.53	peak
9	5875.000	56.88	1.59	58.47	105.20	-46.73	peak
10	5925.000	56.99	1.72	58.71	68.20	-9.49	peak
11	5973.600	59.83	1.85	61.68	68.20	-6.52	peak

Note:1.Result (dBuV/m) = Correct Factor (dB/m) + Reading(dBuV).

2.Correction factor (dB/m) = Antenna Factor (dB/m) + Cable loss (dB) – Pre-Amplifier gain (dB).

3.When the peak results are less than average limit, so not need to evaluate the average.

Standard:	FCC Part 15.407	Test Distance:	3 m
Test item:	Band edge		
Frequency:	5785 MHz		
Mode:	Mode 8		
Ant.Polar.:	Vertical		

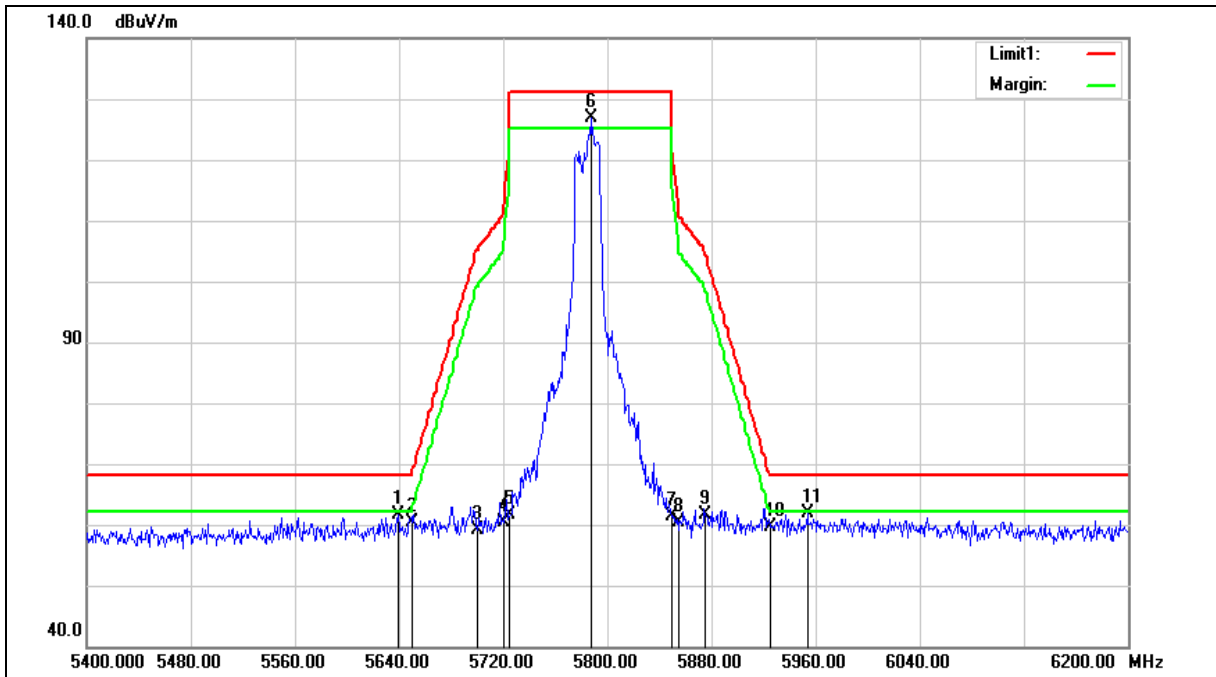

Standard:	FCC Part 15.407	Test Distance:	3 m
Test item:	Band edge		
Frequency:	5785 MHz		
Mode:	Mode 8		
Ant.Polar.:	Vertical		

No.	Frequency (MHz)	Reading (dBuV)	Correct Factor (dB/m)	Result (dBuV/m)	Limit (dBuV/m)	Margin (dB)	Remark
1	5639.200	60.59	0.96	61.55	68.20	-6.65	peak
2	5650.000	59.44	0.97	60.41	68.20	-7.79	peak
3	5700.000	57.99	1.11	59.10	105.20	-46.10	peak
4	5720.000	59.32	1.17	60.49	110.80	-50.31	peak
5	5725.000	60.50	1.18	61.68	122.20	-60.52	peak
6	5787.200	125.54	1.34	126.88	--	--	peak
7	5850.000	59.89	1.52	61.41	122.20	-60.79	peak
8	5855.000	58.76	1.53	60.29	110.80	-50.51	peak
9	5875.000	60.04	1.59	61.63	105.20	-43.57	peak
10	5925.000	57.98	1.72	59.70	68.20	-8.50	peak
11	5953.600	60.02	1.79	61.81	68.20	-6.39	peak

Note:1.Result (dBuV/m) = Correct Factor (dB/m) + Reading(dBuV).

2.Correction factor (dB/m) = Antenna Factor (dB/m) + Cable loss (dB) – Pre-Amplifier gain (dB).

3.When the peak results are less than average limit, so not need to evaluate the average.

Standard:	FCC Part 15.407	Test Distance:	3 m
Test item:	Band edge		
Frequency:	5825 MHz		
Mode:	Mode 8		
Ant.Polar.:	Horizontal		

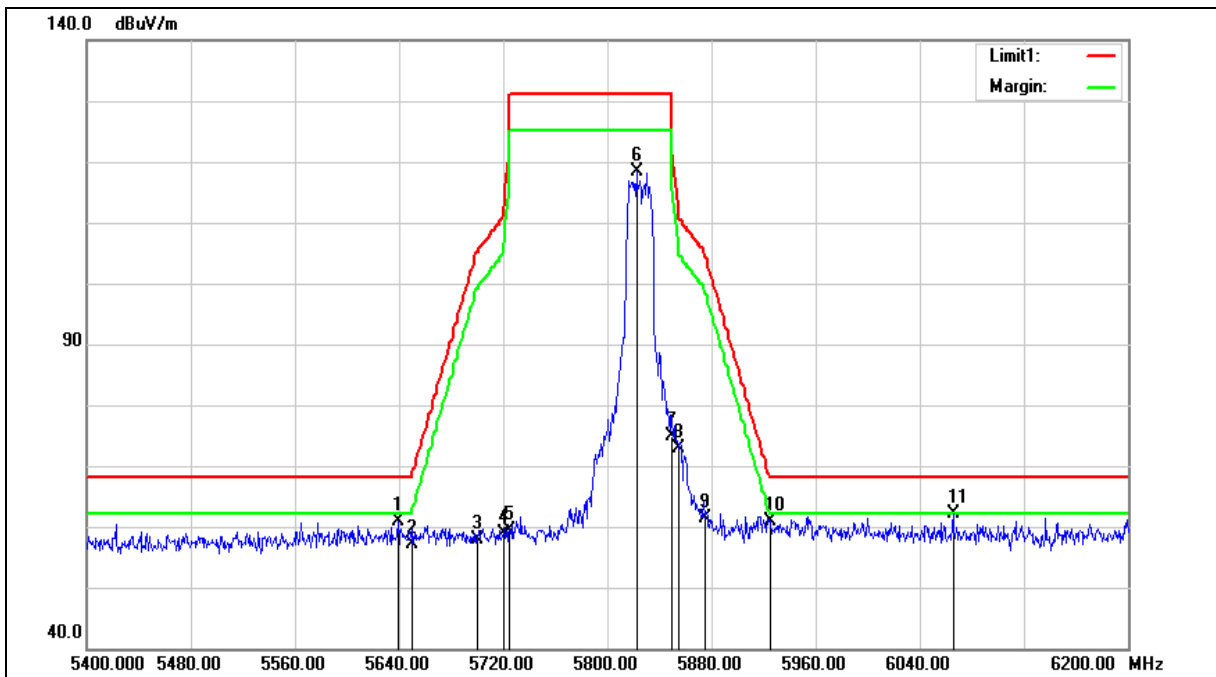

Standard:	FCC Part 15.407	Test Distance:	3 m
Test item:	Band edge		
Frequency:	5825 MHz		
Mode:	Mode 8		
Ant.Polar.:	Horizontal		

No.	Frequency (MHz)	Reading (dBuV)	Correct Factor (dB/m)	Result (dBuV/m)	Limit (dBuV/m)	Margin (dB)	Remark
1	5639.200	59.85	0.96	60.81	68.20	-7.39	peak
2	5650.000	56.18	0.97	57.15	68.20	-11.05	peak
3	5700.000	56.76	1.11	57.87	105.20	-47.33	peak
4	5720.000	57.83	1.17	59.00	110.80	-51.80	peak
5	5725.000	58.14	1.18	59.32	122.20	-62.88	peak
6	5822.400	116.93	1.45	118.38	--	--	peak
7	5850.000	73.35	1.52	74.87	122.20	-47.33	peak
8	5855.000	71.42	1.53	72.95	110.80	-37.85	peak
9	5875.000	59.84	1.59	61.43	105.20	-43.77	peak
10	5925.000	59.13	1.72	60.85	68.20	-7.35	peak
11	6065.600	60.06	2.17	62.23	68.20	-5.97	peak

Note:1.Result (dBuV/m) = Correct Factor (dB/m) + Reading(dBuV).

2.Correction factor (dB/m) = Antenna Factor (dB/m) + Cable loss (dB) – Pre-Amplifier gain (dB).

3.When the peak results are less than average limit, so not need to evaluate the average.

Standard:	FCC Part 15.407	Test Distance:	3 m
Test item:	Band edge		
Frequency:	5825 MHz		
Mode:	Mode 8		
Ant.Polar.:	Vertical		

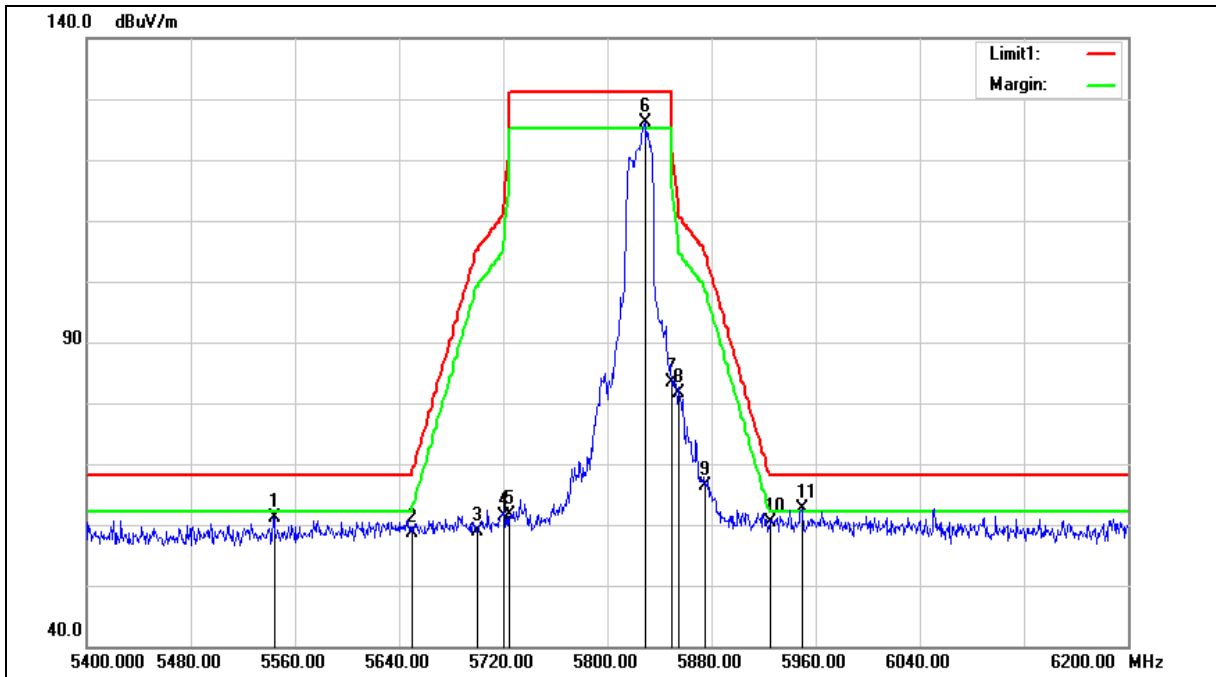

Standard:	FCC Part 15.407	Test Distance:	3 m
Test item:	Band edge		
Frequency:	5825 MHz		
Mode:	Mode 8		
Ant.Polar.:	Vertical		

No.	Frequency (MHz)	Reading (dBuV)	Correct Factor (dB/m)	Result (dBuV/m)	Limit (dBuV/m)	Margin (dB)	Remark
1	5544.000	60.51	0.69	61.20	68.20	-7.00	peak
2	5650.000	57.78	0.97	58.75	68.20	-9.45	peak
3	5700.000	57.82	1.11	58.93	105.20	-46.27	peak
4	5720.000	60.31	1.17	61.48	110.80	-49.32	peak
5	5725.000	60.53	1.18	61.71	122.20	-60.49	peak
6	5828.800	124.72	1.46	126.18	--	--	peak
7	5850.000	81.80	1.52	83.32	122.20	-38.88	peak
8	5855.000	80.07	1.53	81.60	110.80	-29.20	peak
9	5875.000	64.80	1.59	66.39	105.20	-38.81	peak
10	5925.000	58.74	1.72	60.46	68.20	-7.74	peak
11	5949.600	60.79	1.78	62.57	68.20	-5.63	peak

Note:1.Result (dBuV/m) = Correct Factor (dB/m) + Reading(dBuV).

2.Correction factor (dB/m) = Antenna Factor (dB/m) + Cable loss (dB) – Pre-Amplifier gain (dB).

3.When the peak results are less than average limit, so not need to evaluate the average.

Standard:	FCC Part 15.407	Test Distance:	3 m
Test item:	Band edge		
Frequency:	5190 MHz		
Mode:	Mode 9		
Ant.Polar.:	Horizontal		

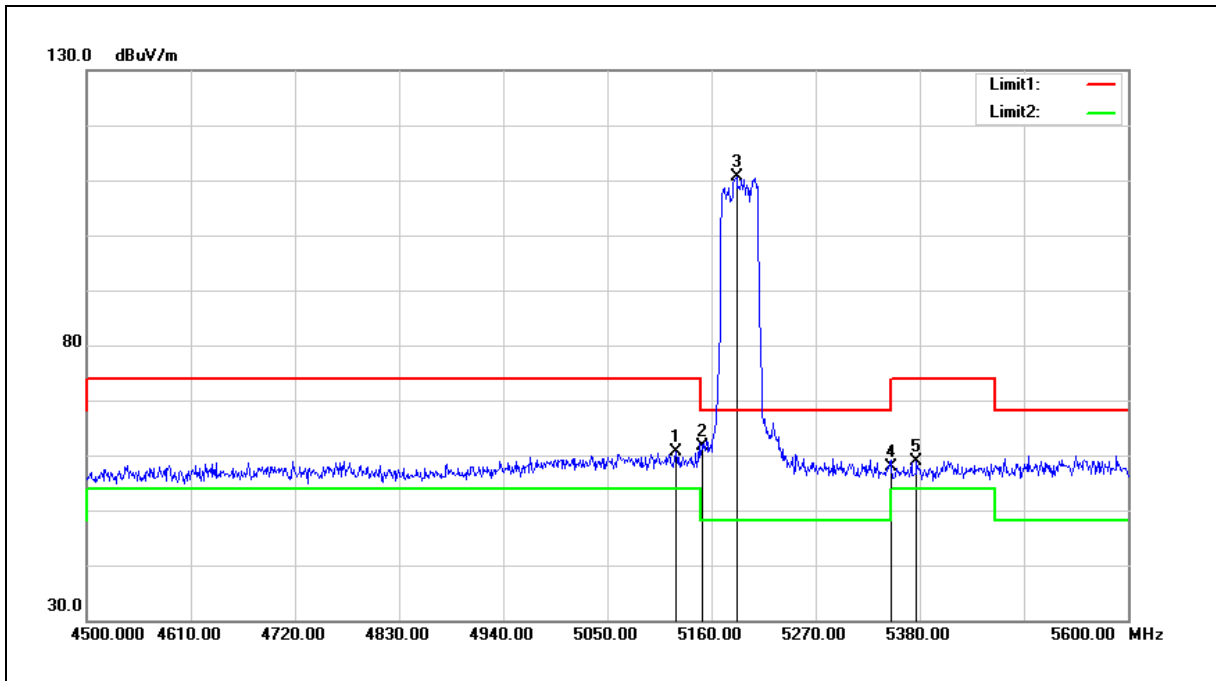

No.	Frequency (MHz)	Reading (dBuV)	Correct Factor (dB/m)	Result (dBuV/m)	Limit (dBuV/m)	Margin (dB)	Remark
1	5122.600	60.65	-0.13	60.52	74.00	-13.48	peak
2	5150.000	61.73	-0.08	61.65	74.00	-12.35	peak
3	5186.400	110.58	-0.01	110.57	--	--	peak
4	5350.000	57.58	0.30	57.88	74.00	-16.12	peak
5	5376.700	58.62	0.34	58.96	74.00	-15.04	peak

Note:1.Result (dBuV/m) = Correct Factor (dB/m) + Reading(dBuV).

2.Correction factor (dB/m) = Antenna Factor (dB/m) + Cable loss (dB) – Pre-Amplifier gain (dB).

3.When the peak results are less than average limit, so not need to evaluate the average.

Standard:	FCC Part 15.407	Test Distance:	3 m
Test item:	Band edge		
Frequency:	5190 MHz		
Mode:	Mode 9		
Ant.Polar.:	Vertical		

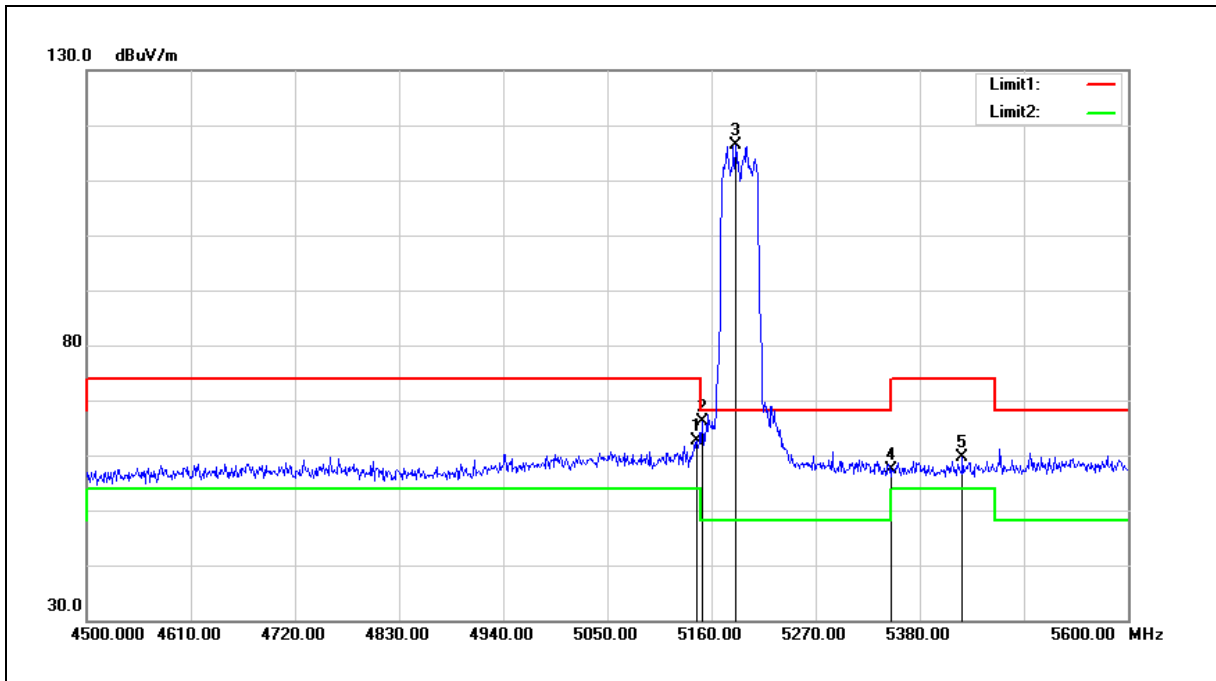

No.	Frequency (MHz)	Reading (dBuV)	Correct Factor (dB/m)	Result (dBuV/m)	Limit (dBuV/m)	Margin (dB)	Remark
1	5144.600	62.61	-0.08	62.53	74.00	-11.47	peak
2	5150.000	66.25	-0.08	66.17	74.00	-7.83	peak
3	5185.300	116.47	-0.01	116.46	--	--	peak
4	5350.000	56.97	0.30	57.27	74.00	-16.73	peak
5	5425.100	59.16	0.43	59.59	74.00	-14.41	peak

Note:1.Result (dBuV/m) = Correct Factor (dB/m) + Reading(dBuV).

2.Correction factor (dB/m) = Antenna Factor (dB/m) + Cable loss (dB) – Pre-Amplifier gain (dB).

3.When the peak results are less than average limit, so not need to evaluate the average.

Standard:	FCC Part 15.407	Test Distance:	3 m
Test item:	Band edge		
Frequency:	5230 MHz		
Mode:	Mode 9		
Ant.Polar.:	Horizontal		

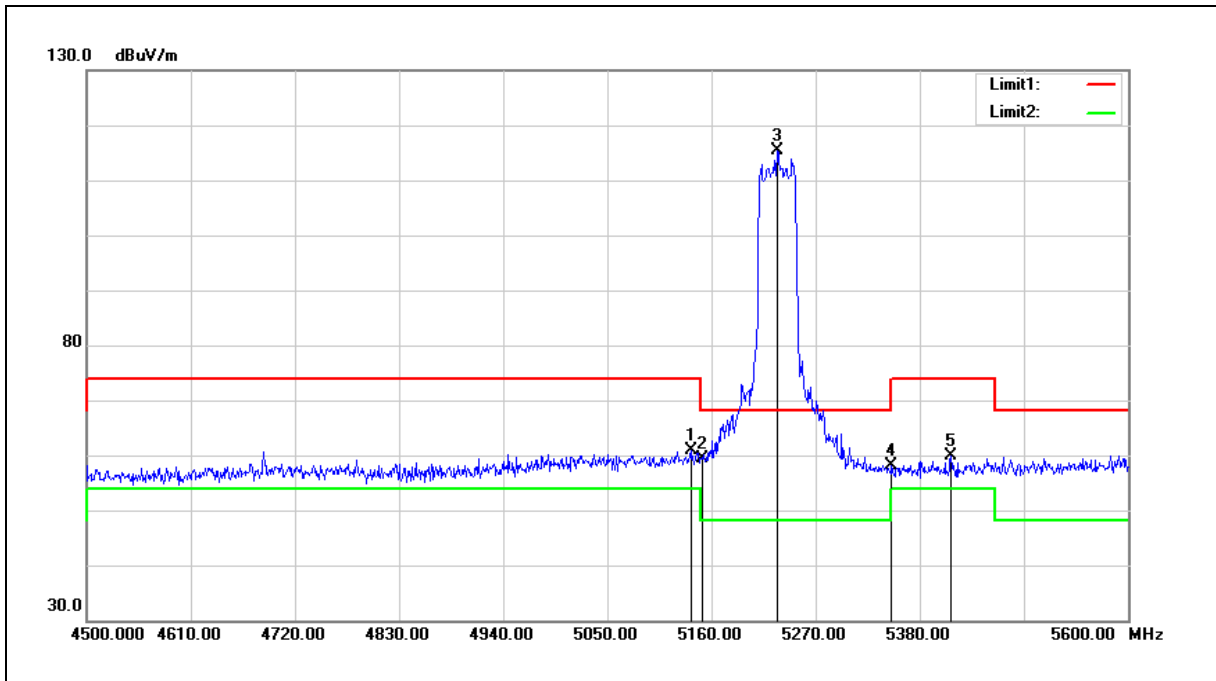

No.	Frequency (MHz)	Reading (dBuV)	Correct Factor (dB/m)	Result (dBuV/m)	Limit (dBuV/m)	Margin (dB)	Remark
1	5138.000	61.09	-0.10	60.99	74.00	-13.01	peak
2	5150.000	59.44	-0.08	59.36	74.00	-14.64	peak
3	5229.300	115.22	0.07	115.29	--	--	peak
4	5350.000	57.72	0.30	58.02	74.00	-15.98	peak
5	5413.000	59.43	0.41	59.84	74.00	-14.16	peak

Note:1.Result (dBuV/m) = Correct Factor (dB/m) + Reading(dBuV).

2.Correction factor (dB/m) = Antenna Factor (dB/m) + Cable loss (dB) – Pre-Amplifier gain (dB).

3.When the peak results are less than average limit, so not need to evaluate the average.

Standard:	FCC Part 15.407	Test Distance:	3 m
Test item:	Band edge		
Frequency:	5230 MHz		
Mode:	Mode 9		
Ant.Polar.:	Vertical		

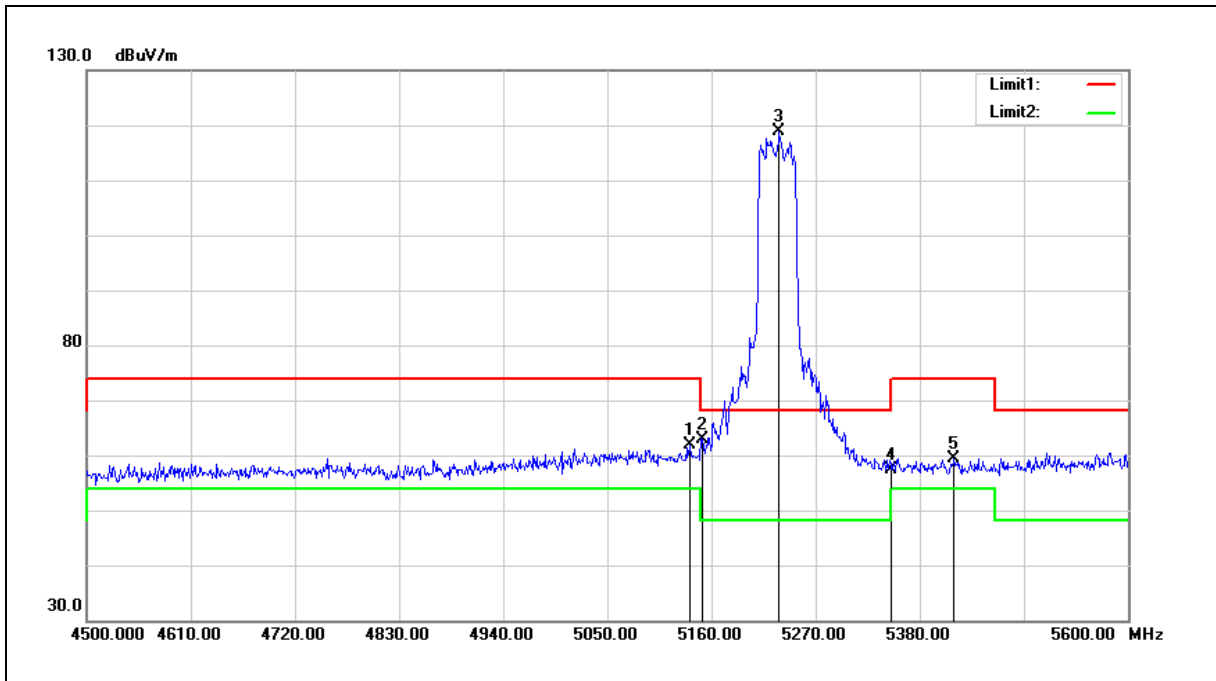

No.	Frequency (MHz)	Reading (dBuV)	Correct Factor (dB/m)	Result (dBuV/m)	Limit (dBuV/m)	Margin (dB)	Remark
1	5136.900	62.00	-0.10	61.90	74.00	-12.10	peak
2	5150.000	63.00	-0.08	62.92	74.00	-11.08	peak
3	5231.500	118.79	0.08	118.87	--	--	peak
4	5350.000	57.01	0.30	57.31	74.00	-16.69	peak
5	5416.300	58.94	0.41	59.35	74.00	-14.65	peak

Note:1.Result (dBuV/m) = Correct Factor (dB/m) + Reading(dBuV).

2.Correction factor (dB/m) = Antenna Factor (dB/m) + Cable loss (dB) – Pre-Amplifier gain (dB).

3.When the peak results are less than average limit, so not need to evaluate the average.

Standard:	FCC Part 15.407	Test Distance:	3 m
Test item:	Band edge		
Frequency:	5270 MHz		
Mode:	Mode 9		
Ant.Polar.:	Horizontal		

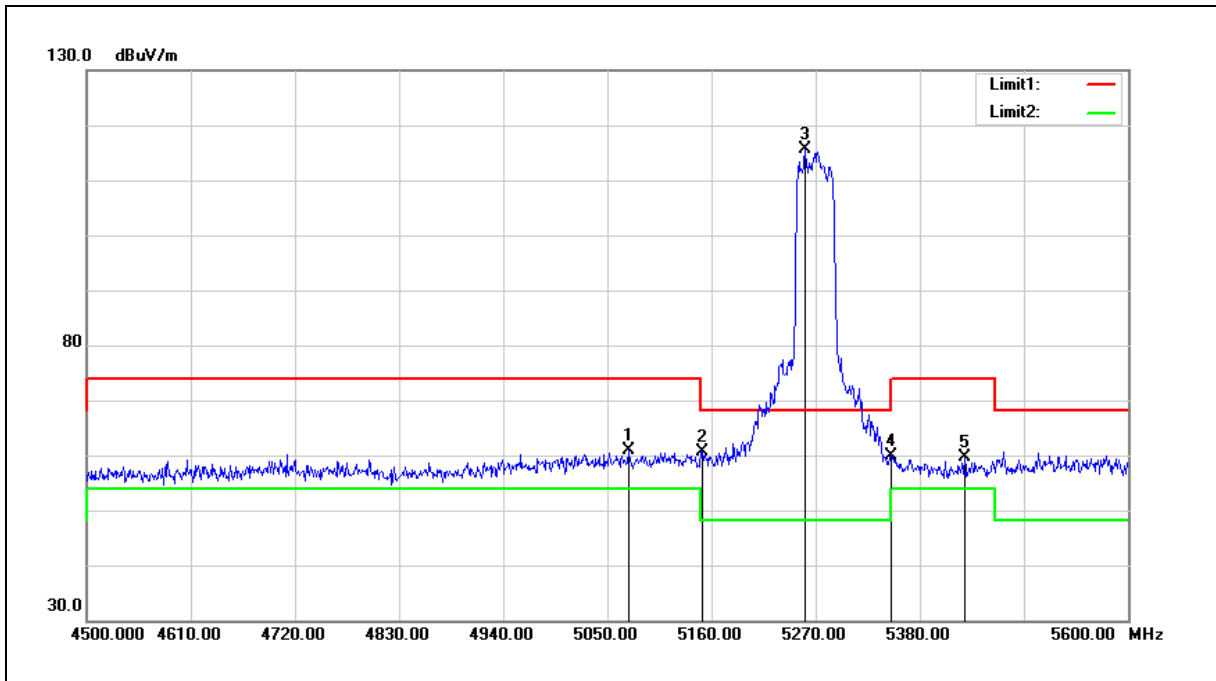

No.	Frequency (MHz)	Reading (dBuV)	Correct Factor (dB/m)	Result (dBuV/m)	Limit (dBuV/m)	Margin (dB)	Remark
1	5072.000	60.99	-0.23	60.76	74.00	-13.24	peak
2	5150.000	60.75	-0.08	60.67	74.00	-13.33	peak
3	5259.000	115.41	0.13	115.54	--	--	peak
4	5350.000	59.53	0.30	59.83	74.00	-14.17	peak
5	5427.300	59.18	0.44	59.62	74.00	-14.38	peak

Note:1.Result (dBuV/m) = Correct Factor (dB/m) + Reading(dBuV).

2.Correction factor (dB/m) = Antenna Factor (dB/m) + Cable loss (dB) – Pre-Amplifier gain (dB).

3.When the peak results are less than average limit, so not need to evaluate the average.

Standard:	FCC Part 15.407	Test Distance:	3 m
Test item:	Band edge		
Frequency:	5270 MHz		
Mode:	Mode 9		
Ant.Polar.:	Vertical		

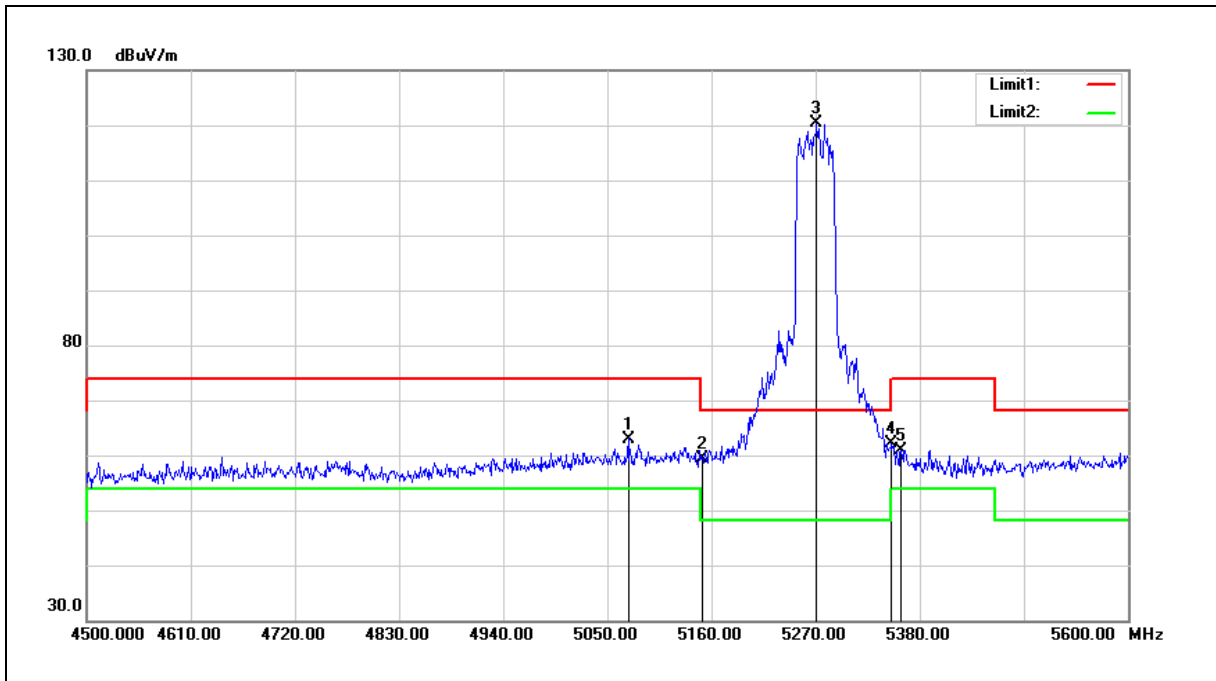

No.	Frequency (MHz)	Reading (dBuV)	Correct Factor (dB/m)	Result (dBuV/m)	Limit (dBuV/m)	Margin (dB)	Remark
1	5072.000	63.23	-0.23	63.00	74.00	-11.00	peak
2	5150.000	59.52	-0.08	59.44	74.00	-14.56	peak
3	5271.100	120.27	0.15	120.42	--	--	peak
4	5350.000	61.83	0.30	62.13	74.00	-11.87	peak
5	5360.200	60.66	0.31	60.97	74.00	-13.03	peak

Note:1.Result (dBuV/m) = Correct Factor (dB/m) + Reading(dBuV).

2.Correction factor (dB/m) = Antenna Factor (dB/m) + Cable loss (dB) – Pre-Amplifier gain (dB).

3.When the peak results are less than average limit, so not need to evaluate the average.

Standard:	FCC Part 15.407	Test Distance:	3 m
Test item:	Band edge		
Frequency:	5310 MHz		
Mode:	Mode 9		
Ant.Polar.:	Horizontal		

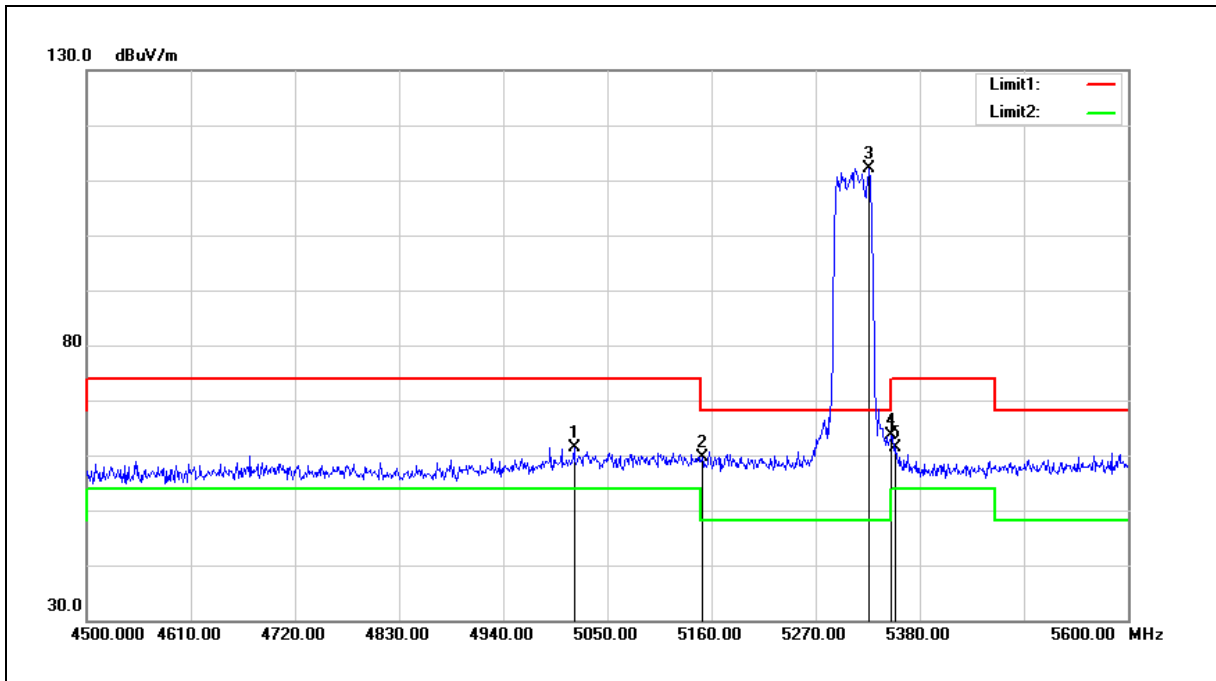

No.	Frequency (MHz)	Reading (dBuV)	Correct Factor (dB/m)	Result (dBuV/m)	Limit (dBuV/m)	Margin (dB)	Remark
1	5014.800	61.75	-0.33	61.42	74.00	-12.58	peak
2	5150.000	59.71	-0.08	59.63	74.00	-14.37	peak
3	5326.100	111.89	0.25	112.14	--	--	peak
4	5350.000	63.34	0.30	63.64	74.00	-10.36	peak
5	5354.700	61.14	0.30	61.44	74.00	-12.56	peak

Note:1.Result (dBuV/m) = Correct Factor (dB/m) + Reading(dBuV).

2.Correction factor (dB/m) = Antenna Factor (dB/m) + Cable loss (dB) – Pre-Amplifier gain (dB).

3.When the peak results are less than average limit, so not need to evaluate the average.

Standard:	FCC Part 15.407	Test Distance:	3 m
Test item:	Band edge		
Frequency:	5310 MHz		
Mode:	Mode 9		
Ant.Polar.:	Vertical		

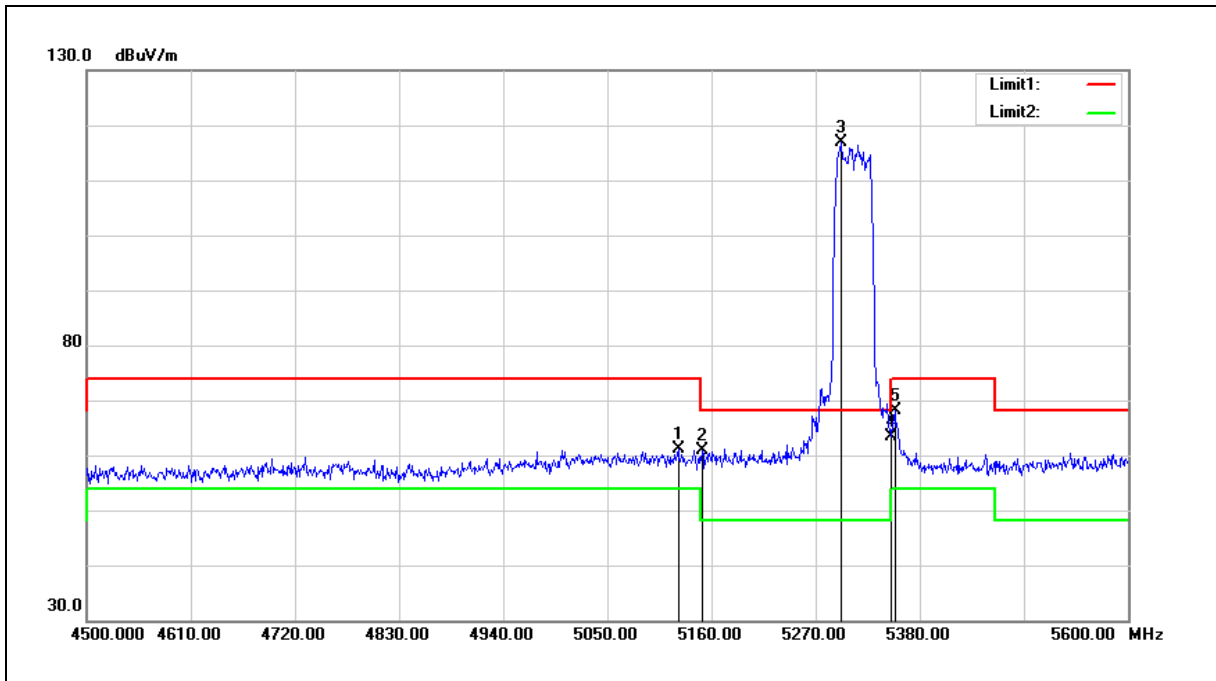

No.	Frequency (MHz)	Reading (dBuV)	Correct Factor (dB/m)	Result (dBuV/m)	Limit (dBuV/m)	Margin (dB)	Remark
1	5124.800	61.15	-0.13	61.02	74.00	-12.98	peak
2	5150.000	61.05	-0.08	60.97	74.00	-13.03	peak
3	5297.500	116.69	0.20	116.89	--	--	peak
4	5350.000	63.04	0.30	63.34	74.00	-10.66	peak
5	5353.600	67.86	0.30	68.16	74.00	-5.84	peak

Note:1.Result (dBuV/m) = Correct Factor (dB/m) + Reading(dBuV).

2.Correction factor (dB/m) = Antenna Factor (dB/m) + Cable loss (dB) – Pre-Amplifier gain (dB).

3.When the peak results are less than average limit, so not need to evaluate the average.

Standard:	FCC Part 15.407	Test Distance:	3 m
Test item:	Band edge		
Frequency:	5510 MHz		
Mode:	Mode 9		
Ant.Polar.:	Horizontal		

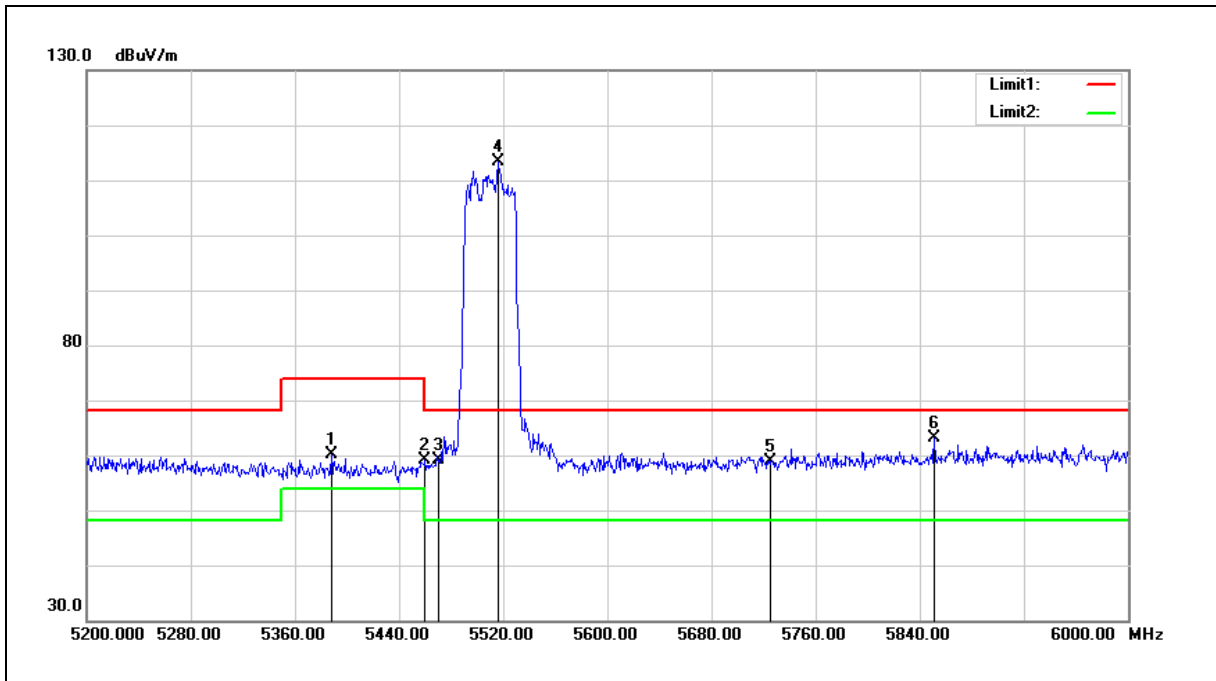

No.	Frequency (MHz)	Reading (dBuV)	Correct Factor (dB/m)	Result (dBuV/m)	Limit (dBuV/m)	Margin (dB)	Remark
1	5388.000	59.78	0.36	60.14	74.00	-13.86	peak
2	5460.000	58.58	0.51	59.09	74.00	-14.91	peak
3	5470.000	58.52	0.52	59.04	68.20	-9.16	peak
4	5516.000	112.74	0.62	113.36	--	--	peak
5	5725.000	57.70	1.18	58.88	68.20	-9.32	peak
6	5851.200	61.59	1.52	63.11	68.20	-5.09	peak

Note: 1. Result (dBuV/m) = Correct Factor (dB/m) + Reading(dBuV).

2. Correction factor (dB/m) = Antenna Factor (dB/m) + Cable loss (dB) – Pre-Amplifier gain (dB).

3. When the peak results are less than average limit, so not need to evaluate the average.

Standard:	FCC Part 15.407	Test Distance:	3 m
Test item:	Band edge		
Frequency:	5510 MHz		
Mode:	Mode 9		
Ant.Polar.:	Vertical		

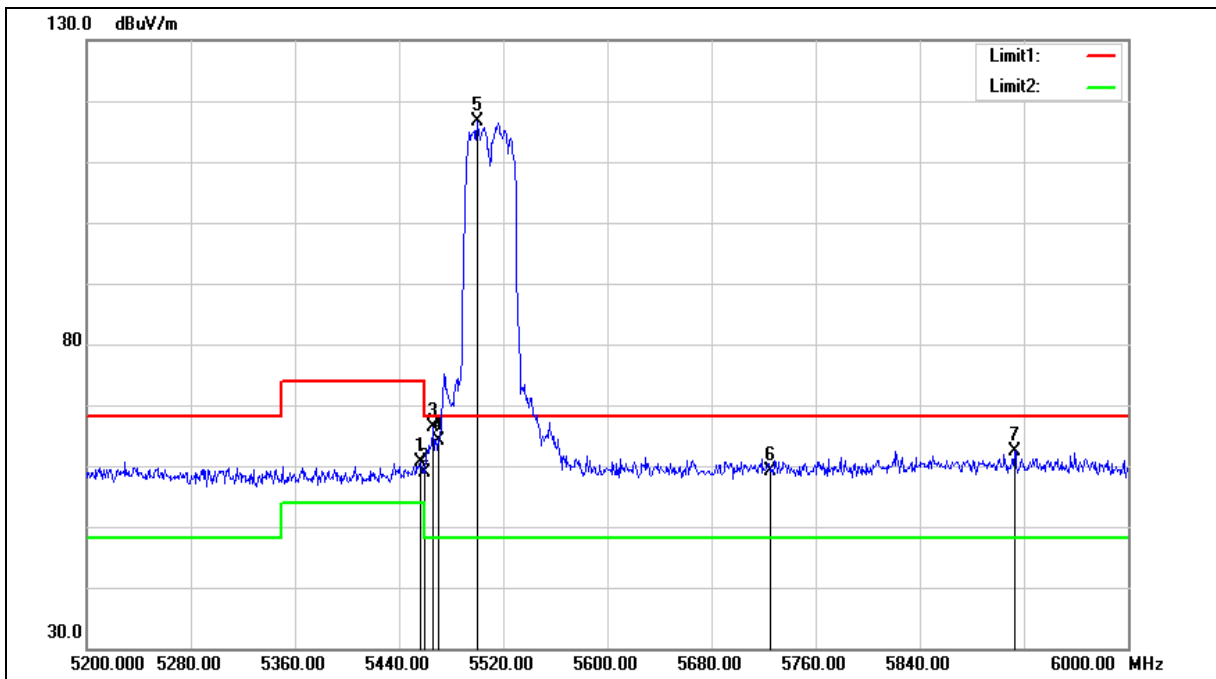

Standard:	FCC Part 15.407	Test Distance:	3 m
Test item:	Band edge		
Frequency:	5510 MHz		
Mode:	Mode 9		
Ant.Polar.:	Vertical		

No.	Frequency (MHz)	Reading (dBuV)	Correct Factor (dB/m)	Result (dBuV/m)	Limit (dBuV/m)	Margin (dB)	Remark
1	5456.800	60.10	0.50	60.60	74.00	-13.40	peak
2	5460.000	58.47	0.51	58.98	74.00	-15.02	peak
3	5466.400	65.91	0.51	66.42	68.20	-1.78	peak
4	5470.000	63.68	0.52	64.20	68.20	-4.00	peak
5	5500.000	115.99	0.58	116.57	--	--	peak
6	5725.000	57.97	1.18	59.15	68.20	-9.05	peak
7	5912.800	60.61	1.69	62.30	68.20	-5.90	peak

Note:1.Result (dBuV/m) = Correct Factor (dB/m) + Reading(dBuV).

2.Correction factor (dB/m) = Antenna Factor (dB/m) + Cable loss (dB) – Pre-Amplifier gain (dB).

3.When the peak results are less than average limit, so not need to evaluate the average.

Standard:	FCC Part 15.407	Test Distance:	3 m
Test item:	Band edge		
Frequency:	5550 MHz		
Mode:	Mode 9		
Ant.Polar.:	Horizontal		

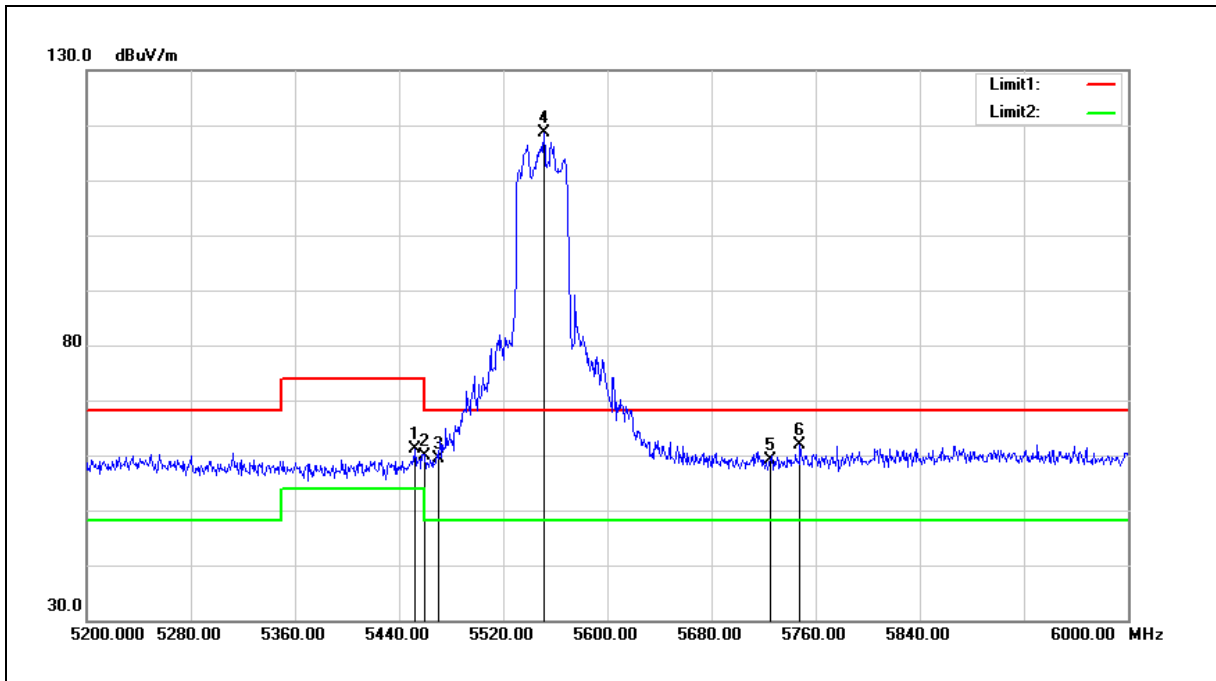

No.	Frequency (MHz)	Reading (dBuV)	Correct Factor (dB/m)	Result (dBuV/m)	Limit (dBuV/m)	Margin (dB)	Remark
1	5452.000	60.74	0.48	61.22	74.00	-12.78	peak
2	5460.000	59.42	0.51	59.93	74.00	-14.07	peak
3	5470.000	58.94	0.52	59.46	68.20	-8.74	peak
4	5551.200	117.86	0.71	118.57	--	--	peak
5	5725.000	57.98	1.18	59.16	68.20	-9.04	peak
6	5748.000	60.69	1.25	61.94	68.20	-6.26	peak

Note: 1. Result (dBuV/m) = Correct Factor (dB/m) + Reading (dBuV).

2. Correction factor (dB/m) = Antenna Factor (dB/m) + Cable loss (dB) – Pre-Amplifier gain (dB).

3. When the peak results are less than average limit, so not need to evaluate the average.

Standard:	FCC Part 15.407	Test Distance:	3 m
Test item:	Band edge		
Frequency:	5550 MHz		
Mode:	Mode 9		
Ant.Polar.:	Vertical		

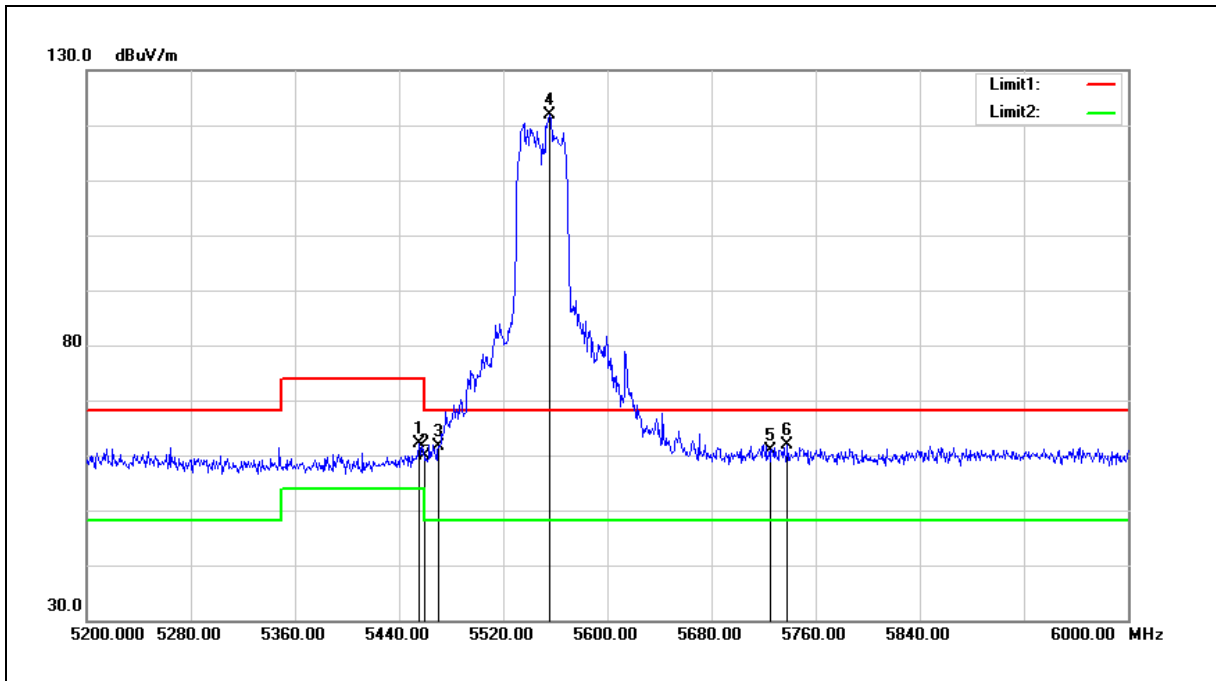

No.	Frequency (MHz)	Reading (dBuV)	Correct Factor (dB/m)	Result (dBuV/m)	Limit (dBuV/m)	Margin (dB)	Remark
1	5455.200	61.64	0.48	62.12	74.00	-11.88	peak
2	5460.000	59.47	0.51	59.98	74.00	-14.02	peak
3	5470.000	61.07	0.52	61.59	68.20	-6.61	peak
4	5555.200	121.19	0.73	121.92	--	--	peak
5	5725.000	59.77	1.18	60.95	68.20	-7.25	peak
6	5738.400	60.62	1.22	61.84	68.20	-6.36	peak

Note: 1. Result (dBuV/m) = Correct Factor (dB/m) + Reading(dBuV).

2. Correction factor (dB/m) = Antenna Factor (dB/m) + Cable loss (dB) – Pre-Amplifier gain (dB).

3. When the peak results are less than average limit, so not need to evaluate the average.

Standard:	FCC Part 15.407	Test Distance:	3 m
Test item:	Band edge		
Frequency:	5670 MHz		
Mode:	Mode 9		
Ant.Polar.:	Horizontal		

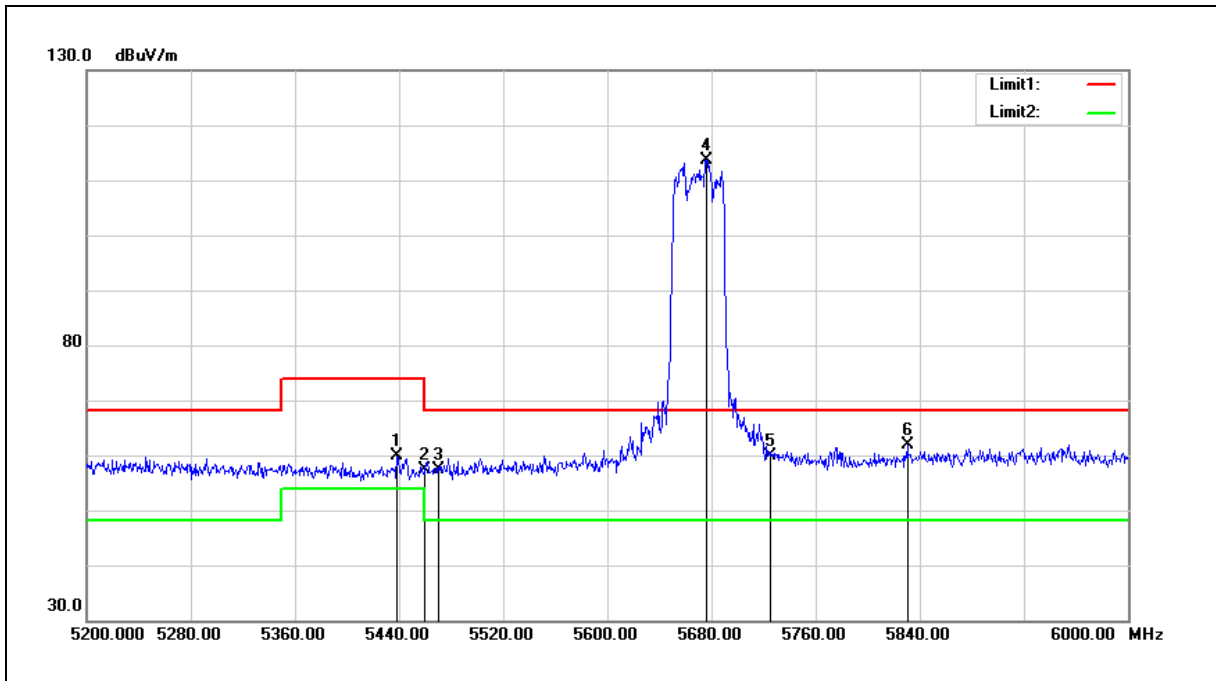

No.	Frequency (MHz)	Reading (dBuV)	Correct Factor (dB/m)	Result (dBuV/m)	Limit (dBuV/m)	Margin (dB)	Remark
1	5438.400	59.33	0.46	59.79	74.00	-14.21	peak
2	5460.000	56.77	0.51	57.28	74.00	-16.72	peak
3	5470.000	56.93	0.52	57.45	68.20	-10.75	peak
4	5676.000	112.61	1.04	113.65	--	--	peak
5	5725.000	58.80	1.18	59.98	68.20	-8.22	peak
6	5830.400	60.37	1.47	61.84	68.20	-6.36	peak

Note: 1. Result (dBuV/m) = Correct Factor (dB/m) + Reading(dBuV).

2. Correction factor (dB/m) = Antenna Factor (dB/m) + Cable loss (dB) – Pre-Amplifier gain (dB).

3. When the peak results are less than average limit, so not need to evaluate the average.

Standard:	FCC Part 15.407	Test Distance:	3 m
Test item:	Band edge		
Frequency:	5670 MHz		
Mode:	Mode 9		
Ant.Polar.:	Vertical		

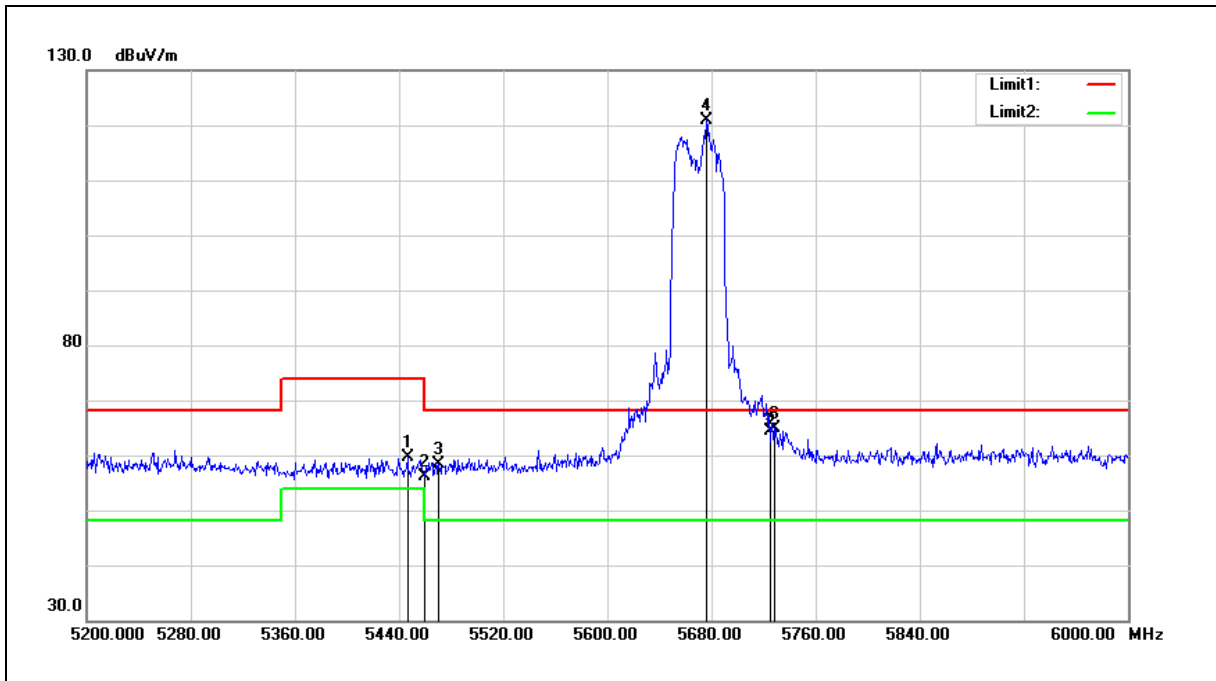

No.	Frequency (MHz)	Reading (dBuV)	Correct Factor (dB/m)	Result (dBuV/m)	Limit (dBuV/m)	Margin (dB)	Remark
1	5446.400	59.08	0.48	59.56	74.00	-14.44	peak
2	5460.000	55.72	0.51	56.23	74.00	-17.77	peak
3	5470.000	57.80	0.52	58.32	68.20	-9.88	peak
4	5676.000	119.92	1.04	120.96	--	--	peak
5	5725.000	63.14	1.18	64.32	68.20	-3.88	peak
6	5728.000	63.59	1.18	64.77	68.20	-3.43	peak

Note: 1. Result (dBuV/m) = Correct Factor (dB/m) + Reading(dBuV).

2. Correction factor (dB/m) = Antenna Factor (dB/m) + Cable loss (dB) – Pre-Amplifier gain (dB).

3. When the peak results are less than average limit, so not need to evaluate the average.

Standard:	FCC Part 15.407	Test Distance:	3 m
Test item:	Band edge		
Frequency:	5755 MHz		
Mode:	Mode 9		
Ant.Polar.:	Horizontal		

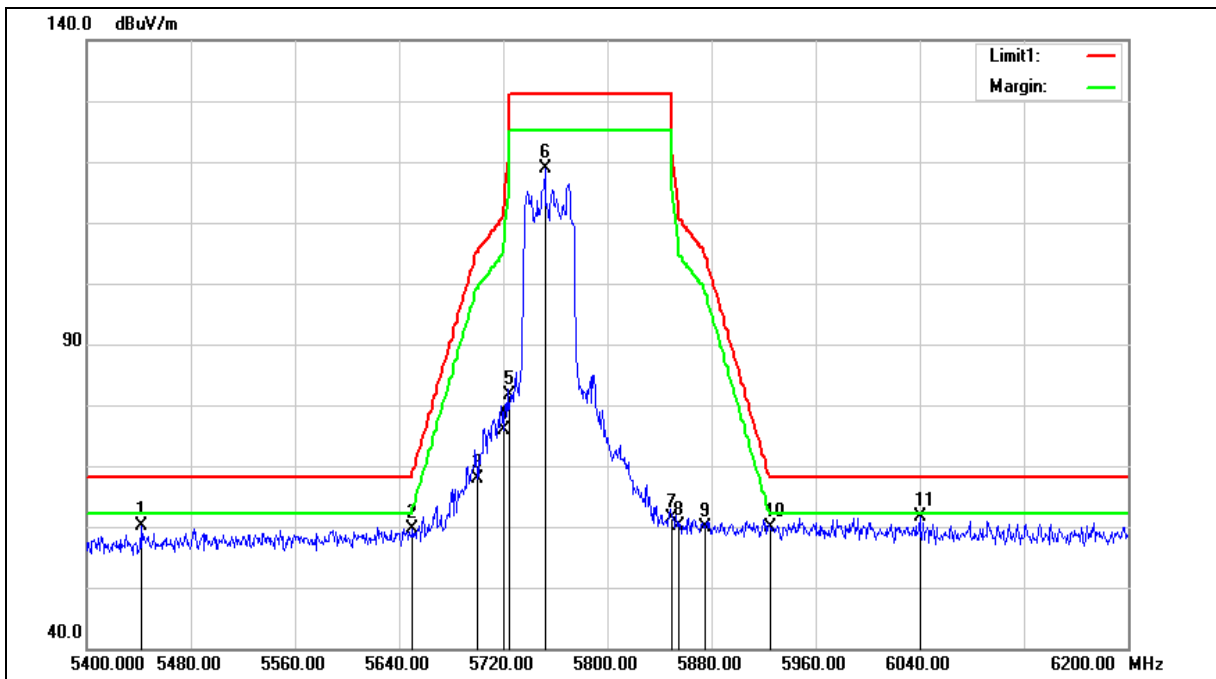

Standard:	FCC Part 15.407	Test Distance:	3 m
Test item:	Band edge		
Frequency:	5755 MHz		
Mode:	Mode 9		
Ant.Polar.:	Horizontal		

No.	Frequency (MHz)	Reading (dBuV)	Correct Factor (dB/m)	Result (dBuV/m)	Limit (dBuV/m)	Margin (dB)	Remark
1	5441.600	59.62	0.46	60.08	68.20	-8.12	peak
2	5650.000	58.76	0.97	59.73	68.20	-8.47	peak
3	5700.000	66.81	1.11	67.92	105.20	-37.28	peak
4	5720.000	74.69	1.17	75.86	110.80	-34.94	peak
5	5725.000	80.49	1.18	81.67	122.20	-40.53	peak
6	5752.000	117.70	1.25	118.95	--	--	peak
7	5850.000	59.80	1.52	61.32	122.20	-60.88	peak
8	5855.000	58.64	1.53	60.17	110.80	-50.63	peak
9	5875.000	58.30	1.59	59.89	105.20	-45.31	peak
10	5925.000	58.05	1.72	59.77	68.20	-8.43	peak
11	6040.000	59.66	2.08	61.74	68.20	-6.46	peak

Note:1.Result (dBuV/m) = Correct Factor (dB/m) + Reading(dBuV).

2.Correction factor (dB/m) = Antenna Factor (dB/m) + Cable loss (dB) – Pre-Amplifier gain (dB).

3.When the peak results are less than average limit, so not need to evaluate the average.

Standard:	FCC Part 15.407	Test Distance:	3 m
Test item:	Band edge		
Frequency:	5755 MHz		
Mode:	Mode 9		
Ant.Polar.:	Vertical		

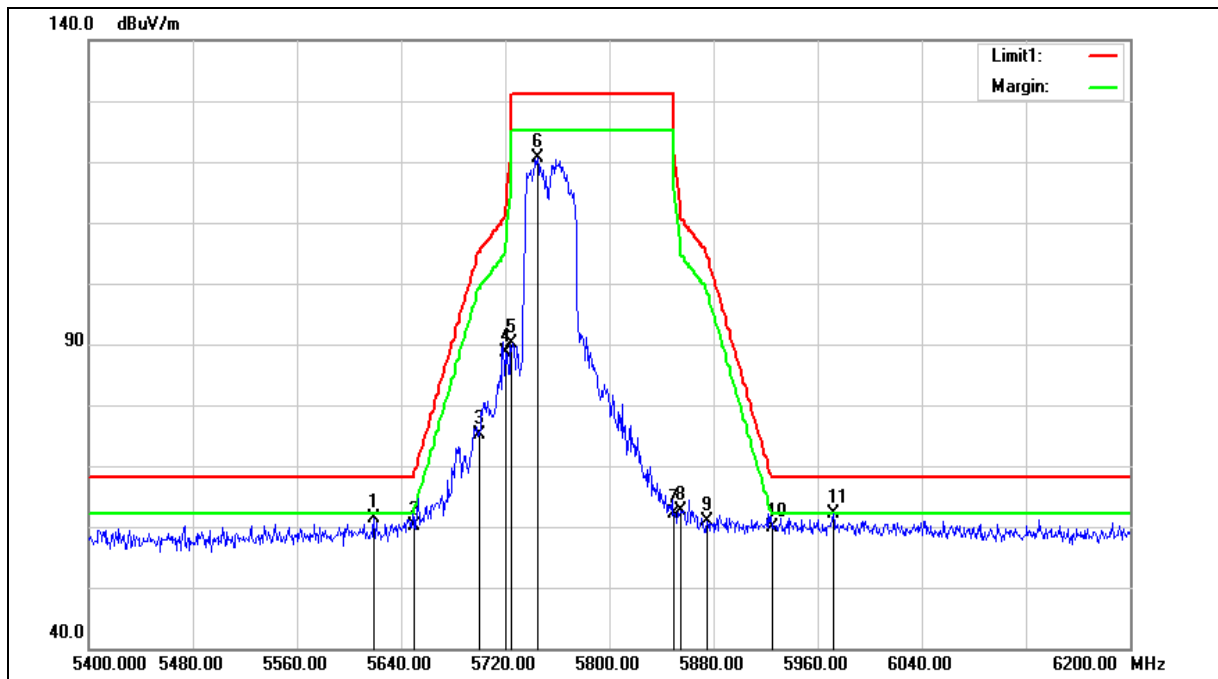

Standard:	FCC Part 15.407	Test Distance:	3 m
Test item:	Band edge		
Frequency:	5755 MHz		
Mode:	Mode 9		
Ant.Polar.:	Vertical		

No.	Frequency (MHz)	Reading (dBuV)	Correct Factor (dB/m)	Result (dBuV/m)	Limit (dBuV/m)	Margin (dB)	Remark
1	5619.200	60.47	0.89	61.36	68.20	-6.84	peak
2	5650.000	59.13	0.97	60.10	68.20	-8.10	peak
3	5700.000	74.08	1.11	75.19	105.20	-30.01	peak
4	5720.000	87.35	1.17	88.52	110.80	-22.28	peak
5	5725.000	89.01	1.18	90.19	122.20	-32.01	peak
6	5744.800	119.39	1.23	120.62	--	--	peak
7	5850.000	60.70	1.52	62.22	122.20	-59.98	peak
8	5855.000	61.11	1.53	62.64	110.80	-48.16	peak
9	5875.000	59.23	1.59	60.82	105.20	-44.38	peak
10	5925.000	58.18	1.72	59.90	68.20	-8.30	peak
11	5972.000	60.21	1.85	62.06	68.20	-6.14	peak

Note:1.Result (dBuV/m) = Correct Factor (dB/m) + Reading(dBuV).

2.Correction factor (dB/m) = Antenna Factor (dB/m) + Cable loss (dB) – Pre-Amplifier gain (dB).

3.When the peak results are less than average limit, so not need to evaluate the average.

Standard:	FCC Part 15.407	Test Distance:	3 m
Test item:	Band edge		
Frequency:	5795 MHz		
Mode:	Mode 9		
Ant.Polar.:	Horizontal		

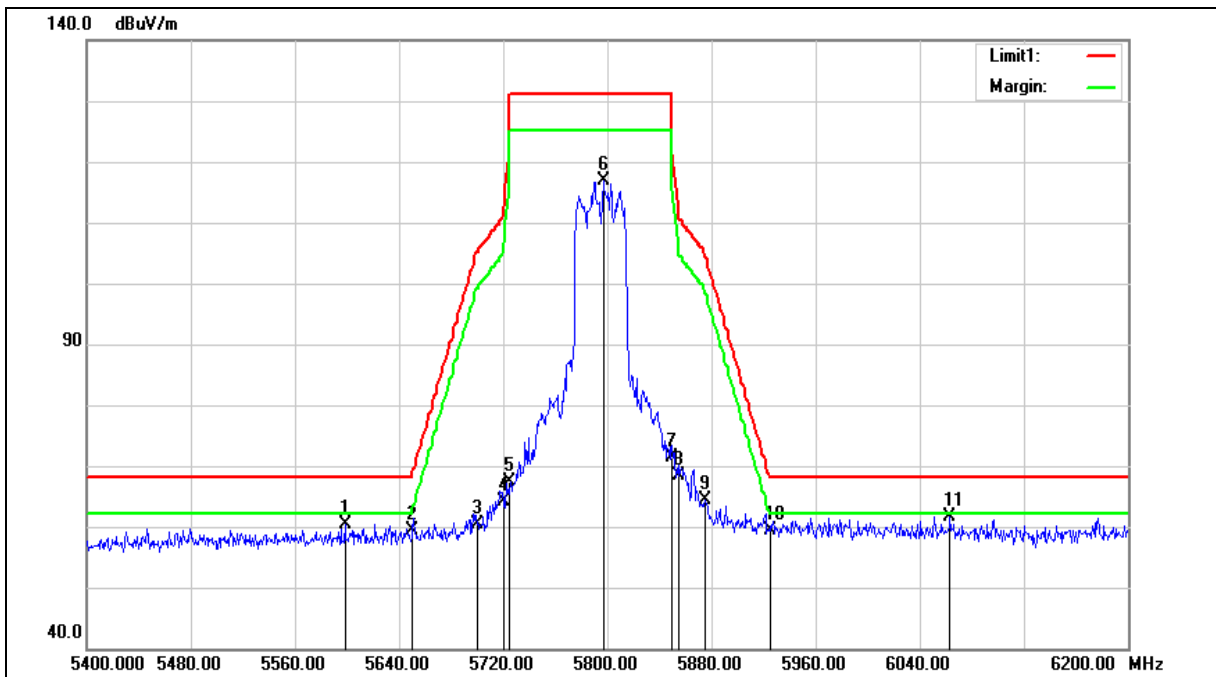

Standard:	FCC Part 15.407	Test Distance:	3 m
Test item:	Band edge		
Frequency:	5795 MHz		
Mode:	Mode 9		
Ant.Polar.:	Horizontal		

No.	Frequency (MHz)	Reading (dBuV)	Correct Factor (dB/m)	Result (dBuV/m)	Limit (dBuV/m)	Margin (dB)	Remark
1	5598.400	59.64	0.84	60.48	68.20	-7.72	peak
2	5650.000	58.46	0.97	59.43	68.20	-8.77	peak
3	5700.000	59.20	1.11	60.31	105.20	-44.89	peak
4	5720.000	62.97	1.17	64.14	110.80	-46.66	peak
5	5725.000	66.17	1.18	67.35	122.20	-54.85	peak
6	5796.800	115.39	1.38	116.77	--	--	peak
7	5850.000	69.95	1.52	71.47	122.20	-50.73	peak
8	5855.000	66.85	1.53	68.38	110.80	-42.42	peak
9	5875.000	62.70	1.59	64.29	105.20	-40.91	peak
10	5925.000	57.59	1.72	59.31	68.20	-8.89	peak
11	6063.200	59.53	2.16	61.69	68.20	-6.51	peak

Note:1.Result (dBuV/m) = Correct Factor (dB/m) + Reading(dBuV).

2.Correction factor (dB/m) = Antenna Factor (dB/m) + Cable loss (dB) – Pre-Amplifier gain (dB).

3.When the peak results are less than average limit, so not need to evaluate the average.

Standard:	FCC Part 15.407	Test Distance:	3 m
Test item:	Band edge		
Frequency:	5795 MHz		
Mode:	Mode 9		
Ant.Polar.:	Vertical		

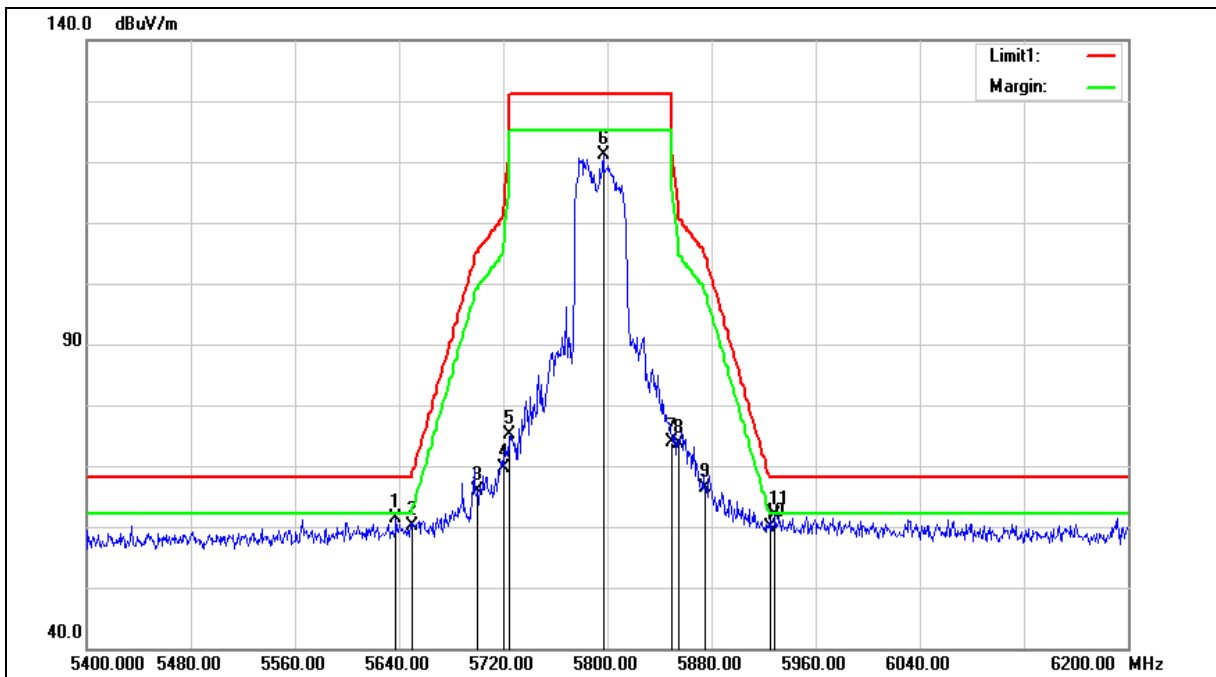

Standard:	FCC Part 15.407	Test Distance:	3 m
Test item:	Band edge		
Frequency:	5795 MHz		
Mode:	Mode 9		
Ant.Polar.:	Vertical		

No.	Frequency (MHz)	Reading (dBuV)	Correct Factor (dB/m)	Result (dBuV/m)	Limit (dBuV/m)	Margin (dB)	Remark
1	5637.600	60.32	0.95	61.27	68.20	-6.93	peak
2	5650.000	59.10	0.97	60.07	68.20	-8.13	peak
3	5700.000	64.67	1.11	65.78	105.20	-39.42	peak
4	5720.000	68.58	1.17	69.75	110.80	-41.05	peak
5	5725.000	74.02	1.18	75.20	122.20	-47.00	peak
6	5796.800	119.66	1.38	121.04	--	--	peak
7	5850.000	72.28	1.52	73.80	122.20	-48.40	peak
8	5855.000	72.08	1.53	73.61	110.80	-37.19	peak
9	5875.000	64.72	1.59	66.31	105.20	-38.89	peak
10	5925.000	58.19	1.72	59.91	68.20	-8.29	peak
11	5928.800	60.12	1.73	61.85	68.20	-6.35	peak

Note:1.Result (dBuV/m) = Correct Factor (dB/m) + Reading(dBuV).

2.Correction factor (dB/m) = Antenna Factor (dB/m) + Cable loss (dB) – Pre-Amplifier gain (dB).

3.When the peak results are less than average limit, so not need to evaluate the average.

Standard:	FCC Part 15.407	Test Distance:	3 m
Test item:	Band edge		
Frequency:	5210 MHz		
Mode:	Mode 10		
Ant.Polar.:	Horizontal		

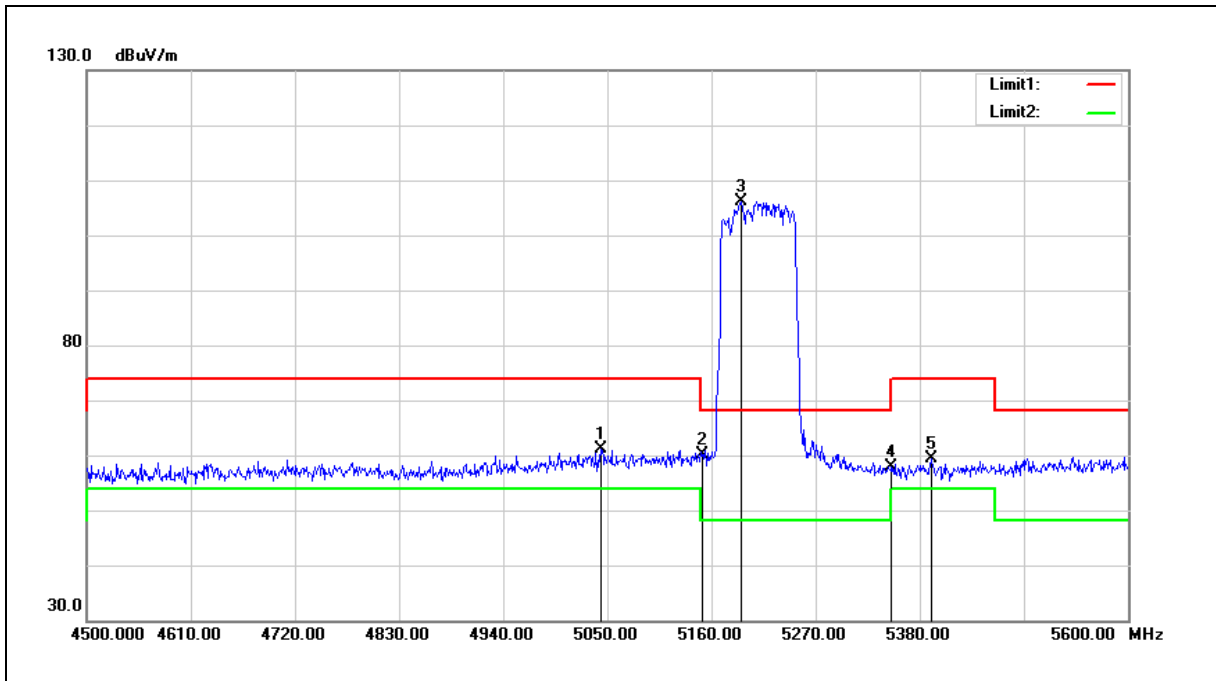

No.	Frequency (MHz)	Reading (dBuV)	Correct Factor (dB/m)	Result (dBuV/m)	Limit (dBuV/m)	Margin (dB)	Remark
1	5043.400	61.42	-0.29	61.13	74.00	-12.87	peak
2	5150.000	60.11	-0.08	60.03	74.00	-13.97	peak
3	5190.800	106.18	-0.01	106.17	--	--	peak
4	5350.000	57.57	0.30	57.87	74.00	-16.13	peak
5	5392.100	58.97	0.37	59.34	74.00	-14.66	peak

Note:1.Result (dBuV/m) = Correct Factor (dB/m) + Reading(dBuV).

2.Correction factor (dB/m) = Antenna Factor (dB/m) + Cable loss (dB) – Pre-Amplifier gain (dB).

3.When the peak results are less than average limit, so not need to evaluate the average.

Standard:	FCC Part 15.407	Test Distance:	3 m
Test item:	Band edge		
Frequency:	5210 MHz		
Mode:	Mode 10		
Ant.Polar.:	Vertical		

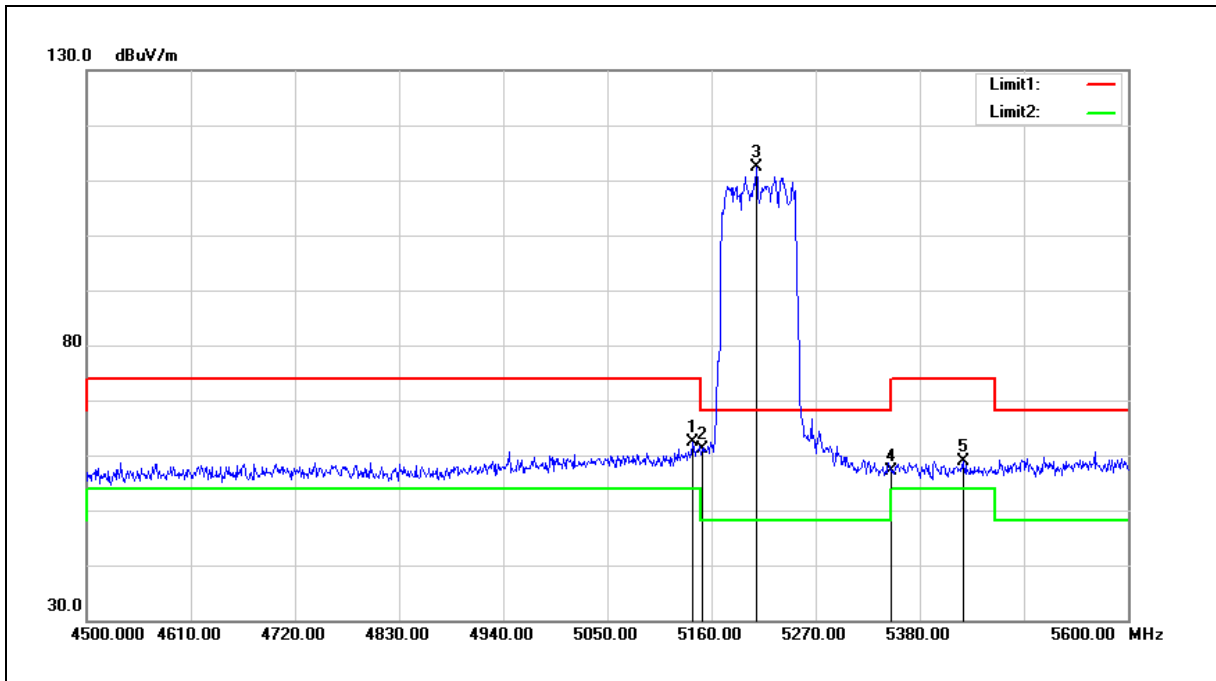

No.	Frequency (MHz)	Reading (dBuV)	Correct Factor (dB/m)	Result (dBuV/m)	Limit (dBuV/m)	Margin (dB)	Remark
1	5140.200	62.54	-0.10	62.44	74.00	-11.56	peak
2	5150.000	61.26	-0.08	61.18	74.00	-12.82	peak
3	5207.300	112.36	0.03	112.39	--	--	peak
4	5350.000	56.87	0.30	57.17	74.00	-16.83	peak
5	5426.200	58.44	0.43	58.87	74.00	-15.13	peak

Note:1.Result (dBuV/m) = Correct Factor (dB/m) + Reading(dBuV).

2.Correction factor (dB/m) = Antenna Factor (dB/m) + Cable loss (dB) – Pre-Amplifier gain (dB).

3.When the peak results are less than average limit, so not need to evaluate the average.

Standard:	FCC Part 15.407	Test Distance:	3 m
Test item:	Band edge		
Frequency:	5290 MHz		
Mode:	Mode 10		
Ant.Polar.:	Horizontal		

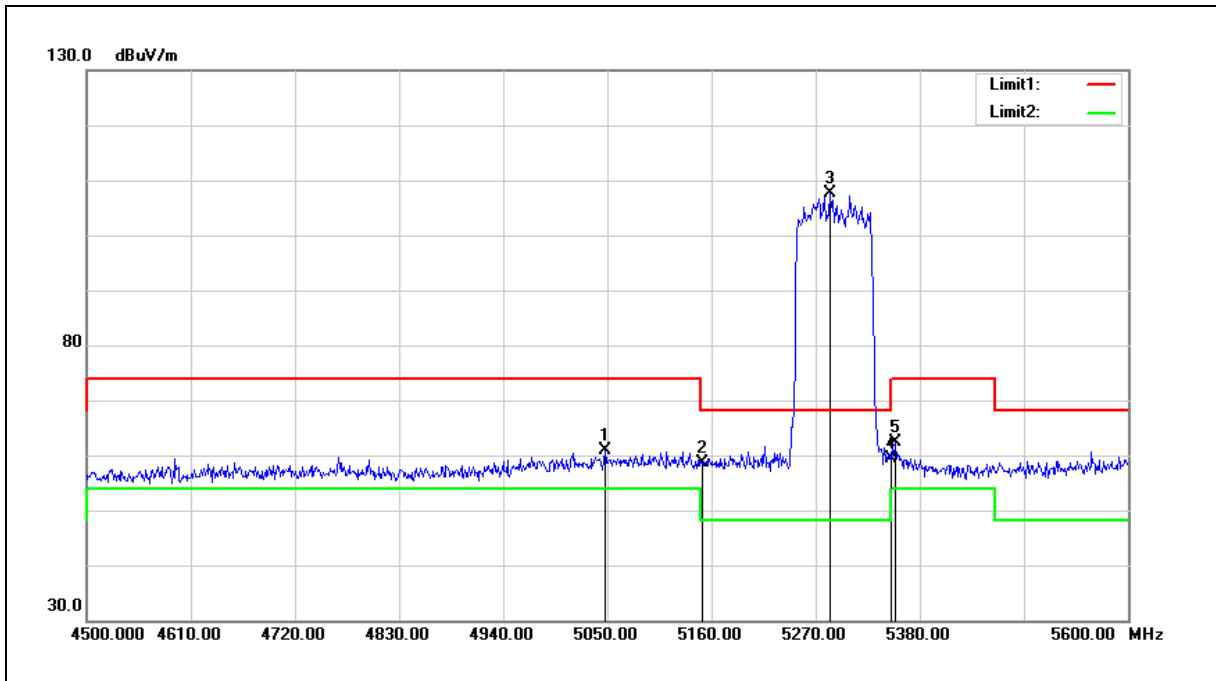

No.	Frequency (MHz)	Reading (dBuV)	Correct Factor (dB/m)	Result (dBuV/m)	Limit (dBuV/m)	Margin (dB)	Remark
1	5047.800	61.20	-0.27	60.93	74.00	-13.07	peak
2	5150.000	58.62	-0.08	58.54	74.00	-15.46	peak
3	5285.400	107.43	0.18	107.61	--	--	peak
4	5350.000	59.19	0.30	59.49	74.00	-14.51	peak
5	5354.700	61.96	0.30	62.26	74.00	-11.74	peak

Note:1.Result (dBuV/m) = Correct Factor (dB/m) + Reading(dBuV).

2.Correction factor (dB/m) = Antenna Factor (dB/m) + Cable loss (dB) – Pre-Amplifier gain (dB).

3.When the peak results are less than average limit, so not need to evaluate the average.

Standard:	FCC Part 15.407	Test Distance:	3 m
Test item:	Band edge		
Frequency:	5290 MHz		
Mode:	Mode 10		
Ant.Polar.:	Vertical		

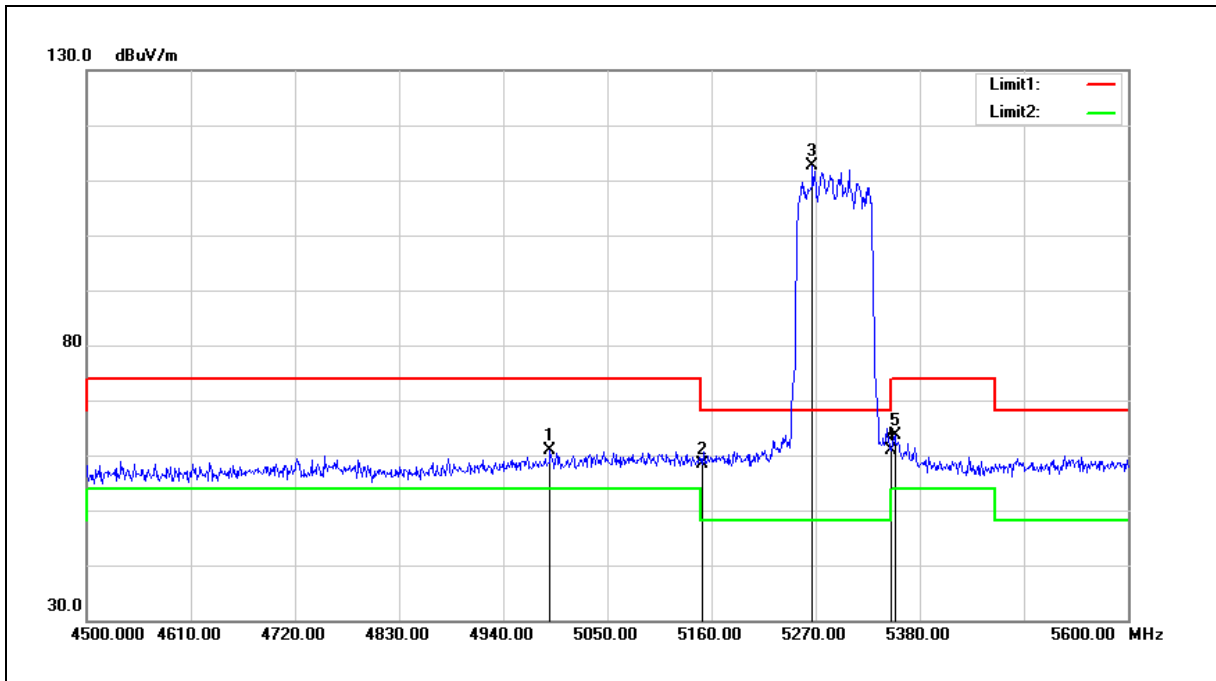

No.	Frequency (MHz)	Reading (dBuV)	Correct Factor (dB/m)	Result (dBuV/m)	Limit (dBuV/m)	Margin (dB)	Remark
1	4989.500	61.29	-0.39	60.90	74.00	-13.10	peak
2	5150.000	58.40	-0.08	58.32	74.00	-15.68	peak
3	5266.700	112.59	0.13	112.72	--	--	peak
4	5350.000	60.48	0.30	60.78	74.00	-13.22	peak
5	5353.600	63.44	0.30	63.74	74.00	-10.26	peak

Note:1.Result (dBuV/m) = Correct Factor (dB/m) + Reading(dBuV).

2.Correction factor (dB/m) = Antenna Factor (dB/m) + Cable loss (dB) – Pre-Amplifier gain (dB).

3.When the peak results are less than average limit, so not need to evaluate the average.

Standard:	FCC Part 15.407	Test Distance:	3 m
Test item:	Band edge		
Frequency:	5530 MHz		
Mode:	Mode 10		
Ant.Polar.:	Horizontal		

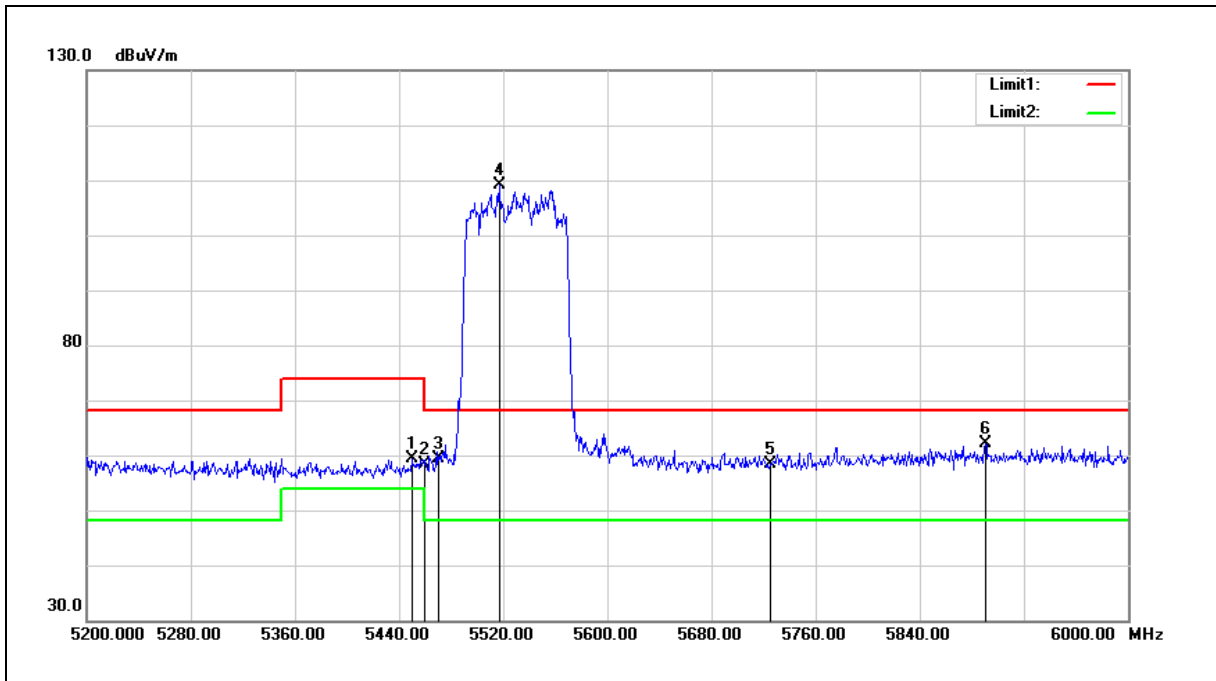

No.	Frequency (MHz)	Reading (dBuV)	Correct Factor (dB/m)	Result (dBuV/m)	Limit (dBuV/m)	Margin (dB)	Remark
1	5449.600	59.00	0.48	59.48	74.00	-14.52	peak
2	5460.000	57.97	0.51	58.48	74.00	-15.52	peak
3	5470.000	58.76	0.52	59.28	68.20	-8.92	peak
4	5516.800	108.59	0.62	109.21	--	--	peak
5	5725.000	57.09	1.18	58.27	68.20	-9.93	peak
6	5890.400	60.50	1.63	62.13	68.20	-6.07	peak

Note: 1. Result (dBuV/m) = Correct Factor (dB/m) + Reading(dBuV).

2. Correction factor (dB/m) = Antenna Factor (dB/m) + Cable loss (dB) – Pre-Amplifier gain (dB).

3. When the peak results are less than average limit, so not need to evaluate the average.

Standard:	FCC Part 15.407	Test Distance:	3 m
Test item:	Band edge		
Frequency:	5530 MHz		
Mode:	Mode 10		
Ant.Polar.:	Vertical		

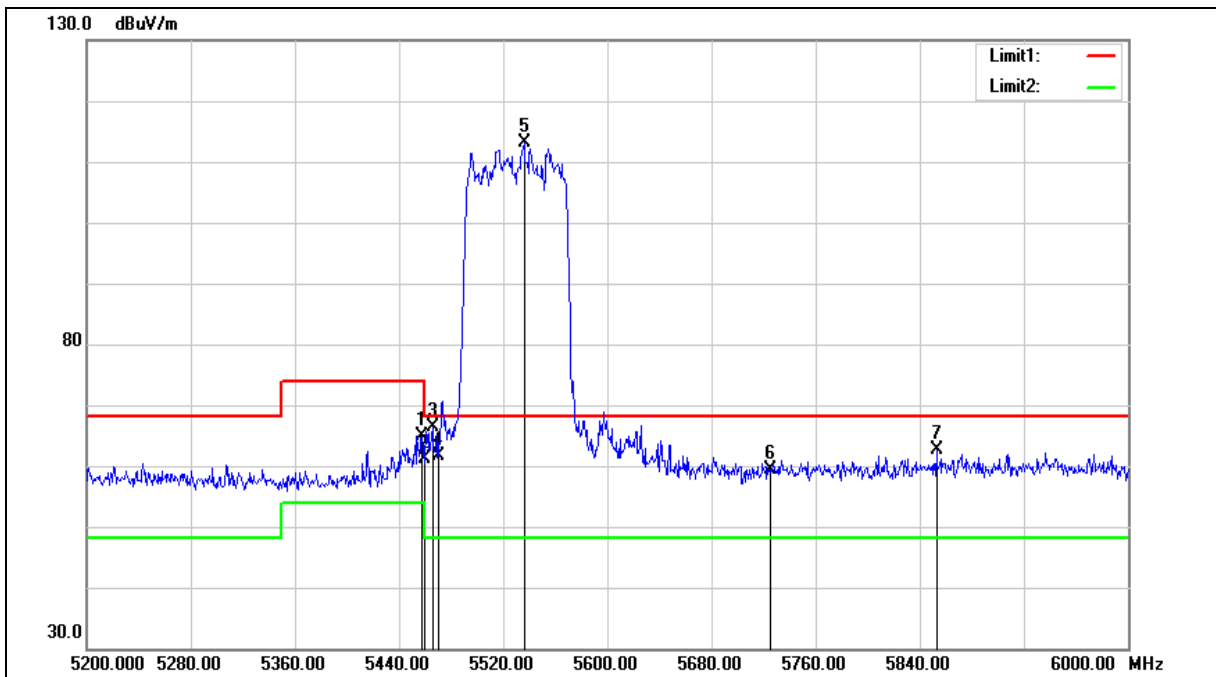

Standard:	FCC Part 15.407	Test Distance:	3 m
Test item:	Band edge		
Frequency:	5530 MHz		
Mode:	Mode 10		
Ant.Polar.:	Vertical		

No.	Frequency (MHz)	Reading (dBuV)	Correct Factor (dB/m)	Result (dBuV/m)	Limit (dBuV/m)	Margin (dB)	Remark
1	5457.600	64.35	0.50	64.85	74.00	-9.15	peak
2	5460.000	60.72	0.51	61.23	74.00	-12.77	peak
3	5465.600	65.77	0.51	66.28	68.20	-1.92	peak
4	5470.000	61.03	0.52	61.55	68.20	-6.65	peak
5	5536.000	112.46	0.67	113.13	--	--	peak
6	5725.000	58.08	1.18	59.26	68.20	-8.94	peak
7	5852.800	61.00	1.52	62.52	68.20	-5.68	peak

Note:1.Result (dBuV/m) = Correct Factor (dB/m) + Reading(dBuV).

2.Correction factor (dB/m) = Antenna Factor (dB/m) + Cable loss (dB) – Pre-Amplifier gain (dB).

3.When the peak results are less than average limit, so not need to evaluate the average.

Standard:	FCC Part 15.407	Test Distance:	3 m
Test item:	Band edge		
Frequency:	5775 MHz		
Mode:	Mode 10		
Ant.Polar.:	Horizontal		

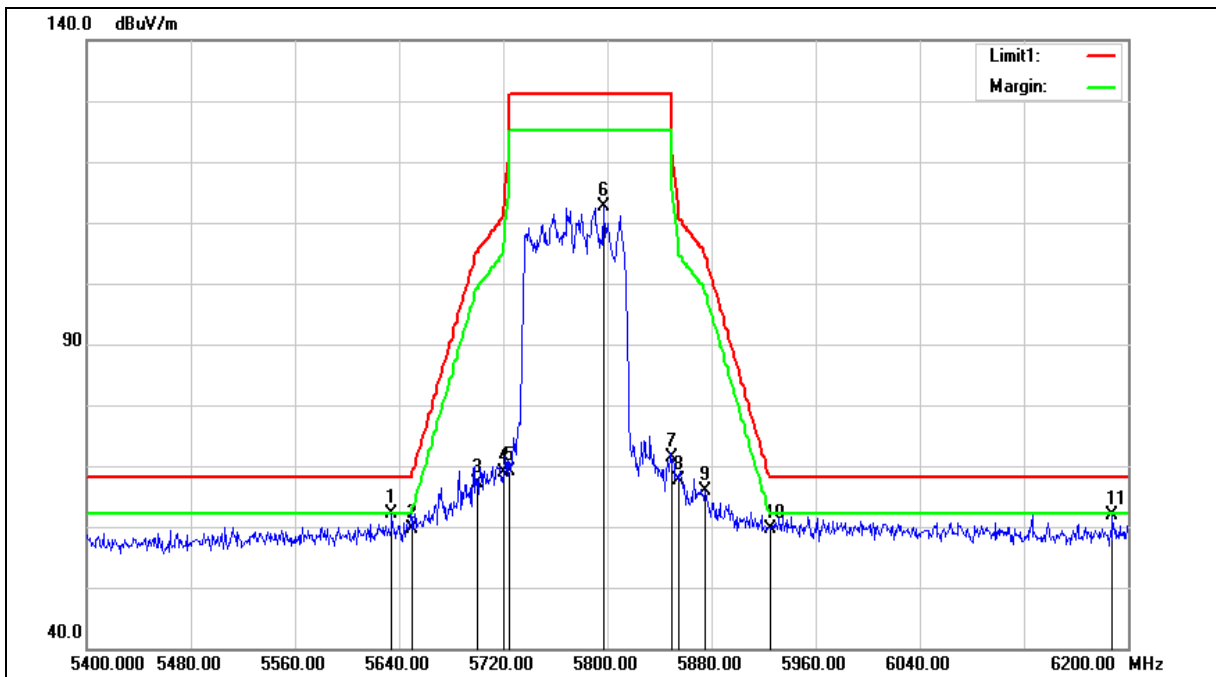

Standard:	FCC Part 15.407	Test Distance:	3 m
Test item:	Band edge		
Frequency:	5775 MHz		
Mode:	Mode 10		
Ant.Polar.:	Horizontal		

No.	Frequency (MHz)	Reading (dBuV)	Correct Factor (dB/m)	Result (dBuV/m)	Limit (dBuV/m)	Margin (dB)	Remark
1	5634.400	61.21	0.93	62.14	68.20	-6.06	peak
2	5650.000	58.67	0.97	59.64	68.20	-8.56	peak
3	5700.000	66.11	1.11	67.22	105.20	-37.98	peak
4	5720.000	67.63	1.17	68.80	110.80	-42.00	peak
5	5725.000	67.85	1.18	69.03	122.20	-53.17	peak
6	5796.800	111.28	1.38	112.66	--	--	peak
7	5850.000	69.81	1.52	71.33	122.20	-50.87	peak
8	5855.000	65.98	1.53	67.51	110.80	-43.29	peak
9	5875.000	64.36	1.59	65.95	105.20	-39.25	peak
10	5925.000	57.84	1.72	59.56	68.20	-8.64	peak
11	6188.000	59.32	2.64	61.96	68.20	-6.24	peak

Note:1.Result (dBuV/m) = Correct Factor (dB/m) + Reading(dBuV).

2.Correction factor (dB/m) = Antenna Factor (dB/m) + Cable loss (dB) – Pre-Amplifier gain (dB).

3.When the peak results are less than average limit, so not need to evaluate the average.

Standard:	FCC Part 15.407	Test Distance:	3 m
Test item:	Band edge		
Frequency:	5775 MHz		
Mode:	Mode 10		
Ant.Polar.:	Vertical		

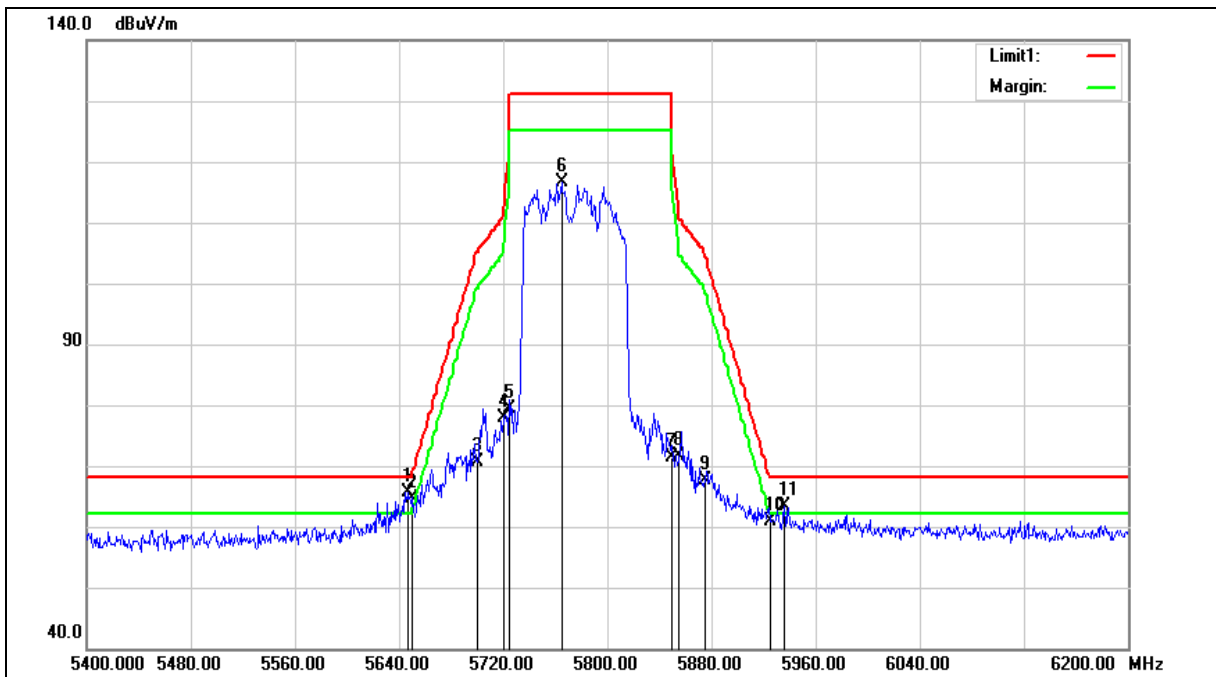

Standard:	FCC Part 15.407	Test Distance:	3 m
Test item:	Band edge		
Frequency:	5775 MHz		
Mode:	Mode 10		
Ant.Polar.:	Vertical		

No.	Frequency (MHz)	Reading (dBuV)	Correct Factor (dB/m)	Result (dBuV/m)	Limit (dBuV/m)	Margin (dB)	Remark
1	5647.200	64.75	0.97	65.72	68.20	-2.48	peak
2	5650.000	63.78	0.97	64.75	68.20	-3.45	peak
3	5700.000	69.43	1.11	70.54	105.20	-34.66	peak
4	5720.000	76.73	1.17	77.90	110.80	-32.90	peak
5	5725.000	78.27	1.18	79.45	122.20	-42.75	peak
6	5764.800	115.22	1.29	116.51	--	--	peak
7	5850.000	69.84	1.52	71.36	122.20	-50.84	peak
8	5855.000	70.21	1.53	71.74	110.80	-39.06	peak
9	5875.000	65.93	1.59	67.52	105.20	-37.68	peak
10	5925.000	59.25	1.72	60.97	68.20	-7.23	peak
11	5936.000	61.73	1.74	63.47	68.20	-4.73	peak

Note:1.Result (dBuV/m) = Correct Factor (dB/m) + Reading(dBuV).

2.Correction factor (dB/m) = Antenna Factor (dB/m) + Cable loss (dB) – Pre-Amplifier gain (dB).

3.When the peak results are less than average limit, so not need to evaluate the average.

Average

Standard:	FCC Part 15.407	Test Distance:	3 m
Test item:	Band edge		
Frequency:	5180 MHz		
Mode:	Mode 2		
Ant.Polar.:	Horizontal		

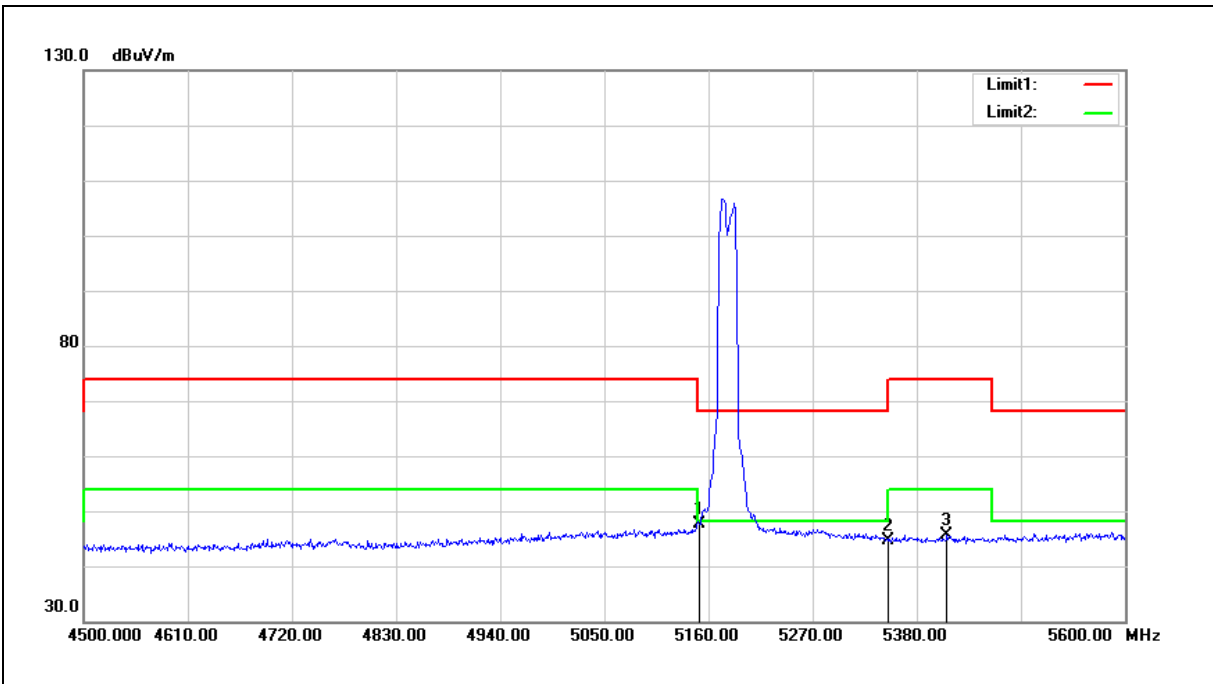

No.	Frequency (MHz)	Reading (dBuV)	Correct Factor (dB/m)	Result (dBuV/m)	Limit (dBuV/m)	Margin (dB)	Remark
1	5150.000	47.66	-0.08	47.58	54.00	-6.42	AVG
2	5350.000	44.32	0.30	44.62	54.00	-9.38	AVG
3	5411.900	45.25	0.41	45.66	54.00	-8.34	AVG

Note:1.Result (dBuV/m) = Correct Factor (dB/m) + Reading(dBuV).
 2.Correction factor (dB/m) = Antenna Factor (dB/m) + Cable loss (dB) – Pre-Amplifier gain (dB).
 3.When the peak results are less than average limit, so not need to evaluate the average.

Standard:	FCC Part 15.407	Test Distance:	3 m
Test item:	Band edge		
Frequency:	5180 MHz		
Mode:	Mode 2		
Ant.Polar.:	Vertical		

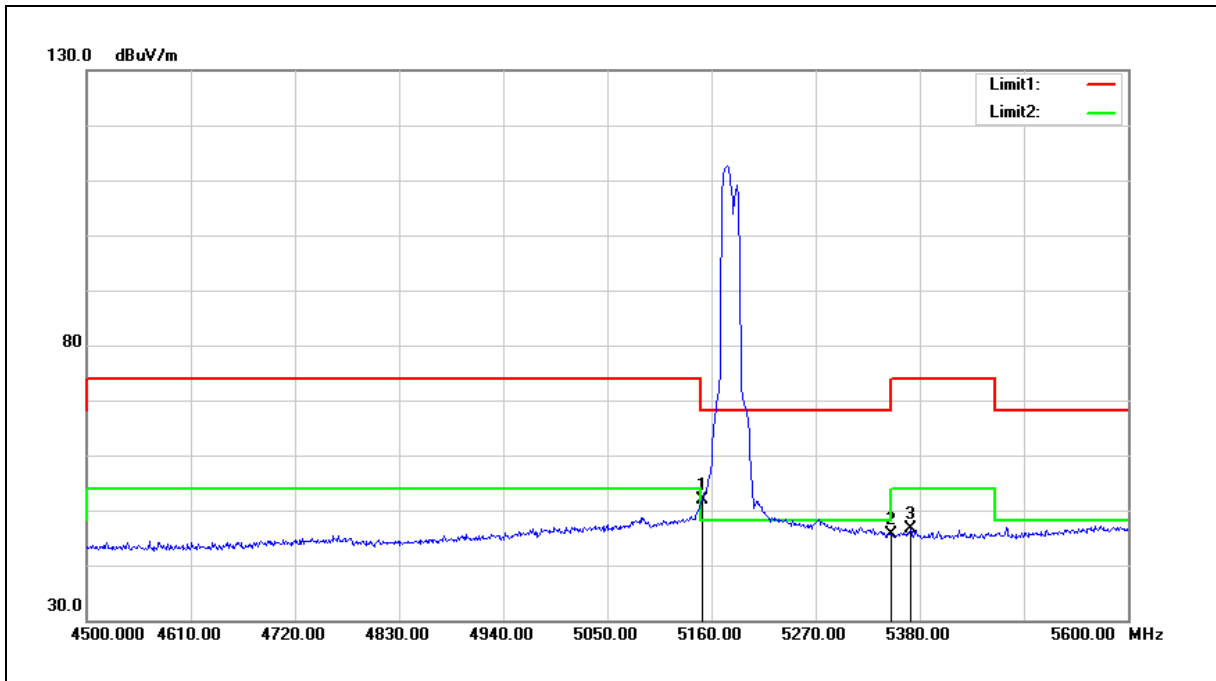

No.	Frequency (MHz)	Reading (dBuV)	Correct Factor (dB/m)	Result (dBuV/m)	Limit (dBuV/m)	Margin (dB)	Remark
1	5150.000	52.04	-0.08	51.96	54.00	-2.04	AVG
2	5350.000	45.29	0.30	45.59	54.00	-8.41	AVG
3	5370.100	46.19	0.34	46.53	54.00	-7.47	AVG

Note:1.Result (dBuV/m) = Correct Factor (dB/m) + Reading(dBuV).

2.Correction factor (dB/m) = Antenna Factor (dB/m) + Cable loss (dB) – Pre-Amplifier gain (dB).

3.When the peak results are less than average limit, so not need to evaluate the average.

Standard:	FCC Part 15.407	Test Distance:	3 m
Test item:	Band edge		
Frequency:	5200 MHz		
Mode:	Mode 2		
Ant.Polar.:	Horizontal		

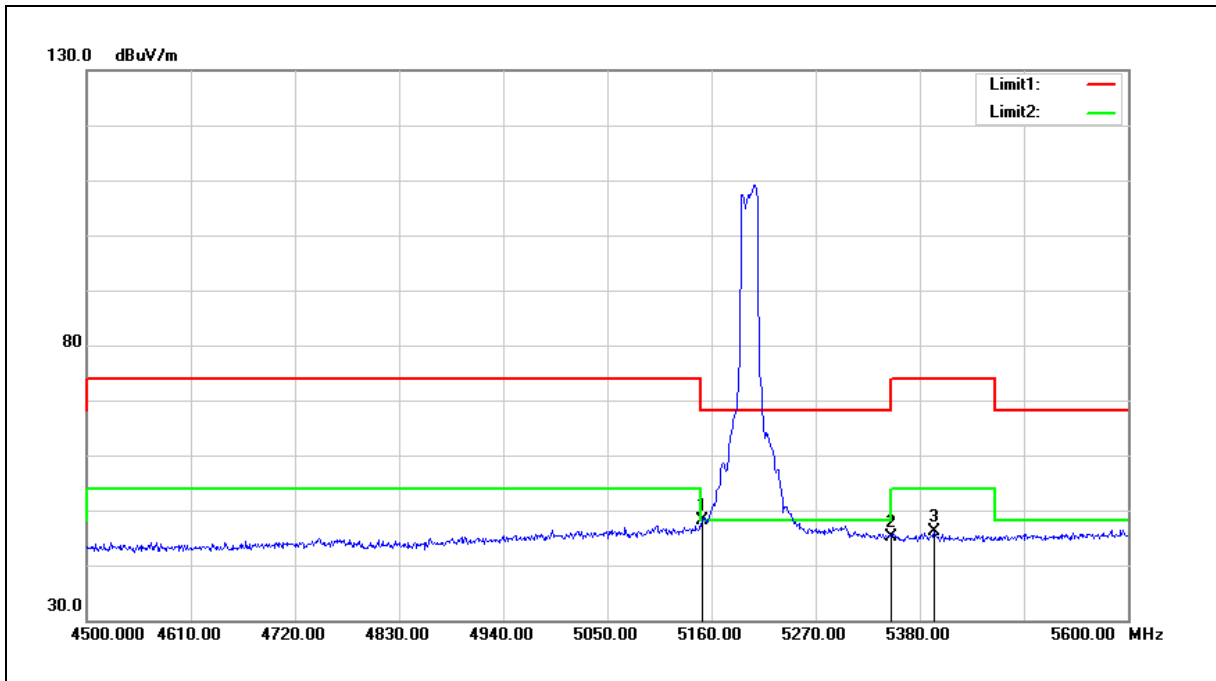

No.	Frequency (MHz)	Reading (dBuV)	Correct Factor (dB/m)	Result (dBuV/m)	Limit (dBuV/m)	Margin (dB)	Remark
1	5150.000	48.22	-0.08	48.14	54.00	-5.86	AVG
2	5350.000	44.90	0.30	45.20	54.00	-8.80	AVG
3	5395.400	45.83	0.38	46.21	54.00	-7.79	AVG

Note:1.Result (dBuV/m) = Correct Factor (dB/m) + Reading(dBuV).

2.Correction factor (dB/m) = Antenna Factor (dB/m) + Cable loss (dB) – Pre-Amplifier gain (dB).

3.When the peak results are less than average limit, so not need to evaluate the average.

Standard:	FCC Part 15.407	Test Distance:	3 m
Test item:	Band edge		
Frequency:	5200 MHz		
Mode:	Mode 2		
Ant.Polar.:	Vertical		

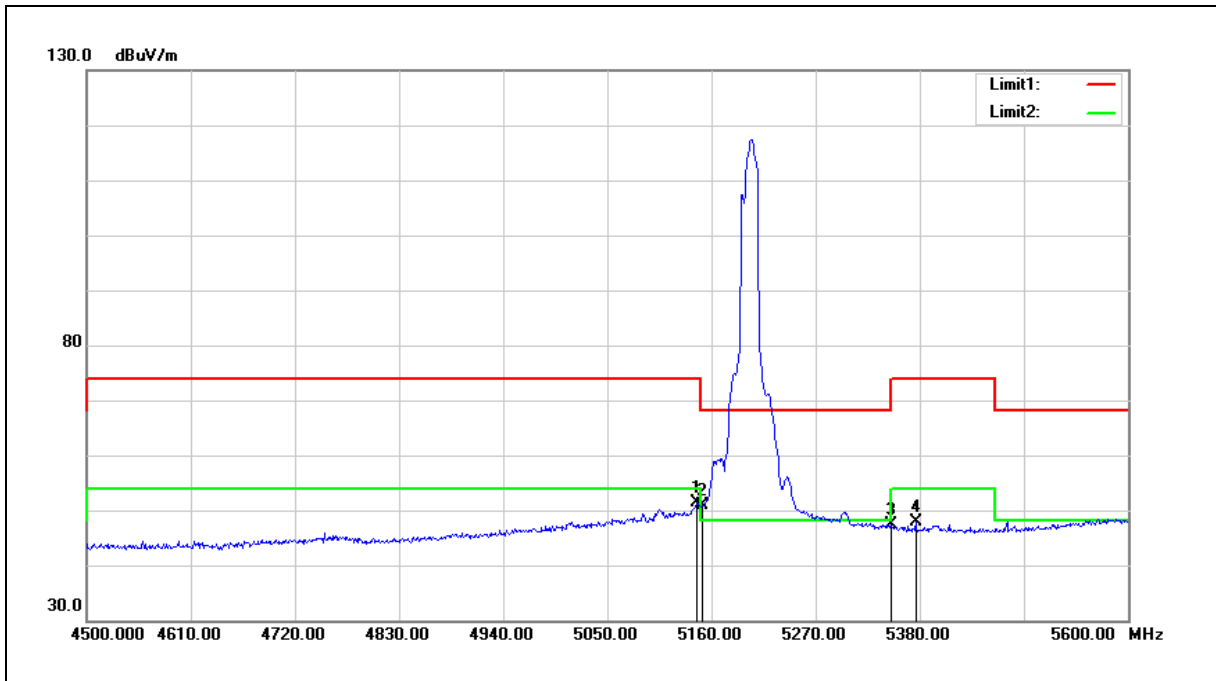

No.	Frequency (MHz)	Reading (dBuV)	Correct Factor (dB/m)	Result (dBuV/m)	Limit (dBuV/m)	Margin (dB)	Remark
1	5144.600	51.55	-0.08	51.47	54.00	-2.53	AVG
2	5150.000	50.92	-0.08	50.84	54.00	-3.16	AVG
3	5350.000	46.97	0.30	47.27	54.00	-6.73	AVG
4	5375.600	47.51	0.34	47.85	54.00	-6.15	AVG

Note:1.Result (dBuV/m) = Correct Factor (dB/m) + Reading(dBuV).

2.Correction factor (dB/m) = Antenna Factor (dB/m) + Cable loss (dB) – Pre-Amplifier gain (dB).

3.When the peak results are less than average limit, so not need to evaluate the average.

Standard:	FCC Part 15.407	Test Distance:	3 m
Test item:	Band edge		
Frequency:	5240 MHz		
Mode:	Mode 2		
Ant.Polar.:	Horizontal		

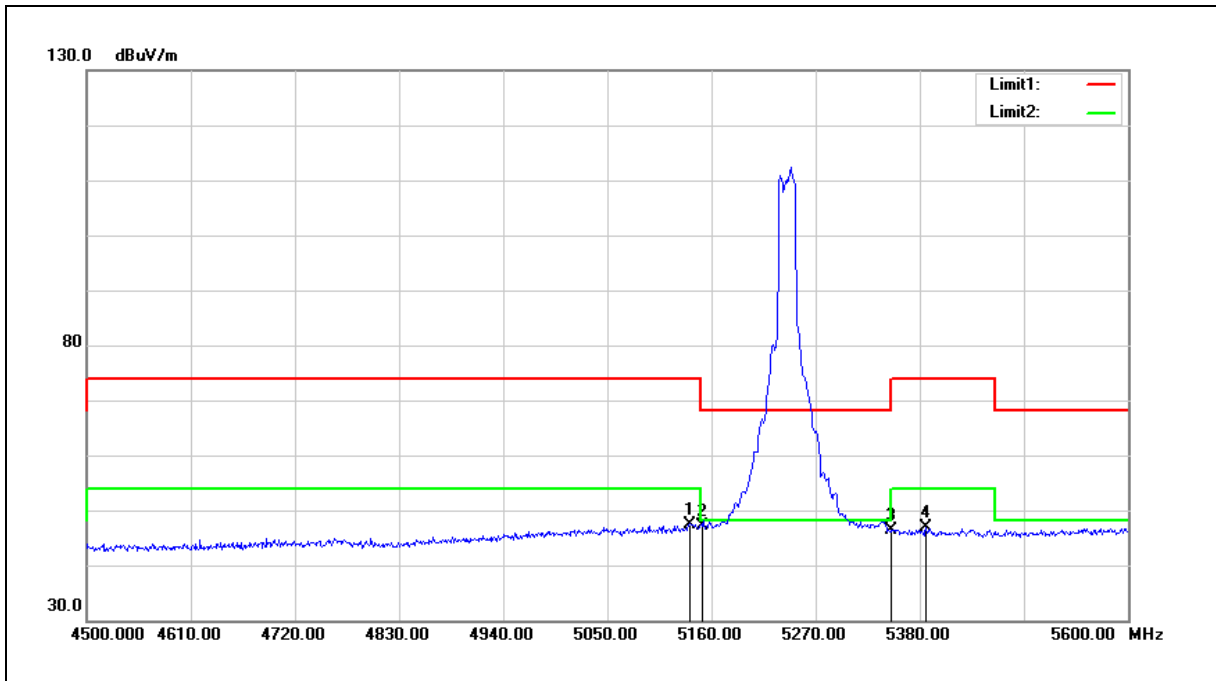

No.	Frequency (MHz)	Reading (dBuV)	Correct Factor (dB/m)	Result (dBuV/m)	Limit (dBuV/m)	Margin (dB)	Remark
1	5136.900	47.60	-0.10	47.50	54.00	-6.50	AVG
2	5150.000	47.29	-0.08	47.21	54.00	-6.79	AVG
3	5350.000	46.05	0.30	46.35	54.00	-7.65	AVG
4	5386.600	46.43	0.36	46.79	54.00	-7.21	AVG

Note:1.Result (dBuV/m) = Correct Factor (dB/m) + Reading(dBuV).

2.Correction factor (dB/m) = Antenna Factor (dB/m) + Cable loss (dB) – Pre-Amplifier gain (dB).

3.When the peak results are less than average limit, so not need to evaluate the average.

Standard:	FCC Part 15.407	Test Distance:	3 m
Test item:	Band edge		
Frequency:	5240 MHz		
Mode:	Mode 2		
Ant.Polar.:	Vertical		

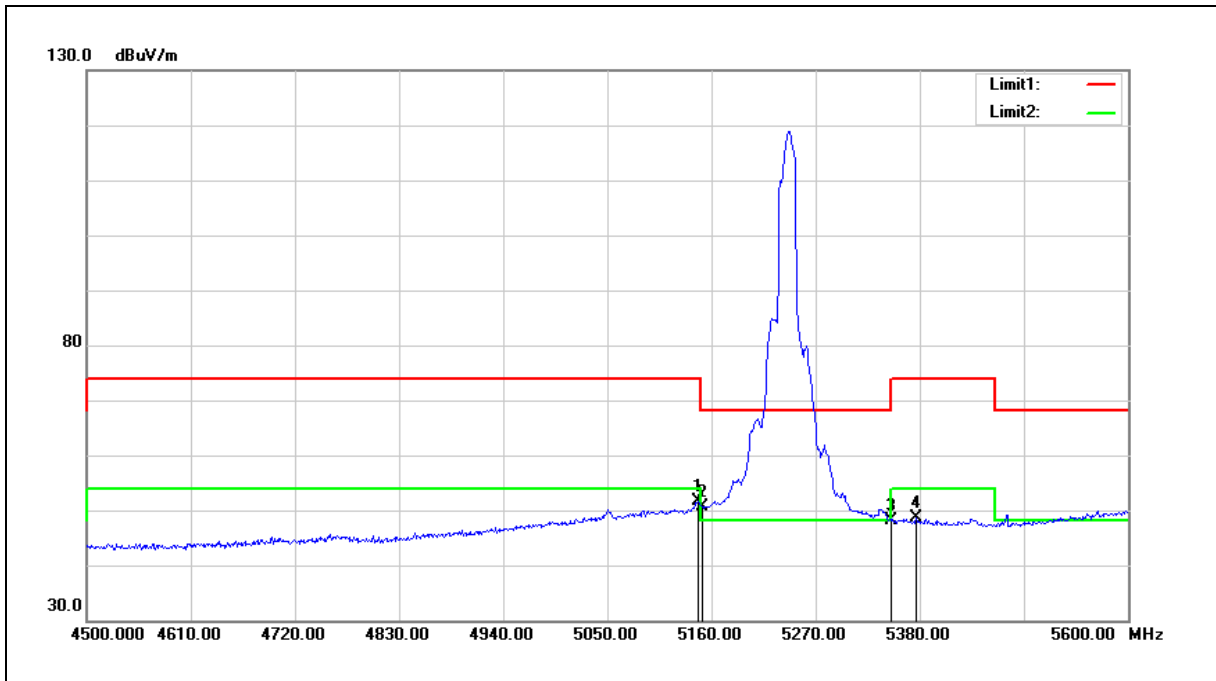

No.	Frequency (MHz)	Reading (dBuV)	Correct Factor (dB/m)	Result (dBuV/m)	Limit (dBuV/m)	Margin (dB)	Remark
1	5145.700	51.60	-0.08	51.52	54.00	-2.48	AVG
2	5150.000	50.81	-0.08	50.73	54.00	-3.27	AVG
3	5350.000	47.90	0.30	48.20	54.00	-5.80	AVG
4	5375.600	48.34	0.34	48.68	54.00	-5.32	AVG

Note:1.Result (dBuV/m) = Correct Factor (dB/m) + Reading(dBuV).

2.Correction factor (dB/m) = Antenna Factor (dB/m) + Cable loss (dB) – Pre-Amplifier gain (dB).

3.When the peak results are less than average limit, so not need to evaluate the average.

Standard:	FCC Part 15.407	Test Distance:	3 m
Test item:	Band edge		
Frequency:	5260 MHz		
Mode:	Mode 2		
Ant.Polar.:	Horizontal		

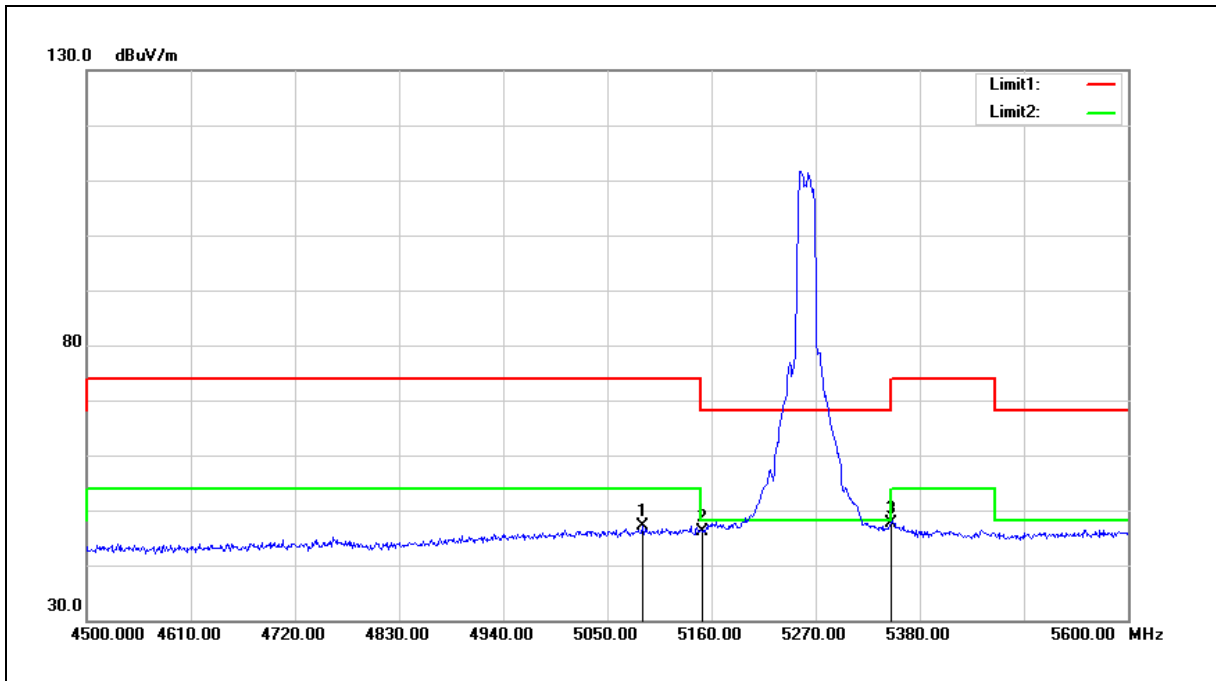

No.	Frequency (MHz)	Reading (dBuV)	Correct Factor (dB/m)	Result (dBuV/m)	Limit (dBuV/m)	Margin (dB)	Remark
1	5087.400	47.29	-0.20	47.09	54.00	-6.91	AVG
2	5150.000	46.21	-0.08	46.13	54.00	-7.87	AVG
3	5350.000	47.41	0.30	47.71	54.00	-6.29	AVG

Note:1.Result (dBuV/m) = Correct Factor (dB/m) + Reading(dBuV).

2.Correction factor (dB/m) = Antenna Factor (dB/m) + Cable loss (dB) – Pre-Amplifier gain (dB).

3.When the peak results are less than average limit, so not need to evaluate the average.

Standard:	FCC Part 15.407	Test Distance:	3 m
Test item:	Band edge		
Frequency:	5260 MHz		
Mode:	Mode 2		
Ant.Polar.:	Vertical		

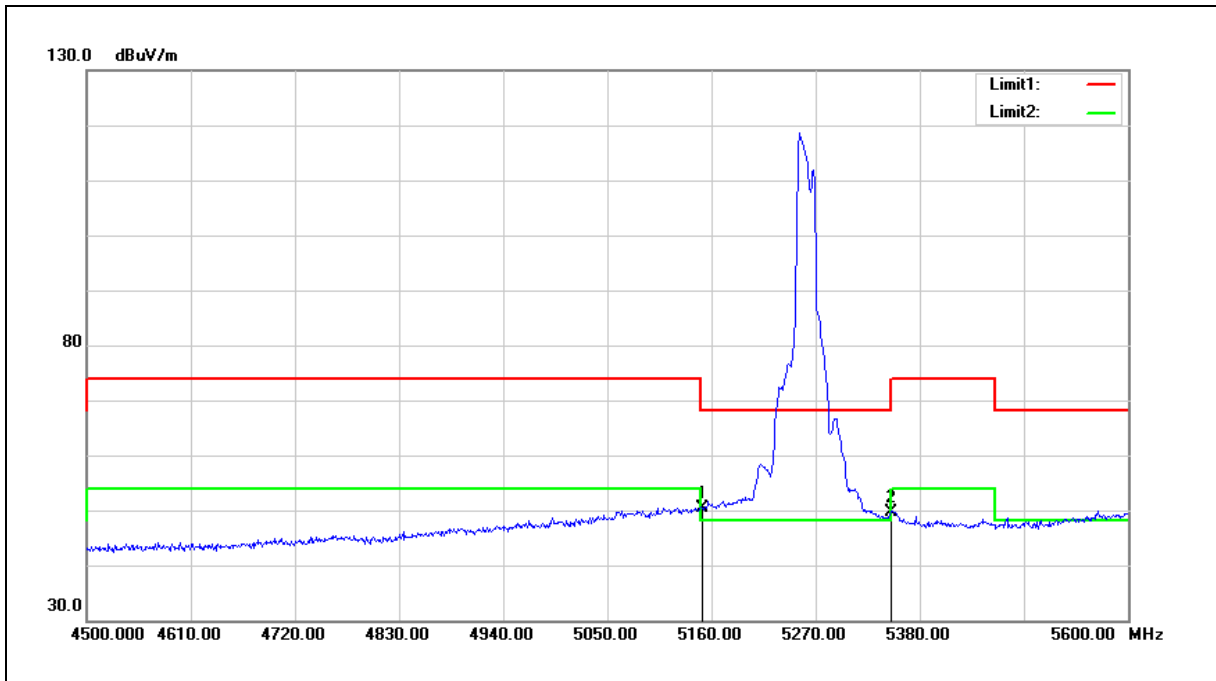

No.	Frequency (MHz)	Reading (dBuV)	Correct Factor (dB/m)	Result (dBuV/m)	Limit (dBuV/m)	Margin (dB)	Remark
1	5150.000	50.58	-0.08	50.50	54.00	-3.50	AVG
2	5350.000	49.30	0.30	49.60	54.00	-4.40	AVG

Note:1.Result (dBuV/m) = Correct Factor (dB/m) + Reading(dBuV).

2.Correction factor (dB/m) = Antenna Factor (dB/m) + Cable loss (dB) – Pre-Amplifier gain (dB).

3.When the peak results are less than average limit, so not need to evaluate the average.

Standard:	FCC Part 15.407	Test Distance:	3 m
Test item:	Band edge		
Frequency:	5280 MHz		
Mode:	Mode 2		
Ant.Polar.:	Horizontal		

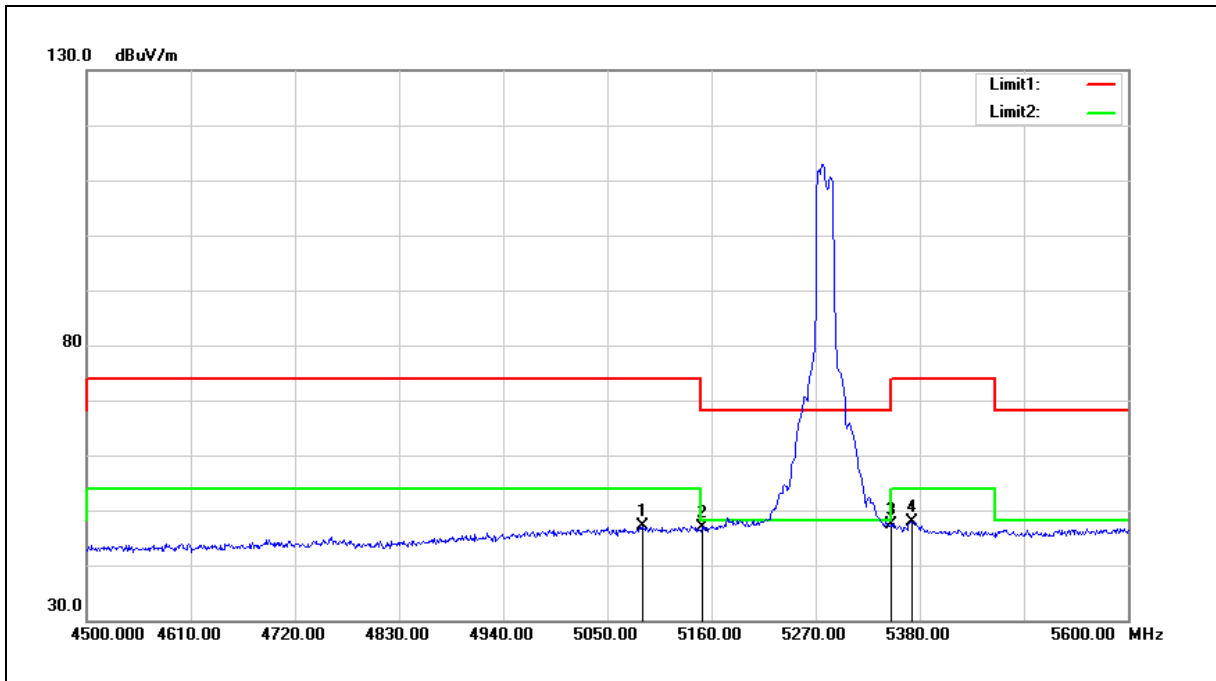

No.	Frequency (MHz)	Reading (dBuV)	Correct Factor (dB/m)	Result (dBuV/m)	Limit (dBuV/m)	Margin (dB)	Remark
1	5087.400	47.40	-0.20	47.20	54.00	-6.80	AVG
2	5150.000	47.01	-0.08	46.93	54.00	-7.07	AVG
3	5350.000	47.04	0.30	47.34	54.00	-6.66	AVG
4	5372.300	47.52	0.34	47.86	54.00	-6.14	AVG

Note:1.Result (dBuV/m) = Correct Factor (dB/m) + Reading(dBuV).

2.Correction factor (dB/m) = Antenna Factor (dB/m) + Cable loss (dB) – Pre-Amplifier gain (dB).

3.When the peak results are less than average limit, so not need to evaluate the average.

Standard:	FCC Part 15.407	Test Distance:	3 m
Test item:	Band edge		
Frequency:	5280 MHz		
Mode:	Mode 2		
Ant.Polar.:	Vertical		

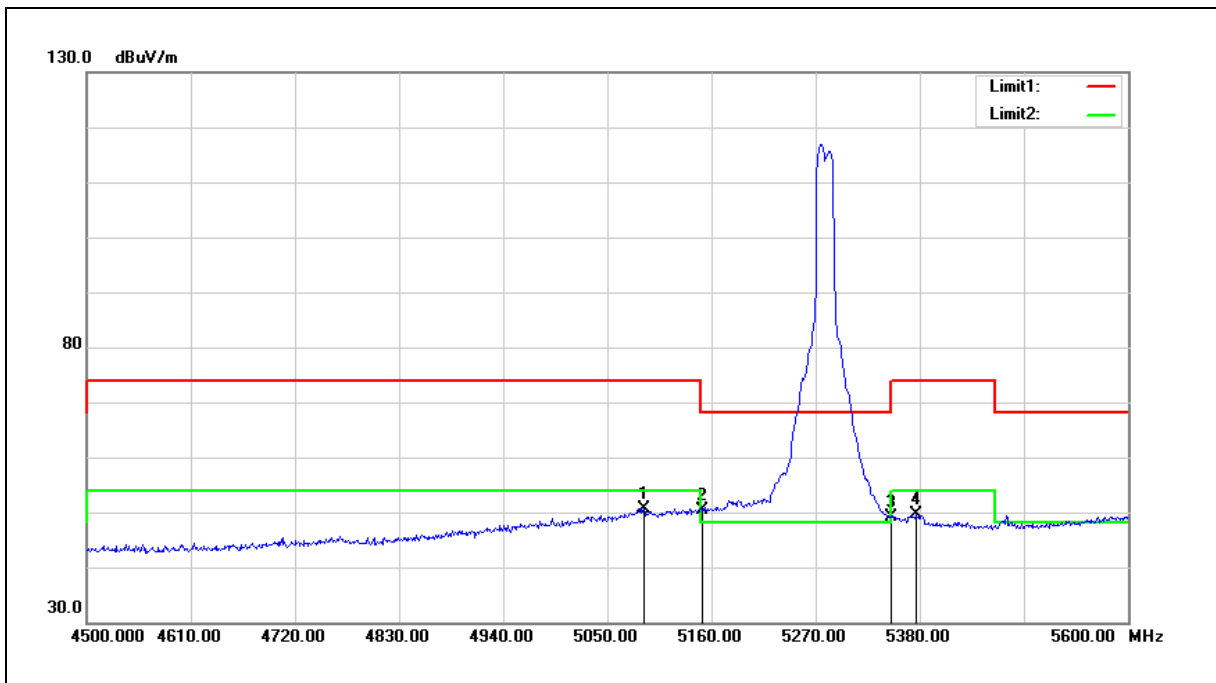

No.	Frequency (MHz)	Reading (dBuV)	Correct Factor (dB/m)	Result (dBuV/m)	Limit (dBuV/m)	Margin (dB)	Remark
1	5088.500	50.79	-0.20	50.59	54.00	-3.41	AVG
2	5150.000	50.50	-0.08	50.42	54.00	-3.58	AVG
3	5350.000	48.85	0.30	49.15	54.00	-4.85	AVG
4	5375.600	49.23	0.34	49.57	54.00	-4.43	AVG

Note:1.Result (dBuV/m) = Correct Factor (dB/m) + Reading(dBuV).

2.Correction factor (dB/m) = Antenna Factor (dB/m) + Cable loss (dB) – Pre-Amplifier gain (dB).

3.When the peak results are less than average limit, so not need to evaluate the average.

Standard:	FCC Part 15.407	Test Distance:	3 m
Test item:	Band edge		
Frequency:	5320 MHz		
Mode:	Mode 2		
Ant.Polar.:	Horizontal		

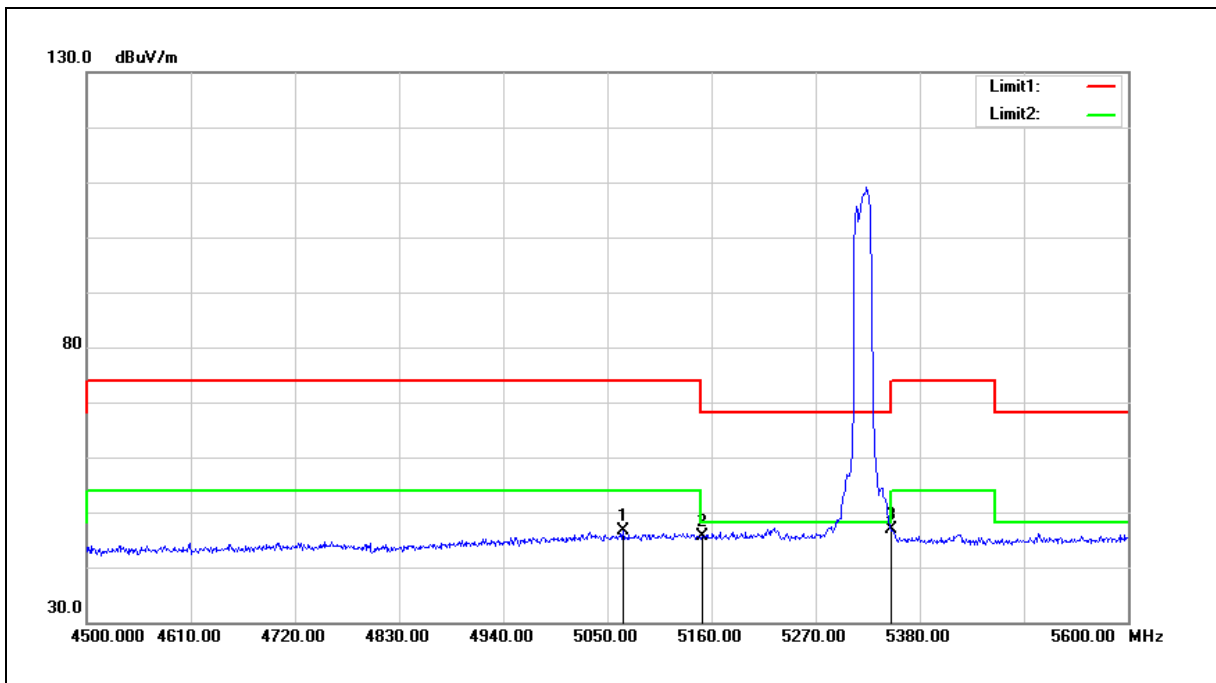

No.	Frequency (MHz)	Reading (dBuV)	Correct Factor (dB/m)	Result (dBuV/m)	Limit (dBuV/m)	Margin (dB)	Remark
1	5066.500	46.84	-0.24	46.60	54.00	-7.40	AVG
2	5150.000	45.60	-0.08	45.52	54.00	-8.48	AVG
3	5350.000	46.67	0.30	46.97	54.00	-7.03	AVG

Note:1.Result (dBuV/m) = Correct Factor (dB/m) + Reading(dBuV).

2.Correction factor (dB/m) = Antenna Factor (dB/m) + Cable loss (dB) – Pre-Amplifier gain (dB).

3.When the peak results are less than average limit, so not need to evaluate the average.

Standard:	FCC Part 15.407	Test Distance:	3 m
Test item:	Band edge		
Frequency:	5320 MHz		
Mode:	Mode 2		
Ant.Polar.:	Vertical		

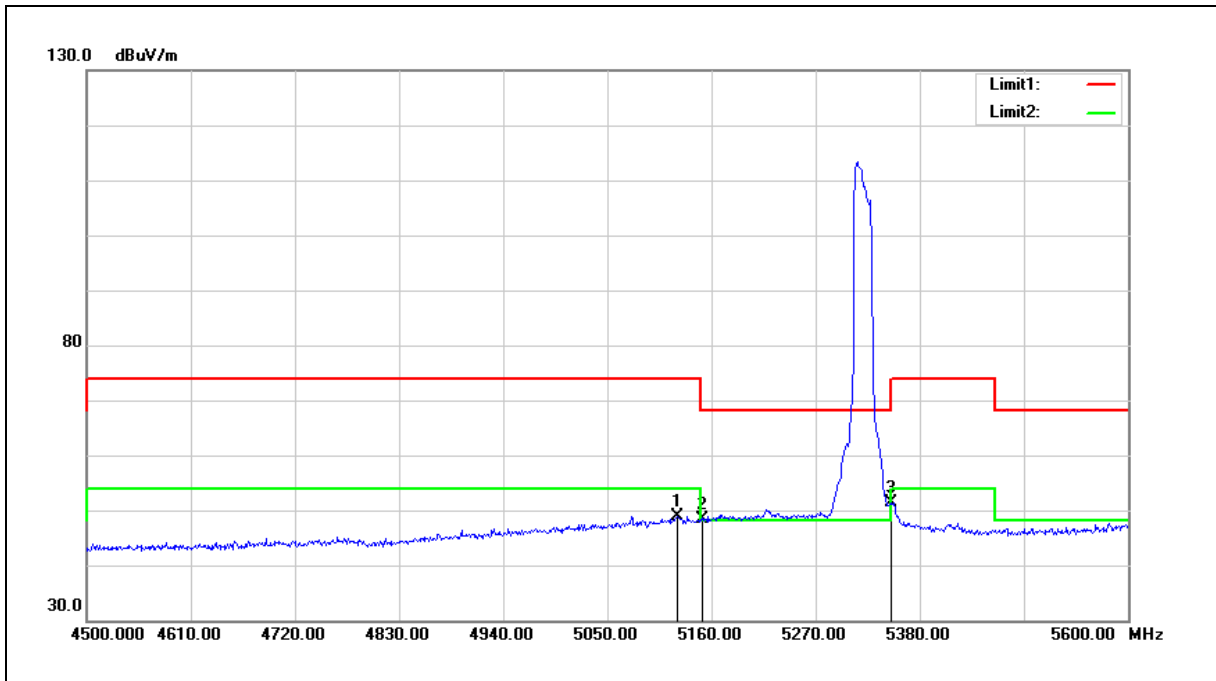

No.	Frequency (MHz)	Reading (dBuV)	Correct Factor (dB/m)	Result (dBuV/m)	Limit (dBuV/m)	Margin (dB)	Remark
1	5123.700	49.04	-0.13	48.91	54.00	-5.09	AVG
2	5150.000	48.58	-0.08	48.50	54.00	-5.50	AVG
3	5350.000	51.08	0.30	51.38	54.00	-2.62	AVG

Note:1.Result (dBuV/m) = Correct Factor (dB/m) + Reading(dBuV).

2.Correction factor (dB/m) = Antenna Factor (dB/m) + Cable loss (dB) – Pre-Amplifier gain (dB).

3.When the peak results are less than average limit, so not need to evaluate the average.

Standard:	FCC Part 15.407	Test Distance:	3 m
Test item:	Band edge		
Frequency:	5500 MHz		
Mode:	Mode 2		
Ant.Polar.:	Horizontal		

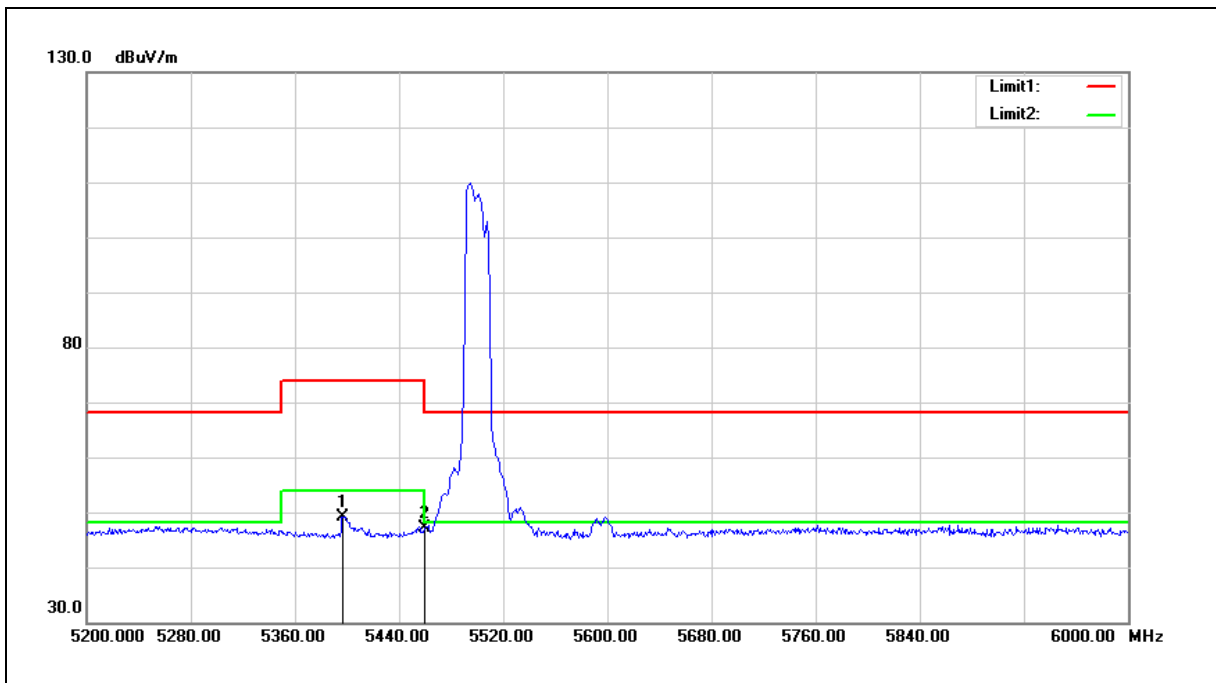

No.	Frequency (MHz)	Reading (dBuV)	Correct Factor (dB/m)	Result (dBuV/m)	Limit (dBuV/m)	Margin (dB)	Remark
1	5396.800	48.85	0.38	49.23	54.00	-4.77	AVG
2	5460.000	46.61	0.51	47.12	54.00	-6.88	AVG

Note:1.Result (dBuV/m) = Correct Factor (dB/m) + Reading(dBuV).

2.Correction factor (dB/m) = Antenna Factor (dB/m) + Cable loss (dB) – Pre-Amplifier gain (dB).

3.When the peak results are less than average limit, so not need to evaluate the average.

Standard:	FCC Part 15.407	Test Distance:	3 m
Test item:	Band edge		
Frequency:	5500 MHz		
Mode:	Mode 2		
Ant.Polar.:	Vertical		

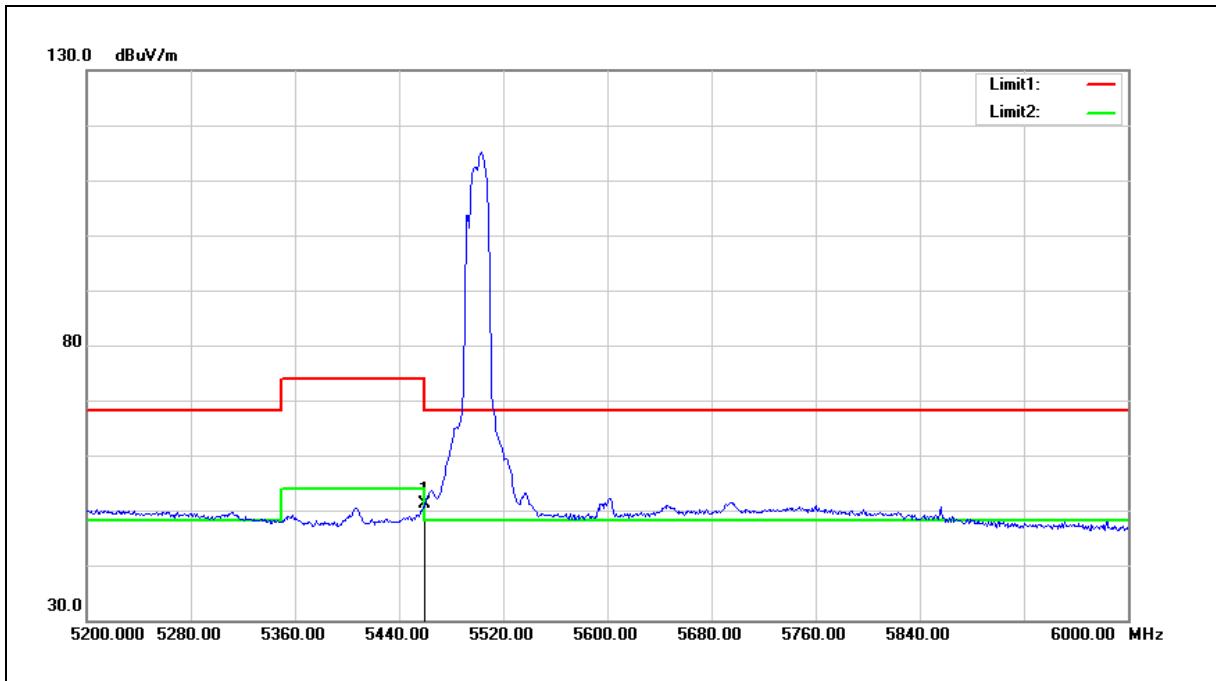

No.	Frequency (MHz)	Reading (dBuV)	Correct Factor (dB/m)	Result (dBuV/m)	Limit (dBuV/m)	Margin (dB)	Remark
1	5460.000	50.67	0.51	51.18	54.00	-2.82	AVG

Note:1.Result (dBuV/m) = Correct Factor (dB/m) + Reading(dBuV).

2.Correction factor (dB/m) = Antenna Factor (dB/m) + Cable loss (dB) – Pre-Amplifier gain (dB).

3.When the peak results are less than average limit, so not need to evaluate the average.

Standard:	FCC Part 15.407	Test Distance:	3 m
Test item:	Band edge		
Frequency:	5560 MHz		
Mode:	Mode 2		
Ant.Polar.:	Horizontal		

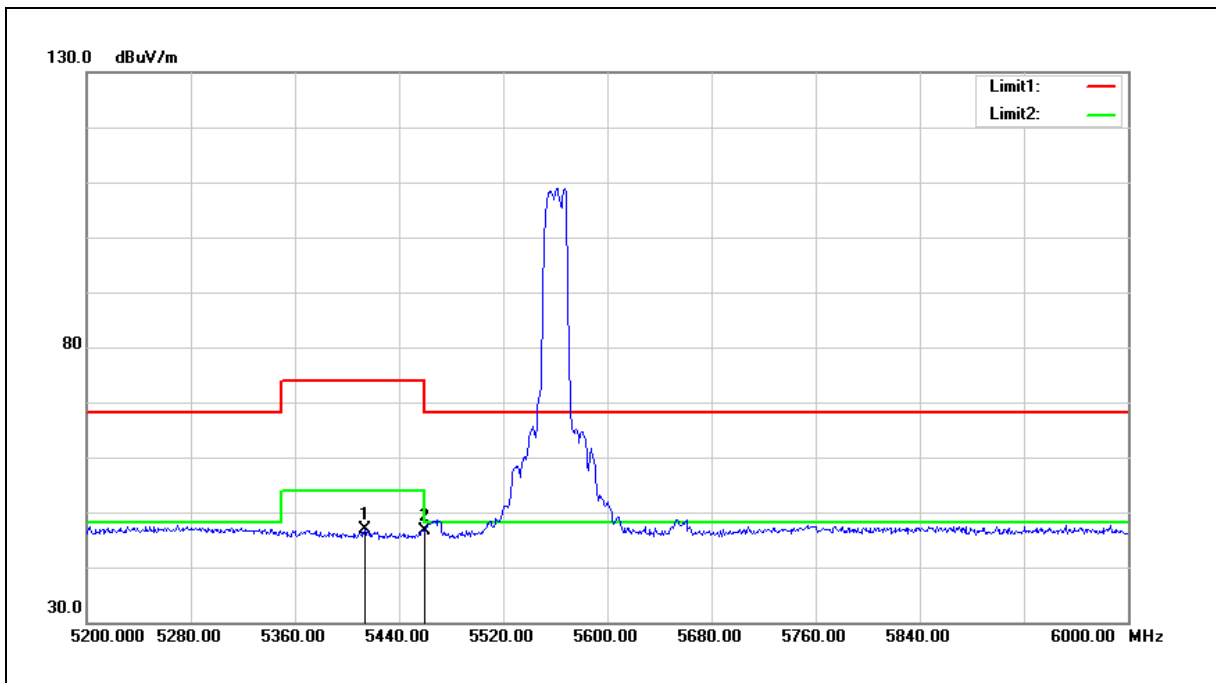

No.	Frequency (MHz)	Reading (dBuV)	Correct Factor (dB/m)	Result (dBuV/m)	Limit (dBuV/m)	Margin (dB)	Remark
1	5413.600	46.44	0.41	46.85	54.00	-7.15	AVG
2	5460.000	46.09	0.51	46.60	54.00	-7.40	AVG

Note:1.Result (dBuV/m) = Correct Factor (dB/m) + Reading(dBuV).

2.Correction factor (dB/m) = Antenna Factor (dB/m) + Cable loss (dB) – Pre-Amplifier gain (dB).

3.When the peak results are less than average limit, so not need to evaluate the average.

Standard:	FCC Part 15.407	Test Distance:	3 m
Test item:	Band edge		
Frequency:	5560 MHz		
Mode:	Mode 2		
Ant.Polar.:	Vertical		

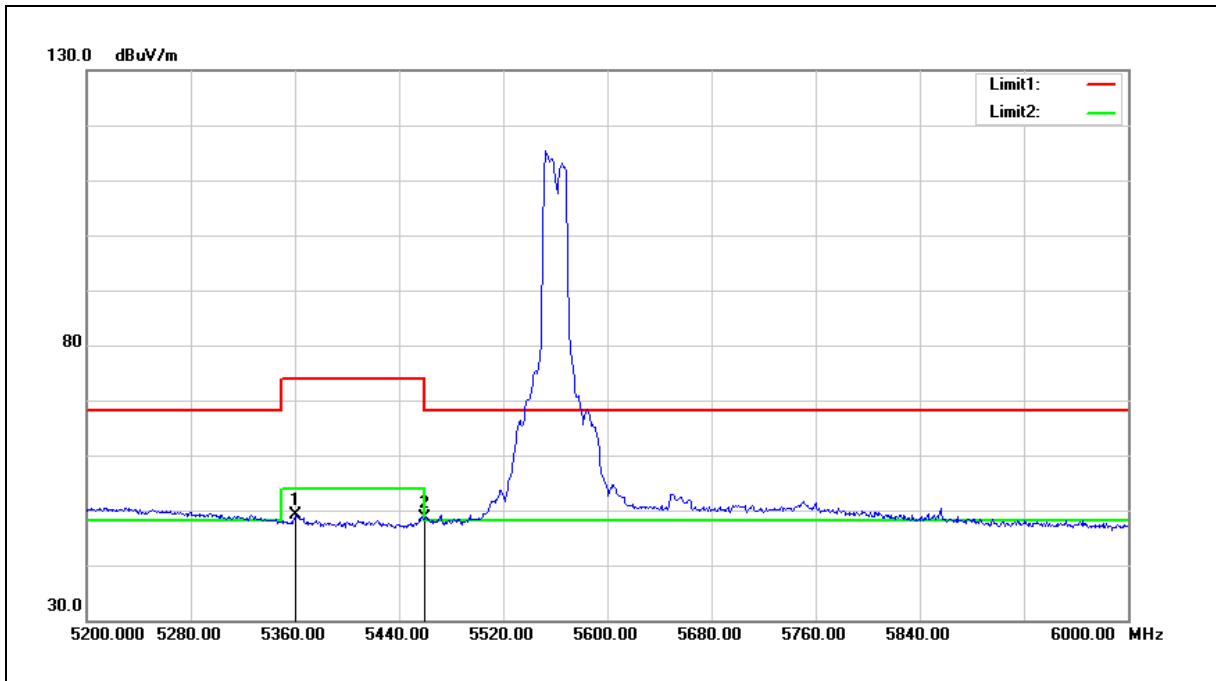

No.	Frequency (MHz)	Reading (dBuV)	Correct Factor (dB/m)	Result (dBuV/m)	Limit (dBuV/m)	Margin (dB)	Remark
1	5360.800	48.74	0.31	49.05	54.00	-4.95	AVG
2	5460.000	48.04	0.51	48.55	54.00	-5.45	AVG

Note:1.Result (dBuV/m) = Correct Factor (dB/m) + Reading(dBuV).

2.Correction factor (dB/m) = Antenna Factor (dB/m) + Cable loss (dB) – Pre-Amplifier gain (dB).

3.When the peak results are less than average limit, so not need to evaluate the average.

Standard:	FCC Part 15.407	Test Distance:	3 m
Test item:	Band edge		
Frequency:	5700 MHz		
Mode:	Mode 2		
Ant.Polar.:	Horizontal		

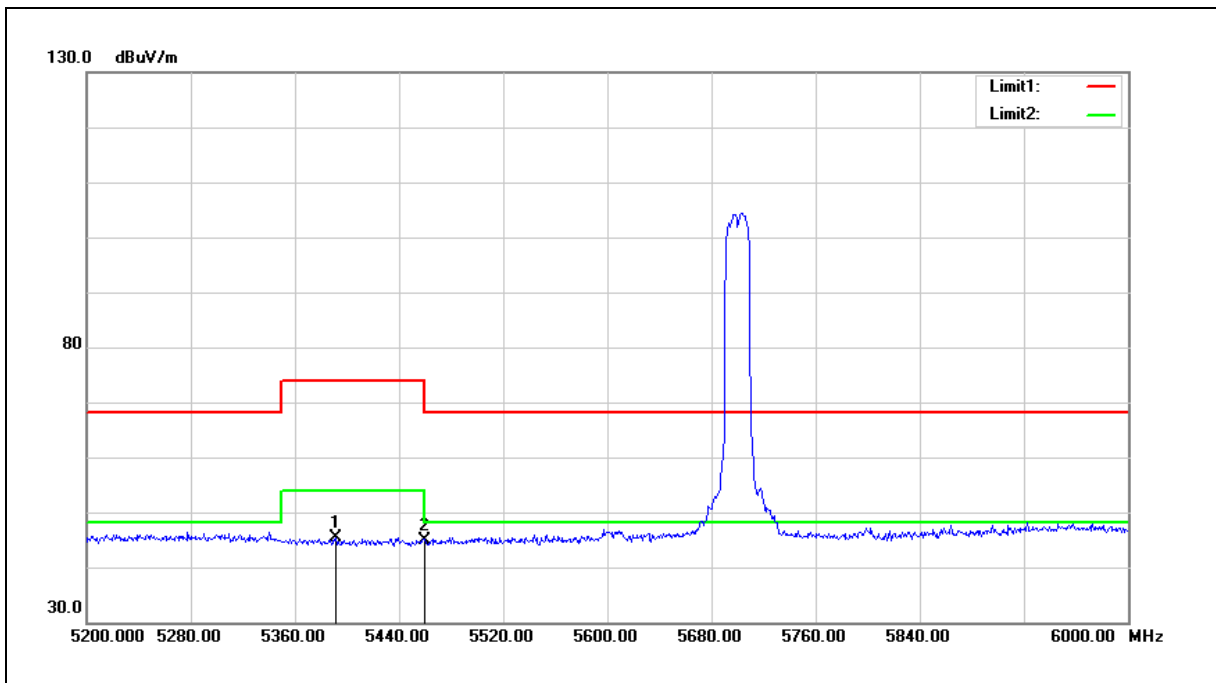

No.	Frequency (MHz)	Reading (dBuV)	Correct Factor (dB/m)	Result (dBuV/m)	Limit (dBuV/m)	Margin (dB)	Remark
1	5391.200	44.93	0.37	45.30	54.00	-8.70	AVG
2	5460.000	44.45	0.51	44.96	54.00	-9.04	AVG

Note:1.Result (dBuV/m) = Correct Factor (dB/m) + Reading(dBuV).

2.Correction factor (dB/m) = Antenna Factor (dB/m) + Cable loss (dB) – Pre-Amplifier gain (dB).

3.When the peak results are less than average limit, so not need to evaluate the average.

Standard:	FCC Part 15.407	Test Distance:	3 m
Test item:	Band edge		
Frequency:	5700 MHz		
Mode:	Mode 2		
Ant.Polar.:	Vertical		

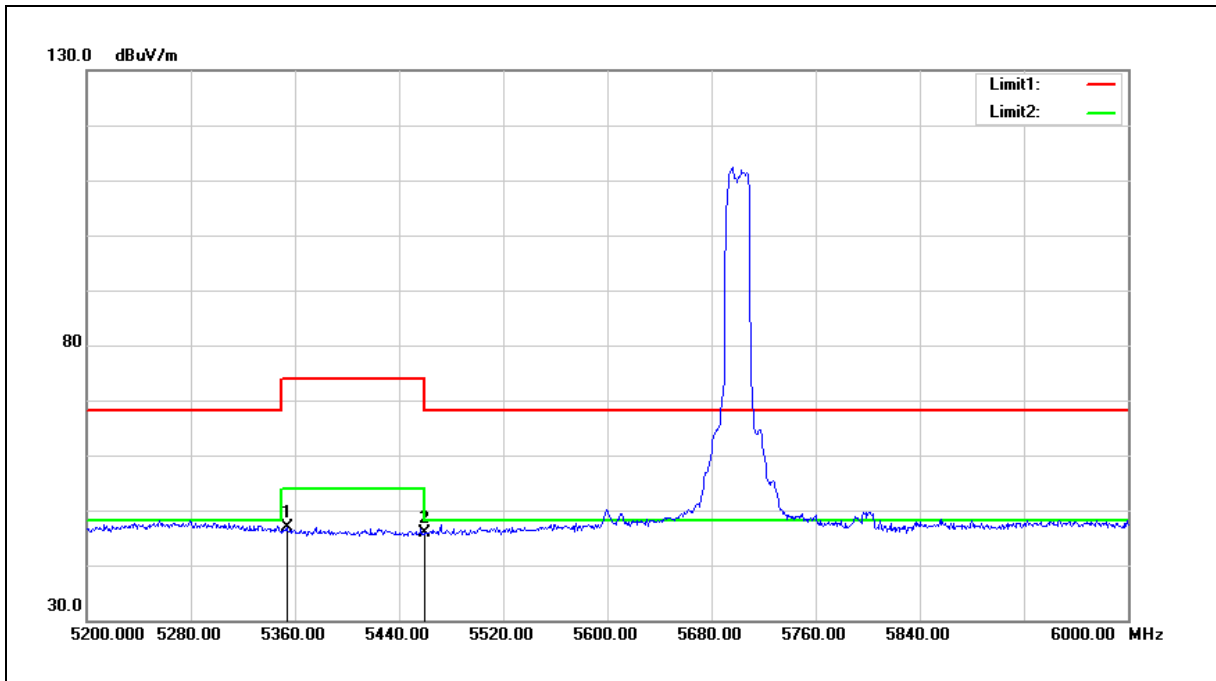

No.	Frequency (MHz)	Reading (dBuV)	Correct Factor (dB/m)	Result (dBuV/m)	Limit (dBuV/m)	Margin (dB)	Remark
1	5353.600	46.70	0.30	47.00	54.00	-7.00	AVG
2	5460.000	45.46	0.51	45.97	54.00	-8.03	AVG

Note:1.Result (dBuV/m) = Correct Factor (dB/m) + Reading(dBuV).

2.Correction factor (dB/m) = Antenna Factor (dB/m) + Cable loss (dB) – Pre-Amplifier gain (dB).

3.When the peak results are less than average limit, so not need to evaluate the average.

Standard:	FCC Part 15.407	Test Distance:	3 m
Test item:	Band edge		
Frequency:	5180 MHz		
Mode:	Mode 8		
Ant.Polar.:	Horizontal		

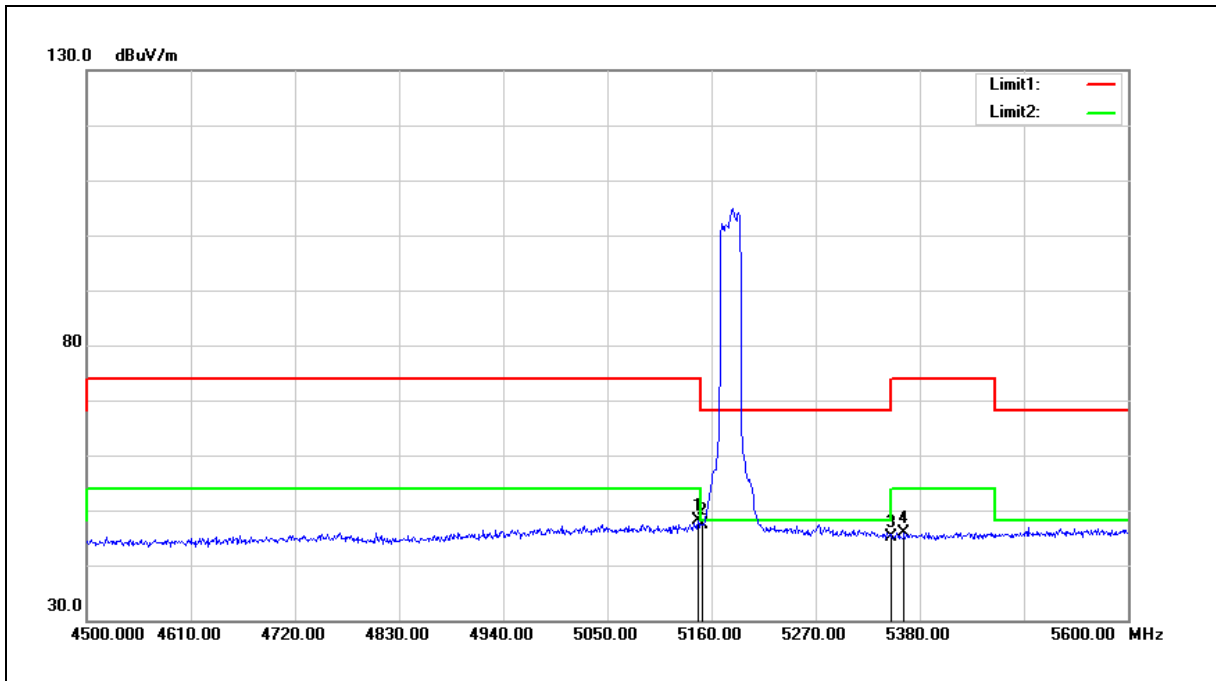

No.	Frequency (MHz)	Reading (dBuV)	Correct Factor (dB/m)	Result (dBuV/m)	Limit (dBuV/m)	Margin (dB)	Remark
1	5145.700	48.14	-0.08	48.06	54.00	-5.94	AVG
2	5150.000	47.37	-0.08	47.29	54.00	-6.71	AVG
3	5350.000	44.87	0.30	45.17	54.00	-8.83	AVG
4	5363.500	45.65	0.32	45.97	54.00	-8.03	AVG

Note:1.Result (dBuV/m) = Correct Factor (dB/m) + Reading(dBuV).

2.Correction factor (dB/m) = Antenna Factor (dB/m) + Cable loss (dB) – Pre-Amplifier gain (dB).

3.When the peak results are less than average limit, so not need to evaluate the average.

Standard:	FCC Part 15.407	Test Distance:	3 m
Test item:	Band edge		
Frequency:	5180 MHz		
Mode:	Mode 8		
Ant.Polar.:	Vertical		

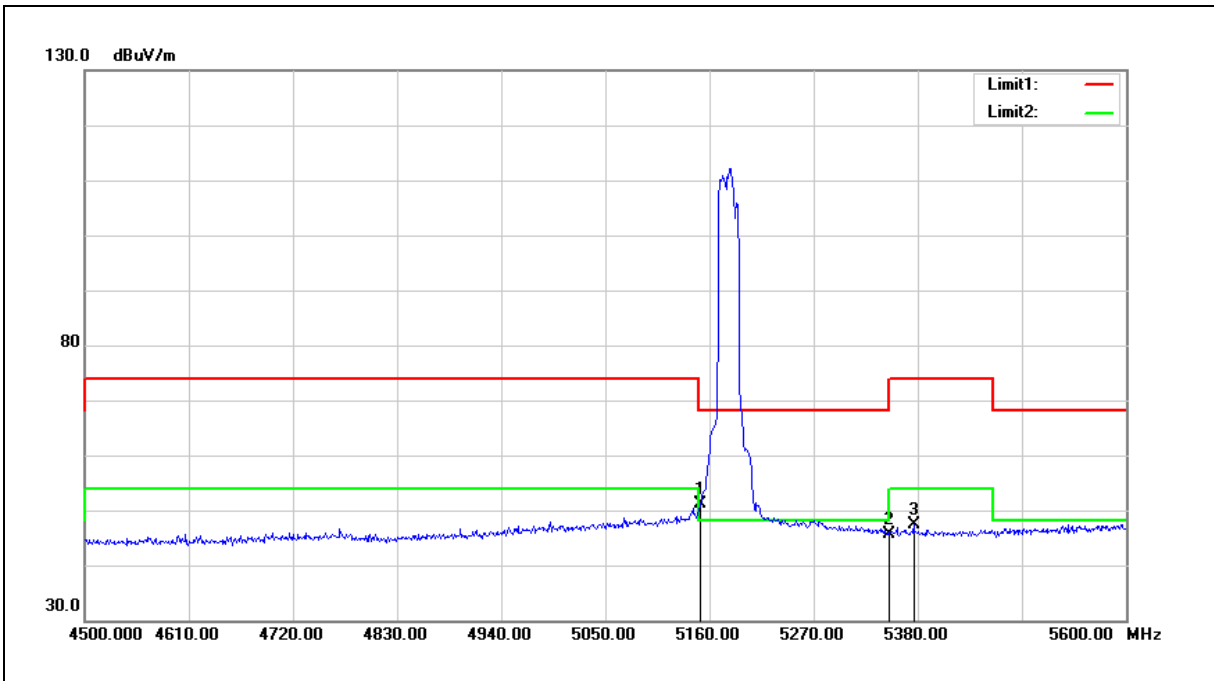

No.	Frequency (MHz)	Reading (dBuV)	Correct Factor (dB/m)	Result (dBuV/m)	Limit (dBuV/m)	Margin (dB)	Remark
1	5150.000	51.14	-0.08	51.06	54.00	-2.94	AVG
2	5350.000	45.35	0.30	45.65	54.00	-8.35	AVG
3	5375.600	46.96	0.34	47.30	54.00	-6.70	AVG

Note:1.Result (dBuV/m) = Correct Factor (dB/m) + Reading(dBuV).

2.Correction factor (dB/m) = Antenna Factor (dB/m) + Cable loss (dB) – Pre-Amplifier gain (dB).

3.When the peak results are less than average limit, so not need to evaluate the average.

Standard:	FCC Part 15.407	Test Distance:	3 m
Test item:	Band edge		
Frequency:	5200 MHz		
Mode:	Mode 8		
Ant.Polar.:	Horizontal		

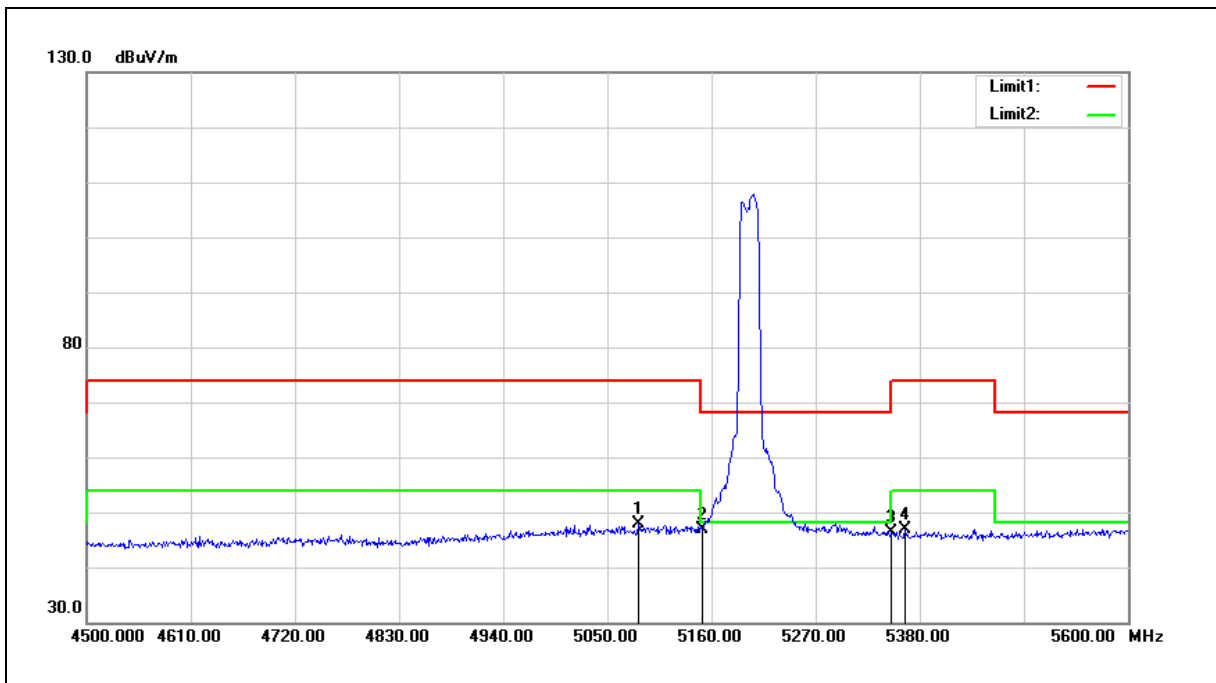

No.	Frequency (MHz)	Reading (dBuV)	Correct Factor (dB/m)	Result (dBuV/m)	Limit (dBuV/m)	Margin (dB)	Remark
1	5083.000	48.09	-0.20	47.89	54.00	-6.11	AVG
2	5150.000	46.89	-0.08	46.81	54.00	-7.19	AVG
3	5350.000	46.15	0.30	46.45	54.00	-7.55	AVG
4	5364.600	46.53	0.32	46.85	54.00	-7.15	AVG

Note:1.Result (dBuV/m) = Correct Factor (dB/m) + Reading(dBuV).

2.Correction factor (dB/m) = Antenna Factor (dB/m) + Cable loss (dB) – Pre-Amplifier gain (dB).

3.When the peak results are less than average limit, so not need to evaluate the average.

Standard:	FCC Part 15.407	Test Distance:	3 m
Test item:	Band edge		
Frequency:	5200 MHz		
Mode:	Mode 8		
Ant.Polar.:	Vertical		

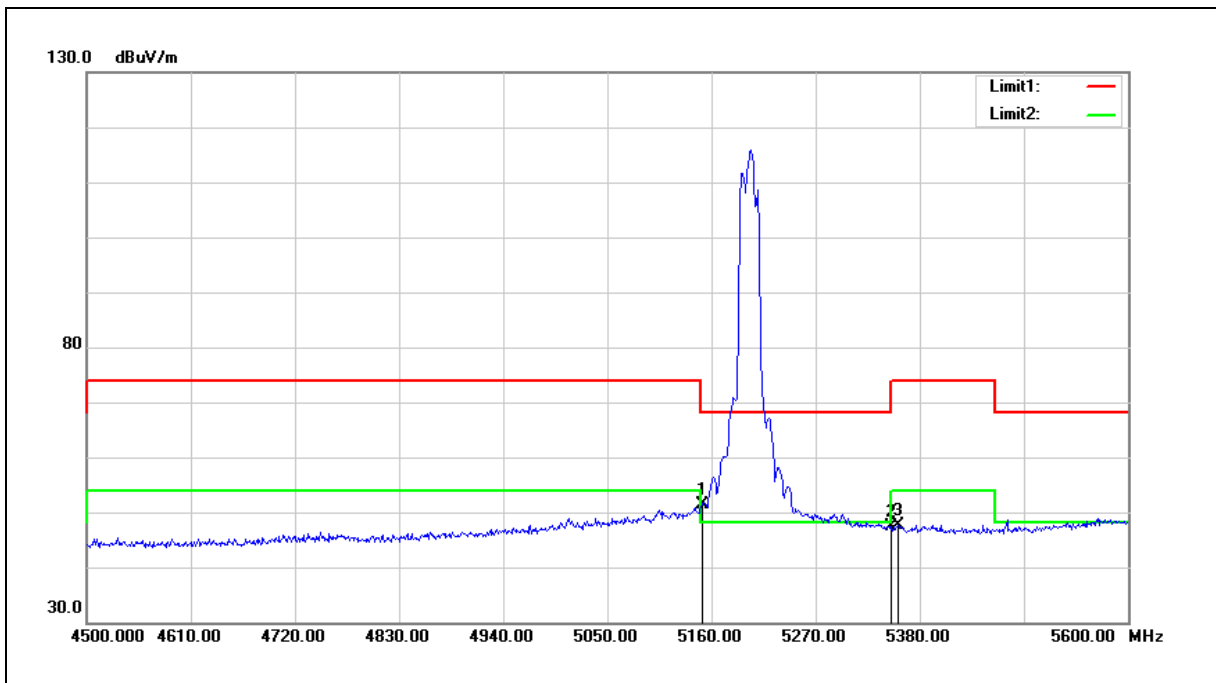

No.	Frequency (MHz)	Reading (dBuV)	Correct Factor (dB/m)	Result (dBuV/m)	Limit (dBuV/m)	Margin (dB)	Remark
1	5150.000	51.48	-0.08	51.40	54.00	-2.60	AVG
2	5350.000	47.00	0.30	47.30	54.00	-6.70	AVG
3	5356.900	47.42	0.31	47.73	54.00	-6.27	AVG

Note:1.Result (dBuV/m) = Correct Factor (dB/m) + Reading(dBuV).

2.Correction factor (dB/m) = Antenna Factor (dB/m) + Cable loss (dB) – Pre-Amplifier gain (dB).

3.When the peak results are less than average limit, so not need to evaluate the average.

Standard:	FCC Part 15.407	Test Distance:	3 m
Test item:	Band edge		
Frequency:	5240 MHz		
Mode:	Mode 8		
Ant.Polar.:	Horizontal		

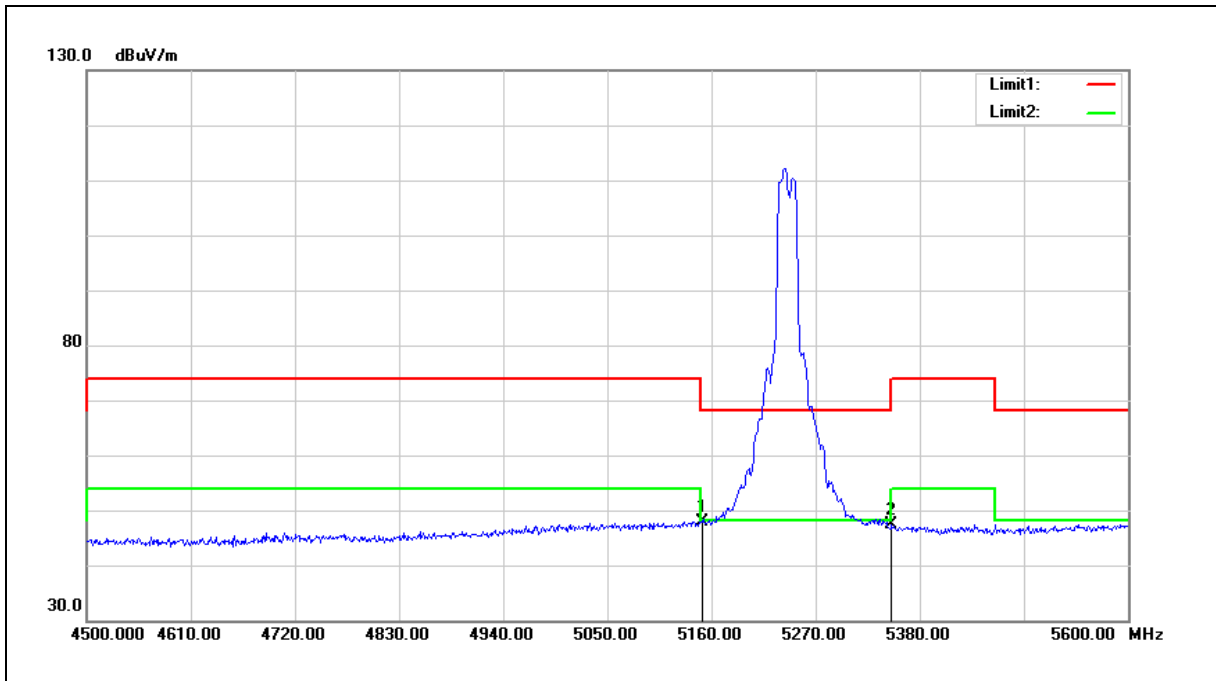

No.	Frequency (MHz)	Reading (dBuV)	Correct Factor (dB/m)	Result (dBuV/m)	Limit (dBuV/m)	Margin (dB)	Remark
1	5150.000	48.07	-0.08	47.99	54.00	-6.01	AVG
2	5350.000	46.99	0.30	47.29	54.00	-6.71	AVG

Note:1.Result (dBuV/m) = Correct Factor (dB/m) + Reading(dBuV).

2.Correction factor (dB/m) = Antenna Factor (dB/m) + Cable loss (dB) – Pre-Amplifier gain (dB).

3.When the peak results are less than average limit, so not need to evaluate the average.

Standard:	FCC Part 15.407	Test Distance:	3 m
Test item:	Band edge		
Frequency:	5240 MHz		
Mode:	Mode 8		
Ant.Polar.:	Vertical		

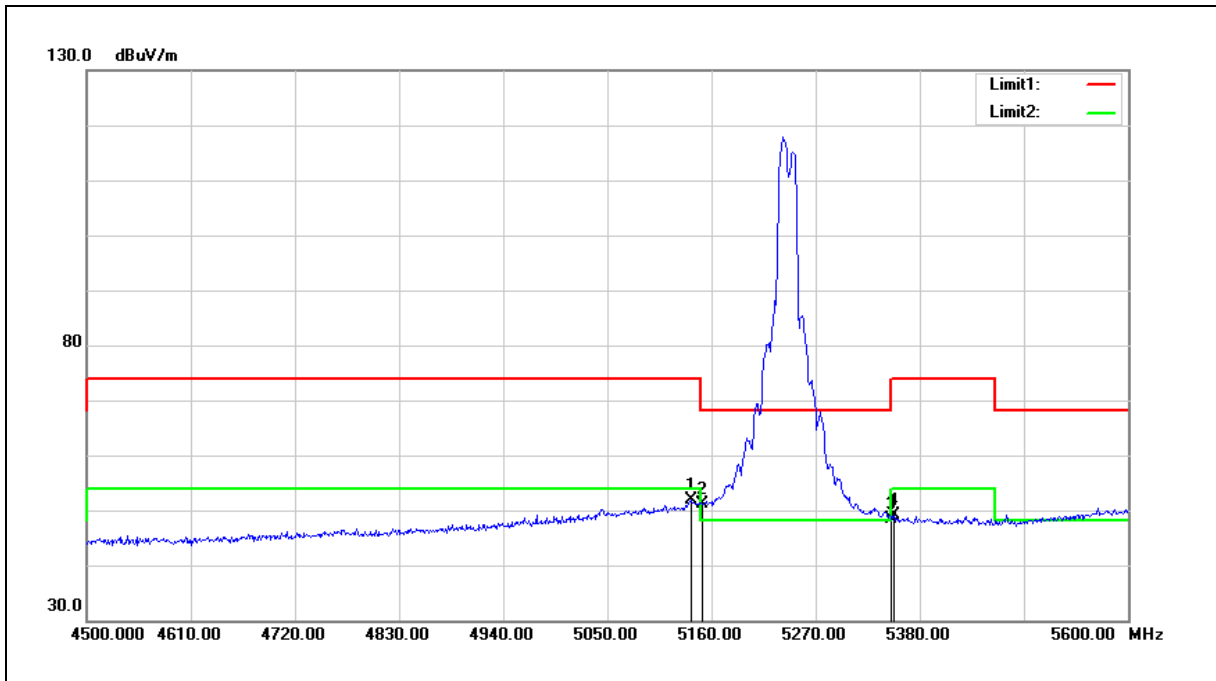

No.	Frequency (MHz)	Reading (dBuV)	Correct Factor (dB/m)	Result (dBuV/m)	Limit (dBuV/m)	Margin (dB)	Remark
1	5138.000	51.94	-0.10	51.84	54.00	-2.16	AVG
2	5150.000	51.22	-0.08	51.14	54.00	-2.86	AVG
3	5350.000	48.18	0.30	48.48	54.00	-5.52	AVG
4	5352.500	48.79	0.30	49.09	54.00	-4.91	AVG

Note:1.Result (dBuV/m) = Correct Factor (dB/m) + Reading(dBuV).

2.Correction factor (dB/m) = Antenna Factor (dB/m) + Cable loss (dB) – Pre-Amplifier gain (dB).

3.When the peak results are less than average limit, so not need to evaluate the average.

Standard:	FCC Part 15.407	Test Distance:	3 m
Test item:	Band edge		
Frequency:	5260 MHz		
Mode:	Mode 8		
Ant.Polar.:	Horizontal		

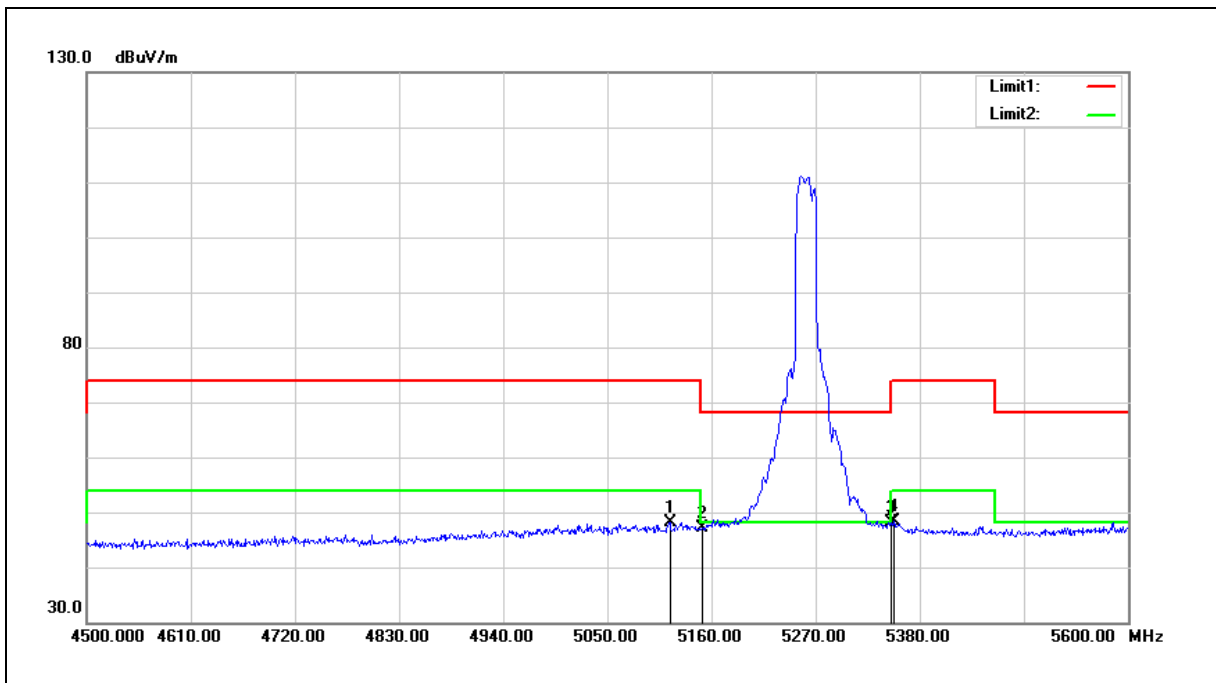

No.	Frequency (MHz)	Reading (dBuV)	Correct Factor (dB/m)	Result (dBuV/m)	Limit (dBuV/m)	Margin (dB)	Remark
1	5116.000	48.35	-0.15	48.20	54.00	-5.80	AVG
2	5150.000	47.29	-0.08	47.21	54.00	-6.79	AVG
3	5350.000	47.94	0.30	48.24	54.00	-5.76	AVG
4	5352.500	48.06	0.30	48.36	54.00	-5.64	AVG

Note:1.Result (dBuV/m) = Correct Factor (dB/m) + Reading(dBuV).

2.Correction factor (dB/m) = Antenna Factor (dB/m) + Cable loss (dB) – Pre-Amplifier gain (dB).

3.When the peak results are less than average limit, so not need to evaluate the average.

Standard:	FCC Part 15.407	Test Distance:	3 m
Test item:	Band edge		
Frequency:	5260 MHz		
Mode:	Mode 8		
Ant.Polar.:	Vertical		

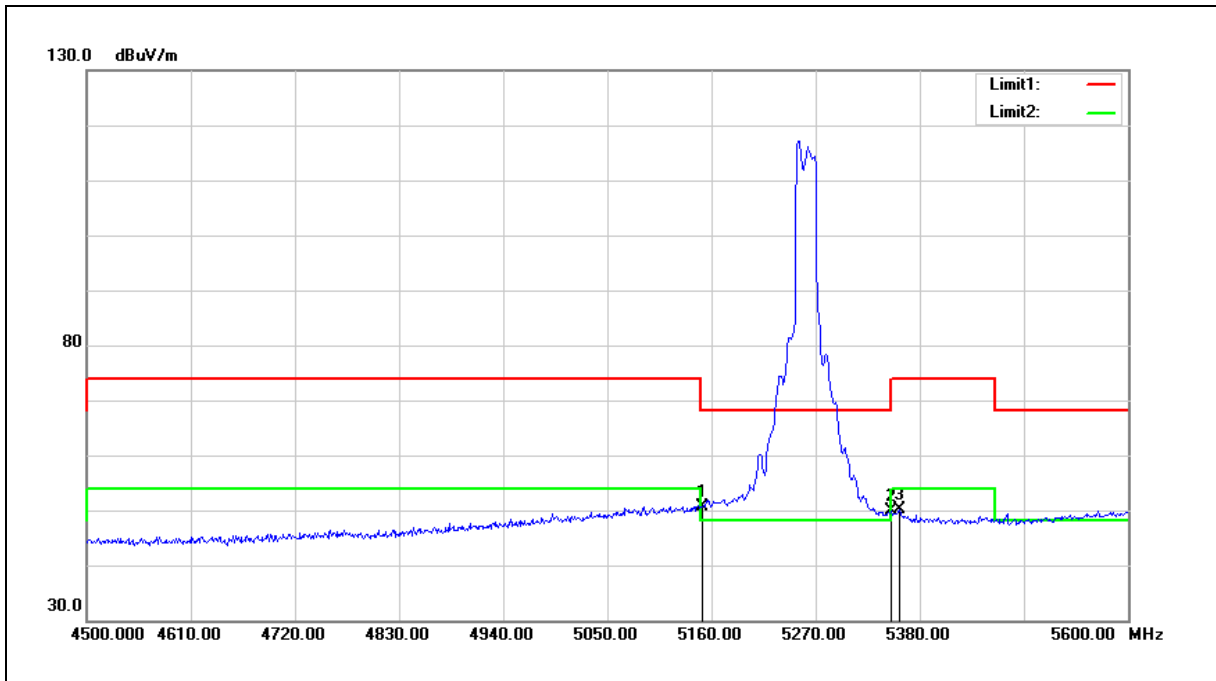

No.	Frequency (MHz)	Reading (dBuV)	Correct Factor (dB/m)	Result (dBuV/m)	Limit (dBuV/m)	Margin (dB)	Remark
1	5150.000	50.63	-0.08	50.55	54.00	-3.45	AVG
2	5350.000	49.49	0.30	49.79	54.00	-4.21	AVG
3	5359.100	49.87	0.31	50.18	54.00	-3.82	AVG

Note:1.Result (dBuV/m) = Correct Factor (dB/m) + Reading(dBuV).

2.Correction factor (dB/m) = Antenna Factor (dB/m) + Cable loss (dB) – Pre-Amplifier gain (dB).

3.When the peak results are less than average limit, so not need to evaluate the average.

Standard:	FCC Part 15.407	Test Distance:	3 m
Test item:	Band edge		
Frequency:	5280 MHz		
Mode:	Mode 8		
Ant.Polar.:	Horizontal		

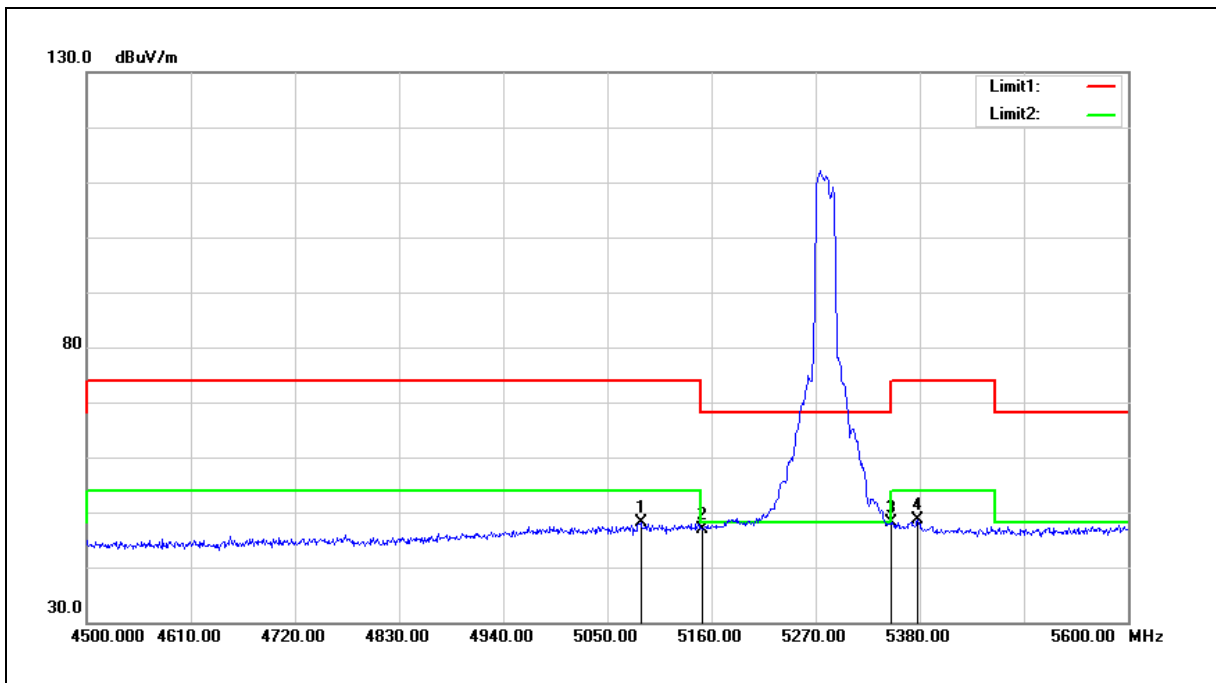

No.	Frequency (MHz)	Reading (dBuV)	Correct Factor (dB/m)	Result (dBuV/m)	Limit (dBuV/m)	Margin (dB)	Remark
1	5085.200	48.22	-0.20	48.02	54.00	-5.98	AVG
2	5150.000	47.07	-0.08	46.99	54.00	-7.01	AVG
3	5350.000	47.75	0.30	48.05	54.00	-5.95	AVG
4	5377.800	48.24	0.35	48.59	54.00	-5.41	AVG

Note:1.Result (dBuV/m) = Correct Factor (dB/m) + Reading(dBuV).

2.Correction factor (dB/m) = Antenna Factor (dB/m) + Cable loss (dB) – Pre-Amplifier gain (dB).

3.When the peak results are less than average limit, so not need to evaluate the average.

Standard:	FCC Part 15.407	Test Distance:	3 m
Test item:	Band edge		
Frequency:	5280 MHz		
Mode:	Mode 8		
Ant.Polar.:	Vertical		

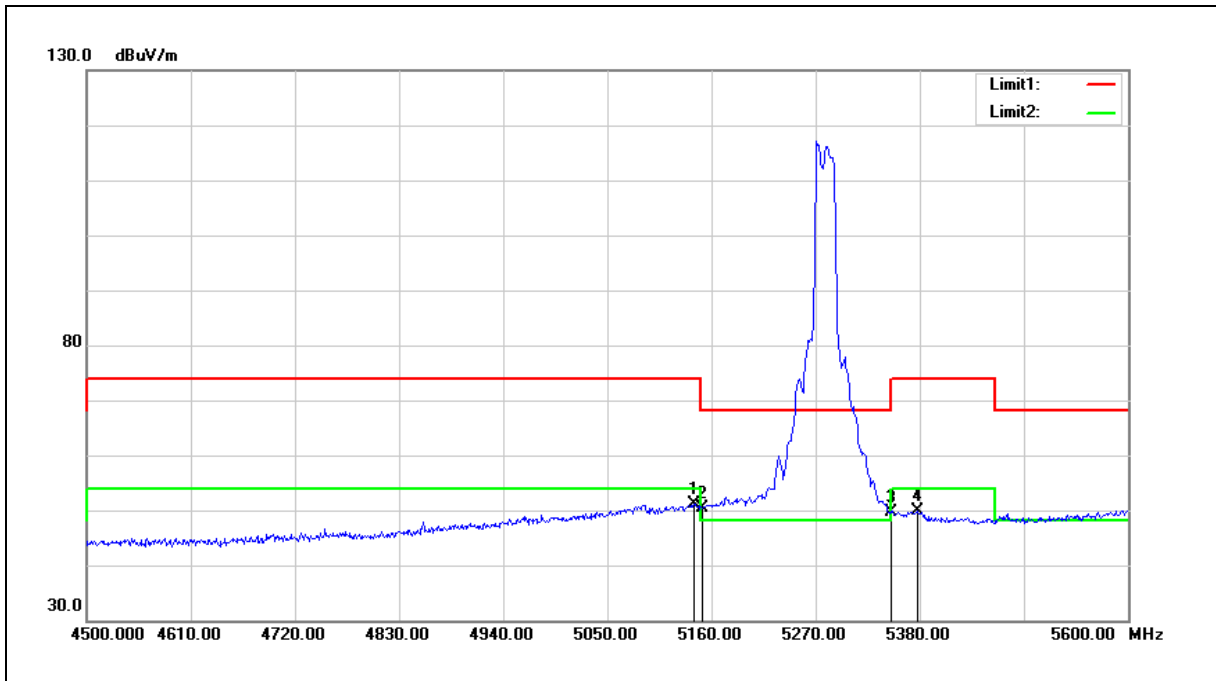

No.	Frequency (MHz)	Reading (dBuV)	Correct Factor (dB/m)	Result (dBuV/m)	Limit (dBuV/m)	Margin (dB)	Remark
1	5141.300	51.22	-0.10	51.12	54.00	-2.88	AVG
2	5150.000	50.45	-0.08	50.37	54.00	-3.63	AVG
3	5350.000	49.35	0.30	49.65	54.00	-4.35	AVG
4	5377.800	49.44	0.35	49.79	54.00	-4.21	AVG

Note:1.Result (dBuV/m) = Correct Factor (dB/m) + Reading(dBuV).

2.Correction factor (dB/m) = Antenna Factor (dB/m) + Cable loss (dB) – Pre-Amplifier gain (dB).

3.When the peak results are less than average limit, so not need to evaluate the average.

Standard:	FCC Part 15.407	Test Distance:	3 m
Test item:	Band edge		
Frequency:	5320 MHz		
Mode:	Mode 8		
Ant.Polar.:	Horizontal		

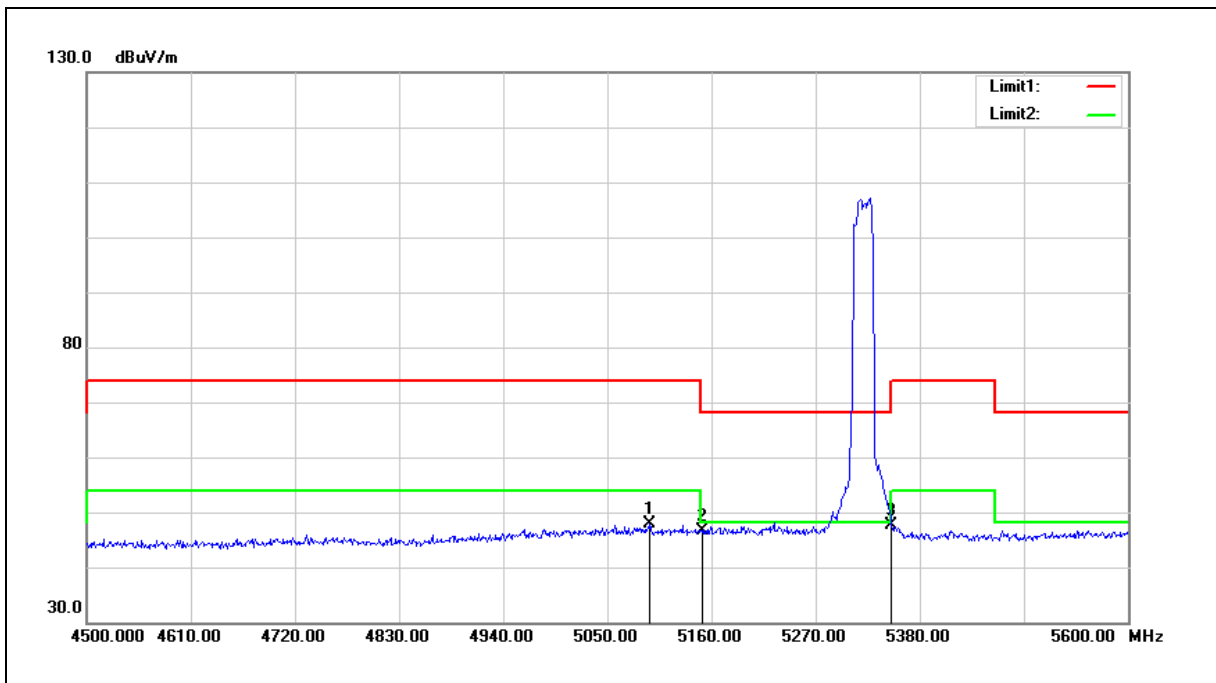

No.	Frequency (MHz)	Reading (dBuV)	Correct Factor (dB/m)	Result (dBuV/m)	Limit (dBuV/m)	Margin (dB)	Remark
1	5095.100	48.02	-0.18	47.84	54.00	-6.16	AVG
2	5150.000	46.71	-0.08	46.63	54.00	-7.37	AVG
3	5350.000	47.43	0.30	47.73	54.00	-6.27	AVG

Note:1.Result (dBuV/m) = Correct Factor (dB/m) + Reading(dBuV).

2.Correction factor (dB/m) = Antenna Factor (dB/m) + Cable loss (dB) – Pre-Amplifier gain (dB).

3.When the peak results are less than average limit, so not need to evaluate the average.

Standard:	FCC Part 15.407	Test Distance:	3 m
Test item:	Band edge		
Frequency:	5320 MHz		
Mode:	Mode 8		
Ant.Polar.:	Vertical		

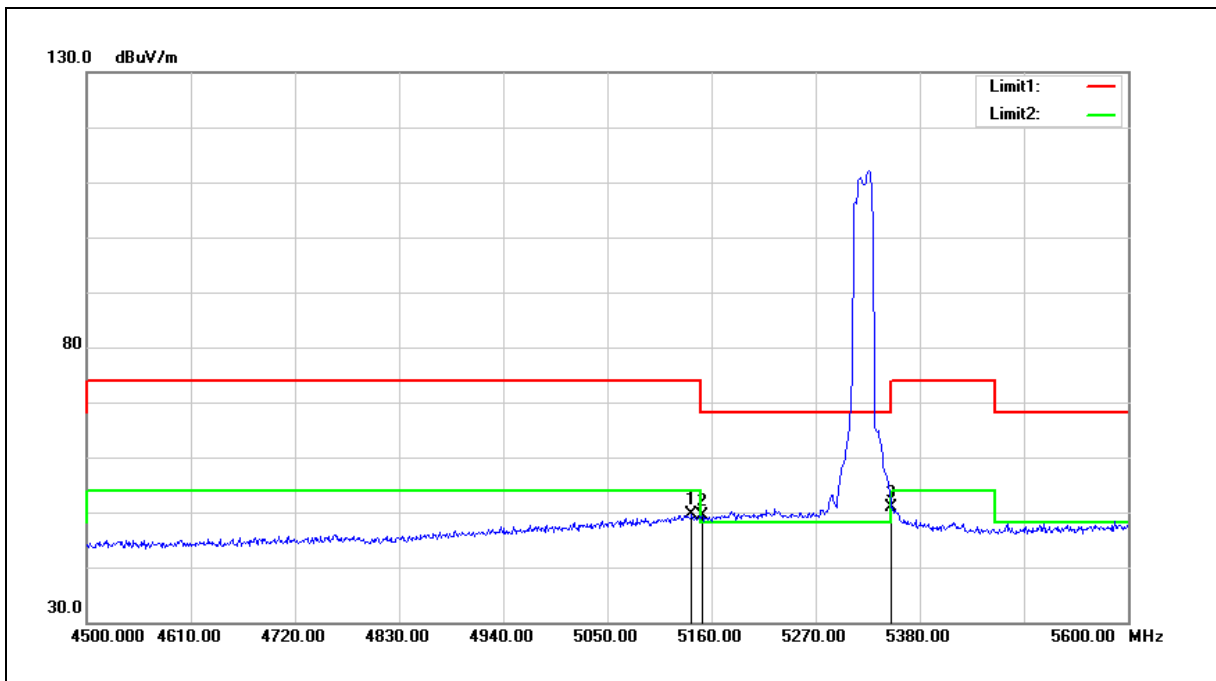

No.	Frequency (MHz)	Reading (dBuV)	Correct Factor (dB/m)	Result (dBuV/m)	Limit (dBuV/m)	Margin (dB)	Remark
1	5139.100	49.64	-0.10	49.54	54.00	-4.46	AVG
2	5150.000	49.55	-0.08	49.47	54.00	-4.53	AVG
3	5350.000	50.69	0.30	50.99	54.00	-3.01	AVG

Note:1.Result (dBuV/m) = Correct Factor (dB/m) + Reading(dBuV).

2.Correction factor (dB/m) = Antenna Factor (dB/m) + Cable loss (dB) – Pre-Amplifier gain (dB).

3.When the peak results are less than average limit, so not need to evaluate the average.

Standard:	FCC Part 15.407	Test Distance:	3 m
Test item:	Band edge		
Frequency:	5500 MHz		
Mode:	Mode 8		
Ant.Polar.:	Horizontal		

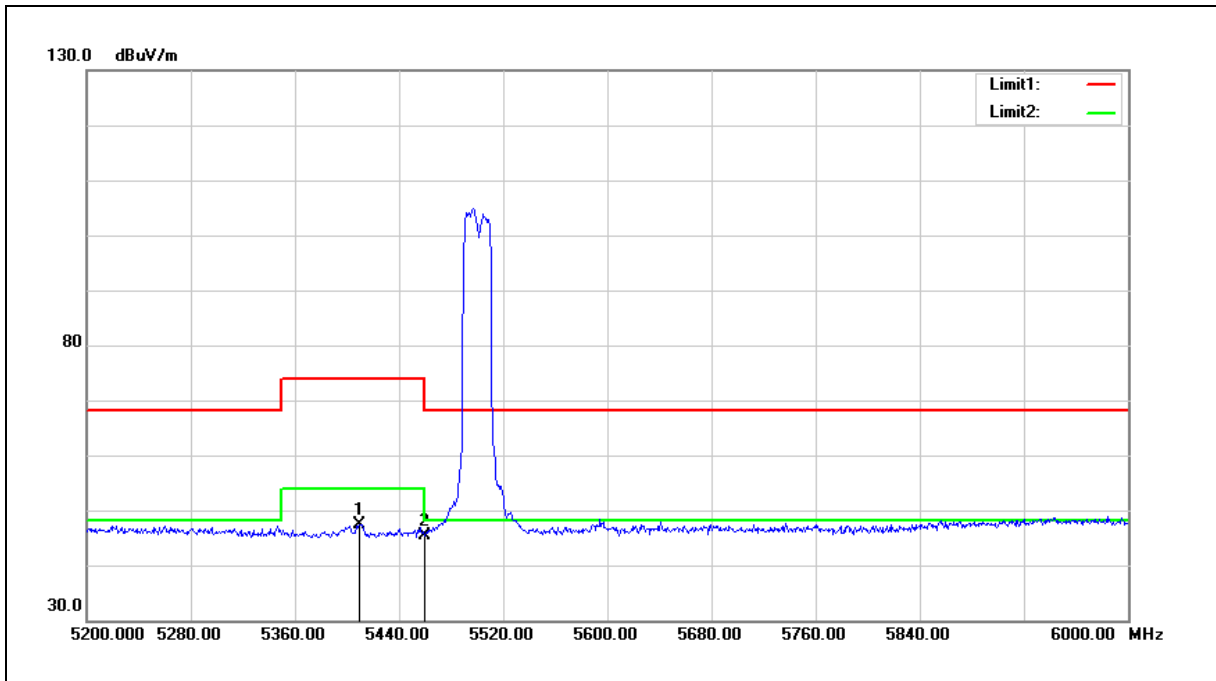

No.	Frequency (MHz)	Reading (dBuV)	Correct Factor (dB/m)	Result (dBuV/m)	Limit (dBuV/m)	Margin (dB)	Remark
1	5409.600	47.08	0.41	47.49	54.00	-6.51	AVG
2	5460.000	44.97	0.51	45.48	54.00	-8.52	AVG

Note:1.Result (dBuV/m) = Correct Factor (dB/m) + Reading(dBuV).

2.Correction factor (dB/m) = Antenna Factor (dB/m) + Cable loss (dB) – Pre-Amplifier gain (dB).

3.When the peak results are less than average limit, so not need to evaluate the average.

Standard:	FCC Part 15.407	Test Distance:	3 m
Test item:	Band edge		
Frequency:	5500 MHz		
Mode:	Mode 8		
Ant.Polar.:	Vertical		

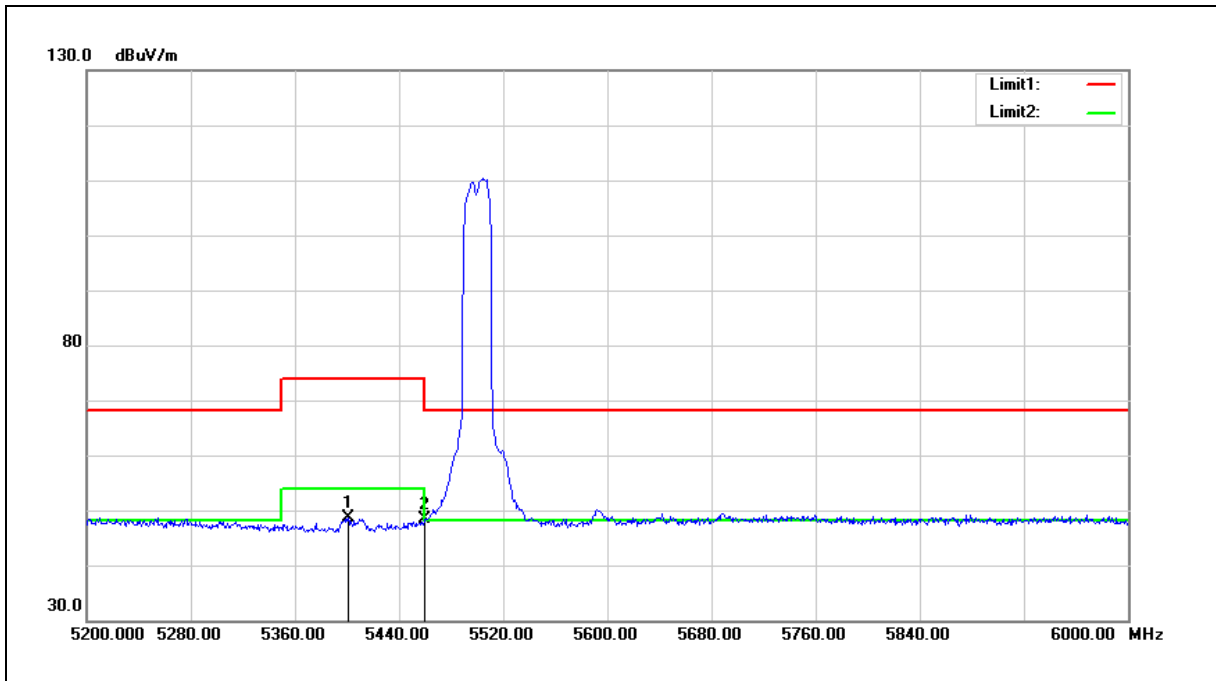

No.	Frequency (MHz)	Reading (dBuV)	Correct Factor (dB/m)	Result (dBuV/m)	Limit (dBuV/m)	Margin (dB)	Remark
1	5400.800	48.12	0.39	48.51	54.00	-5.49	AVG
2	5460.000	47.79	0.51	48.30	54.00	-5.70	AVG

Note:1.Result (dBuV/m) = Correct Factor (dB/m) + Reading(dBuV).

2.Correction factor (dB/m) = Antenna Factor (dB/m) + Cable loss (dB) – Pre-Amplifier gain (dB).

3.When the peak results are less than average limit, so not need to evaluate the average.

Standard:	FCC Part 15.407	Test Distance:	3 m
Test item:	Band edge		
Frequency:	5560 MHz		
Mode:	Mode 8		
Ant.Polar.:	Horizontal		

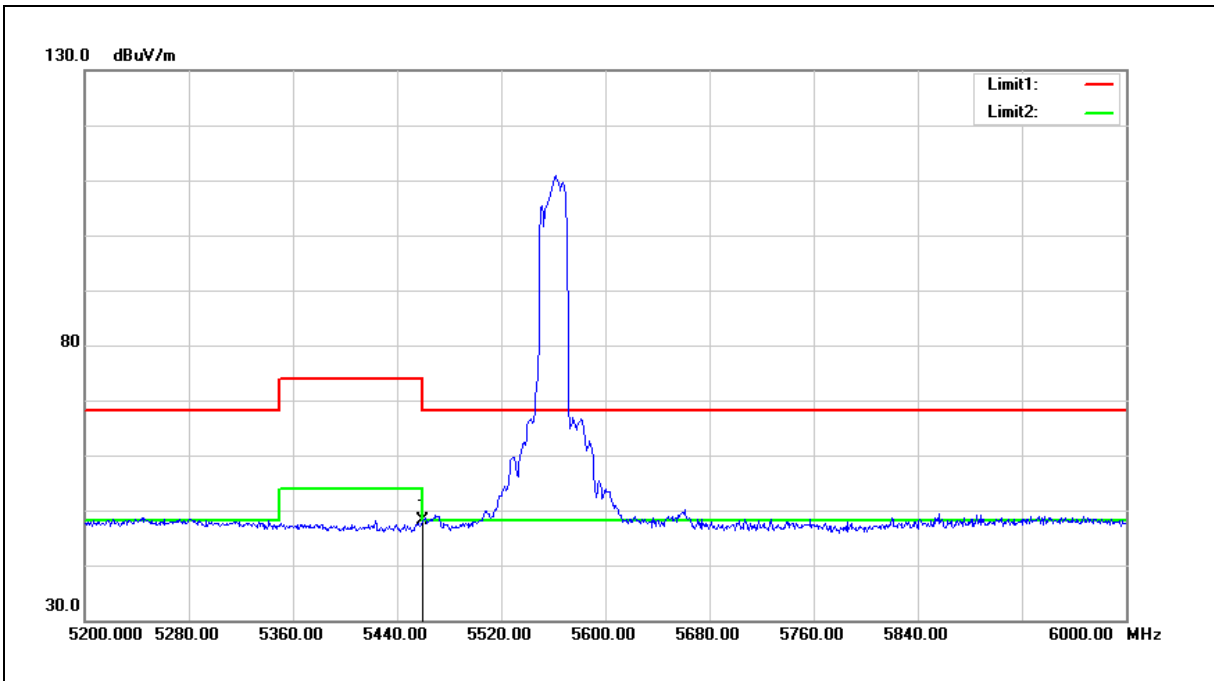

No.	Frequency (MHz)	Reading (dBuV)	Correct Factor (dB/m)	Result (dBuV/m)	Limit (dBuV/m)	Margin (dB)	Remark
1	5460.000	47.65	0.51	48.16	54.00	-5.84	AVG

Note:1.Result (dBuV/m) = Correct Factor (dB/m) + Reading(dBuV).

2.Correction factor (dB/m) = Antenna Factor (dB/m) + Cable loss (dB) – Pre-Amplifier gain (dB).

3.When the peak results are less than average limit, so not need to evaluate the average.

Standard:	FCC Part 15.407	Test Distance:	3 m
Test item:	Band edge		
Frequency:	5560 MHz		
Mode:	Mode 8		
Ant.Polar.:	Vertical		

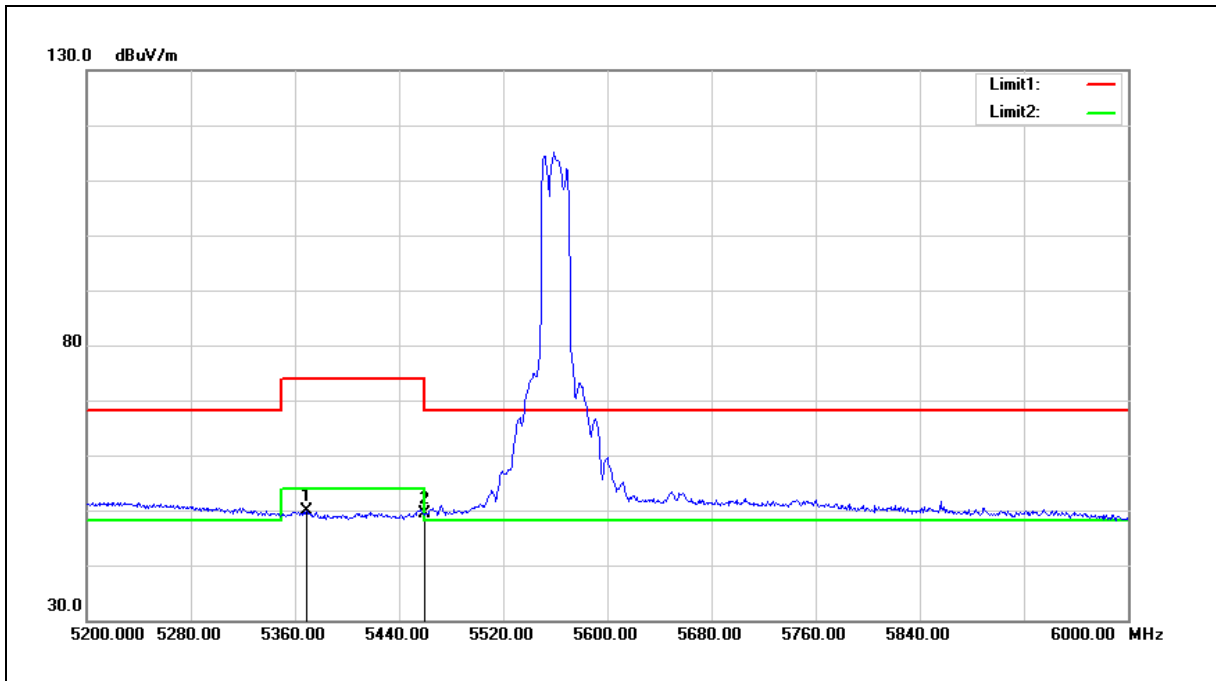

No.	Frequency (MHz)	Reading (dBuV)	Correct Factor (dB/m)	Result (dBuV/m)	Limit (dBuV/m)	Margin (dB)	Remark
1	5368.800	49.53	0.34	49.87	54.00	-4.13	AVG
2	5460.000	48.98	0.51	49.49	54.00	-4.51	AVG

Note:1.Result (dBuV/m) = Correct Factor (dB/m) + Reading(dBuV).

2.Correction factor (dB/m) = Antenna Factor (dB/m) + Cable loss (dB) – Pre-Amplifier gain (dB).

3.When the peak results are less than average limit, so not need to evaluate the average.

Standard:	FCC Part 15.407	Test Distance:	3 m
Test item:	Band edge		
Frequency:	5700 MHz		
Mode:	Mode 8		
Ant.Polar.:	Horizontal		

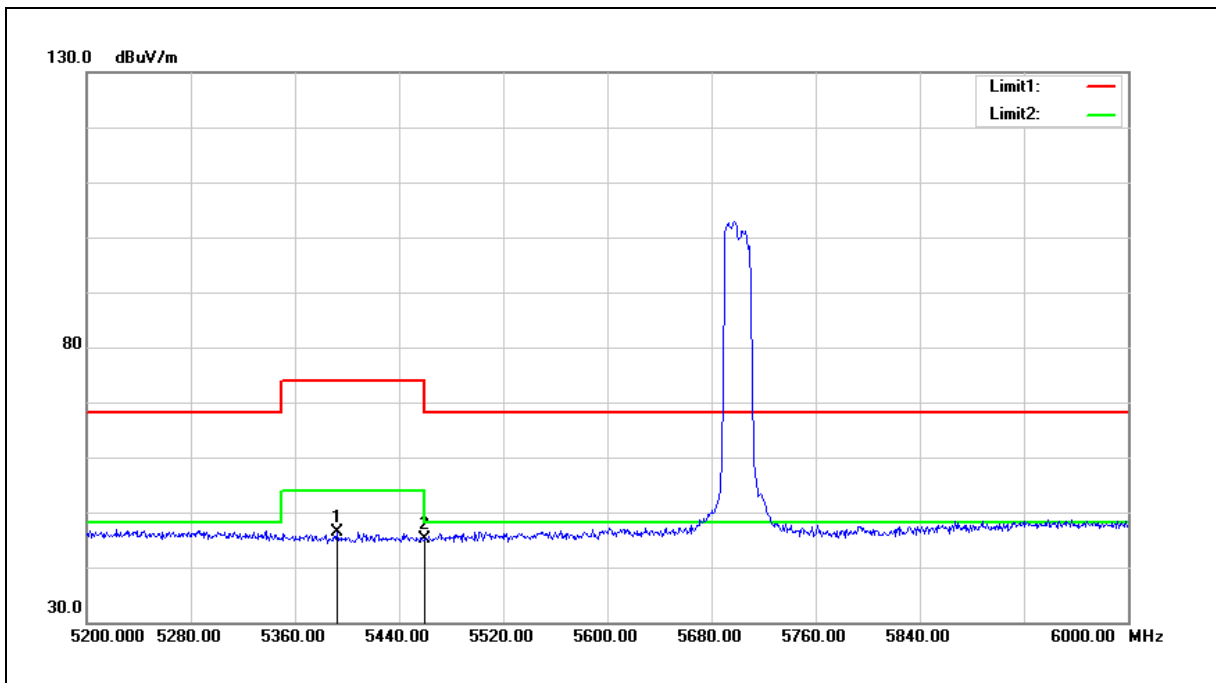

No.	Frequency (MHz)	Reading (dBuV)	Correct Factor (dB/m)	Result (dBuV/m)	Limit (dBuV/m)	Margin (dB)	Remark
1	5392.800	46.08	0.37	46.45	54.00	-7.55	AVG
2	5460.000	44.64	0.51	45.15	54.00	-8.85	AVG

Note:1.Result (dBuV/m) = Correct Factor (dB/m) + Reading(dBuV).

2.Correction factor (dB/m) = Antenna Factor (dB/m) + Cable loss (dB) – Pre-Amplifier gain (dB).

3.When the peak results are less than average limit, so not need to evaluate the average.

Standard:	FCC Part 15.407	Test Distance:	3 m
Test item:	Band edge		
Frequency:	5700 MHz		
Mode:	Mode 8		
Ant.Polar.:	Vertical		

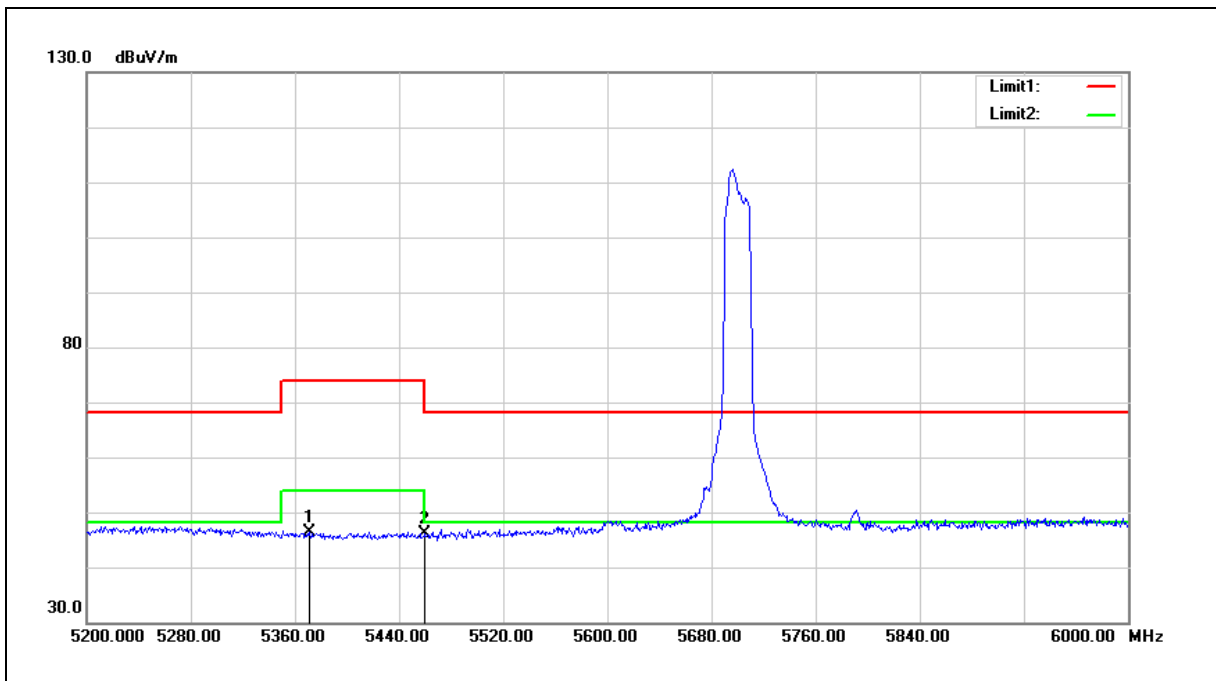

No.	Frequency (MHz)	Reading (dBuV)	Correct Factor (dB/m)	Result (dBuV/m)	Limit (dBuV/m)	Margin (dB)	Remark
1	5371.200	46.04	0.34	46.38	54.00	-7.62	AVG
2	5460.000	45.65	0.51	46.16	54.00	-7.84	AVG

Note:1.Result (dBuV/m) = Correct Factor (dB/m) + Reading(dBuV).

2.Correction factor (dB/m) = Antenna Factor (dB/m) + Cable loss (dB) – Pre-Amplifier gain (dB).

3.When the peak results are less than average limit, so not need to evaluate the average.

Standard:	FCC Part 15.407	Test Distance:	3 m
Test item:	Band edge		
Frequency:	5190 MHz		
Mode:	Mode 9		
Ant.Polar.:	Horizontal		

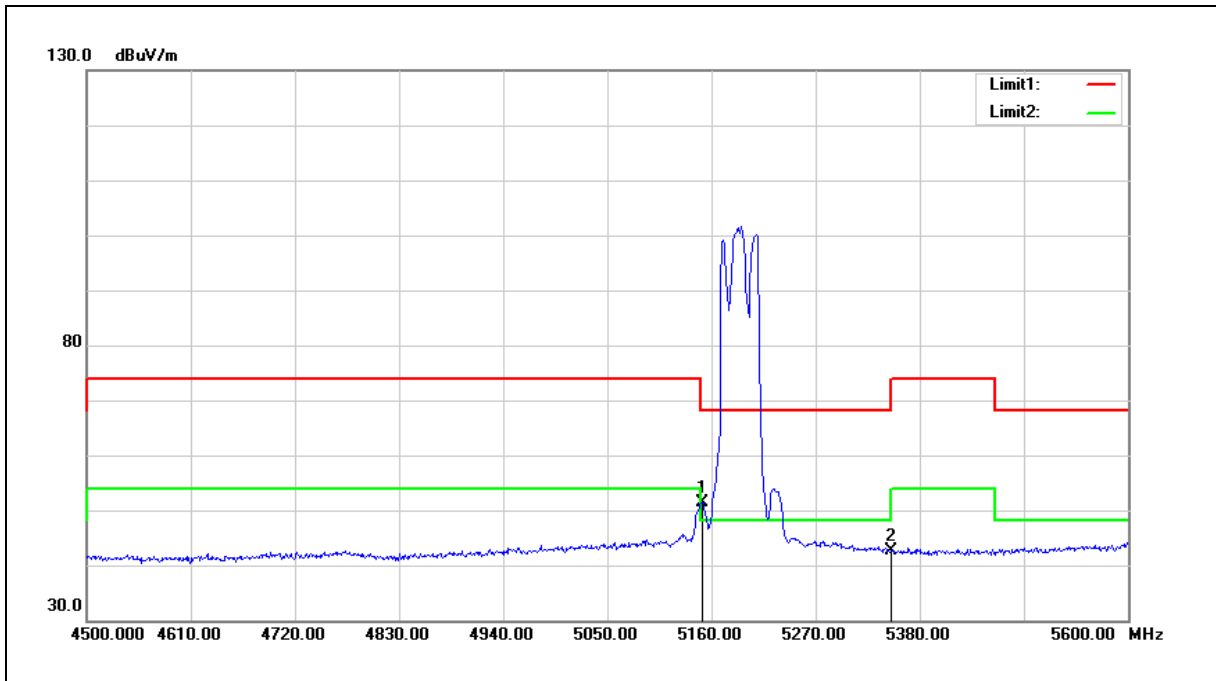

No.	Frequency (MHz)	Reading (dBuV)	Correct Factor (dB/m)	Result (dBuV/m)	Limit (dBuV/m)	Margin (dB)	Remark
1	5150.000	51.51	-0.08	51.43	54.00	-2.57	AVG
2	5350.000	42.33	0.30	42.63	54.00	-11.37	AVG

Note:1.Result (dBuV/m) = Correct Factor (dB/m) + Reading(dBuV).

2.Correction factor (dB/m) = Antenna Factor (dB/m) + Cable loss (dB) – Pre-Amplifier gain (dB).

3.When the peak results are less than average limit, so not need to evaluate the average.

Standard:	FCC Part 15.407	Test Distance:	3 m
Test item:	Band edge		
Frequency:	5190 MHz		
Mode:	Mode 9		
Ant.Polar.:	Vertical		

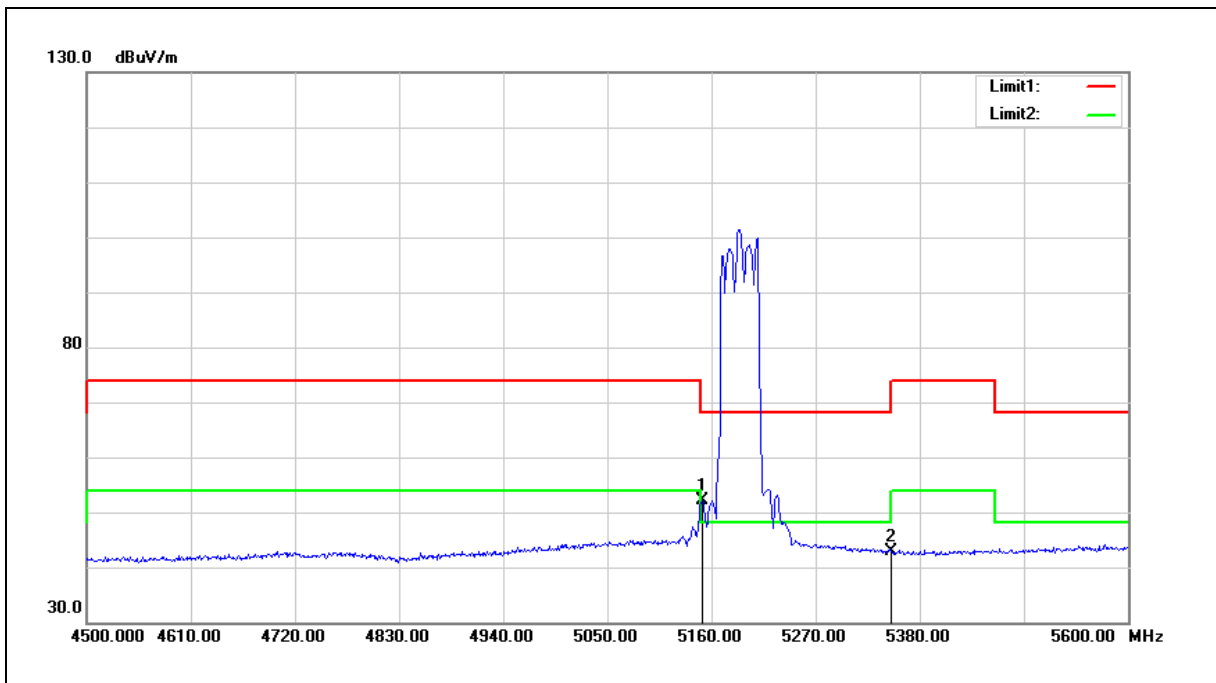

No.	Frequency (MHz)	Reading (dBuV)	Correct Factor (dB/m)	Result (dBuV/m)	Limit (dBuV/m)	Margin (dB)	Remark
1	5150.000	52.17	-0.08	52.09	54.00	-1.91	AVG
2	5350.000	42.61	0.30	42.91	54.00	-11.09	AVG

Note:1.Result (dBuV/m) = Correct Factor (dB/m) + Reading(dBuV).

2.Correction factor (dB/m) = Antenna Factor (dB/m) + Cable loss (dB) – Pre-Amplifier gain (dB).

3.When the peak results are less than average limit, so not need to evaluate the average.

Standard:	FCC Part 15.407	Test Distance:	3 m
Test item:	Band edge		
Frequency:	5230 MHz		
Mode:	Mode 9		
Ant.Polar.:	Horizontal		

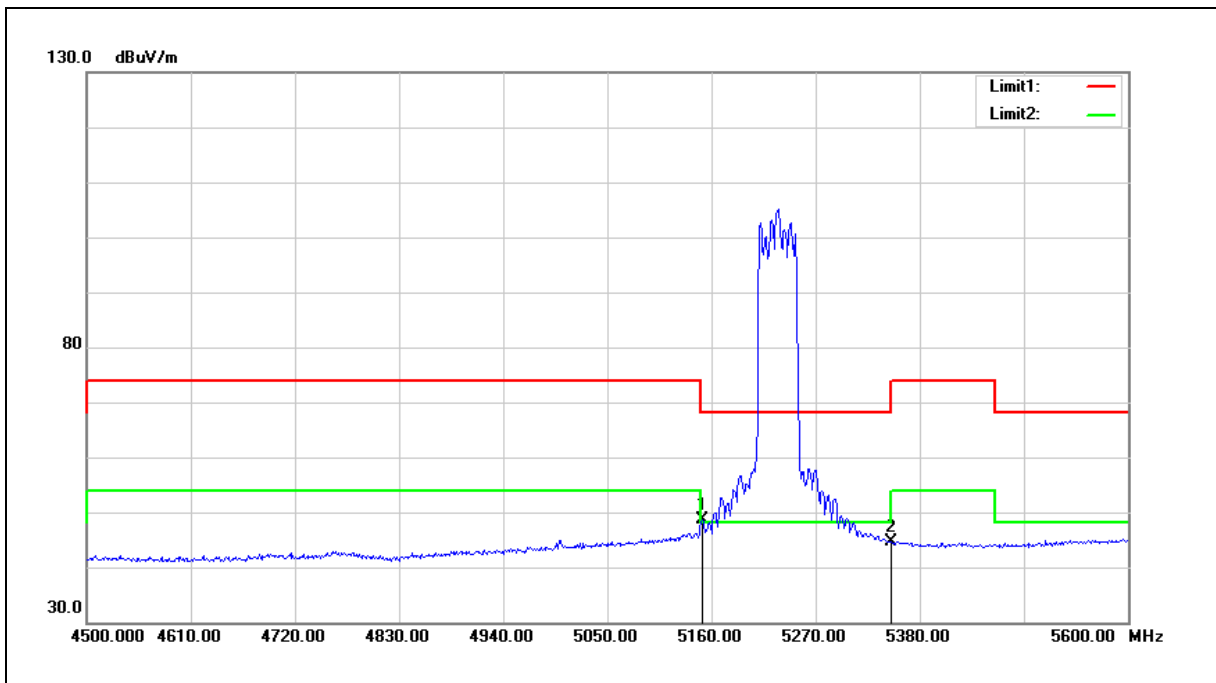

No.	Frequency (MHz)	Reading (dBuV)	Correct Factor (dB/m)	Result (dBuV/m)	Limit (dBuV/m)	Margin (dB)	Remark
1	5150.000	48.77	-0.08	48.69	54.00	-5.31	AVG
2	5350.000	44.27	0.30	44.57	54.00	-9.43	AVG

Note:1.Result (dBuV/m) = Correct Factor (dB/m) + Reading(dBuV).

2.Correction factor (dB/m) = Antenna Factor (dB/m) + Cable loss (dB) – Pre-Amplifier gain (dB).

3.When the peak results are less than average limit, so not need to evaluate the average.

Standard:	FCC Part 15.407	Test Distance:	3 m
Test item:	Band edge		
Frequency:	5230 MHz		
Mode:	Mode 9		
Ant.Polar.:	Vertical		

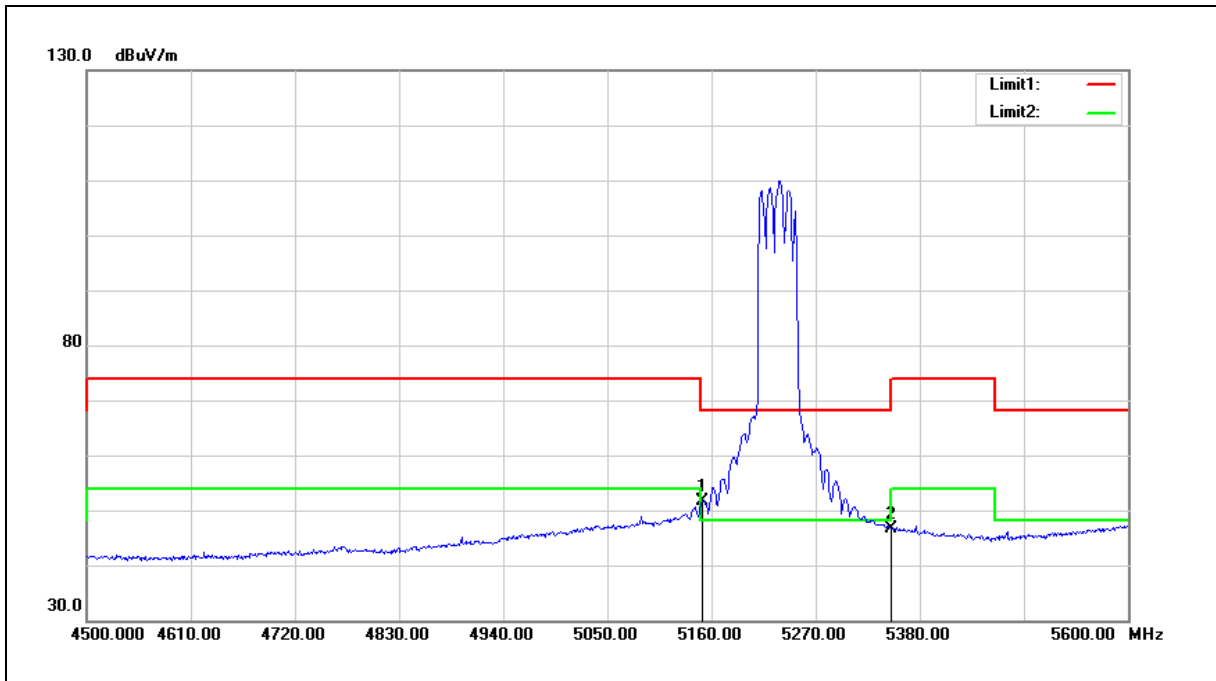

No.	Frequency (MHz)	Reading (dBuV)	Correct Factor (dB/m)	Result (dBuV/m)	Limit (dBuV/m)	Margin (dB)	Remark
1	5150.000	51.68	-0.08	51.60	54.00	-2.40	AVG
2	5350.000	46.44	0.30	46.74	54.00	-7.26	AVG

Note:1.Result (dBuV/m) = Correct Factor (dB/m) + Reading(dBuV).

2.Correction factor (dB/m) = Antenna Factor (dB/m) + Cable loss (dB) – Pre-Amplifier gain (dB).

3.When the peak results are less than average limit, so not need to evaluate the average.

Standard:	FCC Part 15.407	Test Distance:	3 m
Test item:	Band edge		
Frequency:	5270 MHz		
Mode:	Mode 9		
Ant.Polar.:	Horizontal		

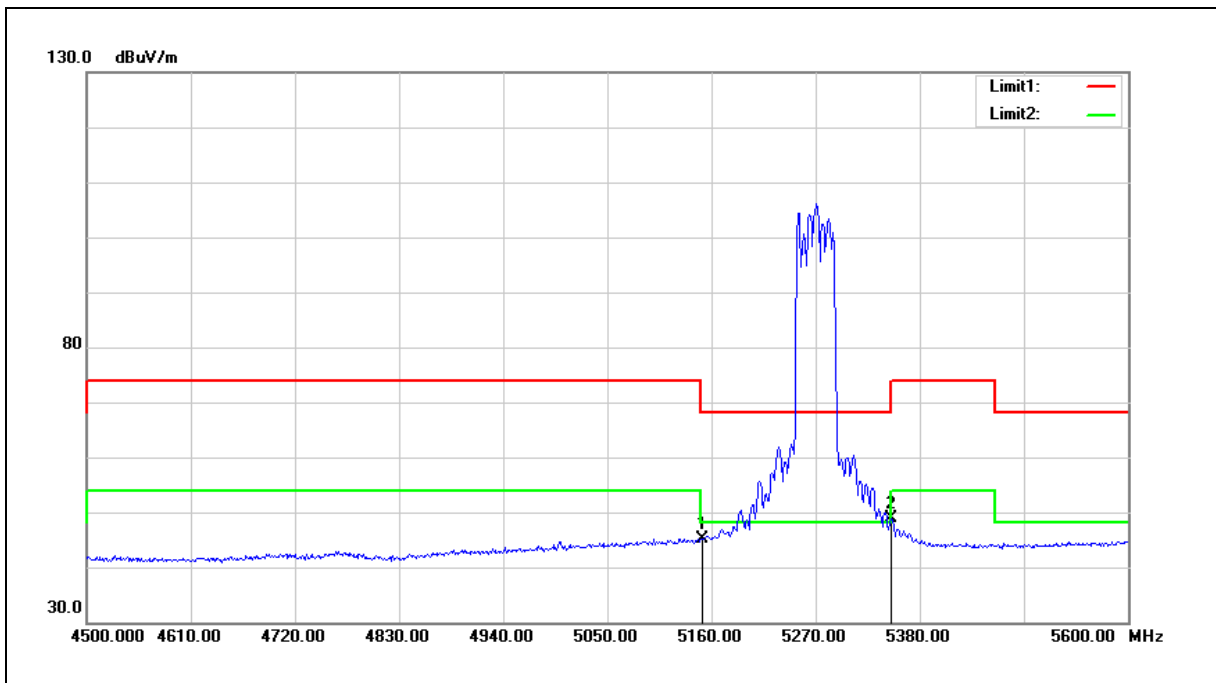

No.	Frequency (MHz)	Reading (dBuV)	Correct Factor (dB/m)	Result (dBuV/m)	Limit (dBuV/m)	Margin (dB)	Remark
1	5150.000	45.26	-0.08	45.18	54.00	-8.82	AVG
2	5350.000	48.58	0.30	48.88	54.00	-5.12	AVG

Note:1.Result (dBuV/m) = Correct Factor (dB/m) + Reading(dBuV).

2.Correction factor (dB/m) = Antenna Factor (dB/m) + Cable loss (dB) – Pre-Amplifier gain (dB).

3.When the peak results are less than average limit, so not need to evaluate the average.

Standard:	FCC Part 15.407	Test Distance:	3 m
Test item:	Band edge		
Frequency:	5270 MHz		
Mode:	Mode 9		
Ant.Polar.:	Vertical		

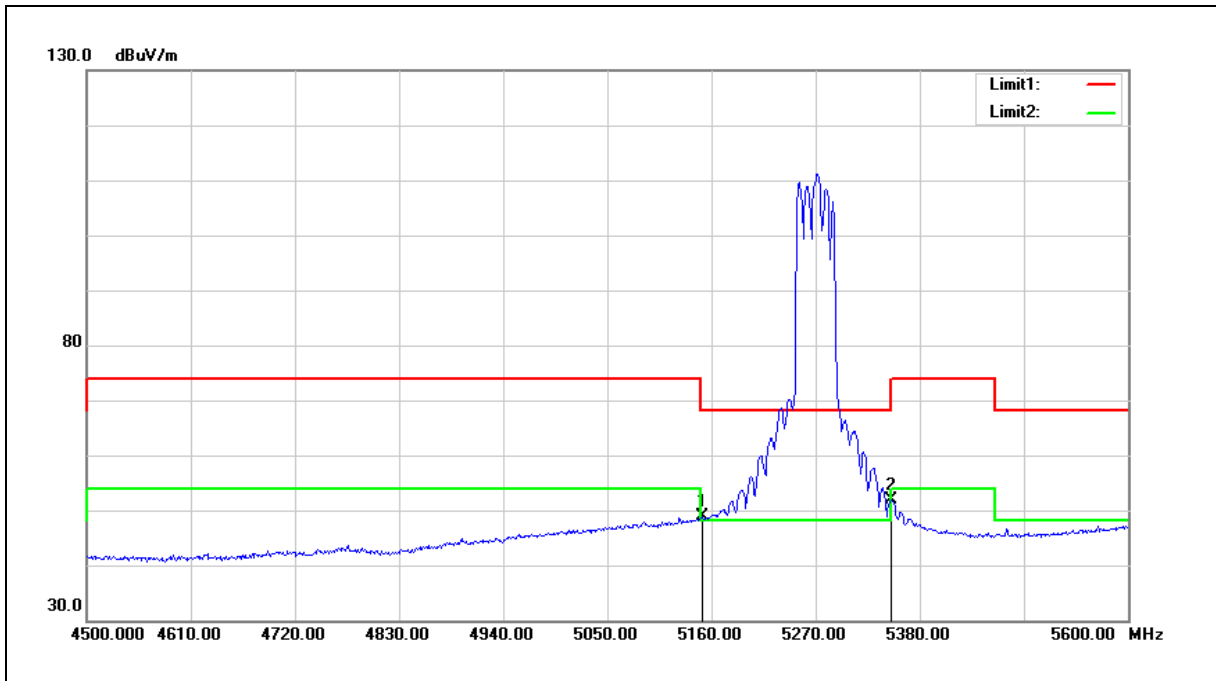

No.	Frequency (MHz)	Reading (dBuV)	Correct Factor (dB/m)	Result (dBuV/m)	Limit (dBuV/m)	Margin (dB)	Remark
1	5150.000	48.86	-0.08	48.78	54.00	-5.22	AVG
2	5350.000	51.60	0.30	51.90	54.00	-2.10	AVG

Note:1.Result (dBuV/m) = Correct Factor (dB/m) + Reading(dBuV).

2.Correction factor (dB/m) = Antenna Factor (dB/m) + Cable loss (dB) – Pre-Amplifier gain (dB).

3.When the peak results are less than average limit, so not need to evaluate the average.

Standard:	FCC Part 15.407	Test Distance:	3 m
Test item:	Band edge		
Frequency:	5310 MHz		
Mode:	Mode 9		
Ant.Polar.:	Horizontal		

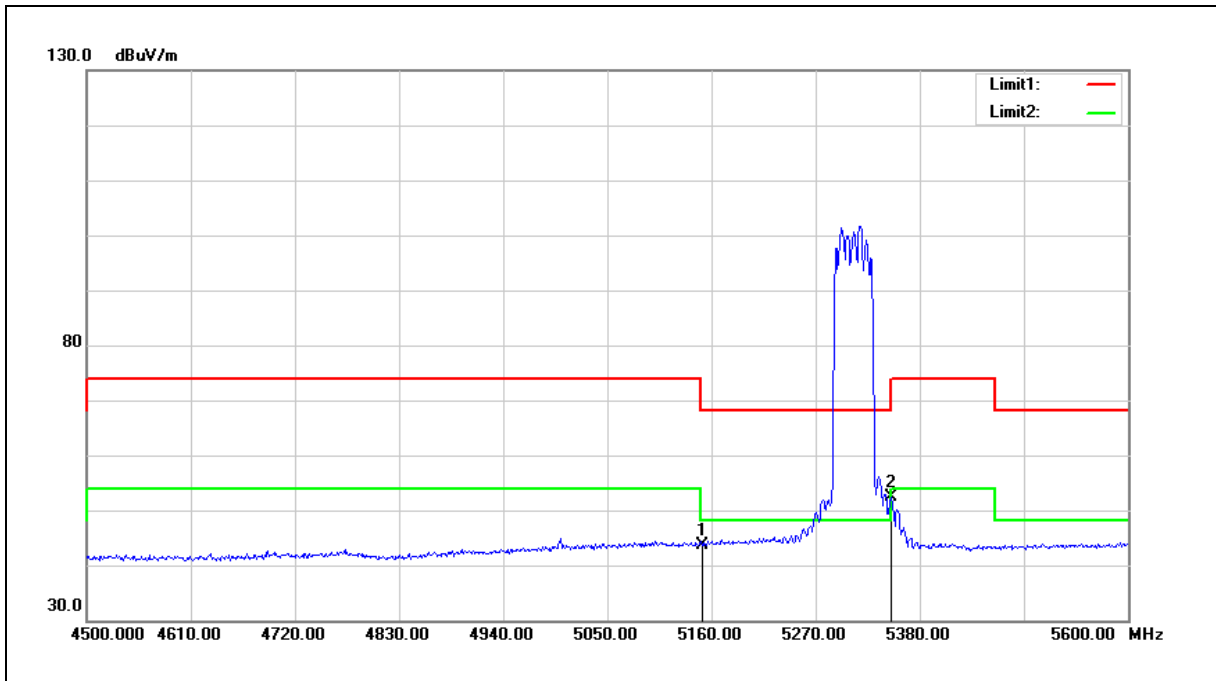

No.	Frequency (MHz)	Reading (dBuV)	Correct Factor (dB/m)	Result (dBuV/m)	Limit (dBuV/m)	Margin (dB)	Remark
1	5150.000	43.82	-0.08	43.74	54.00	-10.26	AVG
2	5350.000	52.07	0.30	52.37	54.00	-1.63	AVG

Note:1.Result (dBuV/m) = Correct Factor (dB/m) + Reading(dBuV).

2.Correction factor (dB/m) = Antenna Factor (dB/m) + Cable loss (dB) – Pre-Amplifier gain (dB).

3.When the peak results are less than average limit, so not need to evaluate the average.

Standard:	FCC Part 15.407	Test Distance:	3 m
Test item:	Band edge		
Frequency:	5310 MHz		
Mode:	Mode 9		
Ant.Polar.:	Vertical		

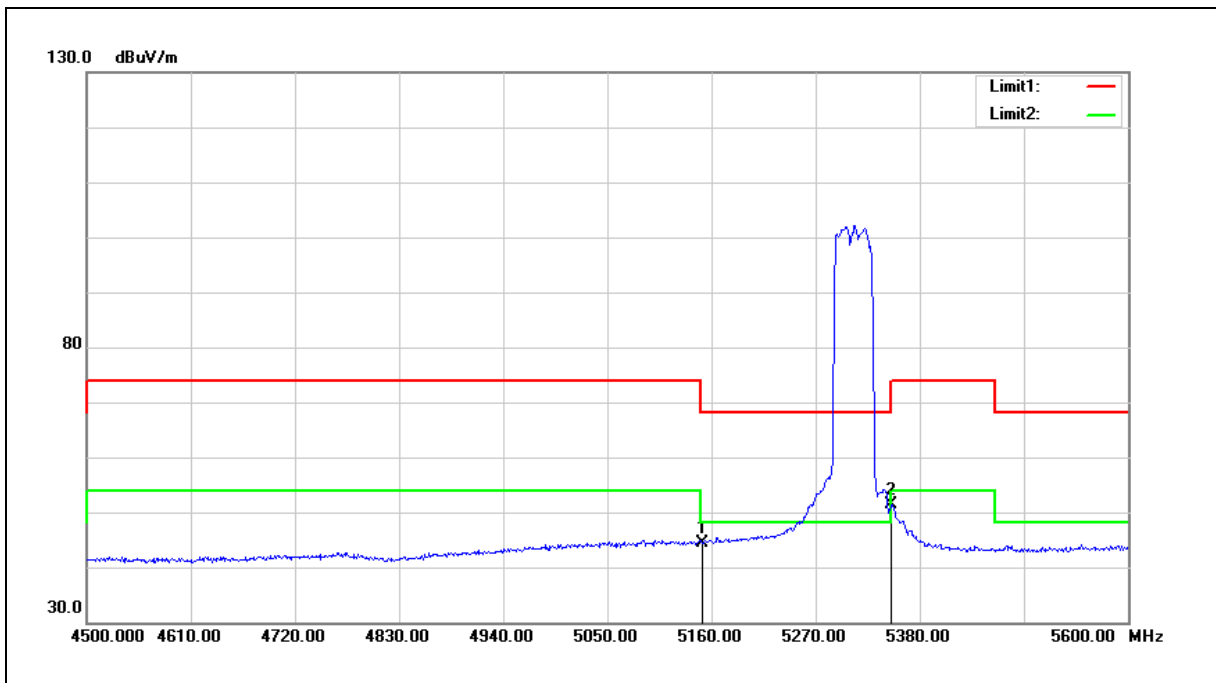

No.	Frequency (MHz)	Reading (dBuV)	Correct Factor (dB/m)	Result (dBuV/m)	Limit (dBuV/m)	Margin (dB)	Remark
1	5150.000	44.57	-0.08	44.49	54.00	-9.51	AVG
2	5350.000	51.12	0.30	51.42	54.00	-2.58	AVG

Note:1.Result (dBuV/m) = Correct Factor (dB/m) + Reading(dBuV).

2.Correction factor (dB/m) = Antenna Factor (dB/m) + Cable loss (dB) – Pre-Amplifier gain (dB).

3.When the peak results are less than average limit, so not need to evaluate the average.

Standard:	FCC Part 15.407	Test Distance:	3 m
Test item:	Band edge		
Frequency:	5510 MHz		
Mode:	Mode 9		
Ant.Polar.:	Horizontal		

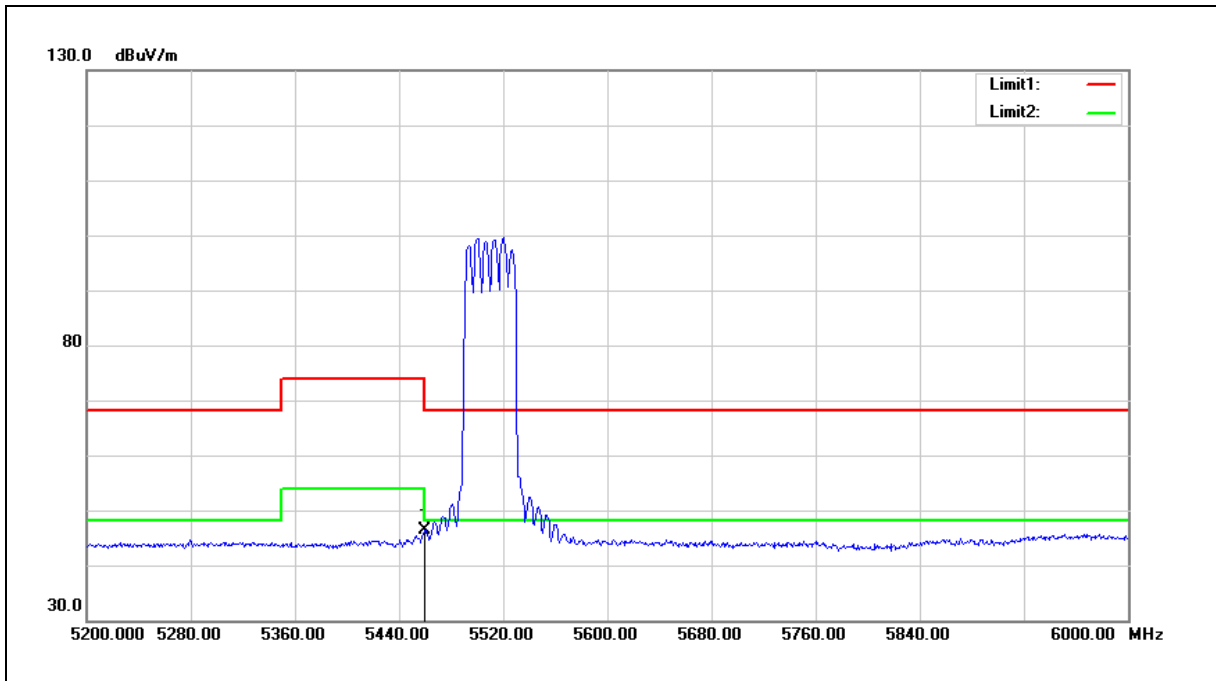

No.	Frequency (MHz)	Reading (dBuV)	Correct Factor (dB/m)	Result (dBuV/m)	Limit (dBuV/m)	Margin (dB)	Remark
1	5460.000	45.86	0.51	46.37	54.00	-7.63	AVG

Note:1.Result (dBuV/m) = Correct Factor (dB/m) + Reading(dBuV).

2.Correction factor (dB/m) = Antenna Factor (dB/m) + Cable loss (dB) – Pre-Amplifier gain (dB).

3.When the peak results are less than average limit, so not need to evaluate the average.

Standard:	FCC Part 15.407	Test Distance:	3 m
Test item:	Band edge		
Frequency:	5510 MHz		
Mode:	Mode 9		
Ant.Polar.:	Vertical		

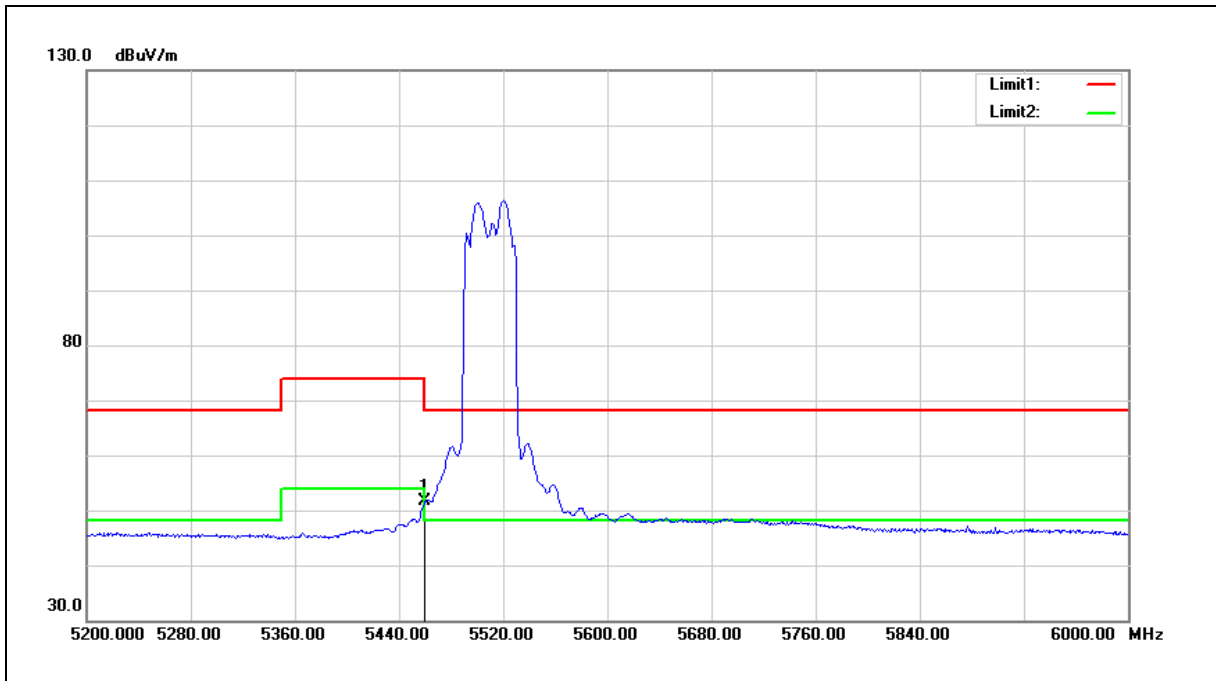

No.	Frequency (MHz)	Reading (dBuV)	Correct Factor (dB/m)	Result (dBuV/m)	Limit (dBuV/m)	Margin (dB)	Remark
1	5460.000	51.18	0.51	51.69	54.00	-2.31	AVG

Note:1.Result (dBuV/m) = Correct Factor (dB/m) + Reading(dBuV).

2.Correction factor (dB/m) = Antenna Factor (dB/m) + Cable loss (dB) – Pre-Amplifier gain (dB).

3.When the peak results are less than average limit, so not need to evaluate the average.

Standard:	FCC Part 15.407	Test Distance:	3 m
Test item:	Band edge		
Frequency:	5550 MHz		
Mode:	Mode 9		
Ant.Polar.:	Horizontal		

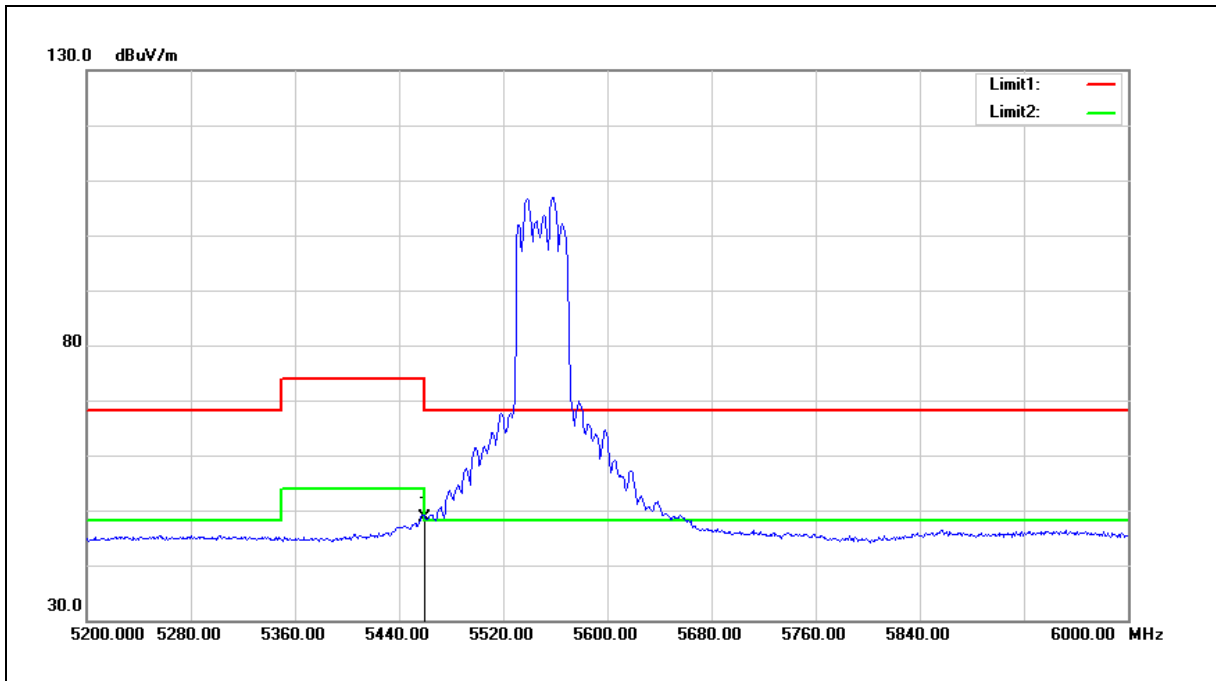

No.	Frequency (MHz)	Reading (dBuV)	Correct Factor (dB/m)	Result (dBuV/m)	Limit (dBuV/m)	Margin (dB)	Remark
1	5460.000	48.23	0.51	48.74	54.00	-5.26	AVG

Note:1.Result (dBuV/m) = Correct Factor (dB/m) + Reading(dBuV).

2.Correction factor (dB/m) = Antenna Factor (dB/m) + Cable loss (dB) – Pre-Amplifier gain (dB).

3.When the peak results are less than average limit, so not need to evaluate the average.

Standard:	FCC Part 15.407	Test Distance:	3 m
Test item:	Band edge		
Frequency:	5550 MHz		
Mode:	Mode 9		
Ant.Polar.:	Vertical		

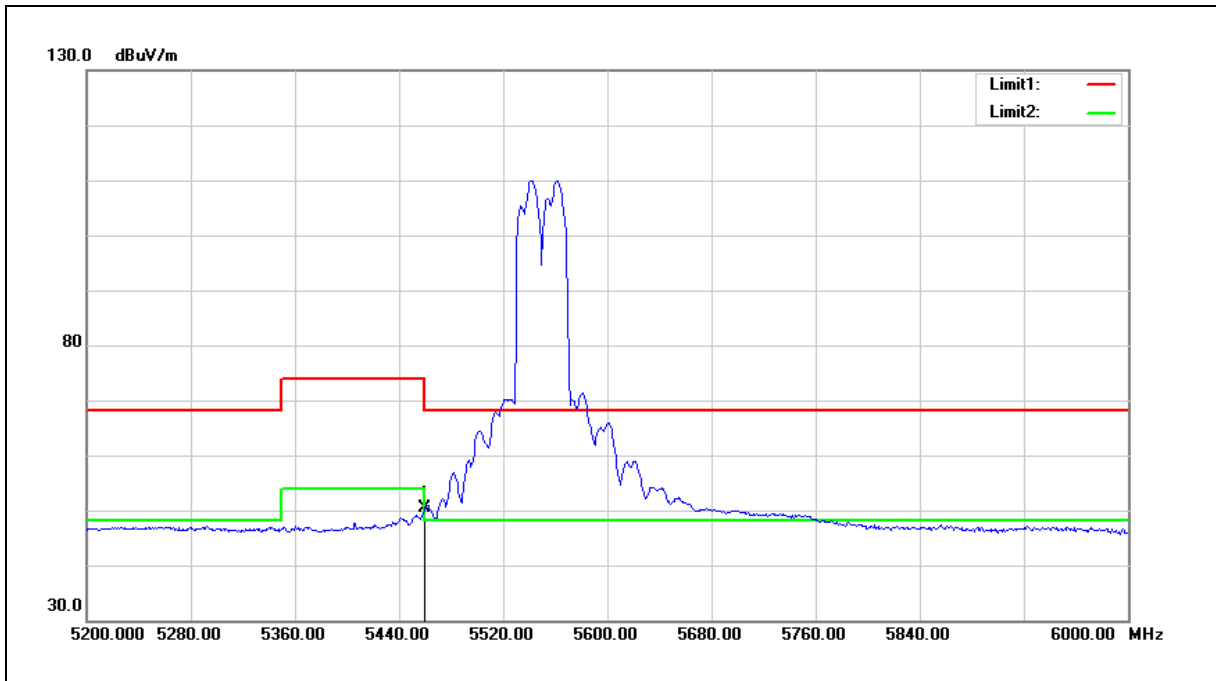

No.	Frequency (MHz)	Reading (dBuV)	Correct Factor (dB/m)	Result (dBuV/m)	Limit (dBuV/m)	Margin (dB)	Remark
1	5460.000	49.94	0.51	50.45	54.00	-3.55	AVG

Note: 1. Result (dBuV/m) = Correct Factor (dB/m) + Reading(dBuV).

2. Correction factor (dB/m) = Antenna Factor (dB/m) + Cable loss (dB) – Pre-Amplifier gain (dB).

3. When the peak results are less than average limit, so not need to evaluate the average.

Standard:	FCC Part 15.407	Test Distance:	3 m
Test item:	Band edge		
Frequency:	5670 MHz		
Mode:	Mode 9		
Ant.Polar.:	Horizontal		

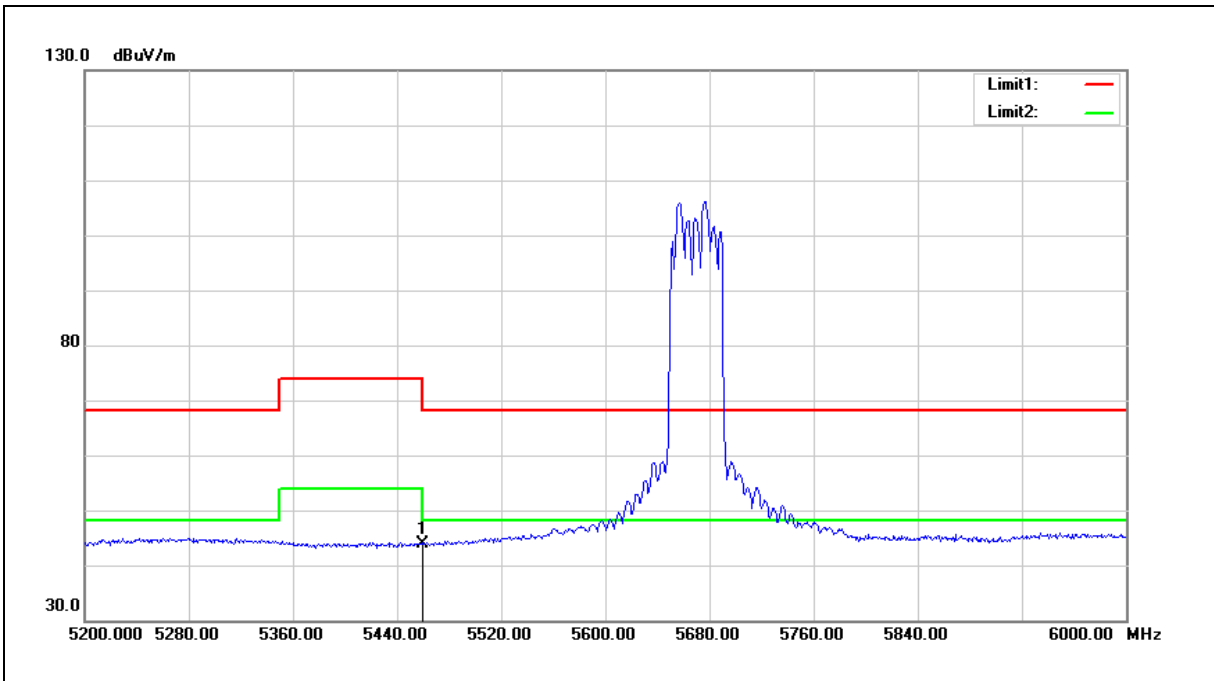

No.	Frequency (MHz)	Reading (dBuV)	Correct Factor (dB/m)	Result (dBuV/m)	Limit (dBuV/m)	Margin (dB)	Remark
1	5460.000	43.46	0.51	43.97	54.00	-10.03	AVG

Note:1.Result (dBuV/m) = Correct Factor (dB/m) + Reading(dBuV).

2.Correction factor (dB/m) = Antenna Factor (dB/m) + Cable loss (dB) – Pre-Amplifier gain (dB).

3.When the peak results are less than average limit, so not need to evaluate the average.

Standard:	FCC Part 15.407	Test Distance:	3 m
Test item:	Band edge		
Frequency:	5670 MHz		
Mode:	Mode 9		
Ant.Polar.:	Vertical		

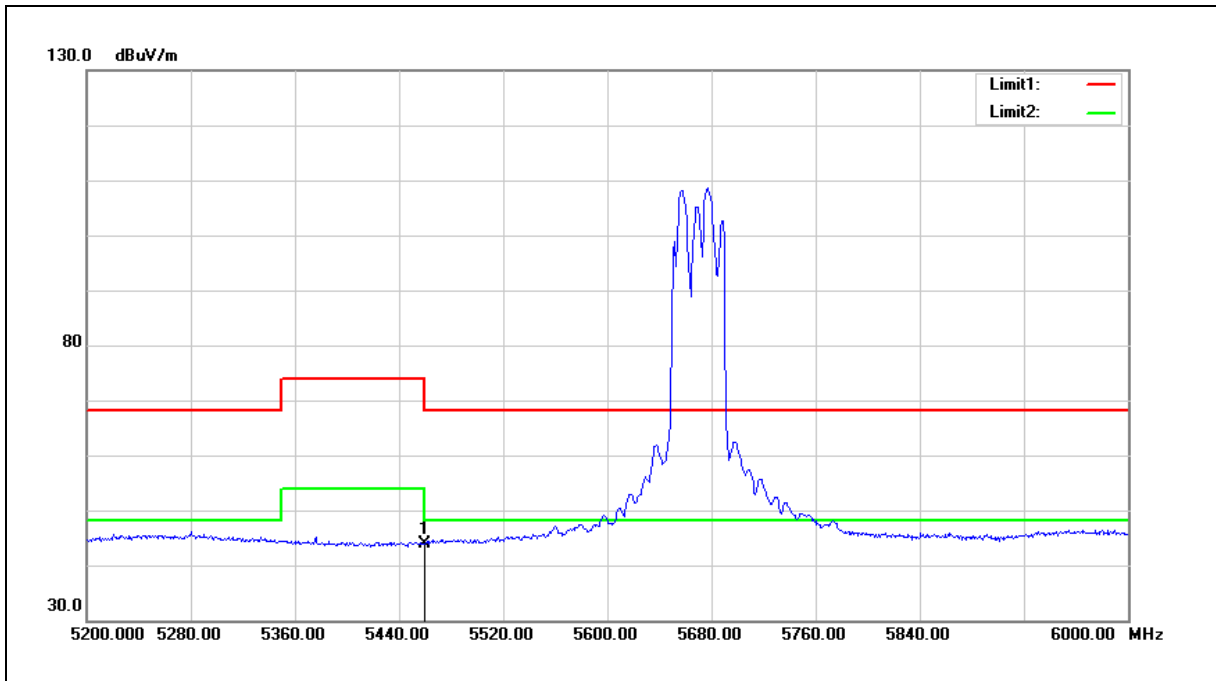

No.	Frequency (MHz)	Reading (dBuV)	Correct Factor (dB/m)	Result (dBuV/m)	Limit (dBuV/m)	Margin (dB)	Remark
1	5460.000	43.26	0.51	43.77	54.00	-10.23	AVG

Note:1.Result (dBuV/m) = Correct Factor (dB/m) + Reading(dBuV).

2.Correction factor (dB/m) = Antenna Factor (dB/m) + Cable loss (dB) – Pre-Amplifier gain (dB).

3.When the peak results are less than average limit, so not need to evaluate the average.

Standard:	FCC Part 15.407	Test Distance:	3 m
Test item:	Band edge		
Frequency:	5210 MHz		
Mode:	Mode 10		
Ant.Polar.:	Horizontal		

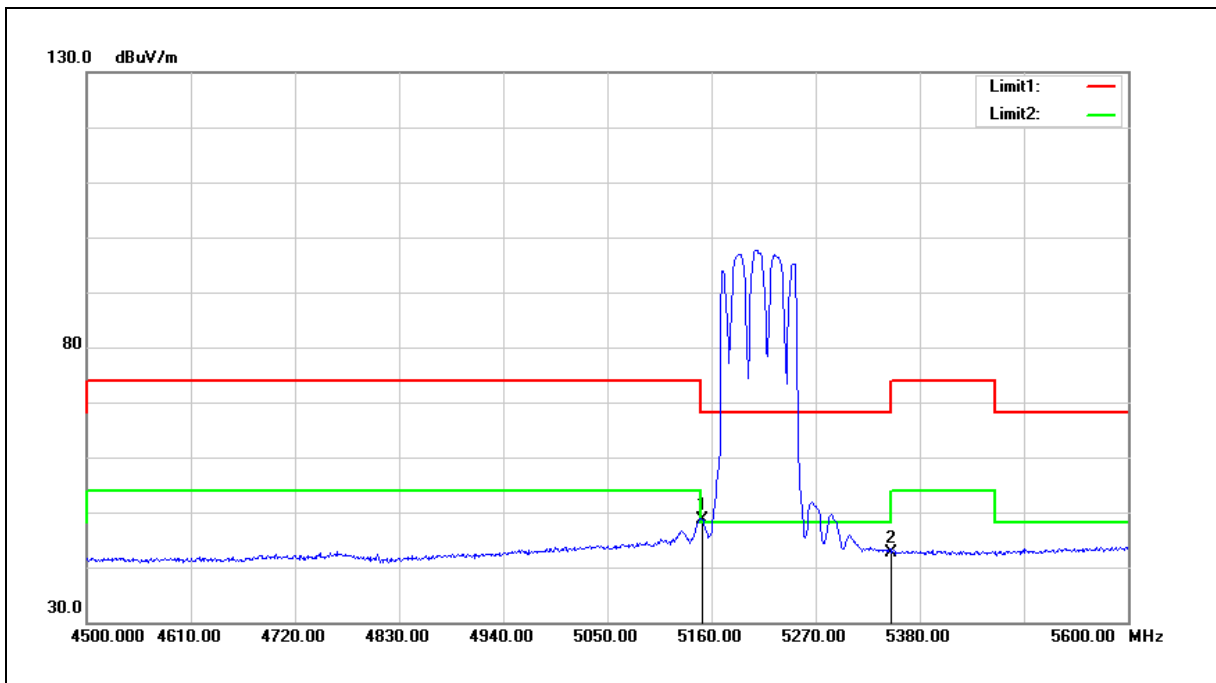

No.	Frequency (MHz)	Reading (dBuV)	Correct Factor (dB/m)	Result (dBuV/m)	Limit (dBuV/m)	Margin (dB)	Remark
1	5150.000	48.73	-0.08	48.65	54.00	-5.35	AVG
2	5350.000	42.42	0.30	42.72	54.00	-11.28	AVG

Note:1.Result (dBuV/m) = Correct Factor (dB/m) + Reading(dBuV).

2.Correction factor (dB/m) = Antenna Factor (dB/m) + Cable loss (dB) – Pre-Amplifier gain (dB).

3.When the peak results are less than average limit, so not need to evaluate the average.

Standard:	FCC Part 15.407	Test Distance:	3 m
Test item:	Band edge		
Frequency:	5210 MHz		
Mode:	Mode 10		
Ant.Polar.:	Vertical		

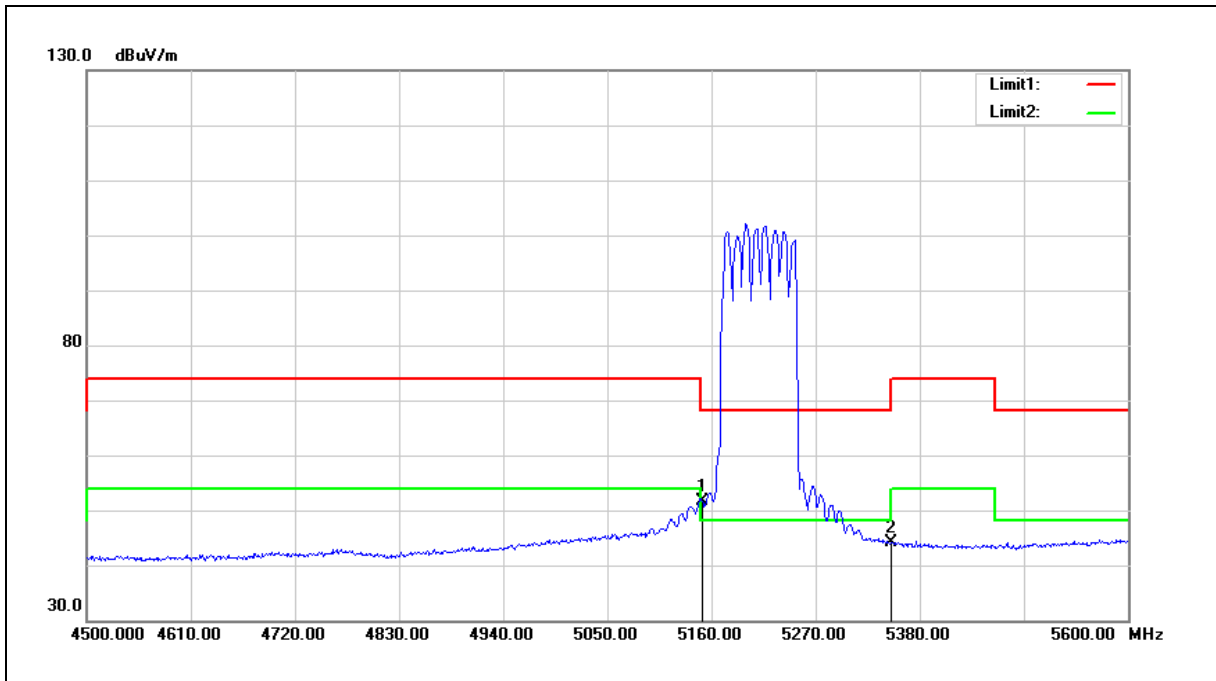

No.	Frequency (MHz)	Reading (dBuV)	Correct Factor (dB/m)	Result (dBuV/m)	Limit (dBuV/m)	Margin (dB)	Remark
1	5150.000	51.76	-0.08	51.68	54.00	-2.32	AVG
2	5350.000	43.89	0.30	44.19	54.00	-9.81	AVG

Note:1.Result (dBuV/m) = Correct Factor (dB/m) + Reading(dBuV).

2.Correction factor (dB/m) = Antenna Factor (dB/m) + Cable loss (dB) – Pre-Amplifier gain (dB).

3.When the peak results are less than average limit, so not need to evaluate the average.

Standard:	FCC Part 15.407	Test Distance:	3 m
Test item:	Band edge		
Frequency:	5290 MHz		
Mode:	Mode 10		
Ant.Polar.:	Horizontal		

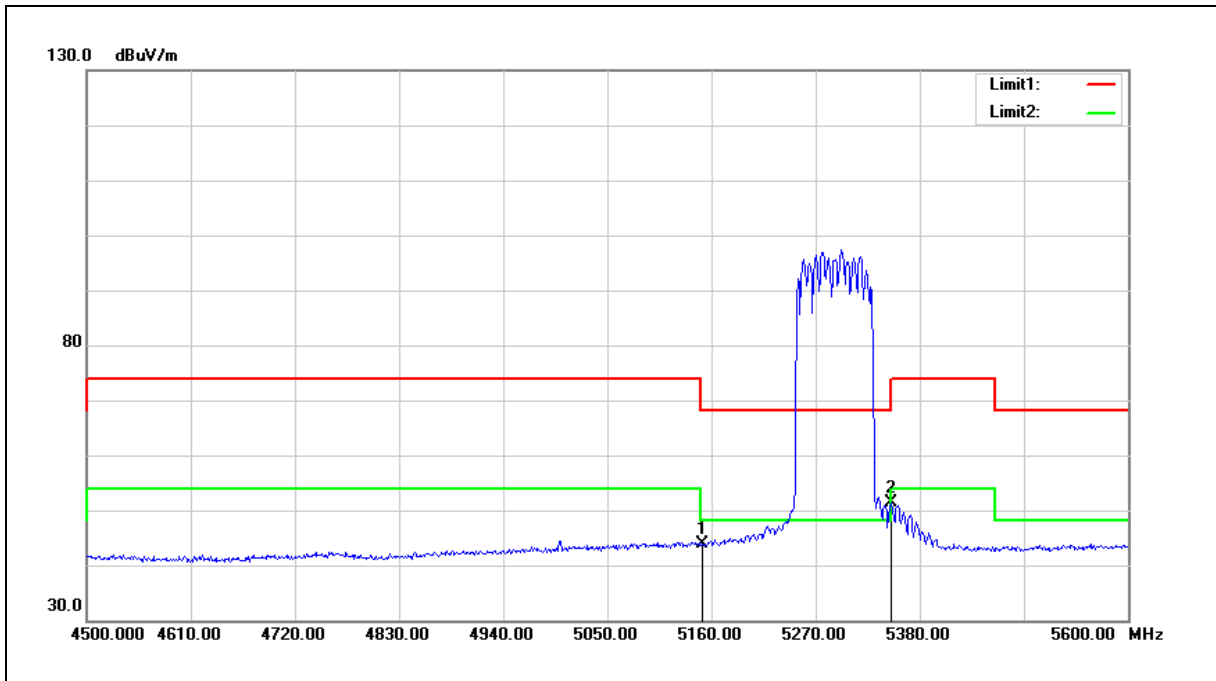

No.	Frequency (MHz)	Reading (dBuV)	Correct Factor (dB/m)	Result (dBuV/m)	Limit (dBuV/m)	Margin (dB)	Remark
1	5150.000	44.02	-0.08	43.94	54.00	-10.06	AVG
2	5350.000	51.11	0.30	51.41	54.00	-2.59	AVG

Note:1.Result (dBuV/m) = Correct Factor (dB/m) + Reading(dBuV).

2.Correction factor (dB/m) = Antenna Factor (dB/m) + Cable loss (dB) – Pre-Amplifier gain (dB).

3.When the peak results are less than average limit, so not need to evaluate the average.

Standard:	FCC Part 15.407	Test Distance:	3 m
Test item:	Band edge		
Frequency:	5290 MHz		
Mode:	Mode 10		
Ant.Polar.:	Vertical		

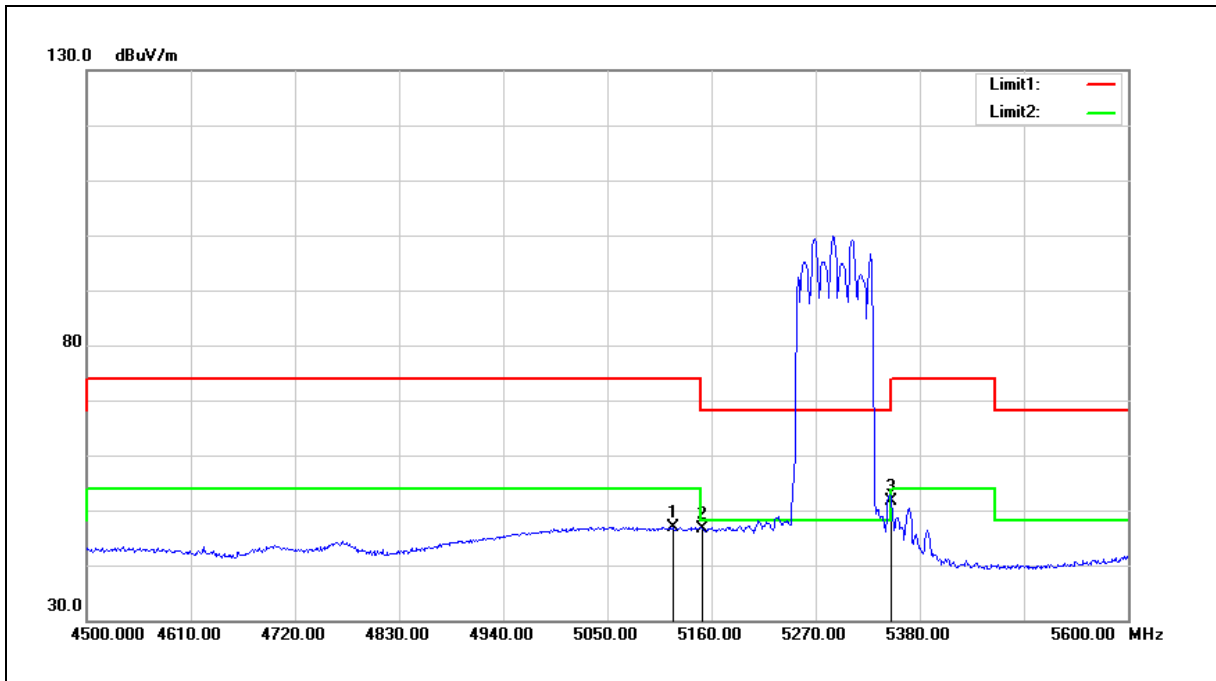

No.	Frequency (MHz)	Reading (dBuV)	Correct Factor (dB/m)	Result (dBuV/m)	Limit (dBuV/m)	Margin (dB)	Remark
1	5119.300	47.07	-0.13	46.94	54.00	-7.06	AVG
2	5150.000	46.74	-0.08	46.66	54.00	-7.34	AVG
3	5350.000	51.39	0.30	51.69	54.00	-2.31	AVG

Note:1.Result (dBuV/m) = Correct Factor (dB/m) + Reading(dBuV).

2.Correction factor (dB/m) = Antenna Factor (dB/m) + Cable loss (dB) – Pre-Amplifier gain (dB).

3.When the peak results are less than average limit, so not need to evaluate the average.

Standard:	FCC Part 15.407	Test Distance:	3 m
Test item:	Band edge		
Frequency:	5530 MHz		
Mode:	Mode 10		
Ant.Polar.:	Horizontal		

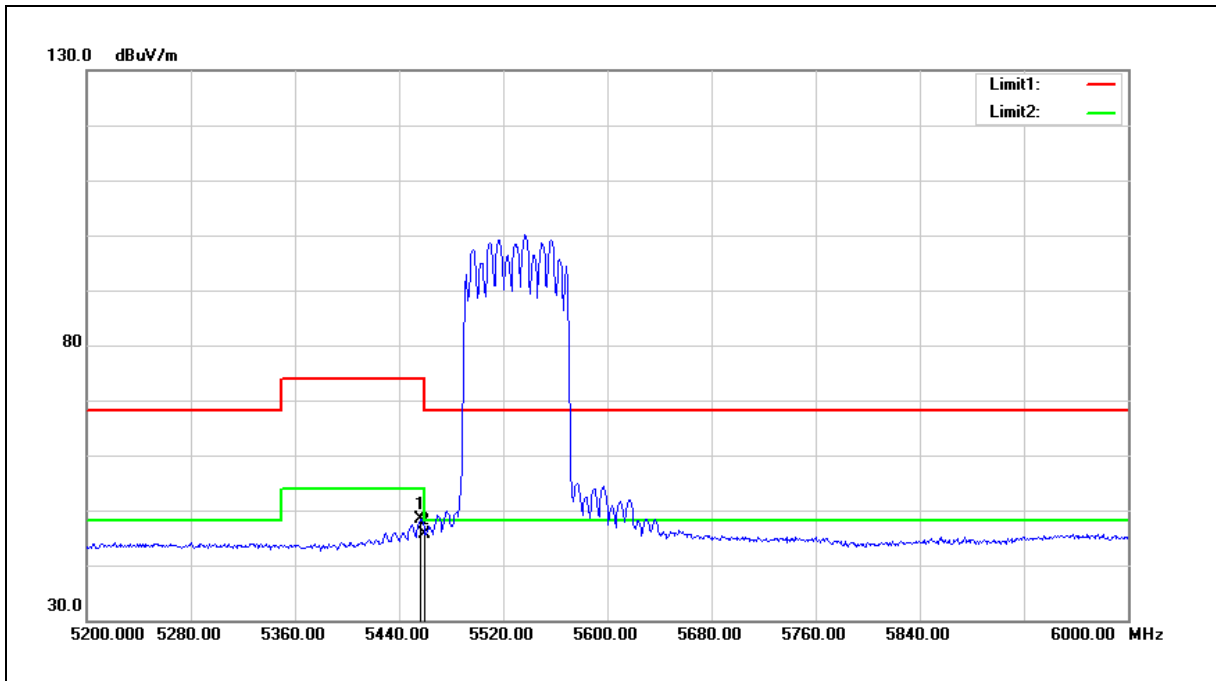

No.	Frequency (MHz)	Reading (dBuV)	Correct Factor (dB/m)	Result (dBuV/m)	Limit (dBuV/m)	Margin (dB)	Remark
1	5456.800	47.82	0.50	48.32	54.00	-5.68	AVG
2	5460.000	45.19	0.51	45.70	54.00	-8.30	AVG

Note:1.Result (dBuV/m) = Correct Factor (dB/m) + Reading(dBuV).

2.Correction factor (dB/m) = Antenna Factor (dB/m) + Cable loss (dB) – Pre-Amplifier gain (dB).

3.When the peak results are less than average limit, so not need to evaluate the average.

Standard:	FCC Part 15.407	Test Distance:	3 m
Test item:	Band edge		
Frequency:	5530 MHz		
Mode:	Mode 10		
Ant.Polar.:	Vertical		

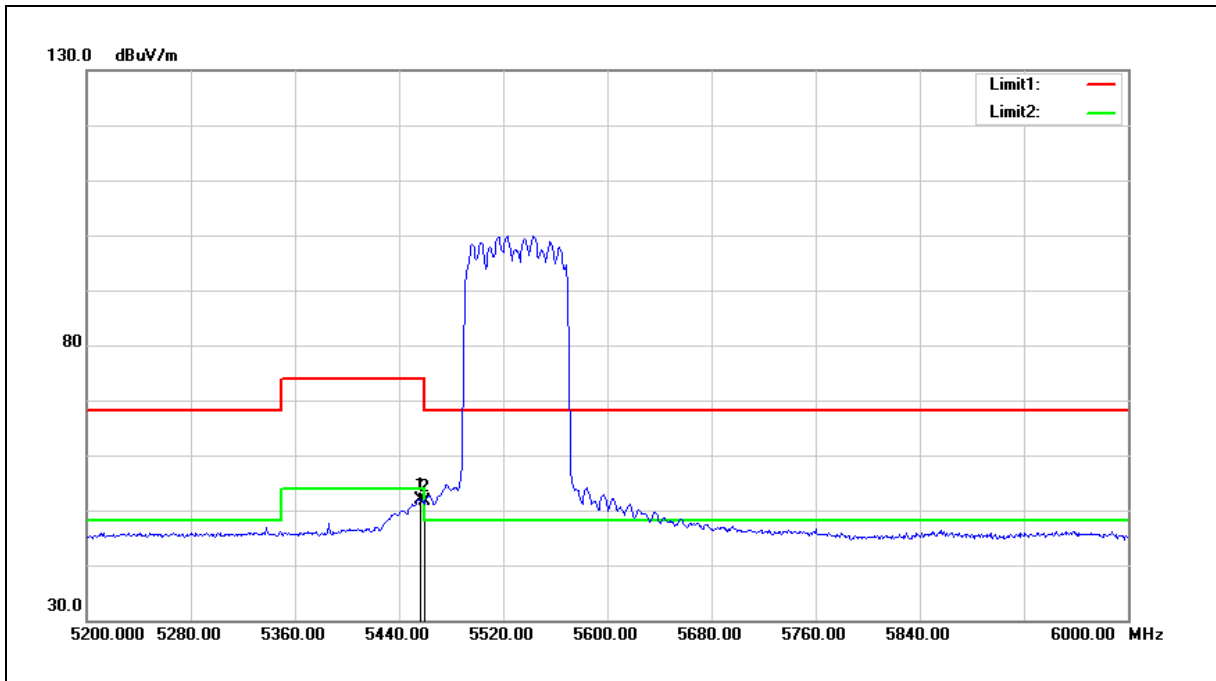

No.	Frequency (MHz)	Reading (dBuV)	Correct Factor (dB/m)	Result (dBuV/m)	Limit (dBuV/m)	Margin (dB)	Remark
1	5456.000	51.50	0.49	51.99	54.00	-2.01	AVG
2	5460.000	51.07	0.51	51.58	54.00	-2.42	AVG

Note:1.Result (dBuV/m) = Correct Factor (dB/m) + Reading(dBuV).

2.Correction factor (dB/m) = Antenna Factor (dB/m) + Cable loss (dB) – Pre-Amplifier gain (dB).

3.When the peak results are less than average limit, so not need to evaluate the average.

Beamforming on

Below 1 GHz

Standard:	FCC Part 15.407	Test Distance:	3 m
Test item:	Radiated Emission		
Mode:	Mode 1		
Ant.Polar.:	Horizontal		

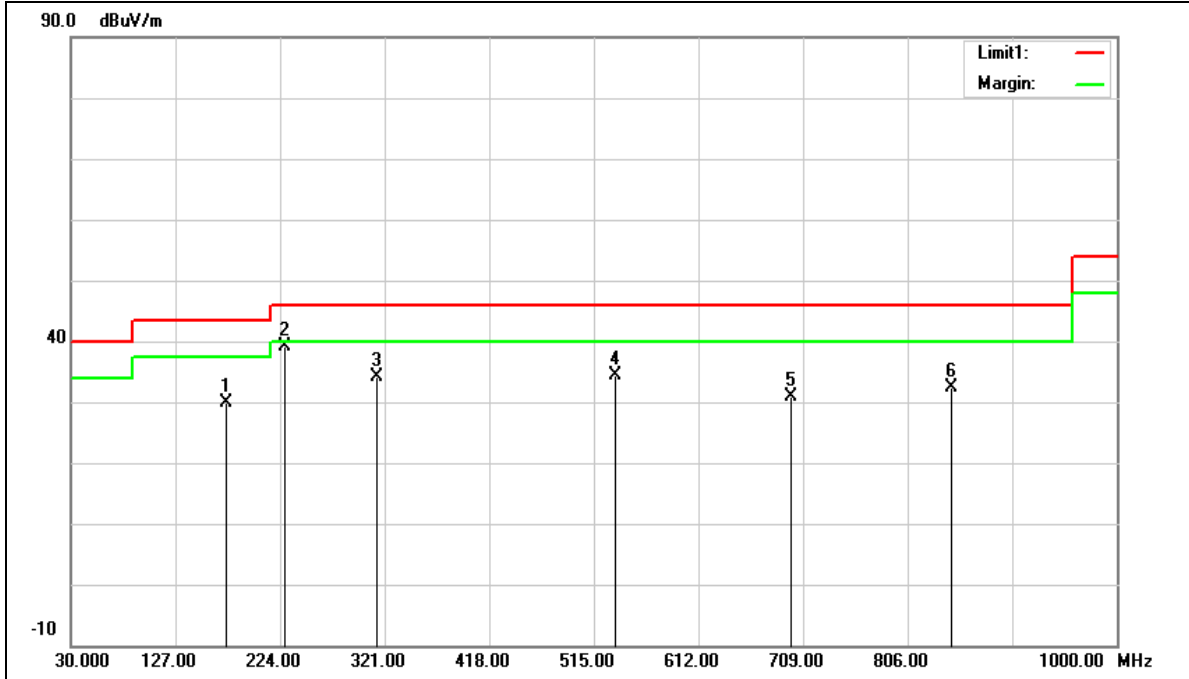

No.	Frequency (MHz)	Reading (dBuV)	Correct Factor (dB/m)	Result (dBuV/m)	Limit (dBuV/m)	Margin (dB)	Remark
1	174.5300	37.14	-7.23	29.91	43.50	-13.59	QP
2	227.8800	47.23	-8.06	39.17	46.00	-6.83	QP
3	313.2400	39.41	-5.24	34.17	46.00	-11.83	QP
4	534.4000	35.52	-1.19	34.33	46.00	-11.67	QP
5	697.3600	28.77	2.18	30.95	46.00	-15.05	QP
6	846.7400	27.75	4.53	32.28	46.00	-13.72	QP

Note:1.Result (dBuV/m) = Correct Factor (dB/m) + Reading(dBuV).

Example: 29.91 = -7.23+37.14.

2.Correction factor (dB/m) = Antenna Factor (dB/m) + Cable loss (dB) – Pre-Amplifier gain (dB).

3.When the peak results are less than average limit, so not need to evaluate the average.

Standard:	FCC Part 15.407	Test Distance:	3 m
Test item:	Radiated Emission		
Mode:	Mode 1		
Ant.Polar.:	Horizontal		

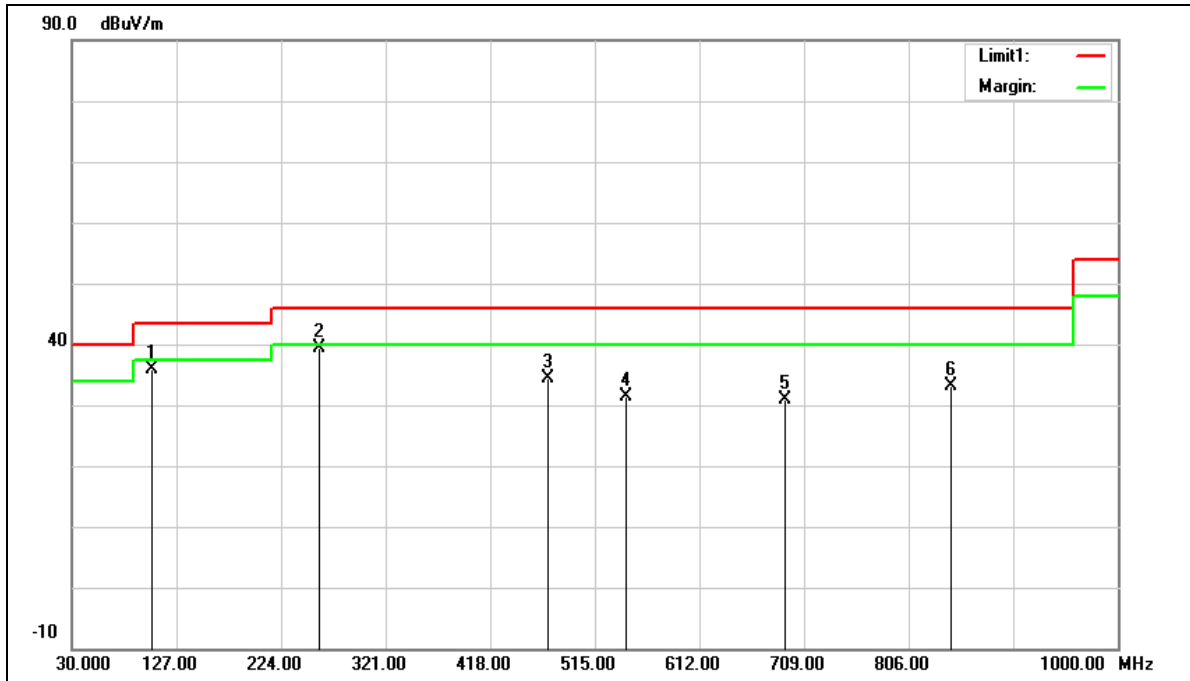

No.	Frequency (MHz)	Reading (dBuV)	Correct Factor (dB/m)	Result (dBuV/m)	Limit (dBuV/m)	Margin (dB)	Remark
1	104.6900	46.97	-11.17	35.80	43.50	-7.70	QP
2	259.8900	46.04	-6.68	39.36	46.00	-6.64	QP
3	471.3500	36.59	-2.27	34.32	46.00	-11.68	QP
4	544.1000	32.33	-1.00	31.33	46.00	-14.67	QP
5	691.5400	28.79	2.05	30.84	46.00	-15.16	QP
6	845.7700	28.62	4.52	33.14	46.00	-12.86	QP

Note: 1. Result (dBuV/m) = Correct Factor (dB/m) + Reading (dBuV).

Example: $35.80 = -11.17 + 46.97$.

2. Correction factor (dB/m) = Antenna Factor (dB/m) + Cable loss (dB) – Pre-Amplifier gain (dB).

3. When the peak results are less than average limit, so not need to evaluate the average.

Peak

Above 1 GHz

Standard:	FCC Part 15.407	Test Distance:	3 m
Test item:	Harmonic		
Frequency:	5180 MHz		
Mode:	Mode 8		
Ant.Polar.:	Horizontal		

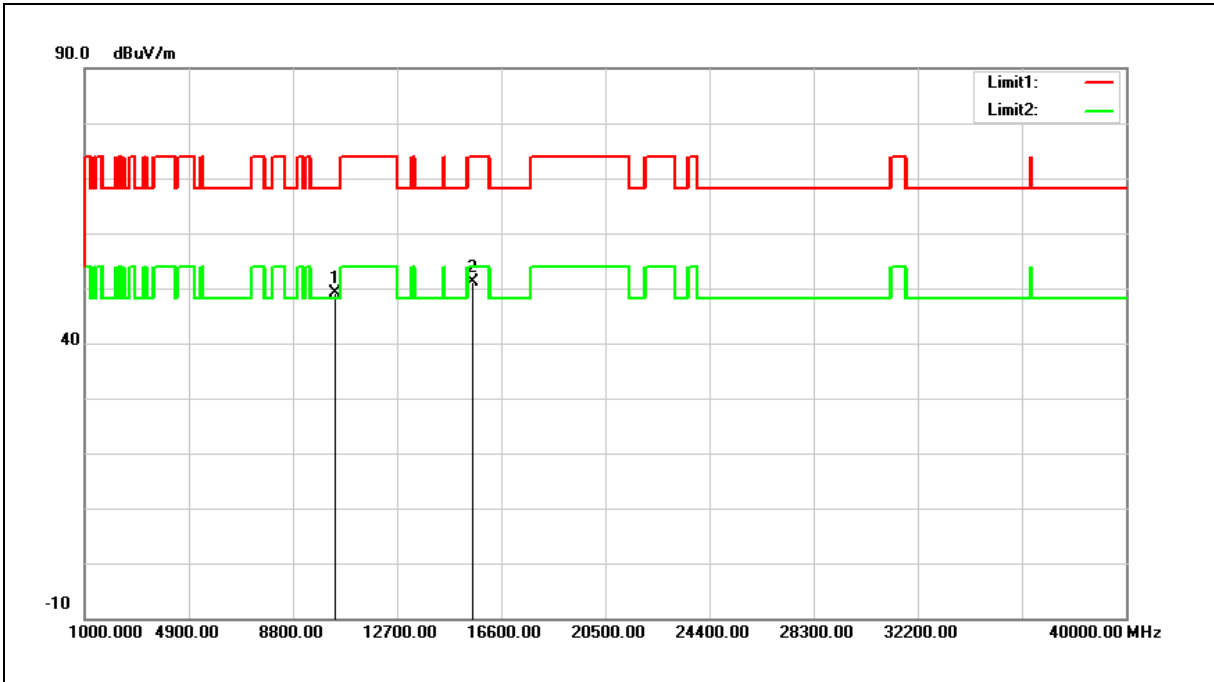

No.	Frequency (MHz)	Reading (dBuV)	Correct Factor (dB/m)	Result (dBuV/m)	Limit (dBuV/m)	Margin (dB)	Remark
1	10360.000	34.80	14.29	49.09	68.20	-19.11	peak
2	15540.000	34.24	16.86	51.10	74.00	-22.90	peak

Note:1.Result (dBuV/m) = Correct Factor (dB/m) + Reading(dBuV).

2.Correction factor (dB/m) = Antenna Factor (dB/m) + Cable loss (dB) – Pre-Amplifier gain (dB).

3.When the peak results are less than average limit, so not need to evaluate the average.

Standard:	FCC Part 15.407	Test Distance:	3 m
Test item:	Harmonic		
Frequency:	5180 MHz		
Mode:	Mode 8		
Ant.Polar.:	Vertical		

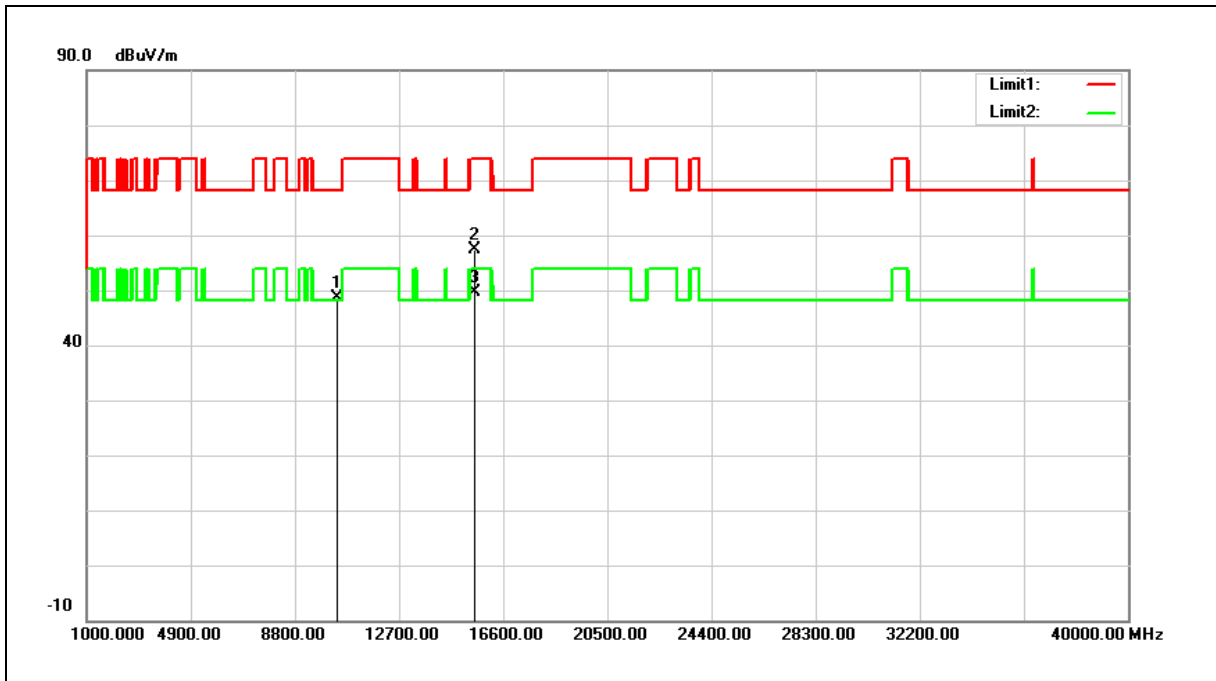

No.	Frequency (MHz)	Reading (dBuV)	Correct Factor (dB/m)	Result (dBuV/m)	Limit (dBuV/m)	Margin (dB)	Remark
1	10360.000	34.41	14.29	48.70	68.20	-19.50	peak
2	15540.000	40.55	16.86	57.41	74.00	-16.59	peak
3	15540.000	32.72	16.86	49.58	54.00	-4.42	AVG

Note:1.Result (dBuV/m) = Correct Factor (dB/m) + Reading(dBuV).

2.Correction factor (dB/m) = Antenna Factor (dB/m) + Cable loss (dB) – Pre-Amplifier gain (dB).

3.When the peak results are less than average limit, so not need to evaluate the average.

Standard:	FCC Part 15.407	Test Distance:	3 m
Test item:	Harmonic		
Frequency:	5200 MHz		
Mode:	Mode 8		
Ant.Polar.:	Horizontal		

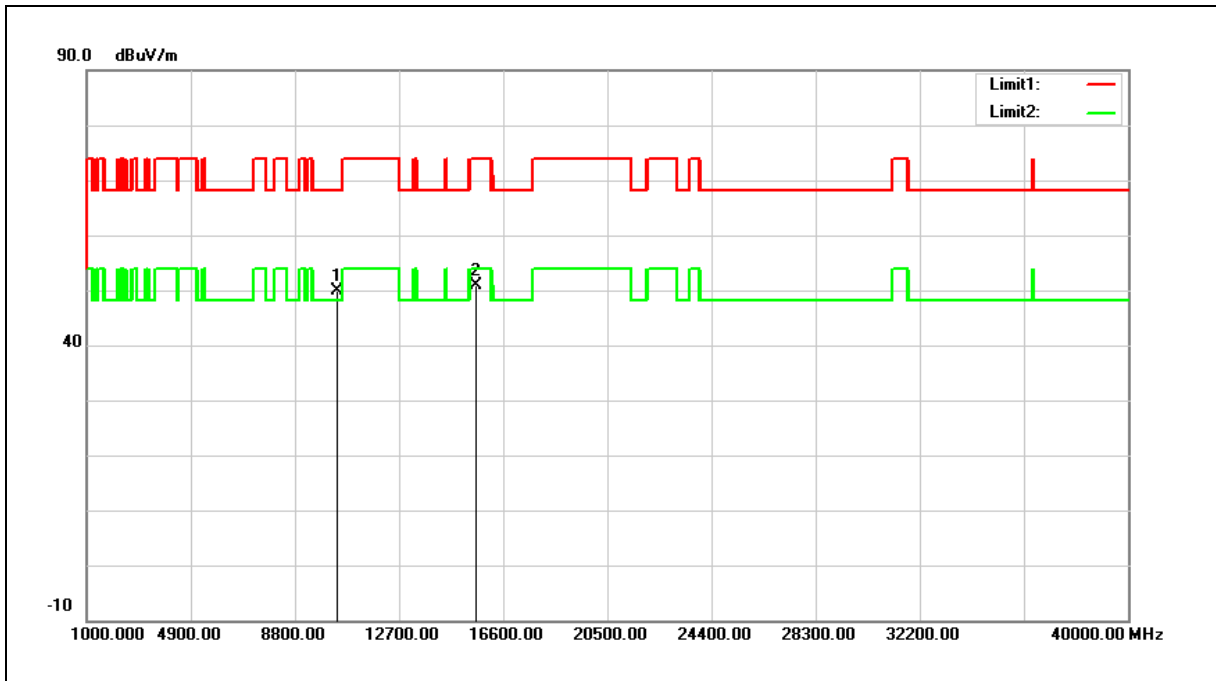

No.	Frequency (MHz)	Reading (dBuV)	Correct Factor (dB/m)	Result (dBuV/m)	Limit (dBuV/m)	Margin (dB)	Remark
1	10400.000	35.52	14.38	49.90	68.20	-18.30	peak
2	15600.000	34.34	16.65	50.99	74.00	-23.01	peak

Note:1.Result (dBuV/m) = Correct Factor (dB/m) + Reading(dBuV).

2.Correction factor (dB/m) = Antenna Factor (dB/m) + Cable loss (dB) – Pre-Amplifier gain (dB).

3.When the peak results are less than average limit, so not need to evaluate the average.

Standard:	FCC Part 15.407	Test Distance:	3 m
Test item:	Harmonic		
Frequency:	5200 MHz		
Mode:	Mode 8		
Ant.Polar.:	Vertical		

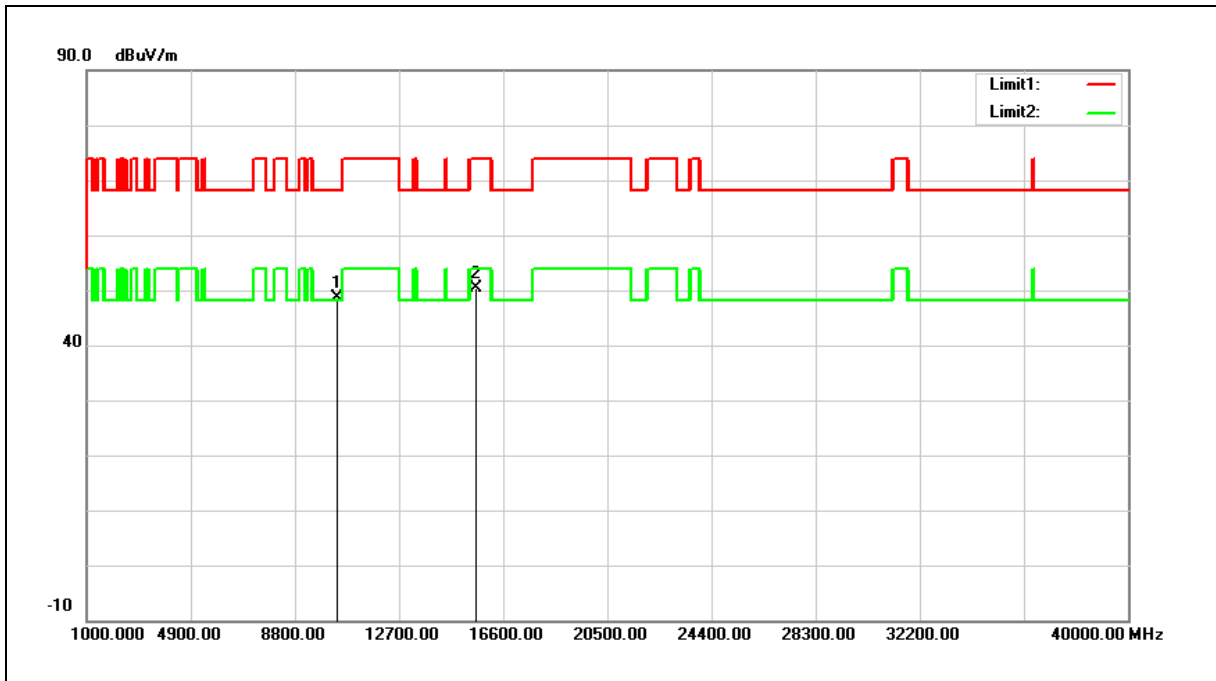

No.	Frequency (MHz)	Reading (dBuV)	Correct Factor (dB/m)	Result (dBuV/m)	Limit (dBuV/m)	Margin (dB)	Remark
1	10400.000	34.25	14.38	48.63	68.20	-19.57	peak
2	15600.000	33.71	16.65	50.36	74.00	-23.64	peak

Note:1.Result (dBuV/m) = Correct Factor (dB/m) + Reading(dBuV).

2.Correction factor (dB/m) = Antenna Factor (dB/m) + Cable loss (dB) – Pre-Amplifier gain (dB).

3.When the peak results are less than average limit, so not need to evaluate the average.

Standard:	FCC Part 15.407	Test Distance:	3 m
Test item:	Harmonic		
Frequency:	5240 MHz		
Mode:	Mode 8		
Ant.Polar.:	Horizontal		

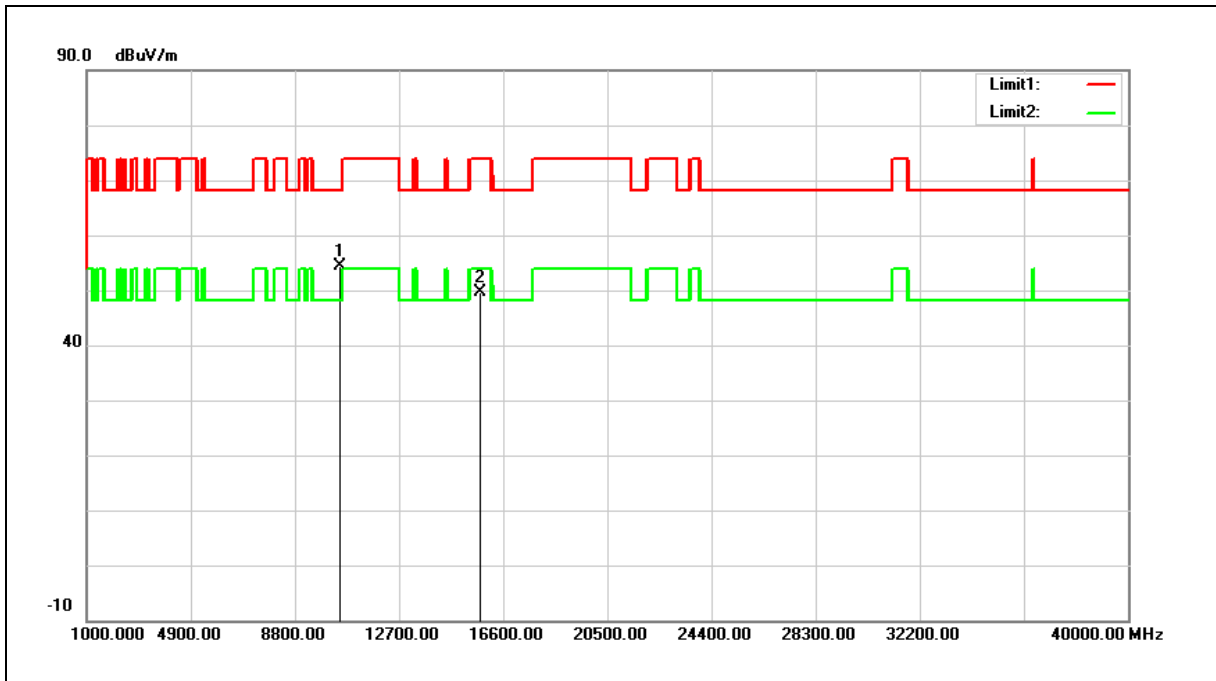

No.	Frequency (MHz)	Reading (dBuV)	Correct Factor (dB/m)	Result (dBuV/m)	Limit (dBuV/m)	Margin (dB)	Remark
1	10480.000	39.78	14.55	54.33	68.20	-13.87	peak
2	15720.000	33.27	16.24	49.51	74.00	-24.49	peak

Note:1.Result (dBuV/m) = Correct Factor (dB/m) + Reading(dBuV).

2.Correction factor (dB/m) = Antenna Factor (dB/m) + Cable loss (dB) – Pre-Amplifier gain (dB).

3.When the peak results are less than average limit, so not need to evaluate the average.

Standard:	FCC Part 15.407	Test Distance:	3 m
Test item:	Harmonic		
Frequency:	5240 MHz		
Mode:	Mode 8		
Ant.Polar.:	Vertical		

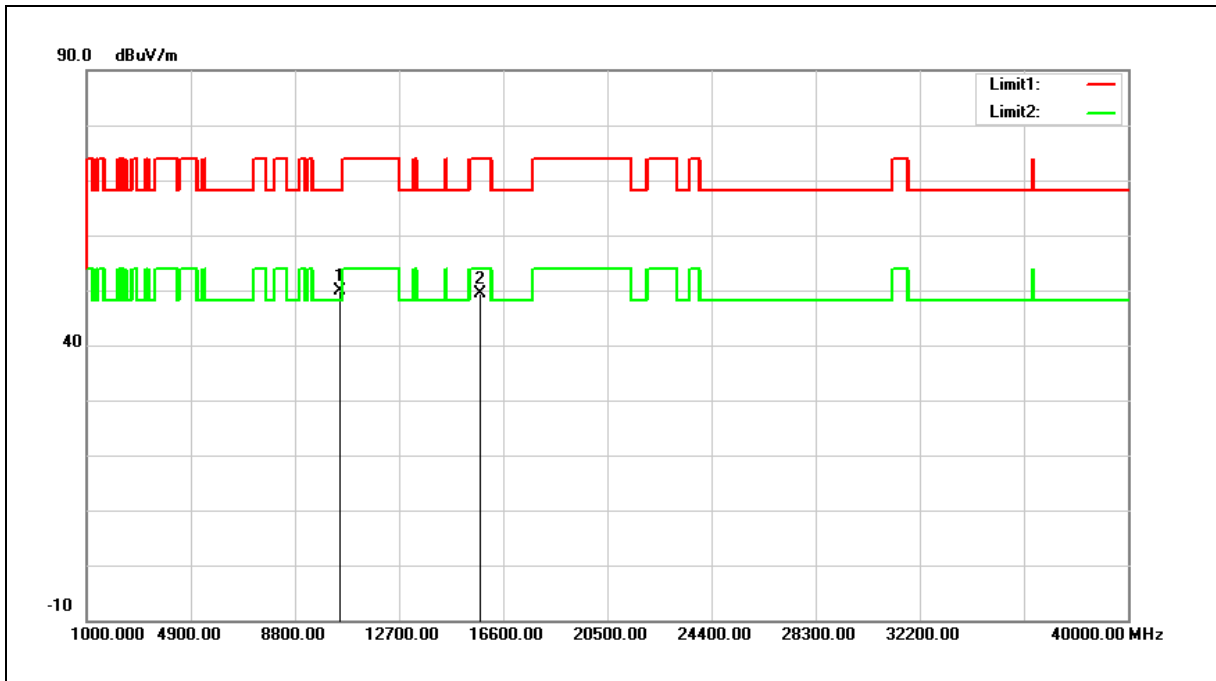

No.	Frequency (MHz)	Reading (dBuV)	Correct Factor (dB/m)	Result (dBuV/m)	Limit (dBuV/m)	Margin (dB)	Remark
1	10480.000	35.25	14.55	49.80	68.20	-18.40	peak
2	15720.000	33.20	16.24	49.44	74.00	-24.56	peak

Note:1.Result (dBuV/m) = Correct Factor (dB/m) + Reading(dBuV).

2.Correction factor (dB/m) = Antenna Factor (dB/m) + Cable loss (dB) – Pre-Amplifier gain (dB).

3.When the peak results are less than average limit, so not need to evaluate the average.

Standard:	FCC Part 15.407	Test Distance:	3 m
Test item:	Harmonic		
Frequency:	5260 MHz		
Mode:	Mode 8		
Ant.Polar.:	Horizontal		

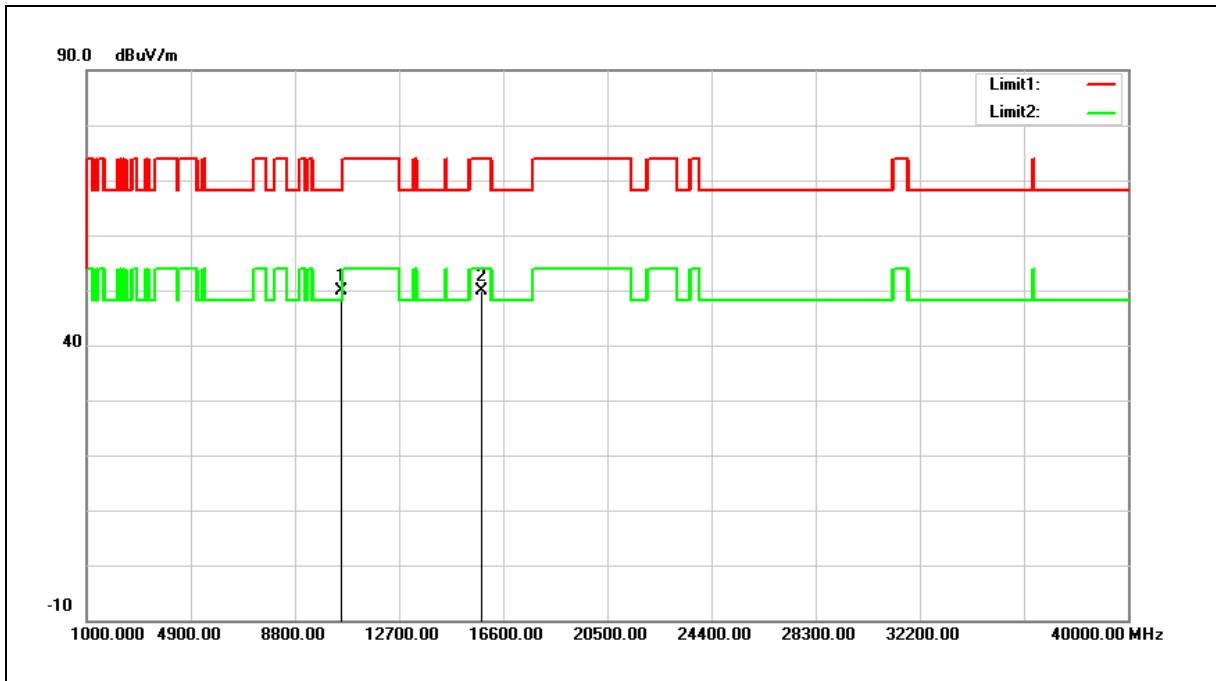

No.	Frequency (MHz)	Reading (dBuV)	Correct Factor (dB/m)	Result (dBuV/m)	Limit (dBuV/m)	Margin (dB)	Remark
1	10520.000	35.22	14.59	49.81	68.20	-18.39	peak
2	15780.000	33.86	16.06	49.92	74.00	-24.08	peak

Note:1.Result (dBuV/m) = Correct Factor (dB/m) + Reading(dBuV).

2.Correction factor (dB/m) = Antenna Factor (dB/m) + Cable loss (dB) – Pre-Amplifier gain (dB).

3.When the peak results are less than average limit, so not need to evaluate the average.

Standard:	FCC Part 15.407	Test Distance:	3 m
Test item:	Harmonic		
Frequency:	5260 MHz		
Mode:	Mode 8		
Ant.Polar.:	Vertical		

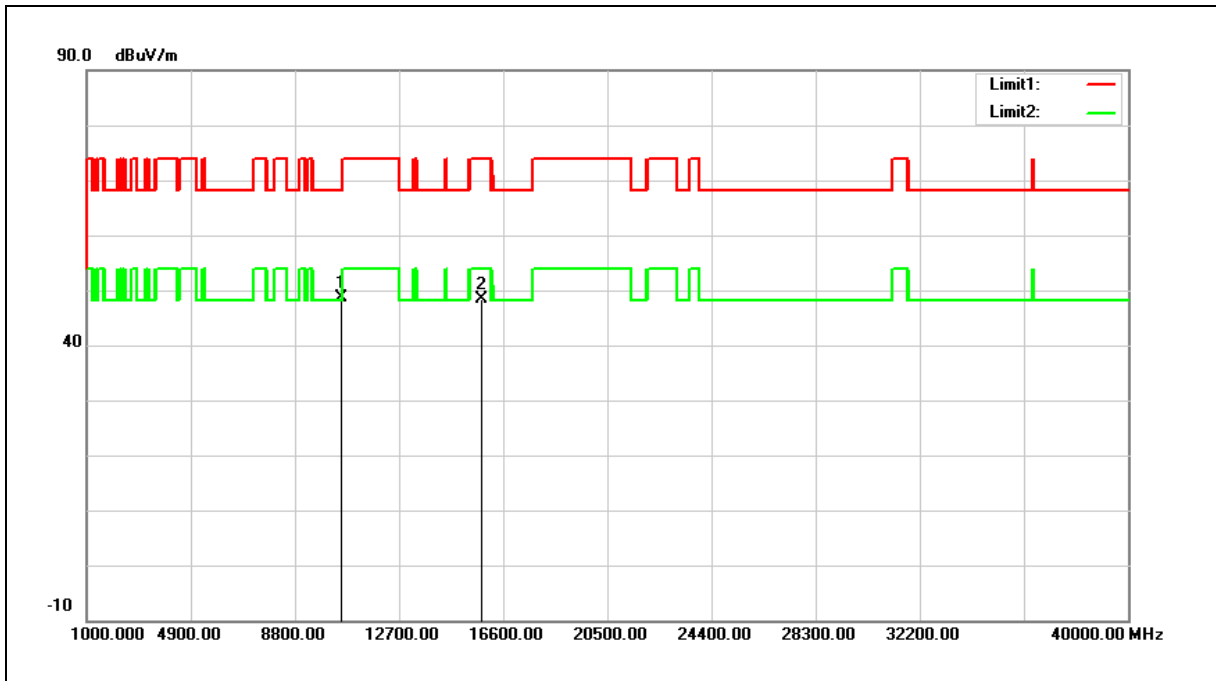

No.	Frequency (MHz)	Reading (dBuV)	Correct Factor (dB/m)	Result (dBuV/m)	Limit (dBuV/m)	Margin (dB)	Remark
1	10520.000	34.02	14.59	48.61	68.20	-19.59	peak
2	15780.000	32.34	16.06	48.40	74.00	-25.60	peak

Note:1.Result (dBuV/m) = Correct Factor (dB/m) + Reading(dBuV).

2.Correction factor (dB/m) = Antenna Factor (dB/m) + Cable loss (dB) – Pre-Amplifier gain (dB).

3.When the peak results are less than average limit, so not need to evaluate the average.

Standard:	FCC Part 15.407	Test Distance:	3 m
Test item:	Harmonic		
Frequency:	5280 MHz		
Mode:	Mode 8		
Ant.Polar.:	Horizontal		

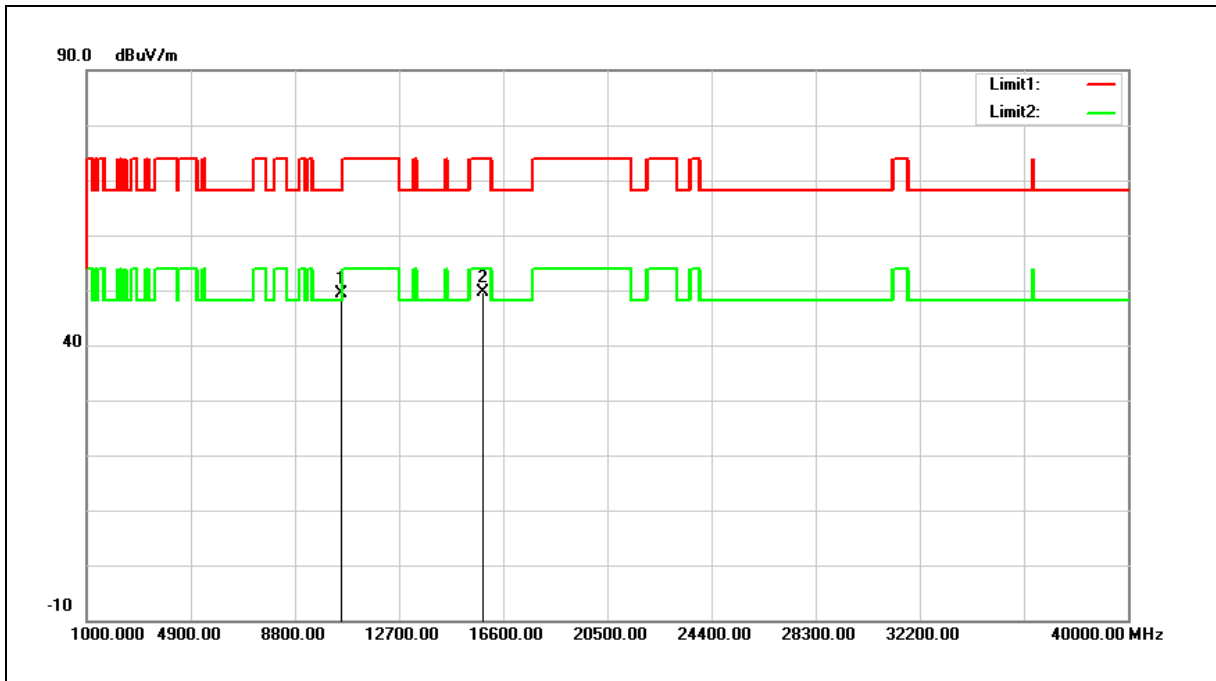

No.	Frequency (MHz)	Reading (dBuV)	Correct Factor (dB/m)	Result (dBuV/m)	Limit (dBuV/m)	Margin (dB)	Remark
1	10560.000	34.83	14.58	49.41	68.20	-18.79	peak
2	15840.000	33.70	15.85	49.55	74.00	-24.45	peak

Note:1.Result (dBuV/m) = Correct Factor (dB/m) + Reading(dBuV).

2.Correction factor (dB/m) = Antenna Factor (dB/m) + Cable loss (dB) – Pre-Amplifier gain (dB).

3.When the peak results are less than average limit, so not need to evaluate the average.

Standard:	FCC Part 15.407	Test Distance:	3 m
Test item:	Harmonic		
Frequency:	5280 MHz		
Mode:	Mode 8		
Ant.Polar.:	Vertical		

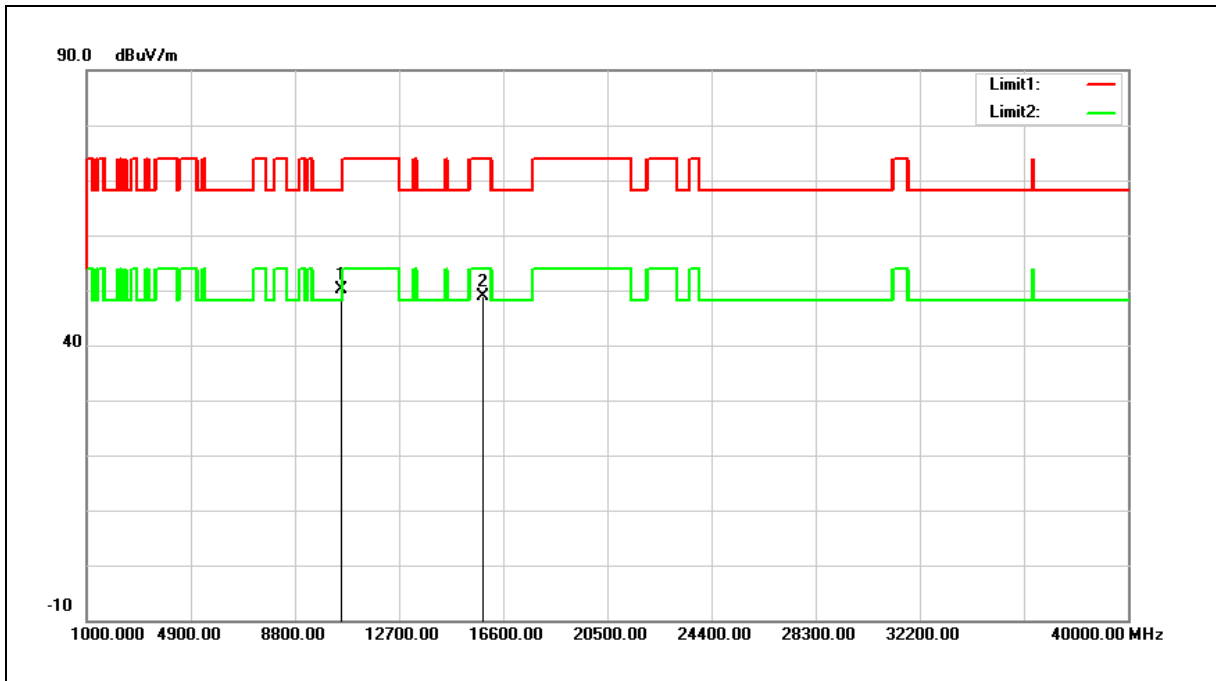

No.	Frequency (MHz)	Reading (dBuV)	Correct Factor (dB/m)	Result (dBuV/m)	Limit (dBuV/m)	Margin (dB)	Remark
1	10560.000	35.55	14.58	50.13	68.20	-18.07	peak
2	15840.000	32.93	15.85	48.78	74.00	-25.22	peak

Note:1.Result (dBuV/m) = Correct Factor (dB/m) + Reading(dBuV).

2.Correction factor (dB/m) = Antenna Factor (dB/m) + Cable loss (dB) – Pre-Amplifier gain (dB).

3.When the peak results are less than average limit, so not need to evaluate the average.

Standard:	FCC Part 15.407	Test Distance:	3 m
Test item:	Harmonic		
Frequency:	5320 MHz		
Mode:	Mode 8		
Ant.Polar.:	Horizontal		

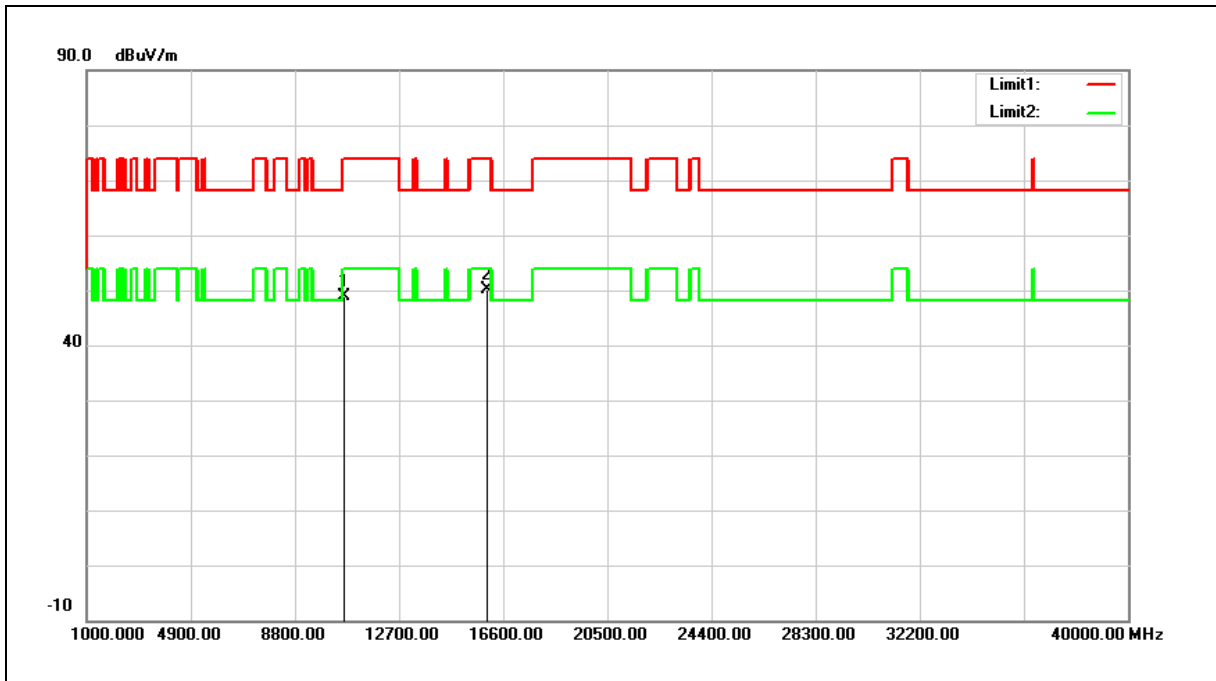

No.	Frequency (MHz)	Reading (dBuV)	Correct Factor (dB/m)	Result (dBuV/m)	Limit (dBuV/m)	Margin (dB)	Remark
1	10640.000	34.42	14.56	48.98	74.00	-25.02	peak
2	15960.000	34.75	15.44	50.19	74.00	-23.81	peak

Note:1.Result (dBuV/m) = Correct Factor (dB/m) + Reading(dBuV).

2.Correction factor (dB/m) = Antenna Factor (dB/m) + Cable loss (dB) – Pre-Amplifier gain (dB).

3.When the peak results are less than average limit, so not need to evaluate the average.

Standard:	FCC Part 15.407	Test Distance:	3 m
Test item:	Harmonic		
Frequency:	5320 MHz		
Mode:	Mode 8		
Ant.Polar.:	Vertical		

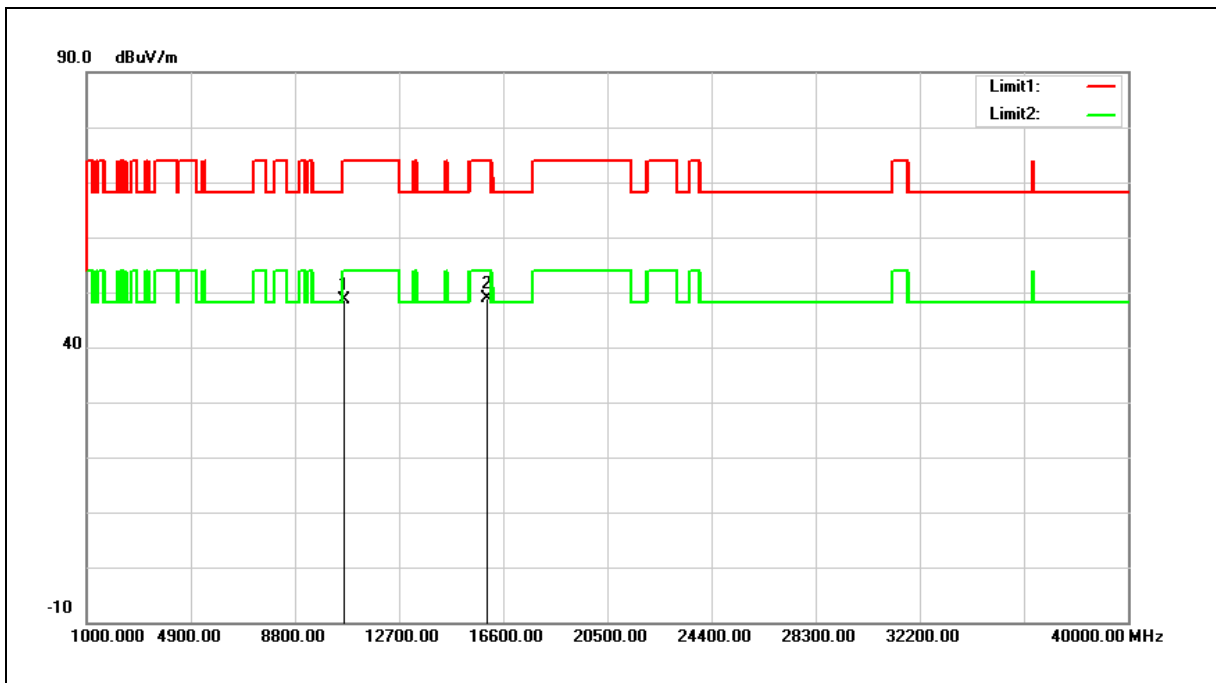

No.	Frequency (MHz)	Reading (dBuV)	Correct Factor (dB/m)	Result (dBuV/m)	Limit (dBuV/m)	Margin (dB)	Remark
1	10640.000	34.12	14.56	48.68	74.00	-25.32	peak
2	15960.000	33.54	15.44	48.98	74.00	-25.02	peak

Note:1.Result (dBuV/m) = Correct Factor (dB/m) + Reading(dBuV).

2.Correction factor (dB/m) = Antenna Factor (dB/m) + Cable loss (dB) – Pre-Amplifier gain (dB).

3.When the peak results are less than average limit, so not need to evaluate the average.

Standard:	FCC Part 15.407	Test Distance:	3 m
Test item:	Harmonic		
Frequency:	5500 MHz		
Mode:	Mode 8		
Ant.Polar.:	Horizontal		

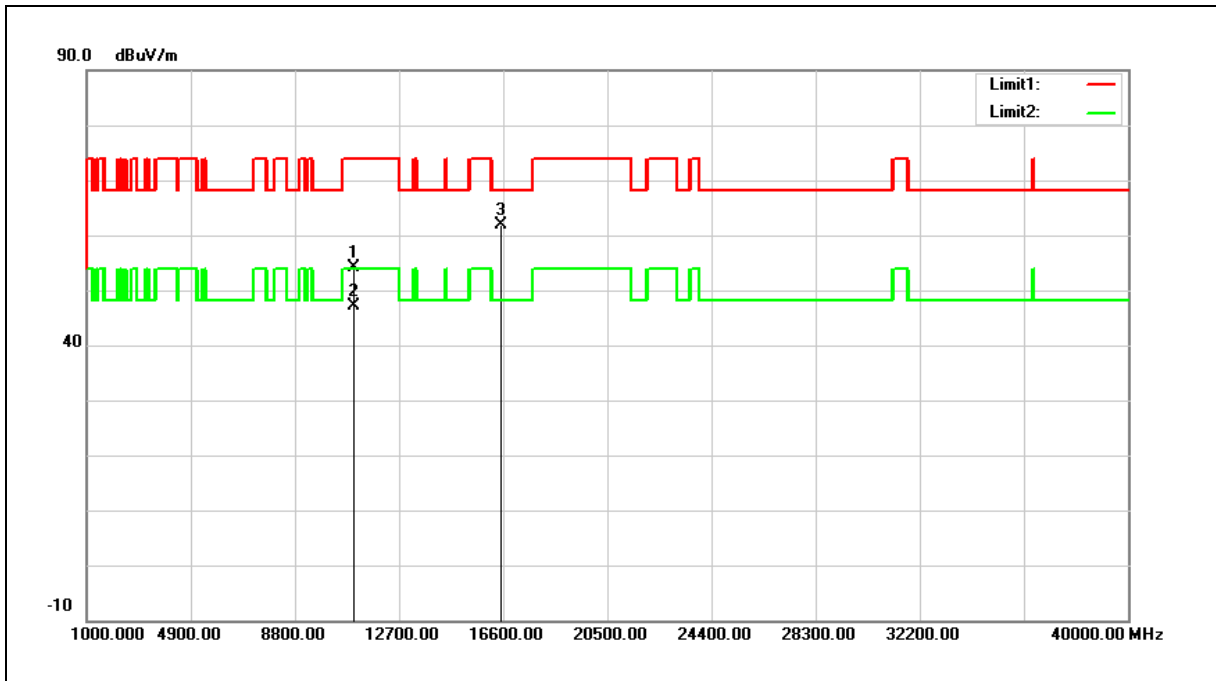

No.	Frequency (MHz)	Reading (dBuV)	Correct Factor (dB/m)	Result (dBuV/m)	Limit (dBuV/m)	Margin (dB)	Remark
1	11000.000	39.59	14.47	54.06	74.00	-19.94	peak
2	11000.000	32.55	14.47	47.02	54.00	-6.98	AVG
3	16500.000	45.28	16.63	61.91	68.20	-6.29	peak

Note:1.Result (dBuV/m) = Correct Factor (dB/m) + Reading(dBuV).

2.Correction factor (dB/m) = Antenna Factor (dB/m) + Cable loss (dB) – Pre-Amplifier gain (dB).

3.When the peak results are less than average limit, so not need to evaluate the average.

Standard:	FCC Part 15.407	Test Distance:	3 m
Test item:	Harmonic		
Frequency:	5500 MHz		
Mode:	Mode 8		
Ant.Polar.:	Vertical		

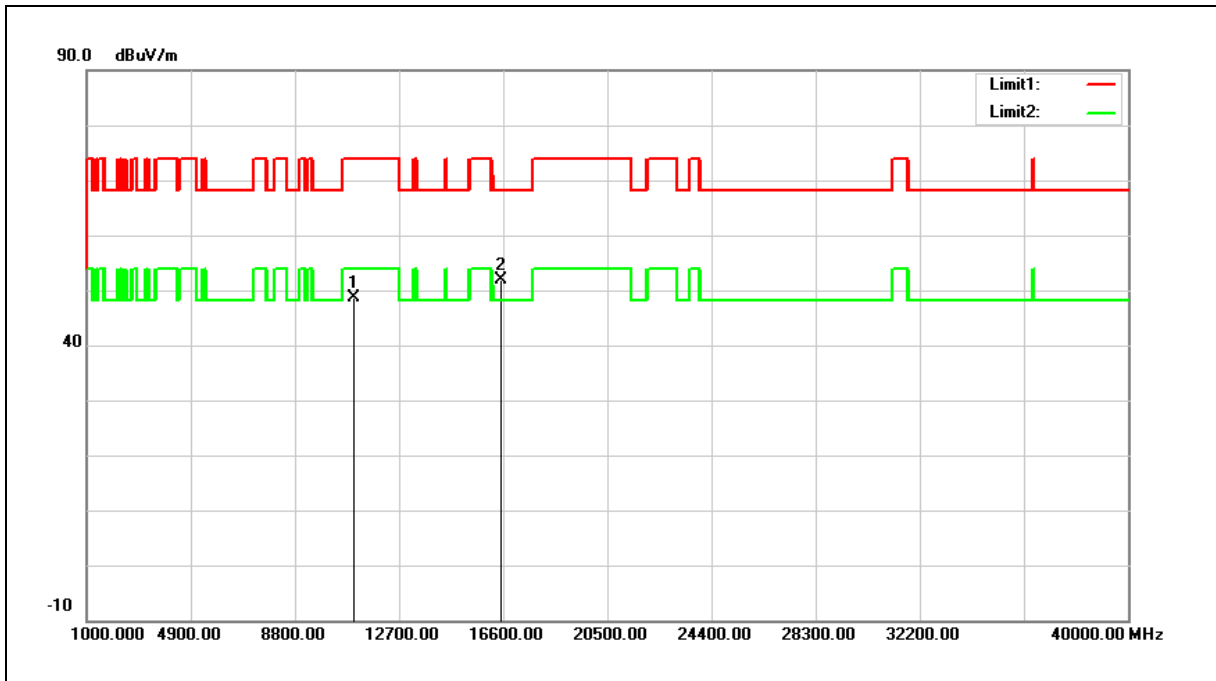

No.	Frequency (MHz)	Reading (dBuV)	Correct Factor (dB/m)	Result (dBuV/m)	Limit (dBuV/m)	Margin (dB)	Remark
1	11000.000	34.18	14.47	48.65	74.00	-25.35	peak
2	16500.000	35.20	16.63	51.83	68.20	-16.37	peak

Note:1.Result (dBuV/m) = Correct Factor (dB/m) + Reading(dBuV).

2.Correction factor (dB/m) = Antenna Factor (dB/m) + Cable loss (dB) – Pre-Amplifier gain (dB).

3.When the peak results are less than average limit, so not need to evaluate the average.

Standard:	FCC Part 15.407	Test Distance:	3 m
Test item:	Harmonic		
Frequency:	5560 MHz		
Mode:	Mode 8		
Ant.Polar.:	Horizontal		

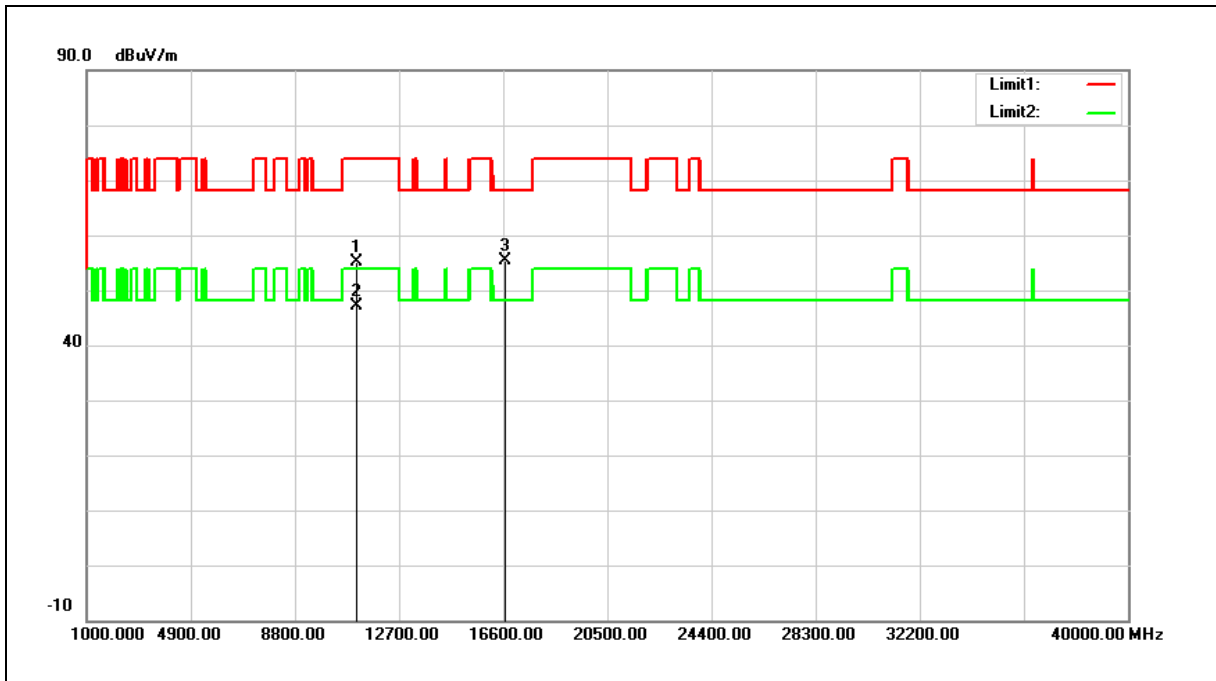

No.	Frequency (MHz)	Reading (dBuV)	Correct Factor (dB/m)	Result (dBuV/m)	Limit (dBuV/m)	Margin (dB)	Remark
1	11120.000	40.52	14.70	55.22	74.00	-18.78	peak
2	11120.000	32.53	14.70	47.23	54.00	-6.77	AVG
3	16680.000	37.53	17.95	55.48	68.20	-12.72	peak

Note:1.Result (dBuV/m) = Correct Factor (dB/m) + Reading(dBuV).

2.Correction factor (dB/m) = Antenna Factor (dB/m) + Cable loss (dB) – Pre-Amplifier gain (dB).

3.When the peak results are less than average limit, so not need to evaluate the average.

Standard:	FCC Part 15.407	Test Distance:	3 m
Test item:	Harmonic		
Frequency:	5560 MHz		
Mode:	Mode 8		
Ant.Polar.:	Vertical		

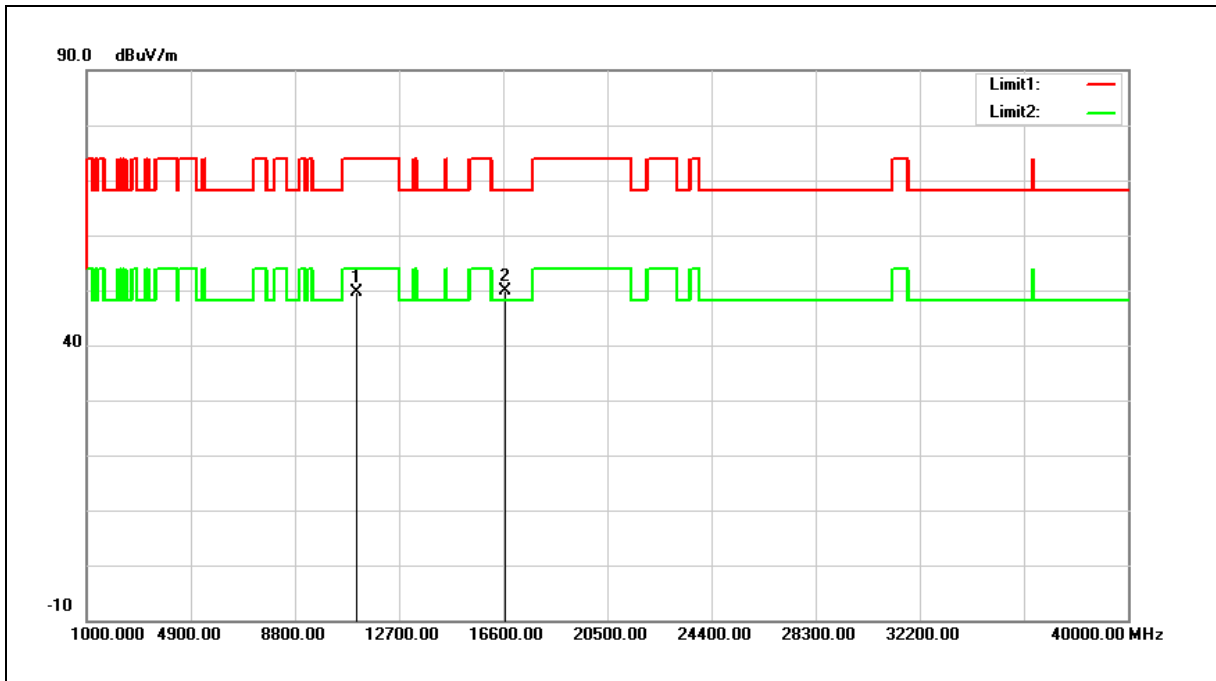

No.	Frequency (MHz)	Reading (dBuV)	Correct Factor (dB/m)	Result (dBuV/m)	Limit (dBuV/m)	Margin (dB)	Remark
1	11120.000	35.04	14.70	49.74	74.00	-24.26	peak
2	16680.000	32.00	17.95	49.95	68.20	-18.25	peak

Note:1.Result (dBuV/m) = Correct Factor (dB/m) + Reading(dBuV).

2.Correction factor (dB/m) = Antenna Factor (dB/m) + Cable loss (dB) – Pre-Amplifier gain (dB).

3.When the peak results are less than average limit, so not need to evaluate the average.

Standard:	FCC Part 15.407	Test Distance:	3 m
Test item:	Harmonic		
Frequency:	5700 MHz		
Mode:	Mode 8		
Ant.Polar.:	Horizontal		

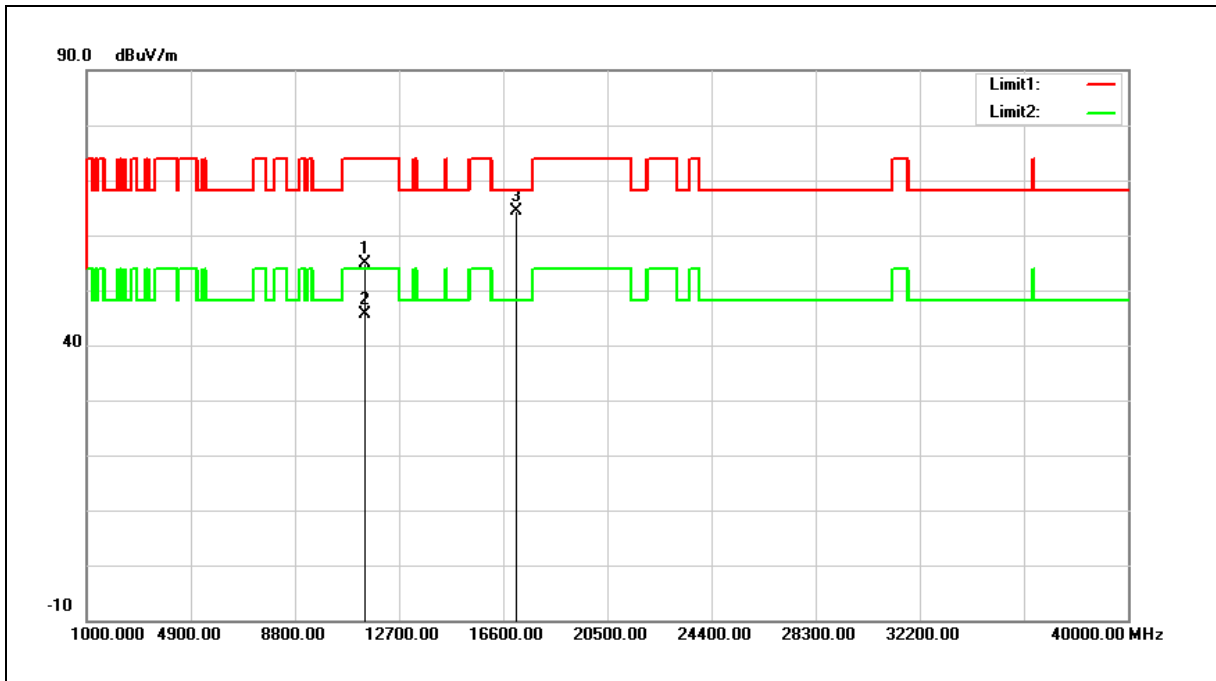

No.	Frequency (MHz)	Reading (dBuV)	Correct Factor (dB/m)	Result (dBuV/m)	Limit (dBuV/m)	Margin (dB)	Remark
1	11400.000	39.76	15.22	54.98	74.00	-19.02	peak
2	11400.000	30.33	15.22	45.55	54.00	-8.45	AVG
3	17100.000	43.42	20.89	64.31	68.20	-3.89	peak

Note:1.Result (dBuV/m) = Correct Factor (dB/m) + Reading(dBuV).

2.Correction factor (dB/m) = Antenna Factor (dB/m) + Cable loss (dB) – Pre-Amplifier gain (dB).

3.When the peak results are less than average limit, so not need to evaluate the average.

Standard:	FCC Part 15.407	Test Distance:	3 m
Test item:	Harmonic		
Frequency:	5700 MHz		
Mode:	Mode 8		
Ant.Polar.:	Vertical		

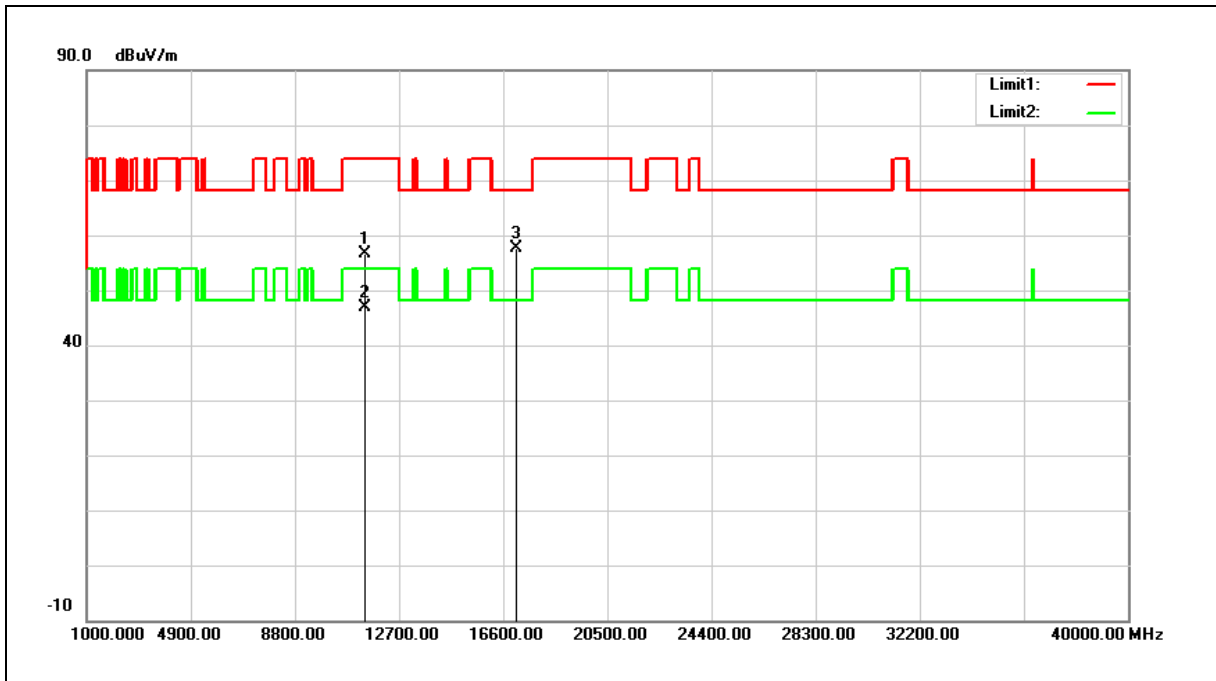

No.	Frequency (MHz)	Reading (dBuV)	Correct Factor (dB/m)	Result (dBuV/m)	Limit (dBuV/m)	Margin (dB)	Remark
1	11400.000	41.43	15.22	56.65	74.00	-17.35	peak
2	11400.000	31.73	15.22	46.95	54.00	-7.05	AVG
3	17100.000	36.70	20.89	57.59	68.20	-10.61	peak

Note:1.Result (dBuV/m) = Correct Factor (dB/m) + Reading(dBuV).

2.Correction factor (dB/m) = Antenna Factor (dB/m) + Cable loss (dB) – Pre-Amplifier gain (dB).

3.When the peak results are less than average limit, so not need to evaluate the average.

Standard:	FCC Part 15.407	Test Distance:	3 m
Test item:	Harmonic		
Frequency:	5745 MHz		
Mode:	Mode 8		
Ant.Polar.:	Horizontal		

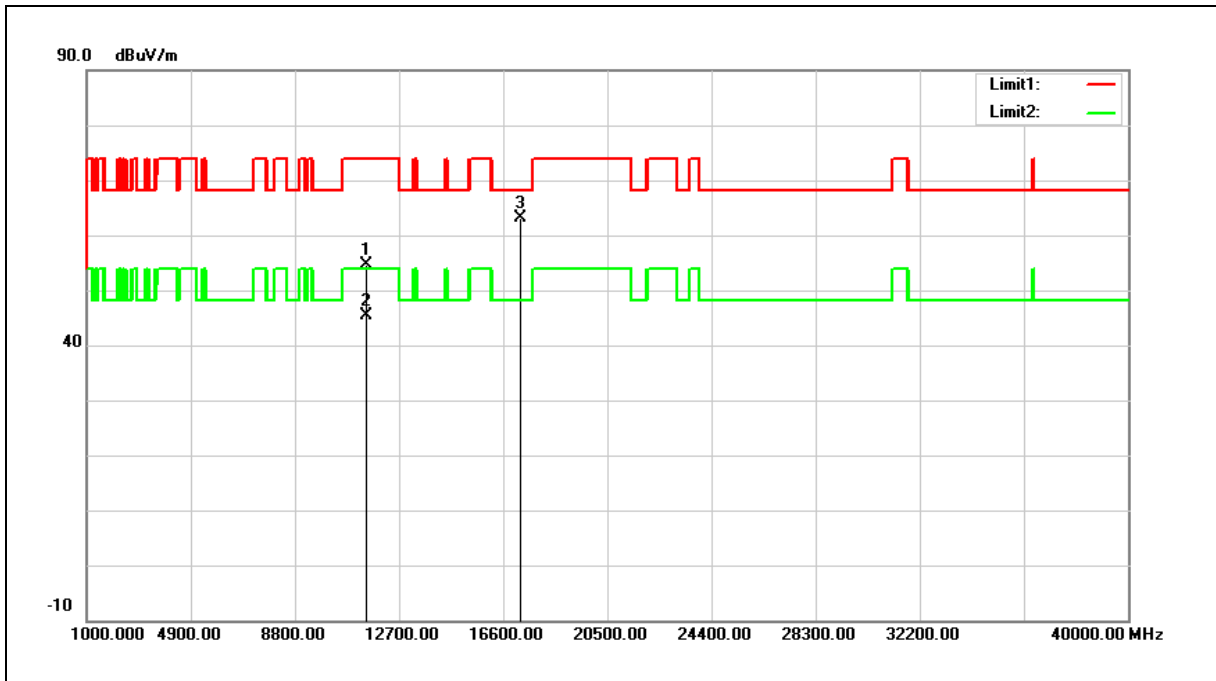

No.	Frequency (MHz)	Reading (dBuV)	Correct Factor (dB/m)	Result (dBuV/m)	Limit (dBuV/m)	Margin (dB)	Remark
1	11490.000	39.25	15.39	54.64	74.00	-19.36	peak
2	11490.000	30.08	15.39	45.47	54.00	-8.53	AVG
3	17235.000	41.37	21.71	63.08	68.20	-5.12	peak

Note:1.Result (dBuV/m) = Correct Factor (dB/m) + Reading(dBuV).

2.Correction factor (dB/m) = Antenna Factor (dB/m) + Cable loss (dB) – Pre-Amplifier gain (dB).

3.When the peak results are less than average limit, so not need to evaluate the average.

Standard:	FCC Part 15.407	Test Distance:	3 m
Test item:	Harmonic		
Frequency:	5745 MHz		
Mode:	Mode 8		
Ant.Polar.:	Vertical		

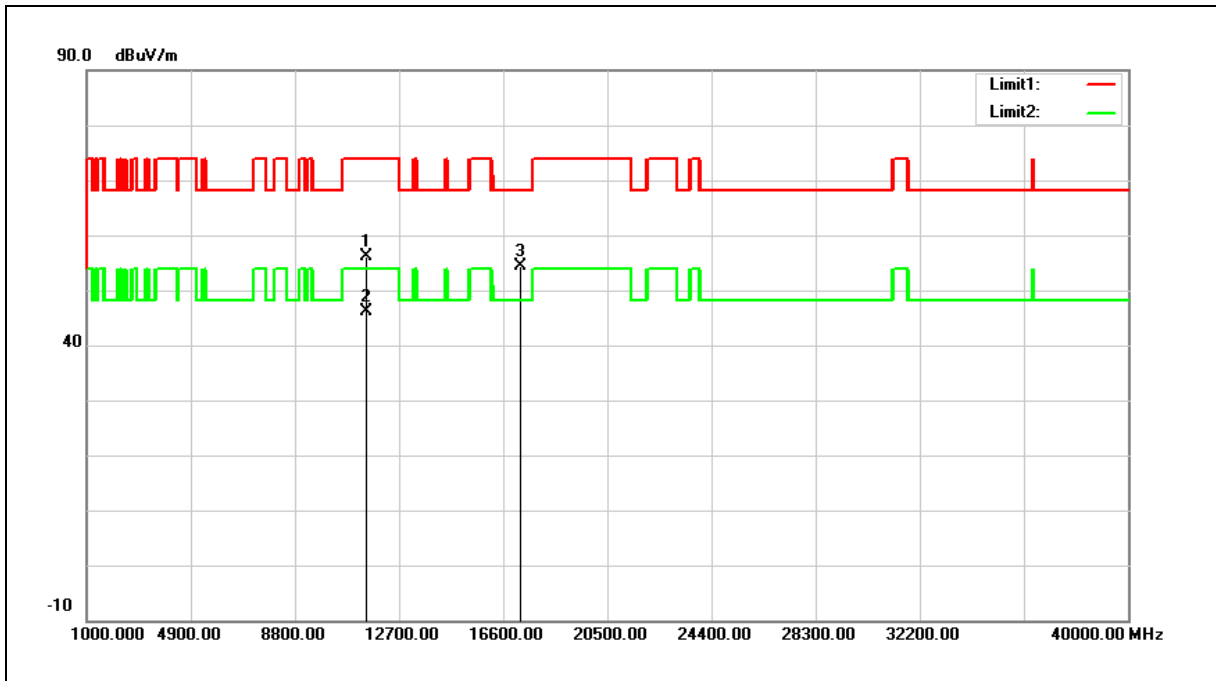

No.	Frequency (MHz)	Reading (dBuV)	Correct Factor (dB/m)	Result (dBuV/m)	Limit (dBuV/m)	Margin (dB)	Remark
1	11490.000	40.76	15.39	56.15	74.00	-17.85	peak
2	11490.000	30.69	15.39	46.08	54.00	-7.92	AVG
3	17235.000	32.63	21.71	54.34	68.20	-13.86	peak

Note:1.Result (dBuV/m) = Correct Factor (dB/m) + Reading(dBuV).

2.Correction factor (dB/m) = Antenna Factor (dB/m) + Cable loss (dB) – Pre-Amplifier gain (dB).

3.When the peak results are less than average limit, so not need to evaluate the average.

Standard:	FCC Part 15.407	Test Distance:	3 m
Test item:	Harmonic		
Frequency:	5785 MHz		
Mode:	Mode 8		
Ant.Polar.:	Horizontal		

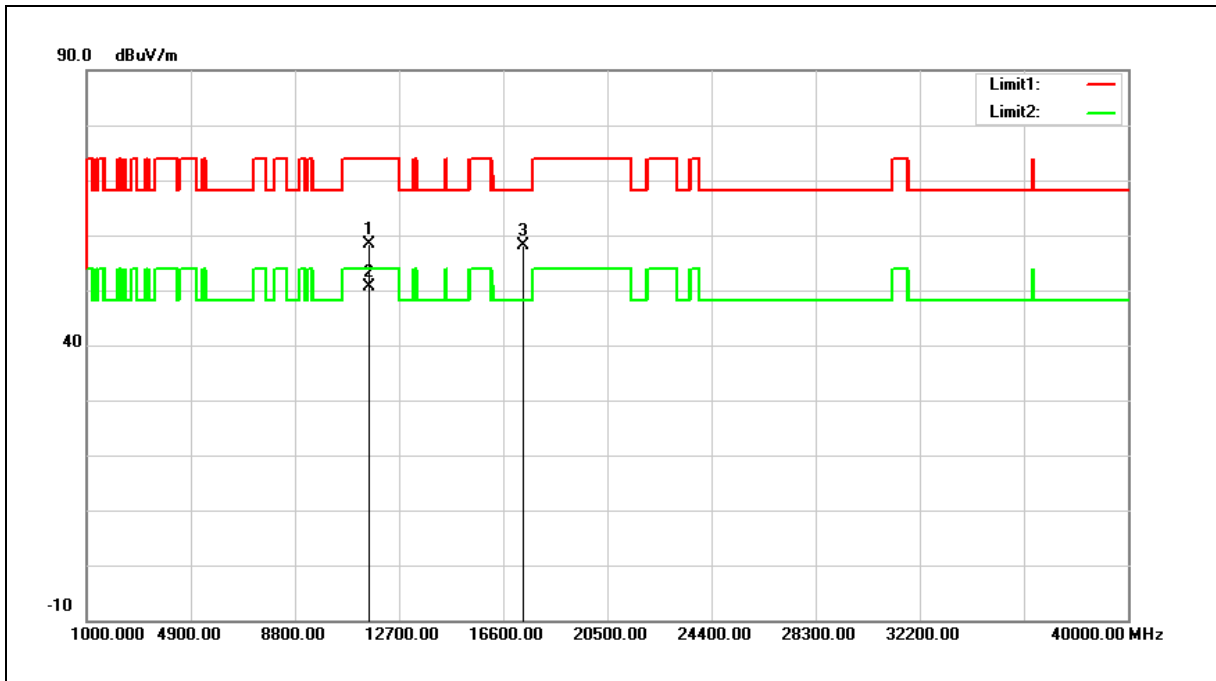

No.	Frequency (MHz)	Reading (dBuV)	Correct Factor (dB/m)	Result (dBuV/m)	Limit (dBuV/m)	Margin (dB)	Remark
1	11570.000	43.09	15.25	58.34	74.00	-15.66	peak
2	11570.000	35.46	15.25	50.71	54.00	-3.29	AVG
3	17355.000	35.66	22.42	58.08	68.20	-10.12	peak

Note:1.Result (dBuV/m) = Correct Factor (dB/m) + Reading(dBuV).

2.Correction factor (dB/m) = Antenna Factor (dB/m) + Cable loss (dB) – Pre-Amplifier gain (dB).

3.When the peak results are less than average limit, so not need to evaluate the average.

Standard:	FCC Part 15.407	Test Distance:	3 m
Test item:	Harmonic		
Frequency:	5785 MHz		
Mode:	Mode 8		
Ant.Polar.:	Vertical		

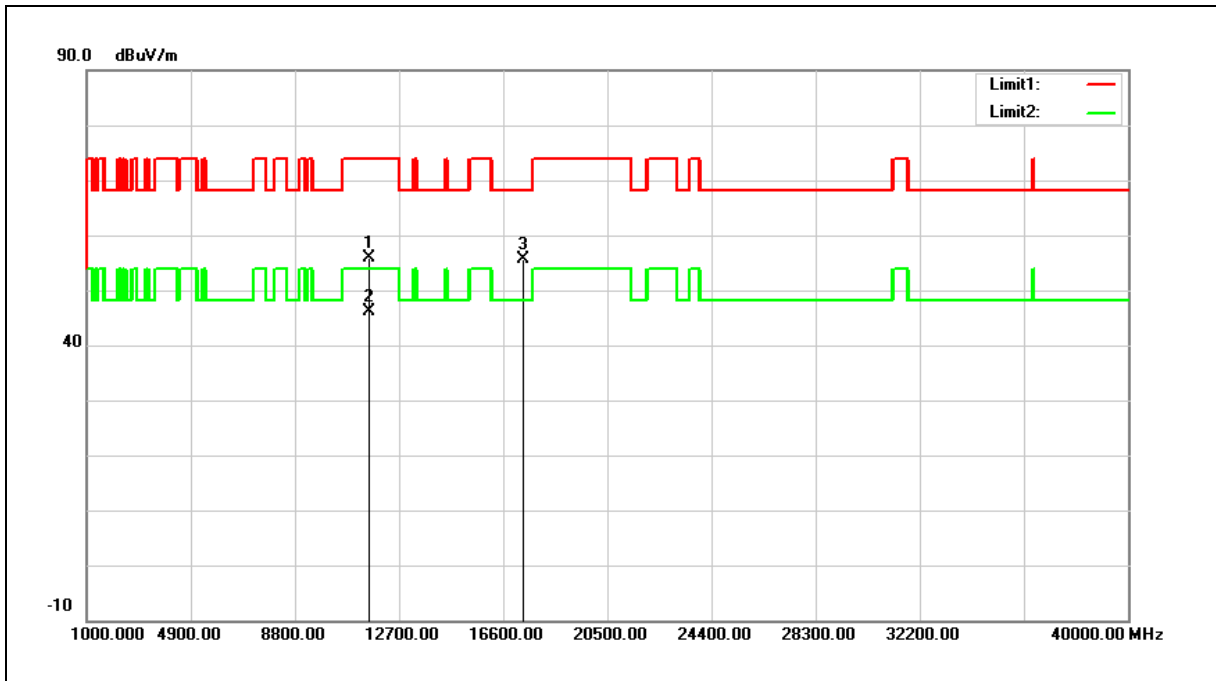

No.	Frequency (MHz)	Reading (dBuV)	Correct Factor (dB/m)	Result (dBuV/m)	Limit (dBuV/m)	Margin (dB)	Remark
1	11570.000	40.61	15.25	55.86	74.00	-18.14	peak
2	11570.000	31.00	15.25	46.25	54.00	-7.75	AVG
3	17355.000	33.20	22.42	55.62	68.20	-12.58	peak

Note:1.Result (dBuV/m) = Correct Factor (dB/m) + Reading(dBuV).

2.Correction factor (dB/m) = Antenna Factor (dB/m) + Cable loss (dB) – Pre-Amplifier gain (dB).

3.When the peak results are less than average limit, so not need to evaluate the average.

Standard:	FCC Part 15.407	Test Distance:	3 m
Test item:	Harmonic		
Frequency:	5825 MHz		
Mode:	Mode 8		
Ant.Polar.:	Horizontal		

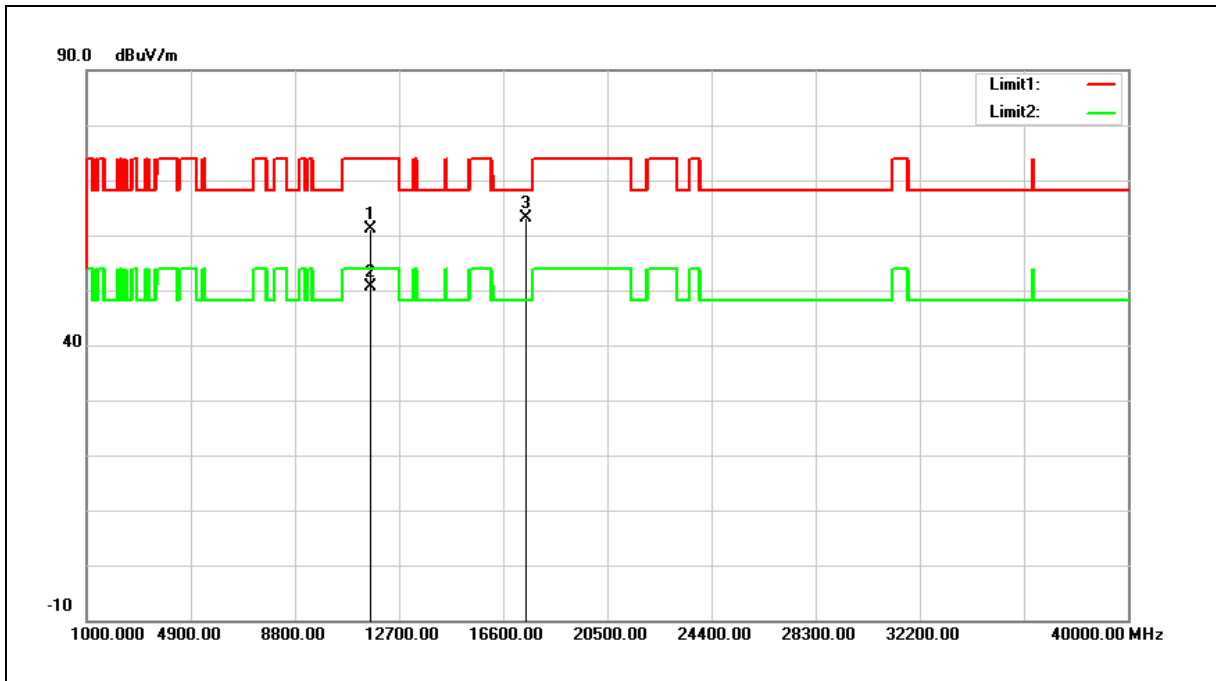

No.	Frequency (MHz)	Reading (dBuV)	Correct Factor (dB/m)	Result (dBuV/m)	Limit (dBuV/m)	Margin (dB)	Remark
1	11650.000	46.02	15.08	61.10	74.00	-12.90	peak
2	11650.000	35.44	15.08	50.52	54.00	-3.48	AVG
3	17475.000	39.97	23.13	63.10	68.20	-5.10	peak

Note:1.Result (dBuV/m) = Correct Factor (dB/m) + Reading(dBuV).

2.Correction factor (dB/m) = Antenna Factor (dB/m) + Cable loss (dB) – Pre-Amplifier gain (dB).

3.When the peak results are less than average limit, so not need to evaluate the average.

Standard:	FCC Part 15.407	Test Distance:	3 m
Test item:	Harmonic		
Frequency:	5825 MHz		
Mode:	Mode 8		
Ant.Polar.:	Vertical		

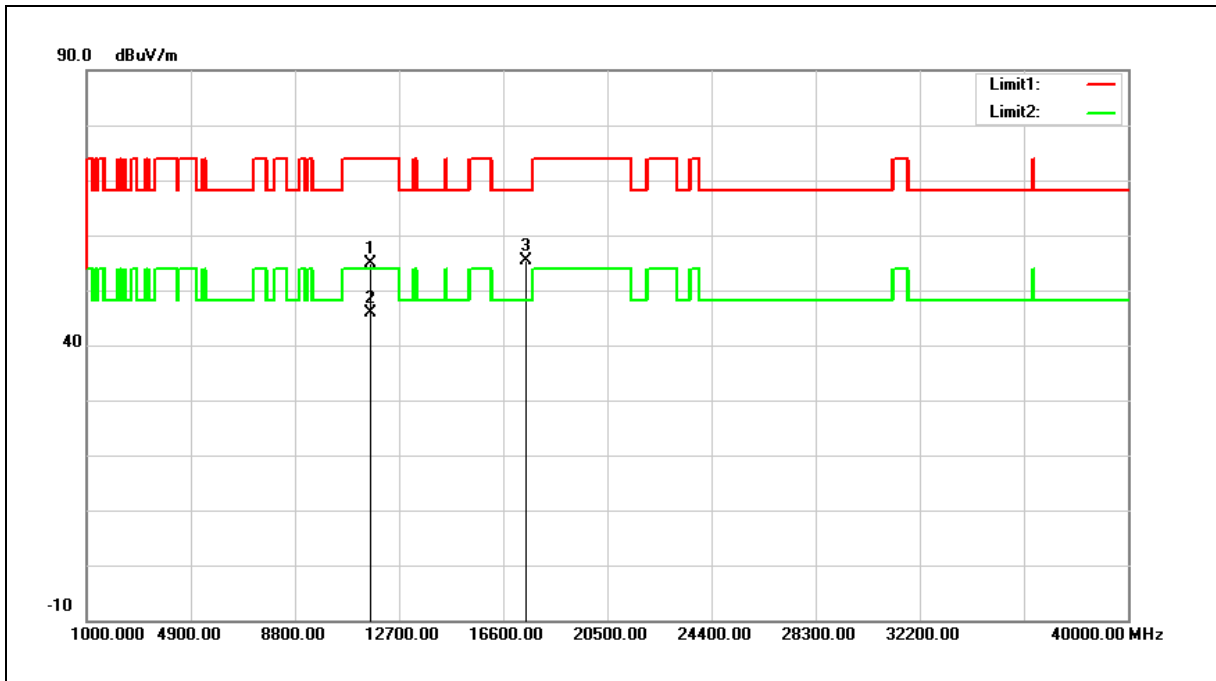

No.	Frequency (MHz)	Reading (dBuV)	Correct Factor (dB/m)	Result (dBuV/m)	Limit (dBuV/m)	Margin (dB)	Remark
1	11650.000	39.77	15.08	54.85	74.00	-19.15	peak
2	11650.000	30.87	15.08	45.95	54.00	-8.05	AVG
3	17475.000	32.31	23.13	55.44	68.20	-12.76	peak

Note:1.Result (dBuV/m) = Correct Factor (dB/m) + Reading(dBuV).

2.Correction factor (dB/m) = Antenna Factor (dB/m) + Cable loss (dB) – Pre-Amplifier gain (dB).

3.When the peak results are less than average limit, so not need to evaluate the average.

Standard:	FCC Part 15.407	Test Distance:	3 m
Test item:	Harmonic		
Frequency:	5190 MHz		
Mode:	Mode 9		
Ant.Polar.:	Horizontal		

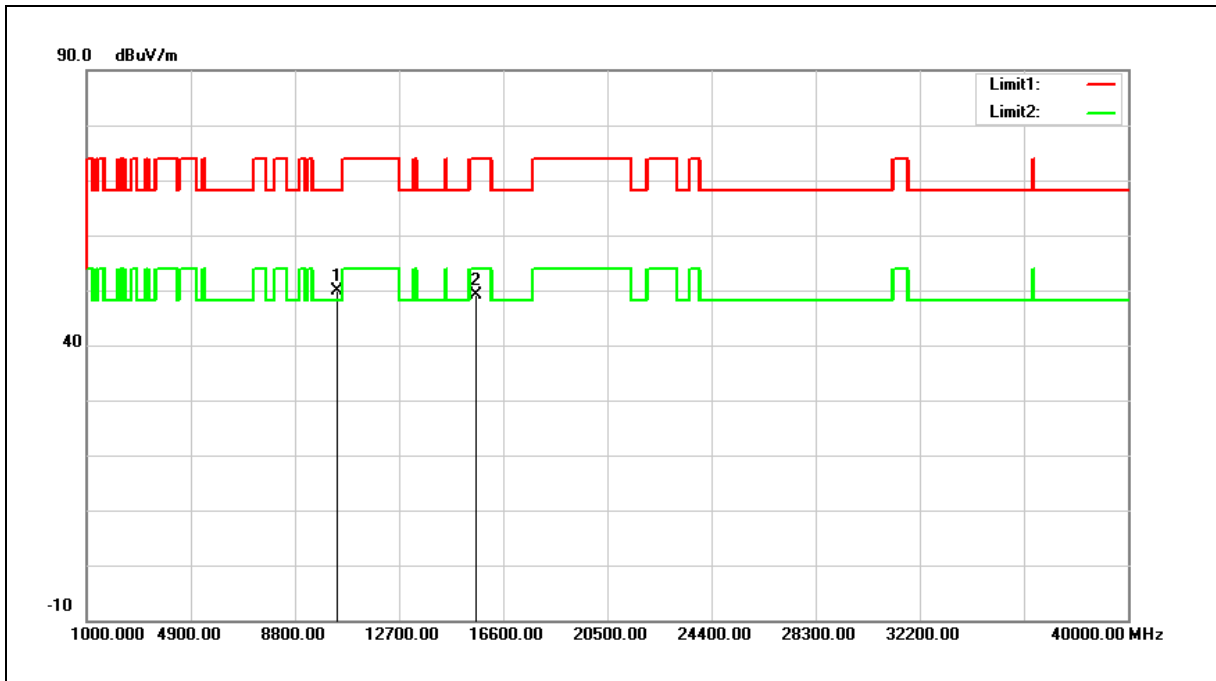

No.	Frequency (MHz)	Reading (dBuV)	Correct Factor (dB/m)	Result (dBuV/m)	Limit (dBuV/m)	Margin (dB)	Remark
1	10380.000	35.42	14.35	49.77	68.20	-18.43	peak
2	15570.000	32.29	16.75	49.04	74.00	-24.96	peak

Note:1.Result (dBuV/m) = Correct Factor (dB/m) + Reading(dBuV).

2.Correction factor (dB/m) = Antenna Factor (dB/m) + Cable loss (dB) – Pre-Amplifier gain (dB).

3.When the peak results are less than average limit, so not need to evaluate the average.

Standard:	FCC Part 15.407	Test Distance:	3 m
Test item:	Harmonic		
Frequency:	5190 MHz		
Mode:	Mode 9		
Ant.Polar.:	Vertical		

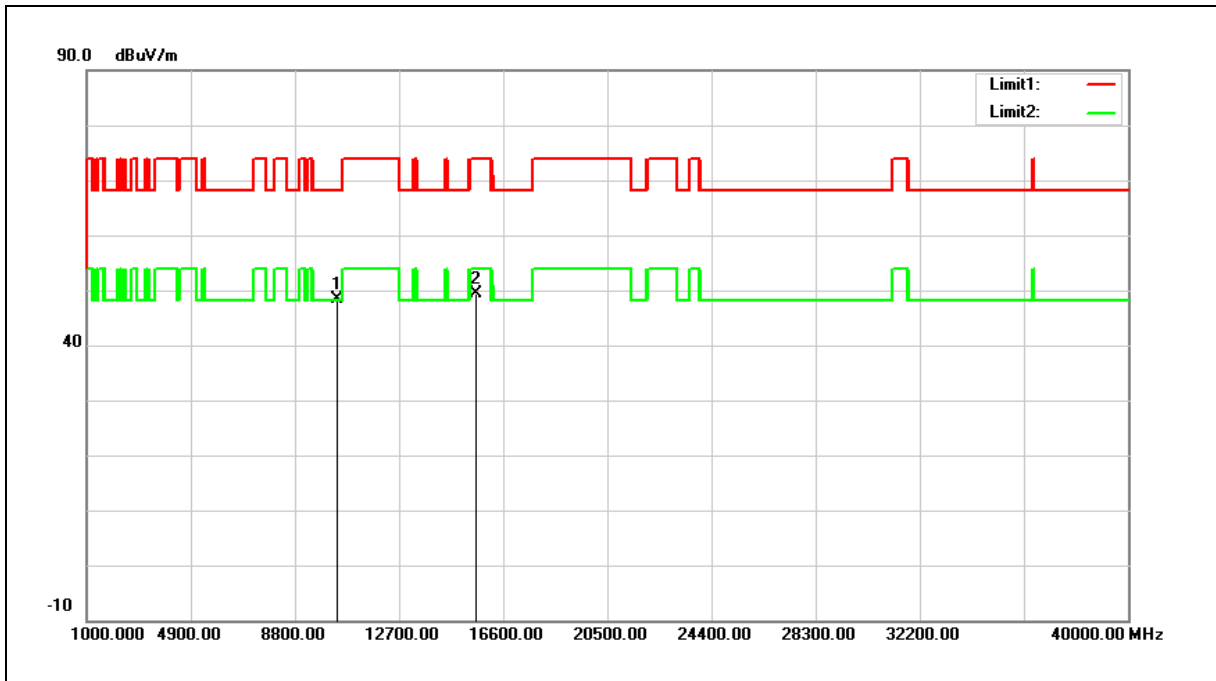

No.	Frequency (MHz)	Reading (dBuV)	Correct Factor (dB/m)	Result (dBuV/m)	Limit (dBuV/m)	Margin (dB)	Remark
1	10380.000	33.98	14.35	48.33	68.20	-19.87	peak
2	15570.000	32.56	16.75	49.31	74.00	-24.69	peak

Note:1.Result (dBuV/m) = Correct Factor (dB/m) + Reading(dBuV).

2.Correction factor (dB/m) = Antenna Factor (dB/m) + Cable loss (dB) – Pre-Amplifier gain (dB).

3.When the peak results are less than average limit, so not need to evaluate the average.

Standard:	FCC Part 15.407	Test Distance:	3 m
Test item:	Harmonic		
Frequency:	5230 MHz		
Mode:	Mode 9		
Ant.Polar.:	Horizontal		

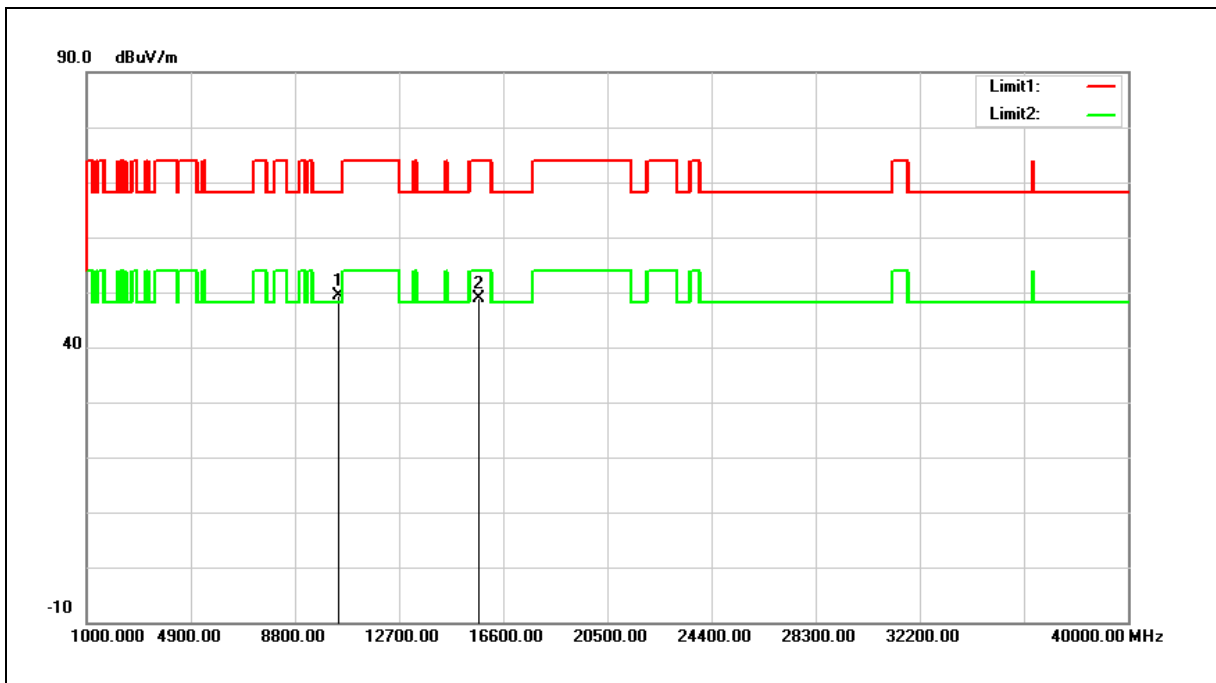

No.	Frequency (MHz)	Reading (dBuV)	Correct Factor (dB/m)	Result (dBuV/m)	Limit (dBuV/m)	Margin (dB)	Remark
1	10460.000	34.86	14.51	49.37	68.20	-18.83	peak
2	15690.000	32.54	16.35	48.89	74.00	-25.11	peak

Note:1.Result (dBuV/m) = Correct Factor (dB/m) + Reading(dBuV).

2.Correction factor (dB/m) = Antenna Factor (dB/m) + Cable loss (dB) – Pre-Amplifier gain (dB).

3.When the peak results are less than average limit, so not need to evaluate the average.

Standard:	FCC Part 15.407	Test Distance:	3 m
Test item:	Harmonic		
Frequency:	5230 MHz		
Mode:	Mode 9		
Ant.Polar.:	Vertical		

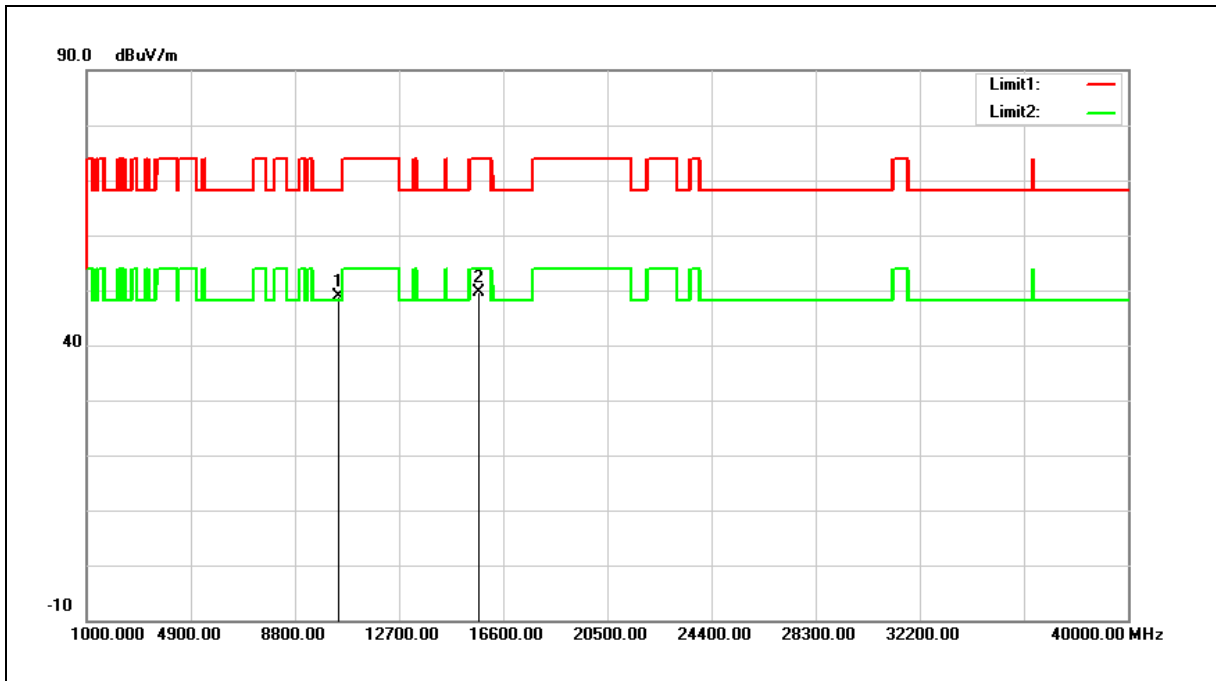

No.	Frequency (MHz)	Reading (dBuV)	Correct Factor (dB/m)	Result (dBuV/m)	Limit (dBuV/m)	Margin (dB)	Remark
1	10460.000	34.35	14.51	48.86	68.20	-19.34	peak
2	15690.000	33.37	16.35	49.72	74.00	-24.28	peak

Note:1.Result (dBuV/m) = Correct Factor (dB/m) + Reading(dBuV).

2.Correction factor (dB/m) = Antenna Factor (dB/m) + Cable loss (dB) – Pre-Amplifier gain (dB).

3.When the peak results are less than average limit, so not need to evaluate the average.

Standard:	FCC Part 15.407	Test Distance:	3 m
Test item:	Harmonic		
Frequency:	5270 MHz		
Mode:	Mode 9		
Ant.Polar.:	Horizontal		

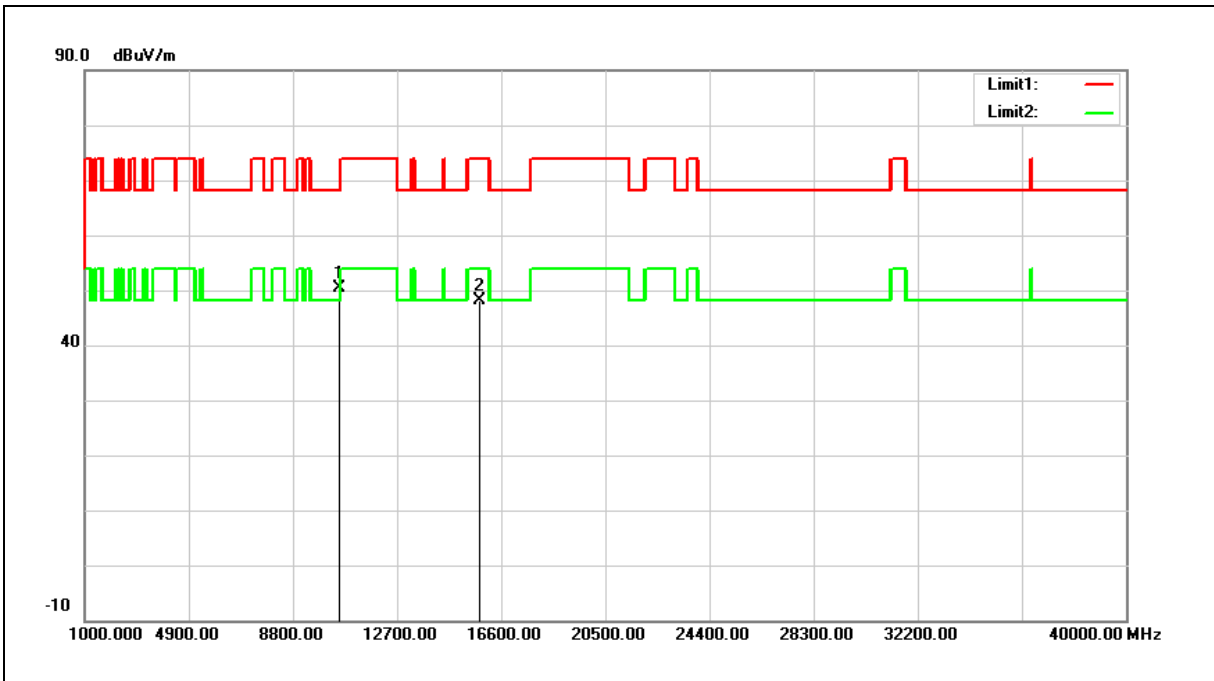

No.	Frequency (MHz)	Reading (dBuV)	Correct Factor (dB/m)	Result (dBuV/m)	Limit (dBuV/m)	Margin (dB)	Remark
1	10540.000	35.90	14.58	50.48	68.20	-17.72	peak
2	15810.000	32.10	15.95	48.05	74.00	-25.95	peak

- Note:1.Result (dBuV/m) = Correct Factor (dB/m) + Reading(dBuV).
 2.Correction factor (dB/m) = Antenna Factor (dB/m) + Cable loss (dB) – Pre-Amplifier gain (dB).
 3.When the peak results are less than average limit, so not need to evaluate the average.

Standard:	FCC Part 15.407	Test Distance:	3 m
Test item:	Harmonic		
Frequency:	5270 MHz		
Mode:	Mode 9		
Ant.Polar.:	Vertical		

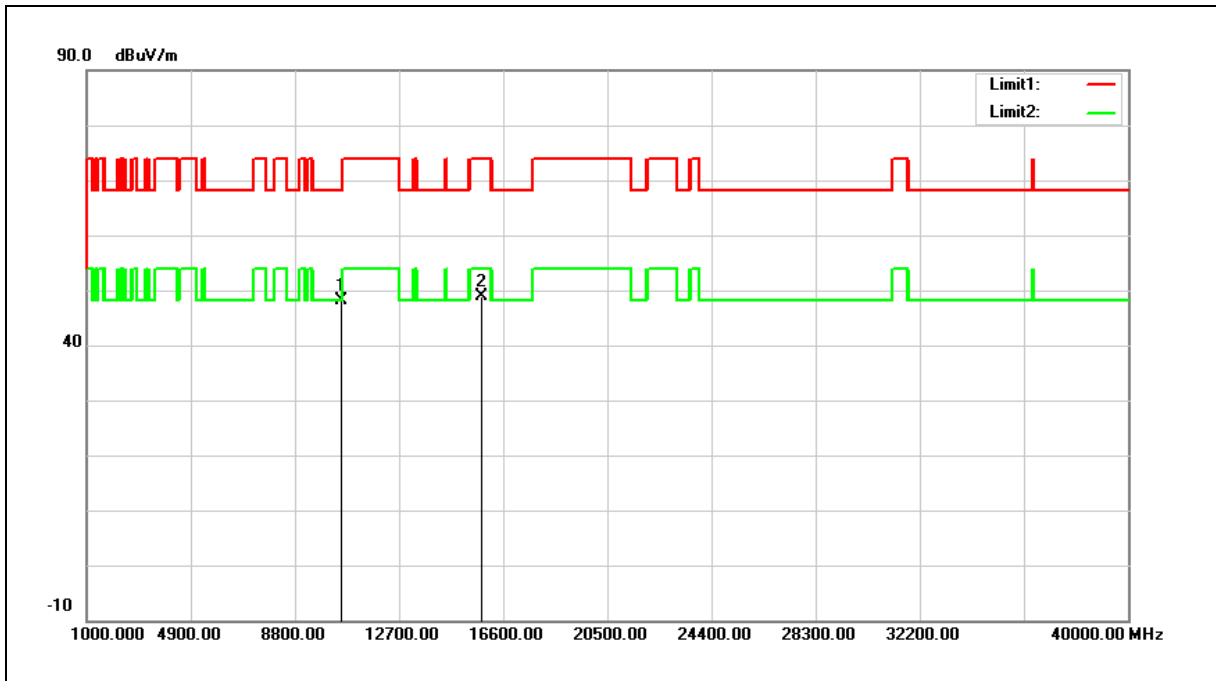

No.	Frequency (MHz)	Reading (dBuV)	Correct Factor (dB/m)	Result (dBuV/m)	Limit (dBuV/m)	Margin (dB)	Remark
1	10540.000	33.58	14.58	48.16	68.20	-20.04	peak
2	15810.000	32.83	15.95	48.78	74.00	-25.22	peak

Note:1.Result (dBuV/m) = Correct Factor (dB/m) + Reading(dBuV).

2.Correction factor (dB/m) = Antenna Factor (dB/m) + Cable loss (dB) – Pre-Amplifier gain (dB).

3.When the peak results are less than average limit, so not need to evaluate the average.

Standard:	FCC Part 15.407	Test Distance:	3 m
Test item:	Harmonic		
Frequency:	5310 MHz		
Mode:	Mode 9		
Ant.Polar.:	Horizontal		

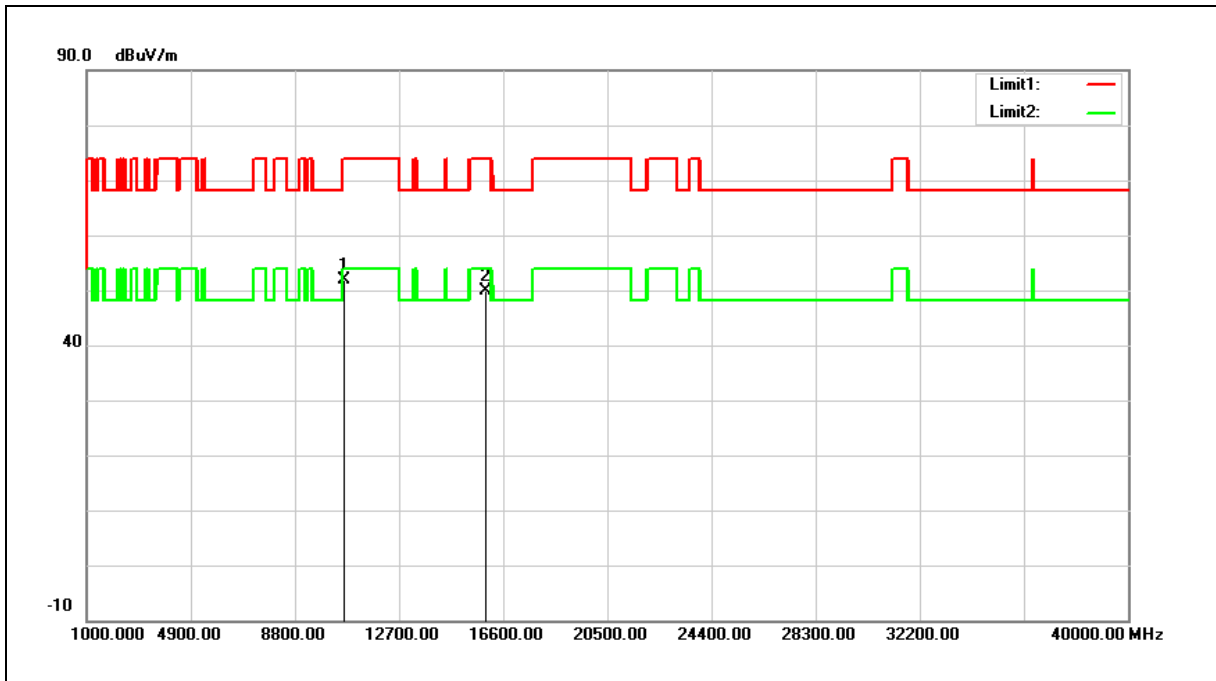

No.	Frequency (MHz)	Reading (dBuV)	Correct Factor (dB/m)	Result (dBuV/m)	Limit (dBuV/m)	Margin (dB)	Remark
1	10620.000	37.34	14.56	51.90	74.00	-22.10	peak
2	15930.000	34.23	15.55	49.78	74.00	-24.22	peak

Note:1.Result (dBuV/m) = Correct Factor (dB/m) + Reading(dBuV).

2.Correction factor (dB/m) = Antenna Factor (dB/m) + Cable loss (dB) – Pre-Amplifier gain (dB).

3.When the peak results are less than average limit, so not need to evaluate the average.

Standard:	FCC Part 15.407	Test Distance:	3 m
Test item:	Harmonic		
Frequency:	5310 MHz		
Mode:	Mode 9		
Ant.Polar.:	Vertical		

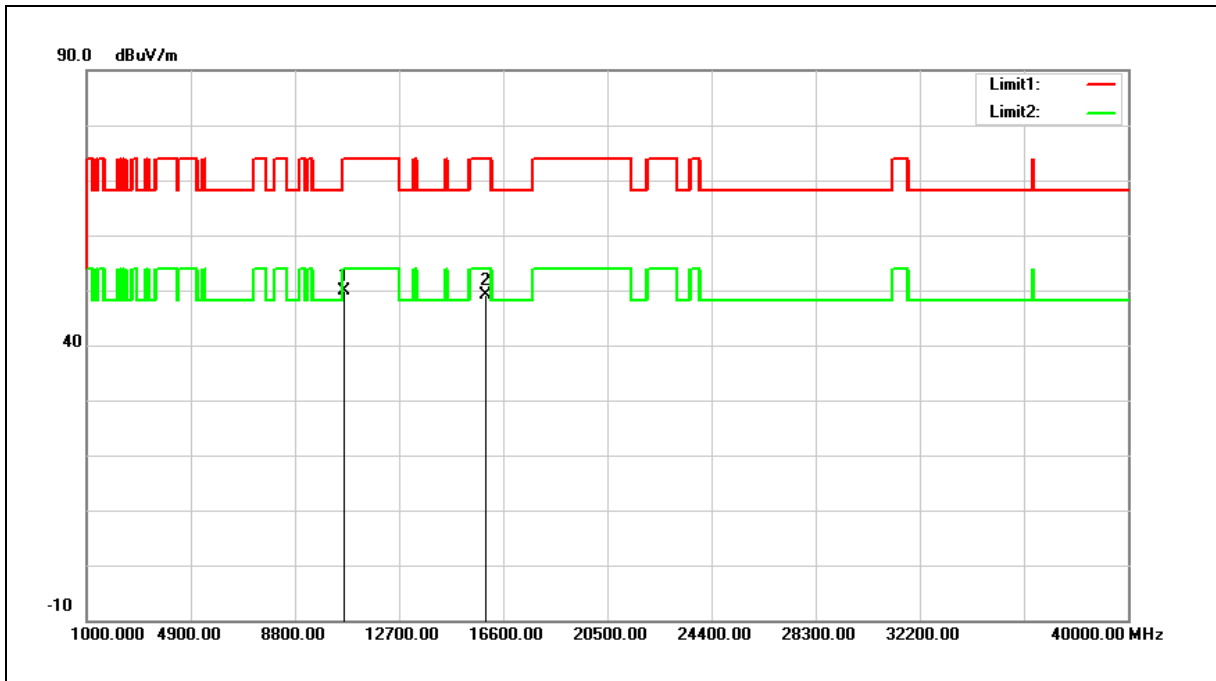

No.	Frequency (MHz)	Reading (dBuV)	Correct Factor (dB/m)	Result (dBuV/m)	Limit (dBuV/m)	Margin (dB)	Remark
1	10620.000	35.26	14.56	49.82	74.00	-24.18	peak
2	15930.000	33.47	15.55	49.02	74.00	-24.98	peak

Note:1.Result (dBuV/m) = Correct Factor (dB/m) + Reading(dBuV).

2.Correction factor (dB/m) = Antenna Factor (dB/m) + Cable loss (dB) – Pre-Amplifier gain (dB).

3.When the peak results are less than average limit, so not need to evaluate the average.

Standard:	FCC Part 15.407	Test Distance:	3 m
Test item:	Harmonic		
Frequency:	5510 MHz		
Mode:	Mode 9		
Ant.Polar.:	Horizontal		

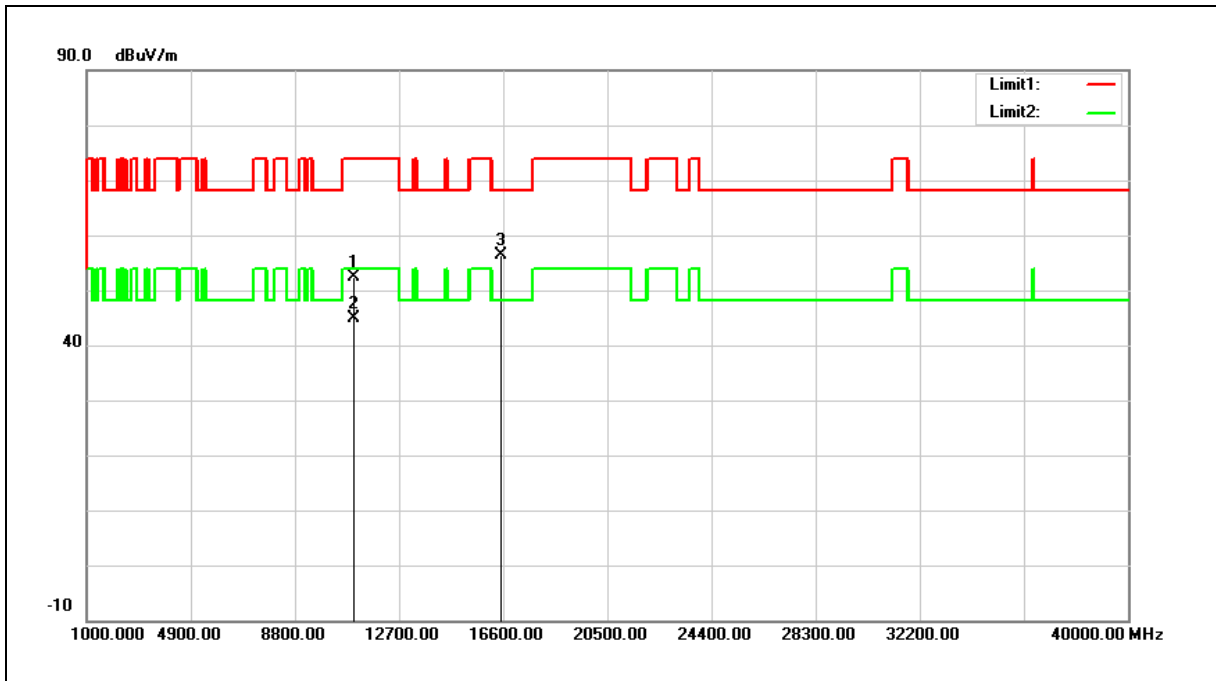

No.	Frequency (MHz)	Reading (dBuV)	Correct Factor (dB/m)	Result (dBuV/m)	Limit (dBuV/m)	Margin (dB)	Remark
1	11020.000	37.85	14.51	52.36	74.00	-21.64	peak
2	11020.000	30.30	14.51	44.81	54.00	-9.19	AVG
3	16530.000	39.47	16.85	56.32	68.20	-11.88	peak

Note:1.Result (dBuV/m) = Correct Factor (dB/m) + Reading(dBuV).

2.Correction factor (dB/m) = Antenna Factor (dB/m) + Cable loss (dB) – Pre-Amplifier gain (dB).

3.When the peak results are less than average limit, so not need to evaluate the average.

Standard:	FCC Part 15.407	Test Distance:	3 m
Test item:	Harmonic		
Frequency:	5510 MHz		
Mode:	Mode 9		
Ant.Polar.:	Vertical		

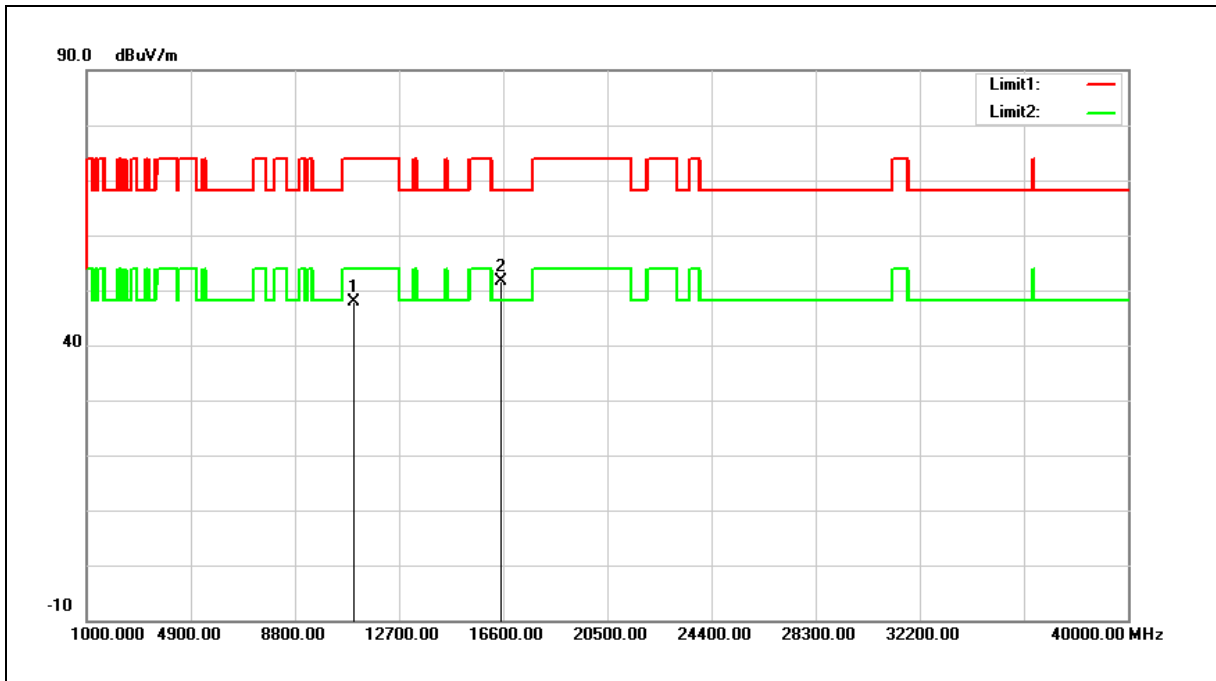

No.	Frequency (MHz)	Reading (dBuV)	Correct Factor (dB/m)	Result (dBuV/m)	Limit (dBuV/m)	Margin (dB)	Remark
1	11020.000	33.40	14.51	47.91	74.00	-26.09	peak
2	16530.000	34.83	16.85	51.68	68.20	-16.52	peak

Note:1.Result (dBuV/m) = Correct Factor (dB/m) + Reading(dBuV).

2.Correction factor (dB/m) = Antenna Factor (dB/m) + Cable loss (dB) – Pre-Amplifier gain (dB).

3.When the peak results are less than average limit, so not need to evaluate the average.

Standard:	FCC Part 15.407	Test Distance:	3 m
Test item:	Harmonic		
Frequency:	5550 MHz		
Mode:	Mode 9		
Ant.Polar.:	Horizontal		

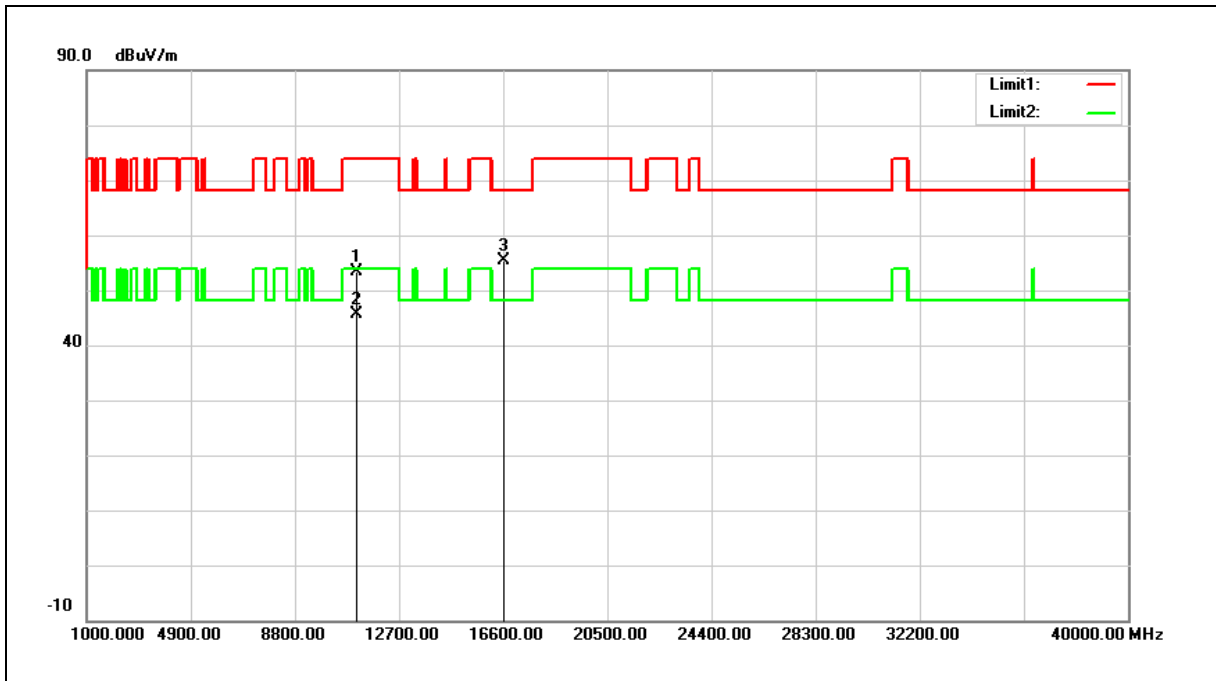

No.	Frequency (MHz)	Reading (dBuV)	Correct Factor (dB/m)	Result (dBuV/m)	Limit (dBuV/m)	Margin (dB)	Remark
1	11100.000	38.79	14.66	53.45	74.00	-20.55	peak
2	11100.000	30.90	14.66	45.56	54.00	-8.44	AVG
3	16650.000	37.59	17.73	55.32	68.20	-12.88	peak

Note:1.Result (dBuV/m) = Correct Factor (dB/m) + Reading(dBuV).

2.Correction factor (dB/m) = Antenna Factor (dB/m) + Cable loss (dB) – Pre-Amplifier gain (dB).

3.When the peak results are less than average limit, so not need to evaluate the average.

Standard:	FCC Part 15.407	Test Distance:	3 m
Test item:	Harmonic		
Frequency:	5550 MHz		
Mode:	Mode 9		
Ant.Polar.:	Vertical		

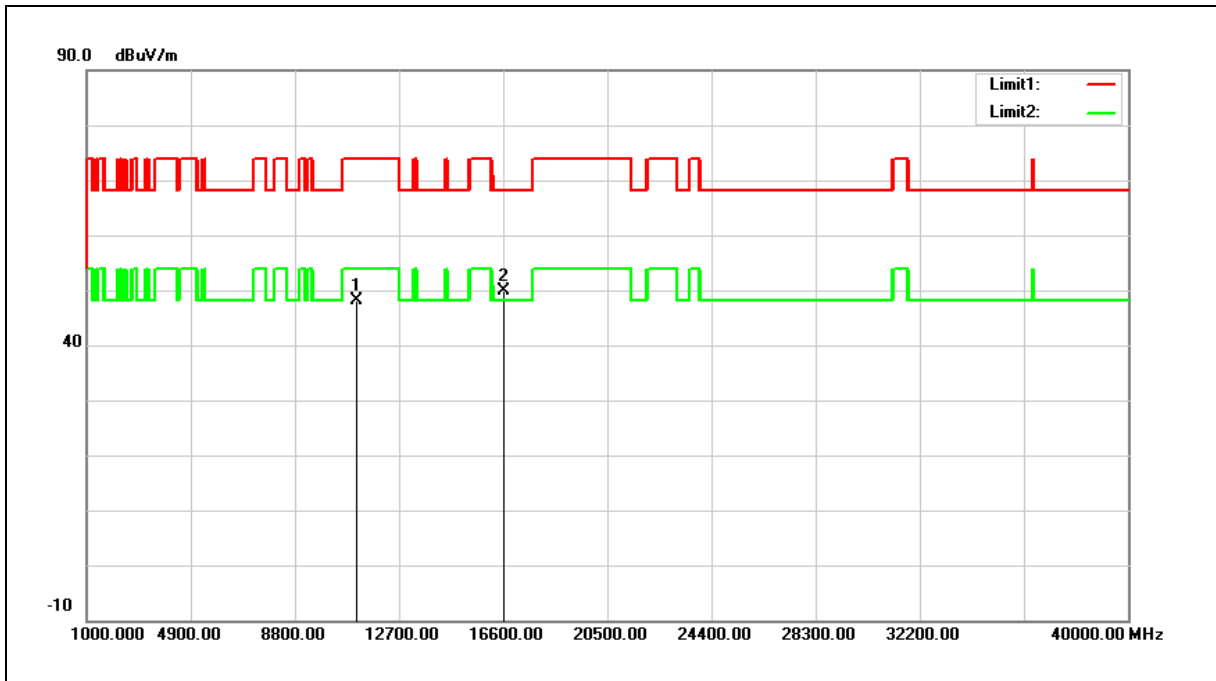

No.	Frequency (MHz)	Reading (dBuV)	Correct Factor (dB/m)	Result (dBuV/m)	Limit (dBuV/m)	Margin (dB)	Remark
1	11100.000	33.43	14.66	48.09	74.00	-25.91	peak
2	16650.000	32.23	17.73	49.96	68.20	-18.24	peak

Note:1.Result (dBuV/m) = Correct Factor (dB/m) + Reading(dBuV).

2.Correction factor (dB/m) = Antenna Factor (dB/m) + Cable loss (dB) – Pre-Amplifier gain (dB).

3.When the peak results are less than average limit, so not need to evaluate the average.

Standard:	FCC Part 15.407	Test Distance:	3 m
Test item:	Harmonic		
Frequency:	5670 MHz		
Mode:	Mode 9		
Ant.Polar.:	Horizontal		

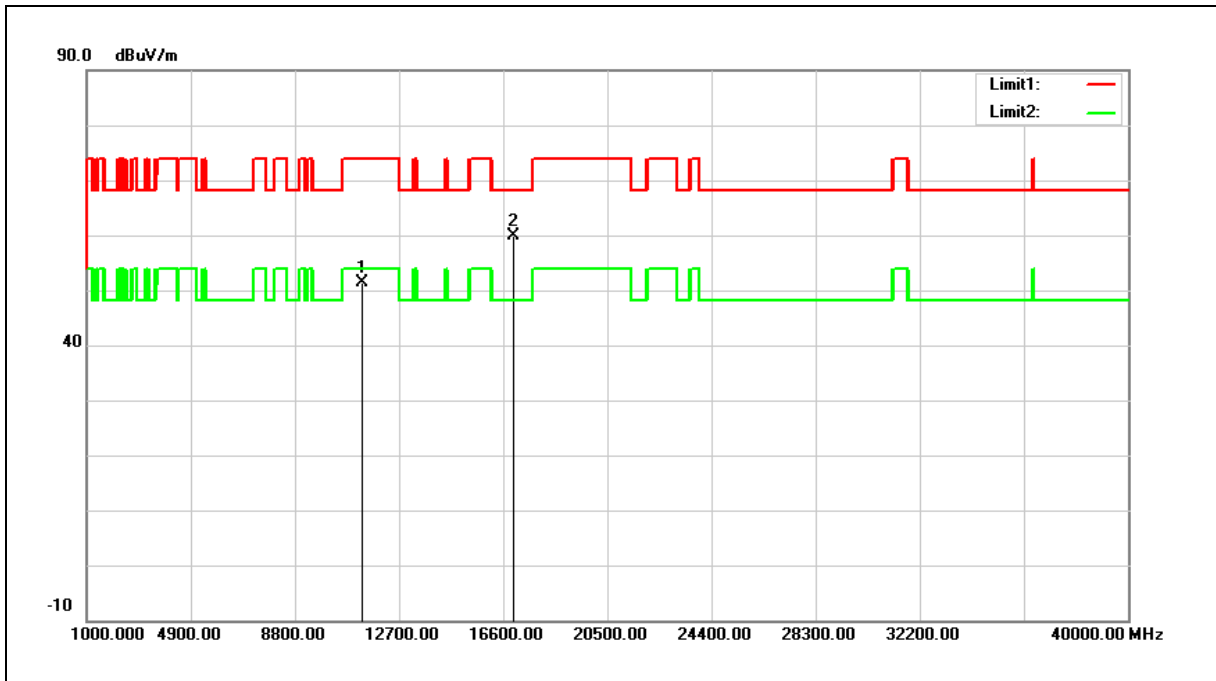

No.	Frequency (MHz)	Reading (dBuV)	Correct Factor (dB/m)	Result (dBuV/m)	Limit (dBuV/m)	Margin (dB)	Remark
1	11340.000	36.19	15.11	51.30	74.00	-22.70	peak
2	17010.000	39.47	20.36	59.83	68.20	-8.37	peak

Note:1.Result (dBuV/m) = Correct Factor (dB/m) + Reading(dBuV).

2.Correction factor (dB/m) = Antenna Factor (dB/m) + Cable loss (dB) – Pre-Amplifier gain (dB).

3.When the peak results are less than average limit, so not need to evaluate the average.

Standard:	FCC Part 15.407	Test Distance:	3 m
Test item:	Harmonic		
Frequency:	5670 MHz		
Mode:	Mode 9		
Ant.Polar.:	Vertical		

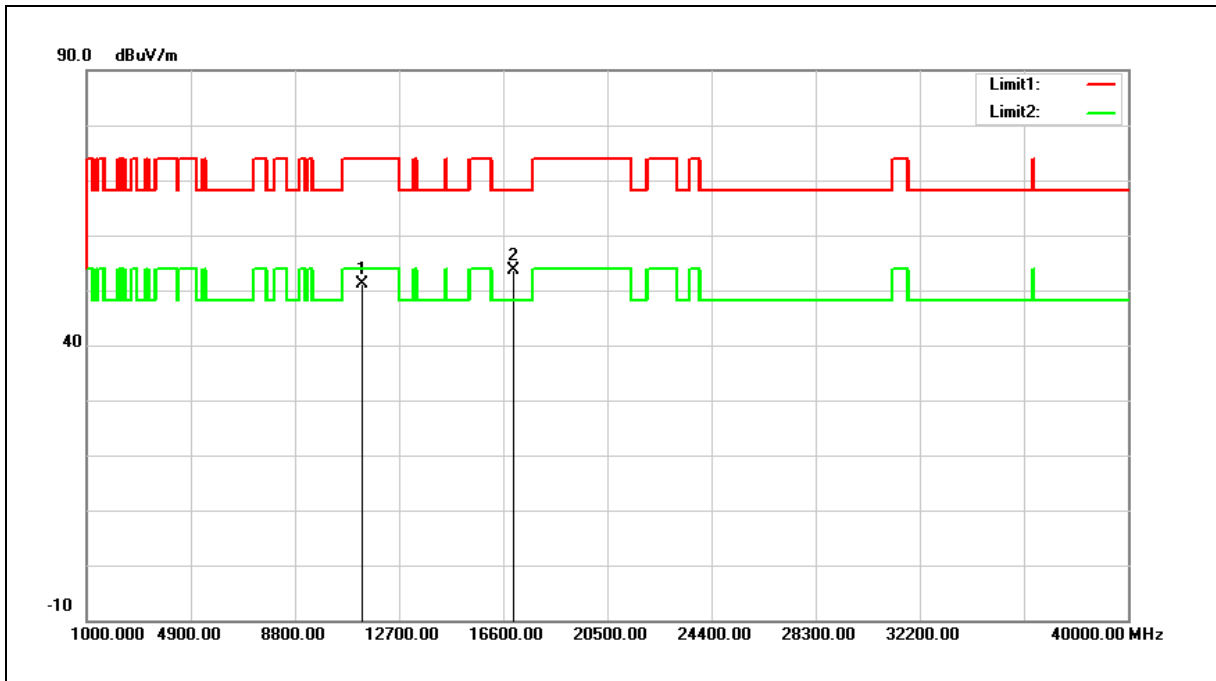

No.	Frequency (MHz)	Reading (dBuV)	Correct Factor (dB/m)	Result (dBuV/m)	Limit (dBuV/m)	Margin (dB)	Remark
1	11340.000	35.90	15.11	51.01	74.00	-22.99	peak
2	17010.000	33.17	20.36	53.53	68.20	-14.67	peak

Note:1.Result (dBuV/m) = Correct Factor (dB/m) + Reading(dBuV).

2.Correction factor (dB/m) = Antenna Factor (dB/m) + Cable loss (dB) – Pre-Amplifier gain (dB).

3.When the peak results are less than average limit, so not need to evaluate the average.

Standard:	FCC Part 15.407	Test Distance:	3 m
Test item:	Harmonic		
Frequency:	5755 MHz		
Mode:	Mode 9		
Ant.Polar.:	Horizontal		

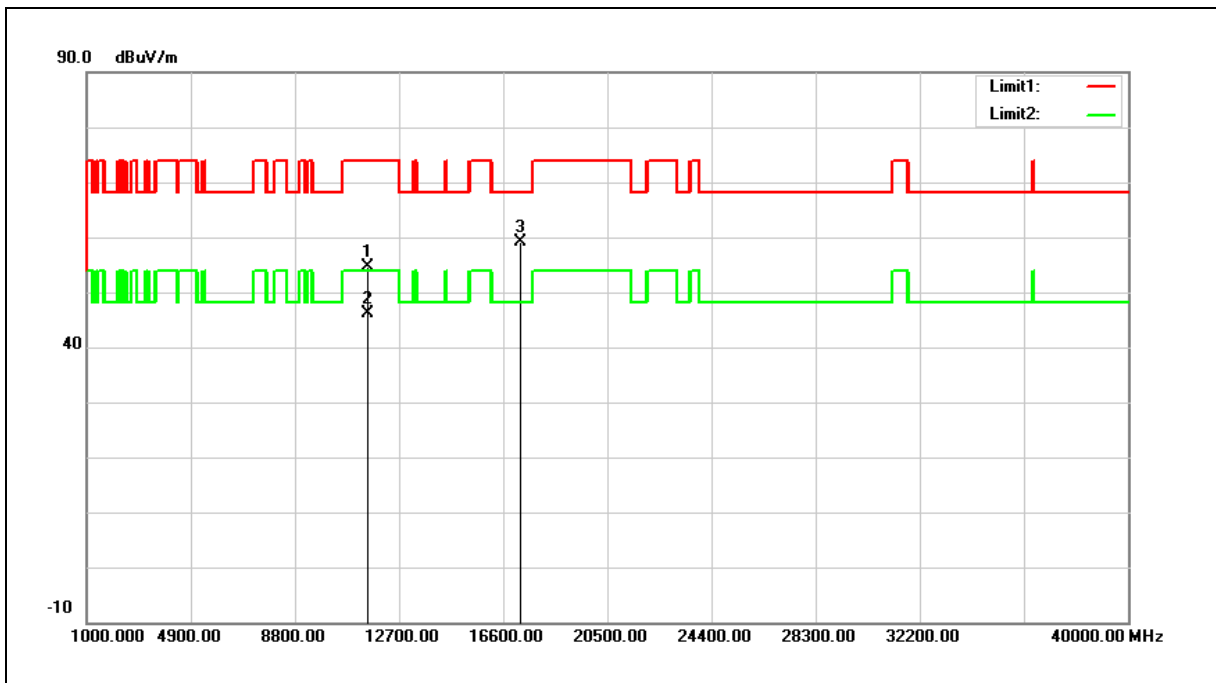

No.	Frequency (MHz)	Reading (dBuV)	Correct Factor (dB/m)	Result (dBuV/m)	Limit (dBuV/m)	Margin (dB)	Remark
1	11510.000	39.23	15.38	54.61	74.00	-19.39	peak
2	11510.000	30.82	15.38	46.20	54.00	-7.80	AVG
3	17265.000	37.34	21.88	59.22	68.20	-8.98	peak

Note:1.Result (dBuV/m) = Correct Factor (dB/m) + Reading(dBuV).

2.Correction factor (dB/m) = Antenna Factor (dB/m) + Cable loss (dB) – Pre-Amplifier gain (dB).

3.When the peak results are less than average limit, so not need to evaluate the average.

Standard:	FCC Part 15.407	Test Distance:	3 m
Test item:	Harmonic		
Frequency:	5755 MHz		
Mode:	Mode 9		
Ant.Polar.:	Vertical		

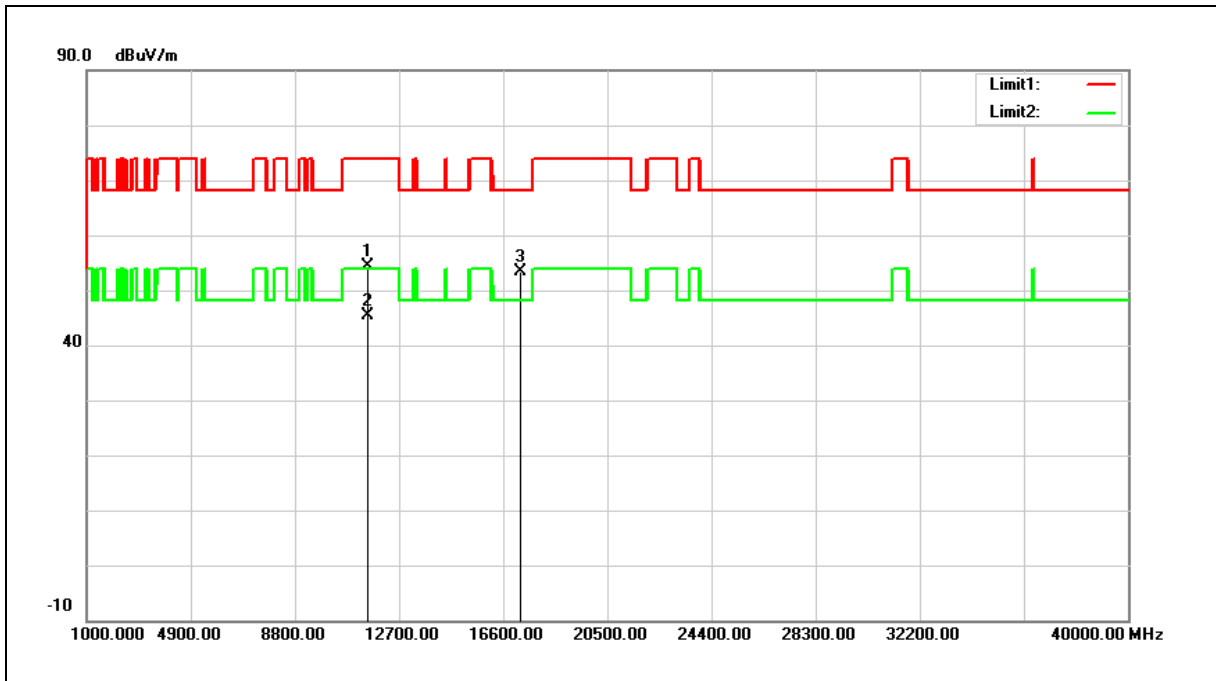

No.	Frequency (MHz)	Reading (dBuV)	Correct Factor (dB/m)	Result (dBuV/m)	Limit (dBuV/m)	Margin (dB)	Remark
1	11510.000	39.12	15.38	54.50	74.00	-19.50	peak
2	11510.000	29.98	15.38	45.36	54.00	-8.64	AVG
3	17265.000	31.49	21.88	53.37	68.20	-14.83	peak

Note:1.Result (dBuV/m) = Correct Factor (dB/m) + Reading(dBuV).

2.Correction factor (dB/m) = Antenna Factor (dB/m) + Cable loss (dB) – Pre-Amplifier gain (dB).

3.When the peak results are less than average limit, so not need to evaluate the average.

Standard:	FCC Part 15.407	Test Distance:	3 m
Test item:	Harmonic		
Frequency:	5795 MHz		
Mode:	Mode 9		
Ant.Polar.:	Horizontal		

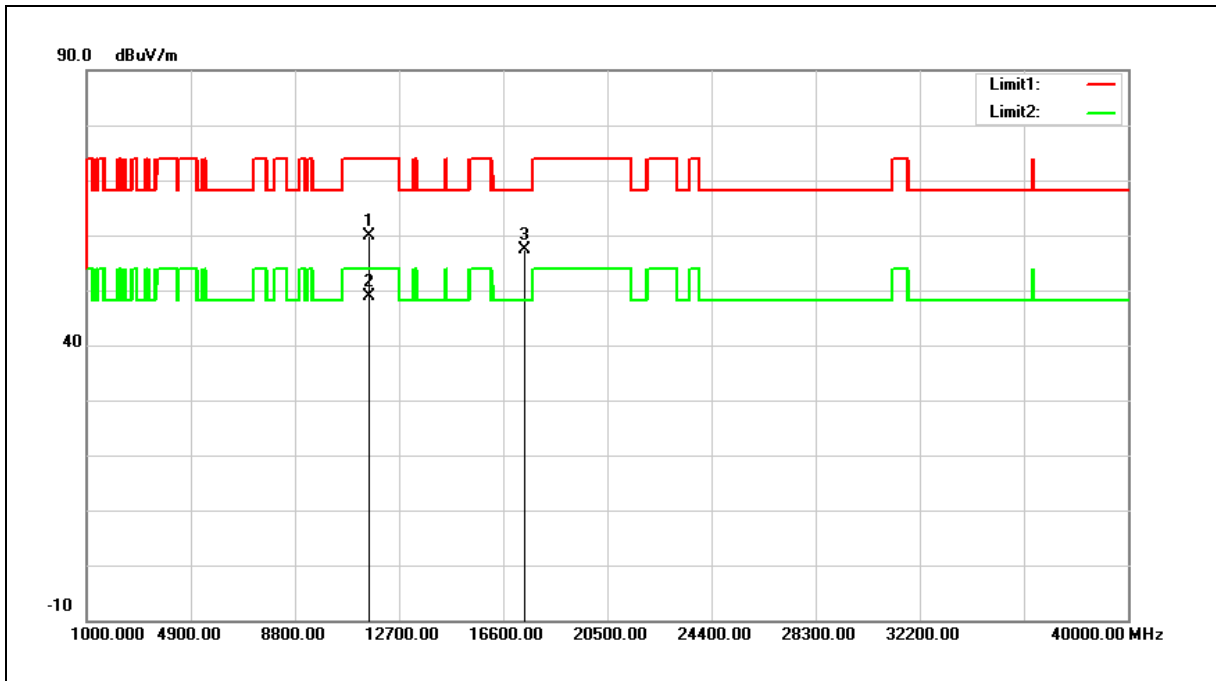

No.	Frequency (MHz)	Reading (dBuV)	Correct Factor (dB/m)	Result (dBuV/m)	Limit (dBuV/m)	Margin (dB)	Remark
1	11590.000	44.69	15.20	59.89	74.00	-14.11	peak
2	11590.000	33.61	15.20	48.81	54.00	-5.19	AVG
3	17385.000	34.72	22.60	57.32	68.20	-10.88	peak

Note:1.Result (dBuV/m) = Correct Factor (dB/m) + Reading(dBuV).

2.Correction factor (dB/m) = Antenna Factor (dB/m) + Cable loss (dB) – Pre-Amplifier gain (dB).

3.When the peak results are less than average limit, so not need to evaluate the average.

Standard:	FCC Part 15.407	Test Distance:	3 m
Test item:	Harmonic		
Frequency:	5795 MHz		
Mode:	Mode 9		
Ant.Polar.:	Vertical		

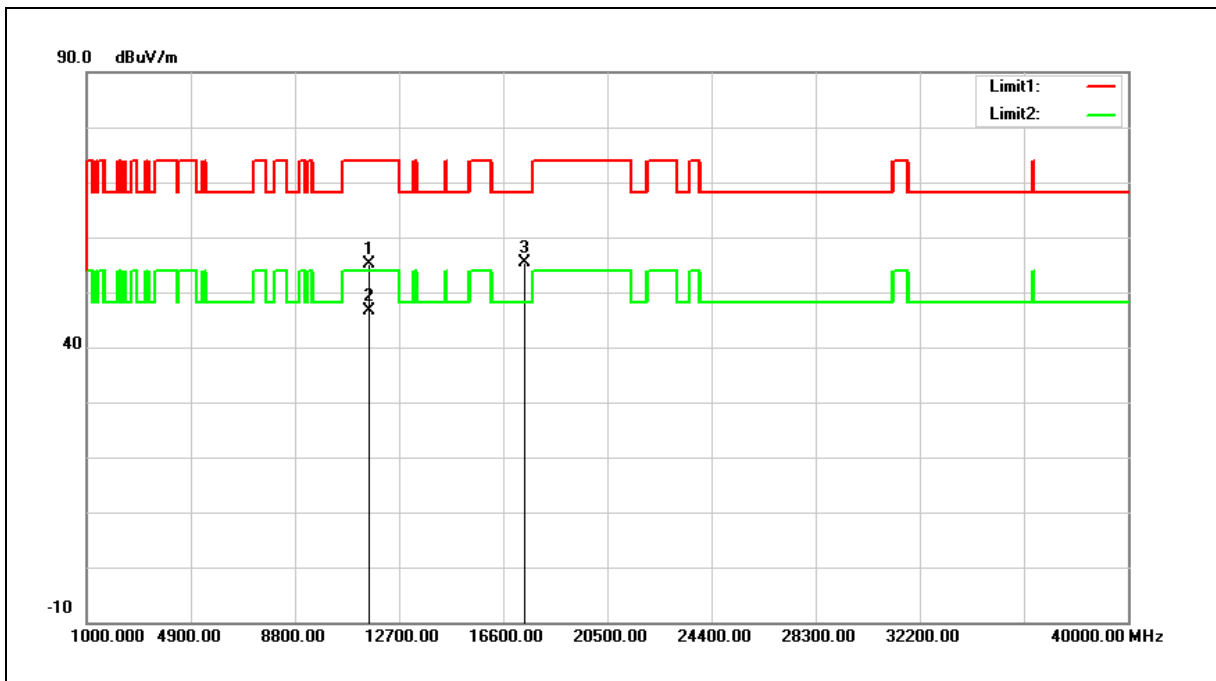

No.	Frequency (MHz)	Reading (dBuV)	Correct Factor (dB/m)	Result (dBuV/m)	Limit (dBuV/m)	Margin (dB)	Remark
1	11590.000	39.92	15.20	55.12	74.00	-18.88	peak
2	11590.000	31.39	15.20	46.59	54.00	-7.41	AVG
3	17385.000	32.69	22.60	55.29	68.20	-12.91	peak

Note:1.Result (dBuV/m) = Correct Factor (dB/m) + Reading(dBuV).

2.Correction factor (dB/m) = Antenna Factor (dB/m) + Cable loss (dB) – Pre-Amplifier gain (dB).

3.When the peak results are less than average limit, so not need to evaluate the average.

Standard:	FCC Part 15.407	Test Distance:	3 m
Test item:	Harmonic		
Frequency:	5210 MHz		
Mode:	Mode 10		
Ant.Polar.:	Horizontal		

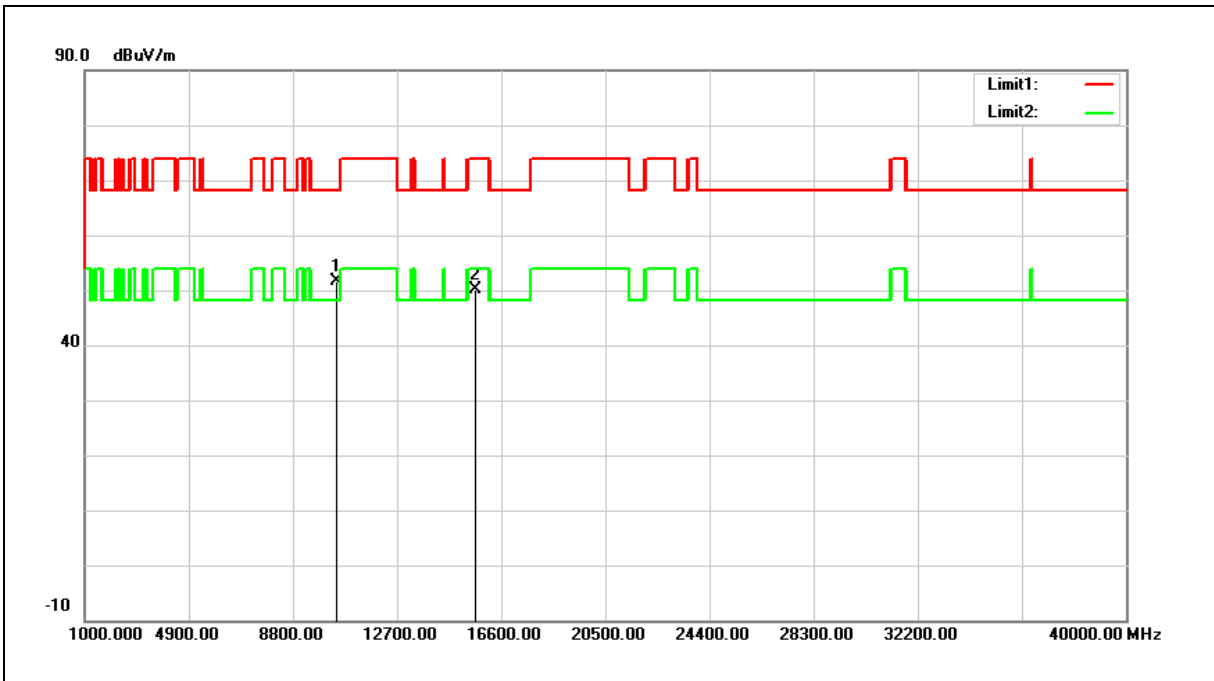

No.	Frequency (MHz)	Reading (dBuV)	Correct Factor (dB/m)	Result (dBuV/m)	Limit (dBuV/m)	Margin (dB)	Remark
1	10420.000	37.11	14.42	51.53	68.20	-16.67	peak
2	15630.000	33.56	16.56	50.12	74.00	-23.88	peak

- Note:1.Result (dBuV/m) = Correct Factor (dB/m) + Reading(dBuV).
 2.Correction factor (dB/m) = Antenna Factor (dB/m) + Cable loss (dB) – Pre-Amplifier gain (dB).
 3.When the peak results are less than average limit, so not need to evaluate the average.

Standard:	FCC Part 15.407	Test Distance:	3 m
Test item:	Harmonic		
Frequency:	5210 MHz		
Mode:	Mode 10		
Ant.Polar.:	Vertical		

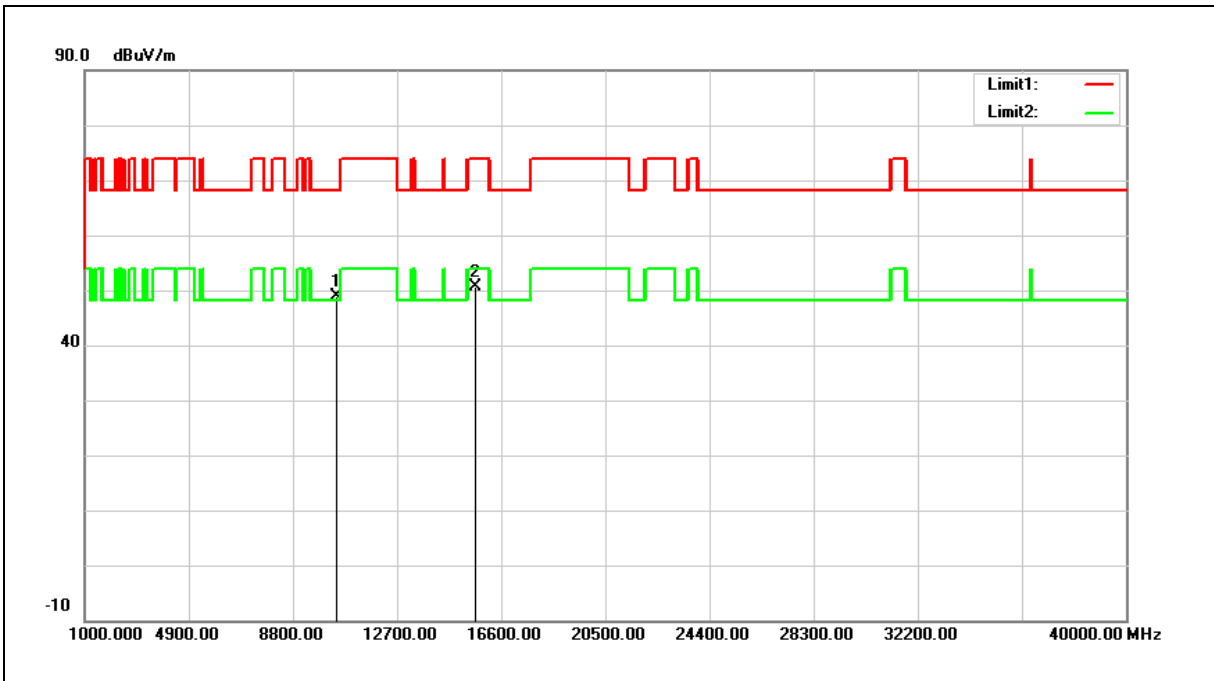

No.	Frequency (MHz)	Reading (dBuV)	Correct Factor (dB/m)	Result (dBuV/m)	Limit (dBuV/m)	Margin (dB)	Remark
1	10420.000	34.56	14.42	48.98	68.20	-19.22	peak
2	15630.000	34.15	16.56	50.71	74.00	-23.29	peak

Note:1.Result (dBuV/m) = Correct Factor (dB/m) + Reading(dBuV).

2.Correction factor (dB/m) = Antenna Factor (dB/m) + Cable loss (dB) – Pre-Amplifier gain (dB).

3.When the peak results are less than average limit, so not need to evaluate the average.

Standard:	FCC Part 15.407	Test Distance:	3 m
Test item:	Harmonic		
Frequency:	5290 MHz		
Mode:	Mode 10		
Ant.Polar.:	Horizontal		

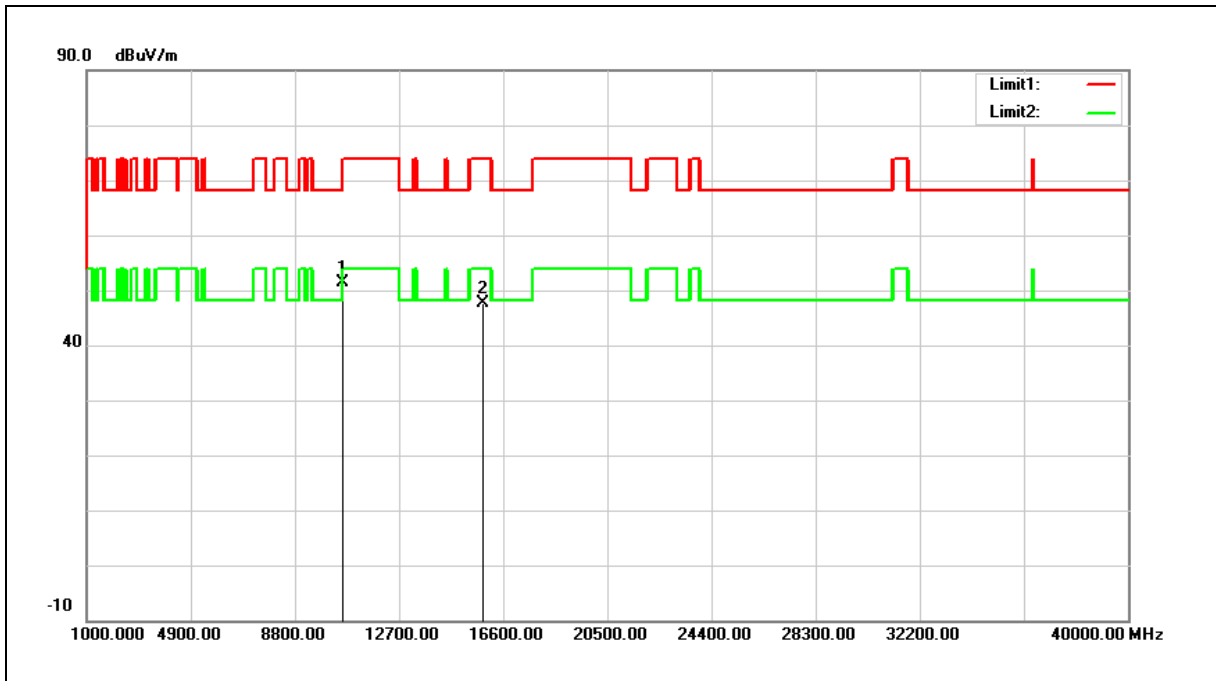

No.	Frequency (MHz)	Reading (dBuV)	Correct Factor (dB/m)	Result (dBuV/m)	Limit (dBuV/m)	Margin (dB)	Remark
1	10580.000	36.75	14.57	51.32	68.20	-16.88	peak
2	15870.000	31.90	15.74	47.64	74.00	-26.36	peak

Note:1.Result (dBuV/m) = Correct Factor (dB/m) + Reading(dBuV).

2.Correction factor (dB/m) = Antenna Factor (dB/m) + Cable loss (dB) – Pre-Amplifier gain (dB).

3.When the peak results are less than average limit, so not need to evaluate the average.

Standard:	FCC Part 15.407	Test Distance:	3 m
Test item:	Harmonic		
Frequency:	5290 MHz		
Mode:	Mode 10		
Ant.Polar.:	Vertical		

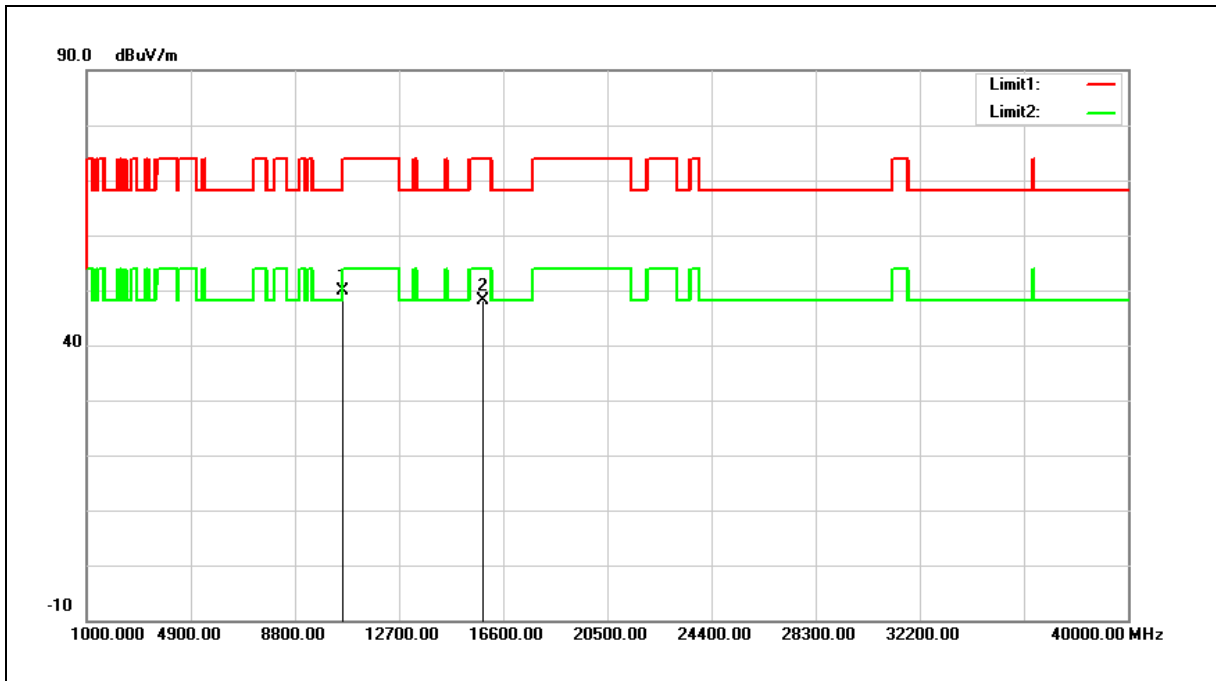

No.	Frequency (MHz)	Reading (dBuV)	Correct Factor (dB/m)	Result (dBuV/m)	Limit (dBuV/m)	Margin (dB)	Remark
1	10580.000	35.39	14.57	49.96	68.20	-18.24	peak
2	15870.000	32.37	15.74	48.11	74.00	-25.89	peak

Note:1.Result (dBuV/m) = Correct Factor (dB/m) + Reading(dBuV).

2.Correction factor (dB/m) = Antenna Factor (dB/m) + Cable loss (dB) – Pre-Amplifier gain (dB).

3.When the peak results are less than average limit, so not need to evaluate the average.

Standard:	FCC Part 15.407	Test Distance:	3 m
Test item:	Harmonic		
Frequency:	5530 MHz		
Mode:	Mode 10		
Ant.Polar.:	Horizontal		

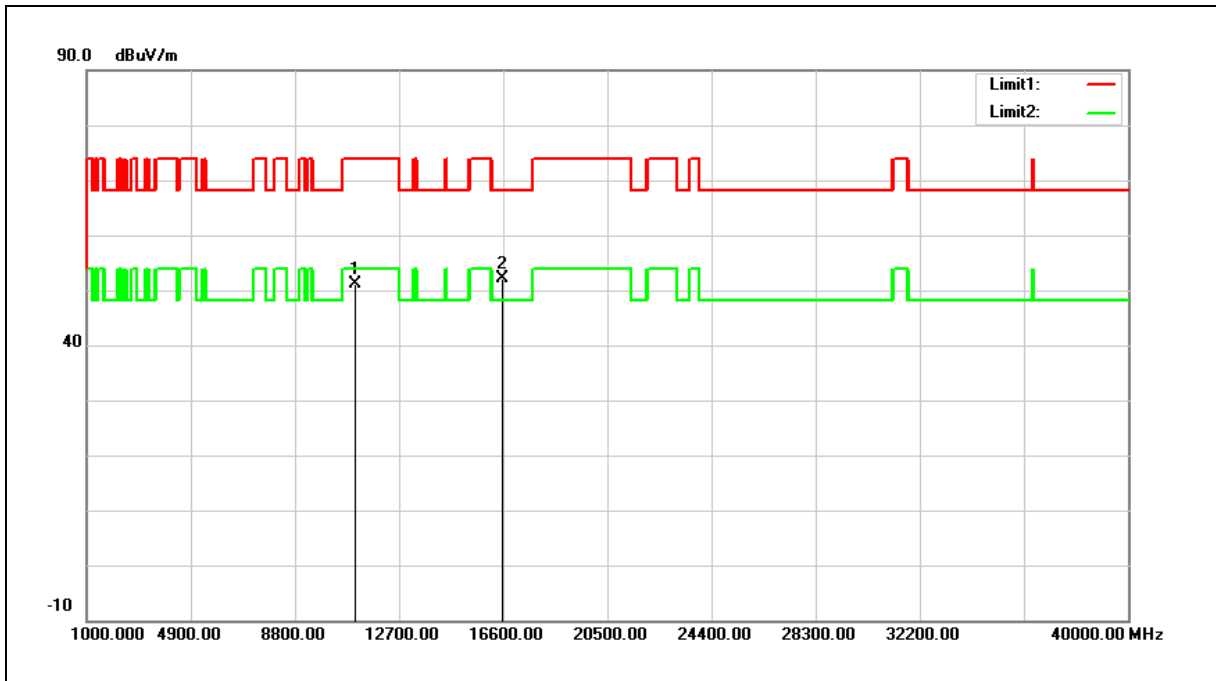

No.	Frequency (MHz)	Reading (dBuV)	Correct Factor (dB/m)	Result (dBuV/m)	Limit (dBuV/m)	Margin (dB)	Remark
1	11060.000	36.62	14.58	51.20	74.00	-22.80	peak
2	16590.000	34.83	17.29	52.12	68.20	-16.08	peak

Note:1.Result (dBuV/m) = Correct Factor (dB/m) + Reading(dBuV).

2.Correction factor (dB/m) = Antenna Factor (dB/m) + Cable loss (dB) – Pre-Amplifier gain (dB).

3.When the peak results are less than average limit, so not need to evaluate the average.

Standard:	FCC Part 15.407	Test Distance:	3 m
Test item:	Harmonic		
Frequency:	5530 MHz		
Mode:	Mode 10		
Ant.Polar.:	Vertical		

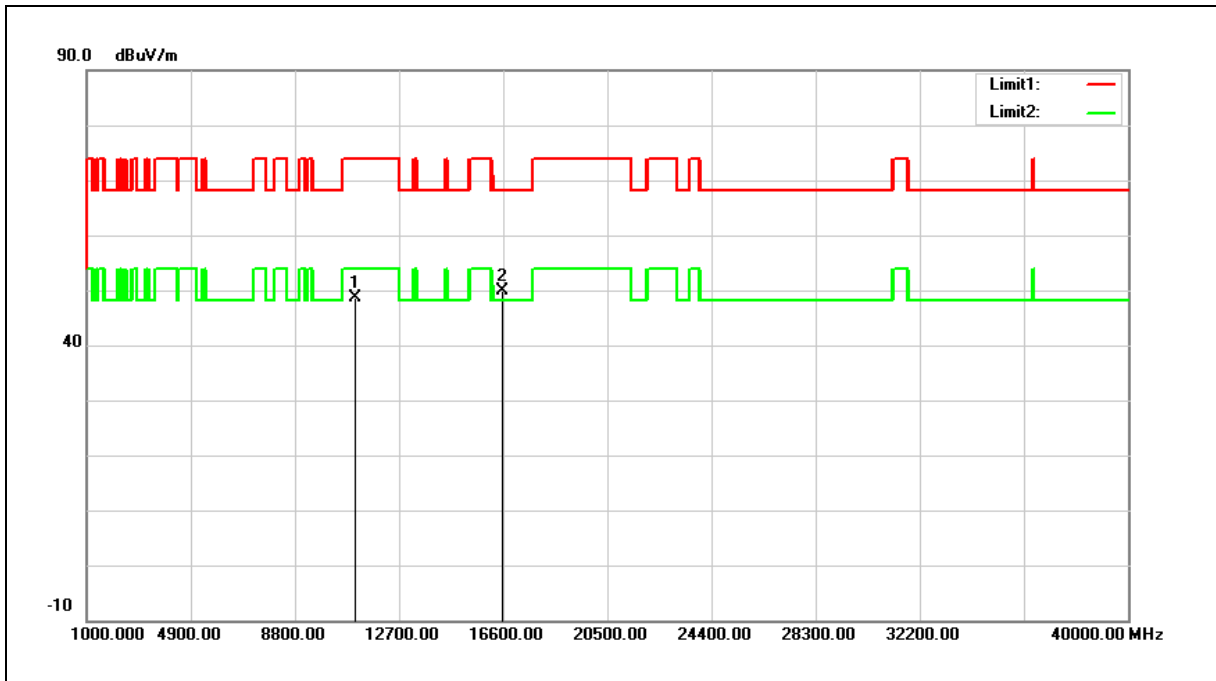

No.	Frequency (MHz)	Reading (dBuV)	Correct Factor (dB/m)	Result (dBuV/m)	Limit (dBuV/m)	Margin (dB)	Remark
1	11060.000	34.04	14.58	48.62	74.00	-25.38	peak
2	16590.000	32.70	17.29	49.99	68.20	-18.21	peak

Note:1.Result (dBuV/m) = Correct Factor (dB/m) + Reading(dBuV).

2.Correction factor (dB/m) = Antenna Factor (dB/m) + Cable loss (dB) – Pre-Amplifier gain (dB).

3.When the peak results are less than average limit, so not need to evaluate the average.

Standard:	FCC Part 15.407	Test Distance:	3 m
Test item:	Harmonic		
Frequency:	5775 MHz		
Mode:	Mode 10		
Ant.Polar.:	Horizontal		

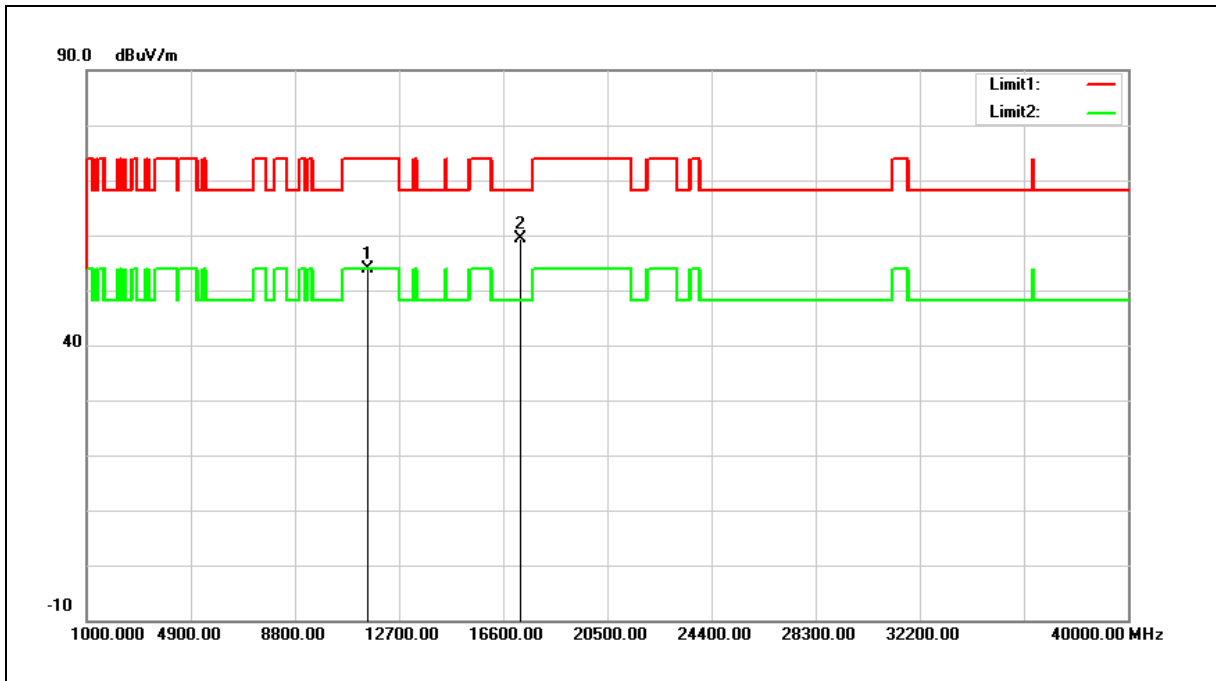

No.	Frequency (MHz)	Reading (dBuV)	Correct Factor (dB/m)	Result (dBuV/m)	Limit (dBuV/m)	Margin (dB)	Remark
1	11550.000	38.61	15.29	53.90	74.00	-20.10	peak
2	17325.000	37.61	22.24	59.85	68.20	-8.35	peak

Note:1.Result (dBuV/m) = Correct Factor (dB/m) + Reading(dBuV).

2.Correction factor (dB/m) = Antenna Factor (dB/m) + Cable loss (dB) – Pre-Amplifier gain (dB).

3.When the peak results are less than average limit, so not need to evaluate the average.

Standard:	FCC Part 15.407	Test Distance:	3 m
Test item:	Harmonic		
Frequency:	5775 MHz		
Mode:	Mode 10		
Ant.Polar.:	Vertical		

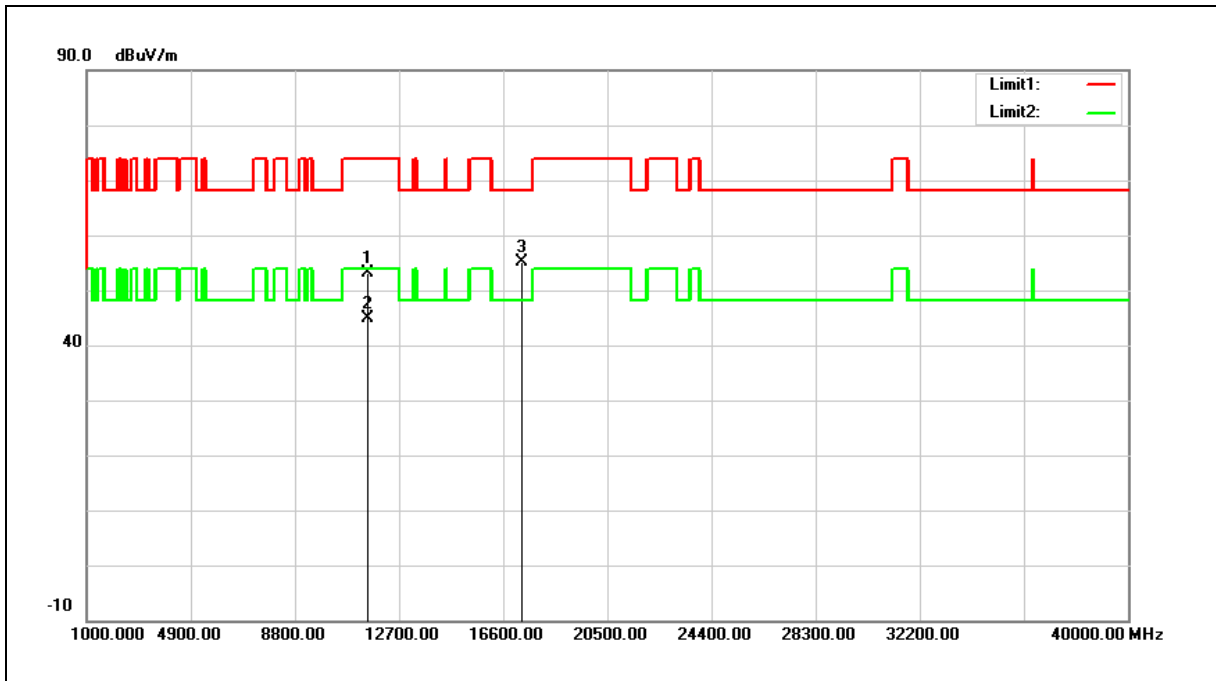

No.	Frequency (MHz)	Reading (dBuV)	Correct Factor (dB/m)	Result (dBuV/m)	Limit (dBuV/m)	Margin (dB)	Remark
1	11550.000	37.82	15.29	53.11	74.00	-20.89	peak
2	11550.000	29.47	15.29	44.76	54.00	-9.24	AVG
3	17325.000	32.91	22.24	55.15	68.20	-13.05	peak

Note:1.Result (dBuV/m) = Correct Factor (dB/m) + Reading(dBuV).

2.Correction factor (dB/m) = Antenna Factor (dB/m) + Cable loss (dB) – Pre-Amplifier gain (dB).

3.When the peak results are less than average limit, so not need to evaluate the average.

Standard:	FCC Part 15.407	Test Distance:	3 m
Test item:	Transmitter Unwanted Emissions		
Test Mode:	Simultaneous Transmitting (WLAN 2.4 GHz + 5 GHz)		
Ant.Polar.:	Horizontal		

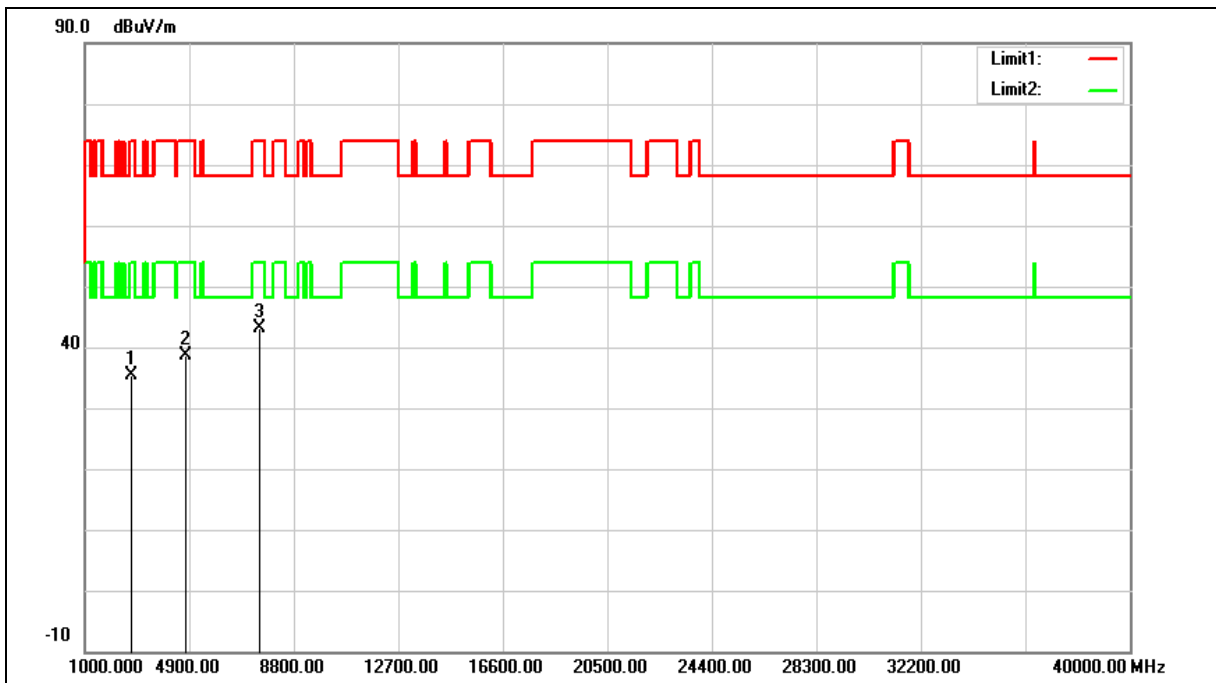

No.	Frequency (MHz)	Reading (dBuV)	Correct Factor (dB/m)	Result (dBuV/m)	Limit (dBuV/m)	Margin (dB)	Remark
1	2734.000	41.62	-6.15	35.47	74.00	-38.53	peak
2	4757.000	39.78	-1.21	38.57	74.00	-35.43	peak
3	7545.000	35.75	7.29	43.04	74.00	-30.96	peak

Note:1.Result (dBuV/m) = Correct Factor (dB/m) + Reading(dBuV).

2.Correction factor (dB/m) = Antenna Factor (dB/m) + Cable loss (dB) – Pre-Amplifier gain (dB).

3.When the peak results are less than average limit, so not need to evaluate the average.

Standard:	FCC Part 15.407	Test Distance:	3 m
Test item:	Transmitter Unwanted Emissions		
Test Mode:	Simultaneous Transmitting (WLAN 2.4 GHz + 5 GHz)		
Ant.Polar.:	Vertical		

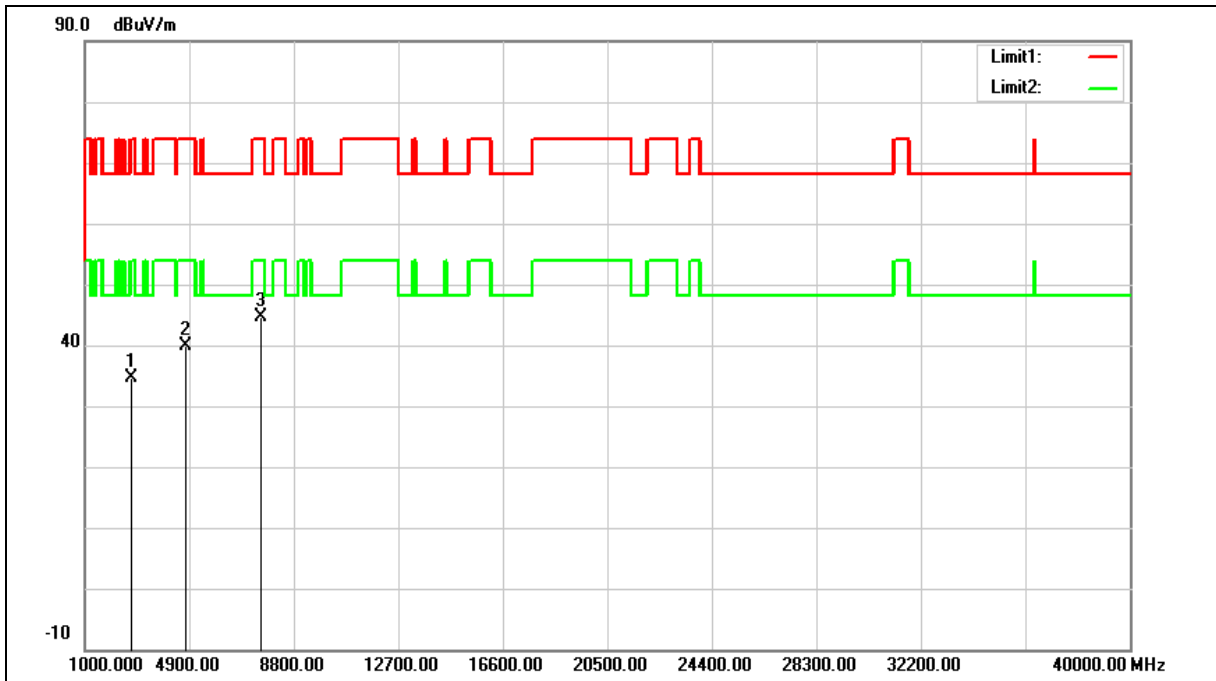

No.	Frequency (MHz)	Reading (dBuV)	Correct Factor (dB/m)	Result (dBuV/m)	Limit (dBuV/m)	Margin (dB)	Remark
1	2751.000	40.67	-6.10	34.57	74.00	-39.43	peak
2	4740.000	41.11	-1.26	39.85	74.00	-34.15	peak
3	7545.000	37.31	7.29	44.60	74.00	-29.40	peak

Note:1.Result (dBuV/m) = Correct Factor (dB/m) + Reading(dBuV).

2.Correction factor (dB/m) = Antenna Factor (dB/m) + Cable loss (dB) – Pre-Amplifier gain (dB).

3.When the peak results are less than average limit, so not need to evaluate the average.

Band Edge

Peak

Standard:	FCC Part 15.407	Test Distance:	3 m
Test item:	Band edge		
Frequency:	5180 MHz		
Mode:	Mode 8		
Ant.Polar.:	Horizontal		

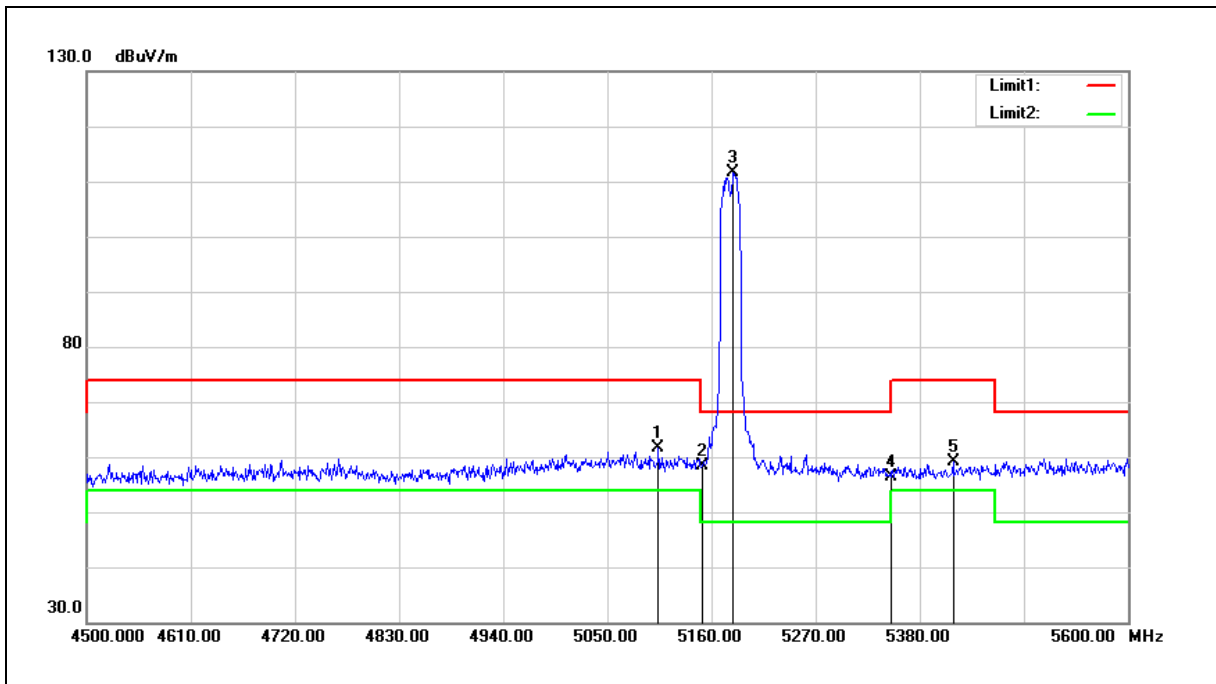

No.	Frequency (MHz)	Reading (dBuV)	Correct Factor (dB/m)	Result (dBuV/m)	Limit (dBuV/m)	Margin (dB)	Remark
1	5103.900	61.78	-0.16	61.62	74.00	-12.38	peak
2	5150.000	58.48	-0.08	58.40	74.00	-15.60	peak
3	5183.100	111.65	-0.02	111.63	--	--	peak
4	5350.000	56.06	0.30	56.36	74.00	-17.64	peak
5	5415.200	58.77	0.41	59.18	74.00	-14.82	peak

Note:1.Result (dBuV/m) = Correct Factor (dB/m) + Reading(dBuV).

2.Correction factor (dB/m) = Antenna Factor (dB/m) + Cable loss (dB) – Pre-Amplifier gain (dB).

3.When the peak results are less than average limit, so not need to evaluate the average.

Standard:	FCC Part 15.407	Test Distance:	3 m
Test item:	Band edge		
Frequency:	5180 MHz		
Mode:	Mode 8		
Ant.Polar.:	Vertical		

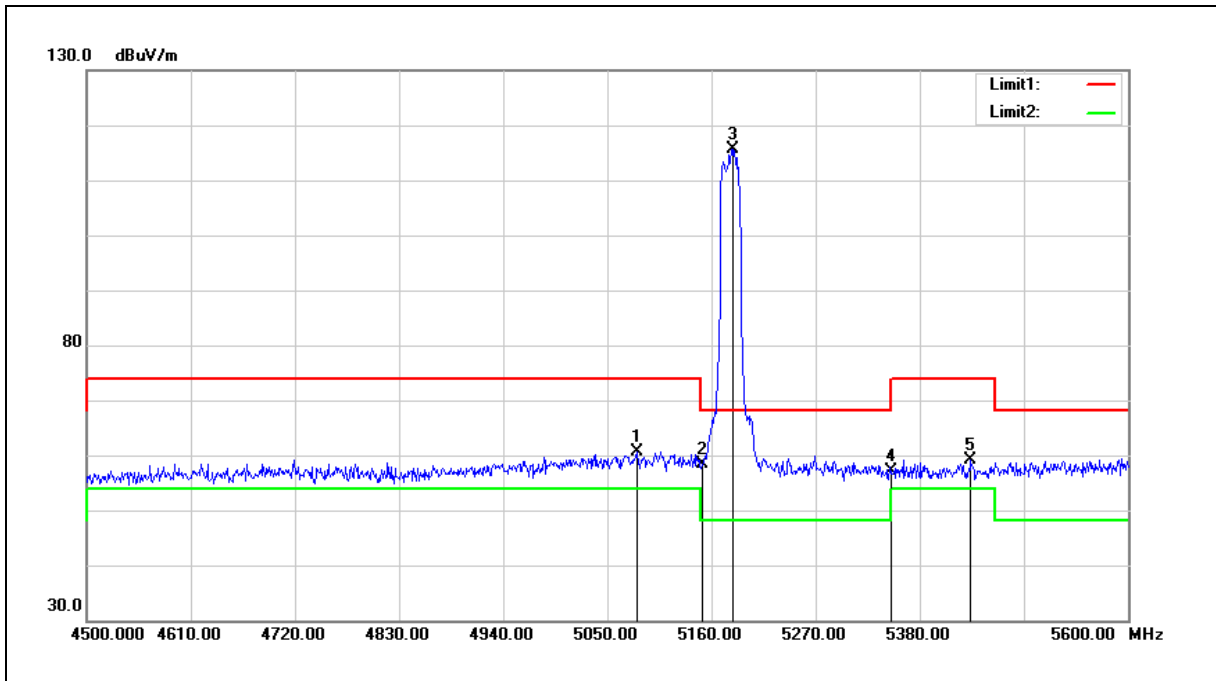

No.	Frequency (MHz)	Reading (dBuV)	Correct Factor (dB/m)	Result (dBuV/m)	Limit (dBuV/m)	Margin (dB)	Remark
1	5080.800	60.93	-0.21	60.72	74.00	-13.28	peak
2	5150.000	58.46	-0.08	58.38	74.00	-15.62	peak
3	5183.100	115.63	-0.02	115.61	--	--	peak
4	5350.000	56.84	0.30	57.14	74.00	-16.86	peak
5	5433.900	58.77	0.46	59.23	74.00	-14.77	peak

Note:1.Result (dBuV/m) = Correct Factor (dB/m) + Reading(dBuV).

2.Correction factor (dB/m) = Antenna Factor (dB/m) + Cable loss (dB) – Pre-Amplifier gain (dB).

3.When the peak results are less than average limit, so not need to evaluate the average.

Standard:	FCC Part 15.407	Test Distance:	3 m
Test item:	Band edge		
Frequency:	5200 MHz		
Mode:	Mode 8		
Ant.Polar.:	Horizontal		

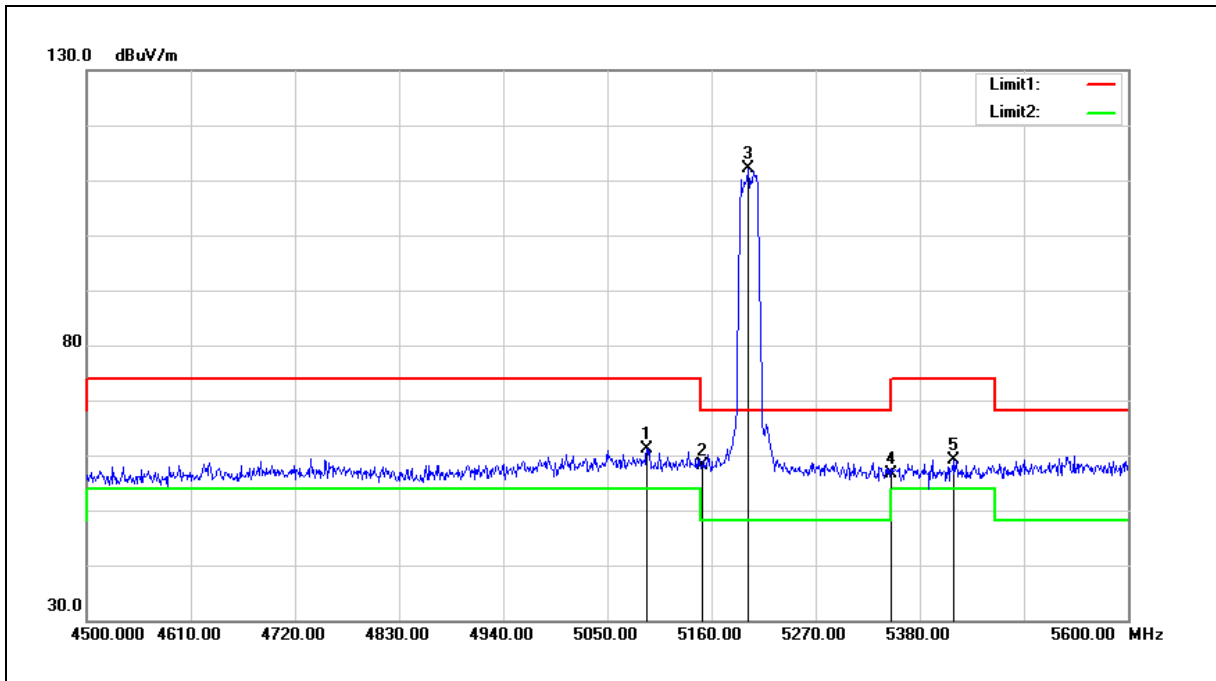

No.	Frequency (MHz)	Reading (dBuV)	Correct Factor (dB/m)	Result (dBuV/m)	Limit (dBuV/m)	Margin (dB)	Remark
1	5091.800	61.38	-0.19	61.19	74.00	-12.81	peak
2	5150.000	58.25	-0.08	58.17	74.00	-15.83	peak
3	5198.500	112.04	0.01	112.05	--	--	peak
4	5350.000	56.37	0.30	56.67	74.00	-17.33	peak
5	5415.200	58.76	0.41	59.17	74.00	-14.83	peak

Note:1.Result (dBuV/m) = Correct Factor (dB/m) + Reading(dBuV).

2.Correction factor (dB/m) = Antenna Factor (dB/m) + Cable loss (dB) – Pre-Amplifier gain (dB).

3.When the peak results are less than average limit, so not need to evaluate the average.

Standard:	FCC Part 15.407	Test Distance:	3 m
Test item:	Band edge		
Frequency:	5200 MHz		
Mode:	Mode 8		
Ant.Polar.:	Vertical		

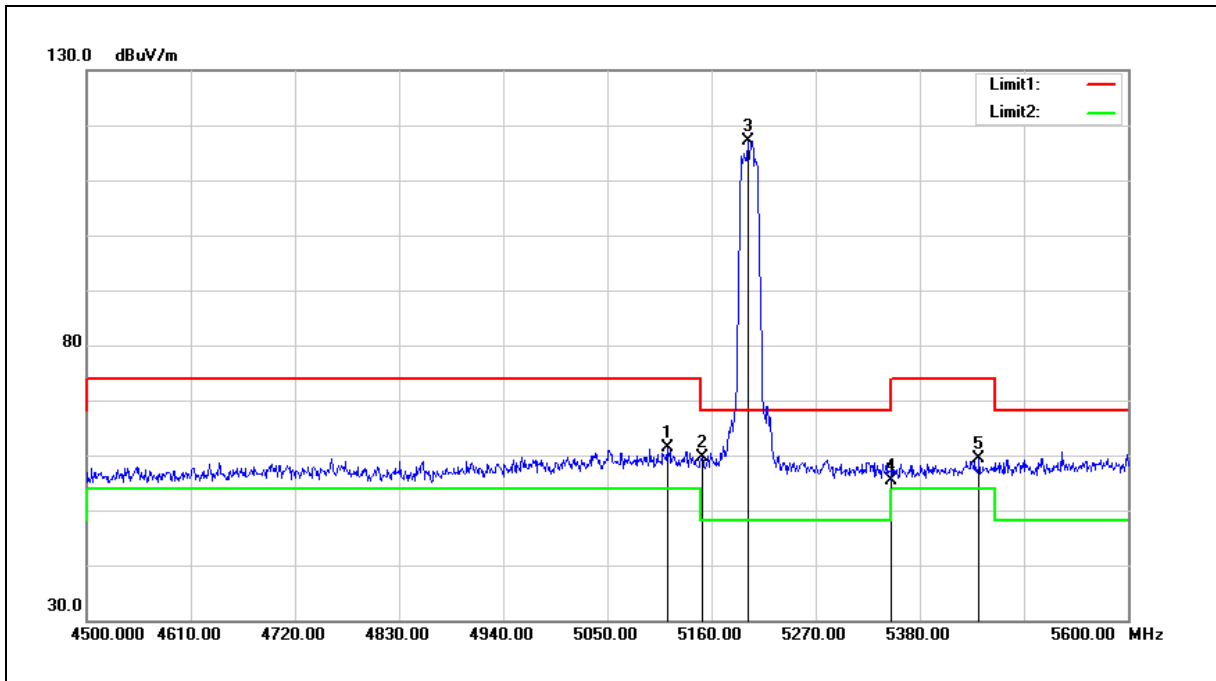

No.	Frequency (MHz)	Reading (dBuV)	Correct Factor (dB/m)	Result (dBuV/m)	Limit (dBuV/m)	Margin (dB)	Remark
1	5113.800	61.57	-0.15	61.42	74.00	-12.58	peak
2	5150.000	59.77	-0.08	59.69	74.00	-14.31	peak
3	5198.500	117.16	0.01	117.17	--	--	peak
4	5350.000	55.07	0.30	55.37	74.00	-18.63	peak
5	5442.700	58.85	0.46	59.31	74.00	-14.69	peak

Note:1.Result (dBuV/m) = Correct Factor (dB/m) + Reading(dBuV).

2.Correction factor (dB/m) = Antenna Factor (dB/m) + Cable loss (dB) – Pre-Amplifier gain (dB).

3.When the peak results are less than average limit, so not need to evaluate the average.

Standard:	FCC Part 15.407	Test Distance:	3 m
Test item:	Band edge		
Frequency:	5240 MHz		
Mode:	Mode 8		
Ant.Polar.:	Horizontal		

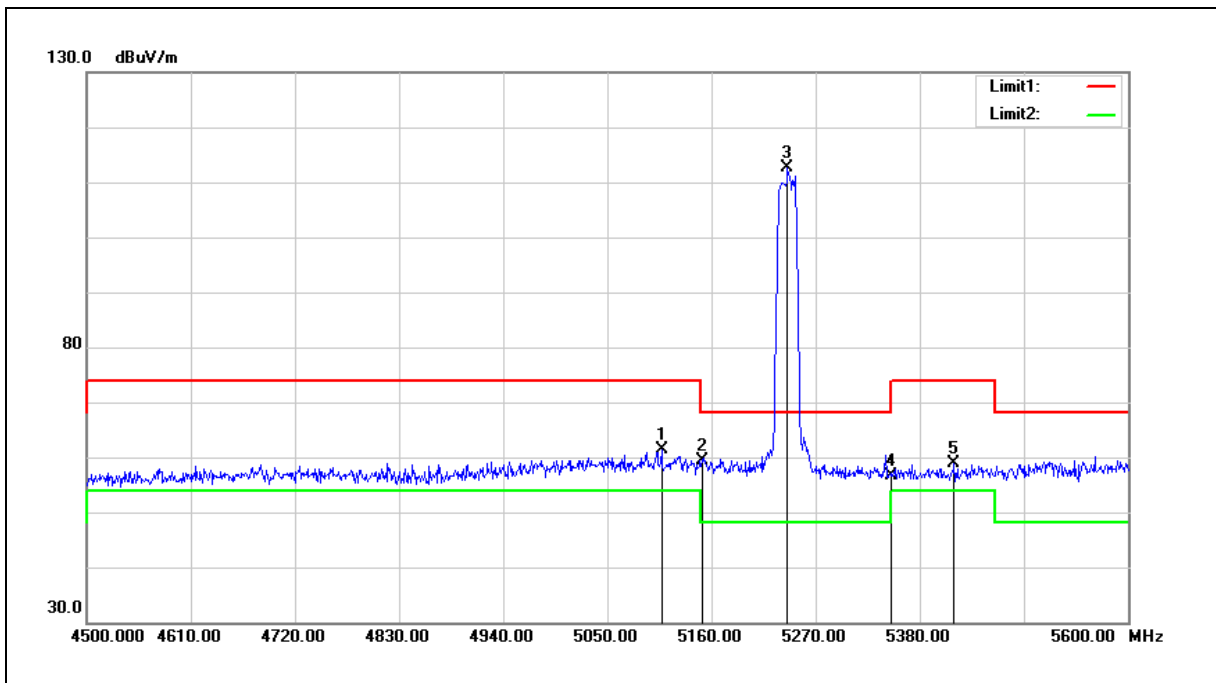

No.	Frequency (MHz)	Reading (dBuV)	Correct Factor (dB/m)	Result (dBuV/m)	Limit (dBuV/m)	Margin (dB)	Remark
1	5107.200	61.63	-0.15	61.48	74.00	-12.52	peak
2	5150.000	59.54	-0.08	59.46	74.00	-14.54	peak
3	5240.300	112.56	0.09	112.65	--	--	peak
4	5350.000	56.25	0.30	56.55	74.00	-17.45	peak
5	5416.300	58.38	0.41	58.79	74.00	-15.21	peak

Note:1.Result (dBuV/m) = Correct Factor (dB/m) + Reading(dBuV).

2.Correction factor (dB/m) = Antenna Factor (dB/m) + Cable loss (dB) – Pre-Amplifier gain (dB).

3.When the peak results are less than average limit, so not need to evaluate the average.

Standard:	FCC Part 15.407	Test Distance:	3 m
Test item:	Band edge		
Frequency:	5240 MHz		
Mode:	Mode 8		
Ant.Polar.:	Vertical		

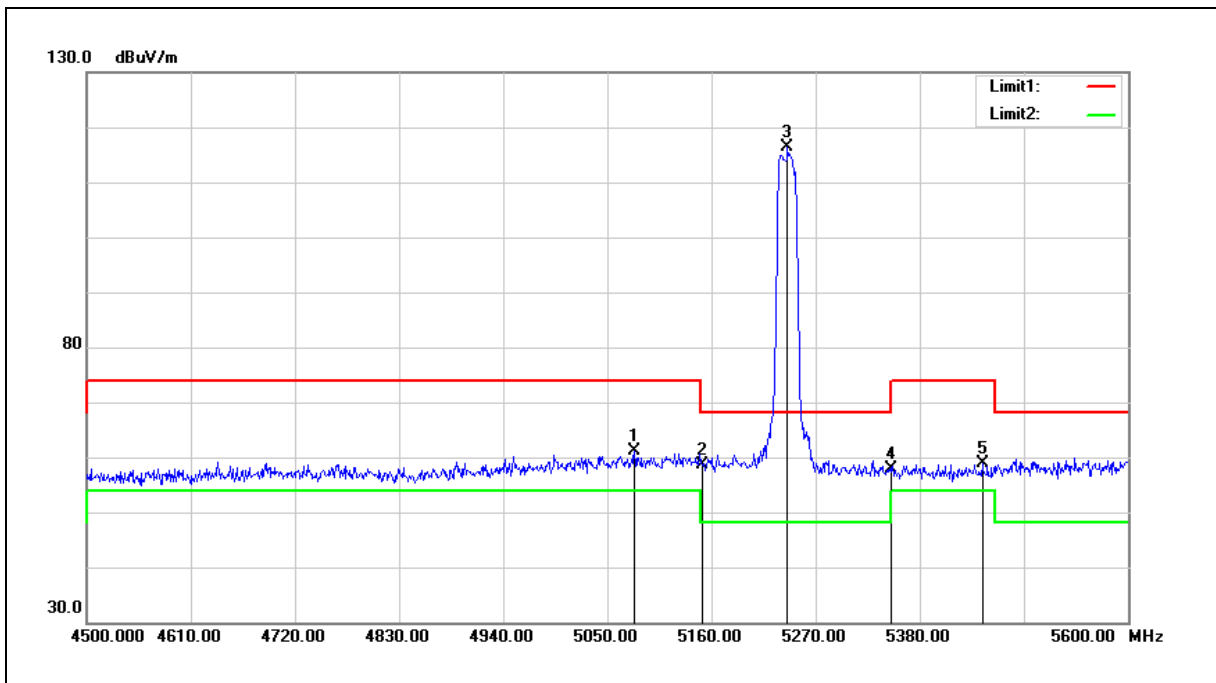

No.	Frequency (MHz)	Reading (dBuV)	Correct Factor (dB/m)	Result (dBuV/m)	Limit (dBuV/m)	Margin (dB)	Remark
1	5078.600	61.26	-0.21	61.05	74.00	-12.95	peak
2	5150.000	58.81	-0.08	58.73	74.00	-15.27	peak
3	5240.300	116.19	0.09	116.28	--	--	peak
4	5350.000	57.49	0.30	57.79	74.00	-16.21	peak
5	5446.000	58.40	0.48	58.88	74.00	-15.12	peak

Note:1.Result (dBuV/m) = Correct Factor (dB/m) + Reading(dBuV).

2.Correction factor (dB/m) = Antenna Factor (dB/m) + Cable loss (dB) – Pre-Amplifier gain (dB).

3.When the peak results are less than average limit, so not need to evaluate the average.

Standard:	FCC Part 15.407	Test Distance:	3 m
Test item:	Band edge		
Frequency:	5260 MHz		
Mode:	Mode 8		
Ant.Polar.:	Horizontal		

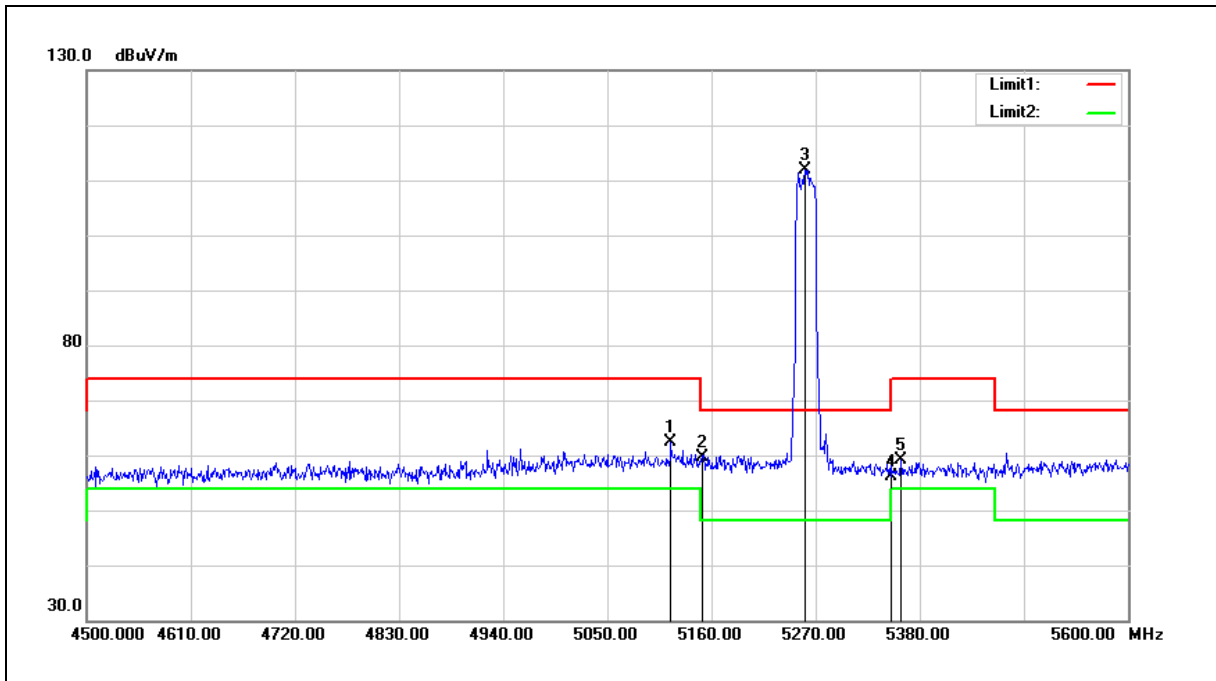

No.	Frequency (MHz)	Reading (dBuV)	Correct Factor (dB/m)	Result (dBuV/m)	Limit (dBuV/m)	Margin (dB)	Remark
1	5117.100	62.50	-0.14	62.36	74.00	-11.64	peak
2	5150.000	59.69	-0.08	59.61	74.00	-14.39	peak
3	5259.000	111.80	0.13	111.93	--	--	peak
4	5350.000	55.76	0.30	56.06	74.00	-17.94	peak
5	5360.200	58.77	0.31	59.08	74.00	-14.92	peak

Note:1.Result (dBuV/m) = Correct Factor (dB/m) + Reading(dBuV).

2.Correction factor (dB/m) = Antenna Factor (dB/m) + Cable loss (dB) – Pre-Amplifier gain (dB).

3.When the peak results are less than average limit, so not need to evaluate the average.

Standard:	FCC Part 15.407	Test Distance:	3 m
Test item:	Band edge		
Frequency:	5260 MHz		
Mode:	Mode 8		
Ant.Polar.:	Vertical		

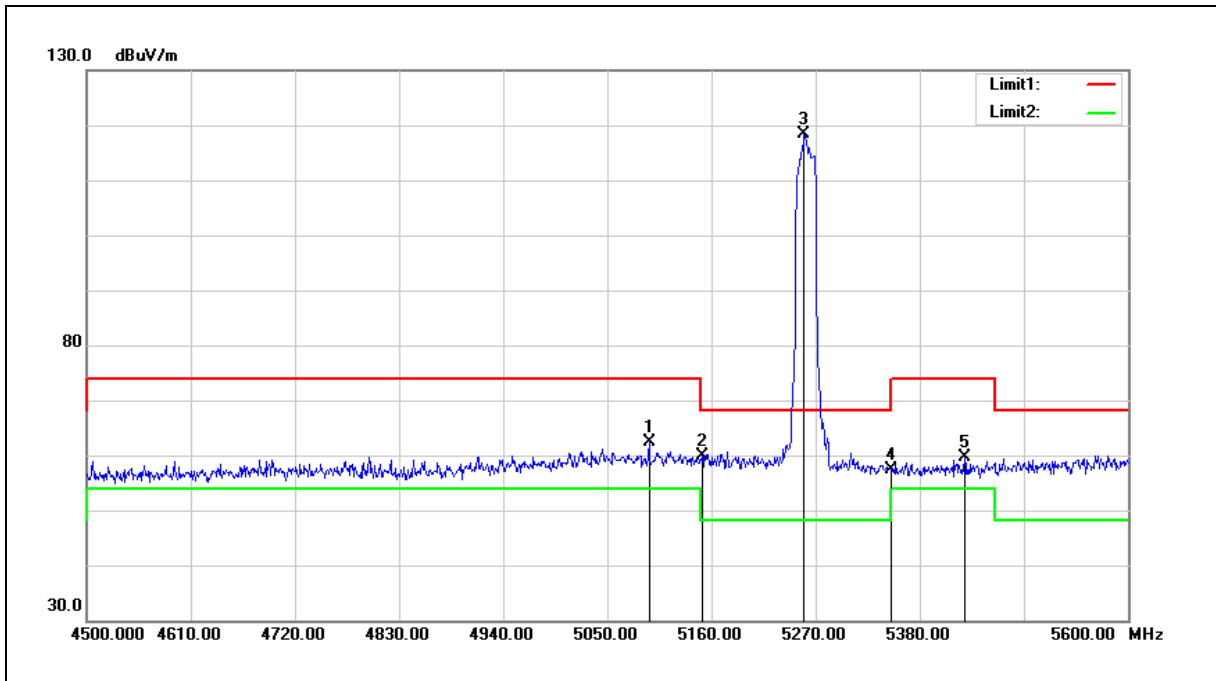

No.	Frequency (MHz)	Reading (dBuV)	Correct Factor (dB/m)	Result (dBuV/m)	Limit (dBuV/m)	Margin (dB)	Remark
1	5094.000	62.68	-0.18	62.50	74.00	-11.50	peak
2	5150.000	59.84	-0.08	59.76	74.00	-14.24	peak
3	5257.900	118.13	0.13	118.26	--	--	peak
4	5350.000	57.17	0.30	57.47	74.00	-16.53	peak
5	5427.300	59.27	0.44	59.71	74.00	-14.29	peak

Note:1.Result (dBuV/m) = Correct Factor (dB/m) + Reading(dBuV).

2.Correction factor (dB/m) = Antenna Factor (dB/m) + Cable loss (dB) – Pre-Amplifier gain (dB).

3.When the peak results are less than average limit, so not need to evaluate the average.

Standard:	FCC Part 15.407	Test Distance:	3 m
Test item:	Band edge		
Frequency:	5280 MHz		
Mode:	Mode 8		
Ant.Polar.:	Horizontal		

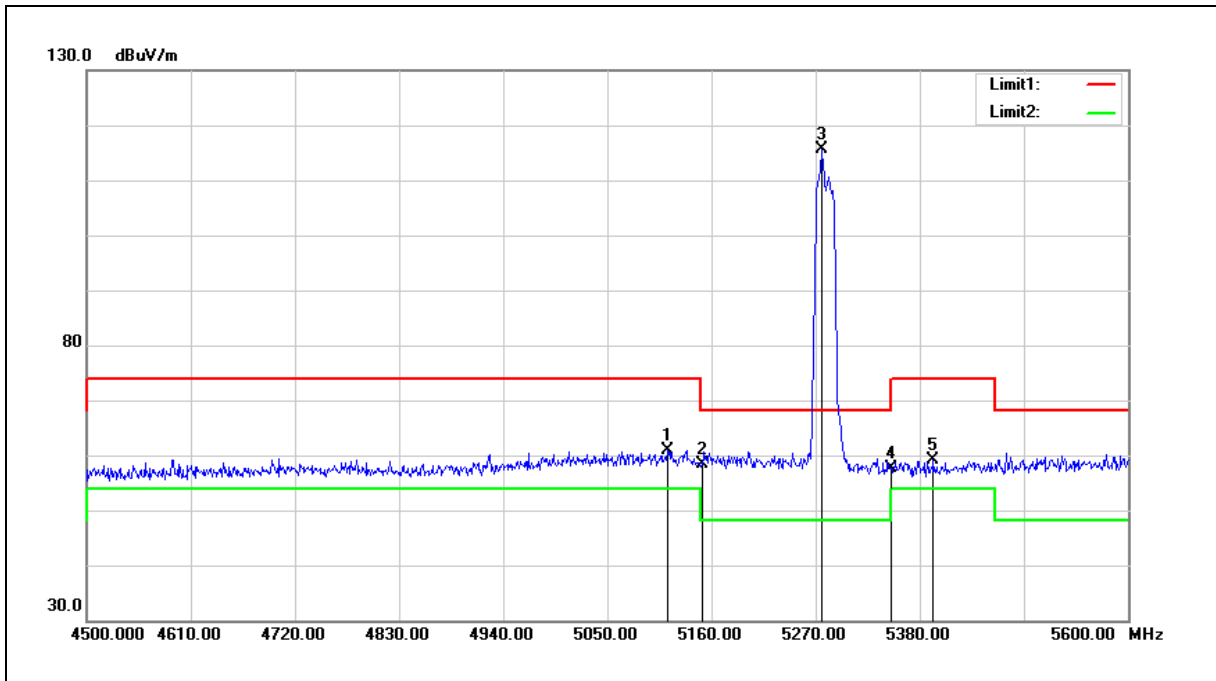

No.	Frequency (MHz)	Reading (dBuV)	Correct Factor (dB/m)	Result (dBuV/m)	Limit (dBuV/m)	Margin (dB)	Remark
1	5113.800	61.07	-0.15	60.92	74.00	-13.08	peak
2	5150.000	58.39	-0.08	58.31	74.00	-15.69	peak
3	5276.600	115.55	0.15	115.70	--	--	peak
4	5350.000	57.22	0.30	57.52	74.00	-16.48	peak
5	5394.300	58.81	0.38	59.19	74.00	-14.81	peak

Note:1.Result (dBuV/m) = Correct Factor (dB/m) + Reading(dBuV).

2.Correction factor (dB/m) = Antenna Factor (dB/m) + Cable loss (dB) – Pre-Amplifier gain (dB).

3.When the peak results are less than average limit, so not need to evaluate the average.

Standard:	FCC Part 15.407	Test Distance:	3 m
Test item:	Band edge		
Frequency:	5280 MHz		
Mode:	Mode 8		
Ant.Polar.:	Vertical		

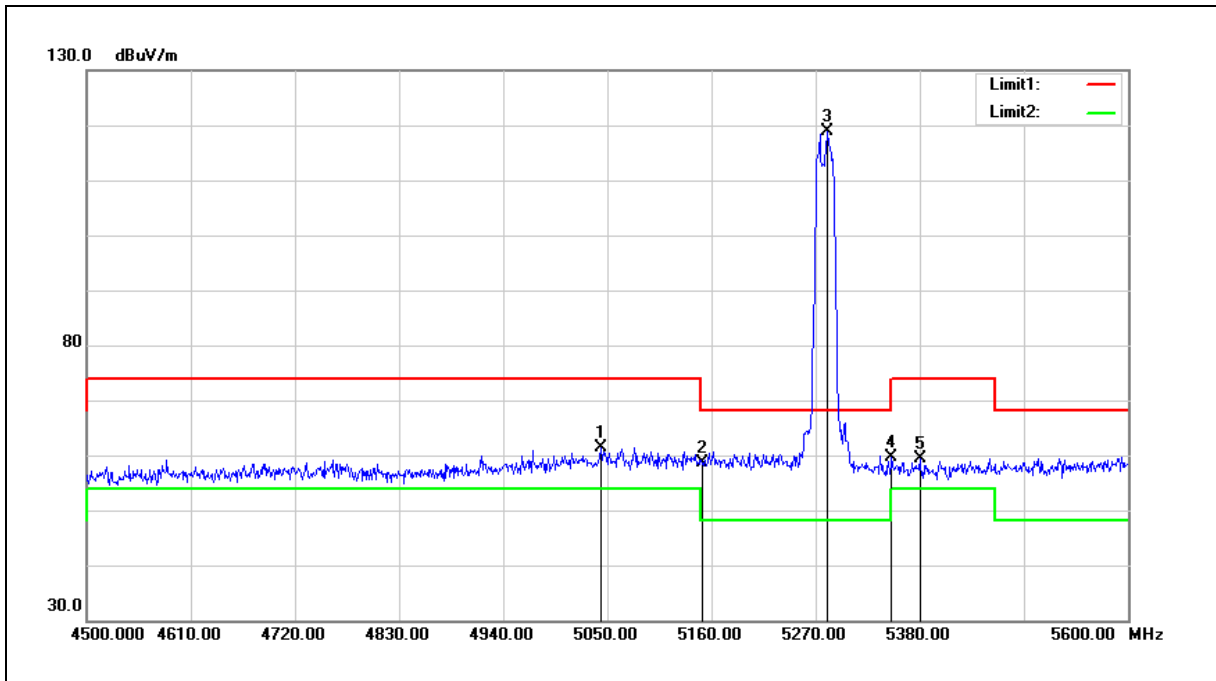

No.	Frequency (MHz)	Reading (dBuV)	Correct Factor (dB/m)	Result (dBuV/m)	Limit (dBuV/m)	Margin (dB)	Remark
1	5043.400	61.75	-0.29	61.46	74.00	-12.54	peak
2	5150.000	58.76	-0.08	58.68	74.00	-15.32	peak
3	5282.100	118.67	0.18	118.85	--	--	peak
4	5350.000	59.33	0.30	59.63	74.00	-14.37	peak
5	5380.000	59.03	0.35	59.38	74.00	-14.62	peak

Note:1.Result (dBuV/m) = Correct Factor (dB/m) + Reading(dBuV).

2.Correction factor (dB/m) = Antenna Factor (dB/m) + Cable loss (dB) – Pre-Amplifier gain (dB).

3.When the peak results are less than average limit, so not need to evaluate the average.

Standard:	FCC Part 15.407	Test Distance:	3 m
Test item:	Band edge		
Frequency:	5320 MHz		
Mode:	Mode 8		
Ant.Polar.:	Horizontal		

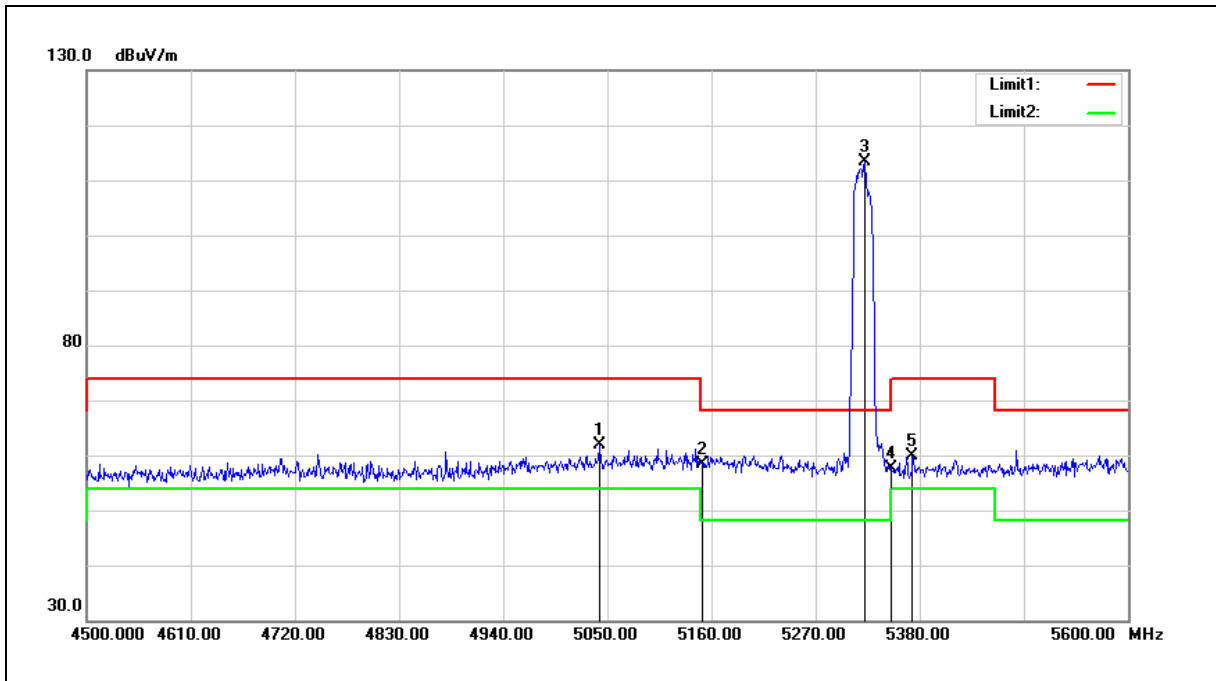

No.	Frequency (MHz)	Reading (dBuV)	Correct Factor (dB/m)	Result (dBuV/m)	Limit (dBuV/m)	Margin (dB)	Remark
1	5041.200	62.09	-0.29	61.80	74.00	-12.20	peak
2	5150.000	58.44	-0.08	58.36	74.00	-15.64	peak
3	5321.700	113.23	0.24	113.47	--	--	peak
4	5350.000	57.29	0.30	57.59	74.00	-16.41	peak
5	5372.300	59.43	0.34	59.77	74.00	-14.23	peak

Note:1.Result (dBuV/m) = Correct Factor (dB/m) + Reading(dBuV).

2.Correction factor (dB/m) = Antenna Factor (dB/m) + Cable loss (dB) – Pre-Amplifier gain (dB).

3.When the peak results are less than average limit, so not need to evaluate the average.

Standard:	FCC Part 15.407	Test Distance:	3 m
Test item:	Band edge		
Frequency:	5320 MHz		
Mode:	Mode 8		
Ant.Polar.:	Vertical		

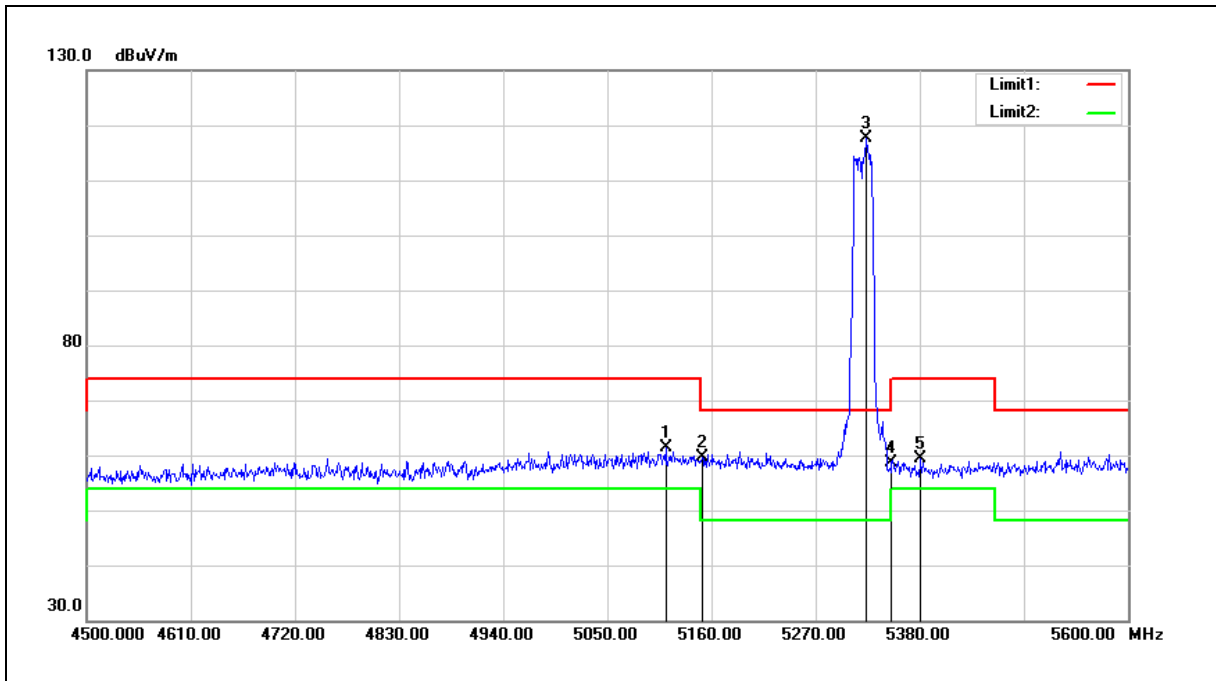

No.	Frequency (MHz)	Reading (dBuV)	Correct Factor (dB/m)	Result (dBuV/m)	Limit (dBuV/m)	Margin (dB)	Remark
1	5111.600	61.54	-0.15	61.39	74.00	-12.61	peak
2	5150.000	59.78	-0.08	59.70	74.00	-14.30	peak
3	5323.900	117.44	0.25	117.69	--	--	peak
4	5350.000	58.35	0.30	58.65	74.00	-15.35	peak
5	5381.100	59.04	0.35	59.39	74.00	-14.61	peak

Note:1.Result (dBuV/m) = Correct Factor (dB/m) + Reading(dBuV).

2.Correction factor (dB/m) = Antenna Factor (dB/m) + Cable loss (dB) – Pre-Amplifier gain (dB).

3.When the peak results are less than average limit, so not need to evaluate the average.

Standard:	FCC Part 15.407	Test Distance:	3 m
Test item:	Band edge		
Frequency:	5500 MHz		
Mode:	Mode 8		
Ant.Polar.:	Horizontal		

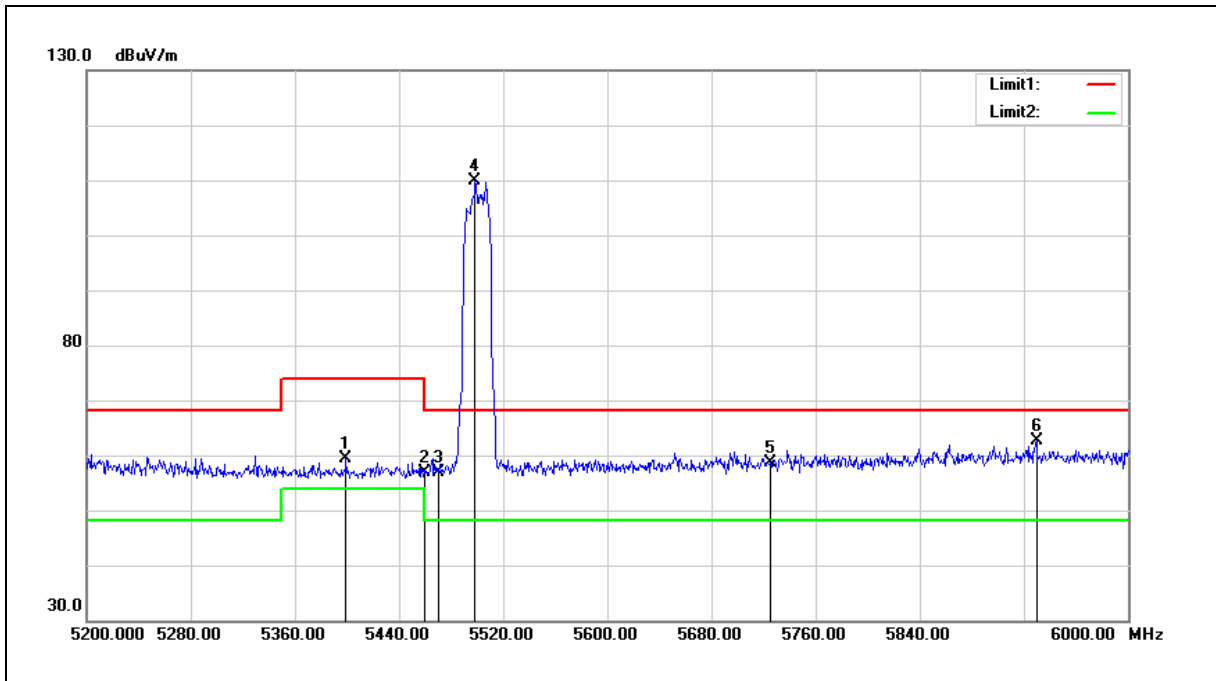

No.	Frequency (MHz)	Reading (dBuV)	Correct Factor (dB/m)	Result (dBuV/m)	Limit (dBuV/m)	Margin (dB)	Remark
1	5399.200	58.90	0.39	59.29	74.00	-14.71	peak
2	5460.000	56.34	0.51	56.85	74.00	-17.15	peak
3	5470.000	56.46	0.52	56.98	68.20	-11.22	peak
4	5498.400	109.36	0.57	109.93	--	--	peak
5	5725.000	57.43	1.18	58.61	68.20	-9.59	peak
6	5929.600	60.84	1.74	62.58	68.20	-5.62	peak

Note: 1. Result (dBuV/m) = Correct Factor (dB/m) + Reading(dBuV).

2. Correction factor (dB/m) = Antenna Factor (dB/m) + Cable loss (dB) – Pre-Amplifier gain (dB).

3. When the peak results are less than average limit, so not need to evaluate the average.

Standard:	FCC Part 15.407	Test Distance:	3 m
Test item:	Band edge		
Frequency:	5500 MHz		
Mode:	Mode 8		
Ant.Polar.:	Vertical		

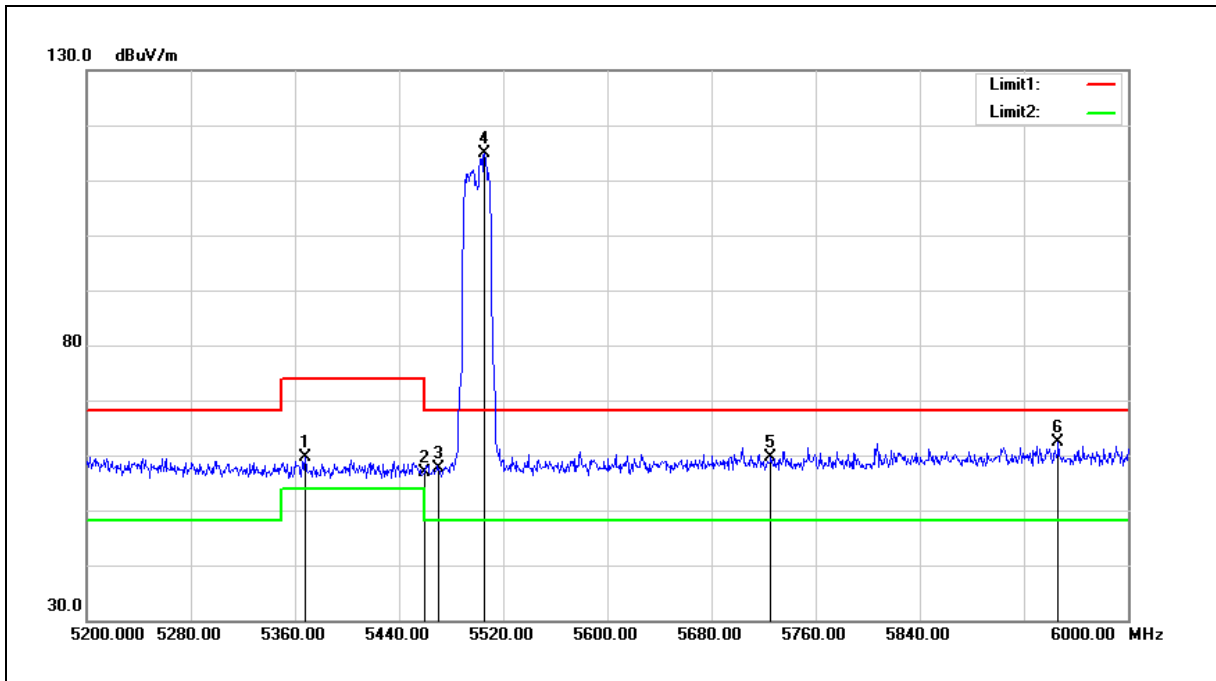

No.	Frequency (MHz)	Reading (dBuV)	Correct Factor (dB/m)	Result (dBuV/m)	Limit (dBuV/m)	Margin (dB)	Remark
1	5368.000	59.25	0.33	59.58	74.00	-14.42	peak
2	5460.000	56.37	0.51	56.88	74.00	-17.12	peak
3	5470.000	57.19	0.52	57.71	68.20	-10.49	peak
4	5505.600	114.22	0.59	114.81	--	--	peak
5	5725.000	58.51	1.18	59.69	68.20	-8.51	peak
6	5946.400	60.69	1.78	62.47	68.20	-5.73	peak

Note:1.Result (dBuV/m) = Correct Factor (dB/m) + Reading(dBuV).

2.Correction factor (dB/m) = Antenna Factor (dB/m) + Cable loss (dB) – Pre-Amplifier gain (dB).

3.When the peak results are less than average limit, so not need to evaluate the average.

Standard:	FCC Part 15.407	Test Distance:	3 m
Test item:	Band edge		
Frequency:	5560 MHz		
Mode:	Mode 8		
Ant.Polar.:	Horizontal		

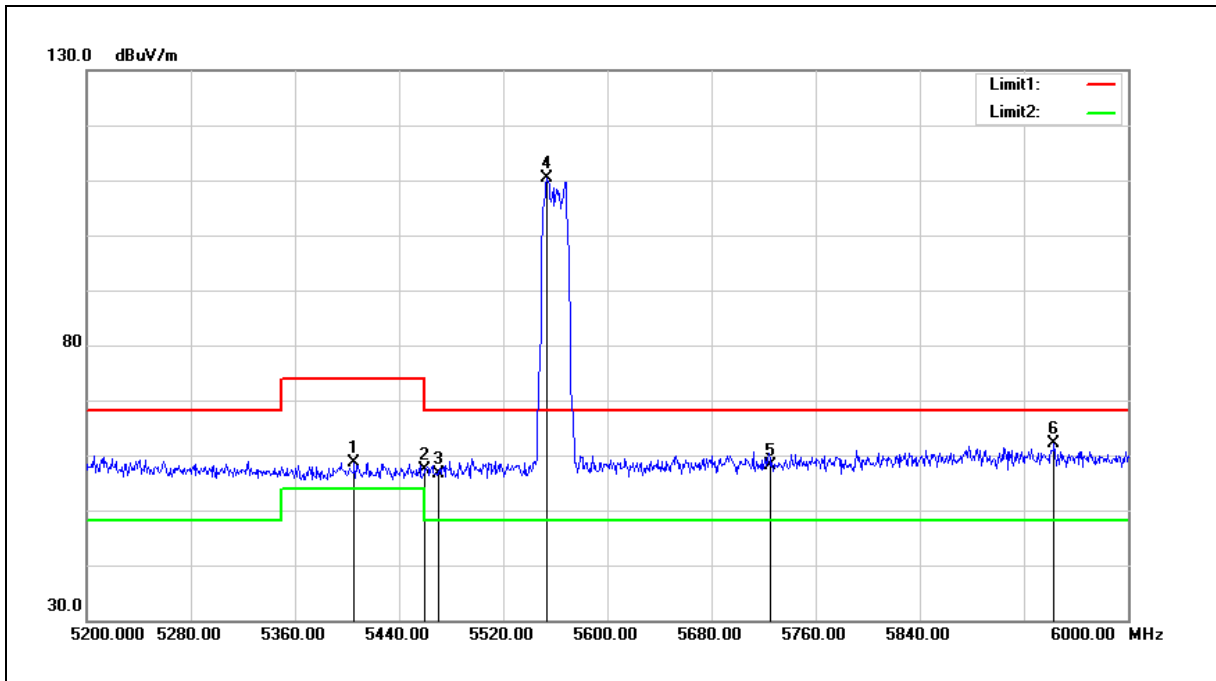

No.	Frequency (MHz)	Reading (dBuV)	Correct Factor (dB/m)	Result (dBuV/m)	Limit (dBuV/m)	Margin (dB)	Remark
1	5405.600	58.32	0.40	58.72	74.00	-15.28	peak
2	5460.000	56.95	0.51	57.46	74.00	-16.54	peak
3	5470.000	55.99	0.52	56.51	68.20	-11.69	peak
4	5553.600	109.73	0.71	110.44	--	--	peak
5	5725.000	57.02	1.18	58.20	68.20	-10.00	peak
6	5943.200	60.24	1.77	62.01	68.20	-6.19	peak

Note: 1. Result (dBuV/m) = Correct Factor (dB/m) + Reading(dBuV).

2. Correction factor (dB/m) = Antenna Factor (dB/m) + Cable loss (dB) – Pre-Amplifier gain (dB).

3. When the peak results are less than average limit, so not need to evaluate the average.

Standard:	FCC Part 15.407	Test Distance:	3 m
Test item:	Band edge		
Frequency:	5560 MHz		
Mode:	Mode 8		
Ant.Polar.:	Vertical		

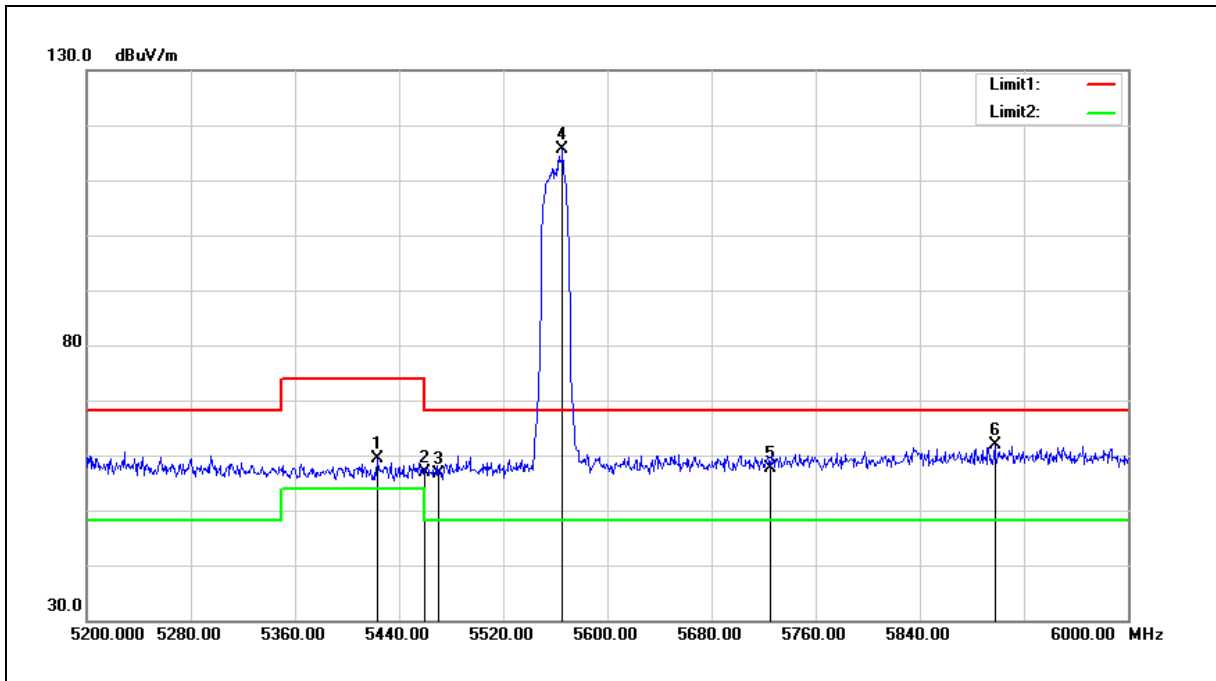

No.	Frequency (MHz)	Reading (dBuV)	Correct Factor (dB/m)	Result (dBuV/m)	Limit (dBuV/m)	Margin (dB)	Remark
1	5423.200	58.94	0.43	59.37	74.00	-14.63	peak
2	5460.000	56.45	0.51	56.96	74.00	-17.04	peak
3	5470.000	56.15	0.52	56.67	68.20	-11.53	peak
4	5565.600	114.81	0.75	115.56	--	--	peak
5	5725.000	56.33	1.18	57.51	68.20	-10.69	peak
6	5897.600	60.19	1.65	61.84	68.20	-6.36	peak

Note:1.Result (dBuV/m) = Correct Factor (dB/m) + Reading(dBuV).

2.Correction factor (dB/m) = Antenna Factor (dB/m) + Cable loss (dB) – Pre-Amplifier gain (dB).

3.When the peak results are less than average limit, so not need to evaluate the average.

Standard:	FCC Part 15.407	Test Distance:	3 m
Test item:	Band edge		
Frequency:	5700 MHz		
Mode:	Mode 8		
Ant.Polar.:	Horizontal		

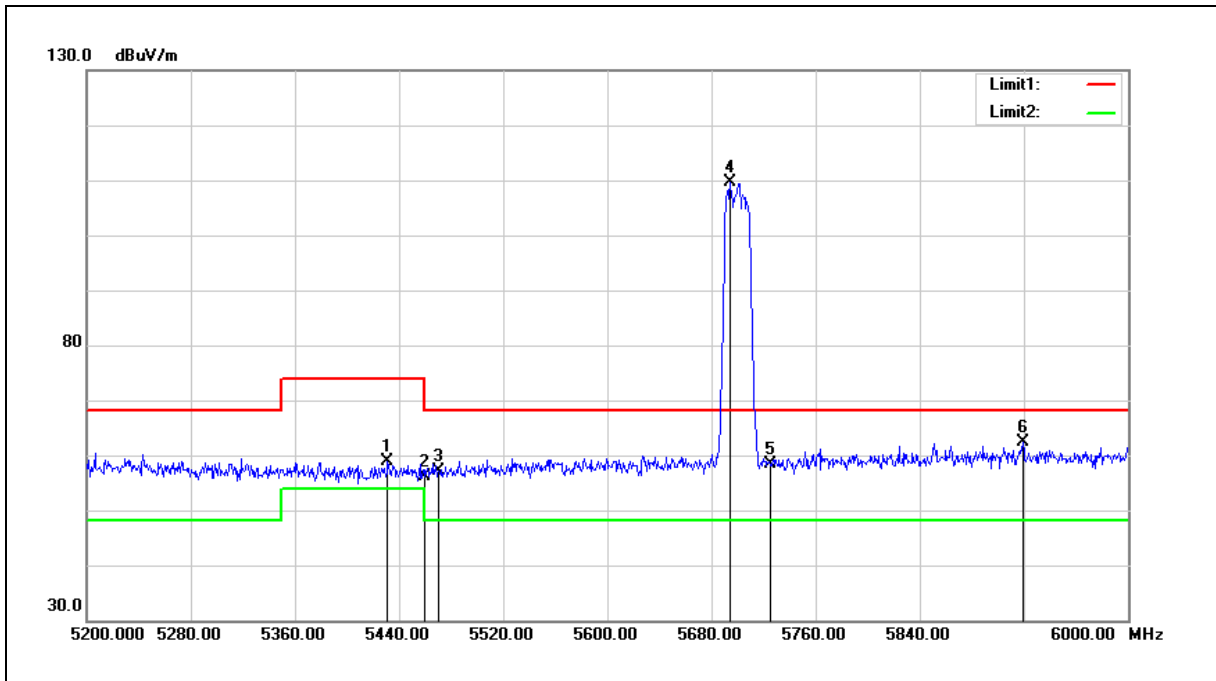

No.	Frequency (MHz)	Reading (dBuV)	Correct Factor (dB/m)	Result (dBuV/m)	Limit (dBuV/m)	Margin (dB)	Remark
1	5431.200	58.40	0.44	58.84	74.00	-15.16	peak
2	5460.000	55.58	0.51	56.09	74.00	-17.91	peak
3	5470.000	56.69	0.52	57.21	68.20	-10.99	peak
4	5694.400	108.59	1.10	109.69	--	--	peak
5	5725.000	57.28	1.18	58.46	68.20	-9.74	peak
6	5919.200	60.65	1.70	62.35	68.20	-5.85	peak

Note: 1. Result (dBuV/m) = Correct Factor (dB/m) + Reading(dBuV).

2. Correction factor (dB/m) = Antenna Factor (dB/m) + Cable loss (dB) – Pre-Amplifier gain (dB).

3. When the peak results are less than average limit, so not need to evaluate the average.

Standard:	FCC Part 15.407	Test Distance:	3 m
Test item:	Band edge		
Frequency:	5700 MHz		
Mode:	Mode 8		
Ant.Polar.:	Vertical		

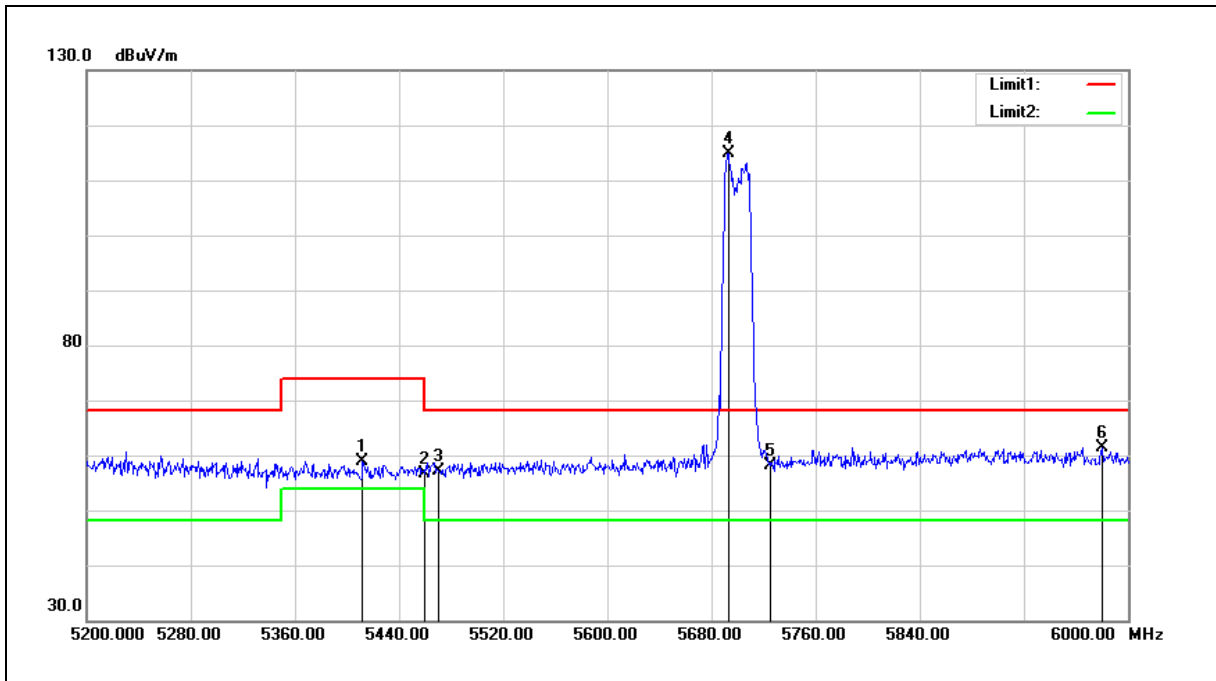

No.	Frequency (MHz)	Reading (dBuV)	Correct Factor (dB/m)	Result (dBuV/m)	Limit (dBuV/m)	Margin (dB)	Remark
1	5412.000	58.54	0.41	58.95	74.00	-15.05	peak
2	5460.000	56.23	0.51	56.74	74.00	-17.26	peak
3	5470.000	56.53	0.52	57.05	68.20	-11.15	peak
4	5692.800	113.83	1.10	114.93	--	--	peak
5	5725.000	56.86	1.18	58.04	68.20	-10.16	peak
6	5980.000	59.52	1.87	61.39	68.20	-6.81	peak

Note: 1. Result (dBuV/m) = Correct Factor (dB/m) + Reading(dBuV).

2. Correction factor (dB/m) = Antenna Factor (dB/m) + Cable loss (dB) – Pre-Amplifier gain (dB).

3. When the peak results are less than average limit, so not need to evaluate the average.

Standard:	FCC Part 15.407	Test Distance:	3 m
Test item:	Band edge		
Frequency:	5745 MHz		
Mode:	Mode 8		
Ant.Polar.:	Horizontal		

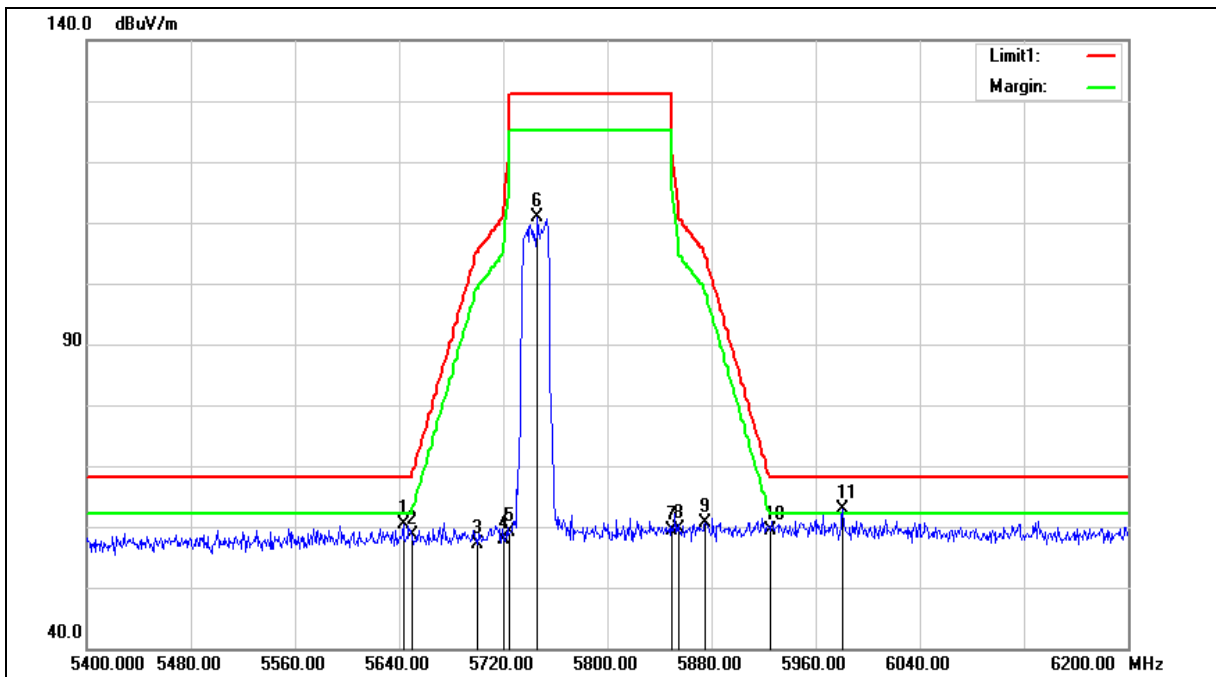

Standard:	FCC Part 15.407	Test Distance:	3 m
Test item:	Band edge		
Frequency:	5745 MHz		
Mode:	Mode 8		
Ant.Polar.:	Horizontal		

No.	Frequency (MHz)	Reading (dBuV)	Correct Factor (dB/m)	Result (dBuV/m)	Limit (dBuV/m)	Margin (dB)	Remark
1	5643.200	59.49	0.96	60.45	68.20	-7.75	peak
2	5650.000	57.73	0.97	58.70	68.20	-9.50	peak
3	5700.000	56.09	1.11	57.20	105.20	-48.00	peak
4	5720.000	56.80	1.17	57.97	110.80	-52.83	peak
5	5725.000	57.94	1.18	59.12	122.20	-63.08	peak
6	5746.400	109.57	1.24	110.81	--	--	peak
7	5850.000	57.79	1.52	59.31	122.20	-62.89	peak
8	5855.000	58.21	1.53	59.74	110.80	-51.06	peak
9	5875.000	59.11	1.59	60.70	105.20	-44.50	peak
10	5925.000	57.58	1.72	59.30	68.20	-8.90	peak
11	5980.800	60.92	1.88	62.80	68.20	-5.40	peak

Note:1.Result (dBuV/m) = Correct Factor (dB/m) + Reading(dBuV).

2.Correction factor (dB/m) = Antenna Factor (dB/m) + Cable loss (dB) – Pre-Amplifier gain (dB).

3.When the peak results are less than average limit, so not need to evaluate the average.

Standard:	FCC Part 15.407	Test Distance:	3 m
Test item:	Band edge		
Frequency:	5745 MHz		
Mode:	Mode 8		
Ant.Polar.:	Vertical		

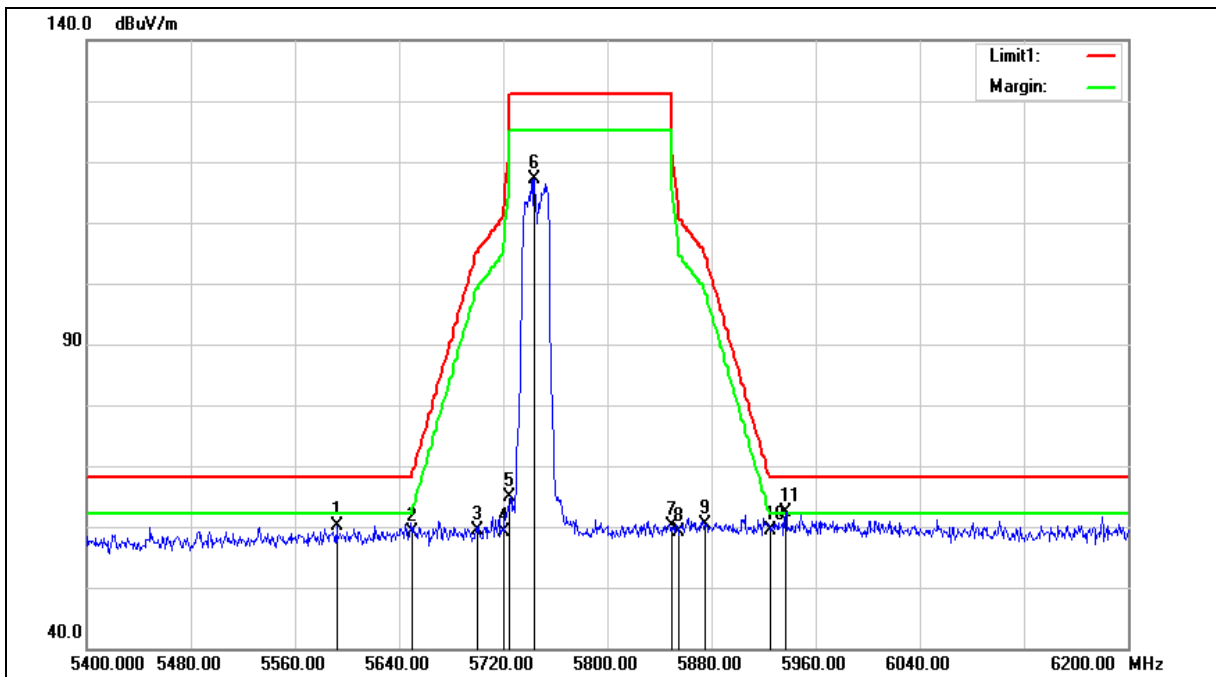

Standard:	FCC Part 15.407	Test Distance:	3 m
Test item:	Band edge		
Frequency:	5745 MHz		
Mode:	Mode 8		
Ant.Polar.:	Vertical		

No.	Frequency (MHz)	Reading (dBuV)	Correct Factor (dB/m)	Result (dBuV/m)	Limit (dBuV/m)	Margin (dB)	Remark
1	5592.000	59.34	0.82	60.16	68.20	-8.04	peak
2	5650.000	58.12	0.97	59.09	68.20	-9.11	peak
3	5700.000	58.34	1.11	59.45	105.20	-45.75	peak
4	5720.000	57.95	1.17	59.12	110.80	-51.68	peak
5	5725.000	63.62	1.18	64.80	122.20	-57.40	peak
6	5744.000	115.94	1.23	117.17	--	--	peak
7	5850.000	58.50	1.52	60.02	122.20	-62.18	peak
8	5855.000	57.72	1.53	59.25	110.80	-51.55	peak
9	5875.000	58.90	1.59	60.49	105.20	-44.71	peak
10	5925.000	57.75	1.72	59.47	68.20	-8.73	peak
11	5936.800	60.63	1.74	62.37	68.20	-5.83	peak

Note:1.Result (dBuV/m) = Correct Factor (dB/m) + Reading(dBuV).

2.Correction factor (dB/m) = Antenna Factor (dB/m) + Cable loss (dB) – Pre-Amplifier gain (dB).

3.When the peak results are less than average limit, so not need to evaluate the average.

Standard:	FCC Part 15.407	Test Distance:	3 m
Test item:	Band edge		
Frequency:	5785 MHz		
Mode:	Mode 8		
Ant.Polar.:	Horizontal		

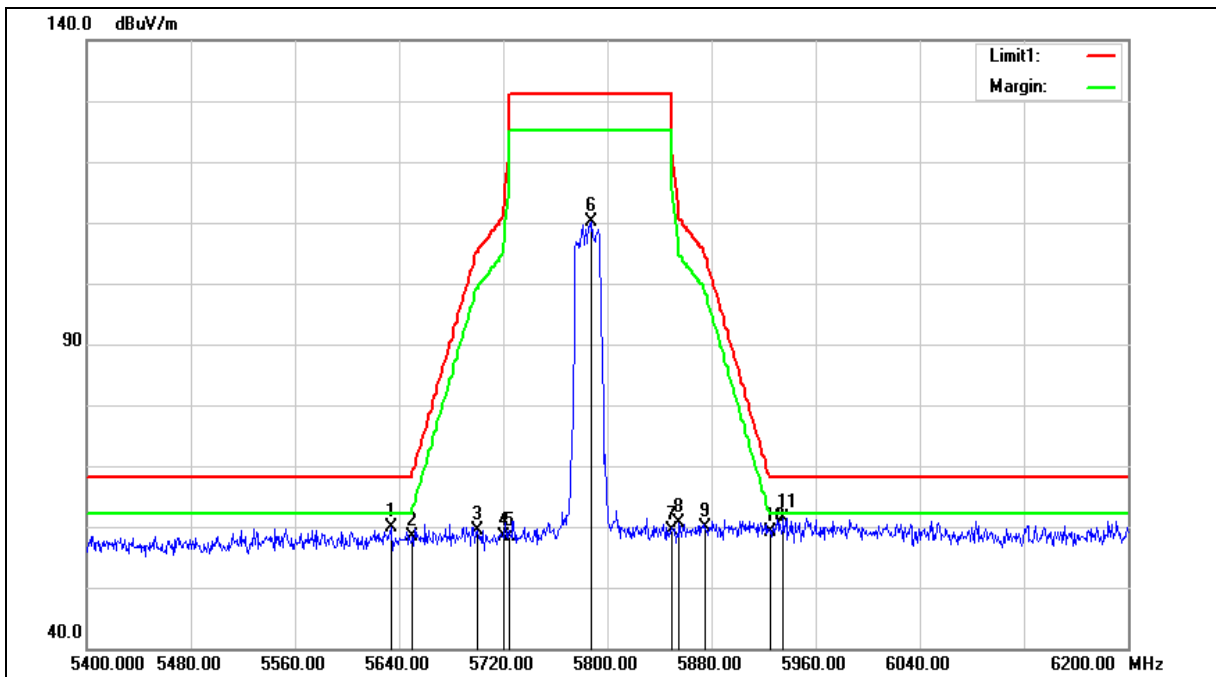

Standard:	FCC Part 15.407	Test Distance:	3 m
Test item:	Band edge		
Frequency:	5785 MHz		
Mode:	Mode 8		
Ant.Polar.:	Horizontal		

No.	Frequency (MHz)	Reading (dBuV)	Correct Factor (dB/m)	Result (dBuV/m)	Limit (dBuV/m)	Margin (dB)	Remark
1	5633.600	58.90	0.93	59.83	68.20	-8.37	peak
2	5650.000	57.36	0.97	58.33	68.20	-9.87	peak
3	5700.000	58.19	1.11	59.30	105.20	-45.90	peak
4	5720.000	57.32	1.17	58.49	110.80	-52.31	peak
5	5725.000	57.17	1.18	58.35	122.20	-63.85	peak
6	5788.000	108.74	1.36	110.10	--	--	peak
7	5850.000	57.87	1.52	59.39	122.20	-62.81	peak
8	5855.000	59.02	1.53	60.55	110.80	-50.25	peak
9	5875.000	58.19	1.59	59.78	105.20	-45.42	peak
10	5925.000	57.41	1.72	59.13	68.20	-9.07	peak
11	5935.200	59.61	1.74	61.35	68.20	-6.85	peak

Note:1.Result (dBuV/m) = Correct Factor (dB/m) + Reading(dBuV).

2.Correction factor (dB/m) = Antenna Factor (dB/m) + Cable loss (dB) – Pre-Amplifier gain (dB).

3.When the peak results are less than average limit, so not need to evaluate the average.

Standard:	FCC Part 15.407	Test Distance:	3 m
Test item:	Band edge		
Frequency:	5785 MHz		
Mode:	Mode 8		
Ant.Polar.:	Vertical		

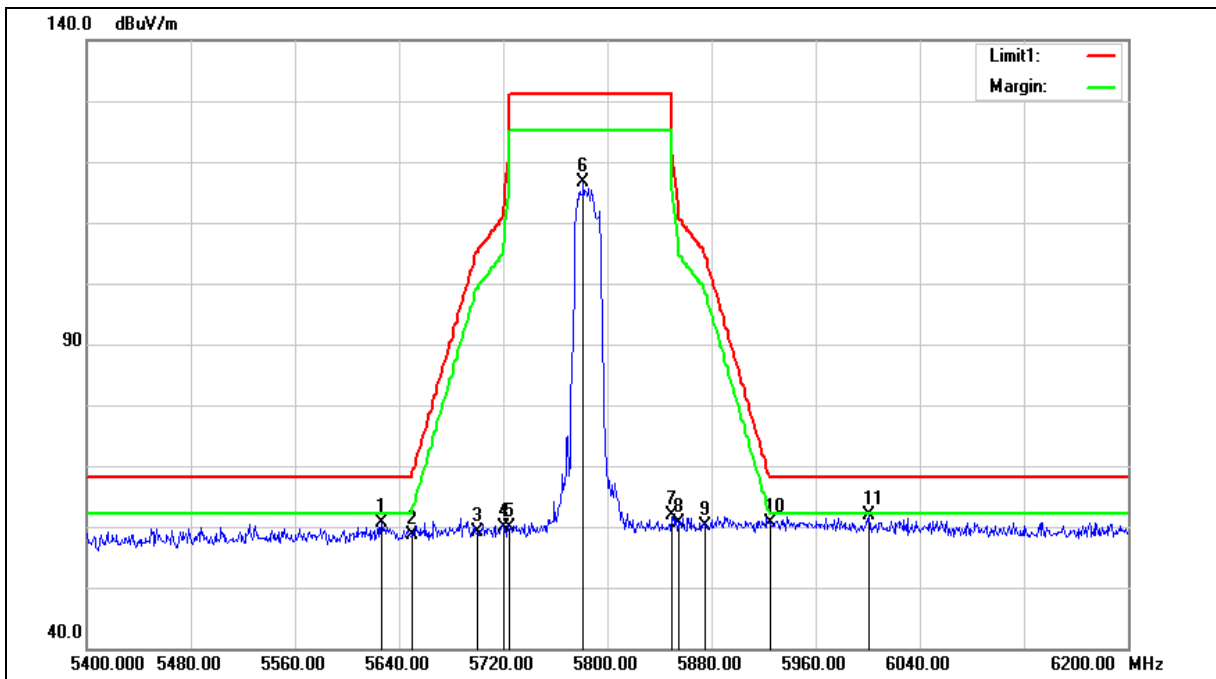

Standard:	FCC Part 15.407	Test Distance:	3 m
Test item:	Band edge		
Frequency:	5785 MHz		
Mode:	Mode 8		
Ant.Polar.:	Vertical		

No.	Frequency (MHz)	Reading (dBuV)	Correct Factor (dB/m)	Result (dBuV/m)	Limit (dBuV/m)	Margin (dB)	Remark
1	5626.400	59.66	0.92	60.58	68.20	-7.62	peak
2	5650.000	57.58	0.97	58.55	68.20	-9.65	peak
3	5700.000	58.02	1.11	59.13	105.20	-46.07	peak
4	5720.000	58.60	1.17	59.77	110.80	-51.03	peak
5	5725.000	58.59	1.18	59.77	122.20	-62.43	peak
6	5781.600	115.26	1.33	116.59	--	--	peak
7	5850.000	60.36	1.52	61.88	122.20	-60.32	peak
8	5855.000	59.09	1.53	60.62	110.80	-50.18	peak
9	5875.000	58.45	1.59	60.04	105.20	-45.16	peak
10	5925.000	58.86	1.72	60.58	68.20	-7.62	peak
11	6000.800	59.98	1.92	61.90	68.20	-6.30	peak

Note:1.Result (dBuV/m) = Correct Factor (dB/m) + Reading(dBuV).

2.Correction factor (dB/m) = Antenna Factor (dB/m) + Cable loss (dB) – Pre-Amplifier gain (dB).

3.When the peak results are less than average limit, so not need to evaluate the average.

Standard:	FCC Part 15.407	Test Distance:	3 m
Test item:	Band edge		
Frequency:	5825 MHz		
Mode:	Mode 8		
Ant.Polar.:	Horizontal		

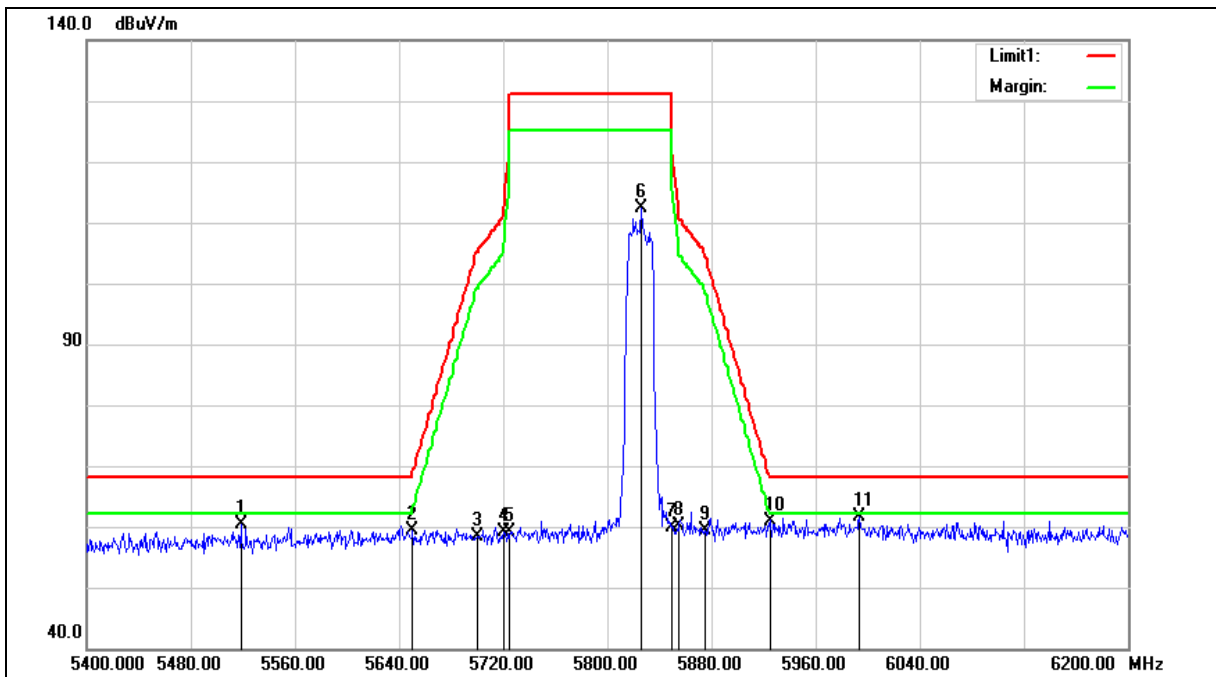

Standard:	FCC Part 15.407	Test Distance:	3 m
Test item:	Band edge		
Frequency:	5825 MHz		
Mode:	Mode 8		
Ant.Polar.:	Horizontal		

No.	Frequency (MHz)	Reading (dBuV)	Correct Factor (dB/m)	Result (dBuV/m)	Limit (dBuV/m)	Margin (dB)	Remark
1	5518.400	59.74	0.62	60.36	68.20	-7.84	peak
2	5650.000	58.43	0.97	59.40	68.20	-8.80	peak
3	5700.000	57.39	1.11	58.50	105.20	-46.70	peak
4	5720.000	57.84	1.17	59.01	110.80	-51.79	peak
5	5725.000	57.90	1.18	59.08	122.20	-63.12	peak
6	5825.600	110.91	1.45	112.36	--	--	peak
7	5850.000	58.32	1.52	59.84	122.20	-62.36	peak
8	5855.000	58.56	1.53	60.09	110.80	-50.71	peak
9	5875.000	57.76	1.59	59.35	105.20	-45.85	peak
10	5925.000	59.27	1.72	60.99	68.20	-7.21	peak
11	5993.600	59.80	1.91	61.71	68.20	-6.49	peak

Note:1.Result (dBuV/m) = Correct Factor (dB/m) + Reading(dBuV).

2.Correction factor (dB/m) = Antenna Factor (dB/m) + Cable loss (dB) – Pre-Amplifier gain (dB).

3.When the peak results are less than average limit, so not need to evaluate the average.

Standard:	FCC Part 15.407	Test Distance:	3 m
Test item:	Band edge		
Frequency:	5825 MHz		
Mode:	Mode 8		
Ant.Polar.:	Vertical		

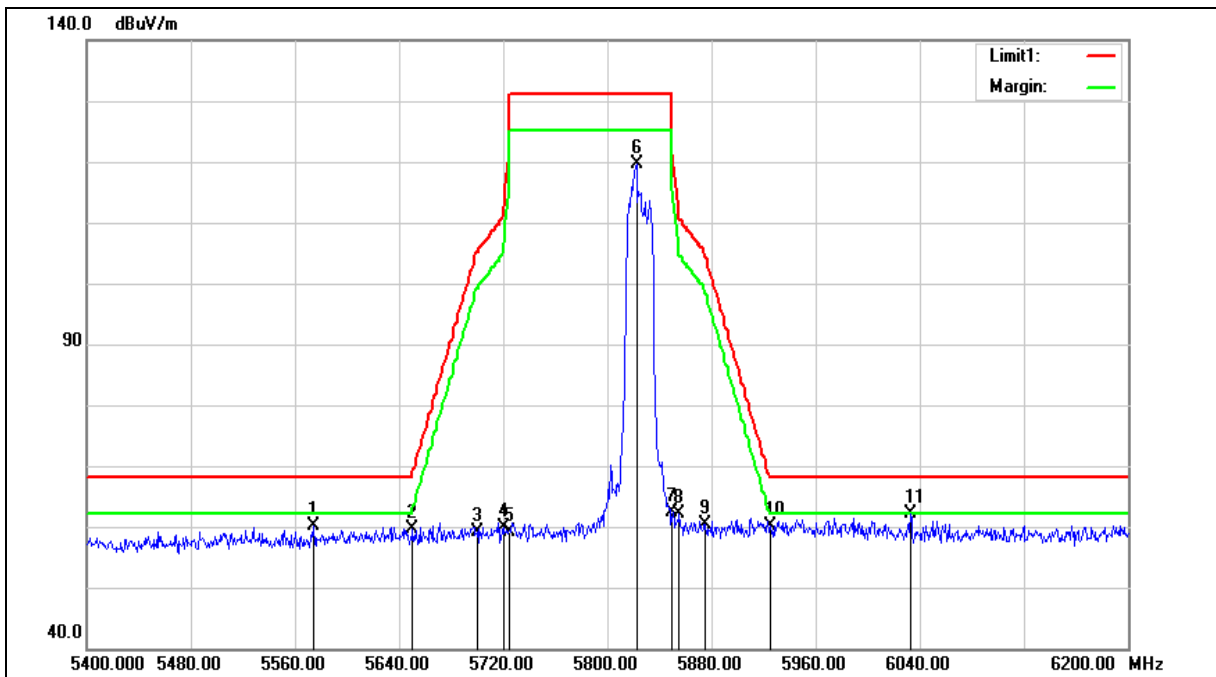

Standard:	FCC Part 15.407	Test Distance:	3 m
Test item:	Band edge		
Frequency:	5825 MHz		
Mode:	Mode 8		
Ant.Polar.:	Vertical		

No.	Frequency (MHz)	Reading (dBuV)	Correct Factor (dB/m)	Result (dBuV/m)	Limit (dBuV/m)	Margin (dB)	Remark
1	5574.400	59.31	0.78	60.09	68.20	-8.11	peak
2	5650.000	58.59	0.97	59.56	68.20	-8.64	peak
3	5700.000	57.97	1.11	59.08	105.20	-46.12	peak
4	5720.000	58.82	1.17	59.99	110.80	-50.81	peak
5	5725.000	57.91	1.18	59.09	122.20	-63.11	peak
6	5822.400	118.17	1.45	119.62	--	--	peak
7	5850.000	60.87	1.52	62.39	122.20	-59.81	peak
8	5855.000	60.55	1.53	62.08	110.80	-48.72	peak
9	5875.000	58.85	1.59	60.44	105.20	-44.76	peak
10	5925.000	58.46	1.72	60.18	68.20	-8.02	peak
11	6032.800	60.06	2.04	62.10	68.20	-6.10	peak

Note:1.Result (dBuV/m) = Correct Factor (dB/m) + Reading(dBuV).

2.Correction factor (dB/m) = Antenna Factor (dB/m) + Cable loss (dB) – Pre-Amplifier gain (dB).

3.When the peak results are less than average limit, so not need to evaluate the average.

Standard:	FCC Part 15.407	Test Distance:	3 m
Test item:	Band edge		
Frequency:	5190 MHz		
Mode:	Mode 9		
Ant.Polar.:	Horizontal		

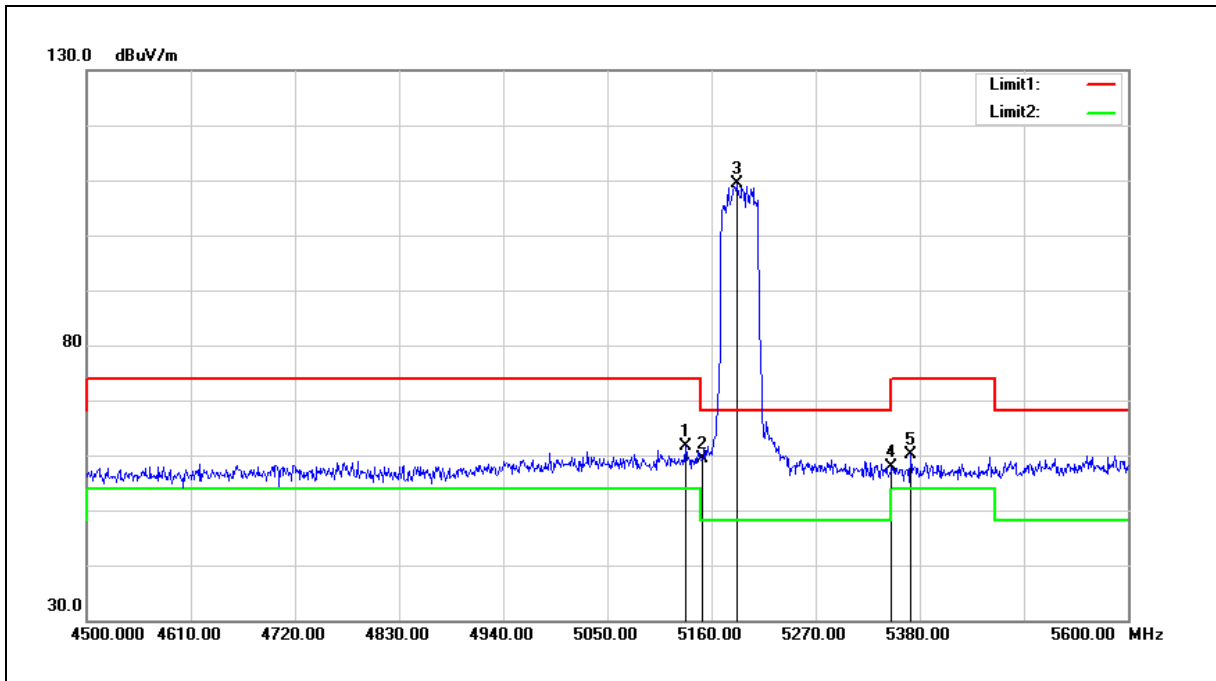

No.	Frequency (MHz)	Reading (dBuV)	Correct Factor (dB/m)	Result (dBuV/m)	Limit (dBuV/m)	Margin (dB)	Remark
1	5132.500	61.73	-0.10	61.63	74.00	-12.37	peak
2	5150.000	59.50	-0.08	59.42	74.00	-14.58	peak
3	5186.400	109.28	-0.01	109.27	--	--	peak
4	5350.000	57.66	0.30	57.96	74.00	-16.04	peak
5	5370.100	59.70	0.34	60.04	74.00	-13.96	peak

Note:1.Result (dBuV/m) = Correct Factor (dB/m) + Reading(dBuV).

2.Correction factor (dB/m) = Antenna Factor (dB/m) + Cable loss (dB) – Pre-Amplifier gain (dB).

3.When the peak results are less than average limit, so not need to evaluate the average.

Standard:	FCC Part 15.407	Test Distance:	3 m
Test item:	Band edge		
Frequency:	5190 MHz		
Mode:	Mode 9		
Ant.Polar.:	Vertical		

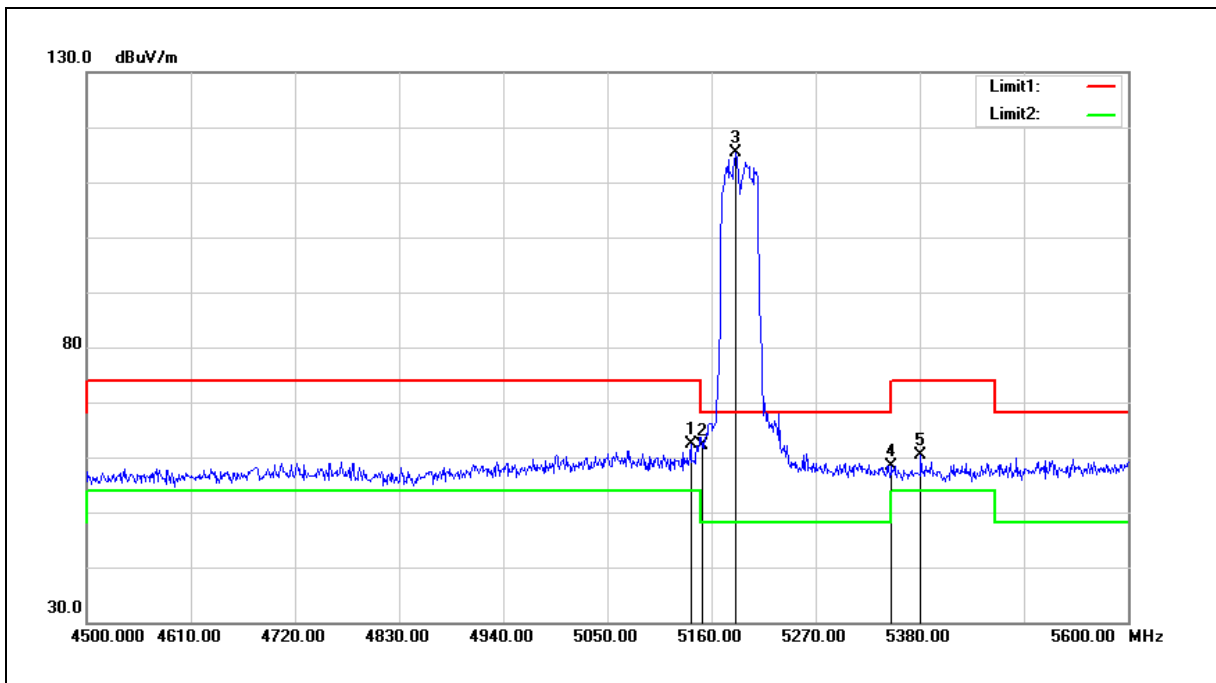

No.	Frequency (MHz)	Reading (dBuV)	Correct Factor (dB/m)	Result (dBuV/m)	Limit (dBuV/m)	Margin (dB)	Remark
1	5138.000	62.36	-0.10	62.26	74.00	-11.74	peak
2	5150.000	62.25	-0.08	62.17	74.00	-11.83	peak
3	5185.300	115.30	-0.01	115.29	--	--	peak
4	5350.000	58.02	0.30	58.32	74.00	-15.68	peak
5	5381.100	59.96	0.35	60.31	74.00	-13.69	peak

Note:1.Result (dBuV/m) = Correct Factor (dB/m) + Reading(dBuV).

2.Correction factor (dB/m) = Antenna Factor (dB/m) + Cable loss (dB) – Pre-Amplifier gain (dB).

3.When the peak results are less than average limit, so not need to evaluate the average.

Standard:	FCC Part 15.407	Test Distance:	3 m
Test item:	Band edge		
Frequency:	5230 MHz		
Mode:	Mode 9		
Ant.Polar.:	Horizontal		

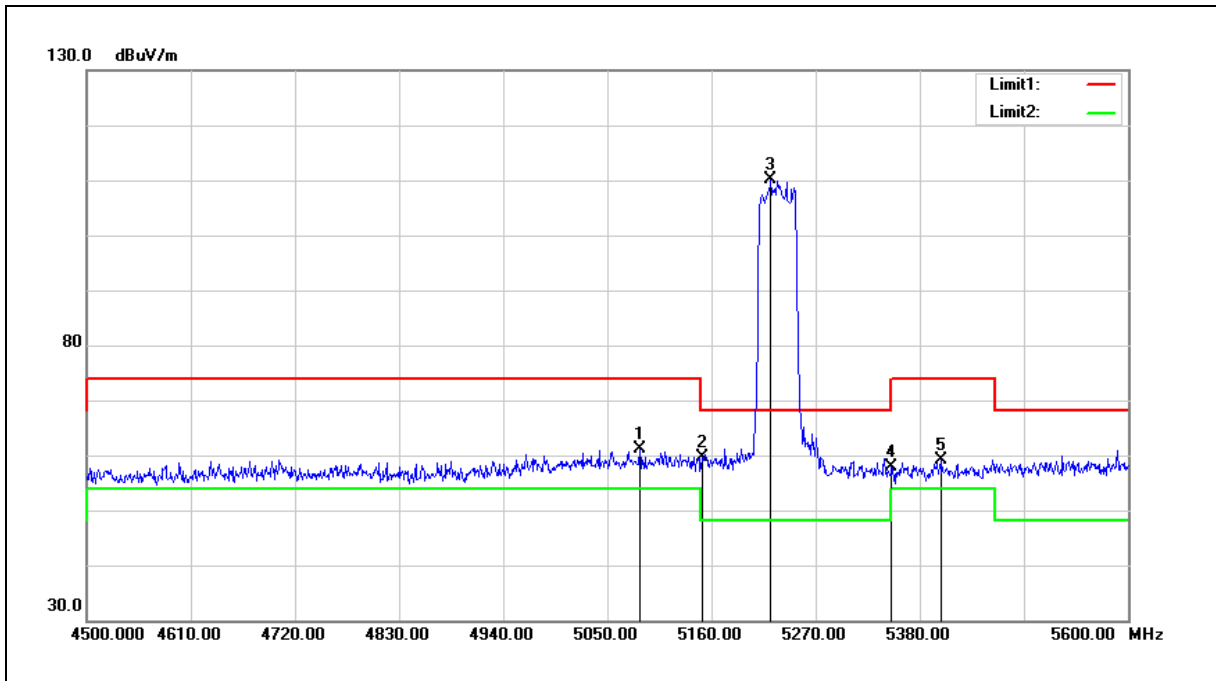

No.	Frequency (MHz)	Reading (dBuV)	Correct Factor (dB/m)	Result (dBuV/m)	Limit (dBuV/m)	Margin (dB)	Remark
1	5084.100	61.29	-0.20	61.09	74.00	-12.91	peak
2	5150.000	59.81	-0.08	59.73	74.00	-14.27	peak
3	5222.700	110.11	0.06	110.17	--	--	peak
4	5350.000	57.47	0.30	57.77	74.00	-16.23	peak
5	5403.100	58.72	0.39	59.11	74.00	-14.89	peak

Note:1.Result (dBuV/m) = Correct Factor (dB/m) + Reading(dBuV).

2.Correction factor (dB/m) = Antenna Factor (dB/m) + Cable loss (dB) – Pre-Amplifier gain (dB).

3.When the peak results are less than average limit, so not need to evaluate the average.

Standard:	FCC Part 15.407	Test Distance:	3 m
Test item:	Band edge		
Frequency:	5230 MHz		
Mode:	Mode 9		
Ant.Polar.:	Vertical		

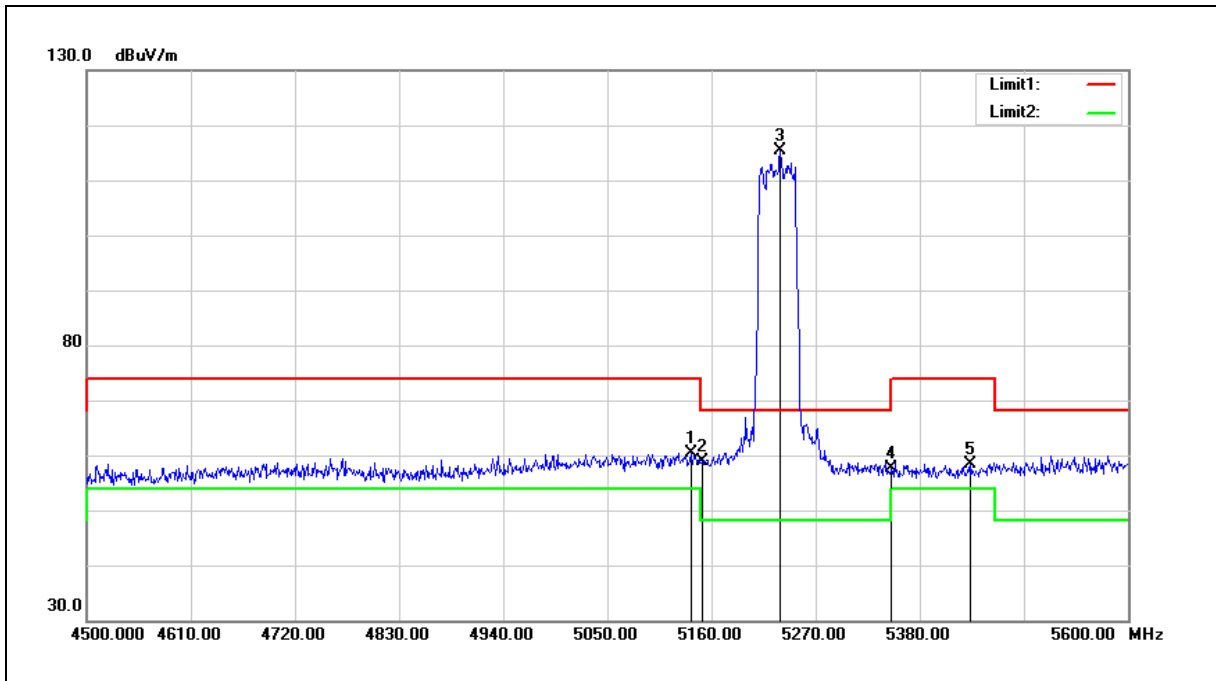

No.	Frequency (MHz)	Reading (dBuV)	Correct Factor (dB/m)	Result (dBuV/m)	Limit (dBuV/m)	Margin (dB)	Remark
1	5138.000	60.51	-0.10	60.41	74.00	-13.59	peak
2	5150.000	58.89	-0.08	58.81	74.00	-15.19	peak
3	5232.600	115.26	0.08	115.34	--	--	peak
4	5350.000	57.23	0.30	57.53	74.00	-16.47	peak
5	5433.900	57.93	0.46	58.39	74.00	-15.61	peak

Note:1.Result (dBuV/m) = Correct Factor (dB/m) + Reading(dBuV).

2.Correction factor (dB/m) = Antenna Factor (dB/m) + Cable loss (dB) – Pre-Amplifier gain (dB).

3.When the peak results are less than average limit, so not need to evaluate the average.

Standard:	FCC Part 15.407	Test Distance:	3 m
Test item:	Band edge		
Frequency:	5270 MHz		
Mode:	Mode 9		
Ant.Polar.:	Horizontal		

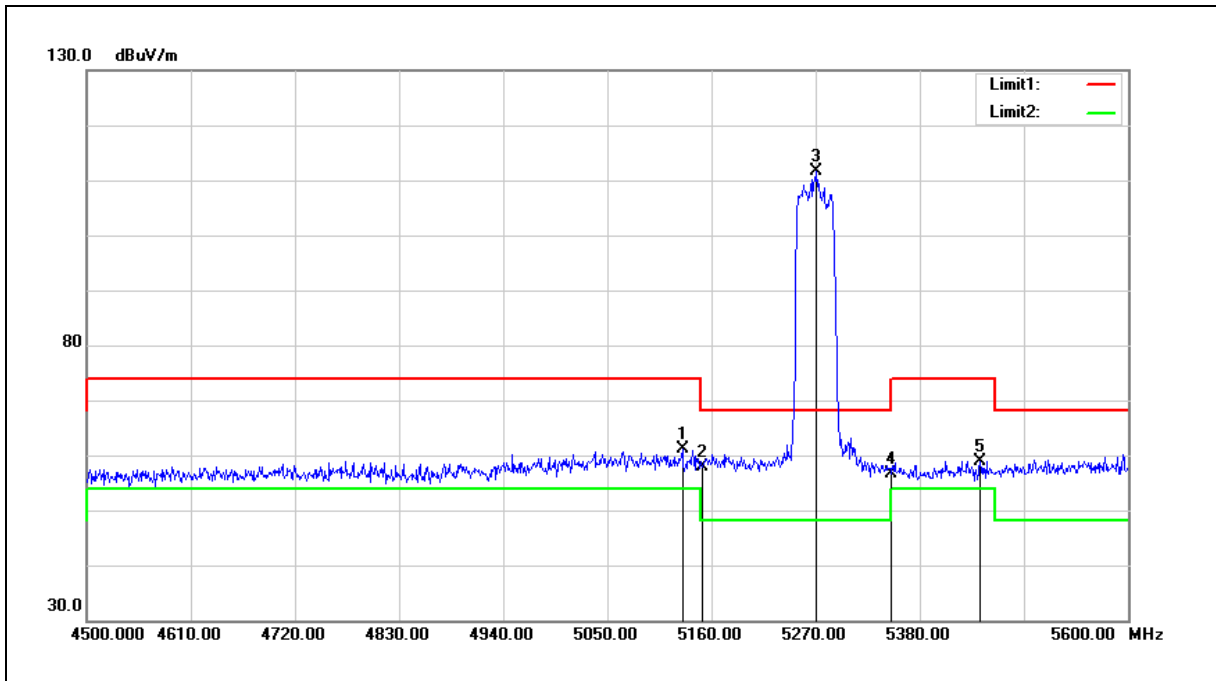

No.	Frequency (MHz)	Reading (dBuV)	Correct Factor (dB/m)	Result (dBuV/m)	Limit (dBuV/m)	Margin (dB)	Remark
1	5129.200	61.24	-0.13	61.11	74.00	-12.89	peak
2	5150.000	58.04	-0.08	57.96	74.00	-16.04	peak
3	5271.100	111.59	0.15	111.74	--	--	peak
4	5350.000	56.21	0.30	56.51	74.00	-17.49	peak
5	5443.800	58.44	0.47	58.91	74.00	-15.09	peak

Note:1.Result (dBuV/m) = Correct Factor (dB/m) + Reading(dBuV).

2.Correction factor (dB/m) = Antenna Factor (dB/m) + Cable loss (dB) – Pre-Amplifier gain (dB).

3.When the peak results are less than average limit, so not need to evaluate the average.

Standard:	FCC Part 15.407	Test Distance:	3 m
Test item:	Band edge		
Frequency:	5270 MHz		
Mode:	Mode 9		
Ant.Polar.:	Vertical		

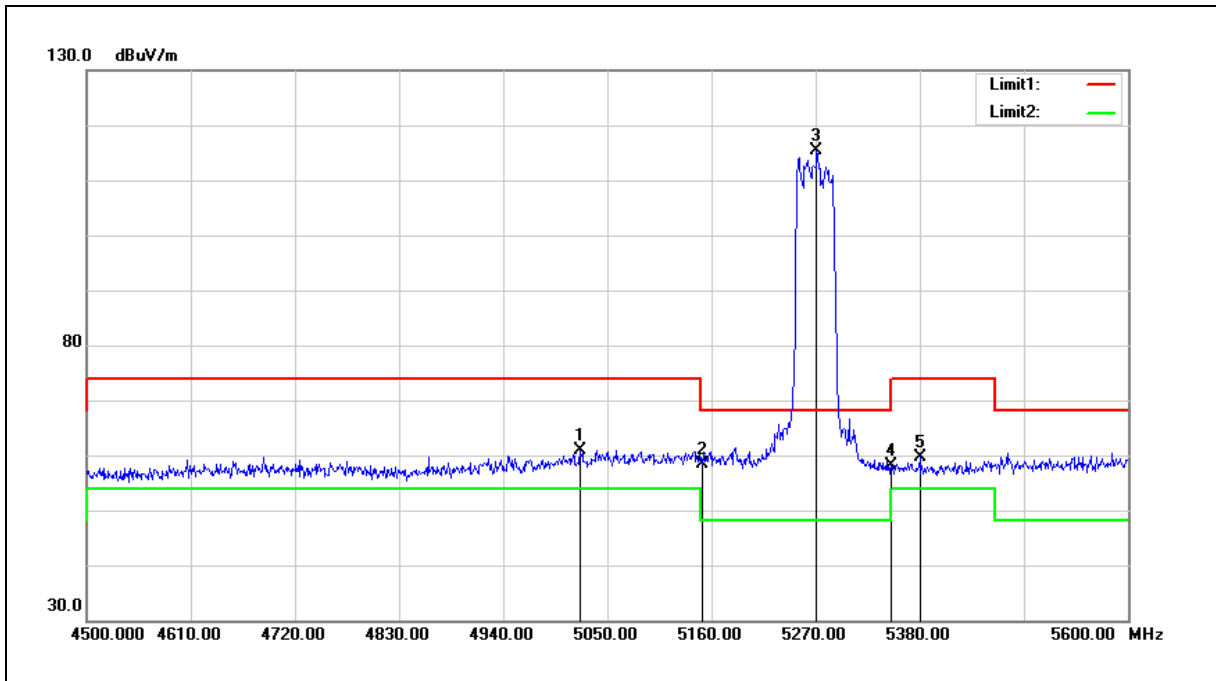

No.	Frequency (MHz)	Reading (dBuV)	Correct Factor (dB/m)	Result (dBuV/m)	Limit (dBuV/m)	Margin (dB)	Remark
1	5021.400	61.25	-0.31	60.94	74.00	-13.06	peak
2	5150.000	58.34	-0.08	58.26	74.00	-15.74	peak
3	5271.100	115.22	0.15	115.37	--	--	peak
4	5350.000	57.78	0.30	58.08	74.00	-15.92	peak
5	5380.000	59.27	0.35	59.62	74.00	-14.38	peak

Note:1.Result (dBuV/m) = Correct Factor (dB/m) + Reading(dBuV).

2.Correction factor (dB/m) = Antenna Factor (dB/m) + Cable loss (dB) – Pre-Amplifier gain (dB).

3.When the peak results are less than average limit, so not need to evaluate the average.

Standard:	FCC Part 15.407	Test Distance:	3 m
Test item:	Band edge		
Frequency:	5310 MHz		
Mode:	Mode 9		
Ant.Polar.:	Horizontal		

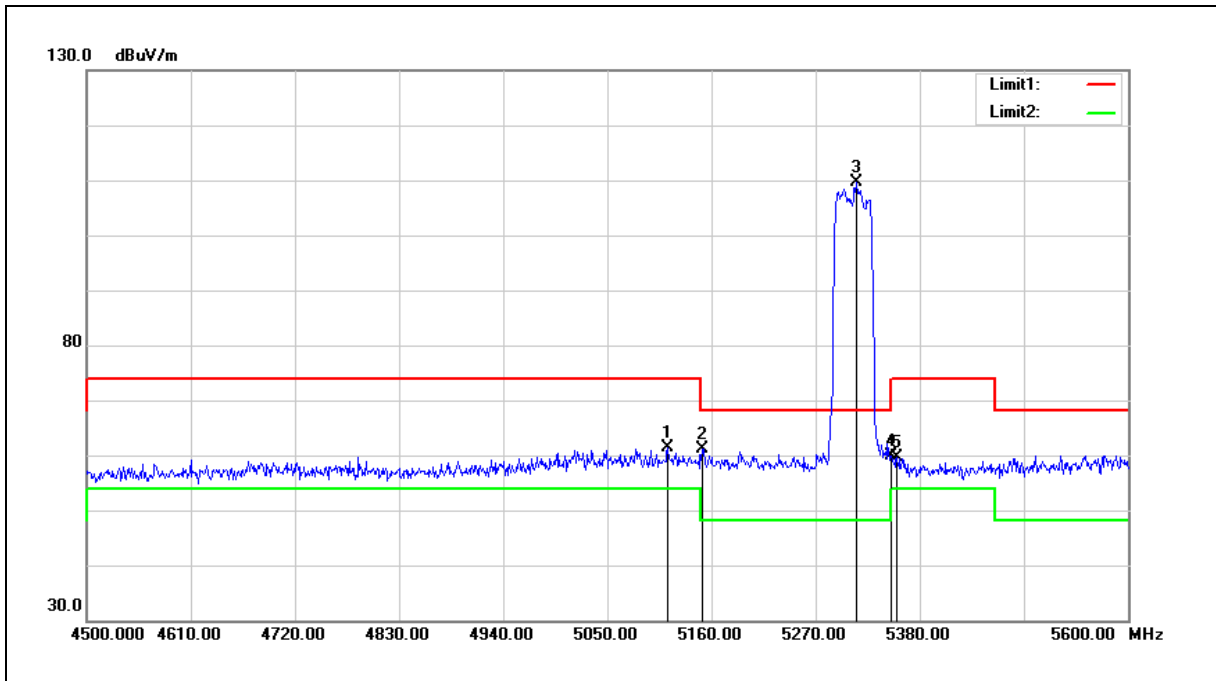

No.	Frequency (MHz)	Reading (dBuV)	Correct Factor (dB/m)	Result (dBuV/m)	Limit (dBuV/m)	Margin (dB)	Remark
1	5113.800	61.65	-0.15	61.50	74.00	-12.50	peak
2	5150.000	61.27	-0.08	61.19	74.00	-12.81	peak
3	5312.900	109.44	0.23	109.67	--	--	peak
4	5350.000	59.58	0.30	59.88	74.00	-14.12	peak
5	5355.800	59.25	0.30	59.55	74.00	-14.45	peak

Note:1.Result (dBuV/m) = Correct Factor (dB/m) + Reading(dBuV).

2.Correction factor (dB/m) = Antenna Factor (dB/m) + Cable loss (dB) – Pre-Amplifier gain (dB).

3.When the peak results are less than average limit, so not need to evaluate the average.

Standard:	FCC Part 15.407	Test Distance:	3 m
Test item:	Band edge		
Frequency:	5310 MHz		
Mode:	Mode 9		
Ant.Polar.:	Vertical		

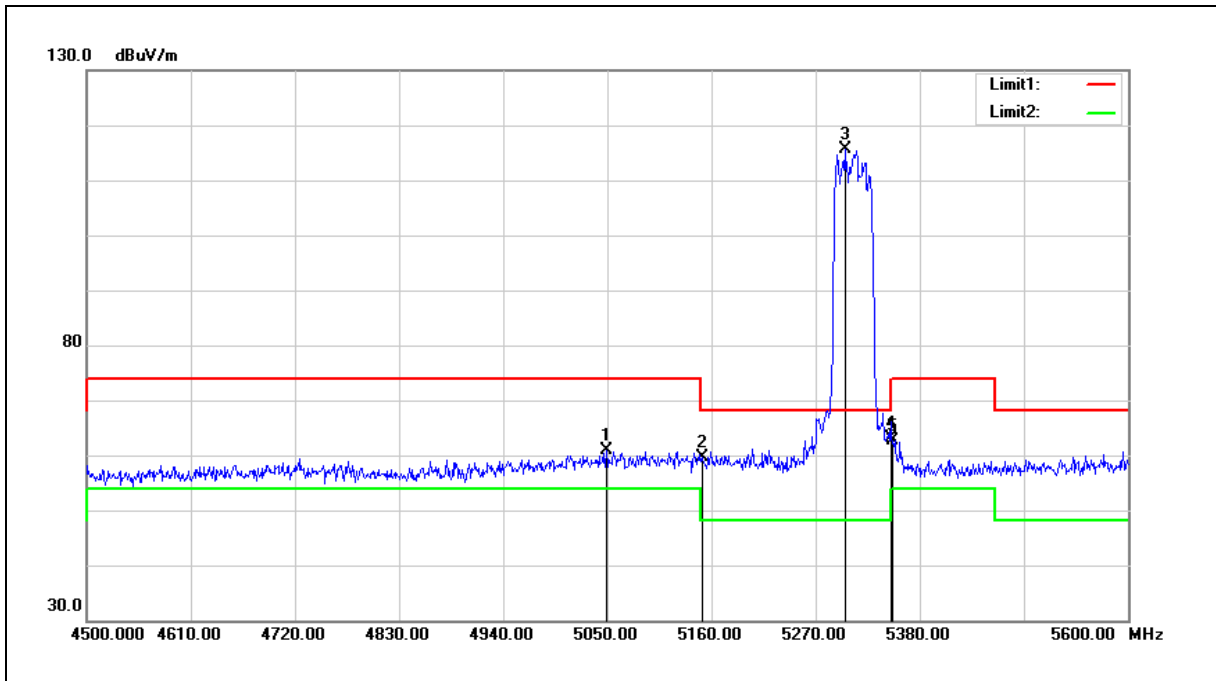

No.	Frequency (MHz)	Reading (dBuV)	Correct Factor (dB/m)	Result (dBuV/m)	Limit (dBuV/m)	Margin (dB)	Remark
1	5048.900	61.04	-0.26	60.78	74.00	-13.22	peak
2	5150.000	59.70	-0.08	59.62	74.00	-14.38	peak
3	5300.800	115.33	0.20	115.53	--	--	peak
4	5350.000	62.72	0.30	63.02	74.00	-10.98	peak
5	5351.400	62.40	0.30	62.70	74.00	-11.30	peak

Note:1.Result (dBuV/m) = Correct Factor (dB/m) + Reading(dBuV).

2.Correction factor (dB/m) = Antenna Factor (dB/m) + Cable loss (dB) – Pre-Amplifier gain (dB).

3.When the peak results are less than average limit, so not need to evaluate the average.

Standard:	FCC Part 15.407	Test Distance:	3 m
Test item:	Band edge		
Frequency:	5510 MHz		
Mode:	Mode 9		
Ant.Polar.:	Horizontal		

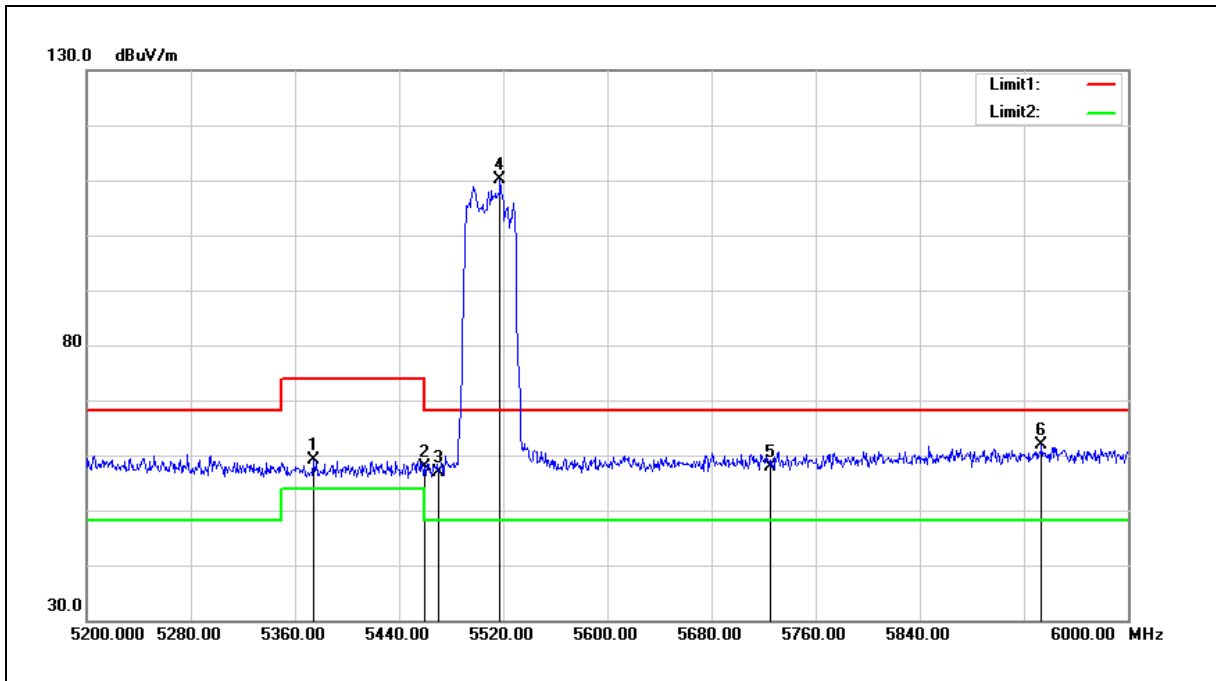

No.	Frequency (MHz)	Reading (dBuV)	Correct Factor (dB/m)	Result (dBuV/m)	Limit (dBuV/m)	Margin (dB)	Remark
1	5374.400	58.67	0.34	59.01	74.00	-14.99	peak
2	5460.000	57.28	0.51	57.79	74.00	-16.21	peak
3	5470.000	56.47	0.52	56.99	68.20	-11.21	peak
4	5517.600	109.40	0.62	110.02	--	--	peak
5	5725.000	56.75	1.18	57.93	68.20	-10.27	peak
6	5933.600	60.17	1.74	61.91	68.20	-6.29	peak

Note: 1. Result (dBuV/m) = Correct Factor (dB/m) + Reading(dBuV).

2. Correction factor (dB/m) = Antenna Factor (dB/m) + Cable loss (dB) – Pre-Amplifier gain (dB).

3. When the peak results are less than average limit, so not need to evaluate the average.

Standard:	FCC Part 15.407	Test Distance:	3 m
Test item:	Band edge		
Frequency:	5510 MHz		
Mode:	Mode 9		
Ant.Polar.:	Vertical		

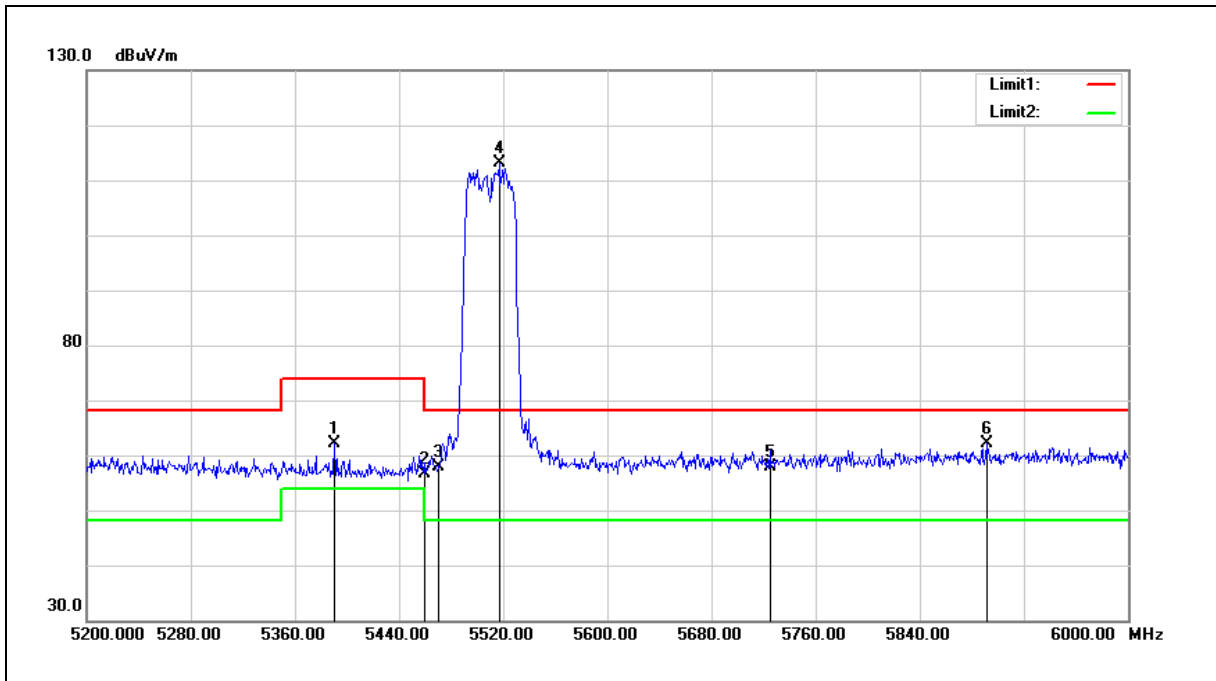

No.	Frequency (MHz)	Reading (dBuV)	Correct Factor (dB/m)	Result (dBuV/m)	Limit (dBuV/m)	Margin (dB)	Remark
1	5390.400	61.66	0.36	62.02	74.00	-11.98	peak
2	5460.000	56.03	0.51	56.54	74.00	-17.46	peak
3	5470.000	57.35	0.52	57.87	68.20	-10.33	peak
4	5516.800	112.63	0.62	113.25	--	--	peak
5	5725.000	56.77	1.18	57.95	68.20	-10.25	peak
6	5891.200	60.44	1.63	62.07	68.20	-6.13	peak

Note: 1. Result (dBuV/m) = Correct Factor (dB/m) + Reading(dBuV).

2. Correction factor (dB/m) = Antenna Factor (dB/m) + Cable loss (dB) – Pre-Amplifier gain (dB).

3. When the peak results are less than average limit, so not need to evaluate the average.

Standard:	FCC Part 15.407	Test Distance:	3 m
Test item:	Band edge		
Frequency:	5550 MHz		
Mode:	Mode 9		
Ant.Polar.:	Horizontal		

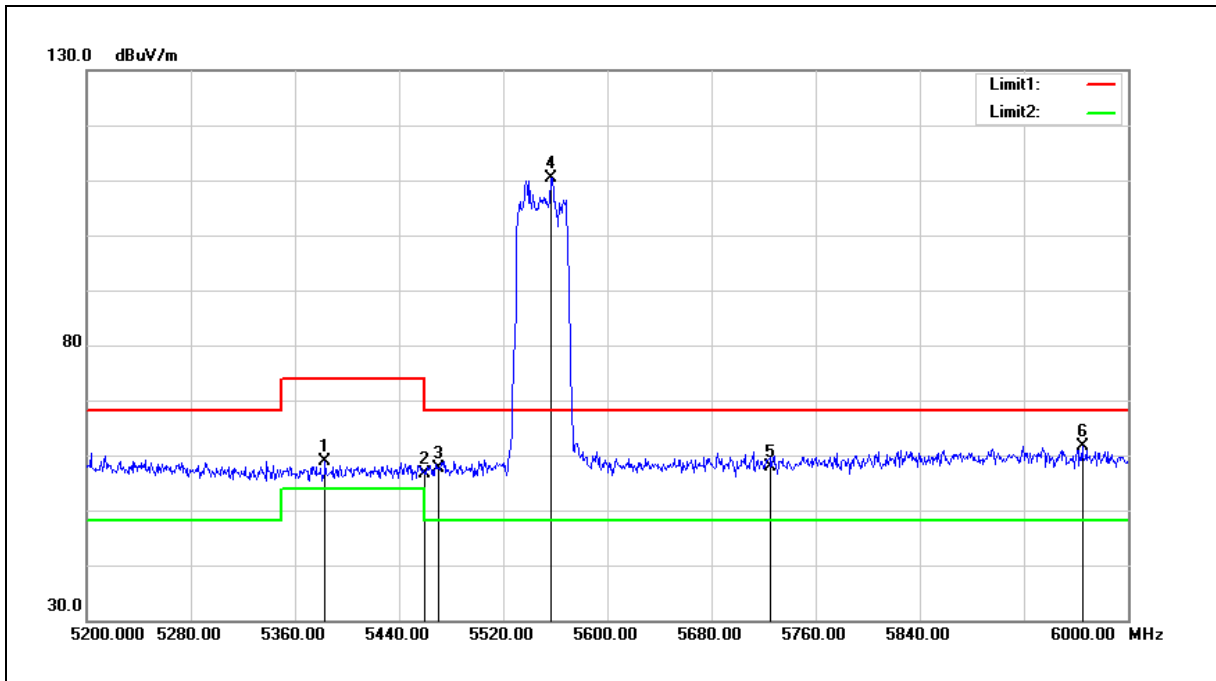

No.	Frequency (MHz)	Reading (dBuV)	Correct Factor (dB/m)	Result (dBuV/m)	Limit (dBuV/m)	Margin (dB)	Remark
1	5383.200	58.48	0.36	58.84	74.00	-15.16	peak
2	5460.000	56.14	0.51	56.65	74.00	-17.35	peak
3	5470.000	57.03	0.52	57.55	68.20	-10.65	peak
4	5556.800	109.68	0.73	110.41	--	--	peak
5	5725.000	56.66	1.18	57.84	68.20	-10.36	peak
6	5964.800	59.91	1.82	61.73	68.20	-6.47	peak

Note: 1. Result (dBuV/m) = Correct Factor (dB/m) + Reading(dBuV).

2. Correction factor (dB/m) = Antenna Factor (dB/m) + Cable loss (dB) – Pre-Amplifier gain (dB).

3. When the peak results are less than average limit, so not need to evaluate the average.

Standard:	FCC Part 15.407	Test Distance:	3 m
Test item:	Band edge		
Frequency:	5550 MHz		
Mode:	Mode 9		
Ant.Polar.:	Vertical		

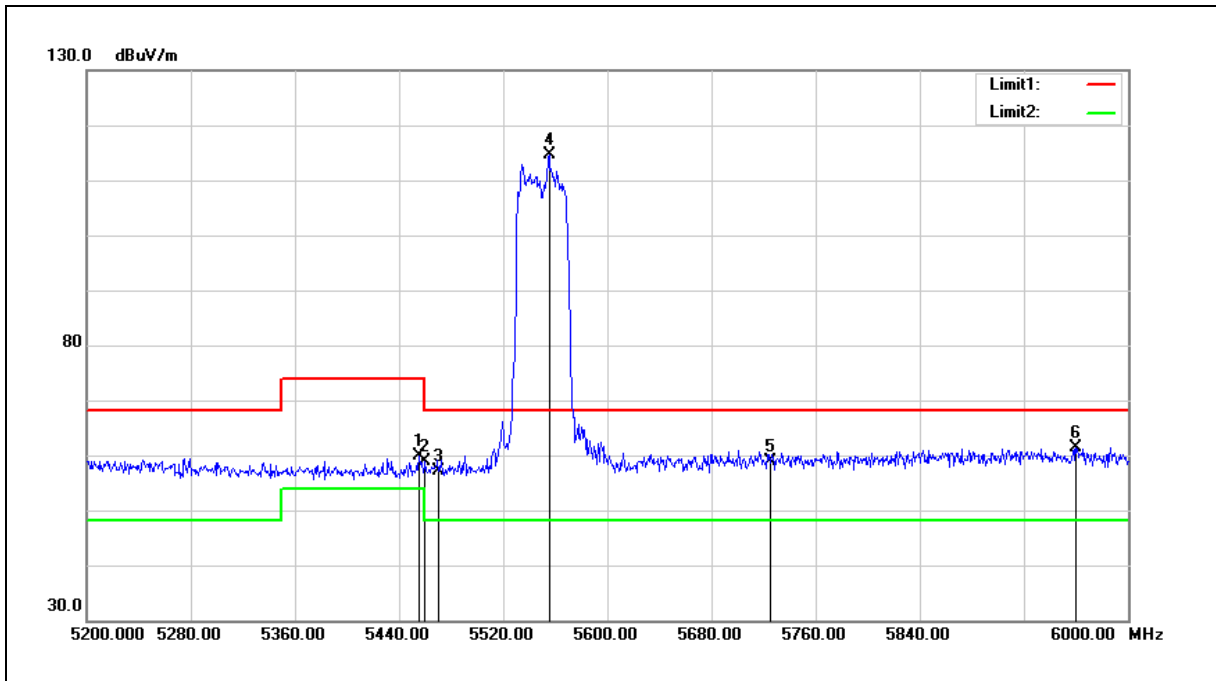

No.	Frequency (MHz)	Reading (dBuV)	Correct Factor (dB/m)	Result (dBuV/m)	Limit (dBuV/m)	Margin (dB)	Remark
1	5455.200	59.33	0.48	59.81	74.00	-14.19	peak
2	5460.000	58.43	0.51	58.94	74.00	-15.06	peak
3	5470.000	56.61	0.52	57.13	68.20	-11.07	peak
4	5555.200	113.99	0.73	114.72	--	--	peak
5	5725.000	57.78	1.18	58.96	68.20	-9.24	peak
6	5960.000	59.57	1.81	61.38	68.20	-6.82	peak

Note: 1. Result (dBuV/m) = Correct Factor (dB/m) + Reading(dBuV).

2. Correction factor (dB/m) = Antenna Factor (dB/m) + Cable loss (dB) – Pre-Amplifier gain (dB).

3. When the peak results are less than average limit, so not need to evaluate the average.

Standard:	FCC Part 15.407	Test Distance:	3 m
Test item:	Band edge		
Frequency:	5670 MHz		
Mode:	Mode 9		
Ant.Polar.:	Horizontal		

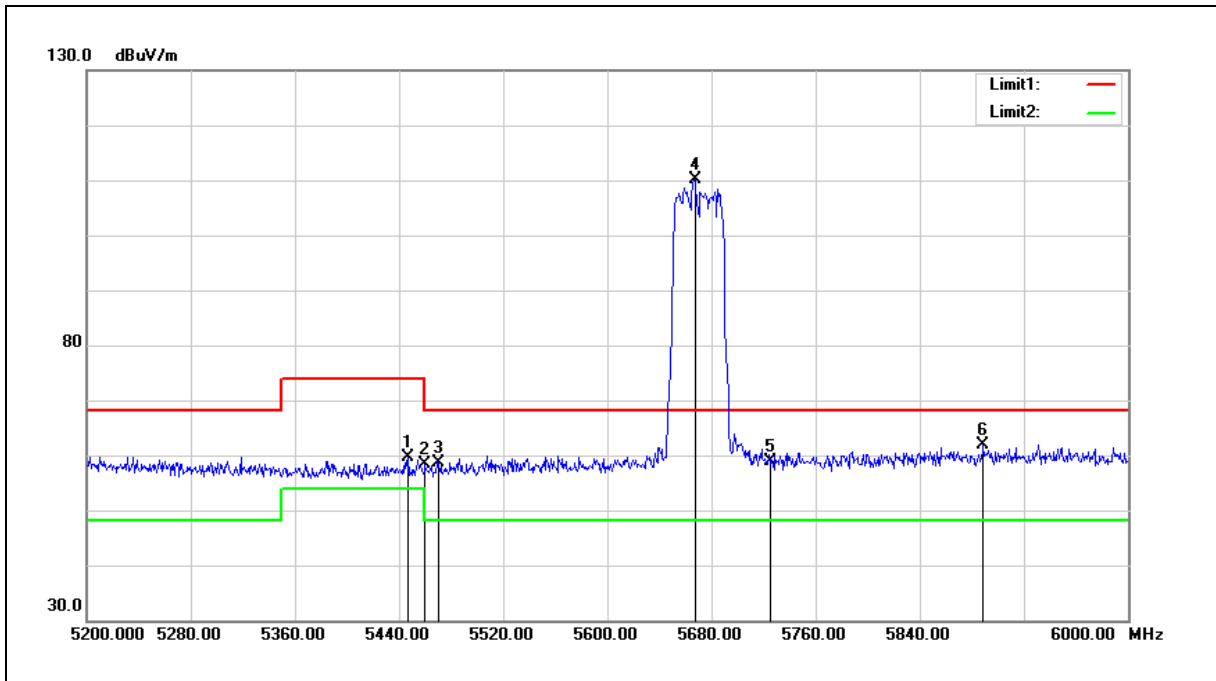

No.	Frequency (MHz)	Reading (dBuV)	Correct Factor (dB/m)	Result (dBuV/m)	Limit (dBuV/m)	Margin (dB)	Remark
1	5447.200	59.09	0.48	59.57	74.00	-14.43	peak
2	5460.000	57.79	0.51	58.30	74.00	-15.70	peak
3	5470.000	58.12	0.52	58.64	68.20	-9.56	peak
4	5667.200	109.13	1.03	110.16	--	--	peak
5	5725.000	57.77	1.18	58.95	68.20	-9.25	peak
6	5888.800	60.31	1.63	61.94	68.20	-6.26	peak

Note: 1. Result (dBuV/m) = Correct Factor (dB/m) + Reading(dBuV).

2. Correction factor (dB/m) = Antenna Factor (dB/m) + Cable loss (dB) – Pre-Amplifier gain (dB).

3. When the peak results are less than average limit, so not need to evaluate the average.

Standard:	FCC Part 15.407	Test Distance:	3 m
Test item:	Band edge		
Frequency:	5670 MHz		
Mode:	Mode 9		
Ant.Polar.:	Vertical		

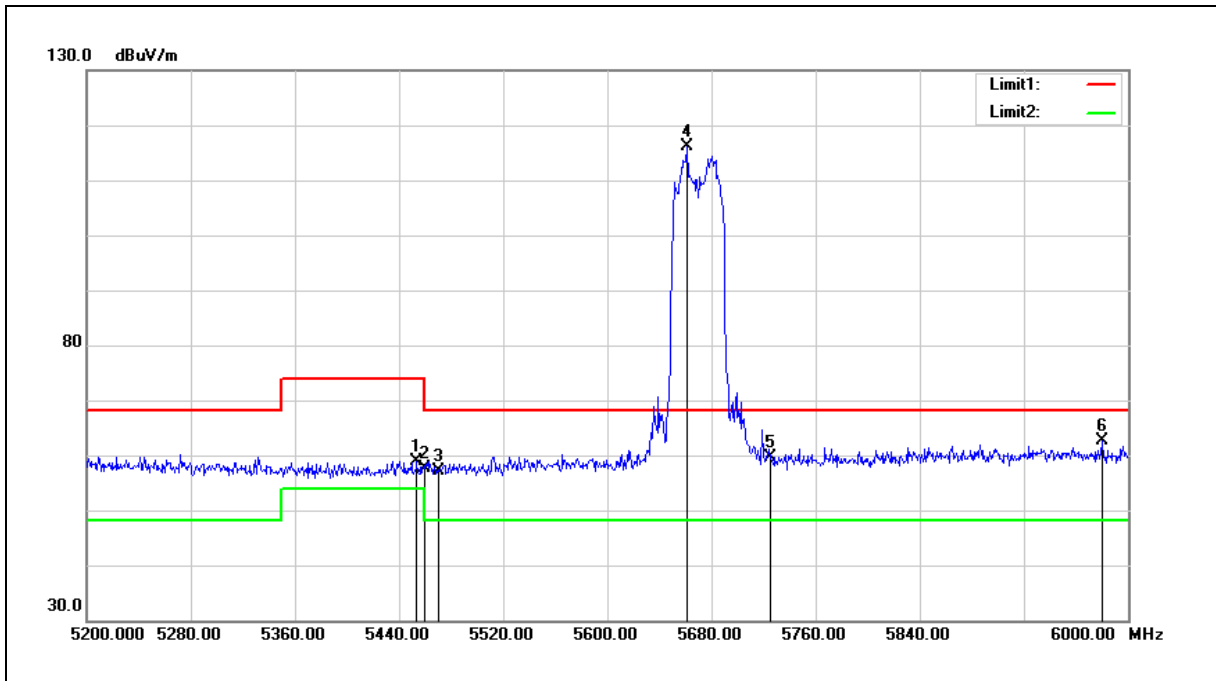

No.	Frequency (MHz)	Reading (dBuV)	Correct Factor (dB/m)	Result (dBuV/m)	Limit (dBuV/m)	Margin (dB)	Remark
1	5453.600	58.50	0.48	58.98	74.00	-15.02	peak
2	5460.000	57.21	0.51	57.72	74.00	-16.28	peak
3	5470.000	56.68	0.52	57.20	68.20	-11.00	peak
4	5660.800	115.17	1.00	116.17	--	--	peak
5	5725.000	58.40	1.18	59.58	68.20	-8.62	peak
6	5980.000	60.67	1.87	62.54	68.20	-5.66	peak

Note: 1. Result (dBuV/m) = Correct Factor (dB/m) + Reading(dBuV).

2. Correction factor (dB/m) = Antenna Factor (dB/m) + Cable loss (dB) – Pre-Amplifier gain (dB).

3. When the peak results are less than average limit, so not need to evaluate the average.

Standard:	FCC Part 15.407	Test Distance:	3 m
Test item:	Band edge		
Frequency:	5755 MHz		
Mode:	Mode 9		
Ant.Polar.:	Horizontal		

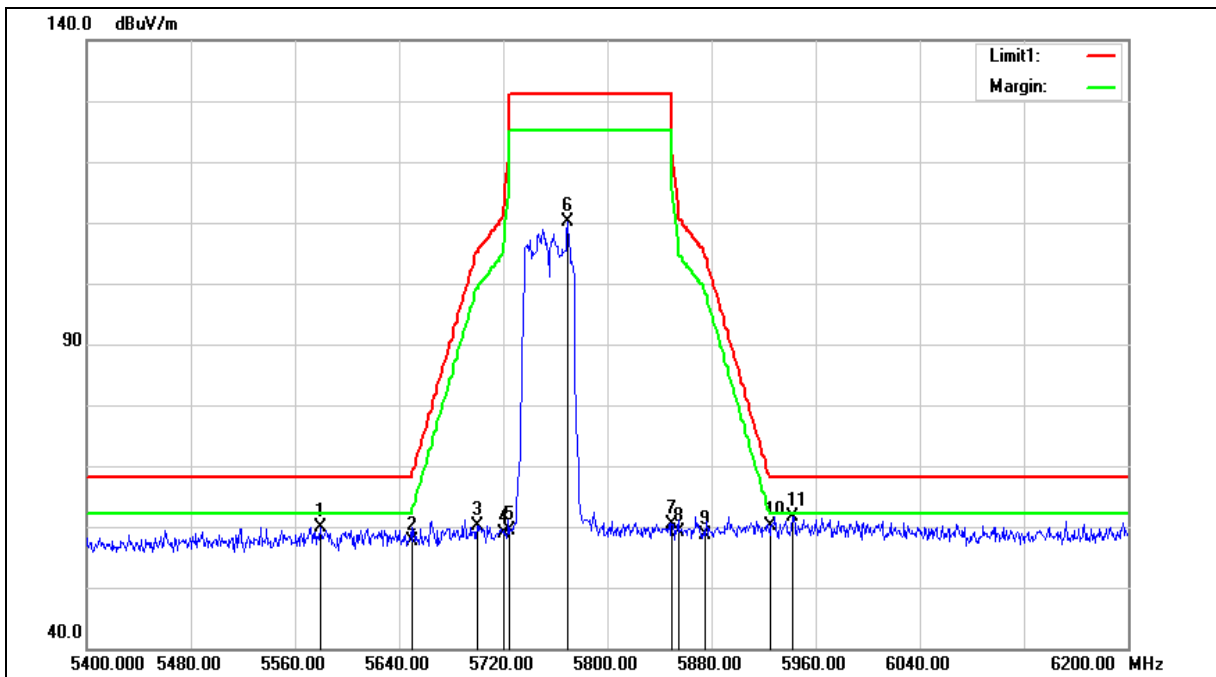

Standard:	FCC Part 15.407	Test Distance:	3 m
Test item:	Band edge		
Frequency:	5755 MHz		
Mode:	Mode 9		
Ant.Polar.:	Horizontal		

No.	Frequency (MHz)	Reading (dBuV)	Correct Factor (dB/m)	Result (dBuV/m)	Limit (dBuV/m)	Margin (dB)	Remark
1	5579.200	59.07	0.79	59.86	68.20	-8.34	peak
2	5650.000	56.60	0.97	57.57	68.20	-10.63	peak
3	5700.000	59.11	1.11	60.22	105.20	-44.98	peak
4	5720.000	57.61	1.17	58.78	110.80	-52.02	peak
5	5725.000	58.18	1.18	59.36	122.20	-62.84	peak
6	5769.600	108.90	1.29	110.19	--	--	peak
7	5850.000	58.94	1.52	60.46	122.20	-61.74	peak
8	5855.000	57.63	1.53	59.16	110.80	-51.64	peak
9	5875.000	57.00	1.59	58.59	105.20	-46.61	peak
10	5925.000	58.46	1.72	60.18	68.20	-8.02	peak
11	5942.400	59.83	1.77	61.60	68.20	-6.60	peak

Note:1.Result (dBuV/m) = Correct Factor (dB/m) + Reading(dBuV).

2.Correction factor (dB/m) = Antenna Factor (dB/m) + Cable loss (dB) – Pre-Amplifier gain (dB).

3.When the peak results are less than average limit, so not need to evaluate the average.

Standard:	FCC Part 15.407	Test Distance:	3 m
Test item:	Band edge		
Frequency:	5755 MHz		
Mode:	Mode 9		
Ant.Polar.:	Vertical		

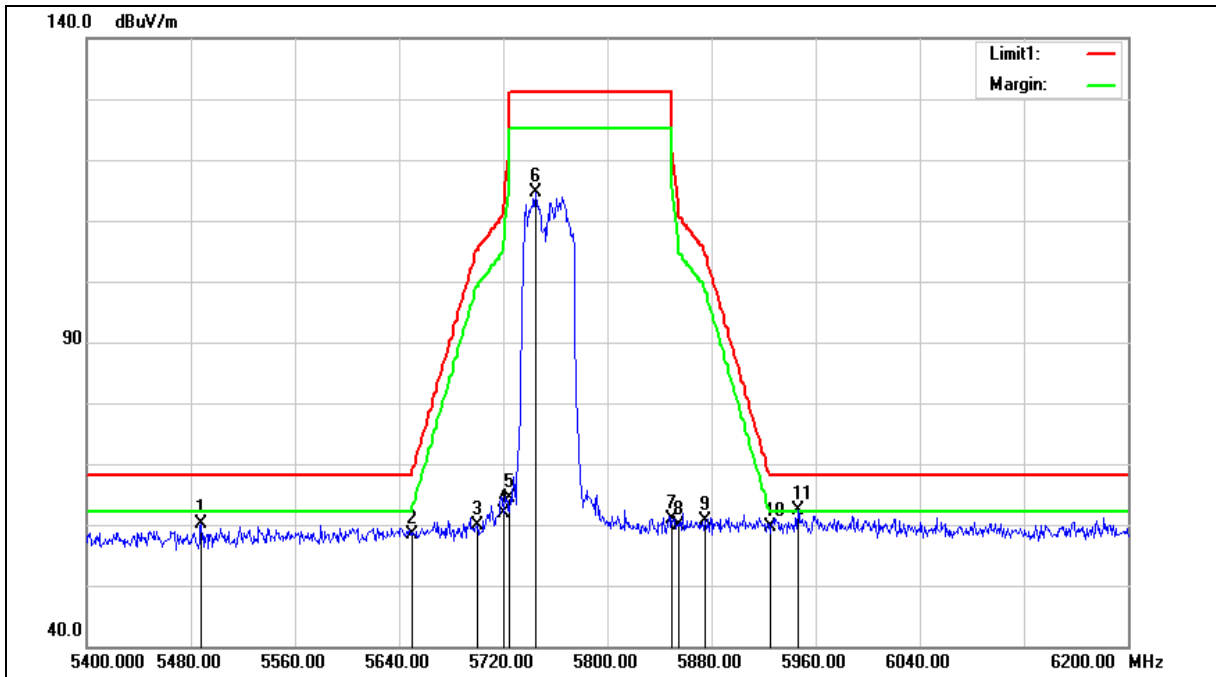

Standard:	FCC Part 15.407	Test Distance:	3 m
Test item:	Band edge		
Frequency:	5755 MHz		
Mode:	Mode 9		
Ant.Polar.:	Vertical		

No.	Frequency (MHz)	Reading (dBuV)	Correct Factor (dB/m)	Result (dBuV/m)	Limit (dBuV/m)	Margin (dB)	Remark
1	5488.000	59.48	0.56	60.04	68.20	-8.16	peak
2	5650.000	57.35	0.97	58.32	68.20	-9.88	peak
3	5700.000	58.77	1.11	59.88	105.20	-45.32	peak
4	5720.000	60.77	1.17	61.94	110.80	-48.86	peak
5	5725.000	63.11	1.18	64.29	122.20	-57.91	peak
6	5744.800	113.32	1.23	114.55	--	--	peak
7	5850.000	59.28	1.52	60.80	122.20	-61.40	peak
8	5855.000	58.42	1.53	59.95	110.80	-50.85	peak
9	5875.000	59.04	1.59	60.63	105.20	-44.57	peak
10	5925.000	57.80	1.72	59.52	68.20	-8.68	peak
11	5946.400	60.50	1.78	62.28	68.20	-5.92	peak

Note:1.Result (dBuV/m) = Correct Factor (dB/m) + Reading(dBuV).

2.Correction factor (dB/m) = Antenna Factor (dB/m) + Cable loss (dB) – Pre-Amplifier gain (dB).

3.When the peak results are less than average limit, so not need to evaluate the average.