



FCC TEST REPORT (15.247)

REPORT NO.: RF981207H05

MODEL NO.: DCW775

RECEIVED: Dec. 07, 2009

TESTED: Dec. 08 to 15, 2009

ISSUED: Dec. 28, 2009

APPLICANT: ASKEY COMPUTER CORP.

ADDRESS: 10F, No.119, ChienKang RD., Chungho,
Taipei, Taiwan

ISSUED BY: Bureau Veritas Consumer Products Services (H.K.)
Ltd., Taoyuan Branch Hsin Chu Laboratory

ADDRESS: No. 81-1, Lu Liao Keng, 9th Ling, Wu Lung Tsuen,
Chiung Lin Hsiang, Hsin Chu Hsien 307, Taiwan

This test report consists of 85 pages in total. It may be duplicated completely for legal use with the approval of the applicant. It should not be reproduced except in full, without the written approval of our laboratory. The client should not use it to claim product endorsement by TAF or any government agencies. The test results in the report only apply to the tested sample.





A D T

Table of Contents

1.	CERTIFICATION	4
2.	SUMMARY OF TEST RESULTS	5
2.1	MEASUREMENT UNCERTAINTY	6
3.	GENERAL INFORMATION	7
3.1	GENERAL DESCRIPTION OF EUT	7
3.2	DESCRIPTION OF TEST MODES	10
3.2.1	TEST MODE APPLICABILITY AND TESTED CHANNEL DETAIL	11
3.3	GENERAL DESCRIPTION OF APPLIED STANDARDS	14
3.4	DESCRIPTION OF SUPPORT UNITS	15
3.5	CONFIGURATION OF SYSTEM UNDER TEST	16
4.	TEST TYPES AND RESULTS (802.11b & g, 2400 ~ 2483.5MHz Band)	17
4.1	CONDUCTED EMISSION MEASUREMENT	17
4.1.1	LIMITS OF CONDUCTED EMISSION MEASUREMENT	17
4.1.2	TEST INSTRUMENTS	17
4.1.3	TEST PROCEDURES	18
4.1.4	DEVIATION FROM TEST STANDARD	18
4.1.5	TEST SETUP	19
4.1.6	EUT OPERATING CONDITIONS	19
4.1.7	TEST RESULTS	20
4.2	RADIATED EMISSION MEASUREMENT	24
4.2.1	LIMITS OF RADIATED EMISSION MEASUREMENT	24
4.2.2	TEST INSTRUMENTS	25
4.2.3	TEST PROCEDURES	27
4.2.4	DEVIATION FROM TEST STANDARD	27
4.2.5	TEST SETUP	28
4.2.6	EUT OPERATING CONDITIONS	28
4.2.7	TEST RESULTS	29
4.3	6dB BANDWIDTH MEASUREMENT	58
4.3.1	LIMITS OF 6dB BANDWIDTH MEASUREMENT	58
4.3.2	TEST INSTRUMENTS	58
4.3.3	TEST PROCEDURE	59
4.3.4	DEVIATION FROM TEST STANDARD	59
4.3.5	TEST SETUP	59
4.3.6	EUT OPERATING CONDITIONS	59
4.3.7	TEST RESULTS	60
4.4	MAXIMUM PEAK OUTPUT POWER	64
4.4.1	LIMITS OF MAXIMUM PEAK OUTPUT POWER MEASUREMENT	64



A D T

4.4.2	INSTRUMENTS	64
4.4.3	TEST PROCEDURES.....	64
4.4.4	DEVIATION FROM TEST STANDARD	64
4.4.5	TEST SETUP	64
4.4.6	EUT OPERATING CONDITIONS.....	65
4.4.7	TEST RESULTS.....	66
4.5	POWER SPECTRAL DENSITY MEASUREMENT.....	68
4.5.1	LIMITS OF POWER SPECTRAL DENSITY MEASUREMENT	68
4.5.2	TEST INSTRUMENTS	68
4.5.3	TEST PROCEDURE	69
4.5.4	DEVIATION FROM TEST STANDARD	69
4.5.5	TEST SETUP	69
4.5.6	EUT OPERATING CONDITION	69
4.5.7	TEST RESULTS.....	70
4.6	CONDUCTED OUT-BAND EMISSION MEASUREMENT.....	74
4.6.1	LIMITS OF CONDUCTED OUT-BAND EMISSION MEASUREMENT	74
4.6.2	TEST INSTRUMENTS	74
4.6.3	TEST PROCEDURE	74
4.6.4	DEVIATION FROM TEST STANDARD	75
4.6.5	EUT OPERATING CONDITION	75
4.6.6	TEST RESULTS.....	75
5.	INFORMATION ON THE TESTING LABORATORIES	84
6.	APPENDIX-A- MODIFICATIONS RECORDERS FOR ENGINEERING CHANGES TO THE EUT BY THE LAB	85



1. CERTIFICATION

PRODUCT: Cable Modem
BRAND NAME: THOMSON
MODEL NO.: DCW775
TEST SAMPLE: MASS-PRODUCTION
TESTED: Dec. 08 to 15, 2009
APPLICANT: ASKEY COMPUTER CORP.
STANDARDS: FCC Part 15, Subpart C (Section 15.247),
ANSI C63.4-2003

The above equipment (Model: DCW775) has been tested by **Bureau Veritas Consumer Products Services (H.K.) Ltd., Taoyuan Branch**, and found compliance with the requirement of the above standards. The test record, data evaluation & Equipment Under Test (EUT) configurations represented herein are true and accurate accounts of the measurements of the sample's EMC characteristics under the conditions specified in this report.

PREPARED BY : Midoli Peng , **DATE:** Dec. 28, 2009
(Midoli Peng, Specialist)

TECHNICAL ACCEPTANCE : Hank Chung , **DATE:** Dec. 28, 2009
(Hank Chung, Deputy Manager)

APPROVED BY : May Chen , **DATE:** Dec. 28, 2009
(May Chen, Deputy Manager)



A D T

2. SUMMARY OF TEST RESULTS

The EUT has been tested according to the following specifications:

For 802.11b & g, 2412~2462MHz Band

APPLIED STANDARD: FCC Part 15, Subpart C (Section 15.247)			
Standard Section	Test Type and Limit	Result	Remark
15.207	AC Power Conducted Emission	PASS	Meet the requirement of limit. Minimum passing margin is -5.71dB at 0.161MHz
15.247(a)(2)	Spectrum Bandwidth of a Direct Sequence Spread Spectrum System Limit: min. 500kHz	PASS	Meet the requirement of limit.
15.247(b)	Maximum Peak Output Power Limit: max. 30dBm	PASS	Meet the requirement of limit.
15.247(d)	Radiated Emissions Limit: Table 15.209	PASS	Meet the requirement of limit. Minimum passing margin is -0.6dB at 2483.88MHz, 2390.0MHz, 2483.52MHz
15.247(e)	Power Spectral Density Limit: max. 8dBm	PASS	Meet the requirement of limit.
15.247(d)	Conducted Out-Band Emission Measurement Limit: 20dB less than the peak value of fundamental frequency	PASS	Meet the requirement of limit.
15.203	Antenna Requirement	PASS	Antenna connector is I-PEX not a standard connector.

NOTE:

1. The EUT was operating in 2400 ~ 2483.5MHz and 5.15~5.25GHz frequencies band. This report was recorded the RF parameters including 2400 ~ 2483.5MHz. For the 5.15~5.25GHz RF parameters was recorded in another test report.



A D T

2.1 MEASUREMENT UNCERTAINTY

Where relevant, the following measurement uncertainty levels have been estimated for tests performed on the EUT as specified in CISPR 16-4-2:

This uncertainty represents an expanded uncertainty expressed at approximately the 95% confidence level using a coverage factor of $k=2$.

Measurement	Value
Conducted emissions	2.45 dB
Radiated emissions (30MHz-1GHz)	3.83 dB
Radiated emissions (1GHz -18GHz)	2.49 dB
Radiated emissions (18GHz -40GHz)	2.70 dB



A D T

3. GENERAL INFORMATION

3.1 GENERAL DESCRIPTION OF EUT

PRODUCT	Cable Modem
MODEL NO.	DCW775
FCC ID	H8NDCW775
POWER SUPPLY	DC 12V from power adapter
MODULATION TYPE	CCK, DQPSK, DBPSK for DSSS 64QAM, 16QAM, QPSK, BPSK for OFDM
MODULATION TECHNOLOGY	DSSS, OFDM
TRANSFER RATE	802.11a/g: 54/48/36/24/18/12/9/6Mbps 802.11b: 11/5.5/2/1Mbps 11n HT20 (800ns GI) MCS15-8: 130/117/104/78/52/39/26/13Mbps MCS7-0: 65/58.5/52/39/26/19.5/13/6.5Mbps 11n HT40 (800ns GI) MCS15-8: 270/243/216/162/108/81/54/27Mbps MCS7-0: 135/121.5/108/81/54/40.5/27/13.5 Mbps MCS32: 6Mbps
FREQUENCY RANGE	For 15.407 802.11a: 5.18 ~ 5.24GHz For 15.247 802.11b & 802.11g: 2412 ~ 2462MHz
NUMBER OF CHANNEL	For 15.407 4 for 802.11a, 802.11n (20MHz) 2 for 802.11n (40MHz) For 15.247(2.4GHz) 11 for 802.11b, 802.11g, 802.11n (20MHz) 7 for 802.11n (40MHz)
MAXIMUM OUTPUT POWER	For 15.407 802.11a: 24.5mW 802.11n (20MHz): 18.5mW 802.11n (40MHz): 42.5mW For 15.247 802.11b: 83.2mW 802.11g: 354.8mW 802.11n (20MHz): 514.2mW 802.11n (40MHz): 485.6mW
ANTENNA TYPE	Please see note 1

ANTENNA CONNECTOR	Please see note 1
DATA CABLE	NA
I/O PORTS	LAN port x 4 USB port x 1 Coaxial port x 1
ASSOCIATED DEVICES	Power adapter x1

NOTE:

1. There are two antennas provided to this EUT, please refer to the following table:

Chain	Antenna Type	Cable Loss(dB)	Antenna Gain (dBi) <include cable lose>	Connector	Cable Length
Chain (0)	PIFA	0.45	2	I-PEX	150mm
Chain (1)	PIFA	0.56	2	I-PEX	200mm

2. The EUT must be supplied with a power adapter and following two different brands could be chosen:

Adapter	Brand	Model No.	Spec.
Adapter 1	LEI	MT18-Y120150-A1	Input: AC 120V, 60Hz, 0.5A Output: 12V 1.5A DC output cable (unshielded, 1.5m)
Adapter 2	Amigo	AMS3-1201500FU	Input: AC 100-240V, 50/60Hz, 0.5A Output: DC: 12V 1.5A DC output cable (unshielded, 1.6m)

3. For radiated test, The EUT was pre-tested under the following modes:

Test Mode	Description
Mode A	Tower-set
Mode B	Level-set

From the above modes, the radiated (below 1GHz) worst case was found in **Mode A** and the radiated (above 1GHz) worst case was found in **Mode B**. Therefore only the test data of the modes were recorded in this report.

4. The EUT incorporates a MIMO function with 802.11n. Physically, the EUT provides two completed transmitters and two completed receivers.



A D T

5. The EUT is 2 * 2 spatial MIMO (2Tx & 2Rx) without beam forming function. The antenna configurations are two transmitter antennas and two receiver antennas, as there are 2 PIFA antennas. Spatial multiplexing modes for simultaneous transmission using 2 antennas, and for simultaneous receiver using 2 antennas. The 11a/b/g legacy mode is limited to single transmitter only.
6. The EUT complies with 802.11n standards and backwards compatible with 802. 11a, 802.11b, 802.11g products.
7. The above EUT information was declared by manufacturer and for more detailed features description, please refer to the manufacturer's specifications or user's manual.

3.2 DESCRIPTION OF TEST MODES

Operated in 2400 ~ 2483.5MHz band:

Eleven channels are provided for 802.11b, 802.11g, 802.11n (20MHz):

CHANNEL	FREQUENCY	CHANNEL	FREQUENCY
1	2412MHz	7	2442MHz
2	2417MHz	8	2447MHz
3	2422MHz	9	2452MHz
4	2427MHz	10	2457MHz
5	2432MHz	11	2462MHz
6	2437MHz		

Seven channels are provided for 802.11n (40MHz):

CHANNEL	FREQUENCY	CHANNEL	FREQUENCY
1	2422MHz	5	2442MHz
2	2427MHz	6	2447MHz
3	2432MHz	7	2452MHz
4	2437MHz		



A D T

3.2.1 TEST MODE APPLICABILITY AND TESTED CHANNEL DETAIL

EUT CONFIGURE MODE	APPLICABLE TO				DESCRIPTION
	PLC	RE < 1G	RE ≥ 1G	APCM	
-	√	√	√	√	-

Where **PLC**: Power Line Conducted Emission **RE < 1G**: Radiated Emission below 1GHz
RE ≥ 1G: Radiated Emission above 1GHz **APCM**: Antenna Port Conducted Measurement

ANTENNA COMBINATION MODE:

COMBINATION MODE	OPERATION MODE	TX CHAIN(0)	TX CHAIN(1)
A	802.11 b	√	
B	802.11 g	√	
C	802.11n(20MHz) for MCS0~7	√	
D	802.11n(20MHz) for MCS8~15	√	√
E	802.11n(40MHz) for MCS0~7	√	
F	802.11n(40MHz) for MCS8~15	√	√

Note:

1. The above information was declared by manufacturer and for more detailed features description, please refer to the manufacturer's specifications or user's manual.
2. Mode A, B, D, F the worst modes, were selected as representative mode for the report.

POWER LINE CONDUCTED EMISSION TEST:

- Pre-Scan has been conducted to determine the worst-case mode from all possible combinations between available modulations, data rates and antenna ports (if EUT with antenna diversity architecture).
- Following channel(s) was (were) selected for the final test as listed below.

MODE	AVAILABLE CHANNEL	TESTED CHANNEL	MODULATION TECHNOLOGY	MODULATION TYPE	DATA RATE (Mbps)	TX COMBINATION
For 2.4 GHz 802.11n (20MHz)	1 to 11	6	OFDM	BPSK	13	D

- The EUT was tested with the following test modes:

Test Mode	Description
Mode 1	Adapter 1
Mode 2	Adapter 2



A D T

RADIATED EMISSION TEST (BELOW 1 GHz):

- Pre-Scan has been conducted to determine the worst-case mode from all possible combinations between available modulations, data rates and antenna ports (if EUT with antenna diversity architecture).
- Following channel(s) was (were) selected for the final test as listed below.

MODE	AVAILABLE CHANNEL	TESTED CHANNEL	MODULATION TECHNOLOGY	MODULATION TYPE	DATA RATE (Mbps)	TX COMBINATION
For 2.4 GHz 802.11n (20MHz)	1 to 11	6	OFDM	BPSK	13	D

- The EUT was tested with the following test modes:

Test Mode	Description
Mode 1	Adapter 1
Mode 2	Adapter 2

Mode 1, the worse case one, was chosen for final test.

RADIATED EMISSION TEST (ABOVE 1 GHz):

- Pre-Scan has been conducted to determine the worst-case mode from all possible combinations between available modulations, data rates and antenna ports (if EUT with antenna diversity architecture).
- Following channel(s) was (were) selected for the final test as listed below.

MODE	AVAILABLE CHANNEL	TESTED CHANNEL	MODULATION TECHNOLOGY	MODULATION TYPE	DATA RATE (Mbps)	TX COMBINATION
802.11b	1 to 11	1, 6, 11	DSSS	DBPSK	1	A
802.11g	1 to 11	1, 6, 11	OFDM	BPSK	6	B
For 2.4 GHz 802.11n (20MHz)	1 to 11	1, 6, 11	OFDM	BPSK	13	D
For 2.4 GHz 802.11n (40MHz)	1 to 7	1, 4, 7	OFDM	BPSK	27	F



CONDUCTED OUT-BAND EMISSION MEASUREMENT:

- Pre-Scan has been conducted to determine the worst-case mode from all possible combinations between available modulations, data rates and antenna ports (if EUT with antenna diversity architecture).
- Following channel(s) was (were) selected for the final test as listed below.

MODE	AVAILABLE CHANNEL	TESTED CHANNEL	MODULATION TECHNOLOGY	MODULATION TYPE	DATA RATE (Mbps)	TX COMBINATION
802.11b	1 to 11	1, 11	DSSS	DBPSK	1	A
802.11g	1 to 11	1, 11	OFDM	BPSK	6	B
For 2.4 GHz 802.11n (20MHz)	1 to 11	1, 11	OFDM	BPSK	13	D
For 2.4 GHz 802.11n (40MHz)	1 to 7	1, 7	OFDM	BPSK	27	F

※ After verification, conducted out band emission as show worst chain in report by investigations.

ANTENNA PORT CONDUCTED MEASUREMENT:

- This item includes all test value of each mode, but only includes spectrum plot of worst value of each mode.
- Pre-Scan has been conducted to determine the worst-case mode from all possible combinations between available modulations, data rates and antenna ports (if EUT with antenna diversity architecture).
- Following channel(s) was (were) selected for the final test as listed below.

MODE	AVAILABLE CHANNEL	TESTED CHANNEL	MODULATION TECHNOLOGY	MODULATION TYPE	DATA RATE (Mbps)	TX COMBINATION
802.11b	1 to 11	1, 6, 11	DSSS	DBPSK	1	A
802.11g	1 to 11	1, 6, 11	OFDM	BPSK	6	B
For 2.4 GHz 802.11n (20MHz)	1 to 11	1, 6, 11	OFDM	BPSK	13	D
For 2.4 GHz 802.11n (40MHz)	1 to 7	1, 4, 7	OFDM	BPSK	27	F

※ After verification, bandwidth as show worst chain in report by investigations.



A D T

TEST CONDITION:

APPLICABLE TO	ENVIRONMENTAL CONDITIONS	INPUT POWER	TESTED BY
RE \geq 1G	25deg. C, 66%RH,1024 hPa	120Vac, 60Hz	Frank Liu
RE<1G	25deg. C, 60%RH,1024 hPa	120Vac, 60Hz	Eagle Chen
PLC	25deg. C, 60%RH,1024 hPa	120Vac, 60Hz	Leo Peng
APCM	25deg. C, 60%RH,1024 hPa	120Vac, 60Hz	Phoenix Huang

3.3 GENERAL DESCRIPTION OF APPLIED STANDARDS

The EUT is a Cable Modem. According to the specifications of the manufacturer, it must comply with the requirements of the following standards:

FCC Part 15, Subpart C. (15.247)

ANSI C63.4-2003

All test items have been performed and recorded as per the above standards.

NOTE: The EUT is also considered as a kind of computer peripheral, because the connection to computer is necessary for typical use. It has been verified to comply with the requirements of FCC Part 15, Subpart B, Class B (DoC). The test report has been issued separately.



A D T

3.4 DESCRIPTION OF SUPPORT UNITS

The EUT has been tested as an independent unit together with other necessary accessories or support units. The following support units or accessories were used to form a representative test configuration during the tests.

NO.	PRODUCT	BRAND	MODEL NO.	SERIAL NO.	FCC ID
1	Notebook Computer	DELL	PP18L	12252644560	FCC DoC
2	Notebook Computer	HP	HSTNN-S19C	JP96X-4Y88K-BXXY8-K27B3-M86FT	FCC DoC
3	USB Flash Drive	SanDisk	SDCZ2-512-A10	5393722913	FCC DoC
4	Icra Cable Modem Termination System	ARRIS	CMT1000	NA	NA

NO.	SIGNAL CABLE DESCRIPTION OF THE ABOVE SUPPORT UNITS
1	RJ-45 cable unshielded, 10m
2	RJ-45 cable unshielded, 0.3m
3	Coaxial cable (10m)
4	NA

NOTE: All power cords of the above support units are non shielded (1.8m).

3.5 CONFIGURATION OF SYSTEM UNDER TEST

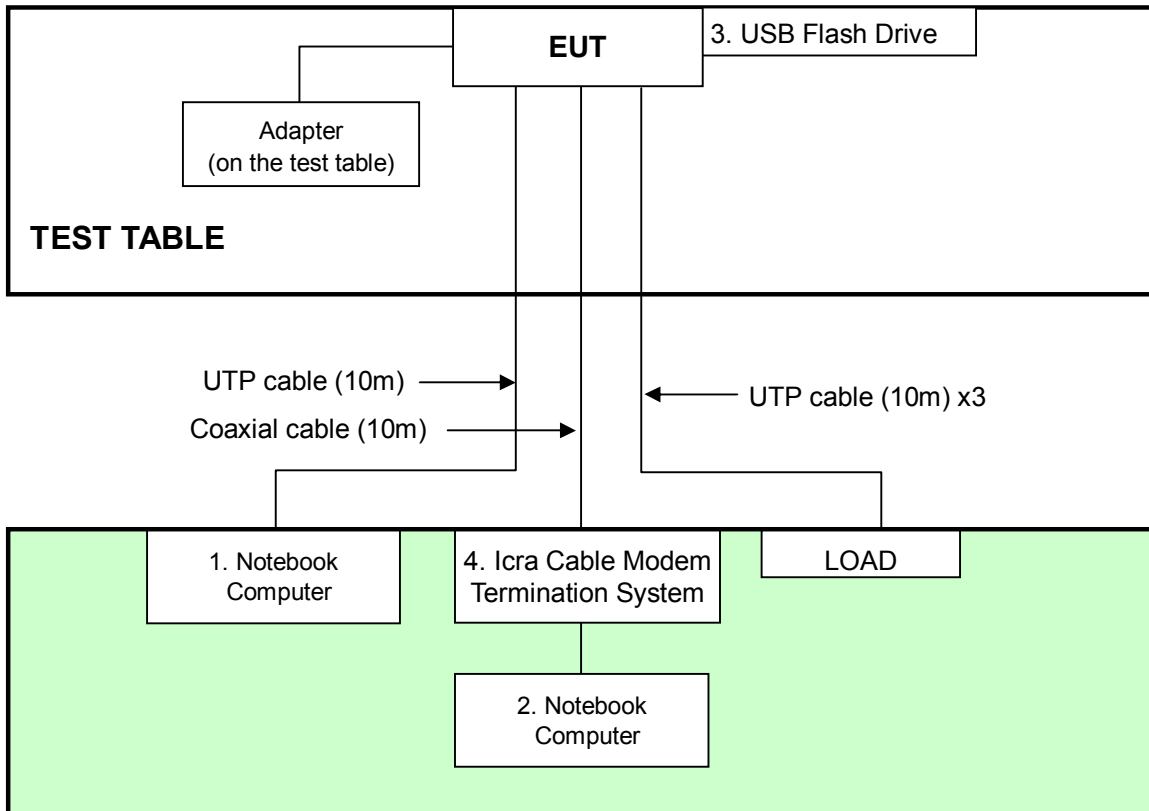



A D T

4. TEST TYPES AND RESULTS (802.11b & g, 2400 ~ 2483.5MHz Band)

4.1 CONDUCTED EMISSION MEASUREMENT

4.1.1 LIMITS OF CONDUCTED EMISSION MEASUREMENT

FREQUENCY OF EMISSION (MHz)	CONDUCTED LIMIT (dBµV)	
0.15-0.5	Quasi-peak	Average
0.5-5	66 to 56	56 to 46
5-30	56	46
	60	50

- NOTE:**
1. The lower limit shall apply at the transition frequencies.
 2. The limit decreases in line with the logarithm of the frequency in the range of 0.15 to 0.50 MHz.
 3. All emanations from a class A/B digital device or system, including any network of conductors and apparatus connected thereto, shall not exceed the level of field strengths specified above.

4.1.2 TEST INSTRUMENTS

DESCRIPTION & MANUFACTURER	MODEL NO.	SERIAL NO.	CALIBRATED DATE	CALIBRATED UNTIL
ROHDE & SCHWARZ Test Receiver	ESCS 30	100287	Mar. 05, 2009	Mar. 04, 2010
Line-Impedance Stabilization Network (for EUT)	KNW-407	8-1395-12	May 04, 2009	May 03, 2010
Line-Impedance Stabilization Network (for Peripheral)	ENV-216	100072	June 08, 2009	June 07, 2010
RF Cable (JYEBAO)	5DFB	COACAB-001	Dec 15, 2008	Dec 14, 2009
50 ohms Terminator	50	3	Nov. 05, 2009	Nov. 04, 2010
Software	BV ADT_Cond_V7.3.7	NA	NA	NA

Note:

1. The calibration interval of the above test instruments is 12 months and the calibrations are traceable to NML/ROC and NIST/USA.
2. The test was performed in Shielded Room No. A.
3. The VCCI Con A Registration No. is C-817.

4.1.3 TEST PROCEDURES

- a. The EUT was placed 0.4 meters from the conducting wall of the shielded room with EUT being connected to the power mains through a line impedance stabilization network (LISN). Other support units were connected to the power mains through another LISN. The two LISNs provide 50 ohm/ 50uH of coupling impedance for the measuring instrument.
- b. Both lines of the power mains connected to the EUT were checked for maximum conducted interference.
- c. The frequency range from 150kHz to 30MHz was searched. Emission levels under (Limit - 20dB) were not recorded.

4.1.4 DEVIATION FROM TEST STANDARD

No deviation

4.1.5 TEST SETUP

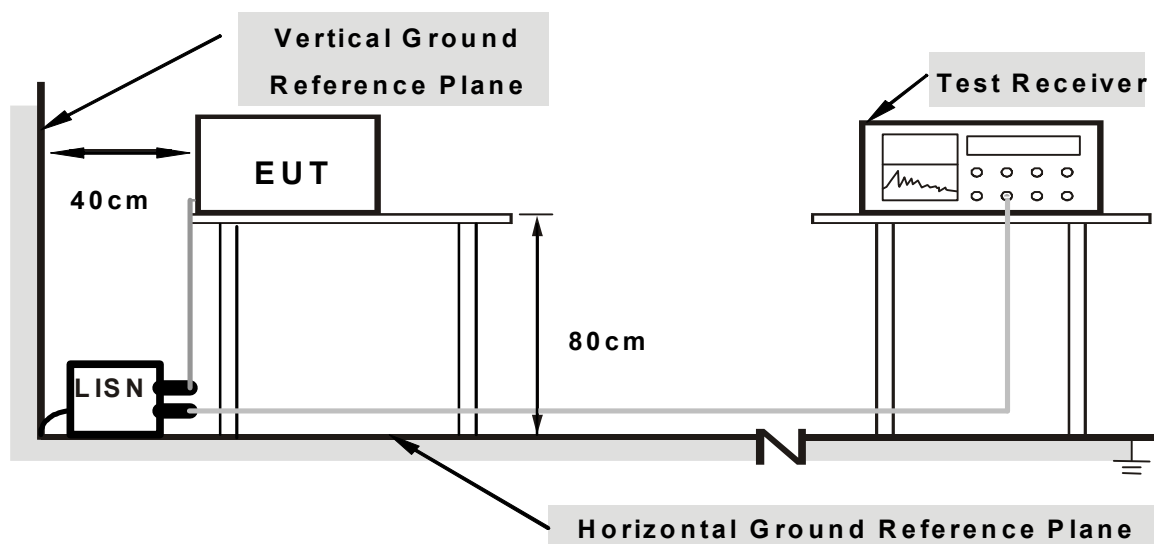

Note: 1. Support units were connected to second LISN.

2. Both of LISNs (AMN) are 80 cm from EUT and at least 80 from other units and other metal planes

For the actual test configuration, please refer to the related item – Photographs of the Test Configuration.

4.1.6 EUT OPERATING CONDITIONS

1. Placed the EUT on the testing table.
2. Prepared the computer systems (support units 1~2 & 4) to act as communication partners and placed them outside of testing area.
3. The communication partners run test program” Hyper terminal” to enable EUT under transmission/receiving condition continuously via one UTP cable and one coaxial cable.

4.1.7 TEST RESULTS

802.11n (20MHz) OFDM MODULATION:

TEST MODE	With adapter 1		
PHASE	Line (L)	6dB BANDWIDTH	9 kHz

No	Freq. [MHz]	Corr. Factor (dB)	Reading Value [dB (uV)]		Emission Level [dB (uV)]		Limit [dB (uV)]		Margin (dB)	
			Q.P.	AV.	Q.P.	AV.	Q.P.	AV.	Q.P.	AV.
1	0.161	0.25	57.46	49.47	57.71	49.72	65.43	55.43	-7.72	-5.71
2	0.216	0.16	54.08	42.51	54.24	42.67	62.96	52.96	-8.71	-10.28
3	0.269	0.14	49.83	-	49.97	-	61.16	51.16	-11.19	-
4	0.384	0.09	47.50	-	47.59	-	58.18	48.18	-10.60	-
5	0.494	0.08	48.66	33.38	48.74	33.46	56.10	46.10	-7.37	-12.65
6	0.599	0.07	48.47	35.75	48.54	35.82	56.00	46.00	-7.46	-10.18
7	0.713	0.07	48.52	33.25	48.59	33.32	56.00	46.00	-7.41	-12.68
8	0.931	0.06	47.62	37.20	47.68	37.26	56.00	46.00	-8.32	-8.74
9	5.000	0.15	40.90	-	41.05	-	56.00	46.00	-14.95	-
10	8.055	0.20	43.04	-	43.24	-	60.00	50.00	-16.76	-

- REMARKS:**
1. Q.P. and AV. are abbreviations of quasi-peak and average individually.
 2. "-": The Quasi-peak reading value also meets average limit and measurement with the average detector is unnecessary.
 3. The emission levels of other frequencies were very low against the limit.
 4. Margin value = Emission level - Limit value
 5. Correction factor = Insertion loss + Cable loss
 6. Emission Level = Correction Factor + Reading Value.

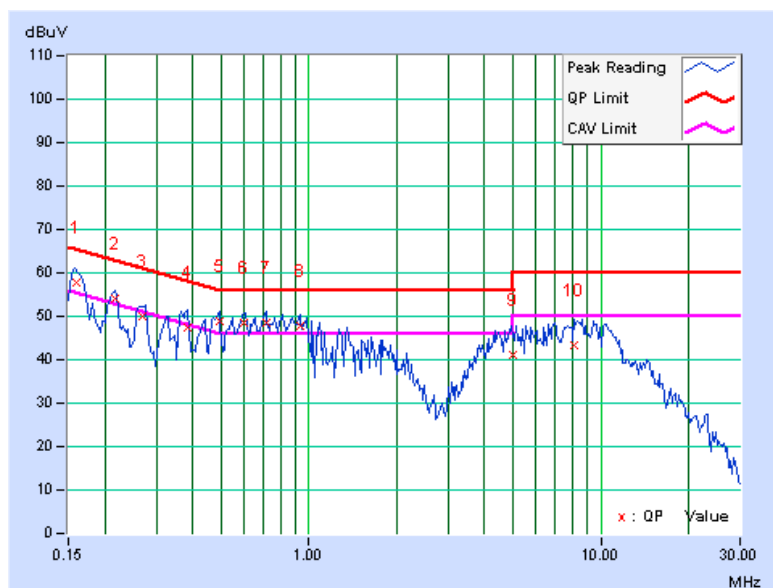

TEST MODE	With adapter 1		
PHASE	Neutral (N)	6dB BANDWIDTH	9 kHz

No	Freq. [MHz]	Corr. Factor (dB)	Reading Value [dB (uV)]		Emission Level [dB (uV)]		Limit [dB (uV)]		Margin (dB)	
			Q.P.	AV.	Q.P.	AV.	Q.P.	AV.	Q.P.	AV.
1	0.158	0.26	56.17	49.01	56.43	49.27	65.58	55.58	-9.15	-6.31
2	0.267	0.15	49.25	-	49.40	-	61.20	51.20	-11.81	-
3	0.373	0.10	47.56	-	47.66	-	58.44	48.44	-10.78	-
4	0.490	0.09	49.48	36.83	49.57	36.92	56.17	46.17	-6.60	-9.25
5	0.599	0.09	49.73	36.72	49.82	36.81	56.00	46.00	-6.18	-9.19
6	0.709	0.08	49.70	34.97	49.78	35.05	56.00	46.00	-6.22	-10.95
7	0.927	0.08	48.64	39.48	48.72	39.56	56.00	46.00	-7.28	-6.44
8	1.203	0.08	47.10	35.86	47.18	35.94	56.00	46.00	-8.82	-10.06

- REMARKS:**
1. Q.P. and AV. are abbreviations of quasi-peak and average individually.
 2. "-": The Quasi-peak reading value also meets average limit and measurement with the average detector is unnecessary.
 3. The emission levels of other frequencies were very low against the limit.
 4. Margin value = Emission level - Limit value
 5. Correction factor = Insertion loss + Cable loss
 6. Emission Level = Correction Factor + Reading Value.

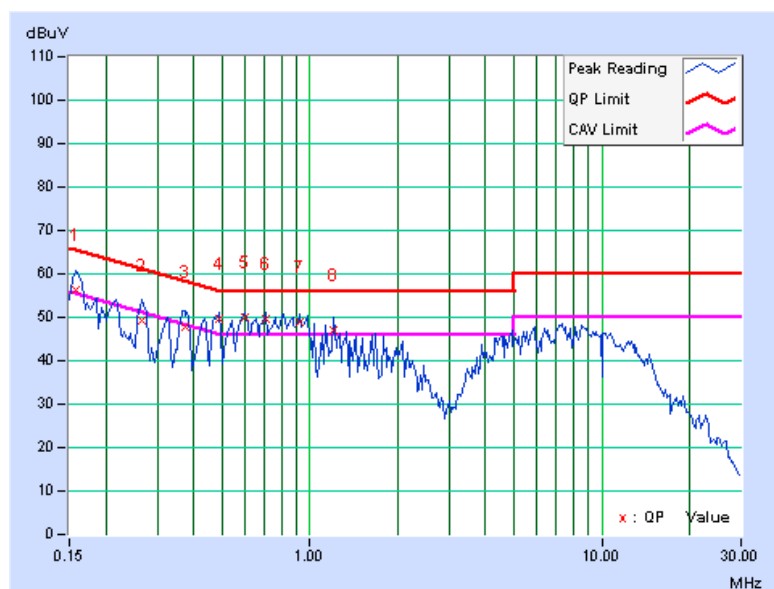

802.11n (20MHz) OFDM MODULATION:

TEST MODE	With adapter 2		
PHASE	Line (L)	6dB BANDWIDTH	9 kHz

No	Freq. [MHz]	Corr. Factor (dB)	Reading Value [dB (uV)]		Emission Level [dB (uV)]		Limit [dB (uV)]		Margin (dB)	
			Q.P.	AV.	Q.P.	AV.	Q.P.	AV.	Q.P.	AV.
			1	0.533	0.08	29.27	-	29.35	-	56.00
2	2.449	0.09	32.77	-	32.86	-	56.00	46.00	-23.14	-
3	2.973	0.10	34.22	-	34.32	-	56.00	46.00	-21.68	-
4	4.324	0.14	38.79	-	38.93	-	56.00	46.00	-17.07	-
5	14.770	0.35	36.53	-	36.88	-	60.00	50.00	-23.12	-
6	23.133	0.54	36.16	-	36.70	-	60.00	50.00	-23.30	-

- REMARKS:**
1. Q.P. and AV. are abbreviations of quasi-peak and average individually.
 2. "-": The Quasi-peak reading value also meets average limit and measurement with the average detector is unnecessary.
 3. The emission levels of other frequencies were very low against the limit.
 4. Margin value = Emission level - Limit value
 5. Correction factor = Insertion loss + Cable loss
 6. Emission Level = Correction Factor + Reading Value.

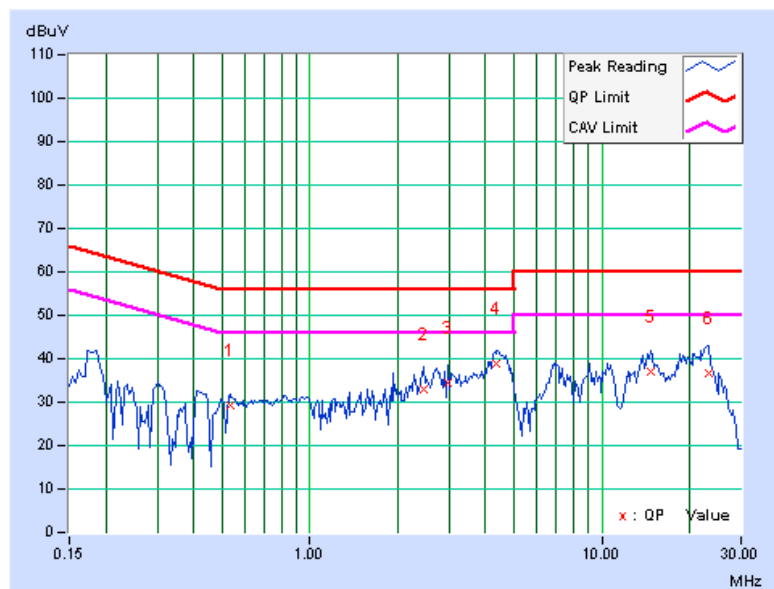

TEST MODE	With adapter 2		
PHASE	Neutral (N)	6dB BANDWIDTH	9 kHz

No	Freq. [MHz]	Corr. Factor (dB)	Reading Value [dB (uV)]		Emission Level [dB (uV)]		Limit [dB (uV)]		Margin (dB)	
			Q.P.	AV.	Q.P.	AV.	Q.P.	AV.	Q.P.	AV.
			1	0.177	0.22	41.59	-	41.81	-	64.61
2	0.241	0.16	35.21	-	35.37	-	62.07	52.07	-26.70	-
3	1.887	0.10	28.88	-	28.98	-	56.00	46.00	-27.02	-
4	4.266	0.16	35.65	-	35.81	-	56.00	46.00	-20.19	-
5	14.629	0.38	36.91	-	37.29	-	60.00	50.00	-22.71	-
6	18.770	0.49	36.68	-	37.17	-	60.00	50.00	-22.83	-

- REMARKS:**
1. Q.P. and AV. are abbreviations of quasi-peak and average individually.
 2. "-": The Quasi-peak reading value also meets average limit and measurement with the average detector is unnecessary.
 3. The emission levels of other frequencies were very low against the limit.
 4. Margin value = Emission level - Limit value
 5. Correction factor = Insertion loss + Cable loss
 6. Emission Level = Correction Factor + Reading Value.

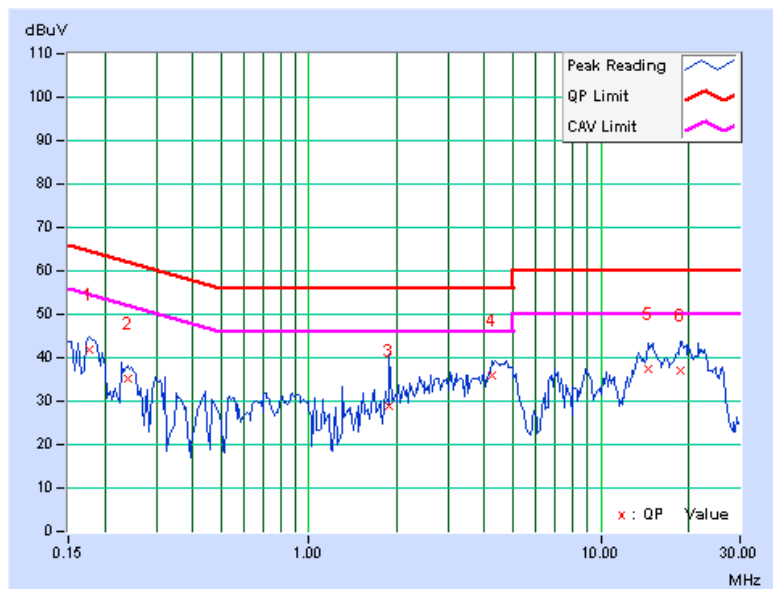

4.2 RADIATED EMISSION MEASUREMENT

4.2.1 LIMITS OF RADIATED EMISSION MEASUREMENT

Emissions radiated outside of the specified bands, shall be according to the general radiated limits in 15.209 as following:

Frequencies (MHz)	Field strength (microvolts/meter)	Measurement distance (meters)
0.009-0.490	2400/F(kHz)	300
0.490-1.705	24000/F(kHz)	30
1.705-30.0	30	30
30-88	100	3
88-216	150	3
216-960	200	3
Above 960	500	3

NOTE:

1. The lower limit shall apply at the transition frequencies.
2. Emission level (dBuV/m) = 20 log Emission level (uV/m).
3. As shown in 15.35(b), for frequencies above 1000MHz, the field strength limits are based on average detector, however, the peak field strength of any emission shall not exceed the maximum permitted average limits, specified above by more than 20dB under any condition of modulation.



A D T

4.2.2 TEST INSTRUMENTS

Below 1GHz:

DESCRIPTION & MANUFACTURER	MODEL NO.	SERIAL NO.	CALIBRATED DATE	CALIBRATED UNTIL
ADVANTEST Spectrum Analyzer	U3751	160200410	July 17, 2009	July 16, 2010
ADVANTEST Spectrum Analyzer	U3772	160100280	Sep. 21, 2009	Sep. 20, 2010
HP Pre_Amplifier	8449B	3008A01922	Sep. 25, 2009	Sep. 24, 2010
ROHDE & SCHWARZ Test Receiver	ESVS 30	841977/002	Oct. 28, 2009	Oct. 27, 2010
SCHAFFNER(CHASE) Broadband Antenna	CBL6112B	2798	April 29, 2009	April 28, 2010
Schwarzbeck Horn_Antenna	BBHA9120-D1	D123	Sep. 21, 2009	Sep. 20, 2010
Schwarzbeck Horn_Antenna	BBHA 9170	BBHA9170153	Jan. 23, 2009	Jan. 22, 2010
RF Switches	MP59B	6100175593	Sep. 01, 2009	Aug. 31, 2010
RF Cable	8DFB	STBCAB-001	Sep. 01, 2009	Aug. 31, 2010
Software	ADT_Radiated_V7.6.15.9.2	NA	NA	NA
CT Antenna Tower & Turn Table	NA	NA	NA	NA
CORCOM AC Filter	MRI2030	024/019	NA	NA

Note: 1. The calibration interval of the above test instruments is 12 months and the calibrations are traceable to NML/ROC and NIST/USA.

2. The horn antenna, HP preamplifier (model: 8449B) and Spectrum Analyzer (model: U3772) are used only for the measurement of emission frequency above 1GHz if tested.
3. The test was performed in Open Site No. B.
4. The VCCI Site Registration No. is R-847.
5. The FCC Site Registration No. is 92753.
6. The CANADA Site Registration No. is IC 7450G-2.



A D T

Above 1GHz:

DESCRIPTION & MANUFACTURER	MODEL NO.	SERIAL NO.	CALIBRATED DATE	CALIBRATED UNTIL
ROHDE & SCHWARZ Spectrum Analyzer	FSP40	100036	Dec. 9, 2009	Dec. 8, 2010
Agilent PSA Spectrum Analyzer	E4446A	MY46180622	Apr. 24 , 2009	Apr. 23 , 2010
HP Pre_Amplifier	8449B	3008A01923	Nov. 02, 2009	Nov. 01, 2010
ROHDE & SCHWARZ Test Receiver	ESCS30	847124/029	Aug. 28, 2009	Aug. 28, 2010
SCHWARZBECK TRILOG Broadband Antenna	VULB 9168	138	April 29, 2009	April 28, 2010
Schwarzbeck Horn_Antenna	BBHA9120	D124	Dec. 09, 2009	Dec. 08, 2010
Schwarzbeck Horn_Antenna	BBHA 9170	BBHA9170153	Jan. 22, 2009	Jan. 21, 2010
RF Switches	EMH-011	08009	Sep. 26, 2009	Sep. 25, 2010
RF CABLE (Chaintek)	Sucoflex 106	28077	Aug. 14, 2009	Aug. 13, 2010
RF Cable	8D	STCCAB-001	Sep. 26, 2009	Sep. 25, 2010
Software	ADT_Radiated_V7.6.15.9.2	NA	NA	NA
CT Antenna Tower & Turn Table	NA	NA	NA	NA

- Note: 1. The calibration interval of the above test instruments is 12 months and the calibrations are traceable to NML/ROC and NIST/USA.
2. The horn antenna, HP preamplifier (model: 8449B) and Spectrum Analyzer (model: FSP40) are used only for the measurement of emission frequency above 1GHz if tested.
3. The test was performed in Open Site No. C.
4. The FCC Site Registration No. is 656396.
5. The VCCI Site Registration No. is R-1626.
6. The CANADA Site Registration No. is IC 7450G-3.



A D T

4.2.3 TEST PROCEDURES

- a. The EUT was placed on the top of a rotating table 0.8 meters above the ground at a 10 meter open area test site. The table was rotated 360 degrees to determine the position of the highest radiation.
- b. The EUT was set 3 meters away from the interference-receiving antenna, which was mounted on the top of a variable-height antenna tower.
- c. The antenna is a broadband antenna, and its height is varied from one meter to four meters above the ground to determine the maximum value of the field strength. Both horizontal and vertical polarizations of the antenna are set to make the measurement.
- d. For each suspected emission, the EUT was arranged to its worst case and then the antenna was tuned to heights from 1 meter to 4 meters and the rotatable table was turned from 0 degrees to 360 degrees to find the maximum reading.
- e. The test-receiver system was set to Peak Detect Function and Specified Bandwidth with Maximum Hold Mode.
- f. If the emission level of the EUT in peak mode was 10dB lower than the limit specified, then testing could be stopped and the peak values of the EUT would be reported. Otherwise the emissions that did not have 10dB margin would be re-tested one by one using peak, quasi-peak or average method as specified and then reported in a data sheet.

NOTE:

1. The resolution bandwidth and video bandwidth of test receiver/spectrum analyzer is 120kHz for Peak detection (PK) and Quasi-peak detection (QP) at frequency below 1GHz.
2. The resolution bandwidth of test receiver/spectrum analyzer is 1 MHz and the video bandwidth is 3 MHz for Peak detection (PK) at frequency above 1GHz.
3. The resolution bandwidth of test receiver/spectrum analyzer is 1 MHz and the video bandwidth is 10 Hz for Average detection (AV) at frequency above 1GHz.

4.2.4 DEVIATION FROM TEST STANDARD

No deviation

4.2.5 TEST SETUP

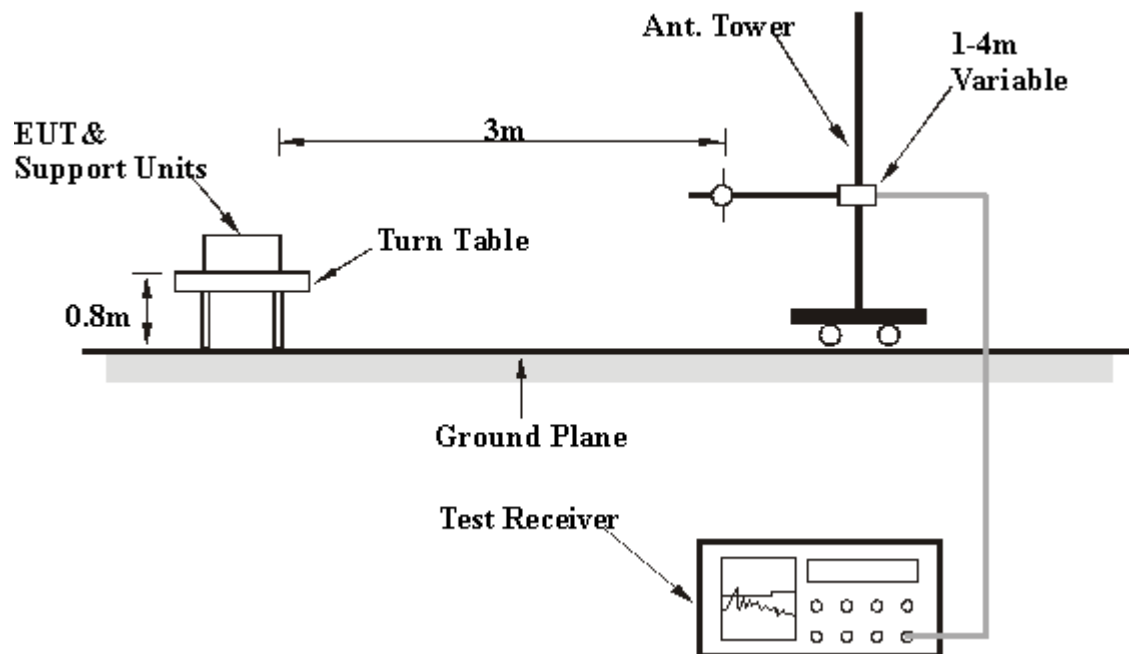

For the actual test configuration, please refer to the related item – Photographs of the Test Configuration.

4.2.6 EUT OPERATING CONDITIONS

Same as 4.1.6



A D T

4.2.7 TEST RESULTS

BELOW 1GHz DATA : 802.11n (20MHz) OFDM MODULATION

EUT TEST CONDITION		MEASUREMENT DETAIL	
CHANNEL	Channel 6	FREQUENCY RANGE	Below 1000MHz
INPUT POWER	120Vac, 60 Hz	DETECTOR FUNCTION	Quasi-Peak
ENVIRONMENTAL CONDITIONS	25deg. C, 60%RH 1024 hPa	TESTED BY	Eagle Chen

ANTENNA POLARITY & TEST DISTANCE: HORIZONTAL AT 3 M								
NO.	FREQ. (MHz)	EMISSION LEVEL (dBuV/m)	LIMIT (dBuV/m)	MARGIN (dB)	ANTENNA HEIGHT (m)	TABLE ANGLE (Degree)	RAW VALUE (dBuV)	CORRECTION FACTOR (dB/m)
1	250.00	35.9 QP	46.0	-10.1	1.64 H	66	21.90	14.00
2	336.00	37.3 QP	46.0	-8.7	1.58 H	312	20.95	16.33
3	375.00	37.3 QP	46.0	-8.7	4.00 H	221	19.93	17.38
4	454.80	37.4 QP	46.0	-8.6	1.43 H	196	18.03	19.40
5	500.00	34.5 QP	46.0	-11.5	1.33 H	123	14.11	20.36
6	960.00	37.4 QP	46.0	-8.6	1.00 H	42	12.11	25.33
7	999.99	40.0 QP	54.0	-14.0	1.00 H	244	14.46	25.56

ANTENNA POLARITY & TEST DISTANCE: VERTICAL AT 3 M								
NO.	FREQ. (MHz)	EMISSION LEVEL (dBuV/m)	LIMIT (dBuV/m)	MARGIN (dB)	ANTENNA HEIGHT (m)	TABLE ANGLE (Degree)	RAW VALUE (dBuV)	CORRECTION FACTOR (dB/m)
1	250.40	34.8 QP	46.0	-11.2	1.00 V	41	20.77	14.01
2	333.33	35.8 QP	46.0	-10.2	1.00 V	300	19.52	16.26
3	375.80	35.4 QP	46.0	-10.6	1.00 V	107	18.04	17.40
4	453.23	38.3 QP	46.0	-7.7	1.00 V	136	18.90	19.37
5	500.01	35.4 QP	46.0	-10.6	1.00 V	131	15.01	20.36
6	960.00	36.1 QP	46.0	-9.9	1.57 V	128	10.74	25.33
7	999.99	44.1 QP	54.0	-9.9	1.47 V	13	18.58	25.56

- REMARKS:**
1. Emission level (dBuV/m) = Raw Value (dBuV) + Correction Factor (dB/m).
 2. Correction Factor (dB/m) = Antenna Factor (dB/m) + Cable Factor (dB).
 3. The other emission levels were very low against the limit.
 4. Margin value = Emission level – Limit value.



A D T

**ABOVE 1GHz WORST-CASE DATA
802.11b DSSS MODULATION**

EUT TEST CONDITION		MEASUREMENT DETAIL	
CHANNEL	Channel 1	FREQUENCY RANGE	1 ~ 25GHz
INPUT POWER	120Vac, 60 Hz	DETECTOR FUNCTION	Peak (PK) Average (AV)
ENVIRONMENTAL CONDITIONS	25deg. C, 66%RH 1024 hPa	TESTED BY	Frank Liu

ANTENNA POLARITY & TEST DISTANCE: HORIZONTAL AT 3 M								
NO.	FREQ. (MHz)	EMISSION LEVEL (dBuV/m)	LIMIT (dBuV/m)	MARGIN (dB)	ANTENNA HEIGHT (m)	TABLE ANGLE (Degree)	RAW VALUE (dBuV)	CORRECTION FACTOR (dB/m)
1	2390.00	56.2 PK	74.0	-17.8	1.22 H	58	25.89	30.28
2	2390.00	42.4 AV	54.0	-11.6	1.22 H	58	12.12	30.28
3	*2412.00	99.0 PK			1.34 H	59	68.64	30.36
4	*2412.00	93.3 AV			1.34 H	59	62.94	30.36
5	4824.00	46.4 PK	74.0	-27.6	1.54 H	112	9.61	36.79
6	4824.00	38.7 AV	54.0	-15.3	1.54 H	112	1.91	36.79
7	5000.00	46.4 PK	74.0	-27.6	1.27 H	136	9.14	37.26
8	5000.00	40.0 AV	54.0	-14.0	1.27 H	136	2.74	37.26
9	#7236.00	52.3 PK	79.0	-26.7	1.00 H	213	9.16	43.14
10	#7236.00	38.3 AV	73.3	-35.0	1.00 H	213	-4.84	43.14
11	12500.00	55.3 PK	74.0	-18.7	1.44 H	351	8.46	46.84
12	12500.00	45.0 AV	54.0	-9.0	1.44 H	351	-1.84	46.84

ANTENNA POLARITY & TEST DISTANCE: VERTICAL AT 3 M								
NO.	FREQ. (MHz)	EMISSION LEVEL (dBuV/m)	LIMIT (dBuV/m)	MARGIN (dB)	ANTENNA HEIGHT (m)	TABLE ANGLE (Degree)	RAW VALUE (dBuV)	CORRECTION FACTOR (dB/m)
1	2333.30	55.8 PK	74.0	-18.2	1.00 V	59	25.77	30.07
2	2333.30	48.2 AV	54.0	-5.9	1.00 V	59	18.08	30.07
3	*2412.00	105.5 PK			1.00 V	317	75.14	30.36
4	*2412.00	103.5 AV			1.00 V	317	73.14	30.36
5	4824.00	46.3 PK	74.0	-27.7	1.19 V	90	9.51	36.79
6	4824.00	38.6 AV	54.0	-15.4	1.19 V	90	1.81	36.79
7	5000.00	51.8 PK	74.0	-22.2	1.62 V	4	14.54	37.26
8	5000.00	47.2 AV	54.0	-6.8	1.62 V	4	9.94	37.26
9	#7236.00	52.0 PK	85.5	-33.5	1.00 V	360	8.86	43.14
10	#7236.00	38.4 AV	83.5	-45.1	1.00 V	360	-4.74	43.14
11	12500.00	57.0 PK	74.0	-17.0	1.25 V	339	10.16	46.84
12	12500.00	47.6 AV	54.0	-6.4	1.25 V	339	0.76	46.84

- REMARKS:**
1. Emission level (dBuV/m) = Raw Value (dBuV) + Correction Factor (dB/m).
 2. Correction Factor (dB/m) = Antenna Factor (dB/m) + Cable Factor (dB).
 3. The other emission levels were very low against the limit.
 4. Margin value = Emission level – Limit value.
 5. “ * “: Fundamental frequency.
 6. “#”:The radiated frequency is out the restricted band.



A D T

EUT TEST CONDITION		MEASUREMENT DETAIL	
CHANNEL	Channel 6	FREQUENCY RANGE	1 ~ 25GHz
INPUT POWER	120Vac, 60 Hz	DETECTOR FUNCTION	Peak (PK) Average (AV)
ENVIRONMENTAL CONDITIONS	25deg. C, 66%RH 1024 hPa	TESTED BY	Frank Liu

ANTENNA POLARITY & TEST DISTANCE: HORIZONTAL AT 3 M								
NO.	FREQ. (MHz)	EMISSION LEVEL (dBuV/m)	LIMIT (dBuV/m)	MARGIN (dB)	ANTENNA HEIGHT (m)	TABLE ANGLE (Degree)	RAW VALUE (dBuV)	CORRECTION FACTOR (dB/m)
1	*2437.00	99.5 PK			1.36 H	73	69.04	30.46
2	*2437.00	93.6 AV			1.36 H	73	63.14	30.46
3	2500.00	56.0 PK	74.0	-18.0	1.26 H	58	25.31	30.69
4	2500.00	42.7 AV	54.0	-11.3	1.26 H	58	12.01	30.69
5	4874.00	43.1 PK	74.0	-30.9	1.56 H	113	6.18	36.92
6	4874.00	33.4 AV	54.0	-20.6	1.56 H	113	-3.52	36.92
7	5000.00	47.2 PK	74.0	-26.8	1.24 H	131	9.94	37.26
8	5000.00	40.6 AV	54.0	-13.4	1.24 H	131	3.34	37.26
9	7311.00	52.7 PK	74.0	-21.3	1.00 H	211	9.56	43.14
10	7311.00	38.6 AV	54.0	-15.4	1.00 H	211	-4.54	43.14
11	12500.00	55.1 PK	74.0	-18.9	1.44 H	344	8.26	46.84
12	12500.00	45.2 AV	54.0	-8.8	1.44 H	344	-1.64	46.84

ANTENNA POLARITY & TEST DISTANCE: VERTICAL AT 3 M								
NO.	FREQ. (MHz)	EMISSION LEVEL (dBuV/m)	LIMIT (dBuV/m)	MARGIN (dB)	ANTENNA HEIGHT (m)	TABLE ANGLE (Degree)	RAW VALUE (dBuV)	CORRECTION FACTOR (dB/m)
1	*2437.00	106.7 PK			1.00 V	318	76.24	30.46
2	*2437.00	104.7 AV			1.00 V	318	74.25	30.46
3	2500.00	60.4 PK	74.0	-13.6	1.00 V	306	29.71	30.69
4	2500.00	52.2 AV	54.0	-1.8	1.00 V	306	21.51	30.69
5	4874.00	42.9 PK	74.0	-31.1	1.00 V	360	5.98	36.92
6	4874.00	32.1 AV	54.0	-21.9	1.00 V	360	-4.85	36.92
7	5000.00	51.3 PK	74.0	-22.7	1.58 V	358	14.04	37.26
8	5000.00	47.7 AV	54.0	-6.3	1.58 V	358	10.44	37.26
9	7311.00	50.5 PK	74.0	-23.5	1.51 V	8	7.36	43.14
10	7311.00	40.6 AV	54.0	-13.4	1.51 V	8	-2.54	43.14
11	12500.00	56.0 PK	74.0	-18.0	1.25 V	336	9.16	46.84
12	12500.00	47.0 AV	54.0	-7.0	1.25 V	336	0.16	46.84

- REMARKS:**
1. Emission level (dBuV/m) = Raw Value (dBuV) + Correction Factor (dB/m).
 2. Correction Factor (dB/m) = Antenna Factor (dB/m) + Cable Factor (dB).
 3. The other emission levels were very low against the limit.
 4. Margin value = Emission level – Limit value.
 5. “ * “: Fundamental frequency.



A D T

EUT TEST CONDITION		MEASUREMENT DETAIL	
CHANNEL	Channel 11	FREQUENCY RANGE	1 ~ 25GHz
INPUT POWER	120Vac, 60 Hz	DETECTOR FUNCTION	Peak (PK) Average (AV)
ENVIRONMENTAL CONDITIONS	25deg. C, 66%RH 1024 hPa	TESTED BY	Frank Liu

ANTENNA POLARITY & TEST DISTANCE: HORIZONTAL AT 3 M								
NO.	FREQ. (MHz)	EMISSION LEVEL (dBuV/m)	LIMIT (dBuV/m)	MARGIN (dB)	ANTENNA HEIGHT (m)	TABLE ANGLE (Degree)	RAW VALUE (dBuV)	CORRECTION FACTOR (dB/m)
1	*2462.00	99.2 PK			1.28 H	72	68.65	30.55
2	*2462.00	93.1 AV			1.28 H	72	62.55	30.55
3	2483.50	54.7 PK	74.0	-19.3	1.21 H	96	24.09	30.63
4	2483.50	42.0 AV	54.0	-12.0	1.21 H	96	11.38	30.63
5	4924.00	47.2 PK	74.0	-26.8	1.53 H	119	10.14	37.06
6	4924.00	39.2 AV	54.0	-14.8	1.53 H	119	2.14	37.06
7	5000.00	46.1 PK	74.0	-27.9	1.26 H	129	8.84	37.26
8	5000.00	40.3 AV	54.0	-13.7	1.26 H	129	3.04	37.26
9	7386.00	52.4 PK	74.0	-21.6	1.00 H	219	9.27	43.13
10	7386.00	38.1 AV	54.0	-15.9	1.00 H	219	-5.03	43.13
11	12500.00	55.3 PK	74.0	-18.7	1.28 H	345	8.46	46.84
12	12500.00	45.4 AV	54.0	-8.6	1.28 H	345	-1.44	46.84

ANTENNA POLARITY & TEST DISTANCE: VERTICAL AT 3 M								
NO.	FREQ. (MHz)	EMISSION LEVEL (dBuV/m)	LIMIT (dBuV/m)	MARGIN (dB)	ANTENNA HEIGHT (m)	TABLE ANGLE (Degree)	RAW VALUE (dBuV)	CORRECTION FACTOR (dB/m)
1	*2462.00	106.3 PK			1.00 V	318	75.75	30.55
2	*2462.00	103.8 AV			1.00 V	318	73.25	30.55
3	2500.00	60.1 PK	74.0	-13.9	1.00 V	308	29.38	30.69
4	2500.00	51.4 AV	54.0	-2.6	1.00 V	308	20.67	30.69
5	4924.00	47.7 PK	74.0	-26.3	1.16 V	339	10.62	37.06
6	4924.00	41.7 AV	54.0	-12.3	1.16 V	339	4.64	37.06
7	5000.00	51.4 PK	74.0	-22.6	1.67 V	6	14.14	37.26
8	5000.00	47.7 AV	54.0	-6.3	1.67 V	6	10.44	37.26
9	7386.00	46.8 PK	74.0	-27.2	1.00 V	360	3.67	43.13
10	7386.00	38.7 AV	54.0	-15.3	1.00 V	360	-4.43	43.13
11	12500.00	56.3 PK	74.0	-17.7	1.25 V	337	9.46	46.84
12	12500.00	47.4 AV	54.0	-6.6	1.25 V	337	0.56	46.84

- REMARKS:**
1. Emission level (dBuV/m) = Raw Value (dBuV) + Correction Factor (dB/m).
 2. Correction Factor (dB/m) = Antenna Factor (dB/m) + Cable Factor (dB).
 3. The other emission levels were very low against the limit.
 4. Margin value = Emission level – Limit value.
 5. “ * “: Fundamental frequency.



A D T

RESTRICTED BANDEDGE (802.11b MODE, CH1, HORIZONTAL)

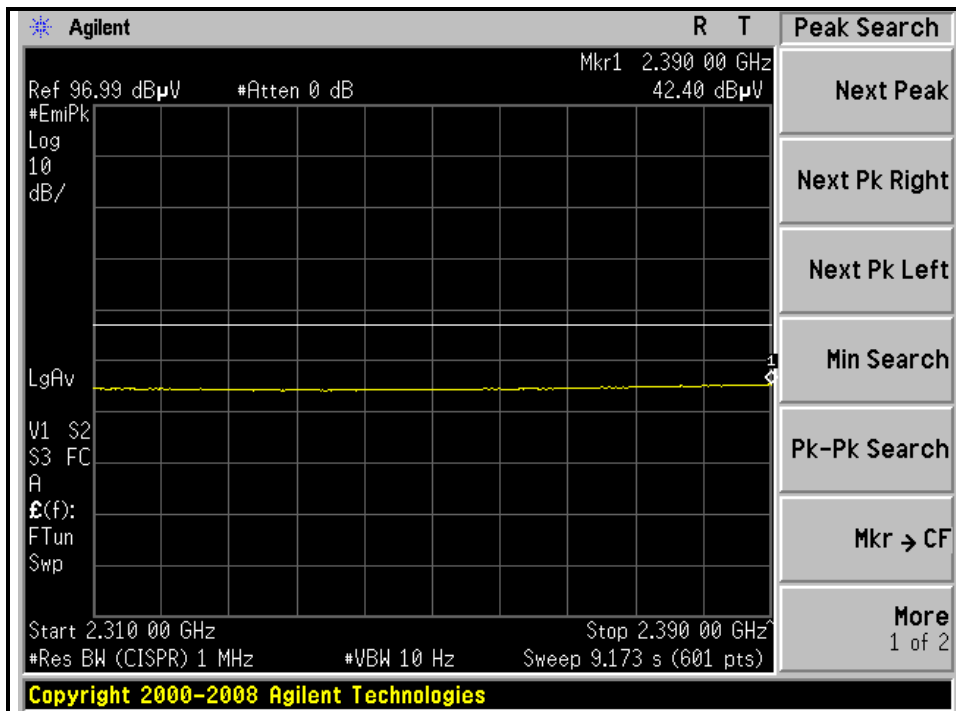
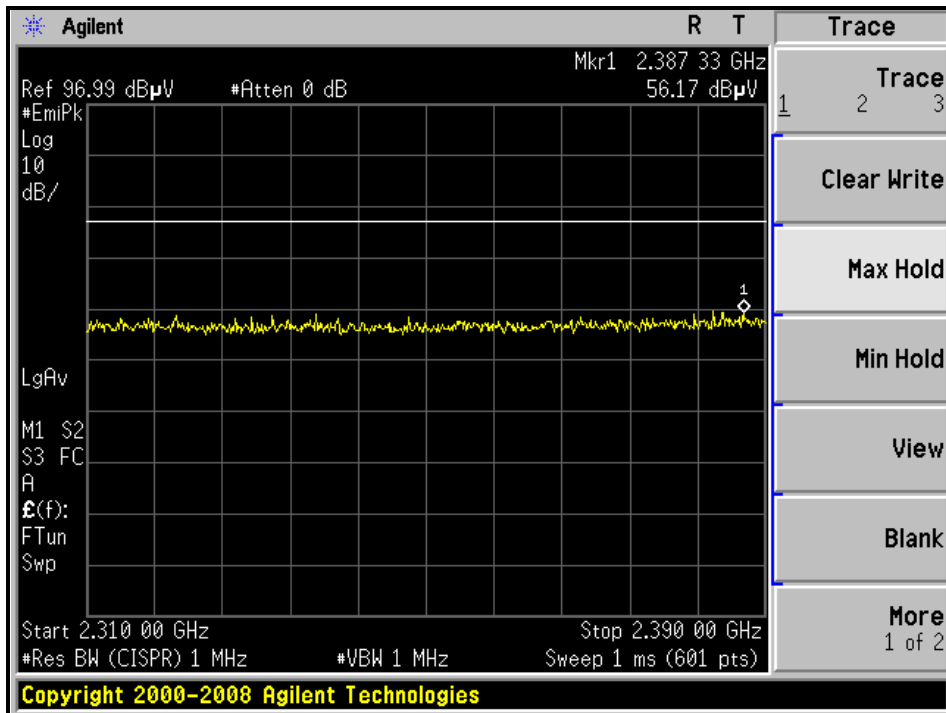



A D T

RESTRICTED BANDEDGE (802.11b MODE, CH1, VERTICAL)

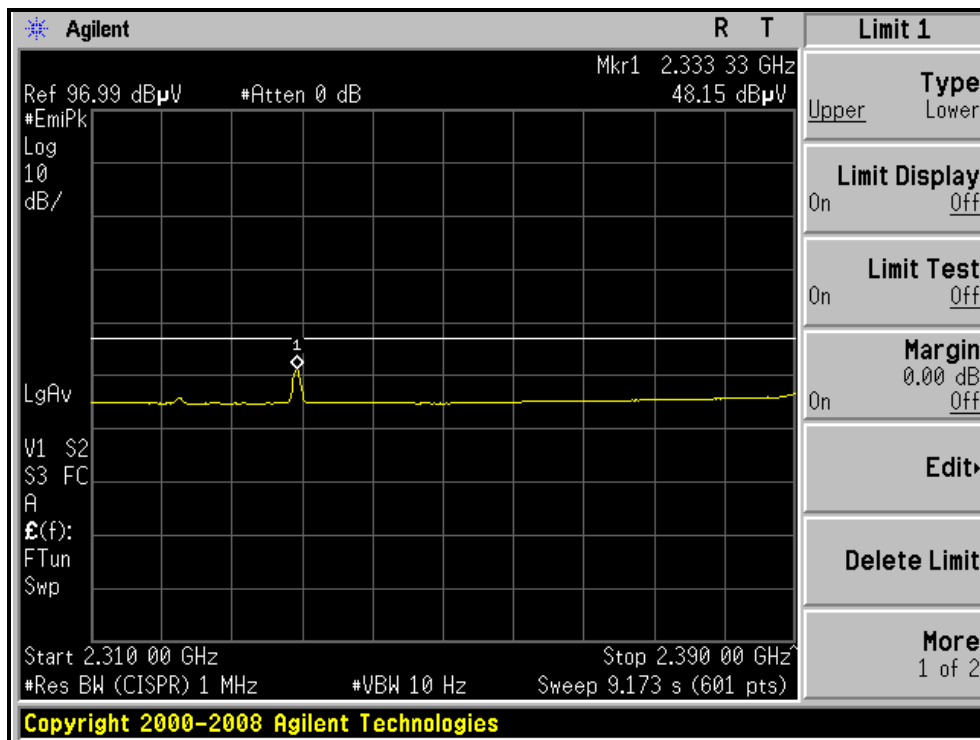
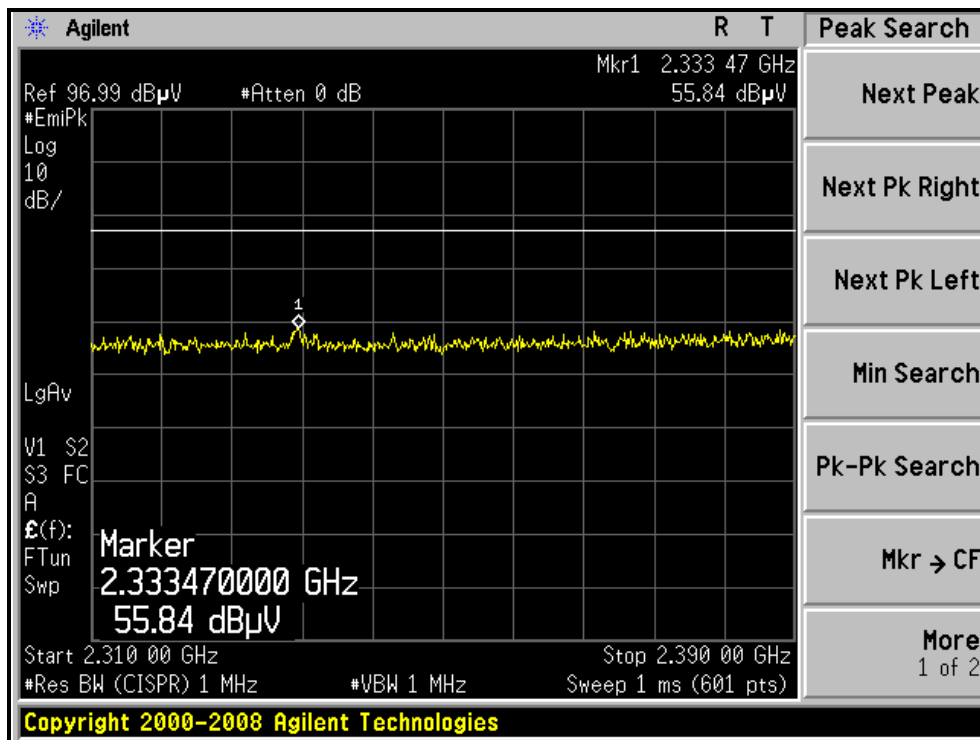

RESTRICTED BANDEDGE (802.11b MODE, CH11, HORIZONTAL)

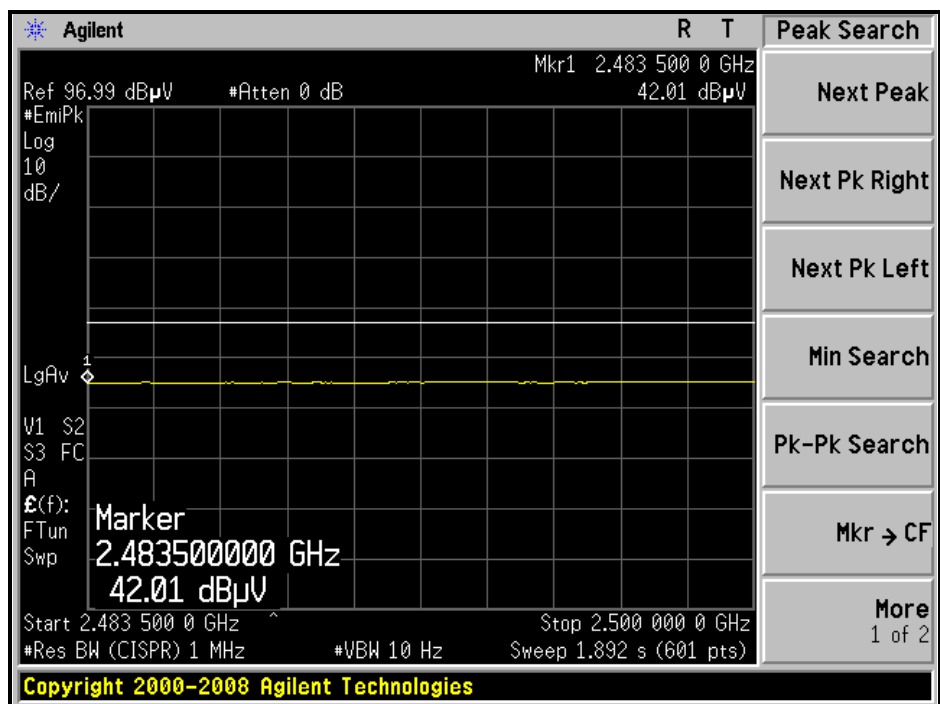
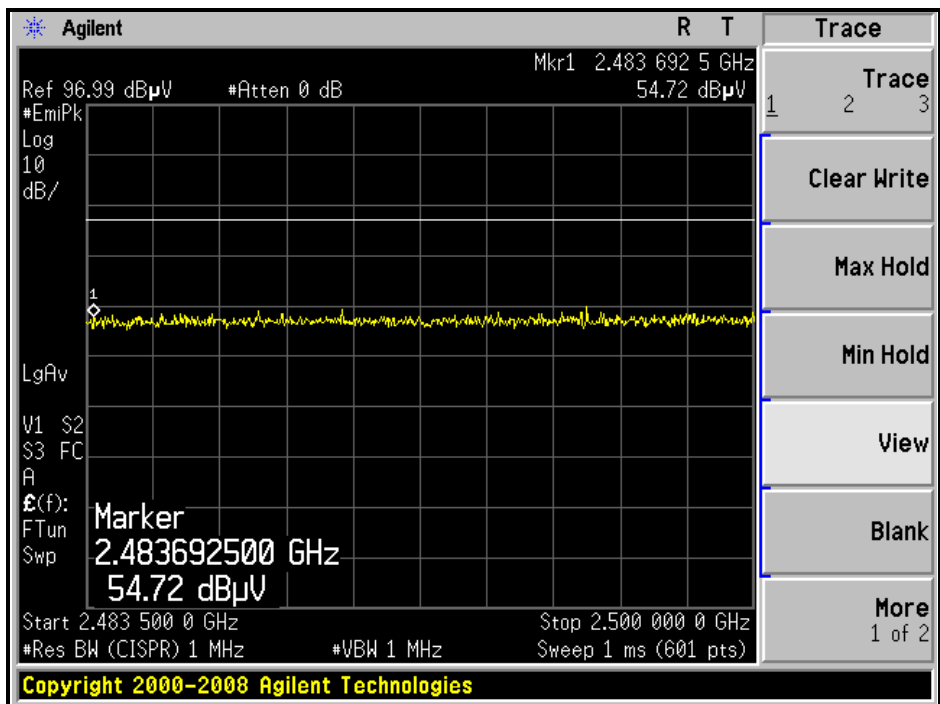



A D T

RESTRICTED BANDEDGE (802.11b MODE, CH11, VERTICAL)

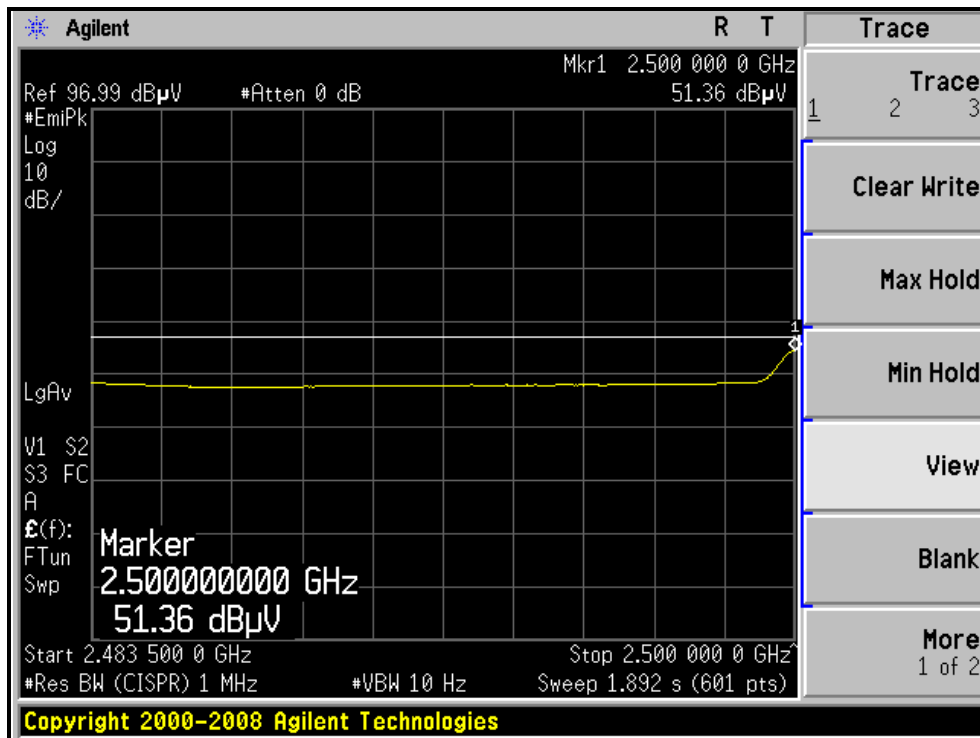
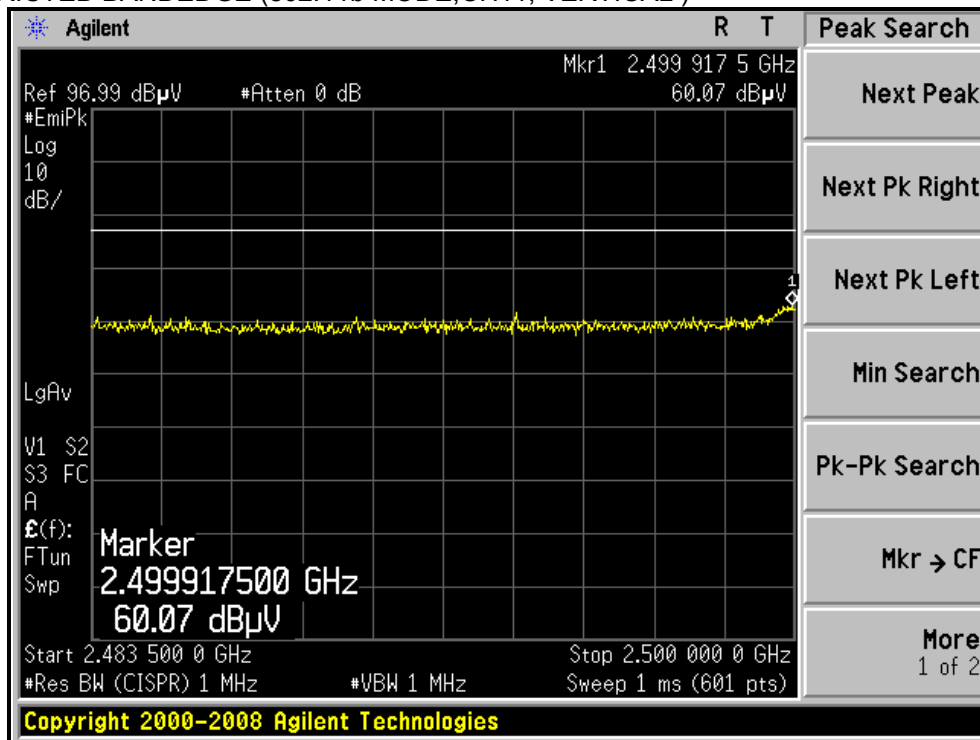



A D T

802.11g OFDM MODULATION

EUT TEST CONDITION		MEASUREMENT DETAIL	
CHANNEL	Channel 1	FREQUENCY RANGE	1 ~ 25GHz
INPUT POWER	120Vac, 60 Hz	DETECTOR FUNCTION	Peak (PK) Average (AV)
ENVIRONMENTAL CONDITIONS	25deg. C, 66%RH 1024 hPa	TESTED BY	Frank Liu

ANTENNA POLARITY & TEST DISTANCE: HORIZONTAL AT 3 M

NO.	FREQ. (MHz)	EMISSION LEVEL (dBuV/m)	LIMIT (dBuV/m)	MARGIN (dB)	ANTENNA HEIGHT (m)	TABLE ANGLE (Degree)	RAW VALUE (dBuV)	CORRECTION FACTOR (dB/m)
1	2389.87	63.0 PK	74.0	-11.0	1.34 H	59	32.74	30.28
2	2389.87	45.7 AV	54.0	-8.3	1.34 H	59	15.44	30.28
3	*2412.00	96.3 PK			1.34 H	57	65.94	30.36
4	*2412.00	85.7 AV			1.34 H	57	55.34	30.36
5	4824.00	43.2 PK	74.0	-30.8	1.41 H	126	6.41	36.79
6	4824.00	35.4 AV	54.0	-18.6	1.41 H	126	-1.39	36.79
7	5000.00	45.8 PK	74.0	-28.2	1.24 H	132	8.54	37.26
8	5000.00	40.1 AV	54.0	-13.9	1.24 H	132	2.84	37.26
9	#7236.00	53.1 PK	76.3	-23.2	1.00 H	239	9.96	43.14
10	#7236.00	38.4 AV	65.7	-27.3	1.00 H	239	-4.74	43.14
11	12500.00	55.5 PK	74.0	-18.5	1.27 H	340	8.66	46.84
12	12500.00	45.6 AV	54.0	-8.4	1.27 H	340	-1.24	46.84

ANTENNA POLARITY & TEST DISTANCE: VERTICAL AT 3 M

NO.	FREQ. (MHz)	EMISSION LEVEL (dBuV/m)	LIMIT (dBuV/m)	MARGIN (dB)	ANTENNA HEIGHT (m)	TABLE ANGLE (Degree)	RAW VALUE (dBuV)	CORRECTION FACTOR (dB/m)
1	2390.00	73.3 PK	74.0	-0.7	1.00 V	150	43.02	30.28
2	2390.00	52.2 AV	54.0	-1.8	1.00 V	150	21.92	30.28
3	*2412.00	107.5 PK			1.00 V	148	77.14	30.36
4	*2412.00	95.6 AV			1.00 V	148	65.20	30.36
5	4824.00	43.6 PK	74.0	-30.4	1.04 V	324	6.81	36.79
6	4824.00	35.3 AV	54.0	-18.7	1.04 V	324	-1.49	36.79
7	5000.00	51.6 PK	74.0	-22.4	1.57 V	7	14.34	37.26
8	5000.00	47.9 AV	54.0	-6.1	1.57 V	7	10.64	37.26
9	#7236.00	46.1 PK	87.5	-41.4	1.00 V	279	2.96	43.14
10	#7236.00	38.2 AV	75.6	-37.4	1.00 V	279	-4.94	43.14
11	12500.00	56.2 PK	74.0	-17.8	1.24 V	339	9.36	46.84
12	12500.00	47.2 AV	54.0	-6.8	1.24 V	339	0.36	46.84

- REMARKS:**
1. Emission level (dBuV/m) = Raw Value (dBuV) + Correction Factor (dB/m).
 2. Correction Factor (dB/m) = Antenna Factor (dB/m) + Cable Factor (dB).
 3. The other emission levels were very low against the limit.
 4. Margin value = Emission level – Limit value.
 5. “ * “: Fundamental frequency.
 6. “#“: The radiated frequency is out the restricted band.



A D T

EUT TEST CONDITION		MEASUREMENT DETAIL	
CHANNEL	Channel 6	FREQUENCY RANGE	1 ~ 25GHz
INPUT POWER	120Vac, 60 Hz	DETECTOR FUNCTION	Peak (PK) Average (AV)
ENVIRONMENTAL CONDITIONS	25deg. C, 66%RH 1024 hPa	TESTED BY	Frank Liu

ANTENNA POLARITY & TEST DISTANCE: HORIZONTAL AT 3 M								
NO.	FREQ. (MHz)	EMISSION LEVEL (dBuV/m)	LIMIT (dBuV/m)	MARGIN (dB)	ANTENNA HEIGHT (m)	TABLE ANGLE (Degree)	RAW VALUE (dBuV)	CORRECTION FACTOR (dB/m)
1	*2437.00	97.2 PK			1.32 H	74	66.74	30.46
2	*2437.00	87.2 AV			1.32 H	74	56.74	30.46
3	4874.00	42.7 PK	74.0	-31.3	1.42 H	129	5.78	36.92
4	4874.00	32.6 AV	54.0	-21.4	1.42 H	129	-4.32	36.92
5	5000.00	46.2 PK	74.0	-27.8	1.26 H	124	8.94	37.26
6	5000.00	41.2 AV	54.0	-12.8	1.26 H	124	3.94	37.26
7	7311.00	52.0 PK	74.0	-22.0	1.00 H	231	8.86	43.14
8	7311.00	38.7 AV	54.0	-15.3	1.00 H	231	-4.44	43.14
9	12500.00	55.9 PK	74.0	-18.1	1.29 H	313	9.06	46.84
10	12500.00	45.7 AV	54.0	-8.3	1.29 H	313	-1.14	46.84
ANTENNA POLARITY & TEST DISTANCE: VERTICAL AT 3 M								
NO.	FREQ. (MHz)	EMISSION LEVEL (dBuV/m)	LIMIT (dBuV/m)	MARGIN (dB)	ANTENNA HEIGHT (m)	TABLE ANGLE (Degree)	RAW VALUE (dBuV)	CORRECTION FACTOR (dB/m)
1	*2437.00	109.4 PK			1.00 V	148	78.94	30.46
2	*2437.00	97.4 AV			1.00 V	148	66.94	30.46
3	4874.00	43.1 PK	74.0	-30.9	1.03 V	324	6.18	36.92
4	4874.00	33.4 AV	54.0	-20.6	1.03 V	324	-3.52	36.92
5	5000.00	52.1 PK	74.0	-21.9	1.64 V	8	14.84	37.26
6	5000.00	48.2 AV	54.0	-5.8	1.64 V	8	10.94	37.26
7	7311.00	46.6 PK	74.0	-27.4	1.00 V	283	3.46	43.14
8	7311.00	38.4 AV	54.0	-15.6	1.00 V	283	-4.74	43.14
9	12500.00	56.4 PK	74.0	-17.6	1.21 V	329	9.56	46.84
10	12500.00	47.3 AV	54.0	-6.7	1.21 V	329	0.46	46.84

- REMARKS:**
1. Emission level (dBuV/m) = Raw Value (dBuV) + Correction Factor (dB/m).
 2. Correction Factor (dB/m) = Antenna Factor (dB/m) + Cable Factor (dB).
 3. The other emission levels were very low against the limit.
 4. Margin value = Emission level – Limit value.
 5. “ * ”: Fundamental frequency.



A D T

EUT TEST CONDITION		MEASUREMENT DETAIL	
CHANNEL	Channel 11	FREQUENCY RANGE	1 ~ 25GHz
INPUT POWER	120Vac, 60 Hz	DETECTOR FUNCTION	Peak (PK) Average (AV)
ENVIRONMENTAL CONDITIONS	25deg. C, 66%RH 1024 hPa	TESTED BY	Frank Liu

ANTENNA POLARITY & TEST DISTANCE: HORIZONTAL AT 3 M

NO.	FREQ. (MHz)	EMISSION LEVEL (dBuV/m)	LIMIT (dBuV/m)	MARGIN (dB)	ANTENNA HEIGHT (m)	TABLE ANGLE (Degree)	RAW VALUE (dBuV)	CORRECTION FACTOR (dB/m)
1	*2462.00	96.8 PK			1.36 H	63	66.25	30.55
2	*2462.00	85.9 AV			1.36 H	63	55.35	30.55
3	2483.50	59.0 PK	74.0	-15.0	1.24 H	55	28.33	30.63
4	2483.50	45.0 AV	54.0	-9.0	1.24 H	55	14.35	30.63
5	4924.00	43.6 PK	74.0	-30.4	1.49 H	121	6.54	37.06
6	4924.00	35.8 AV	54.0	-18.2	1.49 H	121	-1.26	37.06
7	5000.00	46.4 PK	74.0	-27.6	1.24 H	128	9.14	37.26
8	5000.00	41.6 AV	54.0	-12.4	1.24 H	128	4.34	37.26
9	7386.00	52.6 PK	74.0	-21.4	1.00 H	230	9.47	43.13
10	7386.00	38.2 AV	54.0	-15.8	1.00 H	230	-4.93	43.13
11	12500.00	55.3 PK	74.0	-18.7	1.21 H	341	8.46	46.84
12	12500.00	45.4 AV	54.0	-8.6	1.21 H	341	-1.44	46.84

ANTENNA POLARITY & TEST DISTANCE: VERTICAL AT 3 M

NO.	FREQ. (MHz)	EMISSION LEVEL (dBuV/m)	LIMIT (dBuV/m)	MARGIN (dB)	ANTENNA HEIGHT (m)	TABLE ANGLE (Degree)	RAW VALUE (dBuV)	CORRECTION FACTOR (dB/m)
1	*2462.00	108.2 PK			1.00 V	145	77.65	30.55
2	*2462.00	96.8 AV			1.00 V	145	66.25	30.55
3	2483.50	70.5 PK	74.0	-3.5	1.00 V	146	39.90	30.63
4	2483.50	53.3 AV	54.0	-0.7	1.00 V	146	22.67	30.63
5	4924.00	44.6 PK	74.0	-29.4	1.00 V	332	7.54	37.06
6	4924.00	36.2 AV	54.0	-17.8	1.00 V	332	-0.86	37.06
7	5000.00	52.3 PK	74.0	-21.7	1.69 V	7	15.04	37.26
8	5000.00	48.5 AV	54.0	-5.5	1.69 V	7	11.24	37.26
9	7386.00	46.4 PK	74.0	-27.6	1.00 V	279	3.27	43.13
10	7386.00	38.2 AV	54.0	-15.8	1.00 V	279	-4.93	43.13
11	12500.00	56.7 PK	74.0	-17.3	1.26 V	331	9.86	46.84
12	12500.00	47.6 AV	54.0	-6.4	1.26 V	331	0.76	46.84

- REMARKS:**
1. Emission level (dBuV/m) = Raw Value (dBuV) + Correction Factor (dB/m).
 2. Correction Factor (dB/m) = Antenna Factor (dB/m) + Cable Factor (dB).
 3. The other emission levels were very low against the limit.
 4. Margin value = Emission level – Limit value.
 5. “ * “: Fundamental frequency.



A D T

RESTRICTED BANDEDGE (802.11g MODE, CH1, HORIZONTAL)

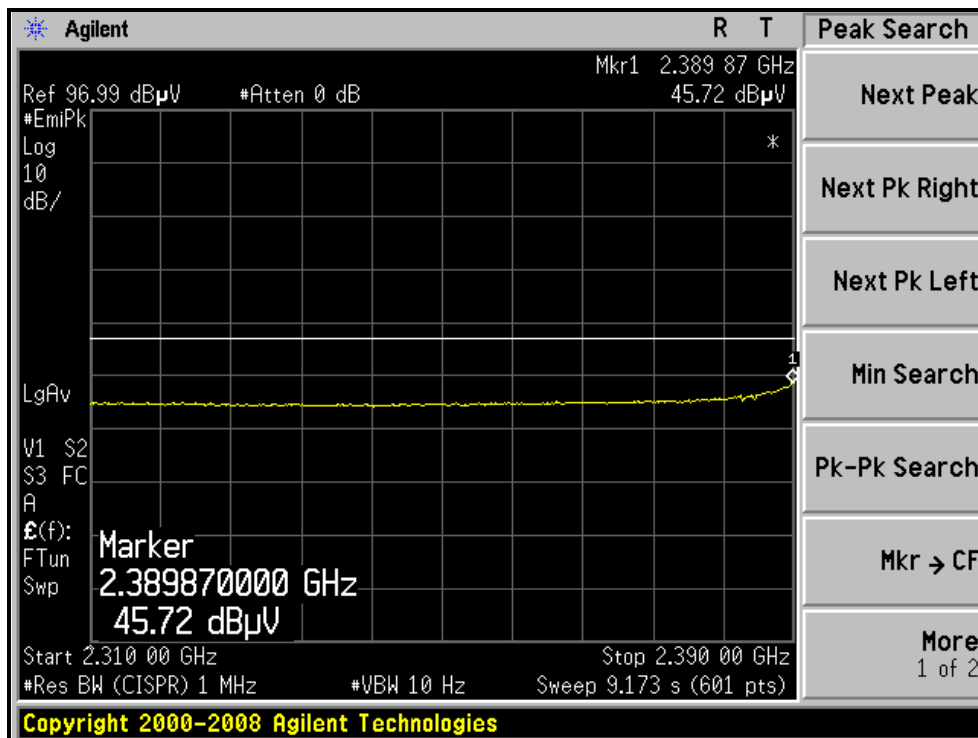
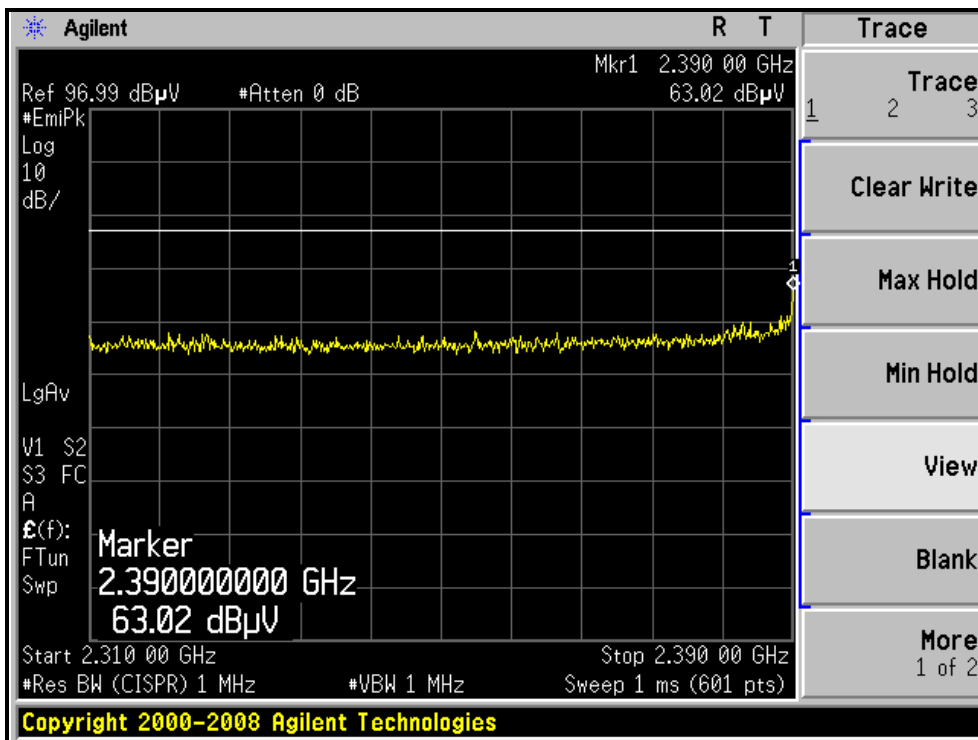



A D T

RESTRICTED BANDEDGE (802.11g MODE,CH1, VERTICAL)

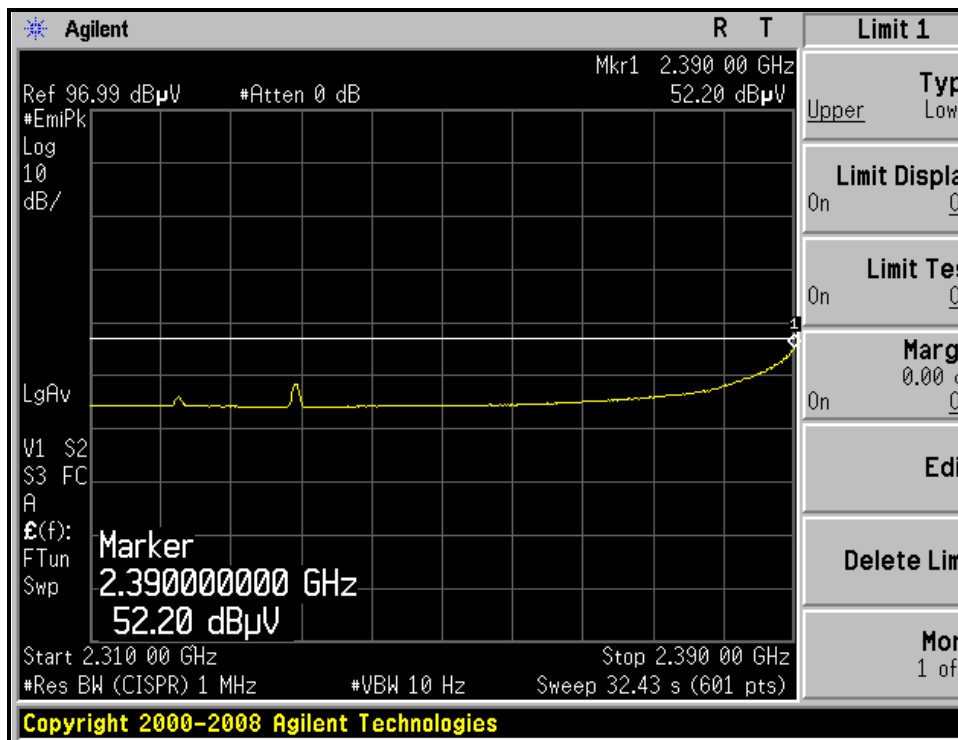
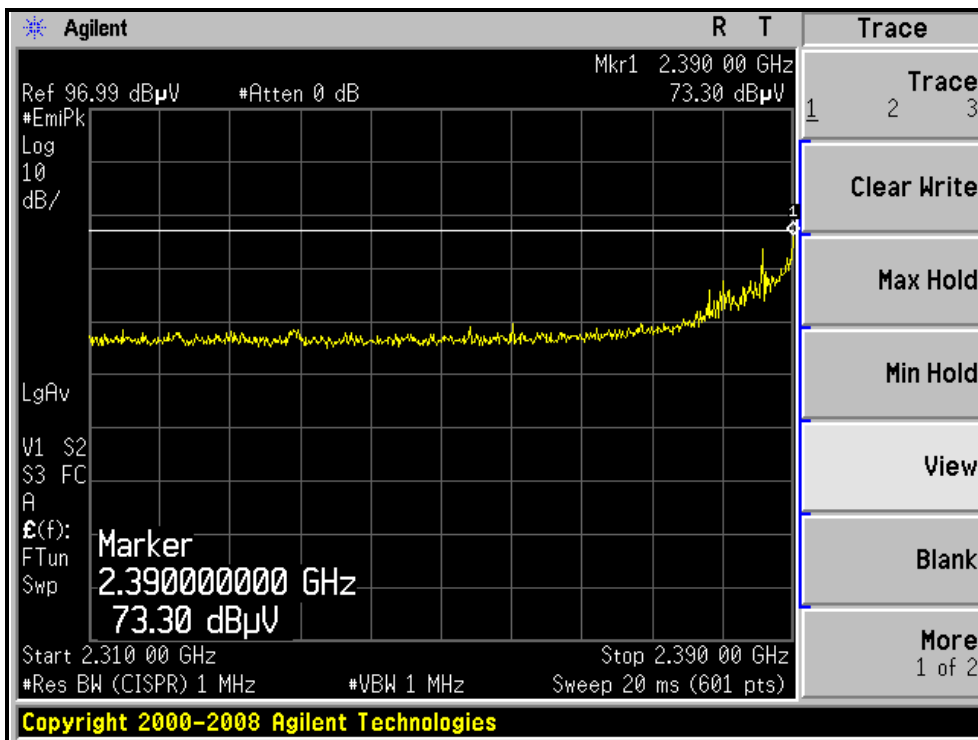



A D T

RESTRICTED BANDEDGE (802.11g MODE, CH11, HORIZONTAL)

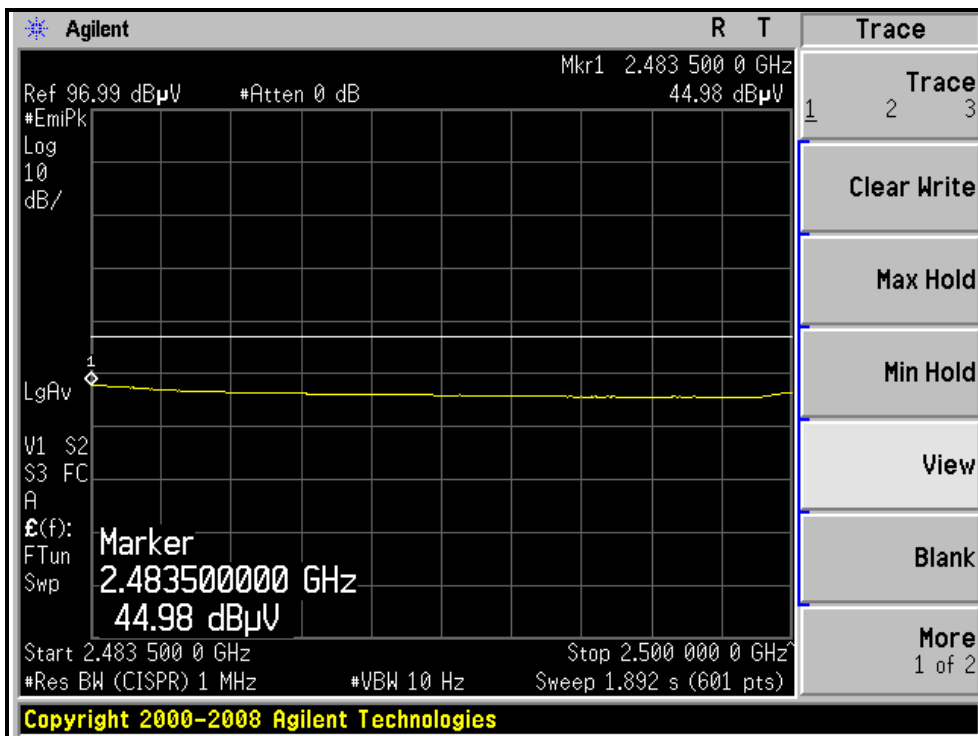
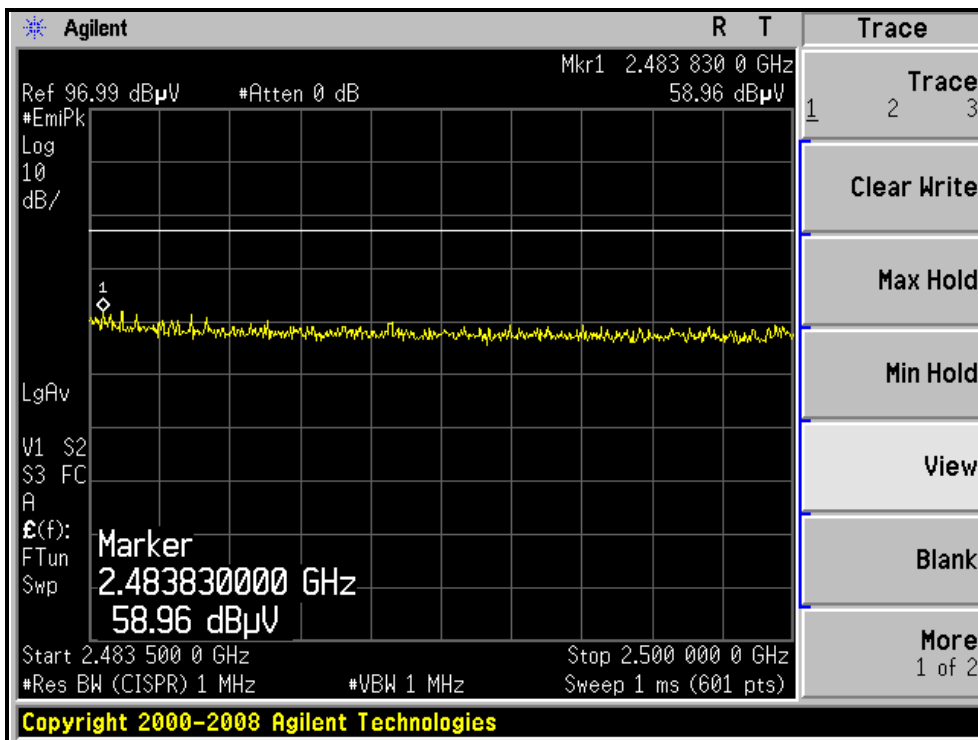



A D T

RESTRICTED BANDEDGE (802.11g MODE,CH11, VERTICAL)

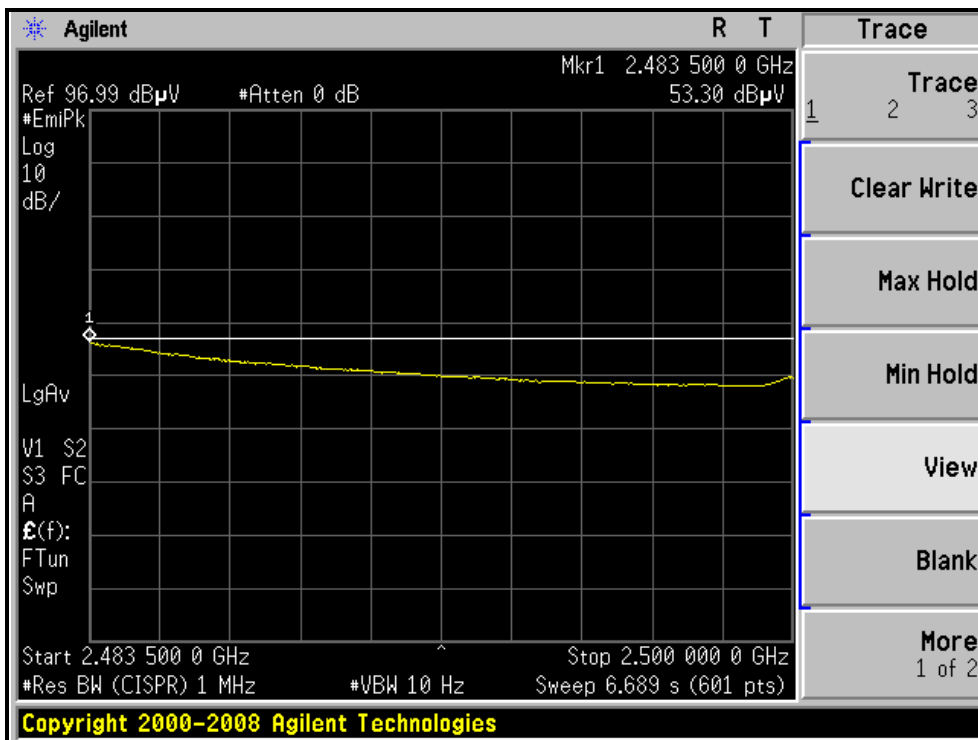
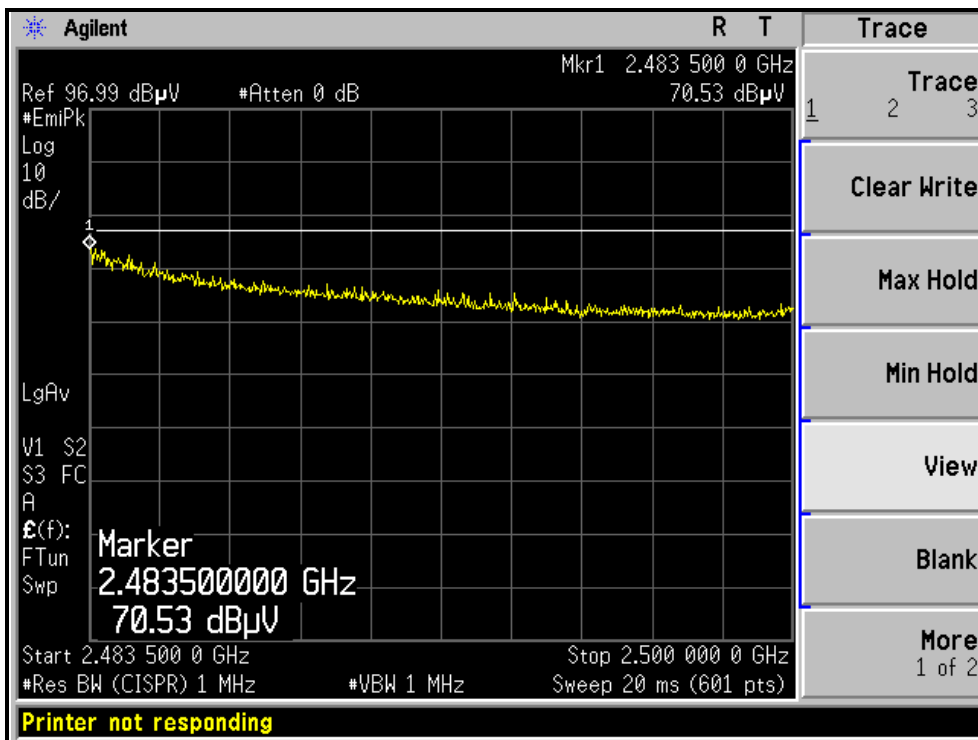



A D T

802.11n (20MHz) OFDM MODULATION

EUT TEST CONDITION		MEASUREMENT DETAIL	
CHANNEL	Channel 1	FREQUENCY RANGE	1 ~ 25GHz
INPUT POWER	120Vac, 60 Hz	DETECTOR FUNCTION	Peak (PK) Average (AV)
ENVIRONMENTAL CONDITIONS	25deg. C, 66%RH 1024 hPa	TESTED BY	Frank Liu

ANTENNA POLARITY & TEST DISTANCE: HORIZONTAL AT 3 M								
NO.	FREQ. (MHz)	EMISSION LEVEL (dBuV/m)	LIMIT (dBuV/m)	MARGIN (dB)	ANTENNA HEIGHT (m)	TABLE ANGLE (Degree)	RAW VALUE (dBuV)	CORRECTION FACTOR (dB/m)
1	2390.00	55.4 PK	74.0	-18.6	1.26 H	58	25.13	30.28
2	2390.00	42.8 AV	54.0	-11.2	1.26 H	58	12.53	30.28
3	*2412.00	97.4 PK			1.24 H	62	67.04	30.36
4	*2412.00	88.4 AV			1.24 H	62	58.04	30.36
5	4824.00	45.2 PK	74.0	-28.8	1.42 H	127	8.41	36.79
6	4824.00	36.4 AV	54.0	-17.6	1.42 H	127	-0.39	36.79
7	5000.00	46.6 PK	74.0	-27.4	1.20 H	124	9.34	37.26
8	5000.00	42.5 AV	54.0	-11.5	1.20 H	124	5.24	37.26
9	#7236.00	47.4 PK	77.4	-30.0	1.00 H	242	4.26	43.14
10	#7236.00	38.6 AV	68.4	-29.8	1.00 H	242	-4.54	43.14
11	12500.00	55.3 PK	74.0	-18.7	1.29 H	354	8.46	46.84
12	12500.00	45.2 AV	54.0	-8.8	1.29 H	354	-1.64	46.84

ANTENNA POLARITY & TEST DISTANCE: VERTICAL AT 3 M								
NO.	FREQ. (MHz)	EMISSION LEVEL (dBuV/m)	LIMIT (dBuV/m)	MARGIN (dB)	ANTENNA HEIGHT (m)	TABLE ANGLE (Degree)	RAW VALUE (dBuV)	CORRECTION FACTOR (dB/m)
1	2390.00	73.2 PK	74.0	-0.8	1.00 V	151	42.92	30.28
2	2390.00	52.8 AV	54.0	-1.2	1.00 V	151	22.50	30.28
3	*2412.00	110.9 PK			1.00 V	150	80.54	30.36
4	*2412.00	98.7 AV			1.00 V	150	68.34	30.36
5	4824.00	45.3 PK	74.0	-28.7	1.00 V	313	8.51	36.79
6	4824.00	36.1 AV	54.0	-17.9	1.00 V	313	-0.69	36.79
7	5000.00	52.4 PK	74.0	-21.6	1.54 V	23	15.14	37.26
8	5000.00	48.6 AV	54.0	-5.4	1.54 V	23	11.34	37.26
9	#7236.00	46.9 PK	90.9	-44.0	1.00 V	264	3.76	43.14
10	#7236.00	38.2 AV	78.7	-40.5	1.00 V	264	-4.94	43.14
11	12500.00	56.4 PK	74.0	-17.6	1.10 V	321	9.56	46.84
12	12500.00	47.3 AV	54.0	-6.7	1.10 V	321	0.46	46.84

- REMARKS:**
1. Emission level (dBuV/m) = Raw Value (dBuV) + Correction Factor (dB/m).
 2. Correction Factor (dB/m) = Antenna Factor (dB/m) + Cable Factor (dB).
 3. The other emission levels were very low against the limit.
 4. Margin value = Emission level – Limit value.
 5. “ * “: Fundamental frequency.
 6. “#”:The radiated frequency is out the restricted band.



A D T

EUT TEST CONDITION		MEASUREMENT DETAIL	
CHANNEL	Channel 6	FREQUENCY RANGE	1 ~ 25GHz
INPUT POWER	120Vac, 60 Hz	DETECTOR FUNCTION	Peak (PK) Average (AV)
ENVIRONMENTAL CONDITIONS	25deg. C, 66%RH 1024 hPa	TESTED BY	Frank Liu

ANTENNA POLARITY & TEST DISTANCE: HORIZONTAL AT 3 M

NO.	FREQ. (MHz)	EMISSION LEVEL (dBuV/m)	LIMIT (dBuV/m)	MARGIN (dB)	ANTENNA HEIGHT (m)	TABLE ANGLE (Degree)	RAW VALUE (dBuV)	CORRECTION FACTOR (dB/m)
1	*2437.00	98.3 PK			1.26 H	74	67.84	30.46
2	*2437.00	88.9 AV			1.26 H	74	58.44	30.46
3	4874.00	42.9 PK	74.0	-31.1	1.54 H	126	5.98	36.92
4	4874.00	33.2 AV	54.0	-20.8	1.54 H	126	-3.72	36.92
5	5000.00	46.3 PK	74.0	-27.7	1.21 H	129	9.04	37.26
6	5000.00	42.1 AV	54.0	-11.9	1.21 H	129	4.84	37.26
7	7311.00	47.2 PK	74.0	-26.8	1.00 H	239	4.06	43.14
8	7311.00	38.4 AV	54.0	-15.6	1.00 H	239	-4.74	43.14
9	12500.00	55.8 PK	74.0	-18.2	1.31 H	350	8.96	46.84
10	12500.00	45.9 AV	54.0	-8.1	1.31 H	350	-0.94	46.84

ANTENNA POLARITY & TEST DISTANCE: VERTICAL AT 3 M

NO.	FREQ. (MHz)	EMISSION LEVEL (dBuV/m)	LIMIT (dBuV/m)	MARGIN (dB)	ANTENNA HEIGHT (m)	TABLE ANGLE (Degree)	RAW VALUE (dBuV)	CORRECTION FACTOR (dB/m)
1	*2437.00	111.4 PK			1.00 V	142	80.94	30.46
2	*2437.00	99.6 AV			1.00 V	142	69.14	30.46
3	4874.00	42.7 PK	74.0	-31.3	1.00 V	321	5.78	36.92
4	4874.00	32.1 AV	54.0	-21.9	1.00 V	321	-4.82	36.92
5	5000.00	52.1 PK	74.0	-21.9	1.57 V	10	14.84	37.26
6	5000.00	48.4 AV	54.0	-5.6	1.57 V	10	11.14	37.26
7	7311.00	46.9 PK	74.0	-27.1	1.00 V	267	3.76	43.14
8	7311.00	38.1 AV	54.0	-15.9	1.00 V	267	-5.04	43.14
9	12500.00	56.3 PK	74.0	-17.7	1.09 V	320	9.46	46.84
10	12500.00	47.4 AV	54.0	-6.6	1.09 V	320	0.56	46.84

- REMARKS:**
1. Emission level (dBuV/m) = Raw Value (dBuV) + Correction Factor (dB/m).
 2. Correction Factor (dB/m) = Antenna Factor (dB/m) + Cable Factor (dB).
 3. The other emission levels were very low against the limit.
 4. Margin value = Emission level – Limit value.
 5. “ * “: Fundamental frequency.



A D T

EUT TEST CONDITION		MEASUREMENT DETAIL	
CHANNEL	Channel 11	FREQUENCY RANGE	1 ~ 25GHz
INPUT POWER	120Vac, 60 Hz	DETECTOR FUNCTION	Peak (PK) Average (AV)
ENVIRONMENTAL CONDITIONS	25deg. C, 66%RH 1024 hPa	TESTED BY	Frank Liu

ANTENNA POLARITY & TEST DISTANCE: HORIZONTAL AT 3 M								
NO.	FREQ. (MHz)	EMISSION LEVEL (dBuV/m)	LIMIT (dBuV/m)	MARGIN (dB)	ANTENNA HEIGHT (m)	TABLE ANGLE (Degree)	RAW VALUE (dBuV)	CORRECTION FACTOR (dB/m)
1	*2462.00	93.2 PK			1.26 H	64	62.65	30.55
2	*2462.00	84.6 AV			1.26 H	64	54.05	30.55
3	2483.50	57.7 PK	74.0	-16.3	1.24 H	55	27.11	30.63
4	2483.50	43.1 AV	54.0	-10.9	1.24 H	55	12.44	30.63
5	4924.00	44.7 PK	74.0	-29.3	1.50 H	125	7.64	37.06
6	4924.00	36.2 AV	54.0	-17.8	1.50 H	125	-0.86	37.06
7	5000.00	46.9 PK	74.0	-27.1	1.26 H	127	9.64	37.26
8	5000.00	41.8 AV	54.0	-12.2	1.26 H	127	4.54	37.26
9	7386.00	53.1 PK	74.0	-20.9	1.00 H	231	9.97	43.13
10	7386.00	38.4 AV	54.0	-15.6	1.00 H	231	-4.73	43.13
11	12500.00	55.6 PK	74.0	-18.4	1.26 H	342	8.76	46.84
12	12500.00	45.7 AV	54.0	-8.3	1.26 H	342	-1.14	46.84

ANTENNA POLARITY & TEST DISTANCE: VERTICAL AT 3 M								
NO.	FREQ. (MHz)	EMISSION LEVEL (dBuV/m)	LIMIT (dBuV/m)	MARGIN (dB)	ANTENNA HEIGHT (m)	TABLE ANGLE (Degree)	RAW VALUE (dBuV)	CORRECTION FACTOR (dB/m)
1	*2462.00	109.4 PK			1.00 V	74	78.85	30.55
2	*2462.00	95.7 AV			1.00 V	74	65.18	30.55
3	2483.88	69.6 PK	74.0	-4.4	1.00 V	147	38.93	30.63
4	2483.88	53.5 AV	54.0	-0.6	1.00 V	147	22.82	30.63
5	4924.00	45.1 PK	74.0	-28.9	1.00 V	316	8.04	37.06
6	4924.00	36.9 AV	54.0	-17.1	1.00 V	316	-0.16	37.06
7	5000.00	52.5 PK	74.0	-21.5	1.64 V	9	15.24	37.26
8	5000.00	48.6 AV	54.0	-5.4	1.64 V	9	11.34	37.26
9	7386.00	46.7 PK	74.0	-27.3	1.00 V	264	3.57	43.13
10	7386.00	38.4 AV	54.0	-15.6	1.00 V	264	-4.73	43.13
11	12500.00	56.8 PK	74.0	-17.2	1.21 V	327	9.96	46.84
12	12500.00	47.2 AV	54.0	-6.8	1.21 V	327	0.36	46.84

- REMARKS:**
1. Emission level (dBuV/m) = Raw Value (dBuV) + Correction Factor (dB/m).
 2. Correction Factor (dB/m) = Antenna Factor (dB/m) + Cable Factor (dB).
 3. The other emission levels were very low against the limit.
 4. Margin value = Emission level – Limit value.
 5. “ * “: Fundamental frequency.



A D T

RESTRICTED BANDEDGE (802.11n (20MHz) MODE,CH1, HORIZONTAL)

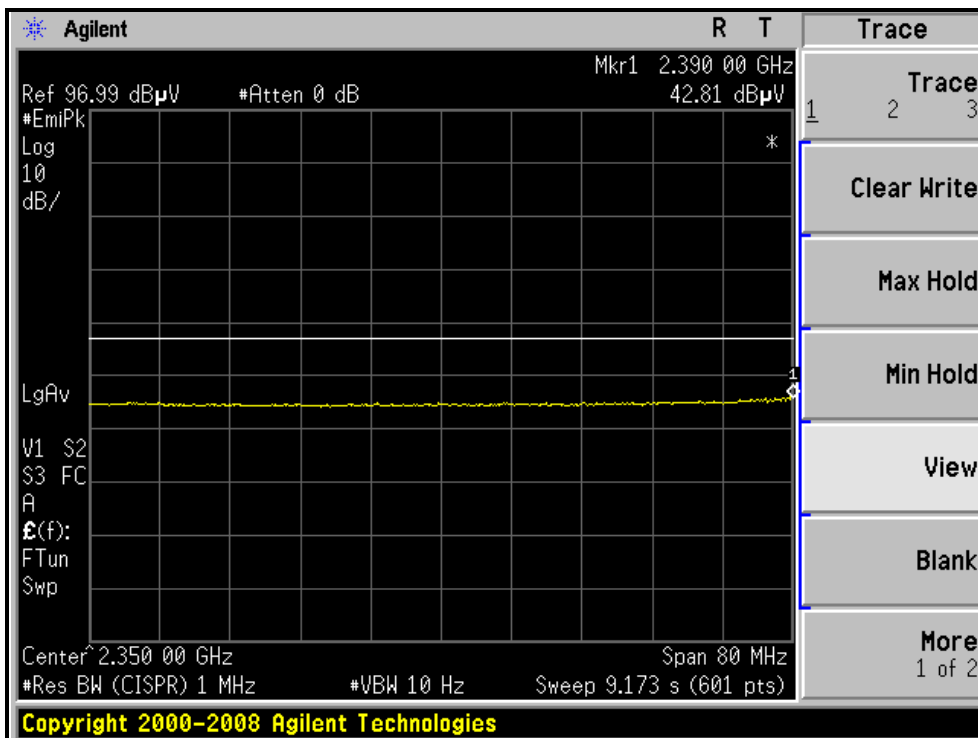
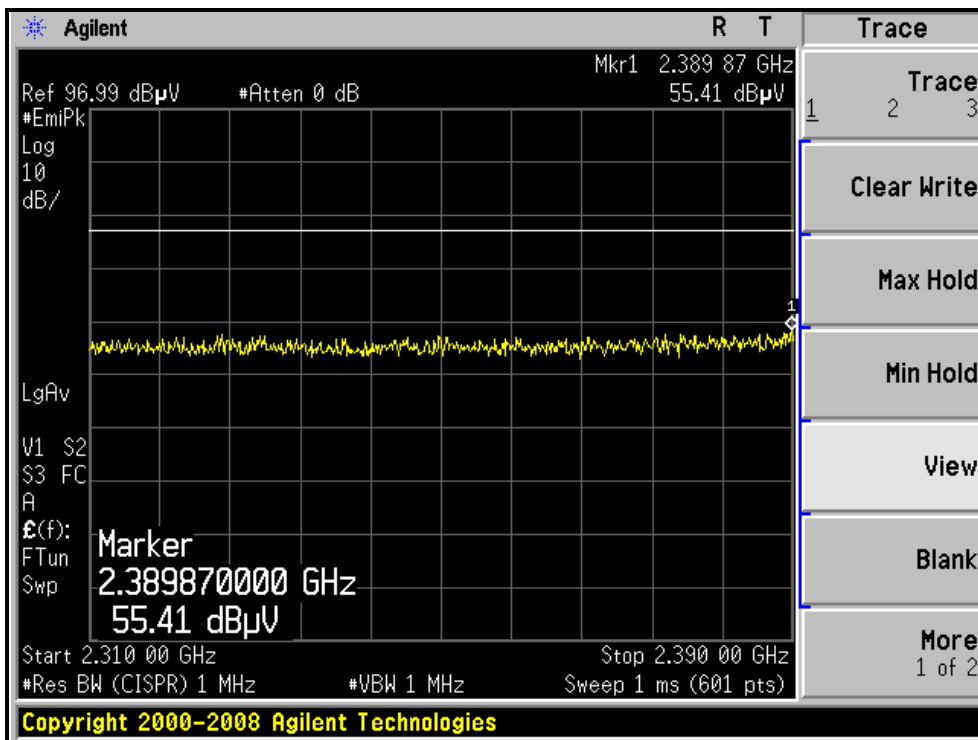



A D T

RESTRICTED BANDEDGE (802.11n (20MHz) MODE,CH1, VERTICAL)

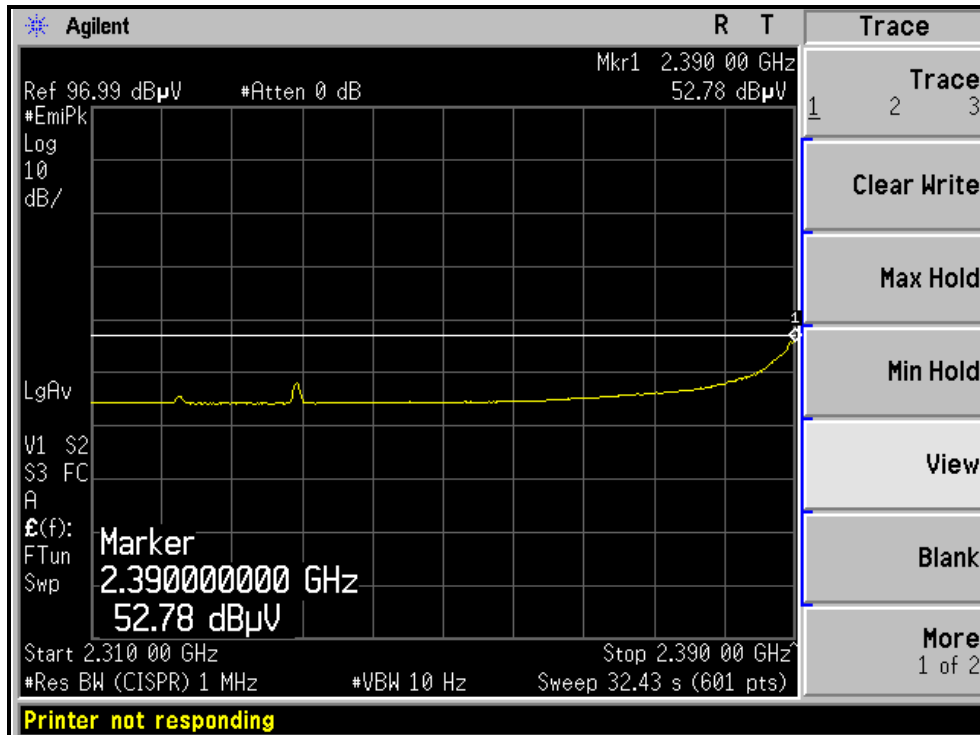
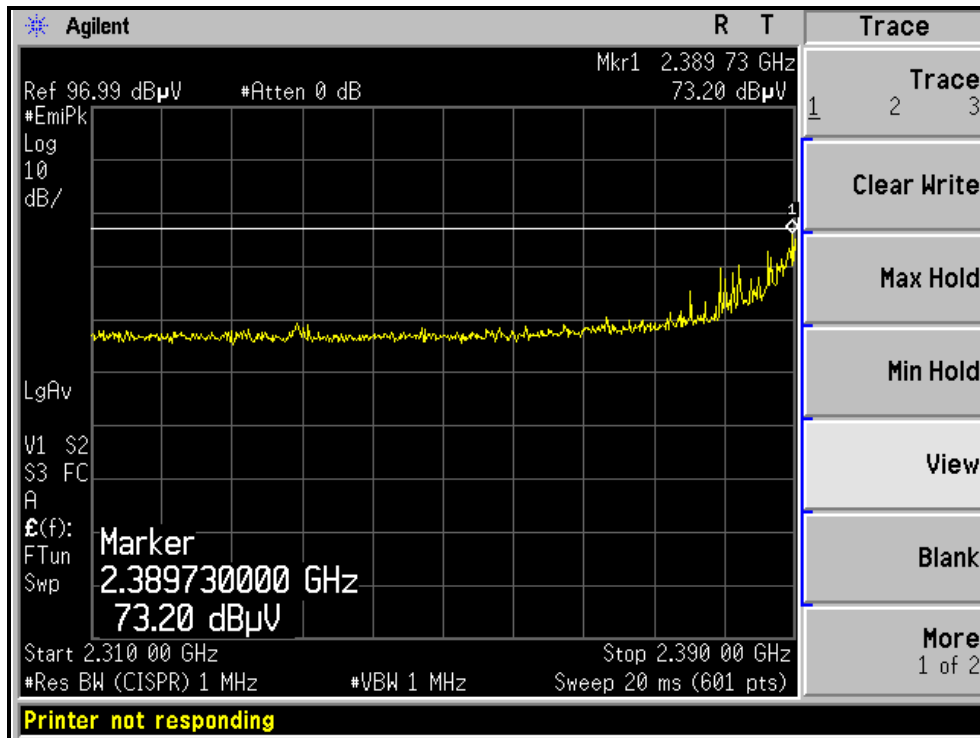



A D T

RESTRICTED BANDEDGE (802.11n (20MHz) MODE,CH11, HORIZONTAL)

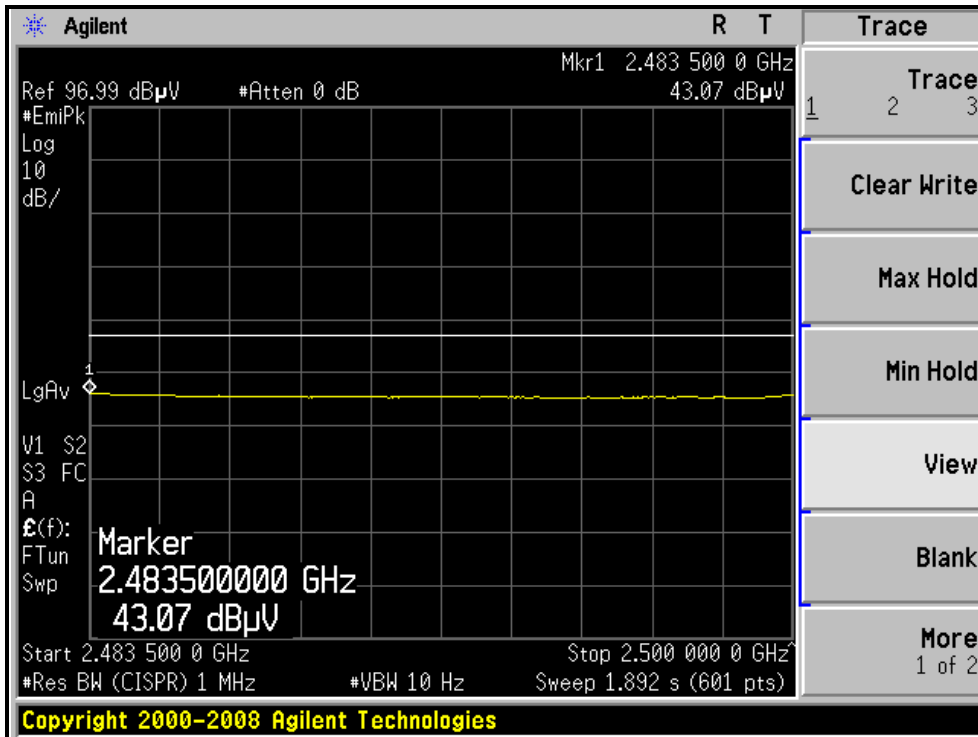
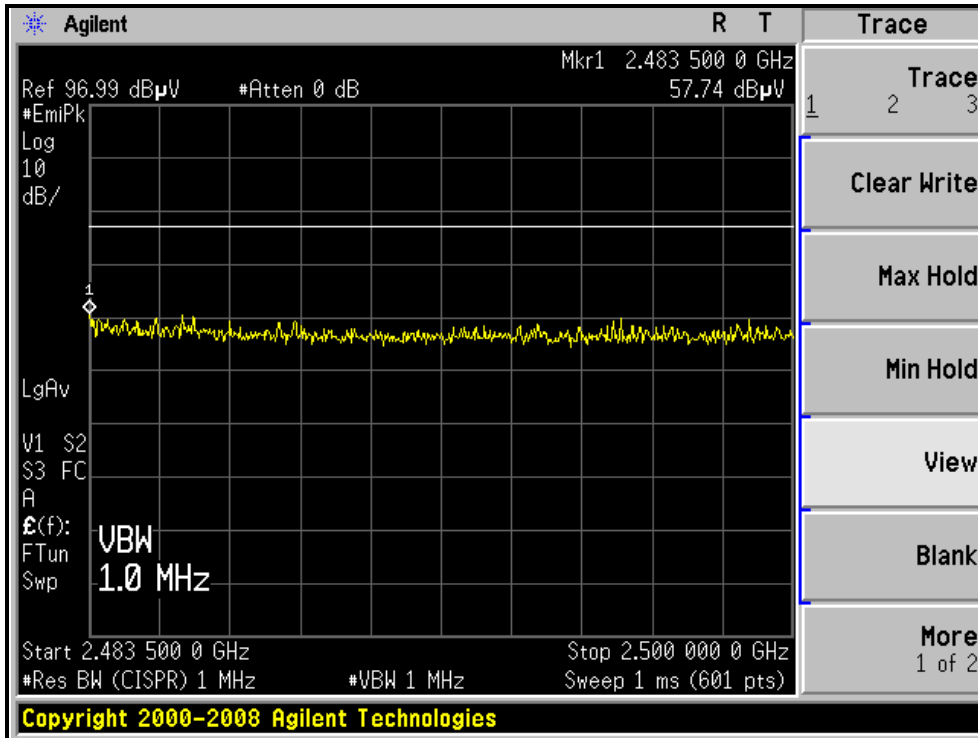



A D T

RESTRICTED BANDEDGE (802.11n (20MHz) MODE,CH11, VERTICAL)

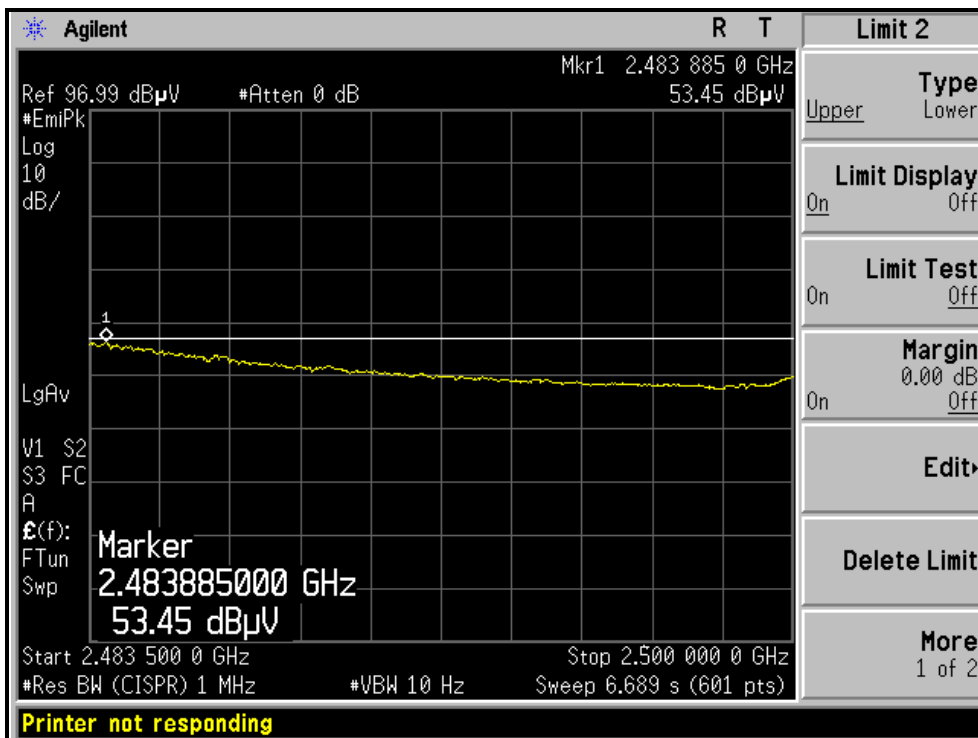
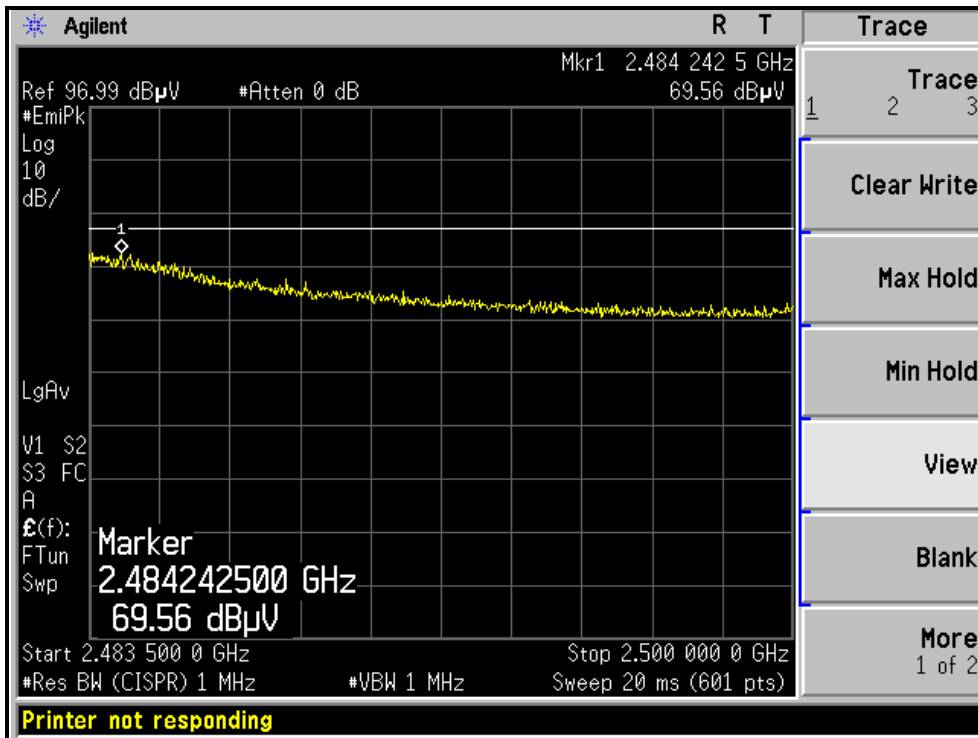



A D T

802.11n (40MHz) OFDM MODULATION

EUT TEST CONDITION		MEASUREMENT DETAIL	
CHANNEL	Channel 1	FREQUENCY RANGE	1 ~ 25GHz
INPUT POWER	120Vac, 60 Hz	DETECTOR FUNCTION	Peak (PK) Average (AV)
ENVIRONMENTAL CONDITIONS	25deg. C, 66%RH 1024 hPa	TESTED BY	Frank Liu

ANTENNA POLARITY & TEST DISTANCE: HORIZONTAL AT 3 M

NO.	FREQ. (MHz)	EMISSION LEVEL (dBuV/m)	LIMIT (dBuV/m)	MARGIN (dB)	ANTENNA HEIGHT (m)	TABLE ANGLE (Degree)	RAW VALUE (dBuV)	CORRECTION FACTOR (dB/m)
1	2388.00	58.7 PK	74.0	-15.3	1.24 H	55	28.45	30.28
2	2388.00	45.7 AV	54.0	-8.3	1.24 H	55	15.44	30.28
3	*2422.00	89.2 PK			1.24 H	63	58.80	30.40
4	*2422.00	80.4 AV			1.24 H	63	50.00	30.40
5	4844.00	43.6 PK	74.0	-30.4	1.43 H	126	6.76	36.84
6	4844.00	33.1 AV	54.0	-20.9	1.43 H	126	-3.74	36.84
7	5000.00	47.6 PK	74.0	-26.4	1.24 H	131	10.34	37.26
8	5000.00	43.1 AV	54.0	-10.9	1.24 H	131	5.84	37.26
9	7266.00	47.2 PK	74.0	-26.8	1.00 H	219	4.06	43.14
10	7266.00	38.4 AV	54.0	-15.6	1.00 H	219	-4.74	43.14
11	12500.00	56.1 PK	74.0	-17.9	1.24 H	341	9.26	46.84
12	12500.00	45.9 AV	54.0	-8.1	1.24 H	341	-0.94	46.84

ANTENNA POLARITY & TEST DISTANCE: VERTICAL AT 3 M

NO.	FREQ. (MHz)	EMISSION LEVEL (dBuV/m)	LIMIT (dBuV/m)	MARGIN (dB)	ANTENNA HEIGHT (m)	TABLE ANGLE (Degree)	RAW VALUE (dBuV)	CORRECTION FACTOR (dB/m)
1	2389.87	71.2 PK	74.0	-2.8	1.00 V	150	40.92	30.28
2	2389.87	53.2 AV	54.0	-0.8	1.00 V	150	22.90	30.28
3	*2422.00	104.8 PK			1.00 V	149	74.40	30.40
4	*2422.00	91.3 AV			1.00 V	149	60.90	30.40
5	4844.00	43.4 PK	74.0	-30.6	1.01 V	249	6.56	36.84
6	4844.00	33.6 AV	54.0	-20.4	1.01 V	249	-3.24	36.84
7	5000.00	53.6 PK	74.0	-20.4	1.69 V	42	16.34	37.26
8	5000.00	49.2 AV	54.0	-4.8	1.69 V	42	11.94	37.26
9	7266.00	47.1 PK	74.0	-26.9	1.00 V	242	3.96	43.14
10	7266.00	38.1 AV	54.0	-15.9	1.00 V	242	-5.04	43.14
11	12500.00	56.9 PK	74.0	-17.1	1.31 V	321	10.06	46.84
12	12500.00	47.3 AV	54.0	-6.7	1.31 V	321	0.46	46.84

- REMARKS:**
1. Emission level (dBuV/m) = Raw Value (dBuV) + Correction Factor (dB/m).
 2. Correction Factor (dB/m) = Antenna Factor (dB/m) + Cable Factor (dB).
 3. The other emission levels were very low against the limit.
 4. Margin value = Emission level – Limit value.
 5. “ * “: Fundamental frequency.



A D T

EUT TEST CONDITION		MEASUREMENT DETAIL	
CHANNEL	Channel 4	FREQUENCY RANGE	1 ~ 25GHz
INPUT POWER	120Vac, 60 Hz	DETECTOR FUNCTION	Peak (PK) Average (AV)
ENVIRONMENTAL CONDITIONS	25deg. C, 66%RH 1024 hPa	TESTED BY	Frank Liu

ANTENNA POLARITY & TEST DISTANCE: HORIZONTAL AT 3 M								
NO.	FREQ. (MHz)	EMISSION LEVEL (dBuV/m)	LIMIT (dBuV/m)	MARGIN (dB)	ANTENNA HEIGHT (m)	TABLE ANGLE (Degree)	RAW VALUE (dBuV)	CORRECTION FACTOR (dB/m)
1	2390.00	64.2 PK	74.0	-9.8	1.13 H	59	33.92	30.28
2	2390.00	46.3 AV	54.0	-7.7	1.13 H	59	16.02	30.28
3	*2437.00	91.3 PK			1.24 H	62	60.84	30.46
4	*2437.00	82.4 AV			1.24 H	62	51.94	30.46
5	4874.00	43.0 PK	74.0	-31.0	1.26 H	344	6.08	36.92
6	4874.00	32.6 AV	54.0	-21.4	1.26 H	344	-4.32	36.92
7	5000.00	47.4 PK	74.0	-26.6	1.00 H	213	10.14	37.26
8	5000.00	42.6 AV	54.0	-11.4	1.00 H	213	5.34	37.26
9	7311.00	47.4 PK	74.0	-26.6	1.27 H	129	4.26	43.14
10	7311.00	38.9 AV	54.0	-15.1	1.27 H	129	-4.24	43.14
11	12500.00	56.2 PK	74.0	-17.8	1.41 H	124	9.36	46.84
12	12500.00	45.8 AV	54.0	-8.2	1.41 H	124	-1.04	46.84

ANTENNA POLARITY & TEST DISTANCE: VERTICAL AT 3 M								
NO.	FREQ. (MHz)	EMISSION LEVEL (dBuV/m)	LIMIT (dBuV/m)	MARGIN (dB)	ANTENNA HEIGHT (m)	TABLE ANGLE (Degree)	RAW VALUE (dBuV)	CORRECTION FACTOR (dB/m)
1	2390.00	71.6 PK	74.0	-2.4	1.00 V	150	41.34	30.28
2	2390.00	53.4 AV	54.0	-0.6	1.00 V	150	23.08	30.28
3	*2437.00	107.0 PK			1.00 V	147	76.54	30.46
4	*2437.00	92.7 AV			1.00 V	147	62.24	30.46
5	4874.00	42.9 PK	74.0	-31.1	1.26 V	319	5.98	36.92
6	4874.00	32.4 AV	54.0	-21.6	1.26 V	319	-4.52	36.92
7	5000.00	53.4 PK	74.0	-20.6	1.00 V	262	16.14	37.26
8	5000.00	48.6 AV	54.0	-5.4	1.00 V	262	11.34	37.26
9	7311.00	47.3 PK	74.0	-26.7	1.64 V	37	4.16	43.14
10	7311.00	38.4 AV	54.0	-15.6	1.64 V	37	-4.74	43.14
11	12500.00	56.5 PK	74.0	-17.5	1.04 V	243	9.66	46.84
12	12500.00	47.2 AV	54.0	-6.8	1.04 V	243	0.36	46.84

- REMARKS:**
1. Emission level (dBuV/m) = Raw Value (dBuV) + Correction Factor (dB/m).
 2. Correction Factor (dB/m) = Antenna Factor (dB/m) + Cable Factor (dB).
 3. The other emission levels were very low against the limit.
 4. Margin value = Emission level – Limit value.
 5. “ * “: Fundamental frequency.



A D T

EUT TEST CONDITION		MEASUREMENT DETAIL	
CHANNEL	Channel 7	FREQUENCY RANGE	1 ~ 25GHz
INPUT POWER	120Vac, 60 Hz	DETECTOR FUNCTION	Peak (PK) Average (AV)
ENVIRONMENTAL CONDITIONS	25deg. C, 66%RH 1024 hPa	TESTED BY	Frank Liu

ANTENNA POLARITY & TEST DISTANCE: HORIZONTAL AT 3 M

NO.	FREQ. (MHz)	EMISSION LEVEL (dBuV/m)	LIMIT (dBuV/m)	MARGIN (dB)	ANTENNA HEIGHT (m)	TABLE ANGLE (Degree)	RAW VALUE (dBuV)	CORRECTION FACTOR (dB/m)
1	*2452.00	90.8 PK			1.26 H	55	60.29	30.51
2	*2452.00	81.5 AV			1.26 H	55	50.99	30.51
3	2484.46	61.7 PK	74.0	-12.3	1.24 H	63	31.06	30.63
4	2484.46	48.7 AV	54.0	-5.3	1.24 H	63	18.11	30.63
5	4904.00	43.1 PK	74.0	-30.9	1.48 H	126	6.10	37.00
6	4904.00	33.1 AV	54.0	-20.9	1.48 H	126	-3.90	37.00
7	5000.00	47.2 PK	74.0	-26.8	1.24 H	121	9.94	37.26
8	5000.00	42.3 AV	54.0	-11.7	1.24 H	121	5.04	37.26
9	7356.00	47.2 PK	74.0	-26.8	1.00 H	239	4.07	43.13
10	7356.00	38.4 AV	54.0	-15.6	1.00 H	239	-4.73	43.13
11	12500.00	56.4 PK	74.0	-17.6	1.31 H	340	9.56	46.84
12	12500.00	45.9 AV	54.0	-8.1	1.31 H	340	-0.94	46.84

ANTENNA POLARITY & TEST DISTANCE: VERTICAL AT 3 M

NO.	FREQ. (MHz)	EMISSION LEVEL (dBuV/m)	LIMIT (dBuV/m)	MARGIN (dB)	ANTENNA HEIGHT (m)	TABLE ANGLE (Degree)	RAW VALUE (dBuV)	CORRECTION FACTOR (dB/m)
1	*2452.00	103.0 PK			1.00 V	150	72.49	30.51
2	*2452.00	91.1 AV			1.00 V	150	60.59	30.51
3	2483.52	73.3 PK	74.0	-0.7	1.00 V	145	42.70	30.63
4	2483.52	53.4 AV	54.0	-0.6	1.00 V	145	22.79	30.63
5	4904.00	43.2 PK	74.0	-30.8	1.03 V	360	6.20	37.00
6	4904.00	33.4 AV	54.0	-20.6	1.03 V	360	-3.60	37.00
7	5000.00	53.1 PK	74.0	-20.9	1.59 V	12	15.84	37.26
8	5000.00	48.4 AV	54.0	-5.6	1.59 V	12	11.14	37.26
9	7356.00	46.9 PK	74.0	-27.1	1.00 V	272	3.77	43.13
10	7356.00	38.2 AV	54.0	-15.8	1.00 V	272	-4.93	43.13
11	12500.00	56.9 PK	74.0	-17.1	1.42 V	321	10.06	46.84
12	12500.00	47.4 AV	54.0	-6.6	1.42 V	321	0.56	46.84

- REMARKS:**
1. Emission level (dBuV/m) = Raw Value (dBuV) + Correction Factor (dB/m).
 2. Correction Factor (dB/m) = Antenna Factor (dB/m) + Cable Factor (dB).
 3. The other emission levels were very low against the limit.
 4. Margin value = Emission level – Limit value.
 5. “ * “: Fundamental frequency.



A D T

RESTRICTED BANDEDGE (802.11n (40MHz) MODE,CH1, HORIZONTAL)

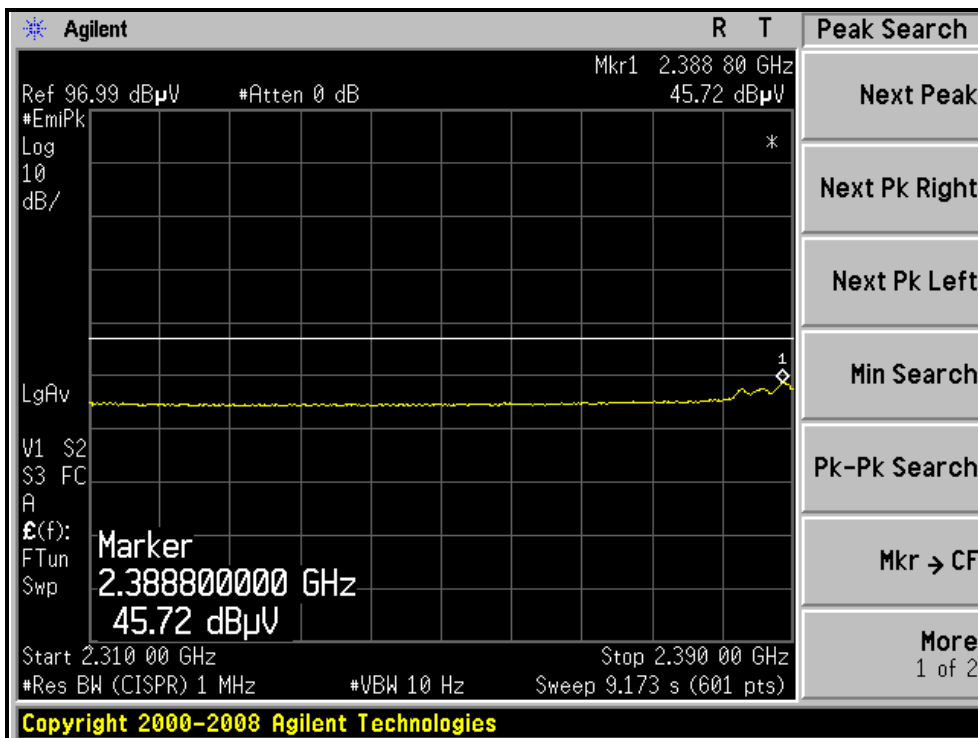
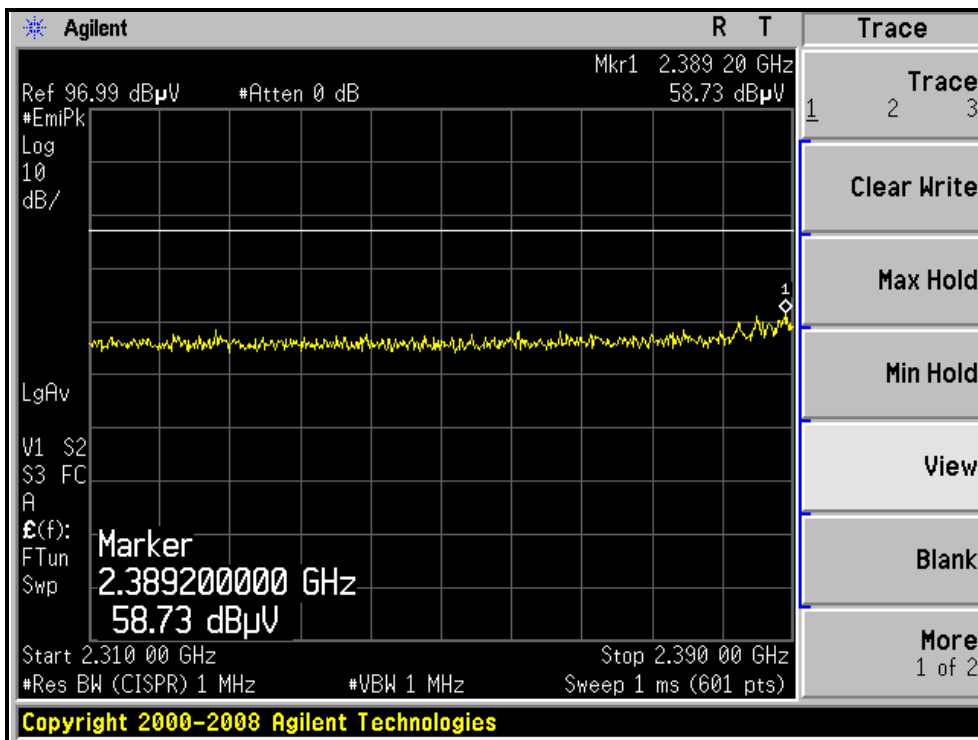



A D T

RESTRICTED BANDEDGE (802.11n (40MHz) MODE,CH1, VERTICAL)

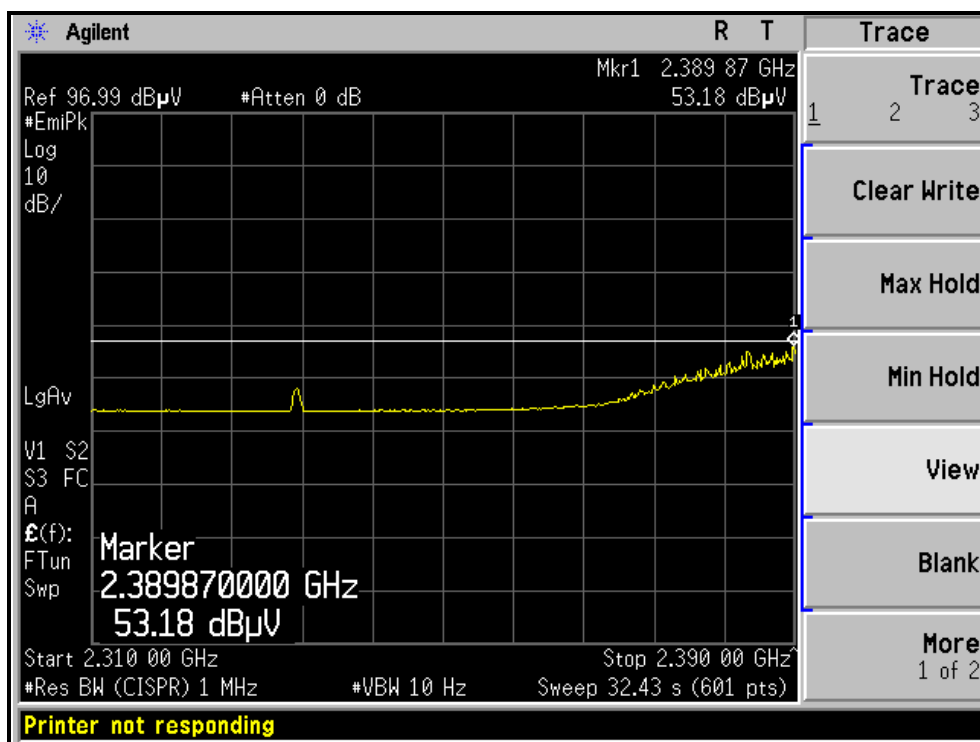
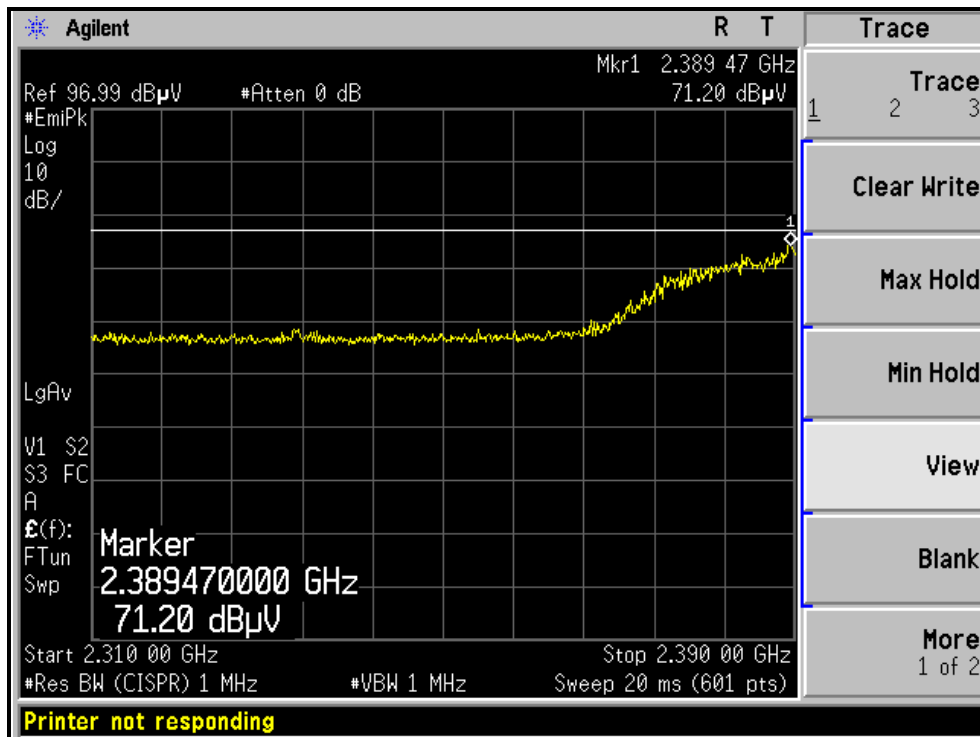

RESTRICTED BANDEDGE (802.11n (40MHz) MODE,CH7, HORIZONTAL)

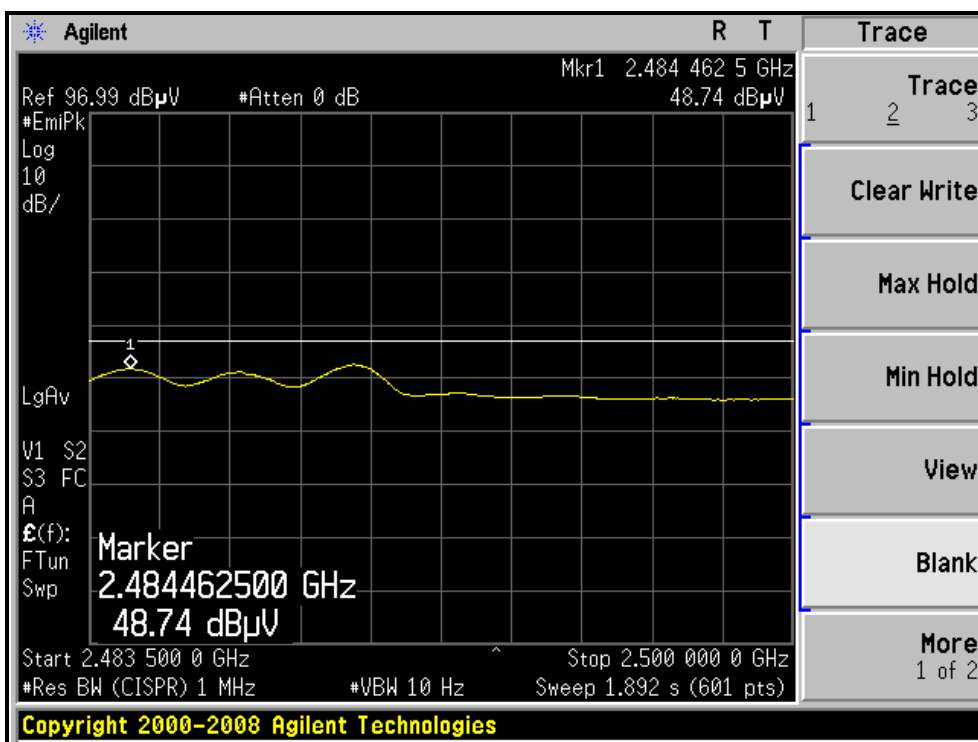
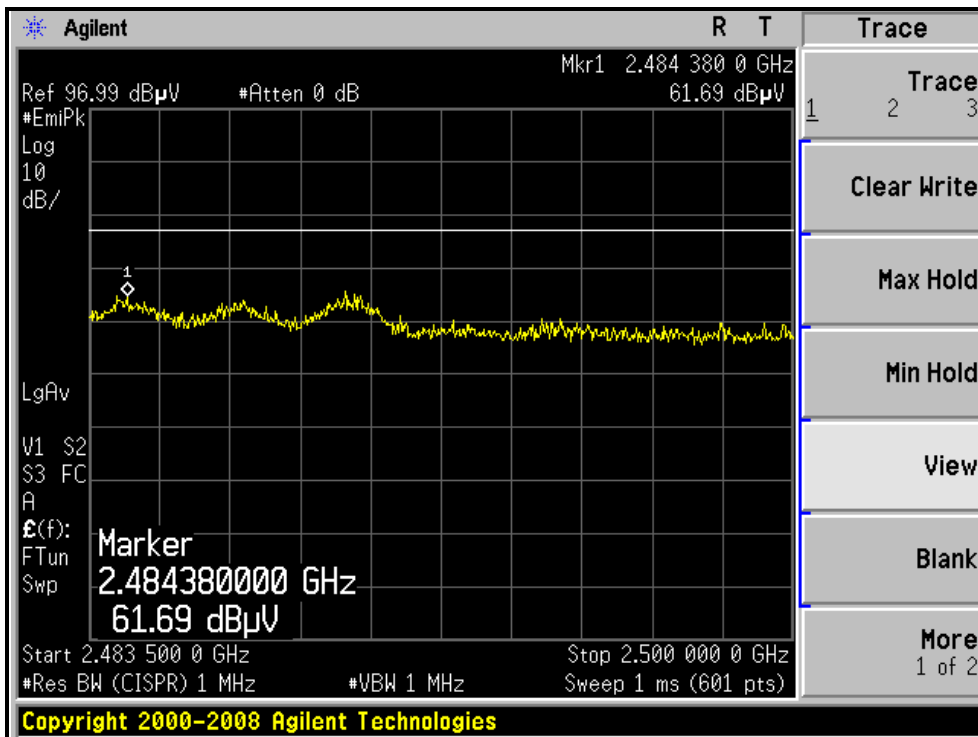



A D T

RESTRICTED BANDEDGE (802.11n (40MHz) MODE,CH7, VERTICAL)

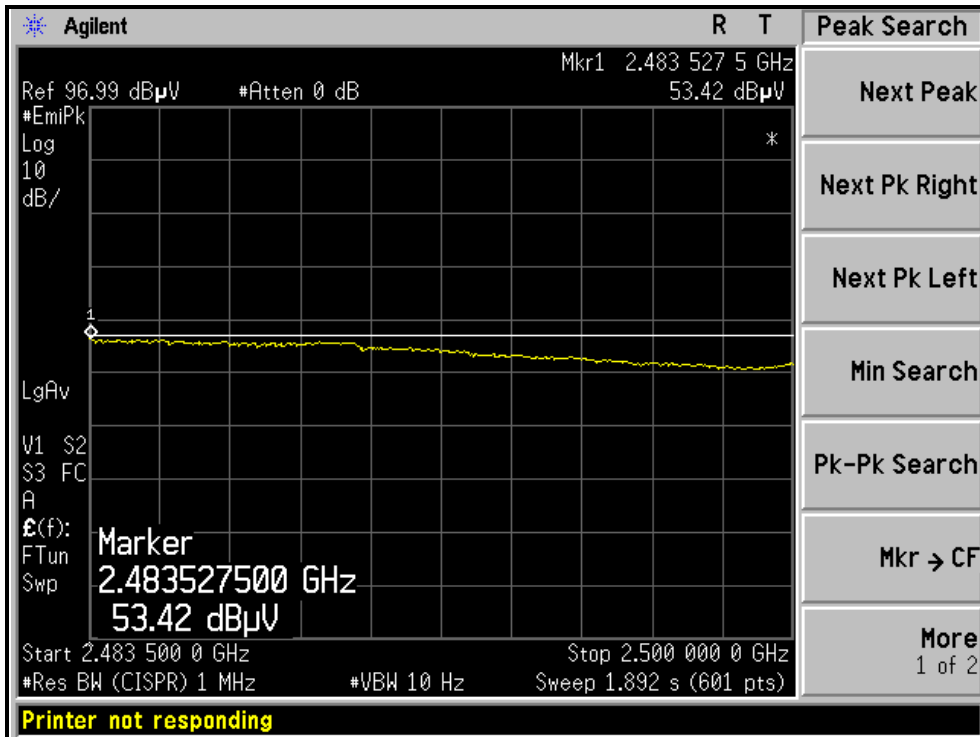
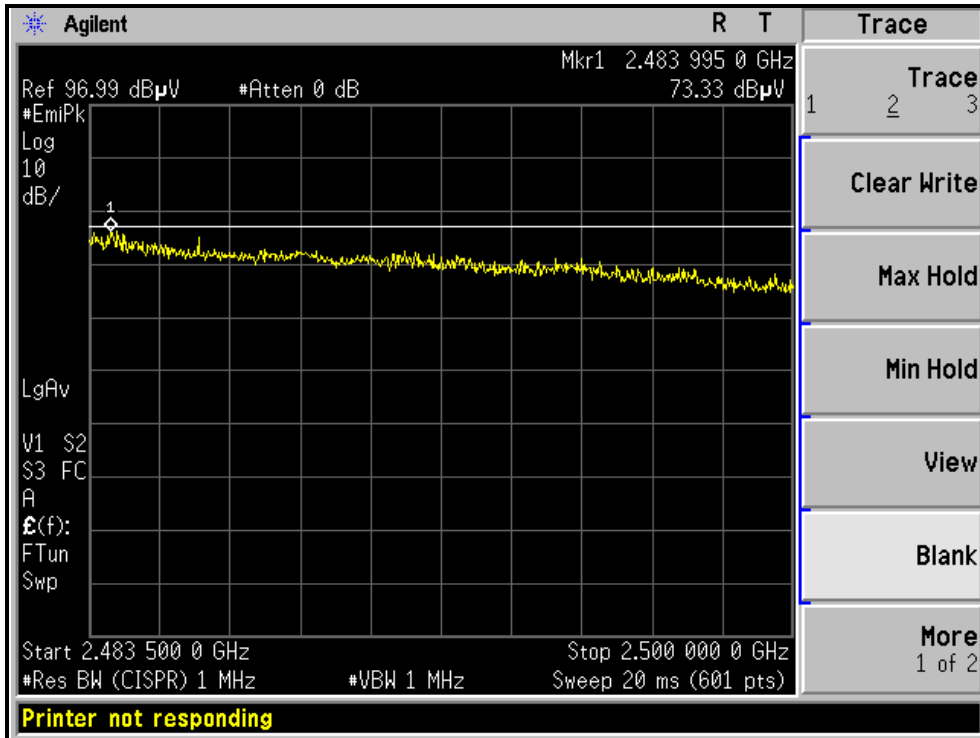



4.3 6dB BANDWIDTH MEASUREMENT

4.3.1 LIMITS OF 6dB BANDWIDTH MEASUREMENT

The minimum of 6dB Bandwidth Measurement is 0.5 MHz.

4.3.2 TEST INSTRUMENTS

DESCRIPTION & MANUFACTURER	MODEL NO.	SERIAL NO.	CALIBRATED DATE	CALIBRATED UNTIL
R&S SPECTRUM ANALYZER	FSP40	100037	Aug. 03, 2009	Aug. 02, 2010

NOTE:

- 1.The calibration interval of the above test instruments is 12 months and the calibrations are traceable to NML/ROC and NIST/USA.

4.3.3 TEST PROCEDURE

The transmitter output was connected to the spectrum analyzer through an attenuator. The bandwidth of the fundamental frequency was measured by spectrum analyzer with 100kHz RBW and 100kHz VBW. The 6dB bandwidth is defined as the total spectrum the power of which is higher than peak power minus 6dB.

4.3.4 DEVIATION FROM TEST STANDARD

No deviation

4.3.5 TEST SETUP

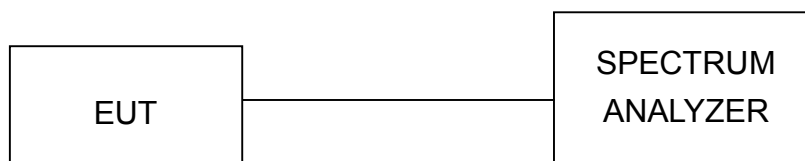

4.3.6 EUT OPERATING CONDITIONS

The software provided by client to enable the EUT under transmission condition continuously at lowest, middle and highest channel frequencies individually.

4.3.7 TEST RESULTS

802.11b DSSS MODULATION:

CHANNEL	CHANNEL FREQUENCY (MHz)	6dB BANDWIDTH (MHz)	MINIMUM LIMIT (MHz)	PASS / FAIL
1	2412	7.78	0.5	PASS
6	2437	8.23	0.5	PASS
11	2462	8.10	0.5	PASS

CH6

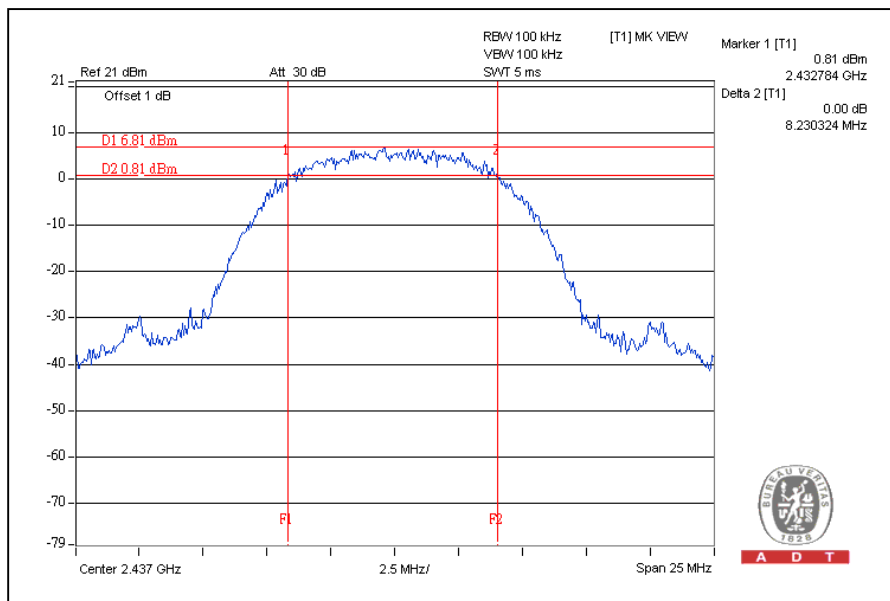

802.11g OFDM MODULATION:

CHANNEL	CHANNEL FREQUENCY (MHz)	6dB BANDWIDTH (MHz)	MINIMUM LIMIT (MHz)	PASS / FAIL
1	2412	15.14	0.5	PASS
6	2437	15.18	0.5	PASS
11	2462	14.86	0.5	PASS

CH6

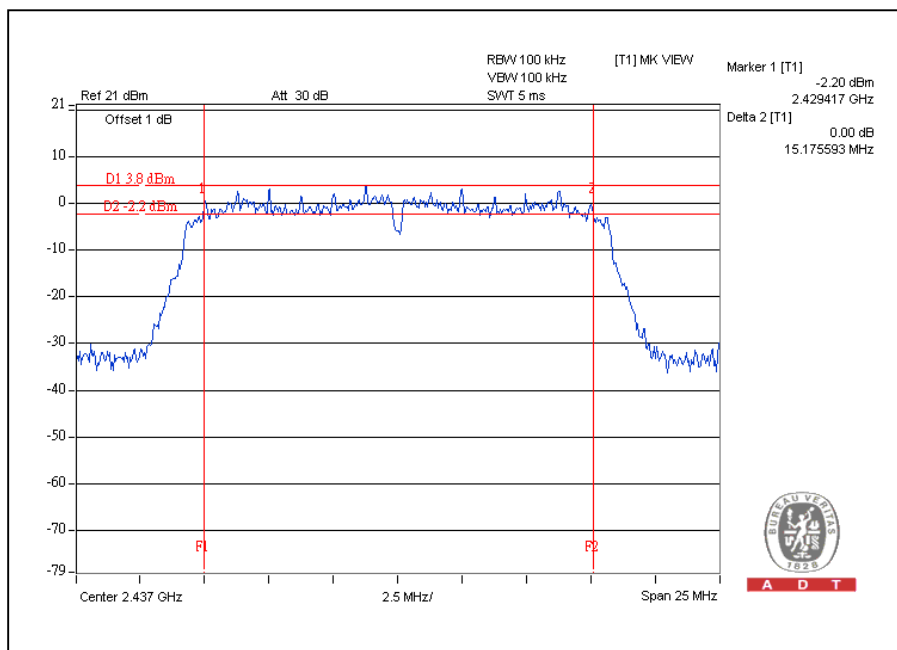

802.11n (20MHz) OFDM MODULATION:

CHANNEL	CHANNEL FREQUENCY (MHz)	6dB BANDWIDTH (MHz)	MINIMUM LIMIT (MHz)	PASS / FAIL
1	2412	16.91	0.5	PASS
6	2437	15.14	0.5	PASS
11	2462	15.12	0.5	PASS

CH1

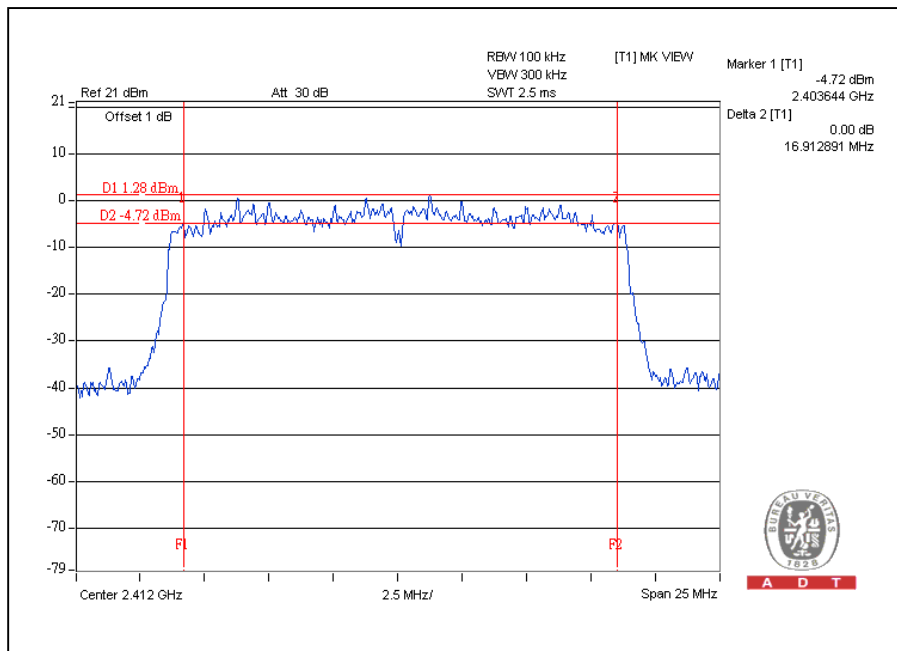

802.11n (40MHz) OFDM MODULATION:

CHANNEL	CHANNEL FREQUENCY (MHz)	6dB BANDWIDTH (MHz)	MINIMUM LIMIT (MHz)	PASS / FAIL
1	2422	35.78	0.5	PASS
4	2437	36.41	0.5	PASS
7	2452	35.85	0.5	PASS

CH4

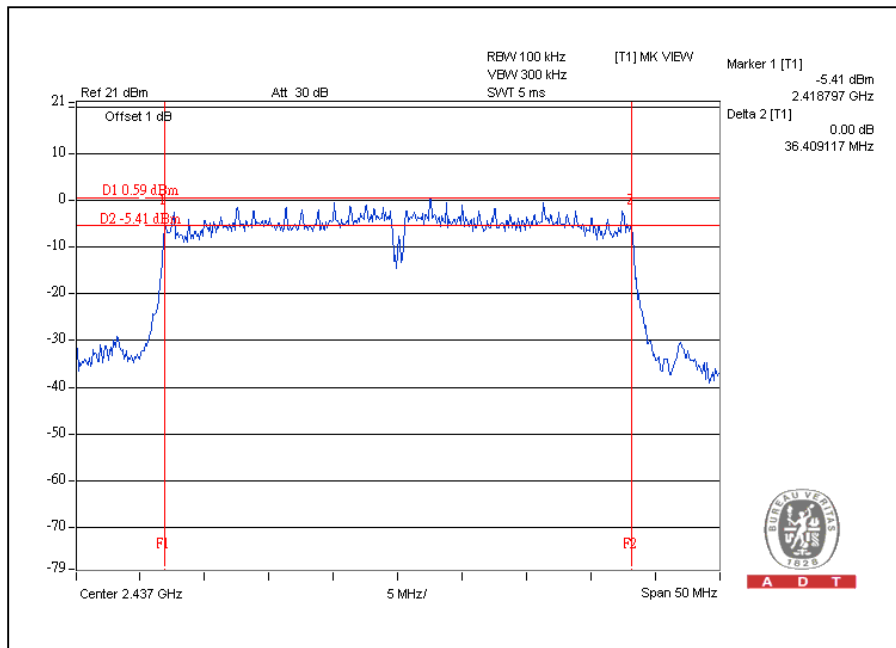

4.4 MAXIMUM PEAK OUTPUT POWER

4.4.1 LIMITS OF MAXIMUM PEAK OUTPUT POWER MEASUREMENT

The Maximum Peak Output Power Measurement is 30dBm.

4.4.2 INSTRUMENTS

DESCRIPTION & MANUFACTURER	MODEL NO.	SERIAL NO.	CALIBRATED DATE	CALIBRATED UNTIL
Anritsu Power Meter	ML2495A	0824006	April 25, 2009	April 24, 2010
Pulse Power Sensor	MA2411B	0738172	April 25, 2009	April 24, 2010

NOTE:

The calibration interval of the above test instruments is 12 months and the calibrations are traceable to NML/ROC and NIST/USA.

4.4.3 TEST PROCEDURES

1. The transmitter output was connected to the power meter through an attenuator; the bandwidth of the fundamental frequency was measured with the power meter.
2. Record the power level.

4.4.4 DEVIATION FROM TEST STANDARD

No deviation

4.4.5 TEST SETUP

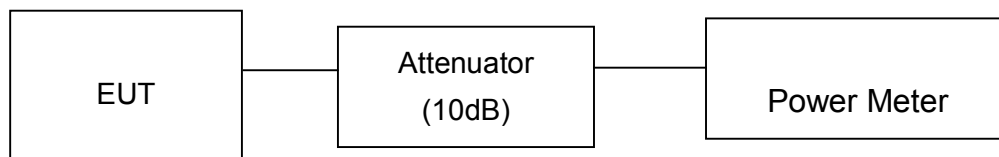

4.4.6 EUT OPERATING CONDITIONS

Same as Item 4.3.6



A D T

4.4.7 TEST RESULTS

802.11b DSSS MODULATION:

CHANNEL	CHANNEL FREQUENCY (MHz)	PEAK POWER OUTPUT (dBm)	PEAK POWER OUTPUT (mW)	PEAK POWER LIMIT (dBm)	PASS / FAIL
1	2412	18.9	77.6	30	PASS
6	2437	19.2	83.2	30	PASS
11	2462	19.1	81.3	30	PASS

802.11g OFDM MODULATION:

CHANNEL	CHANNEL FREQUENCY (MHz)	PEAK POWER OUTPUT (dBm)	PEAK POWER OUTPUT (mW)	PEAK POWER LIMIT (dBm)	PASS / FAIL
1	2412	22.6	182.0	30	PASS
6	2437	25.5	354.8	30	PASS
11	2462	24.3	269.2	30	PASS

802.11n (20MHz) OFDM MODULATION:

CHANNEL	CHANNEL FREQUENCY (MHz)	PEAK POWER OUTPUT (dBm)		TOTAL PEAK POWER (mW)	TOTAL PEAK POWER (dBm)	PEAK POWER LIMIT (dBm)	PASS / FAIL
		CHAIN(0)	CHAIN(1)				
1	2412	21.8	22.0	309.8	24.9	30	PASS
6	2437	24.0	24.2	514.2	27.1	30	PASS
11	2462	23.4	23.6	447.9	26.5	30	PASS



A D T

802.11n (40MHz) OFDM MODULATION:

CHANNEL	CHANNEL FREQUENCY (MHz)	PEAK POWER OUTPUT (dBm)		TOTAL PEAK POWER (mW)	TOTAL PEAK POWER (dBm)	PEAK POWER LIMIT (dBm)	PASS / FAIL
		CHAIN(0)	CHAIN(1)				
1	2422	21.5	21.9	296.1	24.7	30	PASS
4	2437	23.7	24.0	485.6	26.9	30	PASS
7	2452	21.0	21.3	260.8	24.2	30	PASS



4.5 POWER SPECTRAL DENSITY MEASUREMENT

4.5.1 LIMITS OF POWER SPECTRAL DENSITY MEASUREMENT

The Maximum of Power Spectral Density Measurement is 8dBm.

4.5.2 TEST INSTRUMENTS

DESCRIPTION & MANUFACTURER	MODEL NO.	SERIAL NO.	CALIBRATED DATE	CALIBRATED UNTIL
R&S SPECTRUM ANALYZER	FSP40	100037	Aug. 03, 2009	Aug. 02, 2010

NOTE:

- 1.The calibration interval of the above test instruments is 12 months and the calibrations are traceable to NML/ROC and NIST/USA.

4.5.3 TEST PROCEDURE

The transmitter output was connected to the spectrum analyzer through an attenuator, the bandwidth of the fundamental frequency was measured with the spectrum analyzer using 3kHz RBW and 30kHz VBW, set sweep time = span/3kHz. The power spectral density was measured and recorded. The sweep time is allowed to be longer than span/3kHz for a full response of the mixer in the spectrum analyzer.

4.5.4 DEVIATION FROM TEST STANDARD

No deviation

4.5.5 TEST SETUP

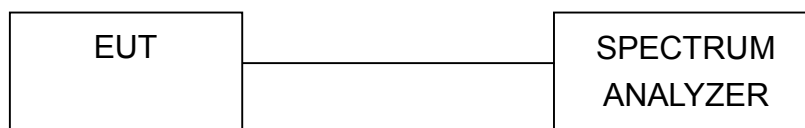

4.5.6 EUT OPERATING CONDITION

Same as Item 4.3.6



A D T

802.11g OFDM MODULATION:

CHANNEL	CHANNEL FREQUENCY (MHz)	RF POWER LEVEL IN 3kHz BW (dBm)	MAXIMUM LIMIT (dBm)	PASS / FAIL
1	2412	-11.6	8	PASS
6	2437	-9.4	8	PASS
11	2462	-10.9	8	PASS

CH6

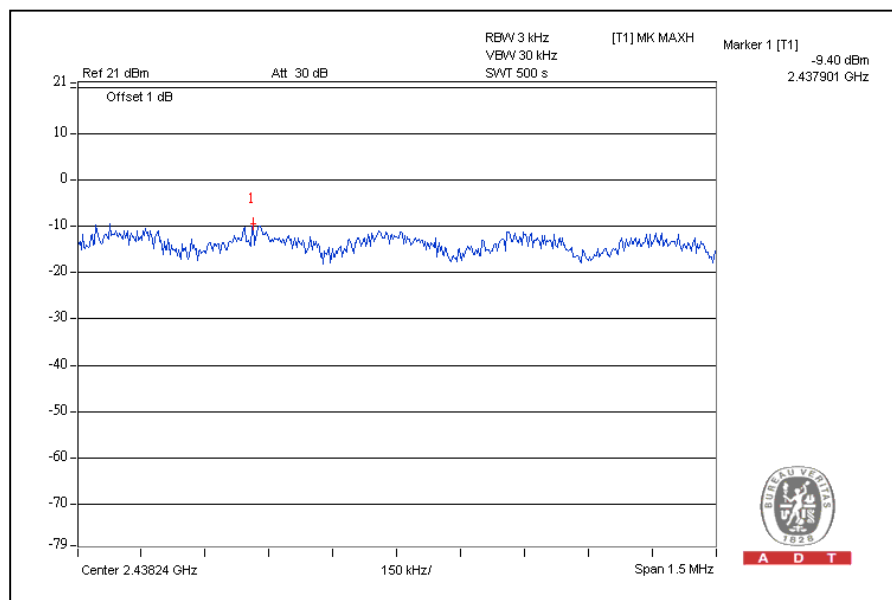



A D T

802.11n (20MHz) OFDM MODULATION:

CHANNEL	CHANNEL FREQUENCY (MHz)	RF POWER LEVEL IN 3kHz BW (dBm)		TOTAL POWER DENSITY (dBm)	MAXIMUM LIMIT (dBm)	PASS / FAIL
		CHAIN(0)	CHAIN(1)			
1	2412	-12.9	-12.8	-9.8	8	PASS
6	2437	-8.6	-8.2	-5.4	8	PASS
11	2462	-11.0	-12.2	-8.5	8	PASS

CH6

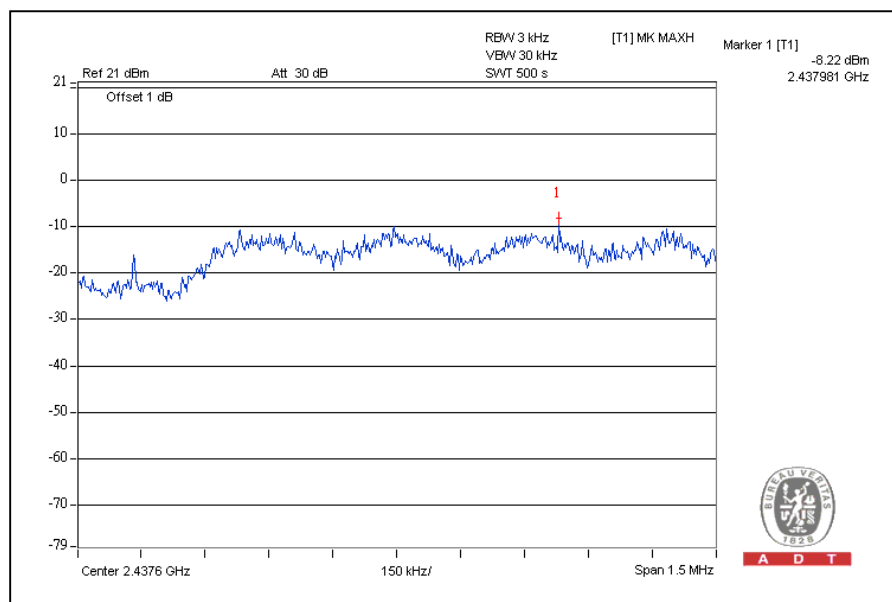



A D T

802.11n (40MHz) OFDM MODULATION:

CHANNEL	CHANNEL FREQUENCY (MHz)	RF POWER LEVEL IN 3kHz BW (dBm)		TOTAL POWER DENSITY (dBm)	MAXIMUM LIMIT (dBm)	PASS / FAIL
		CHAIN(0)	CHAIN(1)			
1	2422	-16.9	-14.6	-12.6	8	PASS
4	2437	-11.7	-11.5	-8.6	8	PASS
7	2452	-10.8	-16.2	-9.7	8	PASS

CH7

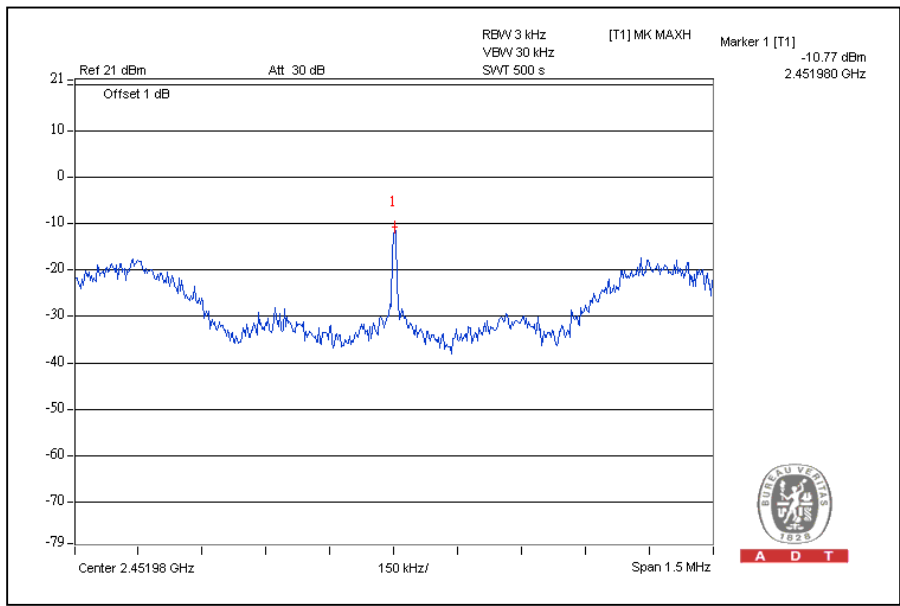

A D T



4.6 CONDUCTED OUT-BAND EMISSION MEASUREMENT

4.6.1 LIMITS OF CONDUCTED OUT-BAND EMISSION MEASUREMENT

Below -20dB of the highest emission level of operating band (in 100KHz Resolution Bandwidth).

4.6.2 TEST INSTRUMENTS

DESCRIPTION & MANUFACTURER	MODEL NO.	SERIAL NO.	CALIBRATED DATE	CALIBRATED UNTIL
R&S SPECTRUM ANALYZER	FSP40	100037	Aug. 03, 2009	Aug. 02, 2010

NOTE:

1. The calibration interval of the above test instruments is 12 months and the calibrations are traceable to NML/ROC and NIST/USA.

4.6.3 TEST PROCEDURE

The transmitter output was connected to the spectrum analyzer via a low loss cable. Set RBW of spectrum analyzer to 100kHz and VBW of spectrum analyzer to 300kHz with suitable frequency span including 100 MHz bandwidth from band edge. The band edges were measured and recorded.

The spectrum plots (RBW = 100kHz, VBW = 300kHz) are attached on the following pages.

4.6.4 DEVIATION FROM TEST STANDARD

No deviation

4.6.5 EUT OPERATING CONDITION

Same as Item 4.3.6

4.6.6 TEST RESULTS

The spectrum plots are attached on the following images. D1 line indicates the highest level, and D2 line indicates the 20dB offset below D1. It shows compliance with the requirement in part 15.247(d).



A D T

802.11b DSSS MODULATION:

CH1

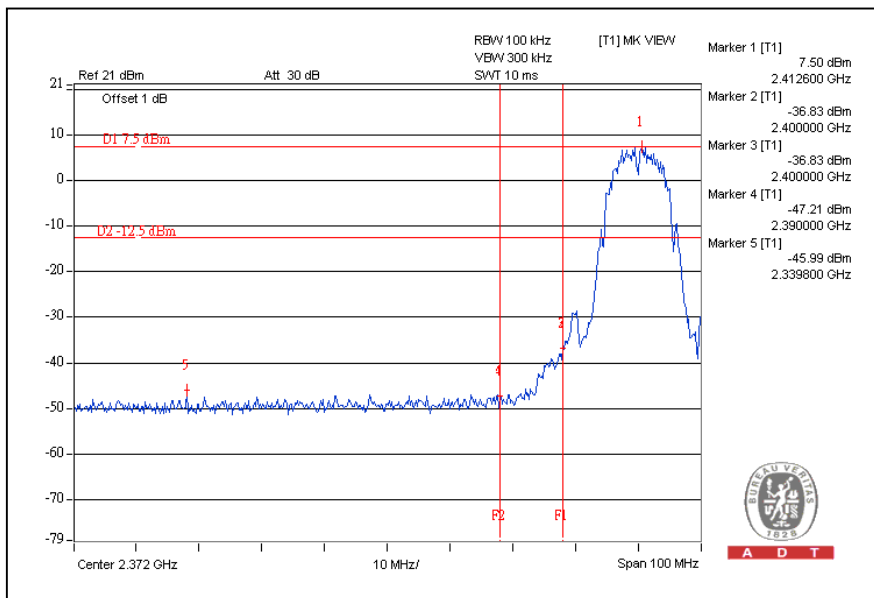

CH11

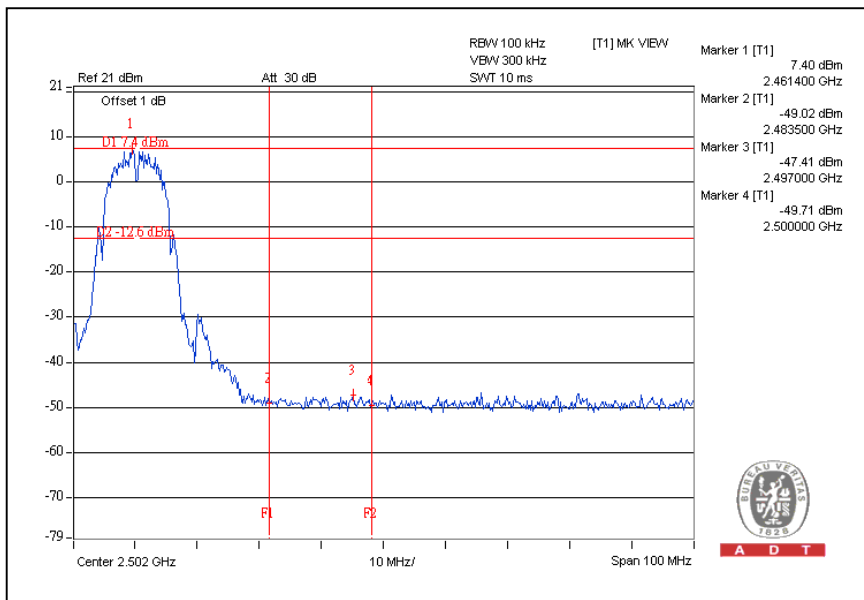



A D T

CH1

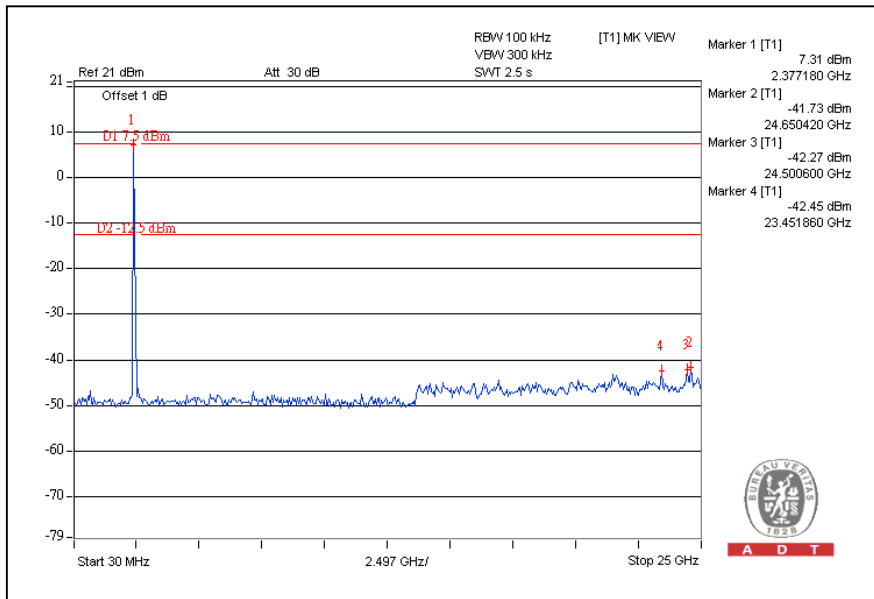

CH11

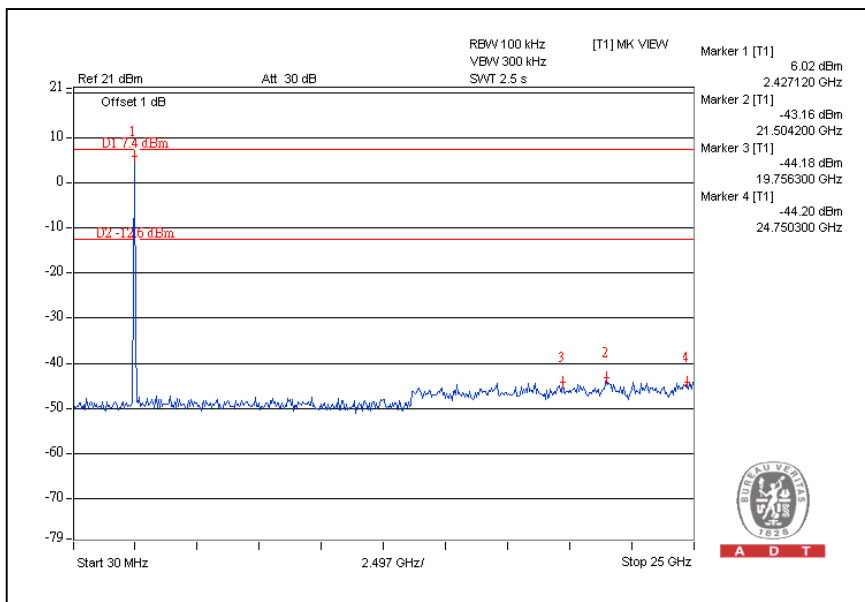



A D T

802.11g OFDM MODULATION::

CH1

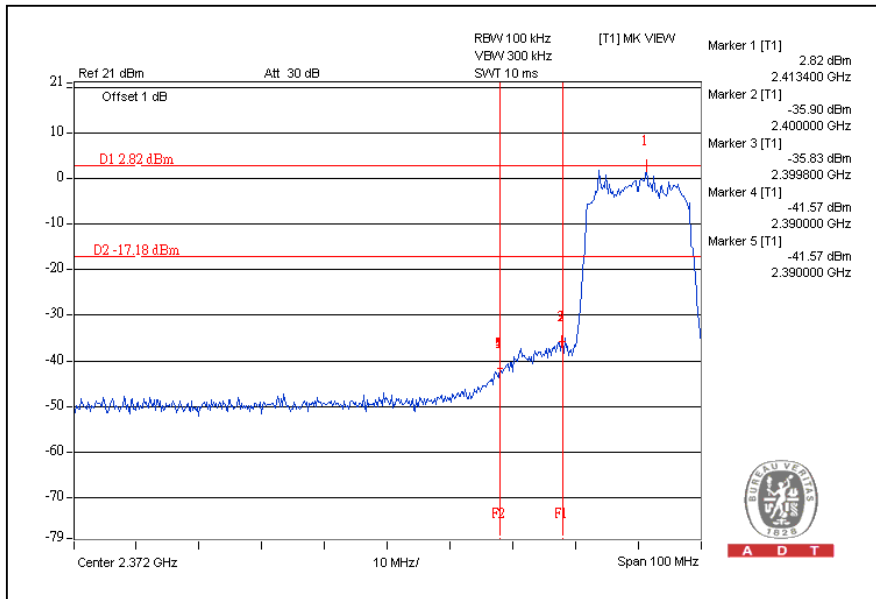

CH11

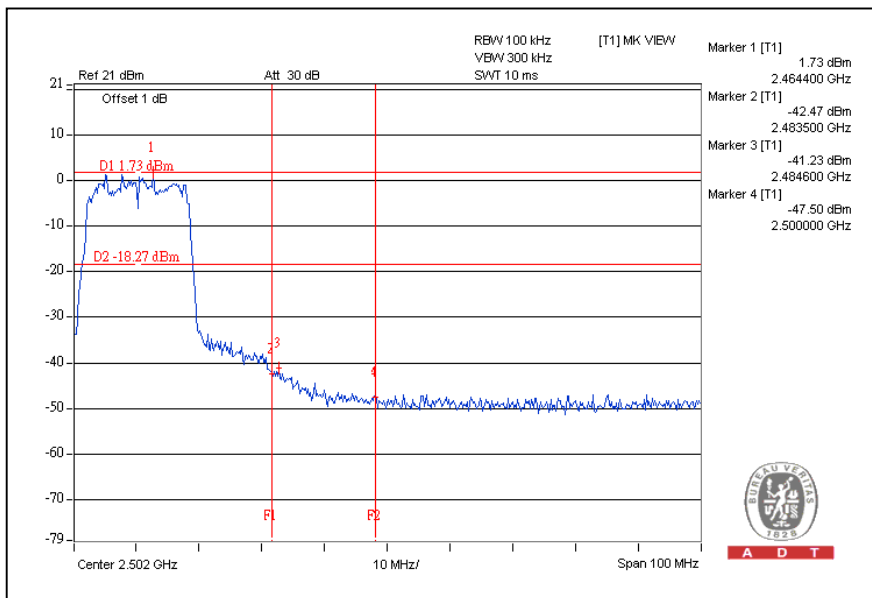

CH1

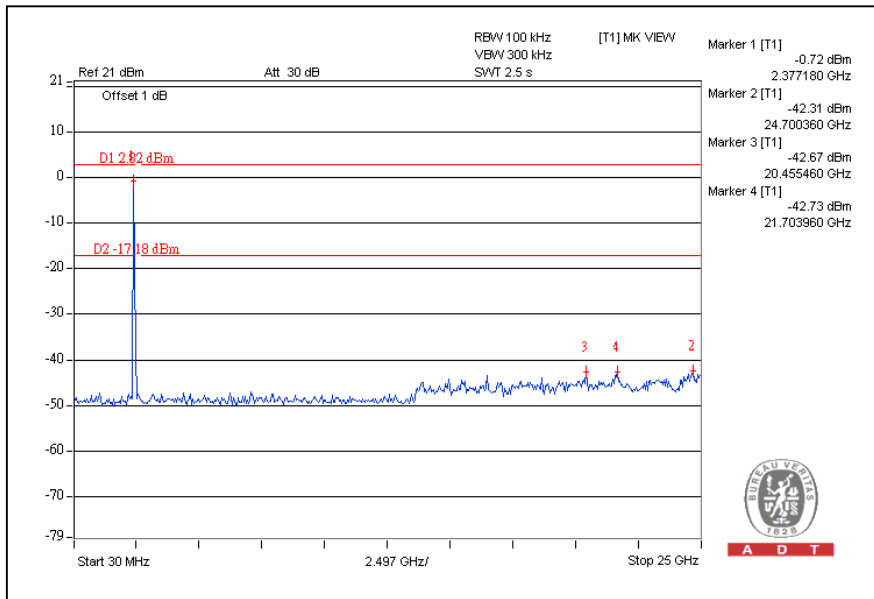

CH11

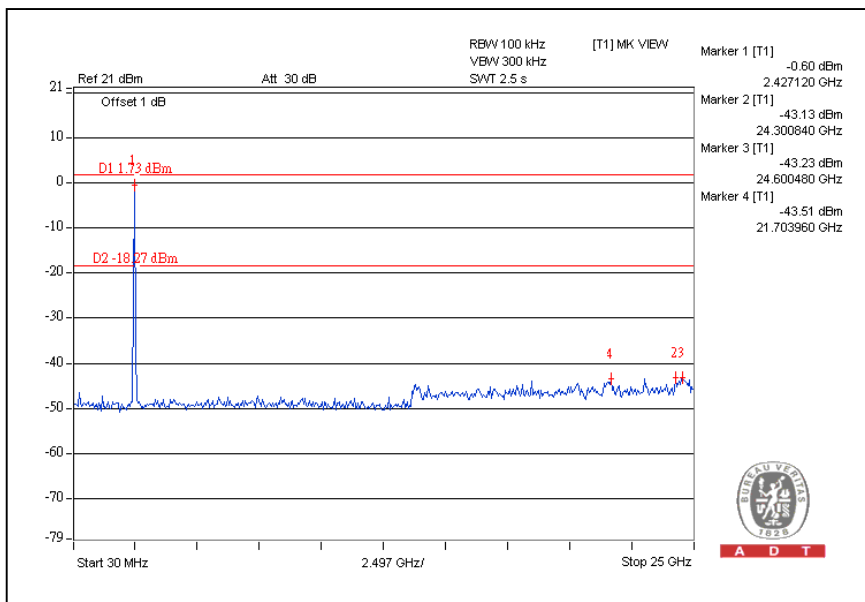

802.11n (20MHz) OFDM MODULATION:

CH1

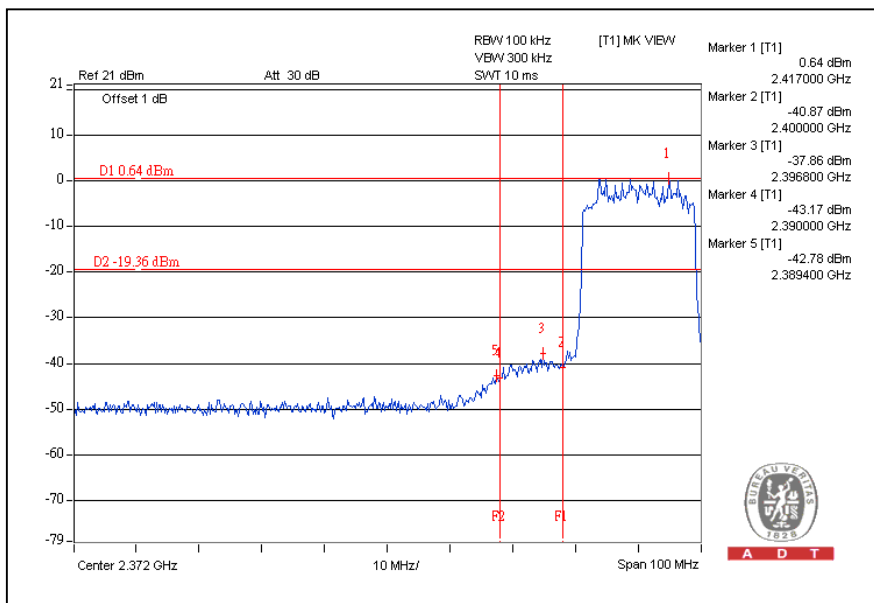

CH11

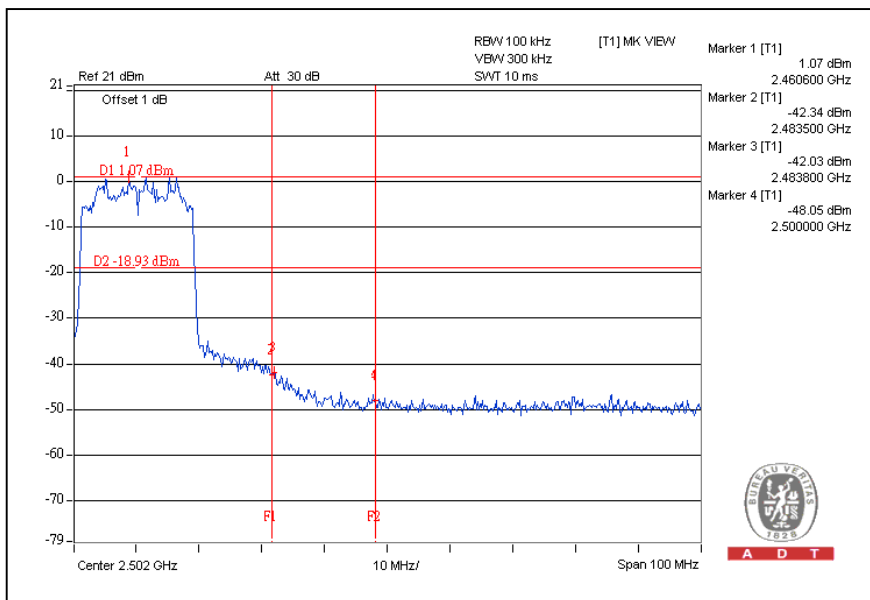



A D T

CH1

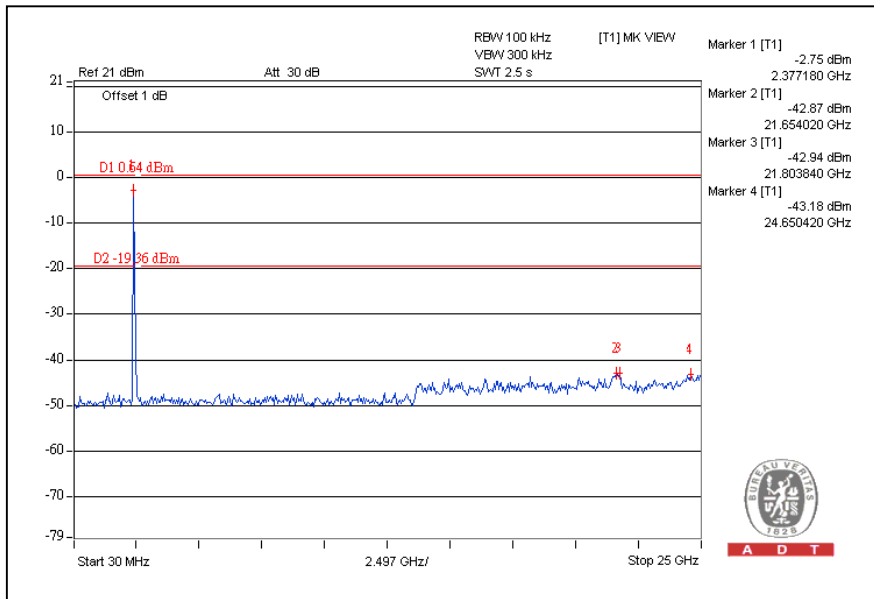

CH11

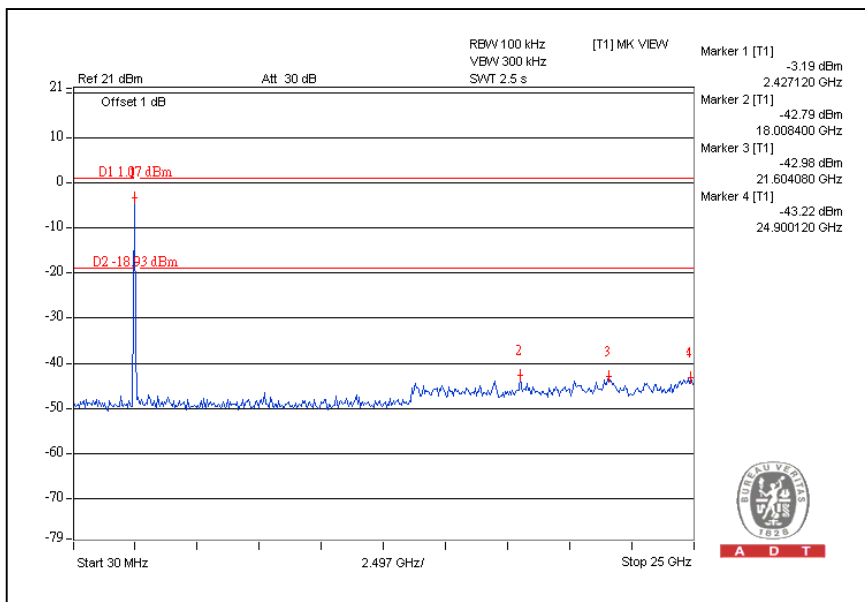

802.11n (40MHz) OFDM MODULATION:

CH1

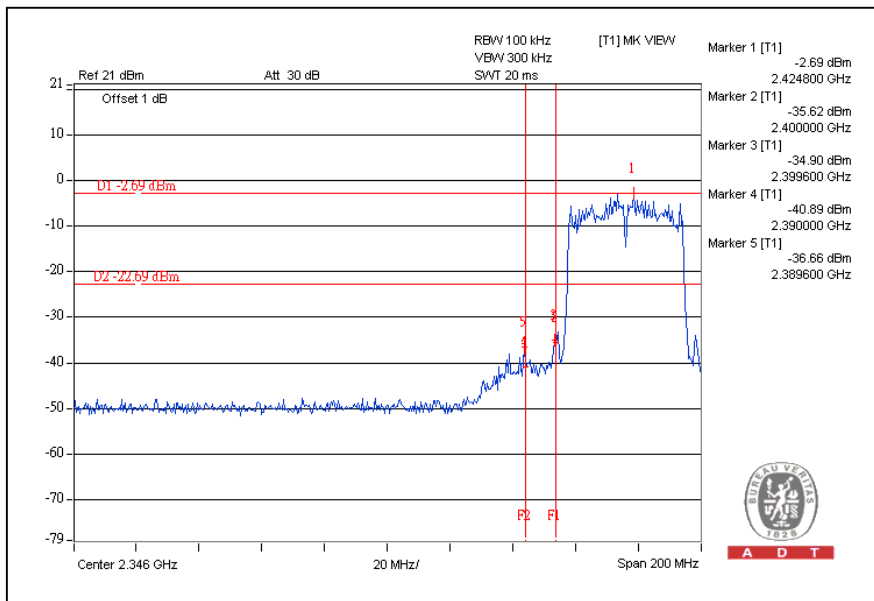

CH7

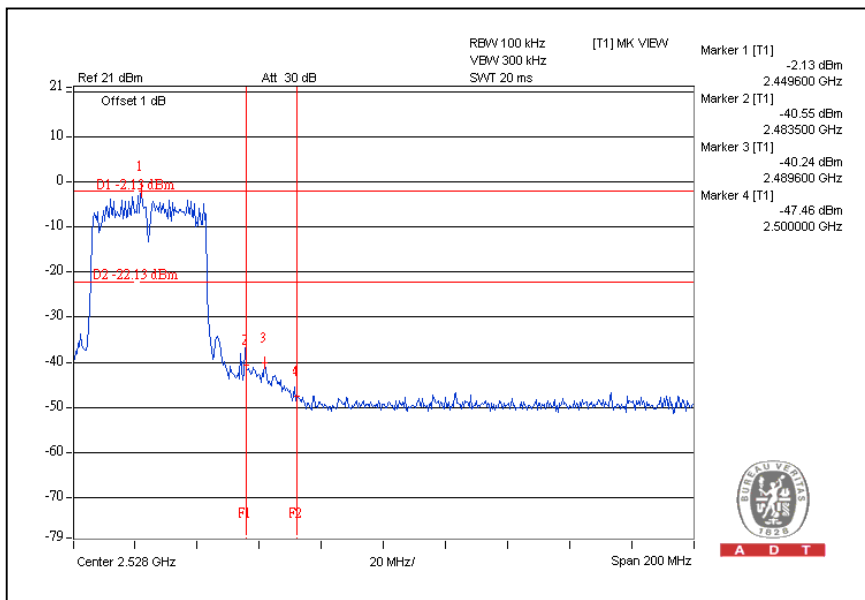



A D T

CH1

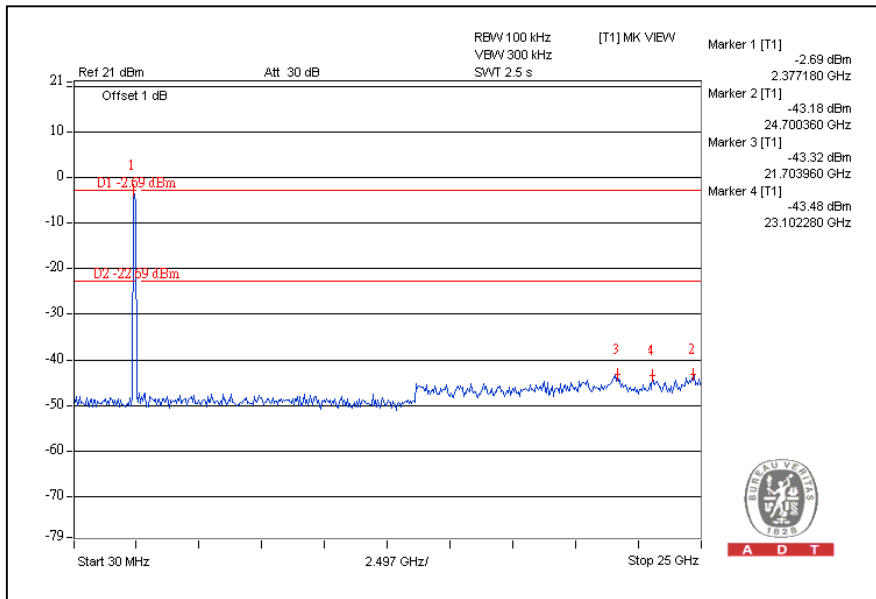

CH7

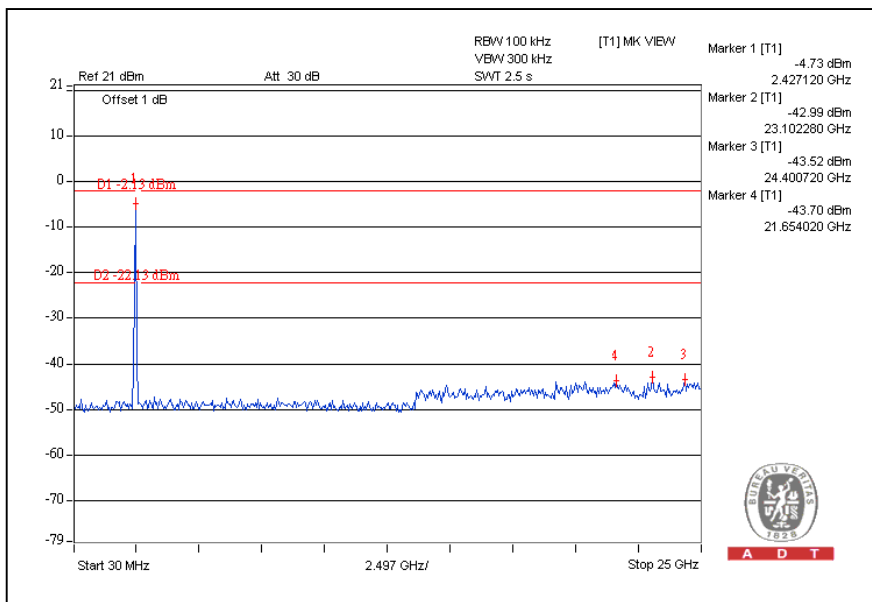



5. INFORMATION ON THE TESTING LABORATORIES

We, Bureau Veritas Consumer Products Services (H.K.) Ltd., Taoyuan Branch, were founded in 1988 to provide our best service in EMC, Radio, Telecom and Safety consultation. Our laboratories are accredited and approved by the following approval agencies according to ISO/IEC 17025:

USA	FCC, NVLAP
Germany	TUV Rheinland
Japan	VCCI
Norway	NEMKO
Canada	INDUSTRY CANADA, CSA
R.O.C.	TAF, BSMI, NCC
Netherlands	Telefication
Singapore	GOST-ASIA (MOU)
Russia	CERTIS (MOU)

Copies of accreditation certificates of our laboratories obtained from approval agencies can be downloaded from our web site:

www.adt.com.tw/index.5/phtml. If you have any comments, please feel free to contact us at the following:

Linko EMC/RF Lab:
Tel: 886-2-26052180
Fax: 886-2-26052943

Hsin Chu EMC/RF Lab:
Tel: 886-3-5935343
Fax: 886-3-5935342

Hwa Ya EMC/RF/Safety Telecom Lab:
Tel: 886-3-3183232
Fax: 886-3-3185050

Web Site: www.adt.com.tw

The address and road map of all our labs can be found in our web site also



A D T

6.APPENDIX-A- MODIFICATIONS RECORDERS FOR ENGINEERING CHANGES TO THE EUT BY THE LAB

No any modifications are made to the EUT by the lab during the test.

---END---