



**CDR8011 Series Manual  
iDVR800  
Quick Start Guide**





### Important Notes to Read Before Use

- The CDR8011 operates on a voltage of 5 V DC. To power up the product, connect it to a cigarette lighter socket.
- The CDR8011 accepts SD cards formatted to FAT32 only. For optimum results, format the SD card before initial use with the CDR8010.
- Operating environment: Charge Temperature 0~60°C; Discharge Temperature 0~50°C
- The CDR8011 may not be able to use the Global Positioning System (GPS) in the following areas:
  - Indoor parking lot
  - Tunnels
  - While under multi-layer highways
  - Between closely positioned high buildings and trees



### Safety Instructions

For users' attention, scenario-specific safety instructions are provided in the following three boxes throughout the document. Following these instructions will help prevent untoward incidents in the use of the CDR8011.

CAUTION	WARNING	NOTE
Failure to follow the instructions provided under "Caution" will lead to data loss.	Failure to follow the instructions provided under "Warning" will lead to serious injury or death, and property damage.	Instructions provided under "Note" provides insights for prudent use of the product.

### Package Contents

CDR8011 Connected Car CAM

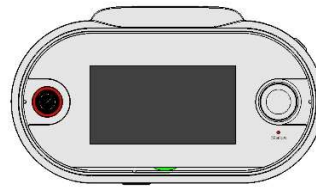

Mount Bracket

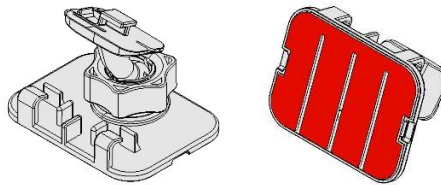

USB Type C to Cigarette Car Charger

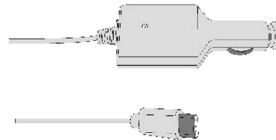

Quick Start Guide



Micro SD card and SD Card Adaptor



Overview

Device Overview

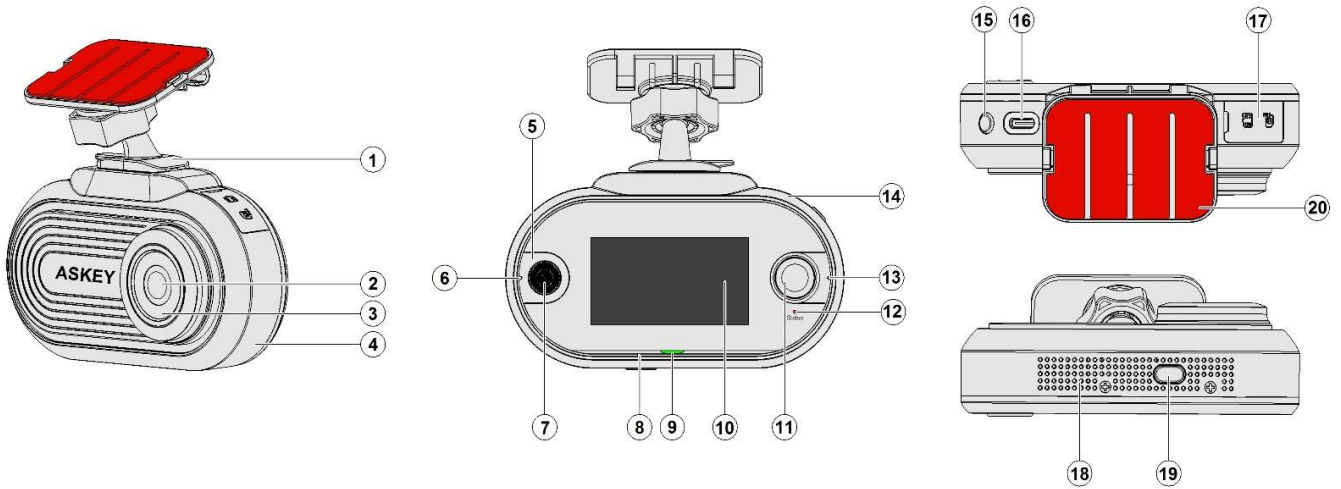

No.	Description
1	Bracket
2	Front Camera
3	Metal Decoration
4	Front Housing
5	E-Call Light Guide
6	Microphone 1
7	E-Call Button
8	Microphone 2
9	Alexa Light Guide
10	Touch Panel

No.	Description
11	Rear Camera
12	Status Light
13	Microphone 3
14	Rear Housing
15	Power Button
16	USB Type C-Port
17	SD Card Cover
18	Speaker Opening
19	Mute Button
20	Film



Getting Started

## Mounting Instructions

**Step 1:** Clean the windshield area properly using a soft cloth. Apply a glass cleaner liquid to the cloth, if required.

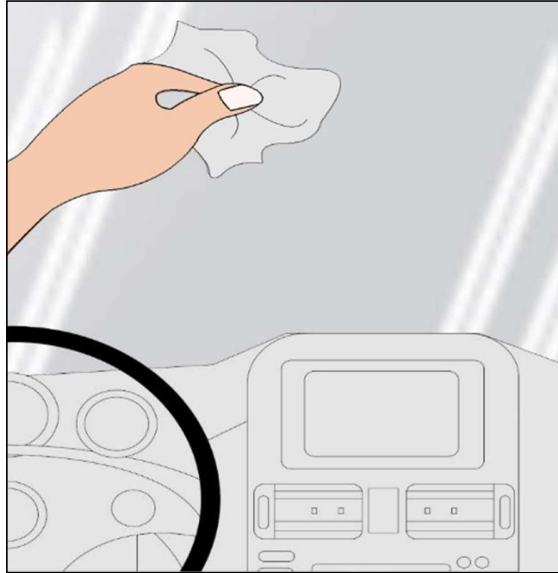

**Step 2:** Lock the mounting bracket into the mounting slot of the device.

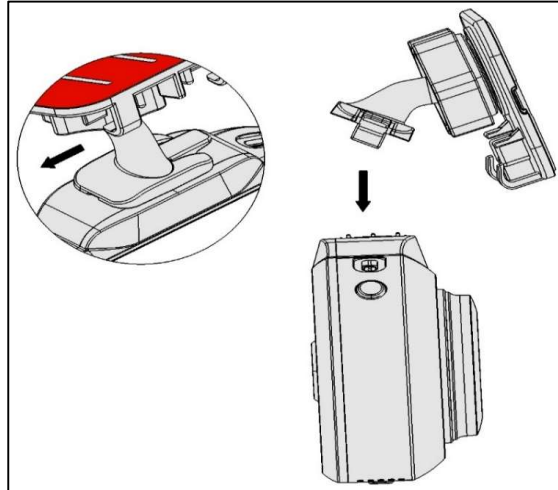

**Step 3:** Peel off the film from the upper surface of the mounting bracket.

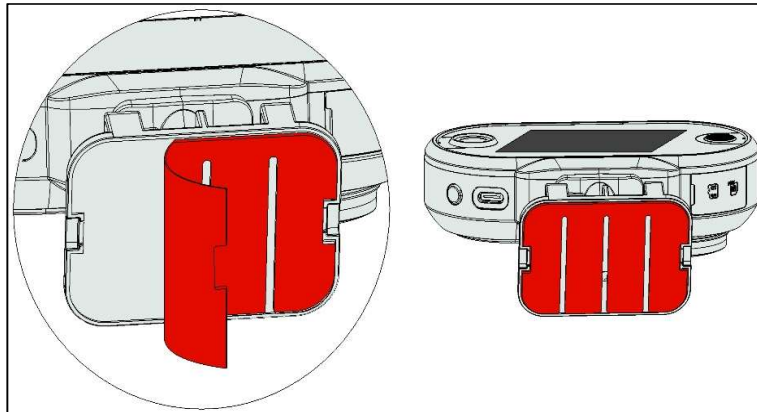

**Step 4:** Position the mounting bracket on the windshield; press the bracket with your thumb to against the windshield.

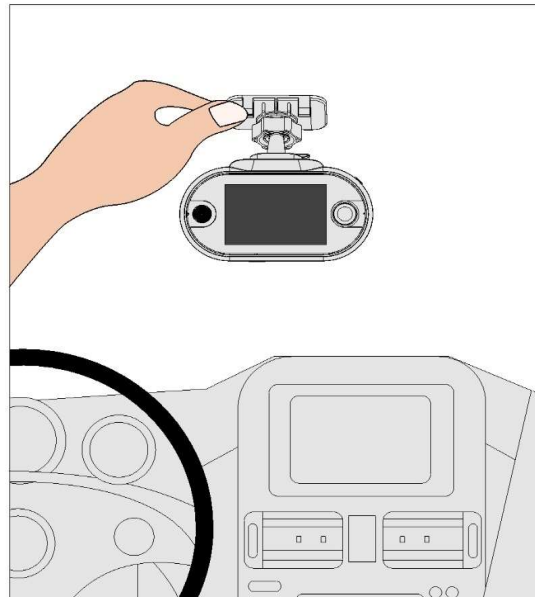

## Insertion of SD Card and SIM Card

### NOTES

- The CDR8011 does not function without SD card.
- The CDR8011 supports only Nano sim cards (LTE/3G).

To insert the **SIM** card (1)/ **SD** card (2):

1. Open the **SD** card cover.
2. Place the **SIM** card (1)/ **SD** card (2) in the slot per orientation marking.
3. Push the **SIM** card (1)/ **SD** card (2) into the slot.
4. Close the **SD** card cover properly.

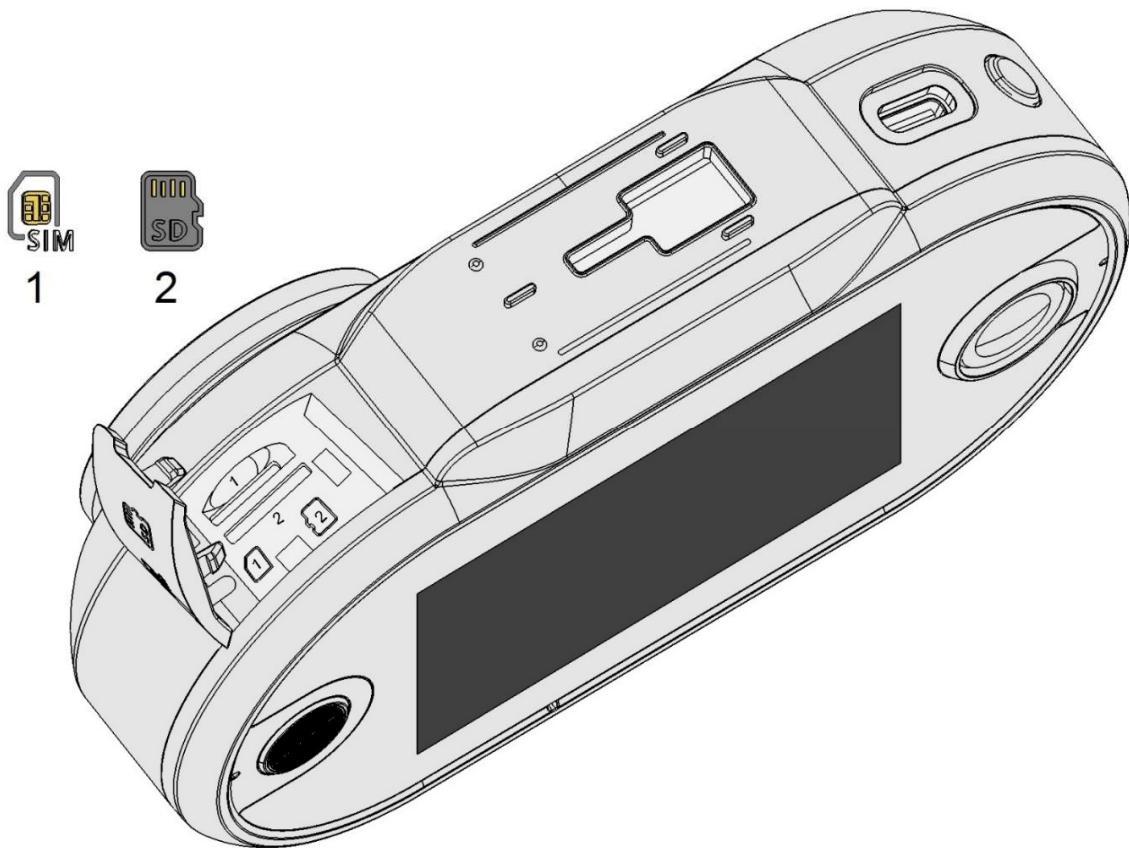

## Activation and Battery Charge

### NOTES

- Make sure that SD card is inserted into the CDR8011. If the SD card is not inserted, you cannot activate the CDR8011.
- Always use the attached car charger to activate and charge the CDR8011.

To activate and charge the CDR8011:

1. Plug one end of the charger into device's USB Type C-Port.
2. Plug the other end of the charger into the cigarette lighter socket of your vehicle.
3. When the vehicle's engine starts, the CDR8011 turns on and the built-in battery begins to charge. When the ignition key is turned off and the vehicle's engine stops, the CDR8011 goes to "Sleep" mode 3 seconds later. Note that while in "Sleep" mode, the CDR8011 consumes battery power.

### Manual Power Off

To turn CDR8010 off manually:



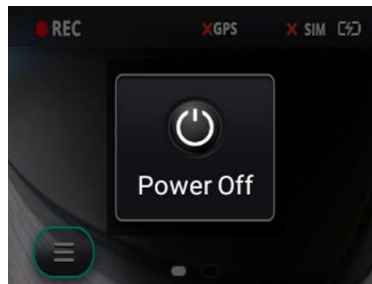







1. Press the "**Power Off**" button and Hold for 3 seconds. The "**Power off**" confirmation dialog box displays on touch screen.
2. On the confirmation dialog box, touch:
  - Touch "**Power off**" to turn off the device.
  - Touch other areas on the display to **cancel**.















## Screen Icons/Buttons



Icons/Buttons/Indicators	Description
	Main menu
	Firmware update available (dot on Main menu)
	Recording ON icon
	Recording error/OFF icon
	Recording event icon
	No SIM card
	No GPS signal
	3G/4G Cellular connection
	Battery Charge Level, 25%, 50% and 75%
	Battery Charge in progress
	Broken cameras

Icons/Buttons/Indicators	Description
	Impact
	E-call Answer/End buttons
	Wi-Fi connection status with signal strength
	Bluetooth on/off
	Hotspot on/off
	Front cam recording icon
	Rear cam recording icon
	Back button
	Play button
	Pause button

## Touch Screen Operations

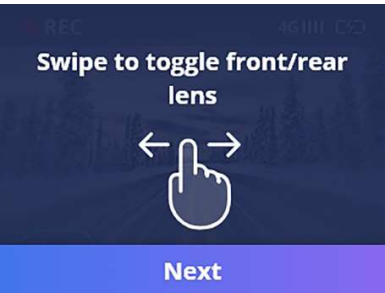
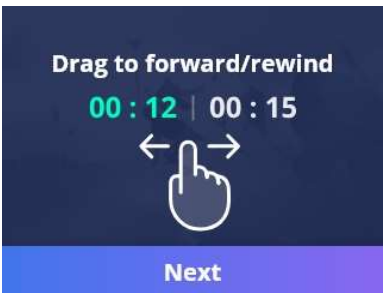
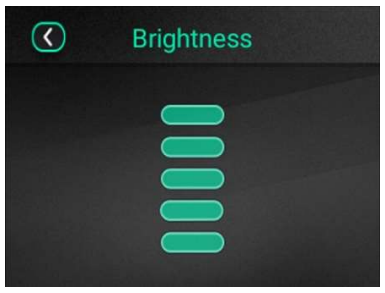
Description	Operation Example	Action
<p><b>Volume Adjustment (from Default Recording Screen)</b></p>		<p>Swipe up to increase the volume. Swipe down to decrease the volume.</p>
<p><b>Toggle between Cameras (from Default Recording Screen)</b></p>		<p>Swipe right to use the rear cam. Swipe left to use the front cam.</p>
<p><b>Forward or Rewind Video (from Playback option)</b></p>		<p>Swipe right to forward. Swipe left to rewind</p>
<p><b>Screen Brightness Adjustment (from Display option)</b></p>		<p>Swipe up to increase the brightness. Swipe down to decrease the brightness.</p>

## NOTES

To access the **Main menu**:

- Ensure the CDR8011 is activated and battery charging is in progress
- Ensure the CDR8011 is registered on an LTE/3G or Wi-Fi network
- Ensure the automatic video recording mode (default screen) is on.

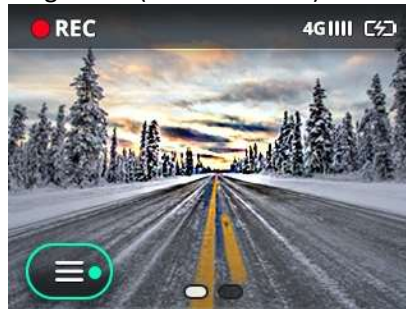

1. Touch the **Menu** icon  on the recording screen to access all the operational functions of the CDR8011.
2. The **Menu** is displayed on as shown below.

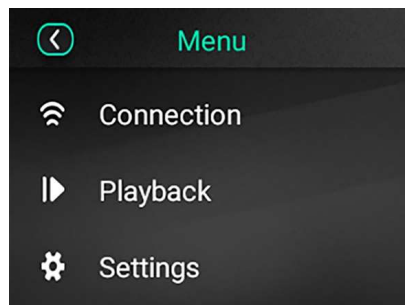

3. To go back to the previous (recording) screen, touch the **Back** icon .

## Connection Menu

- The **Connection** menu allows user to set up (Wi-Fi, cellular data), Bluetooth and hotspot connections. This section explains you on how to connect/disconnect the CDR8011 to/from the network (**Wi-Fi/Cellular data**), Bluetooth, and share **Cellular data** to co-passengers through **Hotspot** option.
- To set connectivity options, open the default recording screen and go to **Menu icon**  > **Connection**.

### NOTE

- The Cellular and Hotspot options become unavailable when the CDR8010 is disconnected from an LTE/3G network.

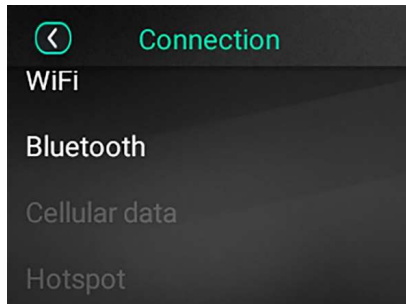

With Wi-Fi Connection

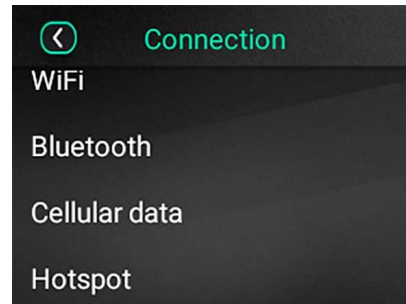

With LTE/3G Network

## Wi-Fi

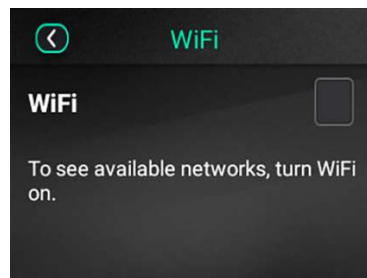

The CDR8010 supports IEEE\_802.11 a/b/g/n/ac, 2.4 GHz and 5 GHz Wi-Fi connections. Perform the following steps to access the Wi-Fi connectivity option:

1. To find and register the CDR8011 on the available Wi-Fi network, go to **Menu**  > **Connection** > **WiFi**.
2. **WiFi** screen displays on touch screen.

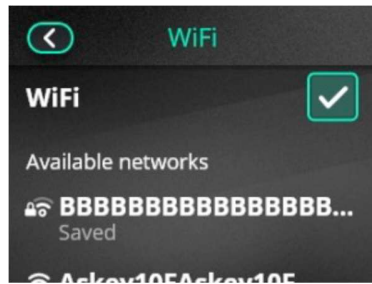

3. Select the **WiFi** check box .
  - On selecting the **WiFi** check box , a list of Available networks is displayed on the screen.



4. Select the required network from the Available networks list and enter the password to connect to the network if required.
5. To go back to previous screens, touch the **Back** icon .
6. If you want to disconnect the CDR8011 from the Wi-Fi network, clear the **WiFi** check box  or touch the cross icon , to disconnect the current **WiFi** connection.

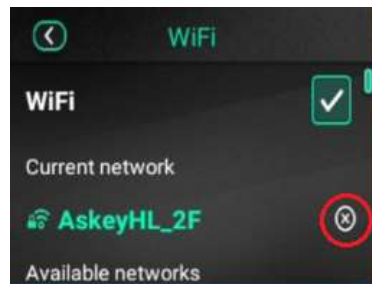

## Bluetooth

The CDR8011 supports Bluetooth 4.2, on Serial Port Profile (SPP). To pair the CDR8011 with a Bluetooth device:

1. Go to **Menu**  > **Connection** > **Bluetooth**.
2. The **Bluetooth** screen is displayed on the touch screen.



3. Select the **Bluetooth** check-box .

  - On selecting the **Bluetooth** check box , a list of **Available devices** is displayed on the screen.

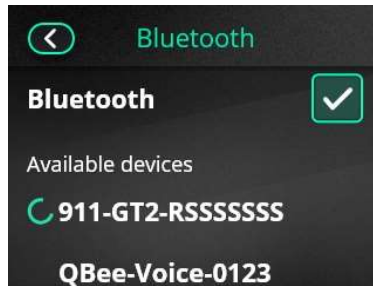

4. Select the required device from the **Available devices** list to pair.



5. On successful pairing, paired Bluetooth device appears in the **Paired devices**.
6. If your Bluetooth device is already available in **Paired devices** list, you can skip previous step.
7. Touch required Bluetooth device from **Paired devices** list to connect. It takes couple of seconds to connect.



8. Successful connection is indicated by the **Bluetooth** icon  against the device name.

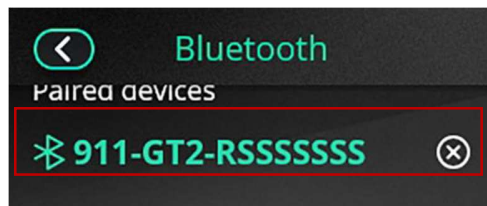

9. To go back to the previous screens, touch the **Back** icon  .

10. To disconnect the CDR8011 from the connected **Bluetooth** device, clear the **Bluetooth** check box  or from the default recording screen, swipe down and clear the **Bluetooth** icon selection.

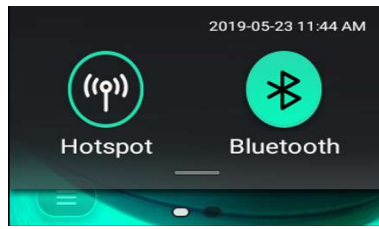

Bluetooth ON

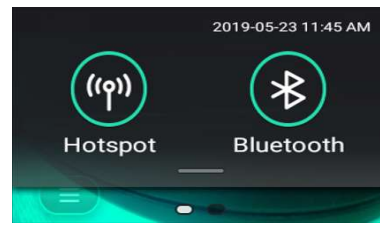

Bluetooth OFF

## Cellular Data (LTE/3G)

### NOTE

- To enable Cellular Data, make sure that SIM card is inserted and working fine.

To use **Cellular Data** on the CDR8011:

1. Go to **Menu**  > **Connection** > **Cellular data**.
  - **Cellular data** screen displays on touch screen.

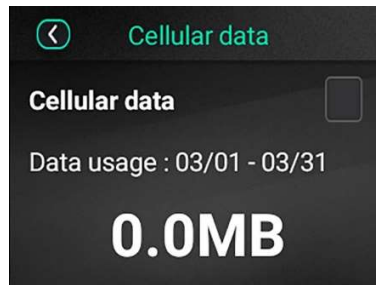

2. Select the **Cellular data** check box .
  - On selecting the **Cellular data** check box , CDR8011 connects to Cellular data and shows the Data usage for the current month.

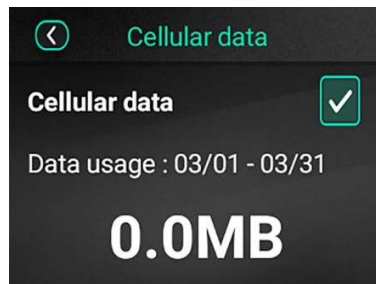

3. To go back to the previous screens, touch the **Back** icon .
4. To turn Cellular data off, clear the **Cellular data** check box .



## Hotspot

### NOTE

- The CDR8010 acts as a Wi-Fi hotspot access point only when Cellular data is enabled.

To activate **Hotspot** on the CDR8011:

1. Go to **Menu**  > **Connection** > **Hotspot**.
  - **Hotspot** screen displays on touch screen.



2. Select the **Hotspot** check box .
  - On selecting the **Hotspot** check box , Co-passenger will now be able to find the CDR8011 listed on their phones and connect to the Wi-Fi network by entering the associated password, which is available on the Hotspot screen.



3. To turn Hotspot off, clear the **Hotspot** check box  or from the default recording screen, swipe down and clear the Hotspot icon selection.

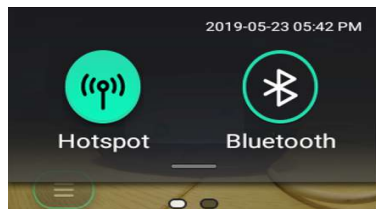

Hotspot ON

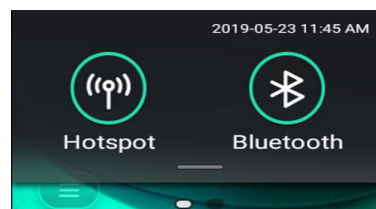

Hotspot OFF

## Playback Menu

The **Playback** provides access to all the Event and Continuous Videos and to view Still images stored on SD card or CDR8011 internal memory.



- To access the **Playback menu**, go to **Menu**  > **Playback** on the default recording screen.

### NOTE

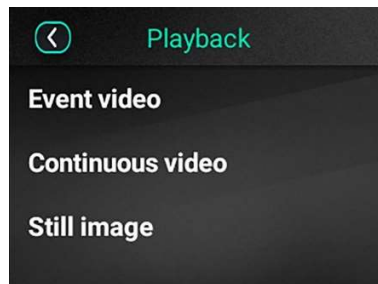
- If the SD card does not have sufficient memory, the older files are overwritten automatically by newly recorded files.



### NOTE

- CDR8010 records videos using both front and rear cameras simultaneously.
- The CDR8011 stores the recorded video clips in the following location: [\\sdcard\event\event\\_data\\_video](\\sdcard\event\event_data_video). Videos are uploaded on to the cloud from this path.
- The CDR8011 records clips for a maximum of 15 seconds.
- Videos recorded by the front camera are indicated by , those recorded by the rear camera are indicated by 

## Settings Menu

To access the **Settings menu**, go to **Menu**  > **Settings**.

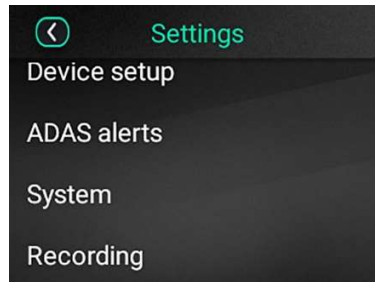

## Device Setup

To access the Device Setup option, go to **Menu**  > **Setting** > **Device Setup**.

### NOTE

- For accurate ADAS calibration, first mount the device and then select the **device setup**.

1. Touch **Go**

Go



2. Select the type of vehicle to be driven: **Sedan, SUV, or Truck**.

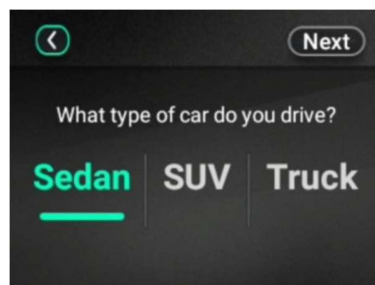

Next

3. Touch **Next**

4. Adjust the Horizon line and the hood to arrive at an appropriate field of view.

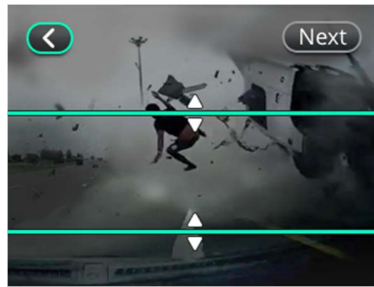

5. Touch **Next** 
6. Adjust the vertical line along the center of the lane.



7. Touch **Done** 

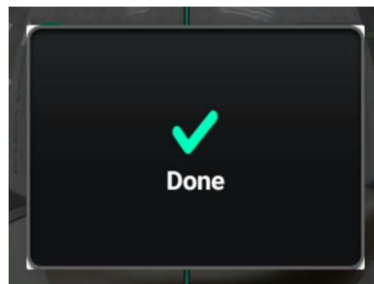

## Advanced Driver-Assistant System Alerts

The ADAS helps detect dangerous driving conditions such as a Forward Collision and Lane Departure. In slow-moving traffic and tailbacks conditions, the Stop & Go function examines the distance between the host vehicle and other vehicles in the front, and triggers an alert for the driver to move carefully with the traffic.

The ADAS generates a voice alert if:

- The vehicle is too close to the moving vehicle in the front.
- The vehicle deviates from the original lane.
- 

### NOTE

- If ADAS alerts are not turned on, the CDR8011 fails to trigger an alert when the vehicle faces a risk, which will eventually lead to accidents.

To turn ADAS alerts on:

1. Go to **Menu**  > **Settings** > **ADAS alerts**.
2. Select the check boxes  for **Forward collision** and **Lane departure** .

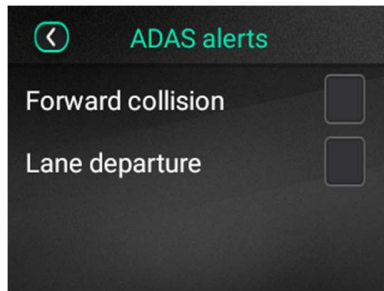

ADAS Alerts OFF

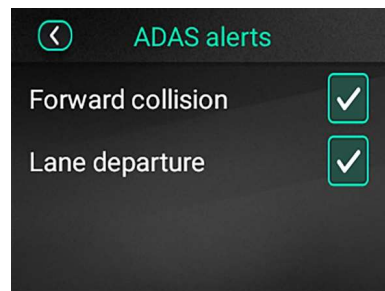

ADAS Alerts ON

## Auto Calibration with ADAS

When the ADAS (contains LDWS + FCWS) is enabled, the ADAS engine calibrates parameters of hood level, horizontal level and horizontal pan automatically. It takes 1-2 minutes to calibrate these parameters.

## Technical Specifications

Category	Specification	Details
Design	Length	124 mm
	Width	69.4 mm
	Height	29.5 mm
	Weight with Cradle	229 g
Display	Screen Size	2.7-inch
	Screen Resolution	QVGA 320 × 240 pixel
	Display Type	LED backlight TFT panel
	Brightness	200 nits
	Touch Screen	Capacitive Touchscreen, Multi-touch
Performance	Operating System	Android 9.0
	Processor	Qualcomm SDM450 (8 core ARM A53 1.8 GHz)
	Main Memory	On board 2 GB LPDDR3 and 16 GB eMMC (eMCP)
Storage	SD Card Slot	Single Micro-SD
	Expandable Memory	Support up to 128 GB SDXC
Camera (Main and CH2)	Resolution	4 MP
	Physical Aperture	2.0
	Video Recording	Camera angle: 1ch Camera & 2ch Camera: Horizon FOV 153° (HFOV 136°) Video recording 1080p 30fps
Special Features	Sensors	G-Sensor (Accelerometer) Gyroscope GPS, GNSS, A-GPS, Galileo, Glonass, and QZSS
Battery	Capacity	750 mAh
	Type	Lithium-ion
	Removable	No
	Standby time	30 minutes at 100 nits, 720 p, Playback
Network and Connectivity Network and Connectivity	Wi-Fi	IEEE802.11 a/b/g/n/ac, 2.4 GHz and 5 GHz
	Wi-Fi Features	Mobile Hotspot v 4.2,
	Bluetooth	Profile – HFP- AG, HSP - AG, PAN - NAP, PANU, HID - Host, A2DP - Source, BNEP, SDP, SPP, GATT, AVRCP
	GPS	GNSS, AGPS, Beidou, Galileo, GLONASS, QZSS
	NFC	Type A, B, F
	USB Type-C	USB charging
Multimedia WLAN	Audio	1x Built-in high-quality speaker (normal 1 W, max 1.5 W)
	Microphone	3x Digital Microphone
	Voice Function	Amazon Alexa
	Security	SSIDMAC Address filtering, Multi-SSID WPA (TKIP/AES)/WPA2-PSK (TKIP/AES), WEP (128 bit)



## Environmental Conditions

Condition	Range
Operation	-10 to 60 °C
Mechanical	-10 to 85 °C
Storage	-40 to 85 °C
Humidity	95 % at 60 °C

## Input Parameters

Condition	Range
Car Charger Voltage	Low: 12 VDC Max: 24 VDC
Charger Current	1.5 RMS max at low line input and DC output at full load
Protection	3A Fuse
EUT Voltage	5V
EUT Current	2.1A

## LEDs and Buttons

Condition	Range
<b>LED Status</b>	1x Dual color LED (Power Button) 1x Red LED (E-Call button) 1x Light Guide (Alexa's Mute)
<b>Buttons</b>	3x Function Keys (Power, E-Call, and Mute)

## Certifications

Description	Certification
Radio Act	NCC (Taiwan), JRF/JPA (Japan), FCC(NA), CE (EU)
Conducted Immunity e/E/CE Mark	CI_ISO7637-2
Conducted Emission e/E/CE Mark	CE_ISO7637-2
Radiated Emission e/E/CE Mark	RE_CISPR25
Safety (on request)	CE-LVD, CB IEC 60950 or 60065 JASO D014 POWER SUPPLY VARIATION TEST
SD card	Self-verification
Carrier Type Approval	For JP: DOCOMO For NA: AT&T
ARIB	STD-T66
Only Test (No Certification)	Wi-Fi Alliance GCF

## Troubleshooting

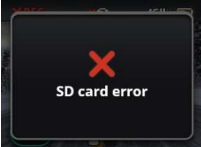
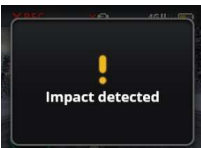
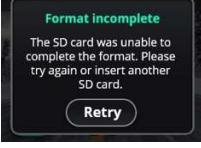
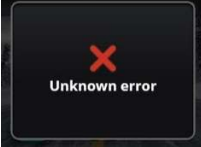
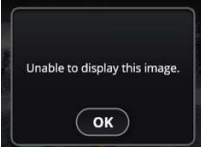
Description	Sample Screen	Rectification
No SD Card		Insert SD card
SD Card Error		Remove SD card
Impact Detected		
Format Incomplete		Retry format again or replace SD card with another SD card
System Unknown Error		Reset the device
Unable to Play Videos		
Unable to View Still Images		



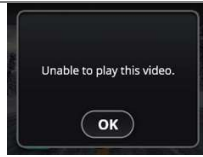

---

Camera Error

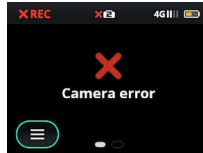



## FCC

### LTE and 3G Frequency Bands

Please make sure the LTE frequency bands with your operator in local before you insert the SIM card into the device.

- Support LTE Band

FCC requirement:

2 (1900 MHz)

4 (1700 MHz)

5 (850 MHz)

12 (700 MHz)

13 (700 MHz)

17 (700 MHz)

26 (850 MHz)

- Peak Downlink/Uplink  
HSPA+ DL: 42Mbps, UL: 5.76Mbps,  
LTE Cat4 DL: 150Mbps, UL: 50Mbps

## Federal Communication Commission Interference Statement

This device complies with Part 15 of the FCC Rules. Operation is subject to the following two conditions: (1) This device may not cause harmful interference, and (2) this device must accept any interference received, including interference that may cause undesired operation.

This equipment has been tested and found to comply with the limits for a Class B digital device, pursuant to Part 15 of the FCC Rules. These limits are designed to provide reasonable protection against harmful interference in a residential installation. This equipment generates, uses and can radiate radio frequency energy and, if not installed and used in accordance with the instructions, may cause harmful interference to radio communications. However, there is no guarantee that interference will not occur in a particular installation. If this equipment does cause harmful interference to radio or television reception, which can be determined by turning the equipment off and on, the user is encouraged to try to correct the interference by one of the following measures:

- Reorient or relocate the receiving antenna.
- Increase the separation between the equipment and receiver.
- Connect the equipment into an outlet on a circuit different from that to which the receiver is connected.
- Consult the dealer or an experienced radio/TV technician for help.



FCC Caution: Any changes or modifications not expressly approved by the party responsible for compliance could void the user's authority to operate this equipment.

This transmitter must not be co-located or operating in conjunction with any other antenna or transmitter.

This device meets all the other requirements specified in Part 15E, Section 15.407 of the FCC Rules.

### **Radiation Exposure Statement:**

This equipment complies with FCC radiation exposure limits set forth for an uncontrolled environment. This equipment should be installed and operated with minimum distance 20cm between the radiator & your body.

Note: The country code selection is for non-US model only and is not available to all US model. Per FCC regulation, all WiFi product marketed in US must fixed to US operation channels only.