

FCC Test Report

Report No.: RF190530C17B-4

FCC ID: H8NCDR8011

Test Model: CDR8010-DBB1

Series Model: CDR8011-DBA1, CDR8011-DDA1, CDR8011-DDB1, CDR8011-SBA1, CDR8011-SBB1, CDR8011-SDA1, CDR8011-SDB1 (refer to item 3.1 for more details)

Received Date: Feb. 25, 2019

Test Date: Apr. 25 ~ Aug. 28, 2019

Issued Date: Sep. 02, 2019

Applicant: ASKEY COMPUTER CORP.

Address: 10F, NO. 119, JIANKANG RD., ZHONGHE DIST., NEW TAIPEI CITY
23585, TAIWAN, R.O.C.

Issued By: Bureau Veritas Consumer Products Services (H.K.) Ltd., Taoyuan Branch
Lin Kou Laboratories

Lab Address: No. 47-2, 14th Ling, Chia Pau Vil., Lin Kou Dist., New Taipei City, Taiwan
(R.O.C.)

Test Location: No. 19, Hwa Ya 2nd Rd., Wen Hwa Vil., Kwei Shan Dist., Taoyuan City
33383, TAIWAN (R.O.C.)

**FCC Registration /
Designation Number:** 788550 / TW0003



This report is for your exclusive use. Any copying or replication of this report to or for any other person or entity, or use of our name or trademark, is permitted only with our prior written permission. This report sets forth our findings solely with respect to the test samples identified herein. The results set forth in this report are not indicative or representative of the quality or characteristics of the lot from which a test sample was taken or any similar or identical product specifically and expressly noted. Our report includes all of the tests requested by you and the results thereof based upon the information that you provided to us. You have 60 days from date of issuance of this report to notify us of any material error or omission caused by our negligence, provided, however, that such notice shall be in writing and shall specifically address the issue you wish to raise. A failure to raise such issue within the prescribed time shall constitute your unqualified acceptance of the completeness of this report, the tests conducted and the correctness of the report contents. Unless specific mention, the uncertainty of measurement has been explicitly taken into account to declare the compliance or non-compliance to the specification. This report should not be used by the client to claim product certification, approval, or endorsement by TAF or any government agencies.

Table of Contents

Release Control Record	4
1 Certificate of Conformity	5
2 Summary of Test Results	6
2.1 Measurement Uncertainty	6
2.2 Modification Record	6
3 General Information	7
3.1 General Description of EUT	7
3.2 Description of Test Modes	8
3.2.1 Test Mode Applicability and Tested Channel Detail	9
3.3 Description of Support Units	10
3.3.1 Configuration of System under Test	10
3.4 General Description of Applied Standards	10
4 Test Types and Results	11
4.1 Radiated Emission and Bandedge Measurement.....	11
4.1.1 Limits of Radiated Emission and Bandedge Measurement	11
4.1.2 Test Instruments	12
4.1.3 Test Procedures.....	13
4.1.4 Deviation from Test Standard	13
4.1.5 Test Setup.....	14
4.1.6 EUT Operating Conditions.....	15
4.1.7 Test Results	16
4.2 6dB Bandwidth Measurement.....	21
4.2.1 Limits of 6dB Bandwidth Measurement.....	21
4.2.2 Test Setup.....	21
4.2.3 Test Instruments	21
4.2.4 Test Procedure	21
4.2.5 Deviation from Test Standard	21
4.2.6 EUT Operating Conditions.....	21
4.2.7 Test Result.....	22
4.3 Conducted Output Power Measurement.....	23
4.3.1 Limits of Conducted Output Power Measurement	23
4.3.2 Test Setup.....	23
4.3.3 Test Instruments	23
4.3.4 Test Procedures.....	23
4.3.5 Deviation from Test Standard	23
4.3.6 EUT Operating Conditions.....	23
4.3.7 Test Results	23
4.4 Power Spectral Density Measurement.....	24
4.4.1 Limits of Power Spectral Density Measurement.....	24
4.4.2 Test Setup.....	24
4.4.3 Test Instruments	24
4.4.4 Test Procedure	24
4.4.5 Deviation from Test Standard	24
4.4.6 EUT Operating Condition	24
4.4.7 Test Results	25
4.5 Conducted Out of Band Emission Measurement.....	26
4.5.1 Limits of Conducted Out of Band Emission Measurement.....	26
4.5.2 Test Setup.....	26
4.5.3 Test Instruments	26
4.5.4 Test Procedure	26
4.5.5 Deviation from Test Standard	26
4.5.6 EUT Operating Condition	26

4.5.7 Test Results	26
5 Pictures of Test Arrangements.....	28
Appendix – Information of the Testing Laboratories	29

Release Control Record

Issue No.	Description	Date Issued
RF190530C17B-4	Original release.	Sep. 02, 2019

1 Certificate of Conformity

Product: iDVR800

Brand: ASKEY

Test Model: CDR8010-DBB1

Series Model: CDR8011-DBA1, CDR8011-DDA1, CDR8011-DDB1, CDR8011-SBA1, CDR8011-SBB1, CDR8011-SDA1, CDR8011-SDB1 (refer to item 3.1 for more details)

Sample Status: Engineering sample

Applicant: ASKEY COMPUTER CORP.

Test Date: Apr. 25 ~ Aug. 28, 2019

Standards: 47 CFR FCC Part 15, Subpart C (Section 15.247)
ANSI C63.10:2013

The above equipment has been tested by **Bureau Veritas Consumer Products Services (H.K.) Ltd., Taoyuan Branch**, and found compliance with the requirement of the above standards. The test record, data evaluation & Equipment Under Test (EUT) configurations represented herein are true and accurate accounts of the measurements of the sample's RF characteristics under the conditions specified in this report.

Prepared by : Pettie Chen , **Date:** Sep. 02, 2019
Pettie Chen / Senior Specialist

Approved by : Bruce Chen , **Date:** Sep. 02, 2019
Bruce Chen / Project Engineer

2 Summary of Test Results

47 CFR FCC Part 15, Subpart C (Section 15.247)			
FCC Clause	Test Item	Result	Remarks
15.207	AC Power Conducted Emission	NA	EUT is powered from DC
15.205 / 15.209 / 15.247(d)	Radiated Emissions and Band Edge Measurement	Pass	Meet the requirement of limit. Minimum passing margin is -7.6dB at 30.00MHz.
15.247(d)	Antenna Port Emission	Pass	Meet the requirement of limit.
15.247(a)(2)	6dB bandwidth	Pass	Meet the requirement of limit.
15.247(b)	Conducted power	Pass	Meet the requirement of limit.
15.247(e)	Power Spectral Density	Pass	Meet the requirement of limit.
15.203	Antenna Requirement	Pass	Antenna connector is I-PEX not a standard connector.

Note: Determining compliance based on the results of the compliance measurement, not taking into account measurement instrumentation uncertainty.

2.1 Measurement Uncertainty

Where relevant, the following measurement uncertainty levels have been estimated for tests performed on the EUT as specified in CISPR 16-4-2:

Measurement	Frequency	Expanded Uncertainty (k=2) (\pm)
Radiated Emissions up to 1 GHz	9kHz ~ 30MHz	3.04 dB
	30MHz ~ 200MHz	3.59 dB
	200MHz ~ 1000MHz	3.60 dB
Radiated Emissions above 1 GHz	1GHz ~ 18GHz	2.29 dB
	18GHz ~ 40GHz	2.29 dB

2.2 Modification Record

There were no modifications required for compliance.

3 General Information

3.1 General Description of EUT

Product	iDVR800
Brand	ASKEY
Test Model	CDR8010-DBB1
Series Model	CDR8011-DBA1, CDR8011-DDA1, CDR8011-DDB1, CDR8011-SBA1, CDR8011-SBB1, CDR8011-SDA1, CDR8011-SDB1
Model Difference	Refer to Note
Sample Status	Engineering sample
Nominal Voltage	12Vdc / 24Vdc (Car Charger) 3.7Vdc (Battery)
Modulation Type	GFSK
Transfer Rate	1Mbps
Operating Frequency	2402~2480MHz
Number of Channel	40
Channel Spacing	2MHz
Output Power	2.275mW
Antenna Type	Refer to Note
Antenna Connector	Refer to Note
Accessory Device	Car charger, SD Card
Cable Supplied	NA

Note:

1. All models are listed as below. Model CDR8010-DBB1 is the representative for final test.

Model	PCB	Camera	NFC	Fan	eSIM	RAM
CDR8010-DBB1	Same PCB	Dual	Yes	Yes	N/A	3GB
CDR8011-DBA1			Yes	Yes		N/A
CDR8011-DDA1			Yes	No		N/A
CDR8011-DDB1			Yes	No		3GB
CDR8011-SBA1		Single	Yes	Yes		N/A
CDR8011-SBB1			Yes	Yes		3GB
CDR8011-SDA1			Yes	No		N/A
CDR8011-SDB1			Yes	No		3GB

2. The following antennas were provided to the EUT.

Antenna Type	PIFA					
Connector Type	I-PEX					
Brand	WHAYU					
Model	C407-510916-A					
Antenna gain (dBi)						
2400MHz	2450MHz	2500MHz	5150MHz	5350MHz	5725MHz	5825MHz
1.32	-0.68	-0.46	3.39	-0.04	3.44	2.40

3. The EUT is powered by the following car charger and battery.

Car charger	
Brand	Sunny
Model	SYD1202-1005
Input Power	12Vdc / 24Vdc, 1.5A
Output Power	5Vdc, 2.1A
Power Line	5.1m cable with USB Type C connector

Battery	
Brand	FUJI ELECTRONICS(SHENZHEN)CO., LTD
Model	ICP463048XS
Rating	3.7Vdc, 750mA

4. Spurious emission of the simultaneous operation (WWAN+WLAN 2.4GHz, WWAN+WLAN 5.0GHz, WWAN+BT) have been evaluated and no non-compliance was found.

3.2 Description of Test Modes

40 channels are provided to this EUT:

Channel	Freq. (MHz)	Channel	Freq. (MHz)	Channel	Freq. (MHz)	Channel	Freq. (MHz)
0	2402	10	2422	20	2442	30	2462
1	2404	11	2424	21	2444	31	2464
2	2406	12	2426	22	2446	32	2466
3	2408	13	2428	23	2448	33	2468
4	2410	14	2430	24	2450	34	2470
5	2412	15	2432	25	2452	35	2472
6	2414	16	2434	26	2454	36	2474
7	2416	17	2436	27	2456	37	2476
8	2418	18	2438	28	2458	38	2478
9	2420	19	2440	29	2460	39	2480

3.2.1 Test Mode Applicability and Tested Channel Detail

EUT Configure Mode	Applicable to				Description
	RE \geq 1G	RE<1G	PLC	APCM	
-	√	√	Note 2	√	-

Where RE \geq 1G: Radiated Emission above 1GHz & Bandedge Measurement
 RE<1G: Radiated Emission below 1GHz
 PLC: Power Line Conducted Emission
 APCM: Antenna Port Conducted Measurement

Note:

1. The EUT had been pre-tested on the positioned of each 3 axis. The worst case was found when positioned on Z-plane.
2. No need to concern of PLC due to the EUT is powered from DC.

Radiated Emission Test (Above 1GHz):

- Pre-Scan has been conducted to determine the worst-case mode from all possible combinations between available modulations, data rates and antenna ports (if EUT with antenna diversity architecture).
- Following channel(s) was (were) selected for the final test as listed below.

EUT Configure Mode	Available Channel	Tested Channel	Modulation Technology	Data Rate (Mbps)
-	0 to 39	0, 19, 39	GFSK	1

Radiated Emission Test (Below 1GHz):

- Pre-Scan has been conducted to determine the worst-case mode from all possible combinations between available modulations, data rates and antenna ports (if EUT with antenna diversity architecture).
- Following channel(s) was (were) selected for the final test as listed below.

EUT Configure Mode	Available Channel	Tested Channel	Modulation Technology	Data Rate (Mbps)
-	0 to 39	39	GFSK	1

Antenna Port Conducted Measurement:

- This item includes all test value of each mode, but only includes spectrum plot of worst value of each mode.
- Pre-Scan has been conducted to determine the worst-case mode from all possible combinations between available modulations, data rates and antenna ports (if EUT with antenna diversity architecture).
- Following channel(s) was (were) selected for the final test as listed below.

EUT Configure Mode	Available Channel	Tested Channel	Modulation Technology	Data Rate (Mbps)
-	0 to 39	0, 19, 39	GFSK	1

Test Condition:

Applicable to	Environmental Conditions	Input Power	Tested by
RE \geq 1G	22 deg. C, 68% RH	3.7Vdc	Greg Lin
RE<1G	22 deg. C, 68% RH	3.7Vdc	Greg Lin
APCM	25 deg. C, 60% RH	3.7Vdc	Frank Liu

3.3 Description of Support Units

The EUT has been tested as an independent unit together with other necessary accessories or support units. The following support units or accessories were used to form a representative test configuration during the tests.

ID	Product	Brand	Model No.	Serial No.	FCC ID	Remarks
A.	Car Charger	Sunny	SYD1202-1005	NA	NA	Accessory of EUT
B.	Battery	YUASA	ST-CLN126-6S	NA	NA	-

Note:

1. All power cords of the above support units are non-shielded (1.8m).

ID	Descriptions	Qty.	Length (m)	Shielding (Yes/No)	Cores (Qty.)	Remarks
1.	Type C to car charger	1	5.1	N	0	Accessory of EUT
2.	DC cable	1	1	N	0	-

3.3.1 Configuration of System under Test

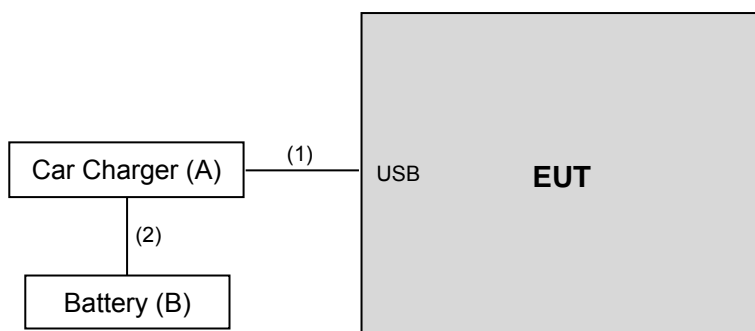

3.4 General Description of Applied Standards

The EUT is a RF Product. According to the specifications of the manufacturer, it must comply with the requirements of the following standards:

FCC Part 15, Subpart C (15.247)
KDB 558074 D01 15.247 Meas Guidance v05r02
 ANSI C63.10-2013

All test items have been performed and recorded as per the above standards.

4 Test Types and Results

4.1 Radiated Emission and Bandedge Measurement

4.1.1 Limits of Radiated Emission and Bandedge Measurement

Radiated emissions which fall in the restricted bands must comply with the radiated emission limits specified as below table. Other emissions shall be at least 20dB below the highest level of the desired power:

Frequencies (MHz)	Field Strength (microvolts/meter)	Measurement Distance (meters)
0.009 ~ 0.490	2400/F(kHz)	300
0.490 ~ 1.705	24000/F(kHz)	30
1.705 ~ 30.0	30	30
30 ~ 88	100	3
88 ~ 216	150	3
216 ~ 960	200	3
Above 960	500	3

Note:

1. The lower limit shall apply at the transition frequencies.
2. Emission level (dBuV/m) = 20 log Emission level (uV/m).
3. For frequencies above 1000MHz, the field strength limits are based on average detector, however, the peak field strength of any emission shall not exceed the maximum permitted average limits, specified above by more than 20dB under any condition of modulation.

4.1.2 Test Instruments

Description & Manufacturer	Model No.	Serial No.	Cal. Date	Cal. Due
Test Receiver ROHDE & SCHWARZ	ESCI	100424	Jan. 03, 2019	Jan. 02, 2020
Spectrum Analyzer ROHDE & SCHWARZ	FSP40	100040	Sep. 25, 2018	Sep. 24, 2019
BILOG Antenna SCHWARZBECK	VULB9168	9168-160	Nov. 21, 2018	Nov. 20, 2019
HORN Antenna SCHWARZBECK	BBHA 9120 D	9120D-1169	Nov. 25, 2018	Nov. 24, 2019
HORN Antenna SCHWARZBECK	BBHA 9170	BBHA9170241	Nov. 25, 2018	Nov. 24, 2019
Loop Antenna TESEQ	HLA 6121	45745	Jun. 14, 2018	Jun. 13, 2019
			Jul. 01, 2019	Jun. 30, 2020
Preamplifier Agilent (Below 1GHz)	8447D	2944A10638	Aug. 08, 2018	Aug. 07, 2019
			Jul. 11, 2019	Jul. 10, 2020
Preamplifier Agilent (Above 1GHz)	8449B	3008A02367	Feb. 19, 2019	Feb. 18, 2020
RF signal cable HUBER+SUHNER&EMCI	SUCOFLEX 104 & EMC104-SM-SM8000	CABLE-CH9-02 (248780+171006)	Jan. 19, 2019	Jan. 18, 2020
RF signal cable HUBER+SUHNER	SUCOFLEX 104	CABLE-CH9-(250795/4)	Aug. 08, 2018	Aug. 07, 2019
			Jul. 11, 2019	Jul. 10, 2020
RF signal cable Woken	8D-FB	Cable-CH9-01	Jul. 31, 2018	Jul. 30, 2019
			Jul. 30, 2019	Jul. 29, 2020
Software BV ADT	ADT_Radiated_ V7.6.15.9.5	NA	NA	NA
Antenna Tower EMCO	2070/2080	512.835.4684	NA	NA
Turn Table EMCO	2087-2.03	NA	NA	NA
Antenna Tower & Turn BV ADT	AT100	AT93021705	NA	NA
Turn Table BV ADT	TT100	TT93021705	NA	NA
Turn Table Controller BV ADT	SC100	SC93021705	NA	NA
Boresight Antenna Fixture	FBA-01	FBA-SIP01	NA	NA
USB Wideband Power Sensor KEYSIGHT	U2021XA	MY55050005/MY551900 04/MY55190007/MY5521 0005	Jul. 17, 2018	Jul. 16, 2019
			Jul. 15, 2019	Jul. 14, 2020

Note: 1. The calibration interval of the above test instruments is 12 months and the calibrations are traceable to NML/ROC and NIST/USA.
2. The test was performed in HwaYa Chamber 9.

4.1.3 Test Procedures

For Radiated emission below 30MHz

- a. The EUT was placed on the top of a rotating table 0.8 meters above the ground at a 3 meter chamber room. The table was rotated 360 degrees to determine the position of the highest radiation.
- b. The EUT was set 3 meters away from the interference-receiving antenna, which was mounted on the top of a variable-height antenna tower.
- c. Parallel, perpendicular, and ground-parallel orientations of the antenna are set to make the measurement.
- d. For each suspected emission, the EUT was arranged to its worst case and the rotatable table was turned from 0 degrees to 360 degrees to find the maximum reading.
- e. The test-receiver system was set to Quasi-Peak Detect Function and Specified Bandwidth with Maximum Hold Mode.

Note:

1. The resolution bandwidth and video bandwidth of test receiver/spectrum analyzer is 9kHz at frequency below 30MHz.

For Radiated emission above 30MHz

- a. The EUT was placed on the top of a rotating table 0.8 meters (for 30MHz ~ 1GHz) / 1.5 meters (for above 1GHz) above the ground at 3 meter chamber room for test. The table was rotated 360 degrees to determine the position of the highest radiation.
- b. The EUT was set 3 meters away from the interference-receiving antenna, which was mounted on the top of a variable-height antenna tower.
- c. The height of antenna is varied from one meter to four meters above the ground to determine the maximum value of the field strength. Both horizontal and vertical polarizations of the antenna are set to make the measurement.
- d. For each suspected emission, the EUT was arranged to its worst case and then the antenna was tuned to heights from 1 meter to 4 meters and the rotatable table was turned from 0 degrees to 360 degrees to find the maximum reading.
- e. The test-receiver system was set to quasi-peak detect function and specified bandwidth with maximum hold mode when the test frequency is below 1 GHz.
- f. The test-receiver system was set to peak and average detect function and specified bandwidth with maximum hold mode when the test frequency is above 1 GHz. If the peak reading value also meets average limit, measurement with the average detector is unnecessary.

Note:

1. The resolution bandwidth and video bandwidth of test receiver/spectrum analyzer is 120kHz for Quasi-peak detection (QP) at frequency below 1GHz.
2. The resolution bandwidth of test receiver/spectrum analyzer is 1 MHz and the video bandwidth is 3 MHz for Peak detection (PK) at frequency above 1GHz.
3. The resolution bandwidth of test receiver/spectrum analyzer is 1 MHz and the video bandwidth is $\geq 1/T$ (Duty cycle < 98%) or 3 x RBW (Duty cycle $\geq 98\%$) for Average detection (AV) at frequency above 1GHz.
4. All modes of operation were investigated and the worst-case emissions are reported.

4.1.4 Deviation from Test Standard

No deviation.

4.1.5 Test Setup

For Radiated emission below 30MHz

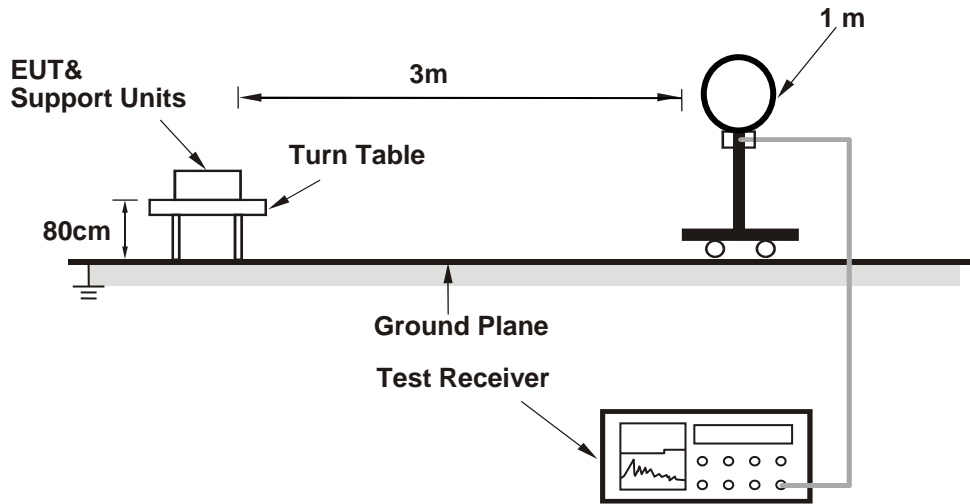

For Radiated emission 30MHz to 1GHz

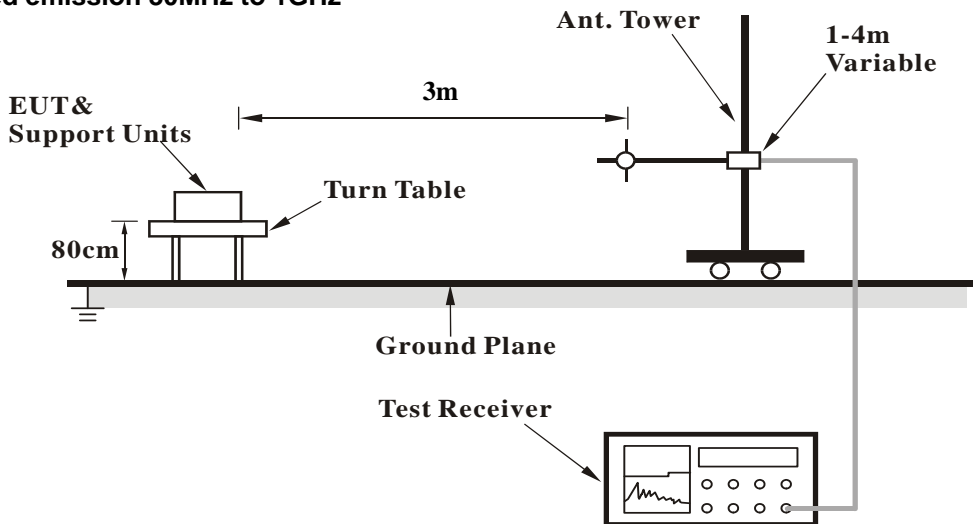

For Radiated emission above 1GHz

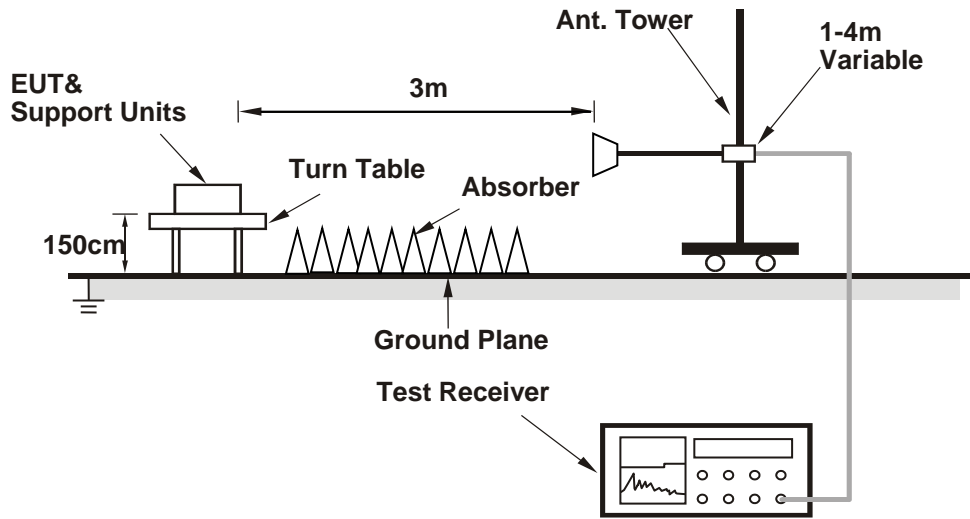

For the actual test configuration, please refer to the attached file (Test Setup Photo).

4.1.6 EUT Operating Conditions

- a. Set the EUT under transmission condition continuously at specific channel frequency.

4.1.7 Test Results

Above 1GHz Data:

CHANNEL	TX Channel 0	DETECTOR FUNCTION	Peak (PK)
FREQUENCY RANGE	1GHz ~ 25GHz		Average (AV)

ANTENNA POLARITY & TEST DISTANCE: HORIZONTAL AT 3 M								
NO.	FREQ. (MHz)	EMISSION LEVEL (dBuV/m)	LIMIT (dBuV/m)	MARGIN (dB)	ANTENNA HEIGHT (m)	TABLE ANGLE (Degree)	RAW VALUE (dBuV)	CORRECTION FACTOR (dB/m)
1	2390.00	56.6 PK	74.0	-17.4	2.17 H	237	24.8	31.8
2	2390.00	44.4 AV	54.0	-9.6	2.17 H	237	12.6	31.8
3	*2402.00	97.1 PK			2.25 H	230	65.3	31.8
4	*2402.00	92.5 AV			2.25 H	230	60.7	31.8
5	4804.00	45.0 PK	74.0	-29.0	2.83 H	134	41.3	3.7
6	4804.00	31.7 AV	54.0	-22.3	2.83 H	134	28.0	3.7
ANTENNA POLARITY & TEST DISTANCE: VERTICAL AT 3 M								
NO.	FREQ. (MHz)	EMISSION LEVEL (dBuV/m)	LIMIT (dBuV/m)	MARGIN (dB)	ANTENNA HEIGHT (m)	TABLE ANGLE (Degree)	RAW VALUE (dBuV)	CORRECTION FACTOR (dB/m)
1	2390.00	56.4 PK	74.0	-17.6	1.03 V	216	24.6	31.8
2	2390.00	44.4 AV	54.0	-9.6	1.03 V	216	12.6	31.8
3	*2402.00	92.0 PK			1.00 V	211	60.2	31.8
4	*2402.00	87.1 AV			1.00 V	211	55.3	31.8
5	4804.00	44.2 PK	74.0	-29.8	1.53 V	239	40.5	3.7
6	4804.00	31.1 AV	54.0	-22.9	1.53 V	239	27.4	3.7

Remarks:

1. Emission Level(dBuV/m) = Raw Value(dBuV) + Correction Factor(dB/m)
2. Correction Factor(dB/m) = Antenna Factor(dB/m) + Cable Factor(dB) – Pre-Amplifier Factor(dB)
3. The other emission levels were very low against the limit.
4. Margin value = Emission Level – Limit value
5. " * ": Fundamental frequency.

CHANNEL	TX Channel 19	DETECTOR FUNCTION	Peak (PK)
FREQUENCY RANGE	1GHz ~ 25GHz		Average (AV)

ANTENNA POLARITY & TEST DISTANCE: HORIZONTAL AT 3 M

NO.	FREQ. (MHz)	EMISSION LEVEL (dBuV/m)	LIMIT (dBuV/m)	MARGIN (dB)	ANTENNA HEIGHT (m)	TABLE ANGLE (Degree)	RAW VALUE (dBuV)	CORRECTION FACTOR (dB/m)
1	*2440.00	97.0 PK			2.49 H	228	65.2	31.8
2	*2440.00	92.1 AV			2.49 H	228	60.3	31.8
3	4880.00	45.1 PK	74.0	-28.9	2.81 H	136	41.6	3.5
4	4880.00	31.7 AV	54.0	-22.3	2.81 H	136	28.2	3.5

ANTENNA POLARITY & TEST DISTANCE: VERTICAL AT 3 M

NO.	FREQ. (MHz)	EMISSION LEVEL (dBuV/m)	LIMIT (dBuV/m)	MARGIN (dB)	ANTENNA HEIGHT (m)	TABLE ANGLE (Degree)	RAW VALUE (dBuV)	CORRECTION FACTOR (dB/m)
1	*2440.00	91.8 PK			1.03 V	206	60.0	31.8
2	*2440.00	87.0 AV			1.03 V	206	55.2	31.8
3	4880.00	44.2 PK	74.0	-29.8	1.62 V	247	40.7	3.5
4	4880.00	30.8 AV	54.0	-23.2	1.62 V	247	27.3	3.5

Remarks:

1. Emission Level(dBuV/m) = Raw Value(dBuV) + Correction Factor(dB/m)
2. Correction Factor(dB/m) = Antenna Factor(dB/m) + Cable Factor(dB) – Pre-Amplifier Factor(dB)
3. The other emission levels were very low against the limit.
4. Margin value = Emission Level – Limit value
5. " * ": Fundamental frequency.

CHANNEL	TX Channel 39	DETECTOR FUNCTION	Peak (PK)
FREQUENCY RANGE	1GHz ~ 25GHz		Average (AV)

ANTENNA POLARITY & TEST DISTANCE: HORIZONTAL AT 3 M

NO.	FREQ. (MHz)	EMISSION LEVEL (dBuV/m)	LIMIT (dBuV/m)	MARGIN (dB)	ANTENNA HEIGHT (m)	TABLE ANGLE (Degree)	RAW VALUE (dBuV)	CORRECTION FACTOR (dB/m)
1	*2480.00	96.5 PK			2.75 H	225	64.7	31.8
2	*2480.00	91.8 AV			2.75 H	225	60.0	31.8
3	2483.50	56.5 PK	74.0	-17.5	2.64 H	217	24.7	31.8
4	2483.50	44.7 AV	54.0	-9.3	2.64 H	217	12.9	31.8
5	4960.00	45.5 PK	74.0	-28.5	2.76 H	143	41.7	3.8
6	4960.00	32.1 AV	54.0	-21.9	2.76 H	143	28.3	3.8

ANTENNA POLARITY & TEST DISTANCE: VERTICAL AT 3 M

NO.	FREQ. (MHz)	EMISSION LEVEL (dBuV/m)	LIMIT (dBuV/m)	MARGIN (dB)	ANTENNA HEIGHT (m)	TABLE ANGLE (Degree)	RAW VALUE (dBuV)	CORRECTION FACTOR (dB/m)
1	*2480.00	91.4 PK			1.04 V	207	59.6	31.8
2	*2480.00	86.7 AV			1.04 V	207	54.9	31.8
3	2483.50	56.1 PK	74.0	-17.9	1.07 V	213	24.3	31.8
4	2483.50	44.2 AV	54.0	-9.8	1.07 V	213	12.4	31.8
5	4960.00	44.6 PK	74.0	-29.4	1.62 V	243	40.8	3.8
6	4960.00	31.3 AV	54.0	-22.7	1.62 V	243	27.5	3.8

Remarks:

1. Emission Level(dBuV/m) = Raw Value(dBuV) + Correction Factor(dB/m)
2. Correction Factor(dB/m) = Antenna Factor(dB/m) + Cable Factor(dB) – Pre-Amplifier Factor(dB)
3. The other emission levels were very low against the limit.
4. Margin value = Emission Level – Limit value
5. " * ": Fundamental frequency.

Below 1GHz worst-case data:

CHANNEL	TX Channel 39	DETECTOR FUNCTION	Quasi-Peak (QP)
FREQUENCY RANGE	9kHz ~ 1GHz		

ANTENNA POLARITY & TEST DISTANCE: HORIZONTAL AT 3 M								
NO.	FREQ. (MHz)	EMISSION LEVEL (dBuV/m)	LIMIT (dBuV/m)	MARGIN (dB)	ANTENNA HEIGHT (m)	TABLE ANGLE (Degree)	RAW VALUE (dBuV)	CORRECTION FACTOR (dB/m)
1	30.00	27.3 QP	40.0	-12.7	1.00 H	355	38.7	-11.4
2	155.13	18.8 QP	43.5	-24.7	1.25 H	17	28.0	-9.2
3	450.01	28.1 QP	46.0	-17.9	1.00 H	96	32.6	-4.5
4	591.63	27.9 QP	46.0	-18.1	1.50 H	54	30.1	-2.2
5	818.61	31.8 QP	46.0	-14.2	1.25 H	131	30.1	1.7
6	916.58	33.2 QP	46.0	-12.8	1.00 H	18	29.5	3.7

Remarks:

1. Emission Level(dBuV/m) = Raw Value(dBuV) + Correction Factor(dB/m)
2. Correction Factor(dB/m) = Antenna Factor(dB/m) + Cable Factor(dB) – Pre-Amplifier Factor(dB)
3. Margin value = Emission Level – Limit value
4. The other emission levels were very low against the limit of frequency range 30MHz~1000MHz.
5. The emission levels were very low against the limit of frequency range 9kHz~30MHz: the amplitude of spurious emissions attenuated more than 20 dB below the permissible value to be report.

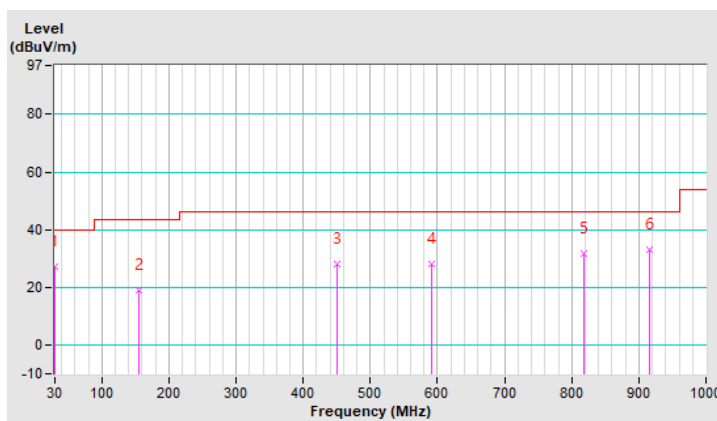

CHANNEL	TX Channel 39	DETECTOR FUNCTION	Quasi-Peak (QP)
FREQUENCY RANGE	9kHz ~ 1GHz		

ANTENNA POLARITY & TEST DISTANCE: VERTICAL AT 3 M								
NO.	FREQ. (MHz)	EMISSION LEVEL (dBuV/m)	LIMIT (dBuV/m)	MARGIN (dB)	ANTENNA HEIGHT (m)	TABLE ANGLE (Degree)	RAW VALUE (dBuV)	CORRECTION FACTOR (dB/m)
1	30.00	32.4 QP	40.0	-7.6	1.50 V	61	43.8	-11.4
2	58.13	27.2 QP	40.0	-12.8	1.00 V	184	37.6	-10.4
3	135.73	24.9 QP	43.5	-18.6	1.25 V	133	35.2	-10.3
4	520.82	26.0 QP	46.0	-20.0	1.25 V	35	29.4	-3.4
5	729.37	35.0 QP	46.0	-11.0	1.00 V	70	35.0	0.0
6	935.98	33.4 QP	46.0	-12.6	1.50 V	338	29.5	3.9

Remarks:

1. Emission Level(dBuV/m) = Raw Value(dBuV) + Correction Factor(dB/m)
2. Correction Factor(dB/m) = Antenna Factor(dB/m) + Cable Factor(dB) – Pre-Amplifier Factor(dB)
3. Margin value = Emission Level – Limit value
4. The other emission levels were very low against the limit of frequency range 30MHz~1000MHz.
5. The emission levels were very low against the limit of frequency range 9kHz~30MHz: the amplitude of spurious emissions attenuated more than 20 dB below the permissible value to be report.

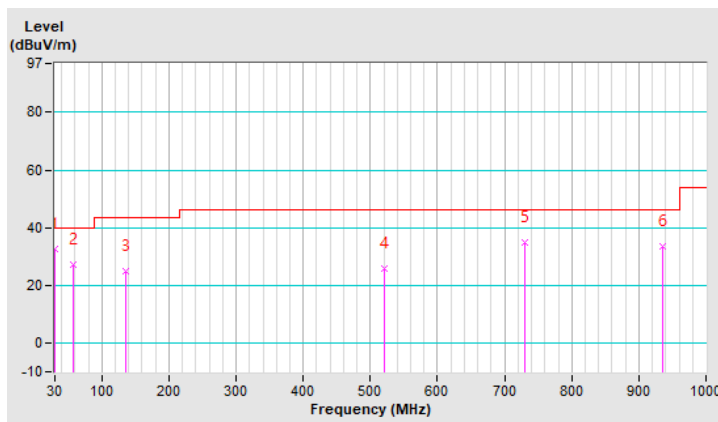

4.2 6dB Bandwidth Measurement

4.2.1 Limits of 6dB Bandwidth Measurement

The minimum of 6dB Bandwidth Measurement is 0.5 MHz.

4.2.2 Test Setup

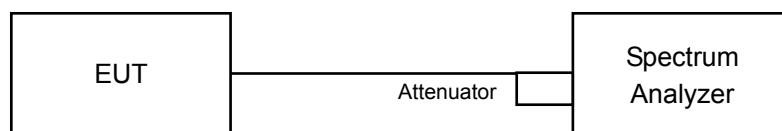

4.2.3 Test Instruments

Refer to section 4.1.2 to get information of above instrument.

4.2.4 Test Procedure

- Set resolution bandwidth (RBW) = 100kHz.
- Set the video bandwidth (VBW) $\geq 3 \times$ RBW, Detector = Peak.
- Trace mode = max hold.
- Sweep = auto couple.
- Measure the maximum width of the emission that is constrained by the frequencies associated with the two amplitude points (upper and lower) that are attenuated by 6 dB relative to the maximum level measured in the fundamental emission.

4.2.5 Deviation from Test Standard

No deviation.

4.2.6 EUT Operating Conditions

The software provided by client to enable the EUT under transmission condition continuously at lowest, middle and highest channel frequencies individually.

4.2.7 Test Result

Channel	Frequency (MHz)	6dB Bandwidth (MHz)	Minimum Limit (MHz)	Pass / Fail
0	2402	0.68	0.5	Pass
19	2440	0.67	0.5	Pass
39	2480	0.67	0.5	Pass

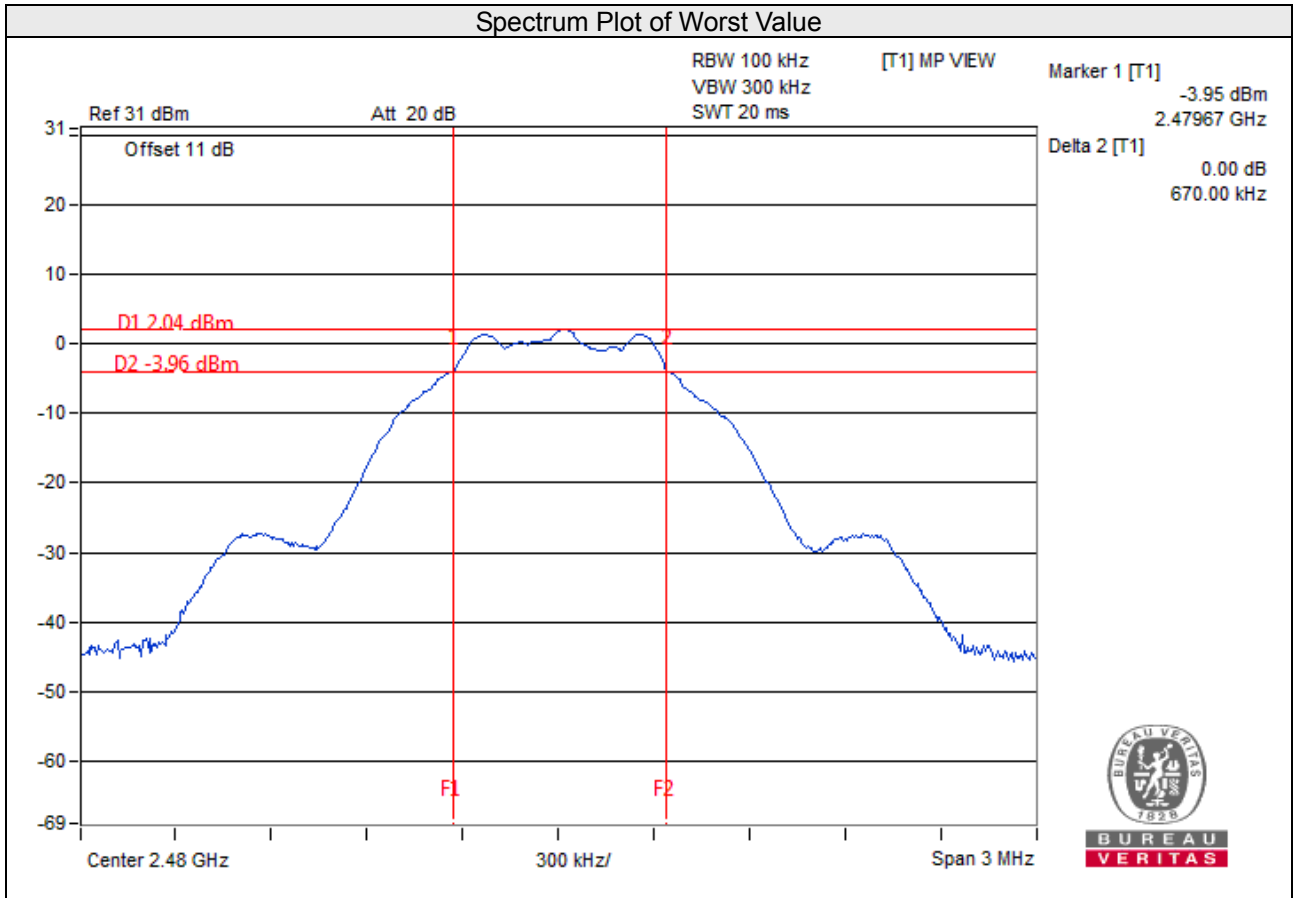

4.3 Conducted Output Power Measurement

4.3.1 Limits of Conducted Output Power Measurement

For systems using digital modulation in the 2400–2483.5 MHz bands: 1 Watt (30dBm)

4.3.2 Test Setup

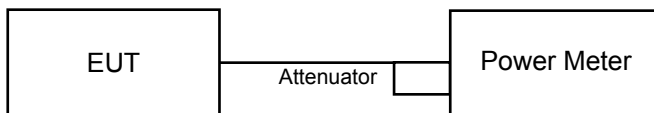

4.3.3 Test Instruments

Refer to section 4.1.2 to get information of above instrument.

4.3.4 Test Procedures

For Peak Power

A peak power sensor was used on the output port of the EUT. A power meter was used to read the response of the peak power sensor. Record the power level.

4.3.5 Deviation from Test Standard

No deviation.

4.3.6 EUT Operating Conditions

Same as item 4.3.6.

4.3.7 Test Results

For Peak Power

Channel	Frequency (MHz)	Peak Power (mW)	Peak Power (dBm)	Limit (dBm)	Pass/Fail
0	2402	1.578	1.98	30	Pass
19	2440	2.275	3.57	30	Pass
39	2480	1.706	2.32	30	Pass

For Average Power

Channel	Frequency (MHz)	Average Power (mW)	Average Power (dBm)
0	2402	1.403	1.47
19	2440	2.070	3.16
39	2480	1.432	1.56

4.4 Power Spectral Density Measurement

4.4.1 Limits of Power Spectral Density Measurement

The Maximum of Power Spectral Density Measurement is 8dBm/3kHz.

4.4.2 Test Setup

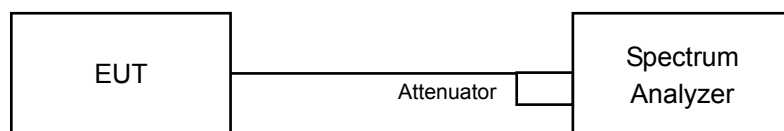

4.4.3 Test Instruments

Refer to section 4.1.2 to get information of above instrument.

4.4.4 Test Procedure

- Set analyzer center frequency to DTS channel center frequency.
- Set the span to 1.5 times the DTS bandwidth.
- Set the RBW to: $3 \text{ kHz} \leq \text{RBW} \leq 100 \text{ kHz}$.
- Set the VBW $\geq 3 \times \text{RBW}$.
- Detector = peak.
- Sweep time = auto couple.
- Trace mode = max hold.
- Allow trace to fully stabilize.
- Use the peak marker function to determine the maximum amplitude level within the RBW.

4.4.5 Deviation from Test Standard

No deviation.

4.4.6 EUT Operating Condition

Same as item 4.3.6

4.4.7 Test Results

Channel	Freq. (MHz)	PSD (dBm/3kHz)	Limit (dBm/3kHz)	Pass / Fail
0	2402	-14.09	8	Pass
19	2440	-12.69	8	Pass
39	2480	-13.43	8	Pass

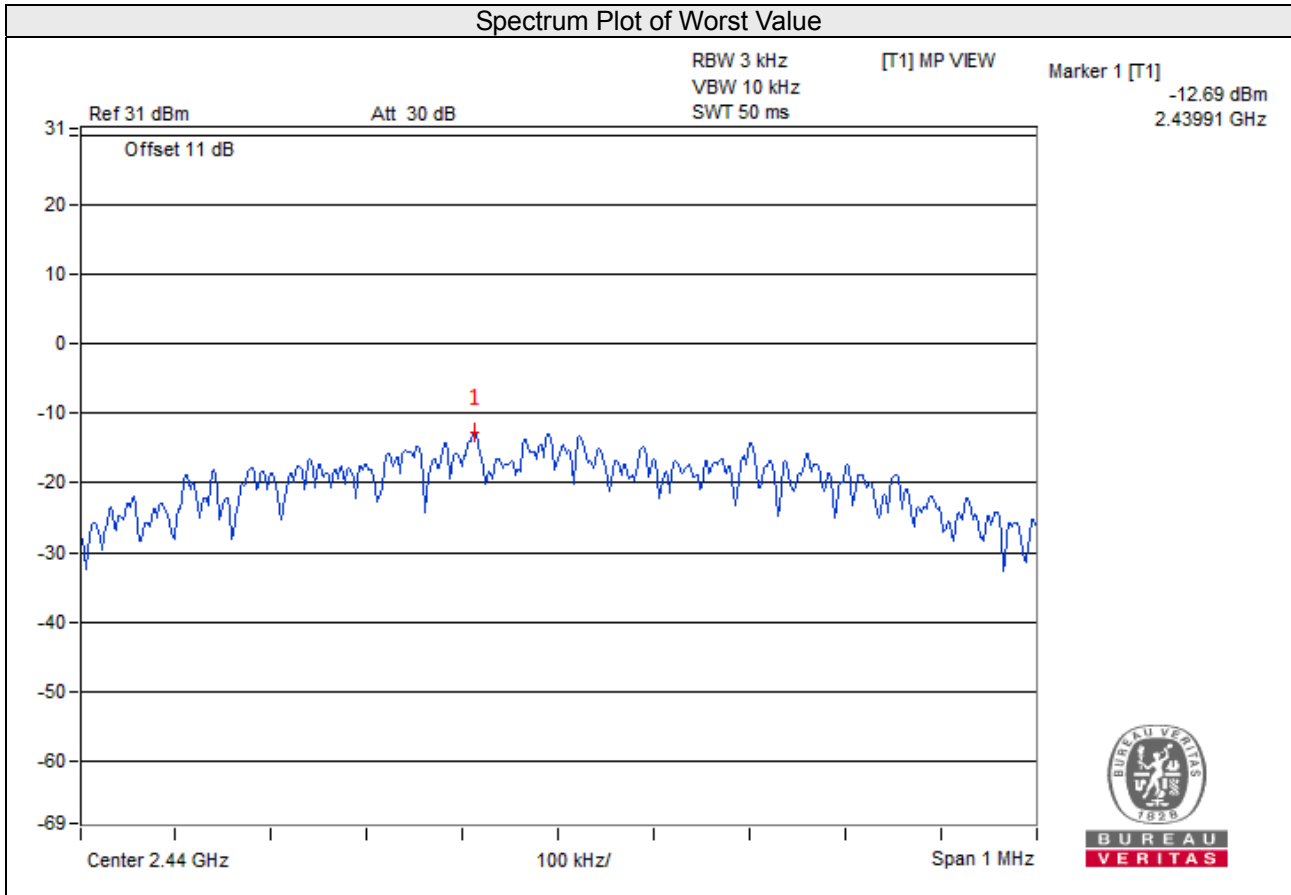

4.5 Conducted Out of Band Emission Measurement

4.5.1 Limits of Conducted Out of Band Emission Measurement

Below -20dB of the highest emission level of operating band (in 100kHz Resolution Bandwidth).

4.5.2 Test Setup

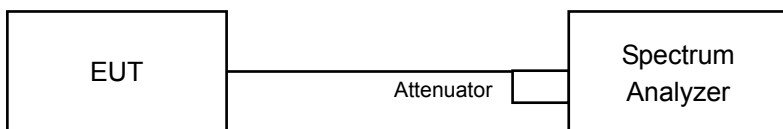

4.5.3 Test Instruments

Refer to section 4.1.2 to get information of above instrument.

4.5.4 Test Procedure

Measurement Procedure REF

- Set the RBW = 100 kHz.
- Set the VBW \geq 300 kHz.
- Detector = peak.
- Sweep time = auto couple.
- Trace mode = max hold.
- Allow trace to fully stabilize.
- Use the peak marker function to determine the maximum power level in any 100 kHz band segment within the fundamental EBW.

Measurement Procedure OOB

- Set RBW = 100 kHz.
- Set VBW \geq 300 kHz.
- Detector = peak.
- Sweep = auto couple.
- Trace Mode = max hold.
- Allow trace to fully stabilize.
- Use the peak marker function to determine the maximum amplitude level.

4.5.5 Deviation from Test Standard

No deviation.

4.5.6 EUT Operating Condition

Same as item 4.3.6

4.5.7 Test Results

The spectrum plots are attached on the following pages. D1 line indicates the highest level, and D2 line indicates the 20dB offset below D1. It shows compliance with the requirement.

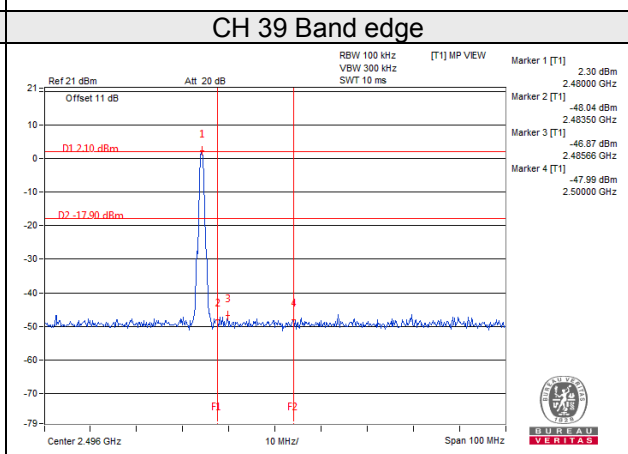
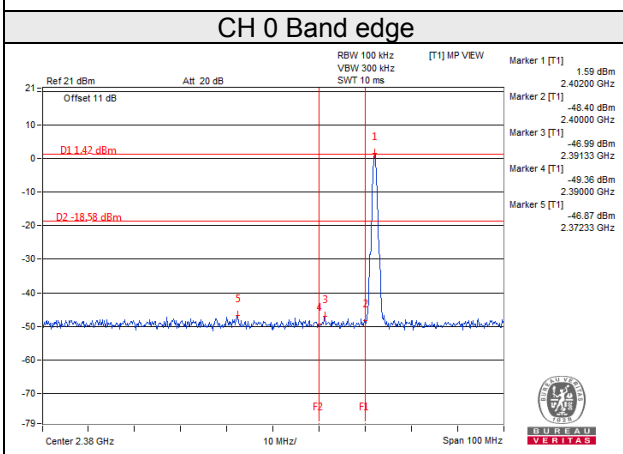
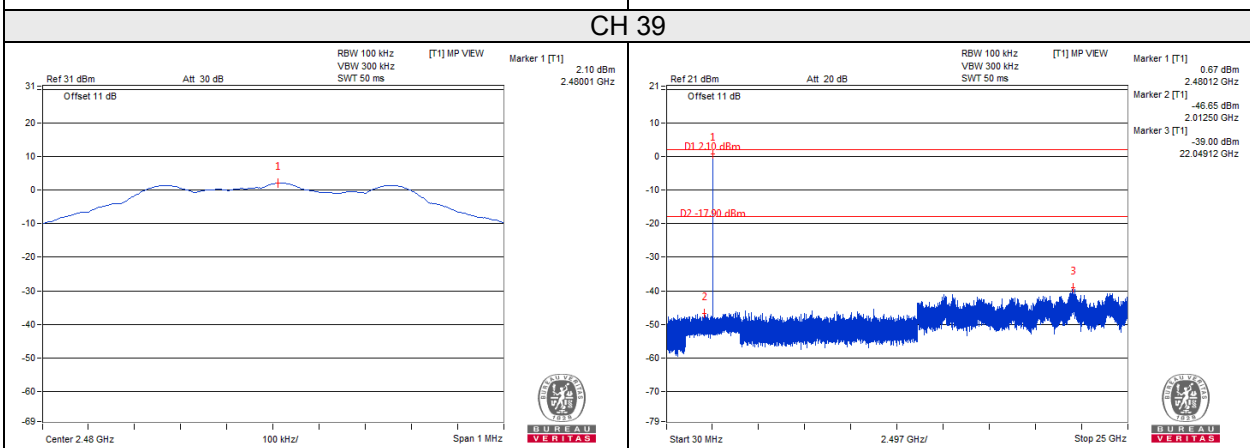
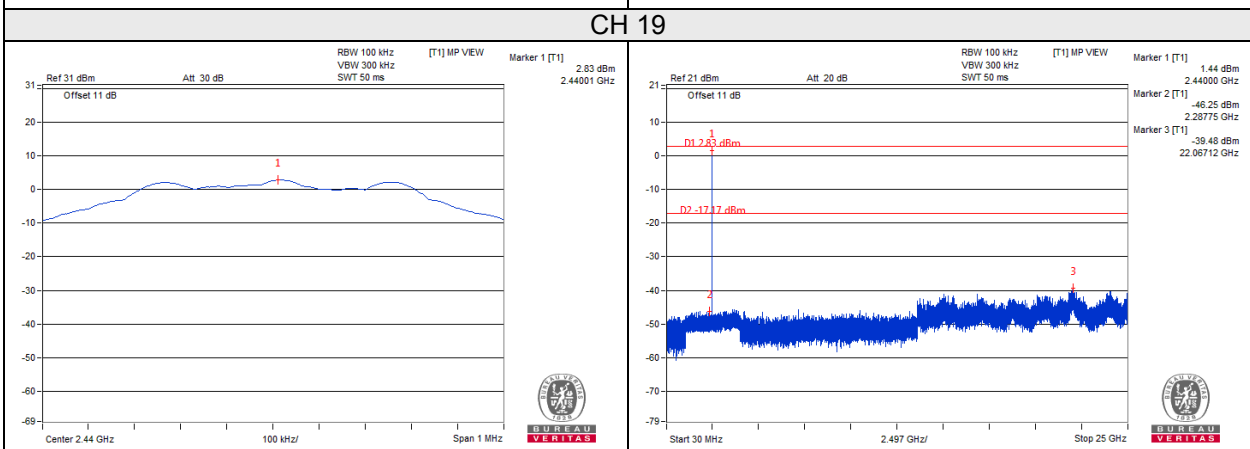
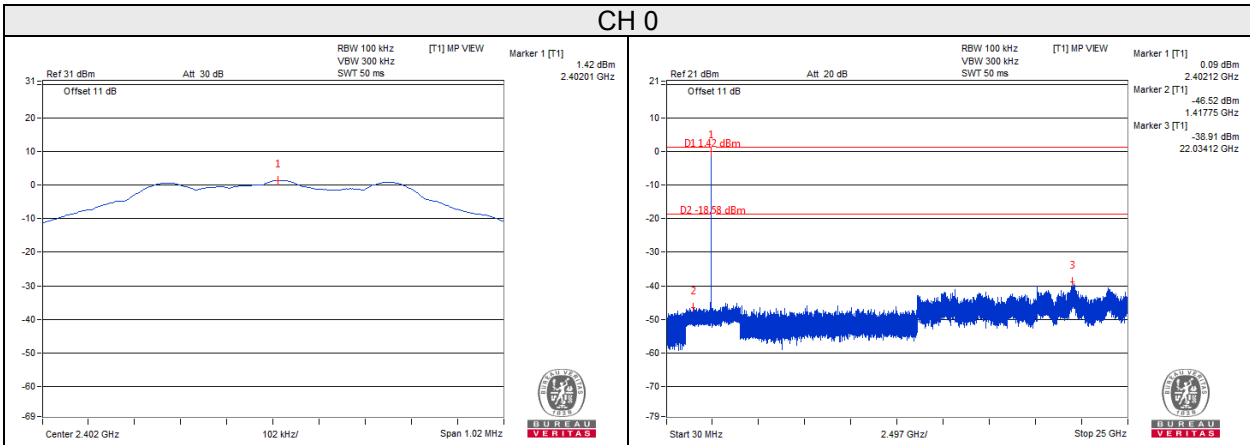

5 Pictures of Test Arrangements

Please refer to the attached file (Test Setup Photo).

Appendix – Information of the Testing Laboratories

We, Bureau Veritas Consumer Products Services (H.K.) Ltd., Taoyuan Branch, were founded in 1988 to provide our best service in EMC, Radio, Telecom and Safety consultation. Our laboratories are FCC recognized accredited test firms and accredited and approved according to ISO/IEC 17025.

If you have any comments, please feel free to contact us at the following:

Lin Kou EMC/RF Lab

Tel: 886-2-26052180

Fax: 886-2-26051924

Hsin Chu EMC/RF/Telecom Lab

Tel: 886-3-6668565

Fax: 886-3-6668323

Hwa Ya EMC/RF/Safety Lab

Tel: 886-3-3183232

Fax: 886-3-3270892

Email: service.adt@tw.bureauveritas.com

Web Site: www.bureauveritas-adt.com

The address and road map of all our labs can be found in our web site also.

--- END ---