

FCC Test Report (Part 22&24&27)

Product Name : DCM (Data Communication Module)
Model No : 5-104348-192
FCC ID : H8NCDD6020

Applicant : ASKEY COMPUTER CORP.

Address : 10F, NO.119, JIANKANG RD., ZHONGHE DIST., NEW TAIPEI CITY 23585

Date of Receipt : 2017/10/13
Issued Date : 2017/11/22
Report No. : 17A0157R-HPUSP46V00
Report Version : V1.0



The test results relate only to the samples tested.

The test results shown in the test report are traceable to the national/international standard through the calibration of the equipment and evaluated measurement uncertainty herein.

This report must not be used to claim product endorsement by TAF or any agency of the government.

The test report shall not be reproduced without the written approval of DEKRA Testing and Certification Co., Ltd.

Test Report

Issued Date : 2017/11/22

Report No.: 17A0157R-HPUSP46V00



Product Name : DCM (Data Communication Module)
Applicant : ASKEY COMPUTER CORP.
Address : 10F, NO.119, JIANKANG RD., ZHONGHE DIST., NEW TAIPEI CITY 23585
Manufacturer : ASKEY COMPUTER CORP.
Trade Name : DENSO CORPORATION
Model No. : 5-104348-192
EUT Rated Voltage : DC 12V
EUT Test Voltage : DC 12V
Measurement Standard : FCC CFR Title 47 Part 2 22 24 27
Measurement : TIA/EIA 603-E 2016
Reference : KDB 971168 D01V03
ANSI C63.26 2015
Test Result : Complied

Documented By : Anny Chou
(Adm. Specialist / Anny Chou)

Tested By : Vorana Chen
(Senior Engineer / Vorana Chen)

Approved By : Vincent Lin
(Director / Vincent Lin)

TABLE OF CONTENTS

Description	Page
1. GENERAL INFORMATION	4
1.1. EUT Description	4
1.2. Antenna List.....	4
1.3. Operational Description.....	5
1.4. Configuration of tested System	6
1.5. EUT Setup Procedures	6
1.6. Test Facility	7
1.7. Type of Emission	8
1.8. Voltages and DC currents	8
2. Technical Test	9
2.1. Summary of test result	9
2.2. List of test Equipment.....	10
2.3. Measurement Uncertainty.....	10
3. Conducted Output Power Measurement	11
3.1. Test Specification	11
3.2. Test Setup	11
3.3. Limits.....	11
3.4. Test Procedure	11
3.5. Test Result of Maximum Power Output.....	12
3.6. Maximum Conducted Power and ERP/EIRP Power	13
4. Occupied Bandwidth	14
4.1. Test Specification	14
4.2. Test Setup	14
4.3. Test Procedure	14
4.4. Test Result of Occupied Bandwidth	15
5. Spurious Emission At Antenna Terminals (+/-1MHz).....	22
5.1. Test Specification	22
5.2. Setup.....	22
5.3. Limits.....	22
5.4. Test Procedure	22
5.5. Test Result of Spurious Emission At Antenna Terminals (+/-1MHz).....	23
6. Spurious Emission	26
6.1. Test Specification	26
6.2. Test Setup	26
6.3. Limits.....	27
6.4. Test Procedure	27
6.5. Test Result of Spurious Emission	28
7. Frequency Stability Under Temperature & Voltage Variations.....	43
7.1. Test Specification	43
7.2. Test Setup	43
7.3. Limits.....	43
7.4. Test Procedure	43
7.5. Test Result of Frequency Stability Under Temperature Variations.....	44
7. EMI Reduction Method During Compliance Testing	47
8. Peak to Average Ratio	48
8.1 Test Specification	48
8.2 Test Setup.....	48
8.3 Limits.....	48
8.4 Test Procedure	48
Attachment 1: EUT Test Photographs	
Attachment 2: EUT Detailed Photographs	

1. GENERAL INFORMATION

1.1. EUT Description

Product Name	DCM (Data Communication Module)
Model No.	5-104348-192
Trade Name	DENSO CORPORATION
IMEI No.	35324409
FCC ID	H8NCDD6020
TX Frequency	WCDMA Band 2: 1852.4 MHz ~ 1907.6 MHz WCDMA Band 4: 1712.4 MHz ~ 1752.6 MHz WCDMA Band 5: 826.4 MHz ~ 846.6 MHz
Rx Frequency	WCDMA Band 2: 1932.4 MHz ~ 1987.6 MHz WCDMA Band 4: 2112.4 MHz ~ 2152.6 MHz WCDMA Band 5: 871.4 MHz ~ 891.6 MHz
Type of modulation	GPRS: GMSK; EGPRS: GMSK / 8PSK WCDMA: QPSK (Uplink); HSDPA: QPSK (Uplink); HSUPA: QPSK (Uplink)
HW Version	Rev2
SW Version	90-00223-M-00-57-00-DV-102717
Antenna Type	Multi Band Dipole Antenna Sentinel 3in1 Adhesive Mount 2*LTE MIMO & GNSS Antenna

1.2. Antenna List

No	Manufacturer	Part No	Peak Gain
1	STAF	N/A (WWAN Main or Aux)	2.56 dBi for 746-960 MHz 3.32 dBi for 1575.42-2170 MHz
2	taoglas	MA250.A.LBI.001 (WWAN Main or Aux MIMO-1 Cable 3m)	0.99 dBi for 824-894 MHz 3.29 dBi for 1710-1880 MHz 3.29 dBi for 1850-1990 MHz
		MA250.A.LBI.001 (WWAN Main or Aux MIMO-2 Cable 3m)	0.44 dBi for 824-894 MHz 3.23 dBi for 1710-1880 MHz 1.77 dBi for 1850-1990 MHz

Note: Each antenna has been evaluated and only the worst case (higher gain antenna) is presented in the report.

1.3. Operational Description

The information contained within this report is intended to show verification of compliance of the 850/1700/1900MHz to the requirements of FCC 47 CFR Part 2, 22, 24 and 27

The EUT provide all functions described as above. The EUT is tested with maximum rated TX power via the Base Station simulator.

DEKRA has verified the construction and function in typical operation. All the test modes were carried out with the EUT in normal operation, which was shown in this test report and defined

as:

Test Mode:	WCDMA BAND 2 (RMC/HSDPA/HSUPA)
	WCDMA BAND 4 (RMC/HSDPA/HSUPA)
	WCDMA BAND 5 (RMC/HSDPA/HSUPA)

Note:

The maximum power levels are RMC 12.2K mode for WCDMA Band 2/4/5, only these modes were used for all tests.

1.4. Configuration of tested System

(a) Configuration of Radiated measurement

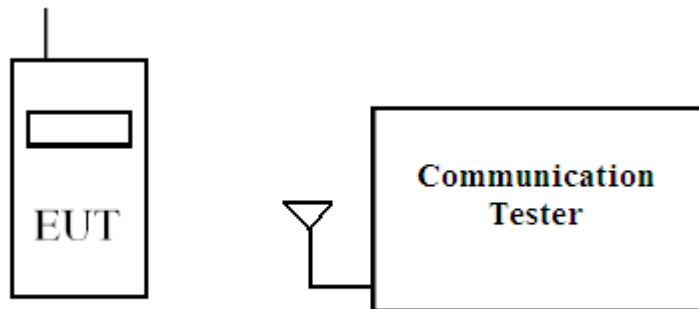

(b) Configuration of Conducted measurement

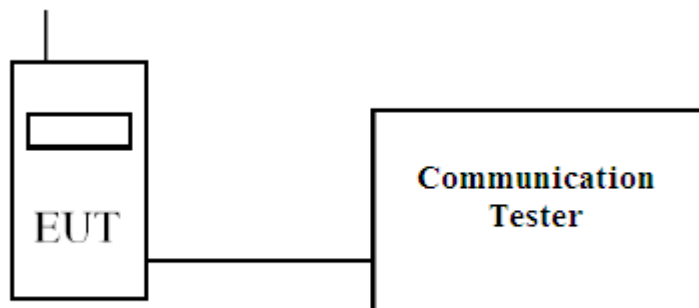

1.5. EUT Setup Procedures

- (1) Setup the EUT and simulators as shown on 1.3
- (2) Turn on the power of all equipments.
- (3) The EUT was set to communicate with communication tester.
- (4) Repeat the above procedure (3).

1.6. Test Facility

Ambient conditions in the laboratory:

Items	Required (IEC 68-1)	Actual
Temperature (°C)	15-35	23.1
Humidity (%RH)	25-75	52
Barometric pressure (mbar)	860-1060	988

The related certificate for our laboratories about the test site and management system can be downloaded from DEKRA Testing and Certification Co., Ltd. Web Site:

<http://www.dekra.com.tw/english/about/certificates.aspx?bval=5>

The address and introduction of DEKRA Testing and Certification Co., Ltd. laboratories can be founded in our Web site: http://www.dekra.com.tw/index_en.aspx

Site Description: File on
Federal Communications Commission
FCC Engineering Laboratory
7435 Oakland Mills Road
Columbia, MD 21046
FCC Registration Number :92195

Site Name: DEKRA Testing and Certification Co., Ltd

Lin Kou Laboratory:

No.5-22, Ruishukeng, Linkou Dist., New Taipei City 24451,
Taiwan, R.O.C.

TEL : 886-2-8601-3788 / FAX : 886-2-8601-3789

E-Mail : info.tw@dekra.com

FCC Accreditation Number: TW3023

1.7. Type of Emission

System	Type of modulation	Emission Designator
WCDMA Band 2 RMC 12.2kbps	QPSK	4M13F9W
WCDMA Band 4 RMC 12.2kbps	QPSK	4M12F9W
WCDMA Band 5 RMC 12.2kbps	QPSK	4M12F9W

1.8. Voltages and DC currents

WCDMA Band 2 RMC 12.2K	
EUT Transmitting (in maximum power) :	DC voltage : 12V , DC current : 0.13A
EUT Standby :	DC voltage : 12V , DC current : 0.09A
WCDMA Band 4 RMC 12.2K	
EUT Transmitting (in maximum power) :	DC voltage : 12V , DC current : 0.13A
EUT Standby :	DC voltage : 12V , DC current : 0.10A
WCDMA Band 5 RMC 12.2K	
EUT Transmitting (in maximum power) :	DC voltage : 12V , DC current : 0.13A
EUT Standby :	DC voltage : 12V , DC current : 0.10A

2. Technical Test

2.1. Summary of test result

Standard	Test Item	Result	Note
2.1046	Conducted Output Power	Pass	
22.913(a)			
24.232(c)			
27.50(d)			
2.1049	Occupied Bandwidth	Pass	
22.917(a)			
24.238(b)			
27.53(h)			
2.1051	Spurious Emission at Antenna Terminals	Pass	
22.917(a)			
24.238(a)			
27.53(h)			
2.1051	Conducted Emission	Pass	
22.917(a)			
24.238(a)			
27.53(h)			
2.1053	Field Strength of Spurious Radiation	Pass	
22.917(a)			
24.238(a)			
27.53(h)			
2.1055	Frequency Stability for Temperature & Voltage	Pass	
22.355			
24.235			
27.54			
22.913 (d)	Peak to Average Ratio	Pass	
24.232 (d)			
27.50			

2.2. List of test Equipment

Conducted /CTR

Instrument	Manufacturer	Type No.	Serial No	Cal. Date
Spectrum Analyzer	Agilent	N9010A	MY48030495	2017/10/13
Directional coupler	Agilent	87300C	MY44300353	2017/11/30
Directional coupler	Agilent	778D-012	50550	2016/12/08
Standard Temperature & Humidity Chamber	WIT	TH-1S-B	EQ-201-00146	2016/11/28
DC power supply	Agilent	E3610A	MY40009845	2017/07/14
Communication Tester	R&S	CMU200	112970	2017/07/07

Radiated / Site3

Instrument	Manufacturer	Type No.	Serial No	Cal. Date
Bilog Antenna	Schaffner Chase	CBL6112B	2707	2017/06/29
Horn Antenna	R&S	9120D	867	2017/04/28
Pre-Amplifier	Agilent	87405C	MY55380068	2017/08/08
Spectrum Analyzer	Agilent	N9010A	MY54510357	2017/04/26
DC power supply	Agilent	E3610A	MY40009845	2017/07/14
Communication Tester	R&S	CMU200	112970	2017/07/07

2.3. Measurement Uncertainty

Conducted Emission

The measurement uncertainty of confidence of 95% is evaluated as ± 1.52 dB

Radiated Emission (Below 1GHz)

The measurement uncertainty of confidence of 95% is evaluated as ± 3.44 dB .

Radiated Emission (Above 1GHz)

The measurement uncertainty of confidence of 95% is evaluated as ± 4.08 dB

3. Conducted Output Power Measurement

3.1. Test Specification

According to Part 2.1046, 22.913, 24.232, 27.50.

3.2. Test Setup

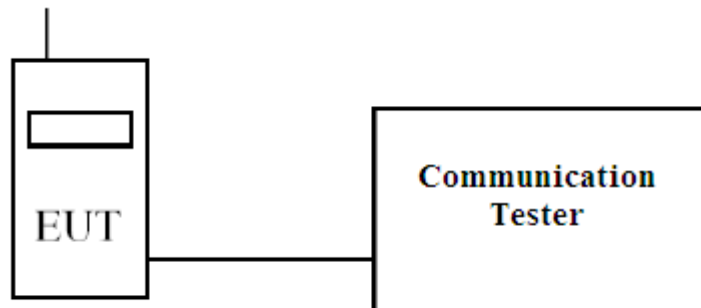

3.3. Limits

Band	Limit
850	<7W
1900	<2W
AWS(1700)	<1W

3.4. Test Procedure

The EUT is tested with maximum rated TX power via the Base Station simulator, and the output power was measured at the antenna terminals of the EUT.

3.5. Test Result of Maximum Power Output

Product	DCM (Data Communication Module)		
Test Mode	RF Output Power (Conducted)		
Date of Test	2017/10/25	Test Site	CTR

Band	WCDMA Band 2			WCDMA Band 4			WCDMA Band 5		
CHANNEL	9262	9400	9538	1312	1413	1513	4132	4183	4233
RMC	24.32	24.43	24.63	23.05	22.92	23.23	24.35	24.36	24.39
HSDPA Set 1	23.29	23.39	23.61	22.13	22.06	22.53	23.26	23.25	23.30
HSDPA Set 2	22.81	23.05	23.43	21.98	21.55	22.25	22.54	22.63	22.76
HSDPA Set 3	22.81	23.08	23.33	21.89	21.50	22.25	22.56	22.67	22.80
HSDPA Set 4	22.91	23.10	23.37	21.89	21.51	22.30	22.53	22.69	22.90
HSUPA Set 1	23.39	23.54	23.56	23.02	22.98	23.17	23.52	23.49	23.51
HSUPA Set 2	21.55	21.58	21.44	21.16	21.11	21.39	21.43	21.27	21.50
HSUPA Set 3	22.57	22.65	22.71	22.17	22.08	22.34	22.48	22.61	22.58
HSUPA Set 4	21.49	21.65	21.39	21.10	21.07	21.44	21.5	21.43	21.45
HSUPA Set 5	23.60	23.61	23.73	23.10	23.04	23.15	23.32	23.43	23.55

3.6. Maximum Conducted Power and ERP/EIRP Power

According to KDB 412172 D01 Section 1.2 Power Approach

$$\text{EIRP} = P_T + G_T - L_C = \text{ERP} + 2.15 \text{ dB}, \text{ERP} = \text{EIRP} - 2.15 \text{ dB}$$

P_T = transmitter output power in dBm

G_T = gain of the transmitting antenna in dBi

L_C = signal attenuation in the connecting cable between the transmitter and antenna in dB

WCDMA	CHANNEL	Conducted Peak Power (dBm)	Conducted Peak Power (W)	Antenna Gain (dBi)	Maximum ERP/EIRP (W)	Maximum ERP/EIRP Limit (W)
Band 2	RMC	24.63	0.29	3.32	0.624	2
Band 2	HSDPA	23.61	0.23	3.32	0.493	2
Band 2	HSUPA	23.73	0.24	3.32	0.507	2
Band 4	RMC	23.23	0.21	3.32	0.452	1
Band 4	HSDPA	22.53	0.18	3.32	0.385	1
Band 4	HSUPA	23.17	0.21	3.32	0.446	1
Band 5	RMC	24.39	0.27	2.56	0.302	7
Band 5	HSDPA	23.3	0.21	2.56	0.235	7
Band 5	HSUPA	23.55	0.23	2.56	0.249	7

4. Occupied Bandwidth

4.1. Test Specification

According to Part 2.1049, 22.917, 24.238, 27.53.

4.2. Test Setup

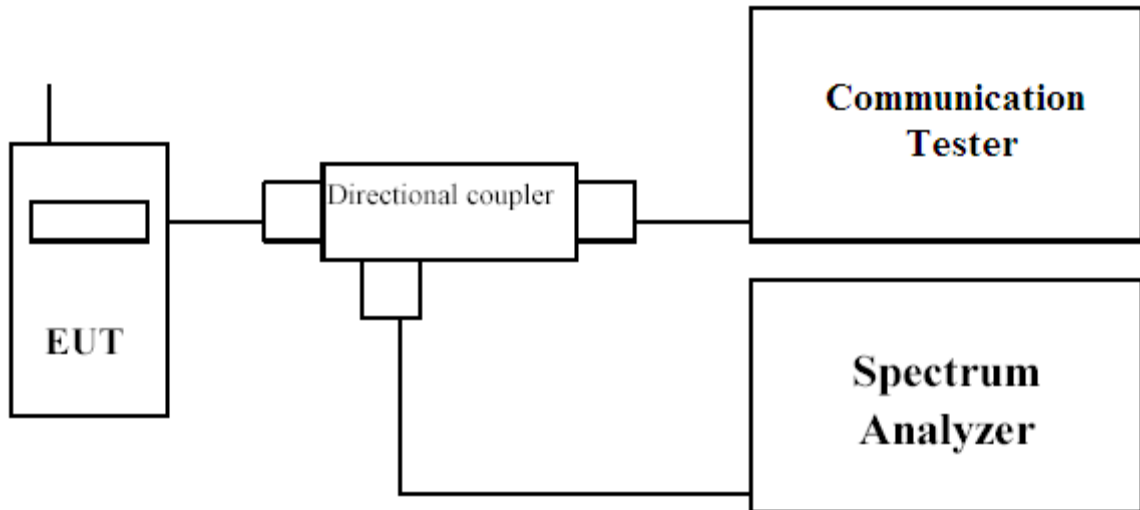

4.3. Test Procedure

The EUT is tested with maximum rated TX power via the Base Station simulator, and the occupied bandwidth was measured at the antenna terminals of the EUT.

The Resolution BW of the analyzer is set to 1 % of the emission bandwidth. The EUT's occupied bandwidth is measured as the width of the signal between two points, one below the carrier center frequency and one above the carrier frequency, outside of which all emissions are attenuated at least 26 dB below the transmitter power.

The plots below show the resultant display from the Spectrum Analyzer.

4.4. Test Result of Occupied Bandwidth

Product	DCM (Data Communication Module)
Test Mode	Occupied Bandwidth
Test Site	CTR

Test Mode	Channel & TX Frequency (MHz)	99% Occupied Bandwidth (kHz)	26 dB bandwidth (kHz)	Required Limit (kHz)	Result
WCDMA Band 2	9262(1852.4)	4.1131	4.708	N/A	Pass
	9400(1880)	4.1165	4.697	N/A	Pass
	9538(1907.6)	4.1257	4.718	N/A	Pass
WCDMA Band 4	1312(1712.4)	4.1197	4.694	N/A	Pass
	1413(1732.6)	4.1227	4.720	N/A	Pass
	1513(1752.6)	4.1052	4.677	N/A	Pass
WCDMA Band 5	4132(826.4)	4.1191	4.691	N/A	Pass
	4183(836.6)	4.1154	4.692	N/A	Pass
	4233(846.6)	4.0968	4.673	N/A	Pass

Product	DCM (Data Communication Module)		
Test Mode	Occupied Bandwidth		
Date of Test	2017/10/30	Test Site	CTR
Test Condition	WCDMA BAND 2		

WCDMA BAND 2 (CH 9262)

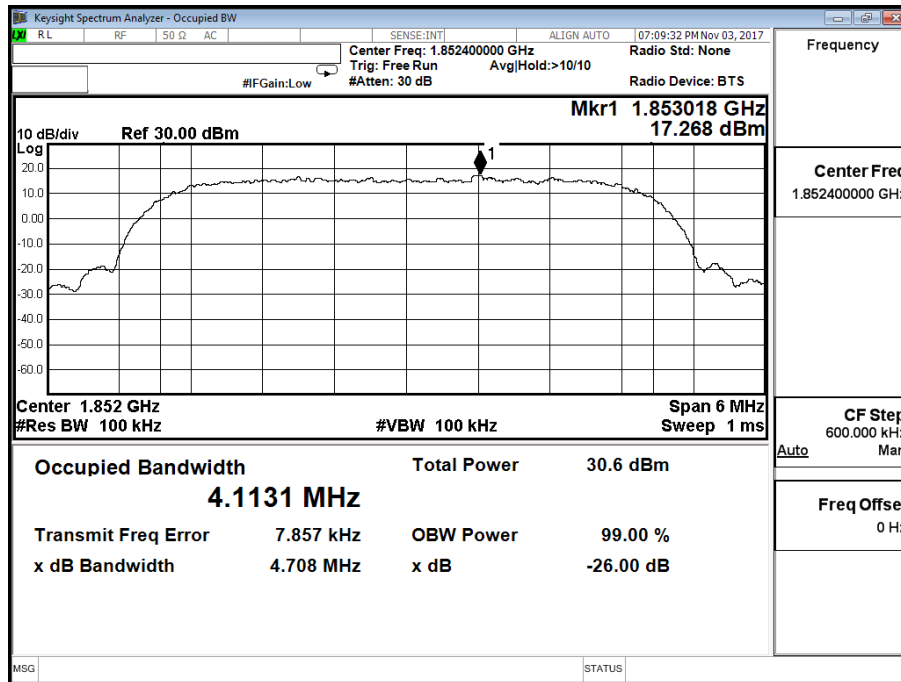

WCDMA BAND 2 (CH 9400)

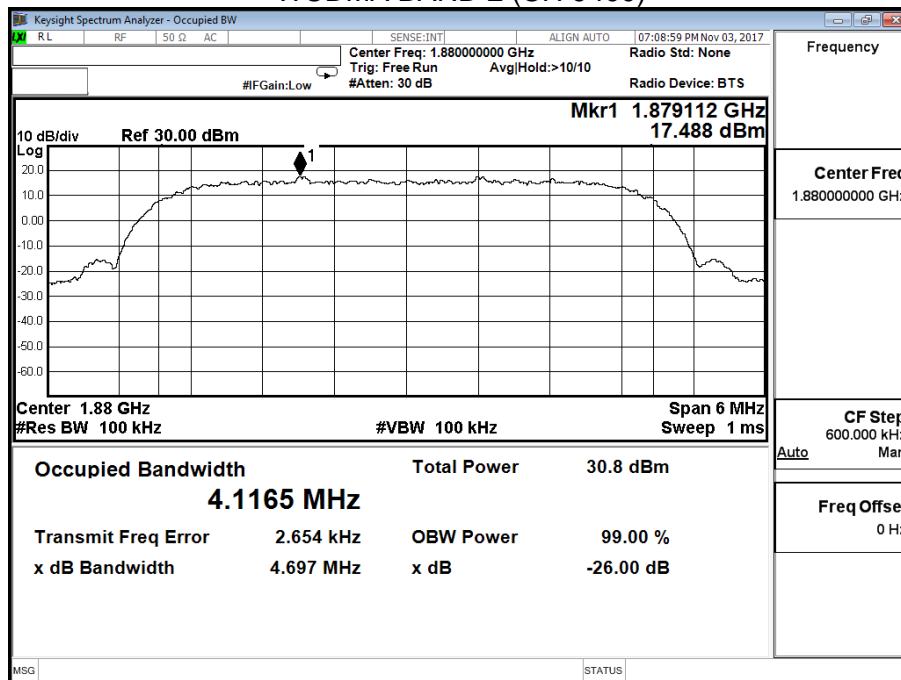

Product	DCM (Data Communication Module)		
Test Mode	Occupied Bandwidth		
Date of Test	2017/10/30	Test Site	CTR
Test Condition	WCDMA BAND 2		

WCDMA BAND 2 (CH 9538)

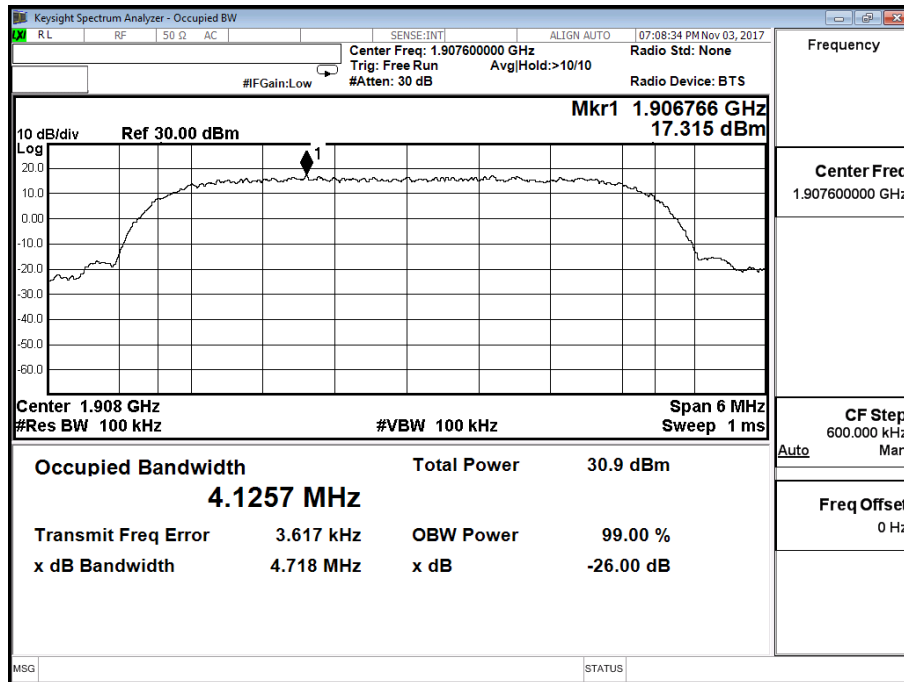

Product	DCM (Data Communication Module)		
Test Mode	Occupied Bandwidth		
Date of Test	2017/10/30	Test Site	CTR
Test Condition	WCDMA BAND 4		

WCDMA BAND 4 (CH 1312)

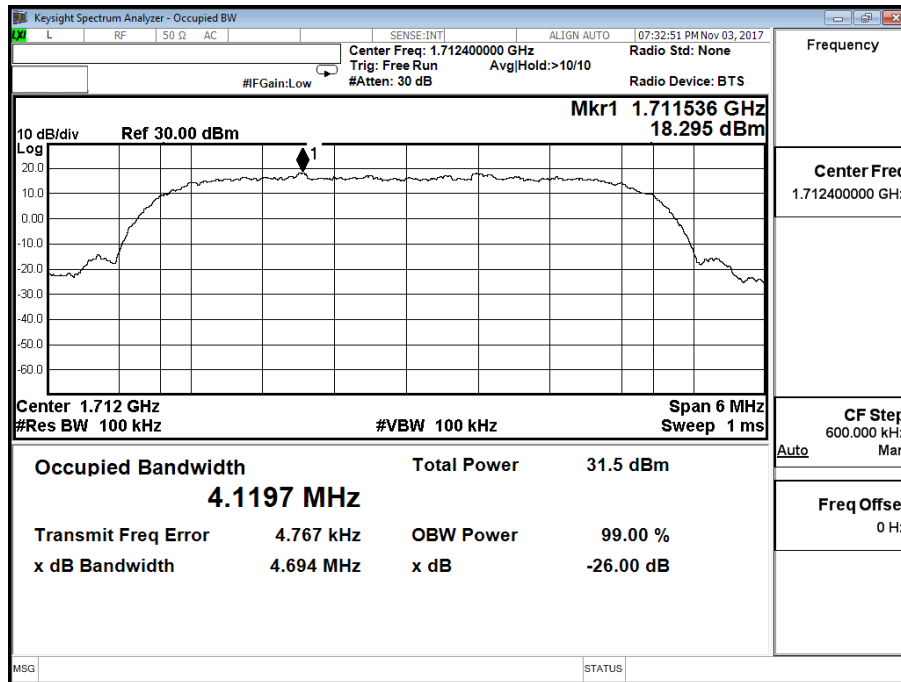

WCDMA BAND 4 (CH 1413)

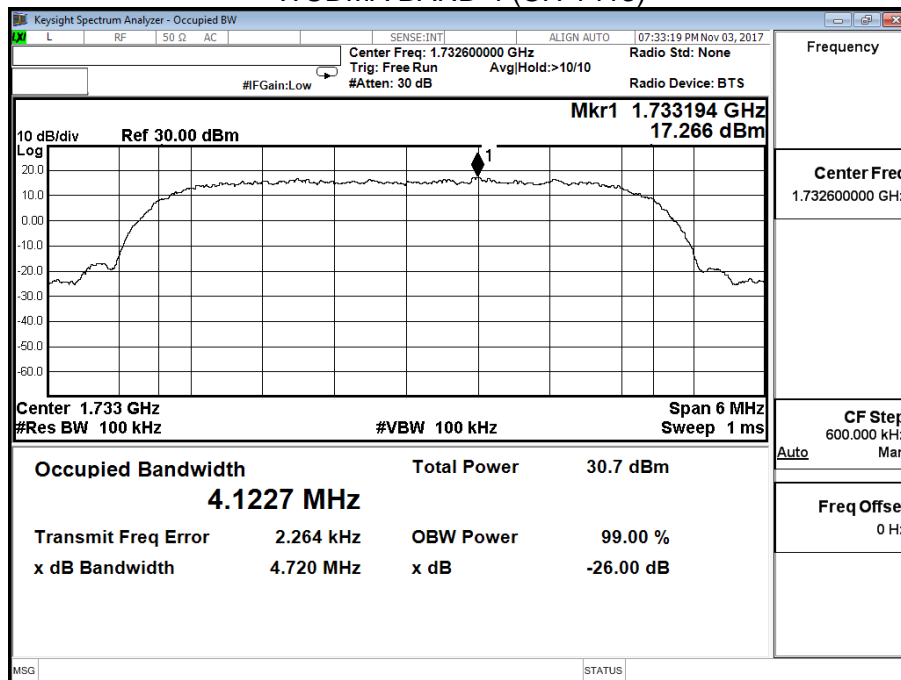

Product	DCM (Data Communication Module)		
Test Mode	Occupied Bandwidth		
Date of Test	2017/10/30	Test Site	CTR
Test Condition	WCDMA BAND 4		

WCDMA BAND 4 (CH 1513)

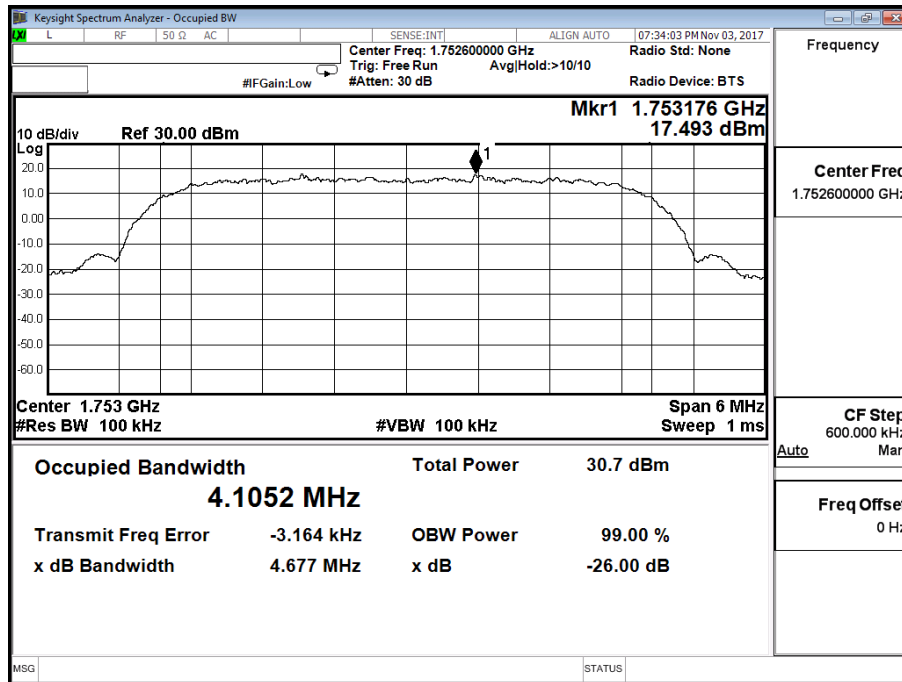

Product	DCM (Data Communication Module)		
Test Mode	Occupied Bandwidth		
Date of Test	2017/10/30	Test Site	CTR
Test Condition	WCDMA BAND 5		

WCDMA BAND 5 (CH 4132)

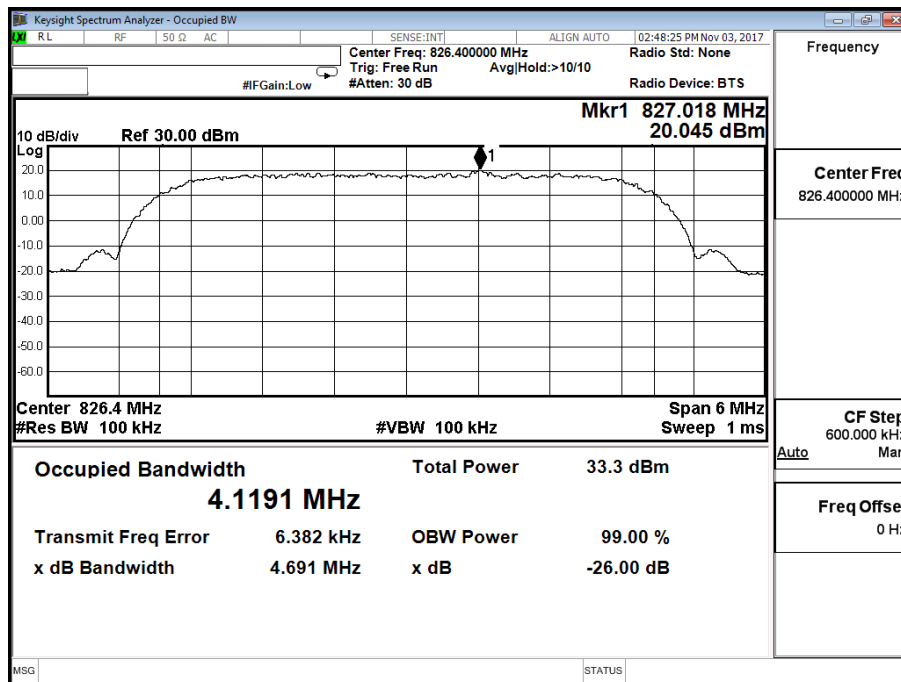

WCDMA BAND 5 (CH 4183)

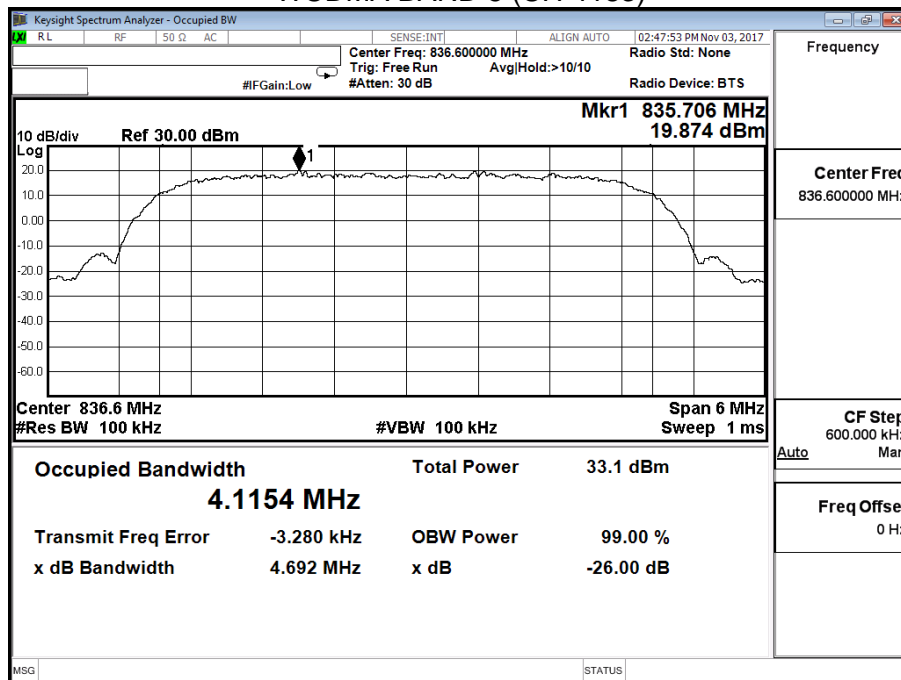

Product	DCM (Data Communication Module)		
Test Mode	Occupied Bandwidth		
Date of Test	2017/10/30	Test Site	CTR
Test Condition	WCDMA BAND 5		

WCDMA BAND 5 (CH 4233)

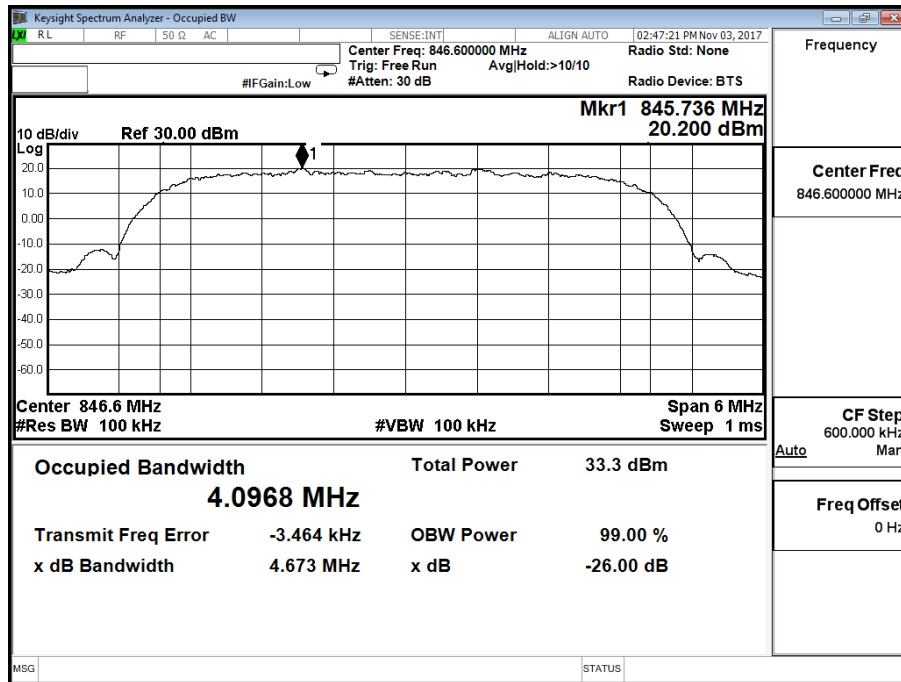

5. Spurious Emission At Antenna Terminals (+/-1MHz)

5.1. Test Specification

According to Part 2.1049, 22.917, 24.238, 27.53.

5.2. Setup

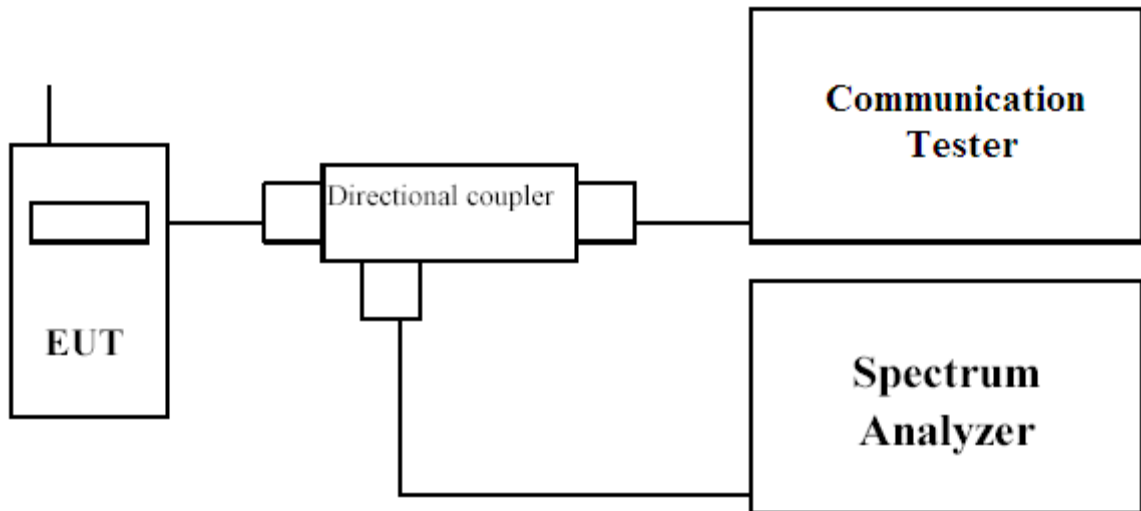

5.3. Limits

The power of any emission outside of the authorized operating frequency ranges must be attenuated below the transmitting power (P) by a factor of at least $43 + 10 \log(P)$ dB.

5.4. Test Procedure

In accordance with Part 22.917, 24.238, 27.53, at least 1% of the emission bandwidth was used for the resolution and video bandwidths up to 1MHz away from the Block Edge. At greater than 1MHz, the resolution and video bandwidth were set $3 \times \text{RBW}$.

The reference power and path losses of all channels used for testing in each frequency block were measured.

5.5. Test Result of Spurious Emission At Antenna Terminals (+/-1MHz)

Product	DCM (Data Communication Module)		
Test Mode	Spurious Emission At Antenna Terminals (+/-1MHz)		
Date of Test	2017/10/26	Test Site	CTR
Test Condition	Block Edge Test (WCDMA BAND 2)		

WCDMA BAND 2 Lower Channel 9262 (1852.4MHz)

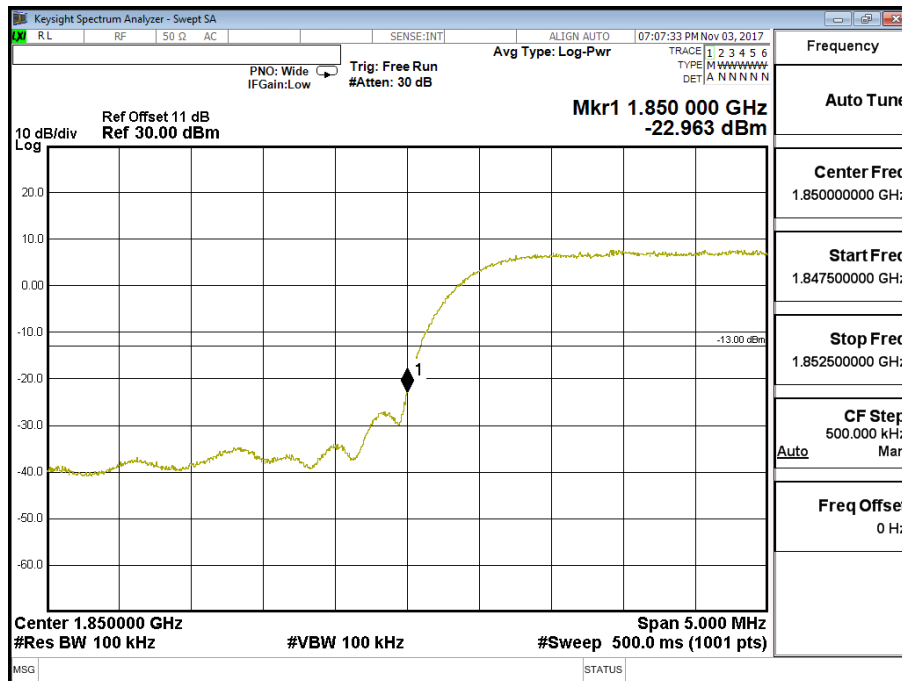

WCDMA BAND 2 Upper Channel 9538 (1907.6 MHz)

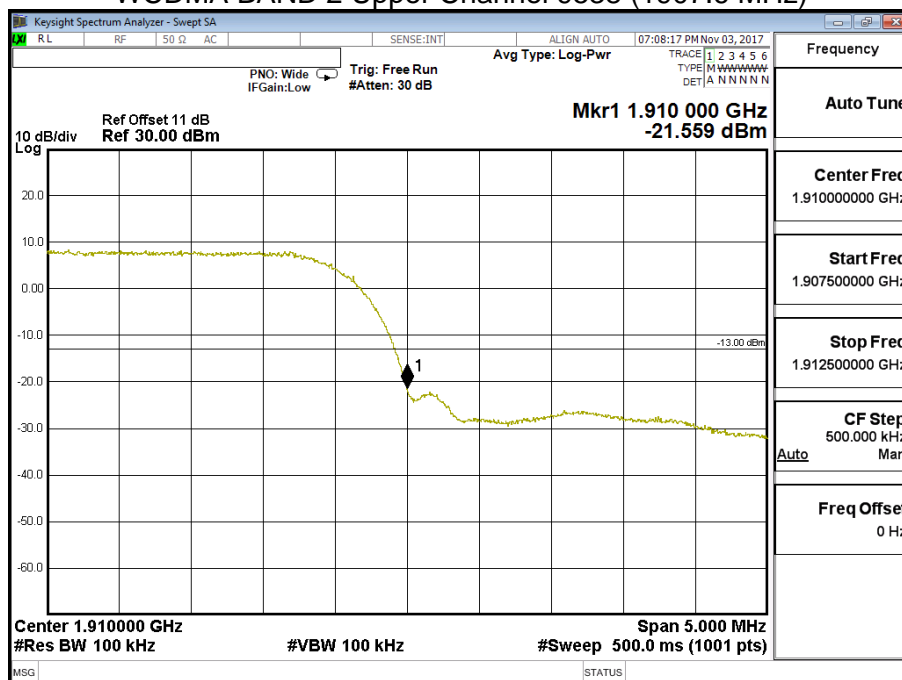

Product	DCM (Data Communication Module)		
Test Mode	Spurious Emission At Antenna Terminals (+/-1MHz)		
Date of Test	2017/10/26	Test Site	CTR
Test Condition	Block Edge Test (WCDMA BAND 4)		

WCDMA BAND 4 Lower Channel 1312 (1712.4MHz)

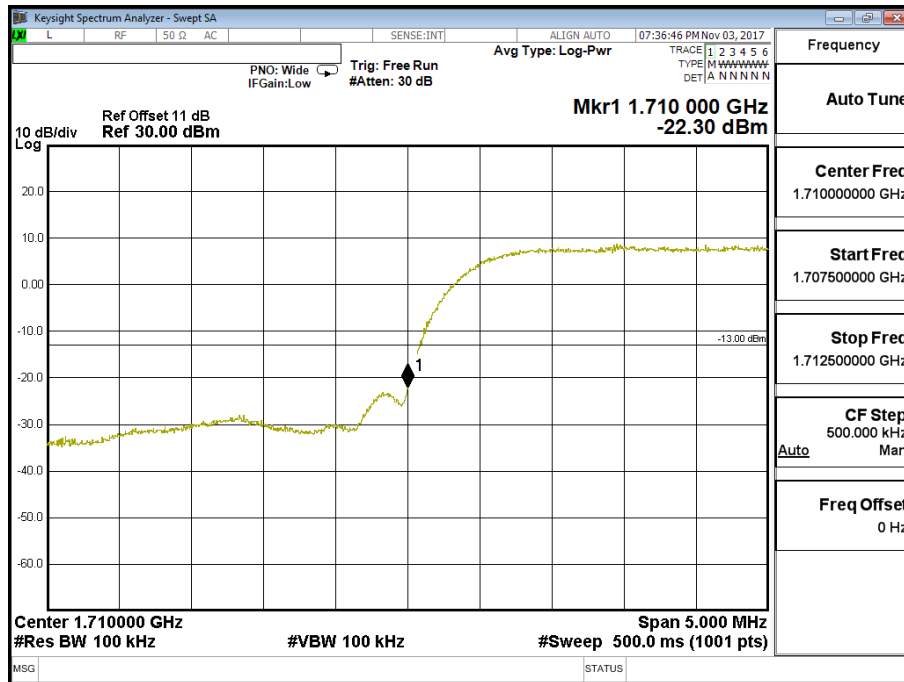

WCDMA BAND 4 Upper Channel 1513 (1752.6MHz)

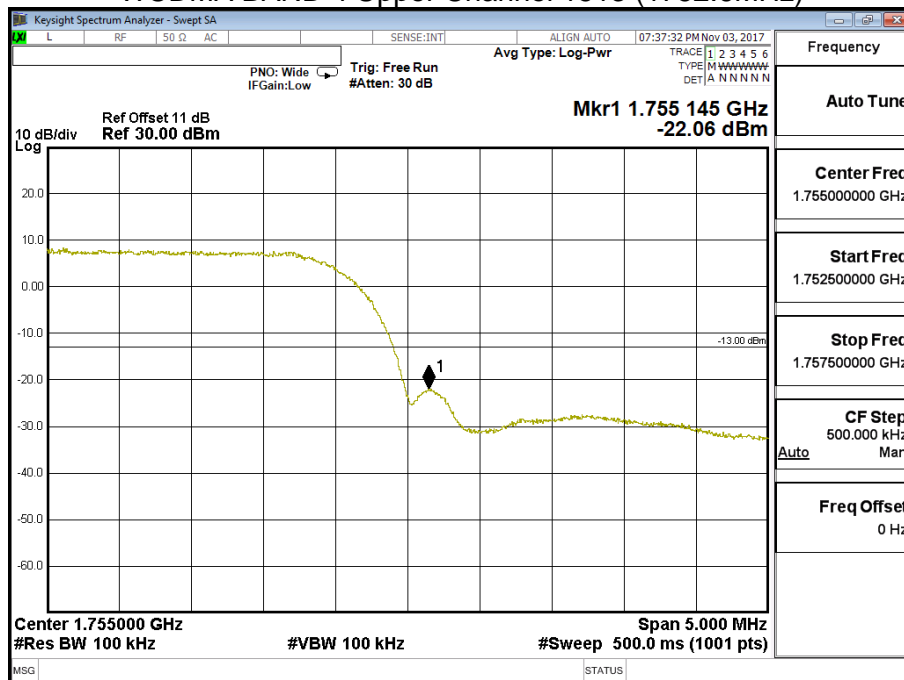

Product	DCM (Data Communication Module)		
Test Mode	Spurious Emission At Antenna Terminals (+/-1MHz)		
Date of Test	2017/10/26	Test Site	CTR
Test Condition	Block Edge Test (WCDMA BAND 5)		

WCDMA BAND 5 Lower Channel 4132 (826.4MHz)

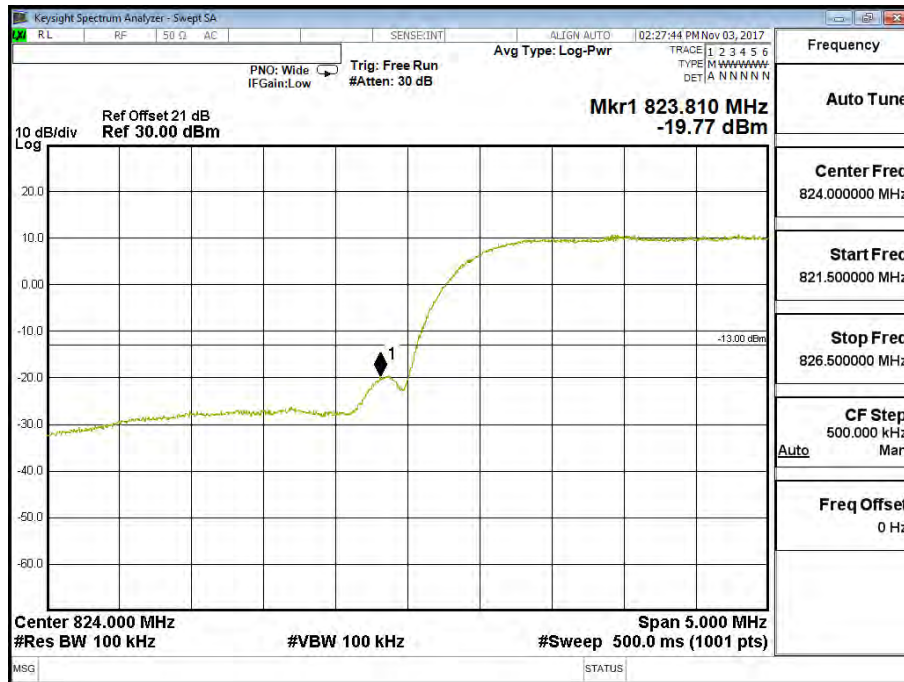

WCDMA BAND 5 Upper Channel 4233 (846.6MHz)

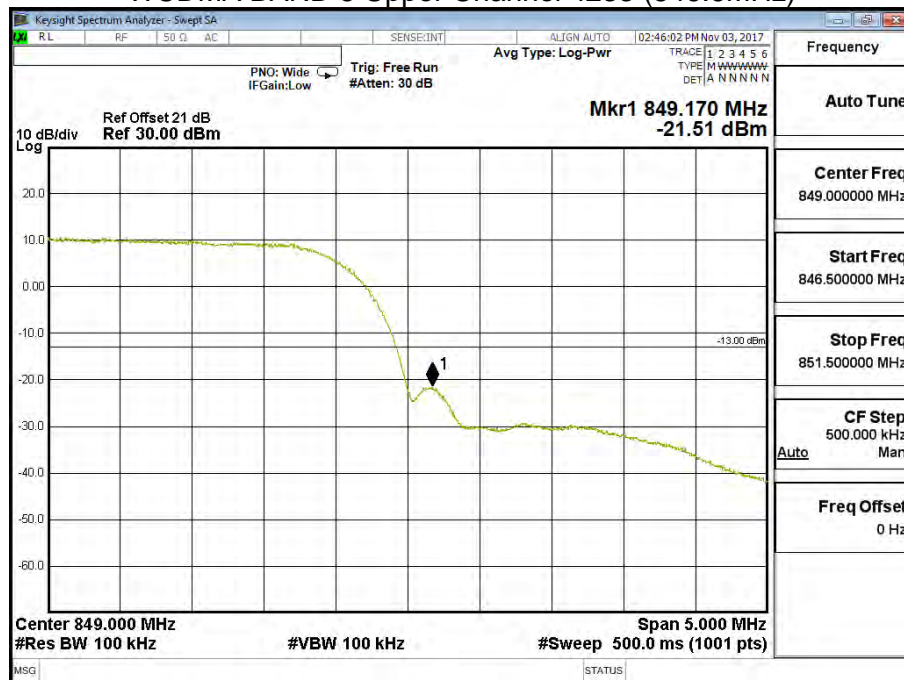

6. Spurious Emission

6.1. Test Specification

According to Part 2.1051, 2.1053, 22.917, 24.238, 27.53.

6.2. Test Setup

6.1.1 Spurious emissions at antenna terminals.

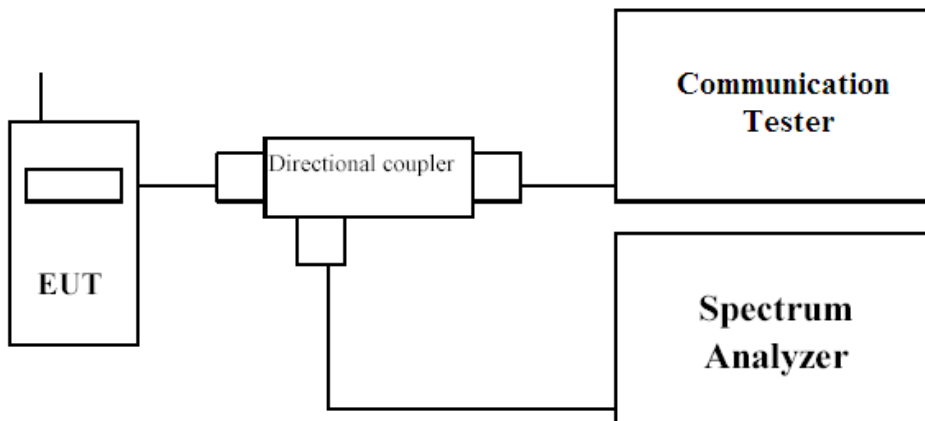

6.1.2 Field strength of spurious radiation.

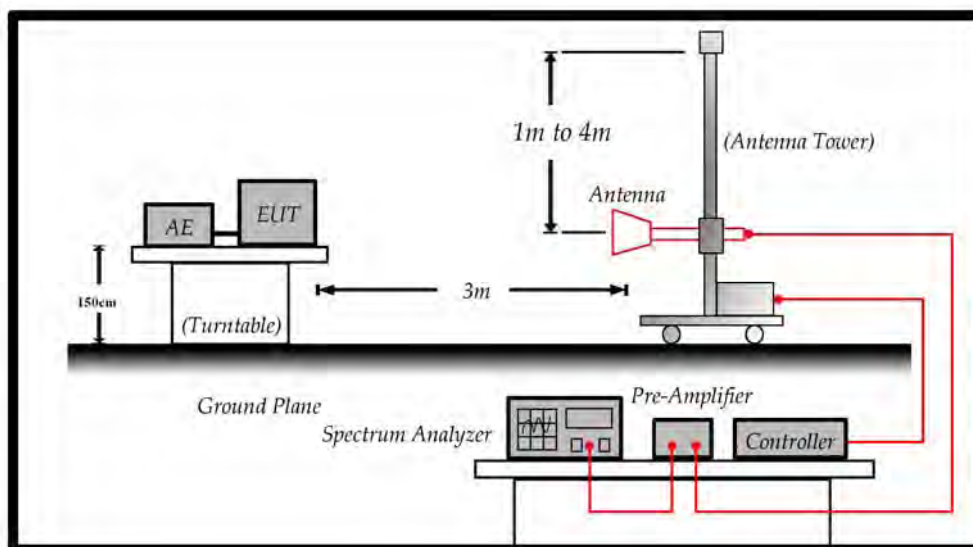

6.3. Limits

Limit	<-13dBm
-------	---------

$43 + 10\text{Log}(P)$ down on the carrier where P is the power in Watts.

6.4. Test Procedure

In accordance with Part 2.1051/2.1053, the spurious emissions from the EUT were measured. The transmitter output power was attenuated using a combination of filters and attenuators and the frequency spectrum investigated from 30MHz to 20GHz. The EUT was set to transmit on full power. The resolution and video bandwidth was set to 1MHz and 3 x RBW. in accordance with Part 22.917 & 24.238, 27.53. The spectrum analyzer detector was set to Max Hold. In addition, measurements were made up to the 10th harmonic of the fundamental. The device was then replaced with a substitution antenna, which input signal was adjusted until the received level matched that of the previously detected emission.

- (1) The EUT is tested with maximum rated TX power via the Base Station simulator.
- (2) The EUT is tested in three orthogonal planes; The worst case test configuration was record on report.

The EUT is placed on a turn table which is 1.5 meter above ground. The turn table can rotate 360 degrees to determine the position of the maximum emission level. The EUT was positioned such that the distance from antenna to the EUT was 3 meters.

The antenna can move up and down between 1 meter and 4 meters to find out the maximum emission level.

Both horizontal and vertical polarization of the antenna are set on measurement. In order to find the maximum emission, all of the interface cables must be manipulated according to TIA/EIA 603-E on radiated measurement.

6.5. Test Result of Spurious Emission

Product	DCM (Data Communication Module)		
Test Mode	Spurious Emission (Conducted)		
Date of Test	2017/11/10	Test Site	CTR
Test Condition	WCDMA BAND 2	Test Range	30MHz~20GHz

WCDMA BAND 2 High-Channel 9538 (1907.6MHz)

Frequency (MHz)	Reading Level (dBm)	Path Loss (dB)	Emission Level (dBm)	Limit (dBm)
3815	-44.242	1.10	-43.142	-13
5723	-52.592	1.23	-51.362	-13
7630	-59.331	1.59	-57.741	-13
9538	-62.248	1.89	-60.358	-13
11446	-65.566	2.07	-63.496	-13
13353	-64.503	2.26	-62.243	-13
15261	-60.980	2.64	-58.340	-13
17168	-61.131	3.50	-57.631	-13
19076	-59.572	3.70	-55.872	-13

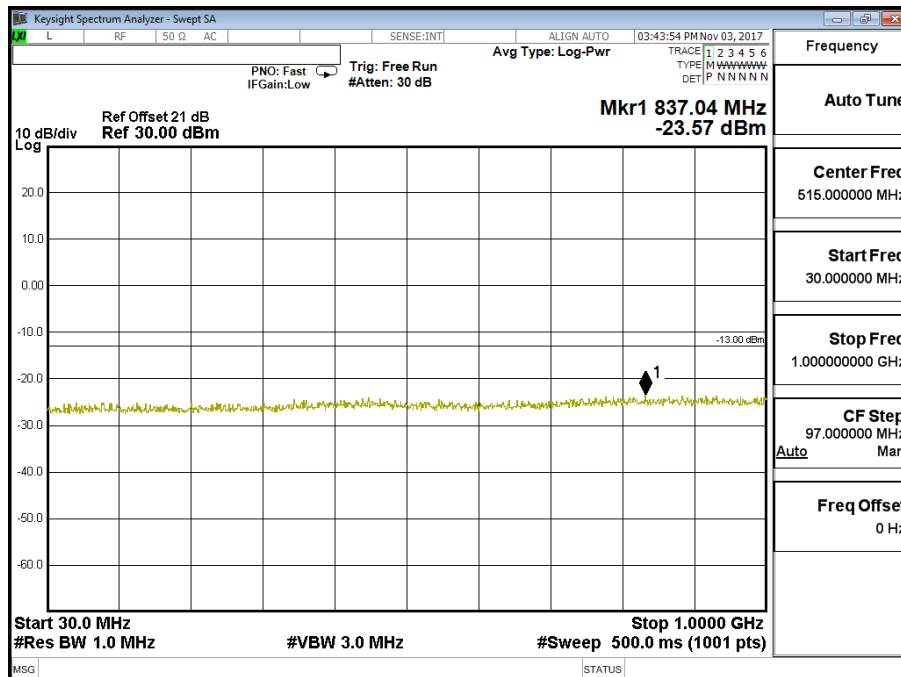

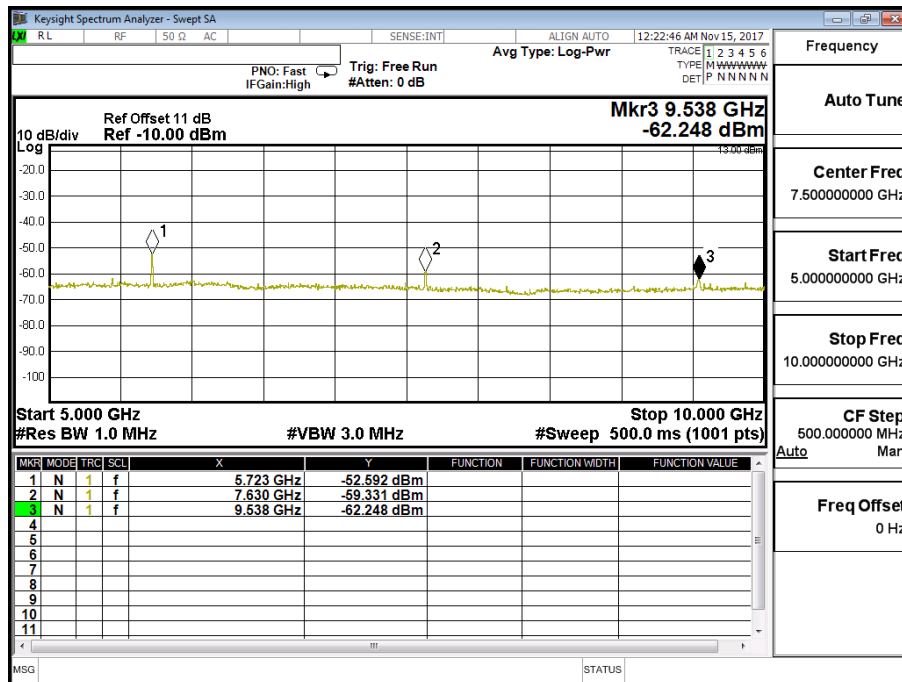
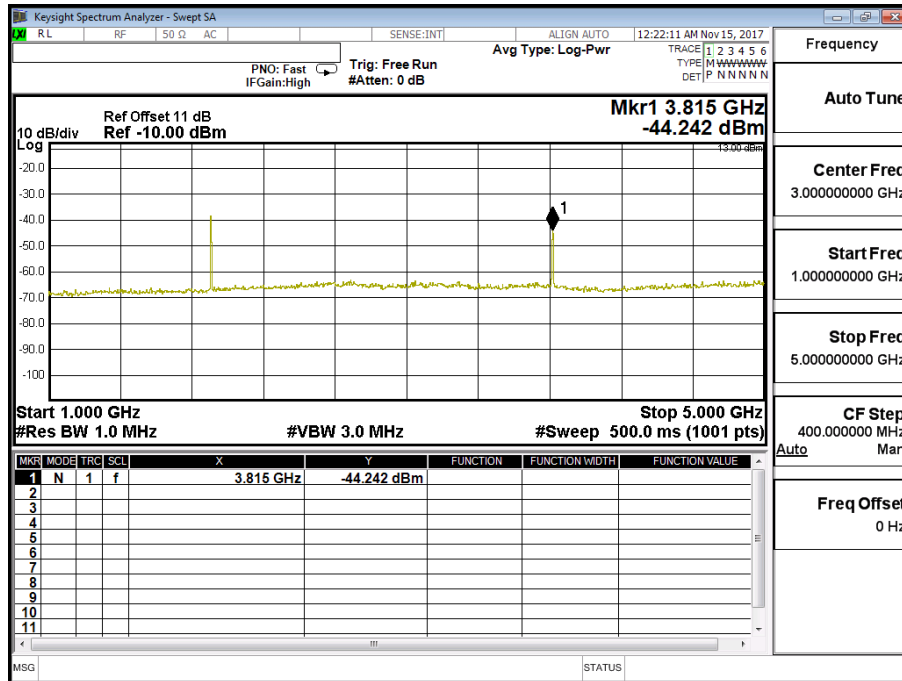

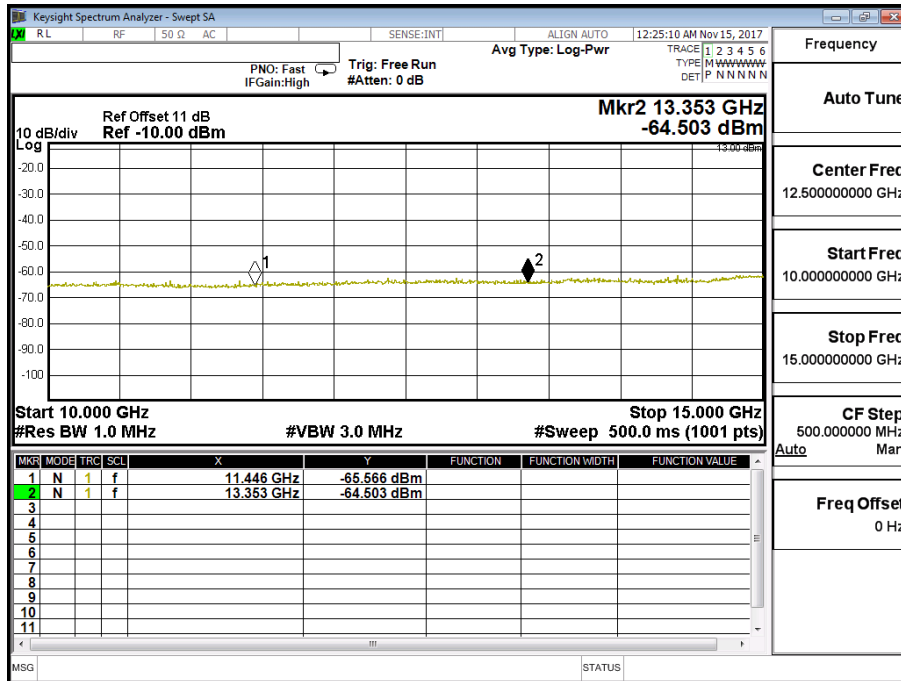

Frequency	Auto Tune
Center Freq	12.500000000 GHz
Start Freq	10.000000000 GHz
Stop Freq	15.000000000 GHz
CF Step	500.000000 MHz
Freq Offset	0 Hz

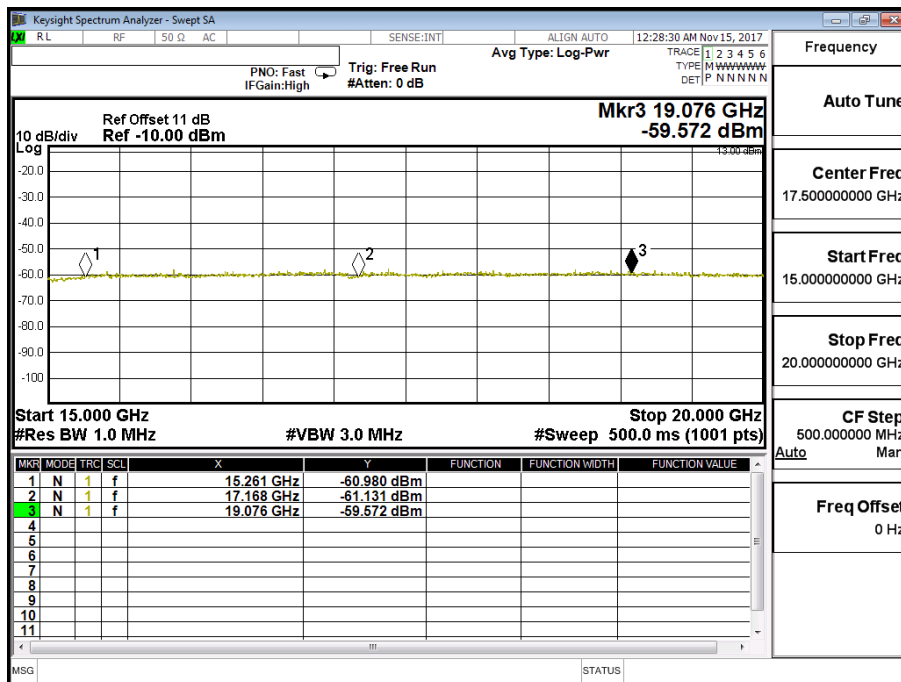

Frequency	Auto Tune
Center Freq	17.500000000 GHz
Start Freq	15.000000000 GHz
Stop Freq	20.000000000 GHz
CF Step	500.000000 MHz
Freq Offset	0 Hz

Product	DCM (Data Communication Module)		
Test Mode	Spurious Emission (Conducted)		
Date of Test	2017/11/10	Test Site	CTR
Test Condition	WCDMA BAND 4	Test Range	30MHz~20GHz

WCDMA BAND 4 High-Channel 1513 (1752.6MHz)

Frequency (MHz)	Reading Level (dBm)	Path Loss (dB)	Emission Level (dBm)	Limit (dBm)
3508	-41.370	1.10	-40.270	-13
5258	-32.027	1.23	-30.797	-13
7010	-55.966	1.59	-54.376	-13
8763	-53.791	1.89	-51.901	-13
10520	-56.140	2.07	-54.070	-13
12268	-65.392	2.26	-63.132	-13
14021	-64.660	2.64	-62.020	-13
15773	-61.426	3.50	-57.926	-13
17526	-60.750	3.70	-57.050	-13

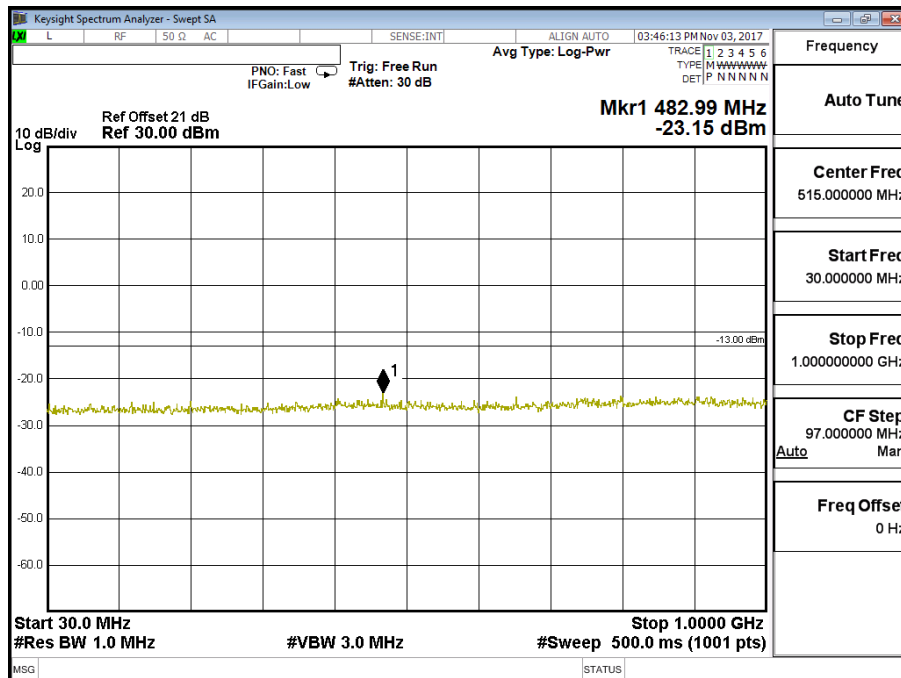

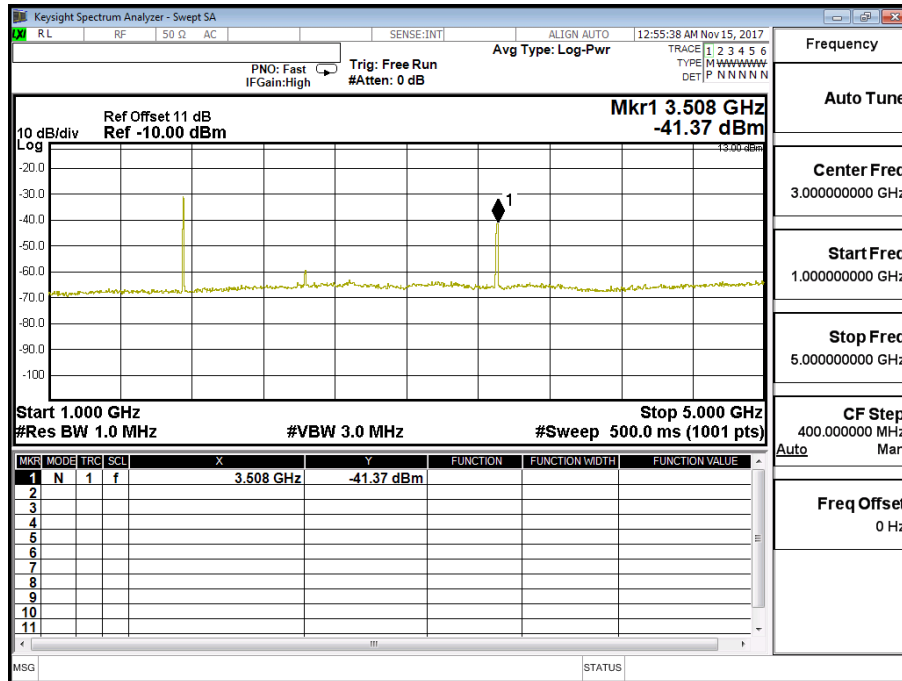

Frequency	Auto Tune
Center Freq	3.000000000 GHz
Start Freq	1.000000000 GHz
Stop Freq	5.000000000 GHz
CF Step	400.0000000 MHz
Auto	Man
Freq Offset	0 Hz

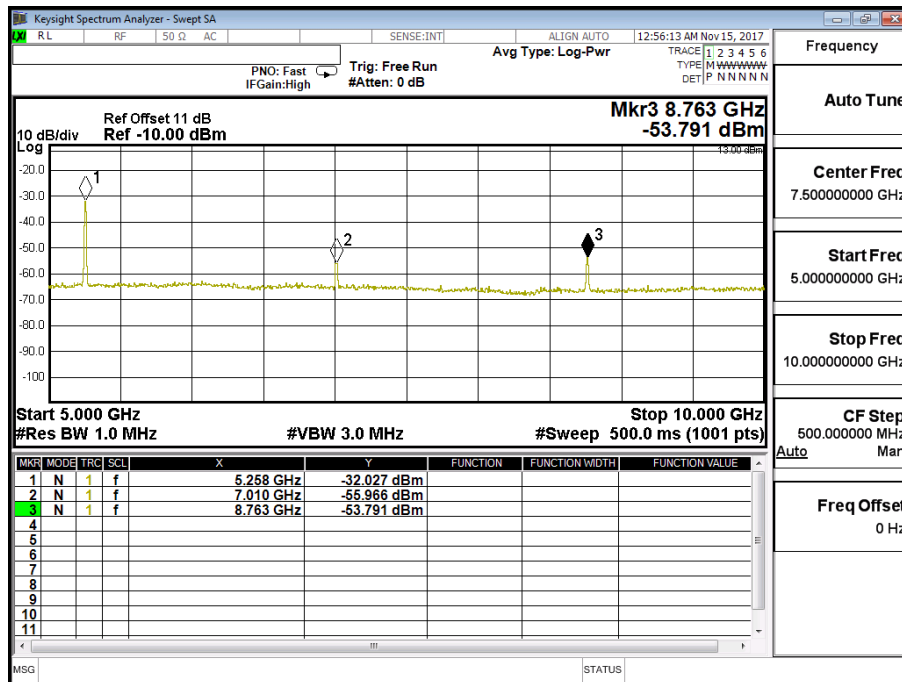

Frequency	Auto Tune
Center Freq	7.500000000 GHz
Start Freq	5.000000000 GHz
Stop Freq	10.000000000 GHz
CF Step	500.0000000 MHz
Auto	Man
Freq Offset	0 Hz

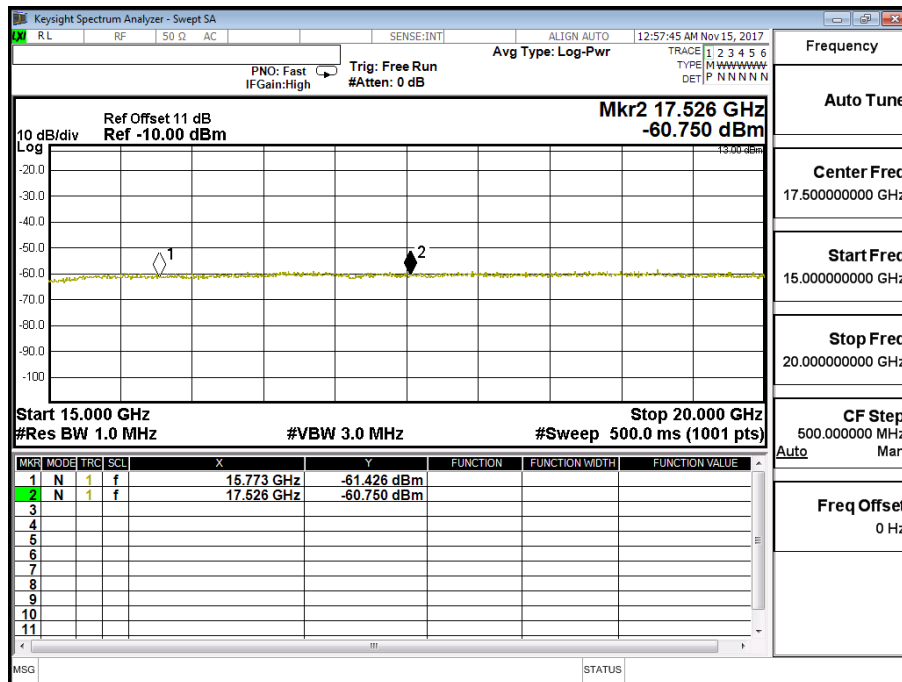
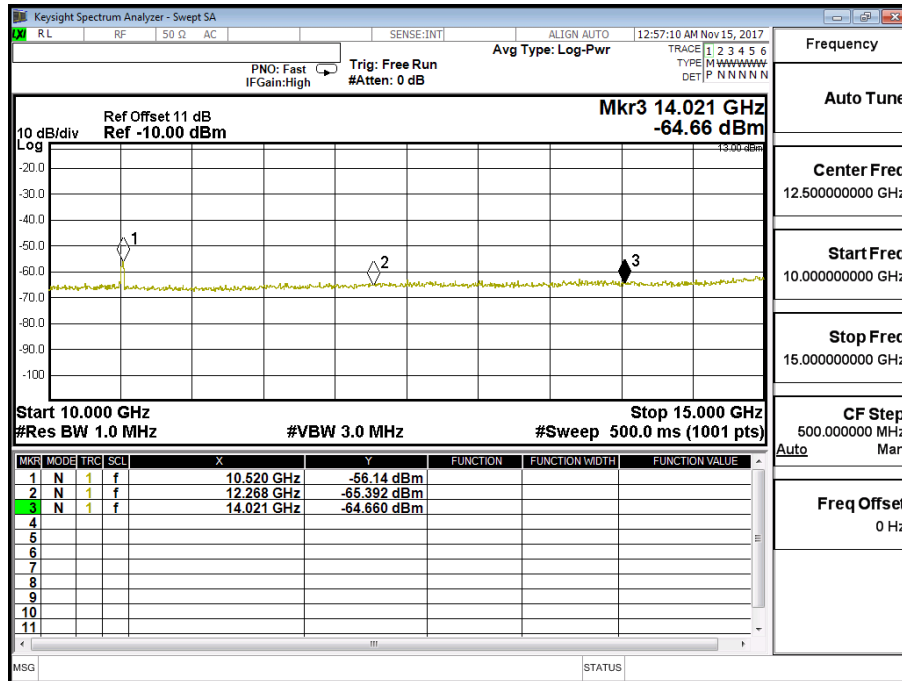

Product	DCM (Data Communication Module)		
Test Mode	Spurious Emission (Conducted)		
Date of Test	2017/11/10	Test Site	CTR
Test Condition	WCDMA BAND 5	Test Range	30MHz~10GHz

WCDMA BAND 5 High-Channel 4233 (846.6MHz)

Frequency (MHz)	Reading Level (dBm)	Path Loss (dB)	Emission Level (dBm)	Limit (dBm)
1696	-54.440	0.58	-53.860	-13
2537	-61.310	0.70	-60.610	-13
3383	-64.130	1.01	-63.120	-13
4228	-54.650	1.18	-53.470	-13
5080	-61.350	1.23	-60.120	-13
5926	-63.298	1.45	-61.848	-13
6773	-64.262	1.56	-62.702	-13
7619	-65.061	1.59	-63.471	-13
8466	-67.357	1.82	-65.537	-13

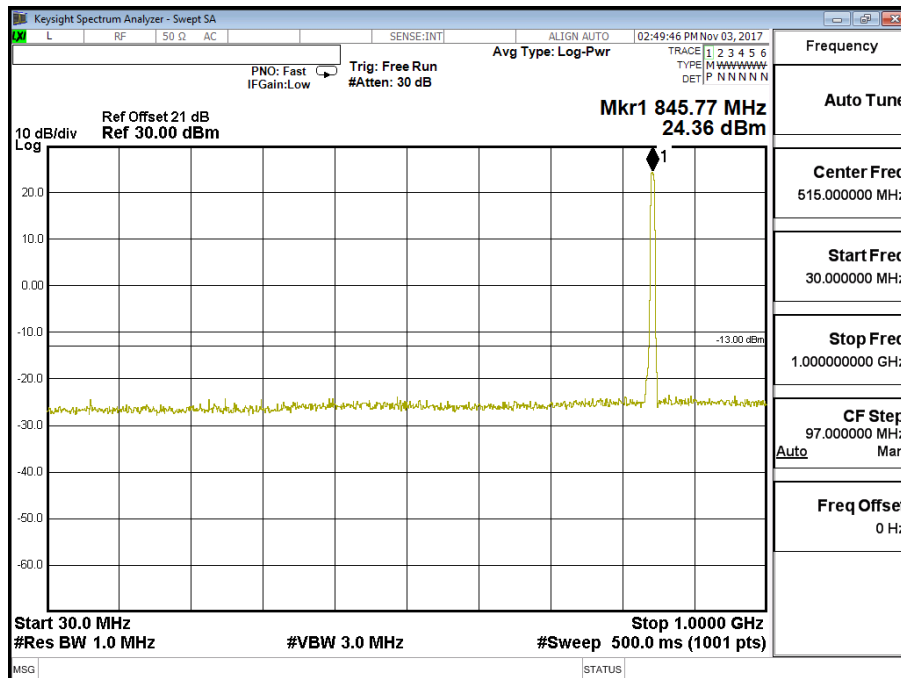

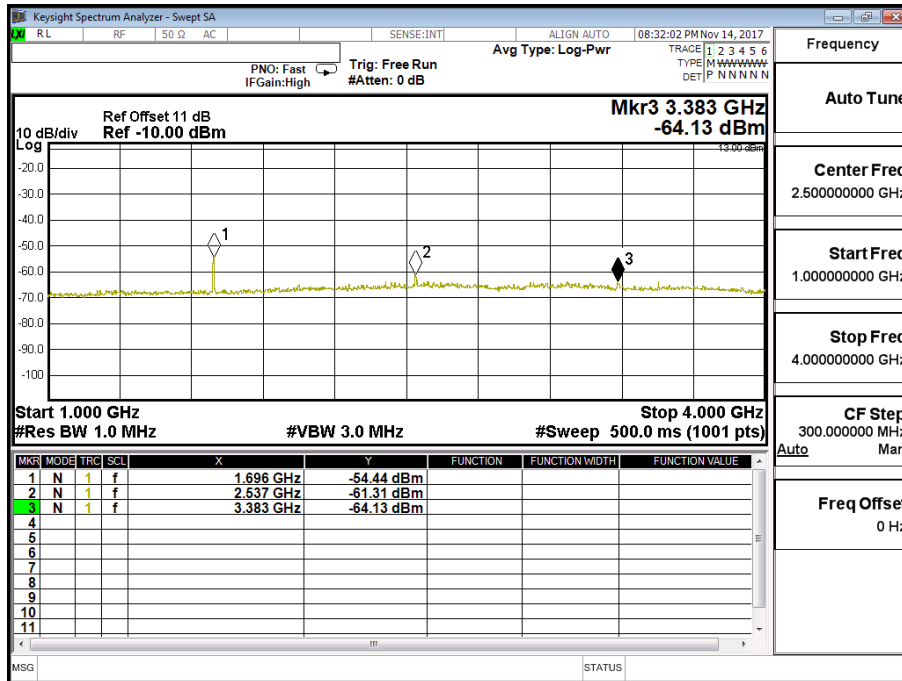

Frequency	
Auto Tune	
Center Freq	2.500000000 GHz
Start Freq	1.000000000 GHz
Stop Freq	4.000000000 GHz
CF Step	300.0000000 MHz
	Auto Man
Freq Offset	0 Hz

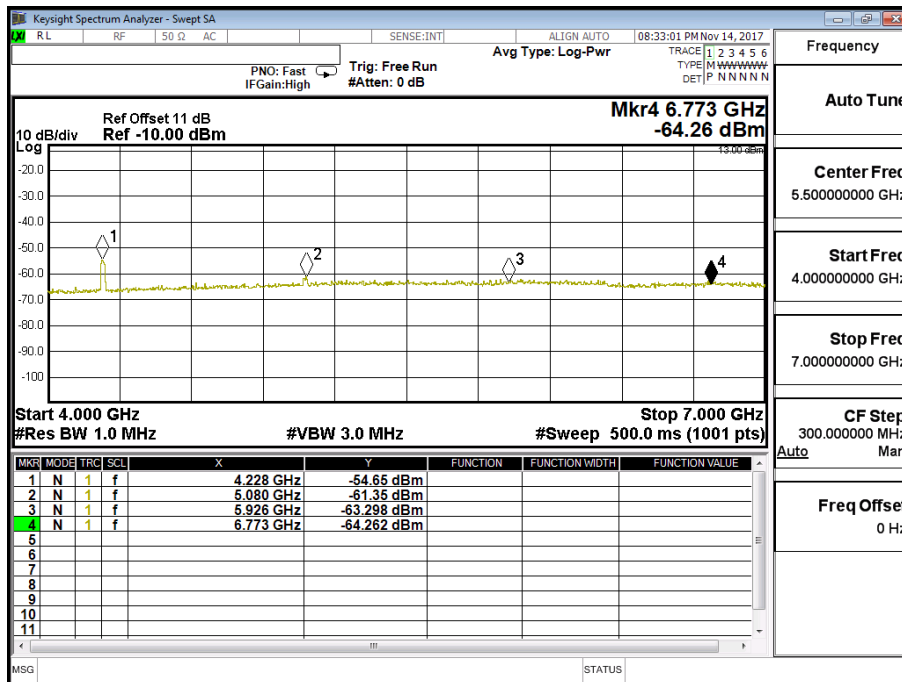

Frequency	
Auto Tune	
Center Freq	5.500000000 GHz
Start Freq	4.000000000 GHz
Stop Freq	7.000000000 GHz
CF Step	300.0000000 MHz
	Auto Man
Freq Offset	0 Hz

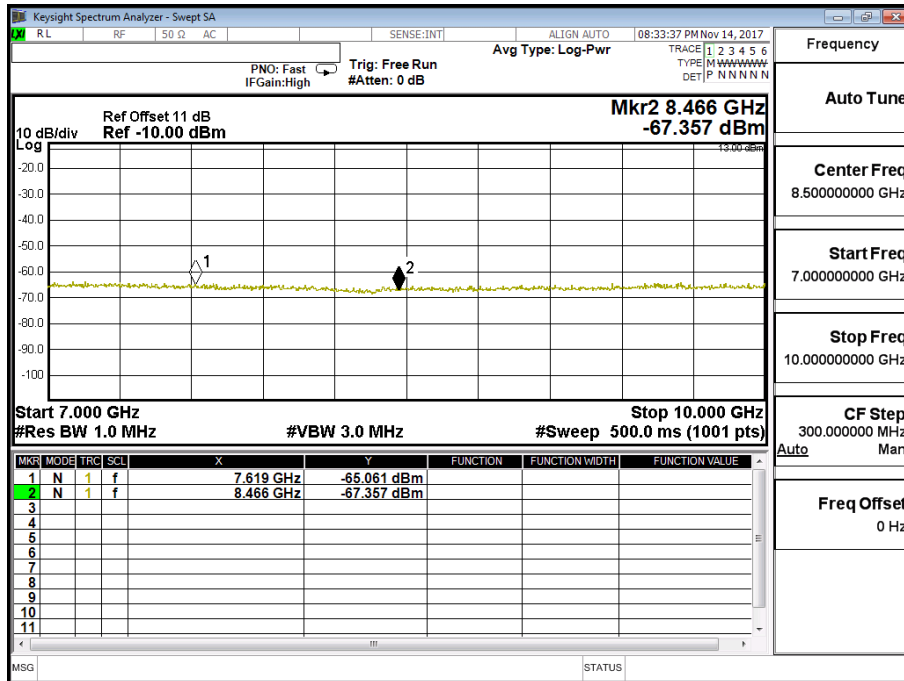

Product	DCM (Data Communication Module)		
Test Mode	Spurious Emission (Radiated) - Multi Band Dipole Antenna (STAF)		
Date of Test	2017/11/15	Test Site	OATS 3
Test Condition	Channel 9538 1907.6MHz (WCDMA BAND 2)	Test Range	9kHz~20GHz

Frequency	Reading Level	Signal Generator Level	Cable Loss	Antenna Gain	EIRP Value	Limit
(GHz)	(dBm)	(dBm)	(dB)	(dBi)	(dBm)	(dBm)

Horizontal Emissions

3815	-55.213	-55.601	2.530	12.600	-45.531	-13
5723	-61.187	-59.101	3.050	13.100	-49.051	-13
7630	-62.853	-48.994	3.650	11.500	-41.144	-13
9538	-62.001	-47.328	3.850	12.000	-39.178	-13
11446	-64.503	-46.059	4.580	12.000	-38.639	-13
13353	-62.665	-42.327	4.800	13.300	-33.827	-13

Vertical Emissions

3815	-58.324	-56.182	2.530	12.600	-46.112	-13
5723	-60.676	-58.483	3.050	13.100	-48.433	-13
7630	-62.821	-48.370	3.650	11.500	-40.520	-13
9538	-62.486	-47.395	3.850	12.000	-39.245	-13
11446	-62.442	-44.022	4.580	12.000	-36.602	-13
13353	-62.843	-42.693	4.800	13.300	-34.193	-13

Note:

1. Receiver setting (Peak Detector) : RBW:1MHz; VBW:3MHz
2. EIRP Value = Signal Generator Level + Antenna Gain - Cable Loss
3. Spurious emissions past 14GHz are not shown, due to the magnitude of spurious emissions attenuated more than 20 dB below the limit.

Product	DCM (Data Communication Module)		
Test Mode	Spurious Emission (Radiated) - Multi Band Dipole Antenna (STAF)		
Date of Test	2017/11/15	Test Site	OATS 3
Test Condition	Channel 1513 1752.6MHz (WCDMA BAND 4)	Test Range	9kHz~20GHz

Frequency	Reading Level	Signal Generator Level	Cable Loss	Antenna Gain	EIRP Value	Limit
(GHz)	(dBm)	(dBm)	(dB)	(dBi)	(dBm)	(dBm)

Horizontal Emissions

3505	-60.413	-60.999	2.530	12.600	-50.929	-13
5258	-55.272	-51.090	3.050	13.100	-41.040	-13
7010	-62.294	-49.473	3.650	11.500	-41.623	-13
8763	-63.062	-46.757	3.850	12.000	-38.607	-13
10516	-63.576	-47.203	4.580	12.000	-39.783	-13
12268	-61.833	-43.975	4.800	13.300	-35.475	-13

Vertical Emissions

3505	-61.819	-61.347	2.530	12.600	-51.277	-13
5258	-58.738	-54.177	3.050	13.100	-44.127	-13
7010	-61.650	-47.946	3.650	11.500	-40.096	-13
8763	-63.344	-46.501	3.850	12.000	-38.351	-13
10516	-63.323	-46.940	4.580	12.000	-39.520	-13
12268	-62.719	-44.960	4.800	13.300	-36.460	-13

Note:

1. Receiver setting (Peak Detector) : RBW:1MHz; VBW:3MHz
2. EIRP Value = Signal Generator Level + Antenna Gain - Cable Loss
3. Spurious emissions past 13GHz are not shown, due to the magnitude of spurious emissions attenuated more than 20 dB below the limit.

Product	DCM (Data Communication Module)		
Test Mode	Spurious Emission (Radiated) - Multi Band Dipole Antenna (STAF)		
Date of Test	2017/11/15	Test Site	OATS 3
Test Condition	Channel 4233 846.6MHz (WCDMA BAND 5)	Test Range	9kHz~10GHz

Frequency	Reading Level	Signal Generator Level	Cable Loss	Antenna Gain	EIRP Value	Limit
(GHz)	(dBm)	(dBm)	(dB)	(dBi)	(dBm)	(dBm)

Horizontal Emissions

1693	-62.517	-65.304	1.630	9.800	-57.134	-13
2540	-60.448	-61.153	2.100	10.600	-52.653	-13
3386	-61.839	-63.392	2.350	12.300	-53.442	-13
4233	-63.528	-61.967	2.700	12.600	-52.067	-13
5080	-62.076	-57.478	2.830	12.700	-47.608	-13
5926	-60.932	-56.899	3.200	13.000	-47.099	-13

Vertical Emissions

1693	-57.816	-60.196	1.630	9.800	-52.026	-13
2540	-60.246	-60.252	2.100	10.600	-51.752	-13
3386	-62.151	-62.565	2.350	12.300	-52.615	-13
4233	-63.491	-60.752	2.700	12.600	-50.852	-13
5080	-61.631	-56.759	2.830	12.700	-46.889	-13
5926	-61.060	-56.918	3.200	13.000	-47.118	-13

Note:

1. Receiver setting (Peak Detector) : RBW:1MHz; VBW:3MHz
2. EIRP Value = Signal Generator Level + Antenna Gain - Cable Loss
3. Spurious emissions past 6 GHz are not shown, due to the magnitude of spurious emissions attenuated more than 20 dB below the limit.

Product	DCM (Data Communication Module)		
Test Mode	Spurious Emission (Radiated) - 4G/3G/2G MIMO-1 Antenna (taogles)		
Date of Test	2017/11/15	Test Site	OATS 3
Test Condition	Channel 9538 1907.6MHz (WCDMA BAND 2)	Test Range	9kHz~20GHz

Frequency	Reading Level	Signal Generator Level	Cable Loss	Antenna Gain	EIRP Value	Limit
(GHz)	(dBm)	(dBm)	(dB)	(dBi)	(dBm)	(dBm)

Horizontal Emissions

3815	-44.129	-44.517	2.530	12.600	-34.447	-13
5723	-58.080	-55.964	3.050	13.100	-45.914	-13
7630	-62.587	-48.728	3.650	11.500	-40.878	-13
9538	-61.853	-47.122	3.850	12.000	-38.972	-13
11446	-63.371	-44.660	4.580	12.000	-37.240	-13
13353	-62.461	-42.313	4.800	13.300	-33.813	-13

Vertical Emissions

3815	-43.785	-41.642	2.530	12.600	-31.572	-13
5723	-55.503	-53.281	3.050	13.100	-43.231	-13
7630	-61.425	-46.974	3.650	11.500	-39.124	-13
9538	-62.622	-47.530	3.850	12.000	-39.380	-13
11446	-63.794	-45.374	4.580	12.000	-37.954	-13
13353	-62.531	-42.426	4.800	13.300	-33.926	-13

Note:

1. Receiver setting (Peak Detector) : RBW:1MHz; VBW:3MHz
2. EIRP Value = Signal Generator Level + Antenna Gain - Cable Loss
3. Spurious emissions past 14 GHz are not shown, due to the magnitude of spurious emissions attenuated more than 20 dB below the limit.

Product	DCM (Data Communication Module)		
Test Mode	Spurious Emission (Radiated) - 4G/3G/2G MIMO-1 Antenna (taogles)		
Date of Test	2017/11/15	Test Site	OATS 3
Test Condition	Channel 1513 1752.6MHz (WCDMA BAND 4)	Test Range	9kHz~20GHz

Frequency	Reading Level	Signal Generator Level	Cable Loss	Antenna Gain	EIRP Value	Limit
(GHz)	(dBm)	(dBm)	(dB)	(dBi)	(dBm)	(dBm)

Horizontal Emissions

3505	-55.039	-55.626	2.530	12.600	-45.556	-13
5258	-51.200	-47.039	3.050	13.100	-36.989	-13
7010	-63.723	-50.902	3.650	11.500	-43.052	-13
8763	-64.249	-47.991	3.850	12.000	-39.841	-13
10516	-62.658	-46.283	4.580	12.000	-38.863	-13
12268	-64.832	-47.016	4.800	13.300	-38.516	-13

Vertical Emissions

3505	-55.847	-55.293	2.530	12.600	-45.223	-13
5258	-52.642	-48.060	3.050	13.100	-38.010	-13
7010	-63.676	-50.292	3.650	11.500	-42.442	-13
8763	-63.185	-46.597	3.850	12.000	-38.447	-13
10516	-62.186	-45.807	4.580	12.000	-38.387	-13
12268	-64.754	-46.994	4.800	13.300	-38.494	-13

Note:

1. Receiver setting (Peak Detector) : RBW:1MHz; VBW:3MHz
2. EIRP Value = Signal Generator Level + Antenna Gain - Cable Loss
3. Spurious emissions past 13 GHz are not shown, due to the magnitude of spurious emissions attenuated more than 20 dB below the limit.

Product	DCM (Data Communication Module)		
Test Mode	Spurious Emission (Radiated) - 4G/3G/2G MIMO-1 Antenna (taogles)		
Date of Test	2017/11/15	Test Site	OATS 3
Test Condition	Channel 4233 846.6MHz (WCDMA BAND 5)	Test Range	9kHz~10GHz

Frequency	Reading Level	Signal Generator Level	Cable Loss	Antenna Gain	EIRP Value	Limit
(GHz)	(dBm)	(dBm)	(dB)	(dBi)	(dBm)	(dBm)

Horizontal Emissions

1693	-53.179	-55.935	1.630	9.800	-47.765	-13
2540	-64.649	-65.453	2.100	10.600	-56.953	-13
3386	-60.370	-61.982	2.350	12.300	-52.032	-13
4233	-62.144	-60.397	2.700	12.600	-50.497	-13
5080	-62.867	-58.269	2.830	12.700	-48.399	-13
5926	-63.878	-59.845	3.200	13.000	-50.045	-13

Vertical Emissions

1693	-52.108	-54.441	1.630	9.800	-46.271	-13
2540	-64.162	-64.168	2.100	10.600	-55.668	-13
3386	-60.345	-60.785	2.350	12.300	-50.835	-13
4233	-61.567	-58.980	2.700	12.600	-49.080	-13
5080	-62.688	-57.816	2.830	12.700	-47.946	-13
5926	-64.030	-59.888	3.200	13.000	-50.088	-13

Note:

1. Receiver setting (Peak Detector) : RBW:1MHz; VBW:3MHz
2. EIRP Value = Signal Generator Level + Antenna Gain - Cable Loss
3. Spurious emissions past 6 GHz are not shown, due to the magnitude of spurious emissions attenuated more than 20 dB below the limit.

7. Frequency Stability Under Temperature & Voltage Variations

7.1. Test Specification

According to Part 2.1055, 22.355, 24.235, 27.54.

7.2. Test Setup

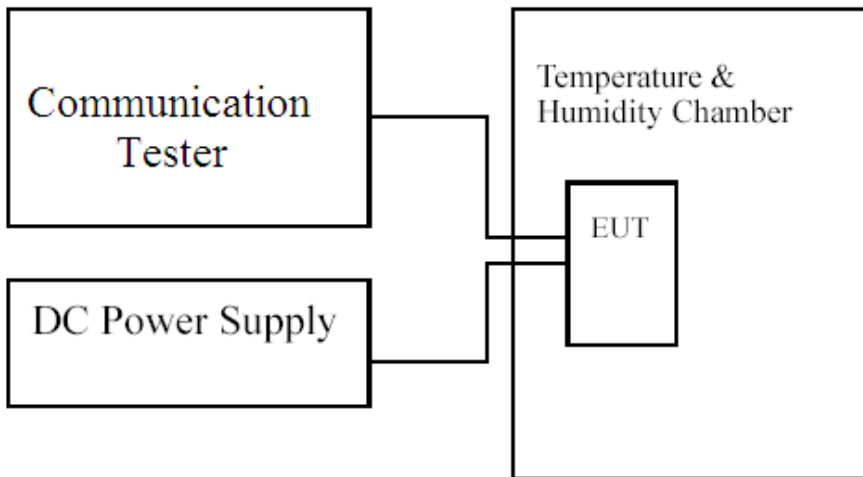

7.3. Limits

Limit	<±2.5ppm
-------	----------

7.4. Test Procedure

The frequency stability of transmitter is measured by:

- (a) Temperature: The temperature is varied from -30 °C to 50 °C in 10 °C increment using a standard temperature & Humidity chamber.
- (b) Primary Supply Voltage: The primary supply voltage is varied 85% to 115% of the nominal value for non hand-carried equipment. For hand-carried, battery-powered equipment, primary supply voltage is reduced to the battery operating endpoint which shall be specified by the manufacturer.

The EUT was connected via the base station simulator. Universal Radio Communication Tester, was used to measure The Frequency Error. The maximum result of measurements was recorded.

7.5. Test Result of Frequency Stability Under Temperature Variations

Product	DCM (Data Communication Module)		
Test Mode	Frequency Stability Under Temperature Variations & Voltage Variations		
Date of Test	2017/11/17	Test Site	CTR
Test Condition	WCDMA BAND 2 / Channel 9400 1880MHz	Test Range	0°C~+35°C

Frequency Stability Under Temperature Variations

Temperature Interval(°C)	Test Frequency (GHz)	Deviation (KHz)	Limit (KHz)
-30	1.88	-0.0049	±4.7
-20	1.88	-0.0063	±4.7
-10	1.88	-0.0045	±4.7
0	1.88	-0.0021	±4.7
10	1.88	0.0049	±4.7
20	1.88	-0.0062	±4.7
35	1.88	-0.0051	±4.7
40	1.88	0.0047	±4.7
50	1.88	-0.0044	±4.7

Note : Test Temperature specified by the manufacturer .

Voltage Variations

DC Voltage (V)	Test Frequency (GHz)	Deviation (KHz)	Limit (KHz)
13.8	1.88	-0.0050	±4.7
12	1.88	-0.0062	±4.7
10.2	1.88	-0.0038	±4.7

Product	DCM (Data Communication Module)		
Test Mode	Frequency Stability Under Temperature Variations & Voltage Variations		
Date of Test	2017/11/17	Test Site	CTR
Test Condition	WCDMA BAND 4 / Channel 1413 1732.6MHz	Test Range	-30°C~+50°C

Frequency Stability Under Temperature Variations

Temperature Interval(°C)	Test Frequency (GHz)	Deviation (KHz)	Limit (KHz)
-30	1.7325	-0.0054	±4.33
-20	1.7325	-0.0032	±4.33
-10	1.7325	-0.0047	±4.33
0	1.7325	-0.0037	±4.33
10	1.7325	0.0036	±4.33
20	1.7325	0.0032	±4.33
30	1.7325	0.0032	±4.33
40	1.7325	0.0038	±4.33
50	1.7325	0.0041	±4.33

Voltage Variations

DC Voltage (V)	Test Frequency (GHz)	Deviation (KHz)	Limit (KHz)
13.8	1.7325	-0.0035	±4.33
12	1.7325	0.0032	±4.33
10.2	1.7325	-0.0033	±4.33

Product	DCM (Data Communication Module)		
Test Mode	Frequency Stability Under Temperature Variations & Voltage Variations		
Date of Test	2017/11/17	Test Site	CTR
Test Condition	WCDMA BAND 5 / Channel 4183 836.6MHz	Test Range	0°C~+35°C

Frequency Stability Under Temperature Variations

Temperature Interval(°C)	Test Frequency (GHz)	Deviation (KHz)	Limit (KHz)
-30	0.8366	-0.0038	±2.09
-20	0.8366	-0.0039	±2.09
-10	0.8366	-0.0042	±2.09
0	0.8366	-0.0023	±2.09
10	0.8366	0.0023	±2.09
20	0.8366	-0.0029	±2.09
33	0.8366	-0.0034	±2.09
40	0.8366	-0.0024	±2.09
50	0.8366	-0.0023	±2.09

Note : Test Temperature specified by the manufacturer .

Voltage Variations

DC Voltage (V)	Test Frequency (GHz)	Deviation (KHz)	Limit (KHz)
13.8	0.8366	-0.0029	±2.09
12	0.8366	-0.0029	±2.09
10.2	0.8366	-0.0032	±2.09

7. EMI Reduction Method During Compliance Testing

No modification was made during testing.

8. Peak to Average Ratio

8.1 Test Specification

According to Part 22.913, 24.232, 27.50.

8.2 Test Setup

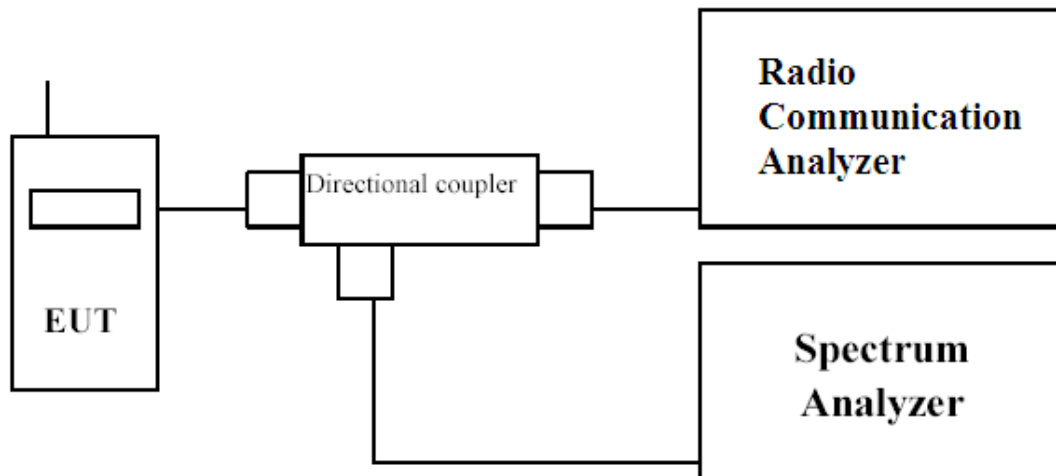

8.3 Limits

The peak-to-average power ratio (PAPR) of the transmitter output power must not exceed 13 dB. The PAPR measurements should be made using either an instrument with complementary cumulative distribution function (CCDF) capabilities to determine that PAPR will not exceed 13 dB for more than 0.1 percent of the time or other Commission approved procedure.

8.4 Test Procedure

- a) Refer to instrument's analyzer instruction manual for details on how to use the power statistics/CCDF function;
- b) Set resolution/measurement bandwidth \geq signal's occupied bandwidth;
- c) Set the number of counts to a value that stabilizes the measured CCDF curve;
- d) Set the measurement interval as follows:
 - 1) for continuous transmissions, set to 1 ms,
 - 2) for burst transmissions, employ an external trigger that is synchronized with the EUT burst timing sequence, or use the internal burst trigger with a trigger level that allows the burst to stabilize and set the measurement interval to a time that is less than or equal to the burst duration.
- e) Record the maximum PAPR level associated with a probability of 0.1%.

Product	DCM (Data Communication Module)		
Test Mode	Peak to Average Ratio		
Date of Test	2017/11/03	Test Site	CTR
Test Condition	WCDMA BAND 2		

WCDMA BAND 2 Channel 9400 1880MHz

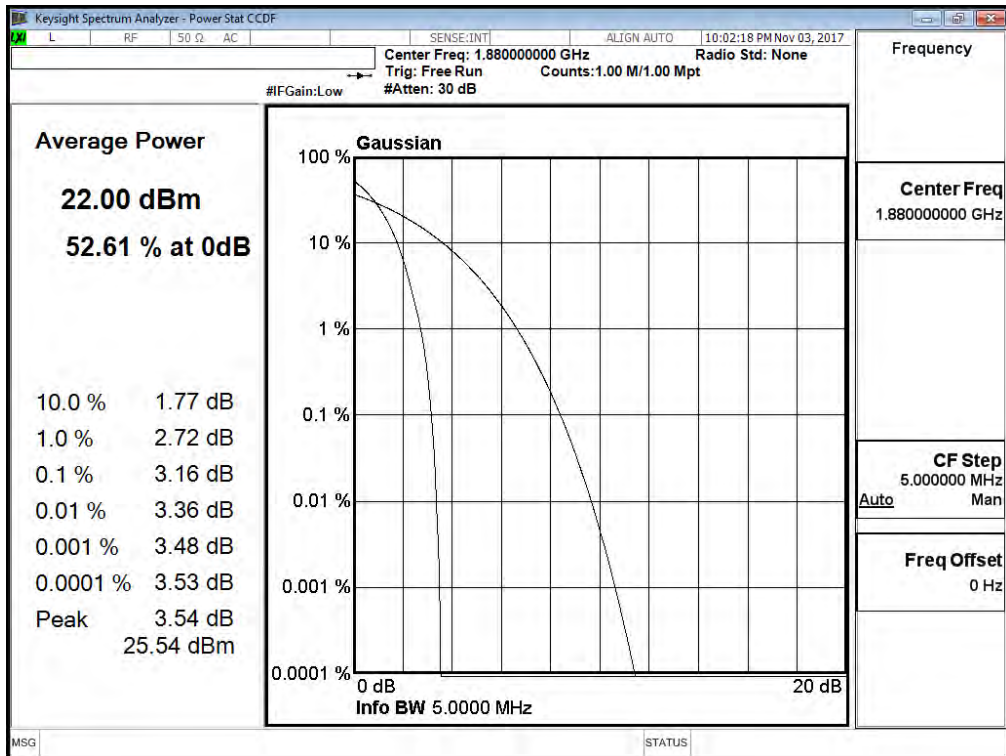

Product	DCM (Data Communication Module)		
Test Mode	Peak to Average Ratio		
Date of Test	2017/11/03	Test Site	CTR
Test Condition	WCDMA BAND 4		

WCDMA BAND 4 Channel 1413 1732.6MHz

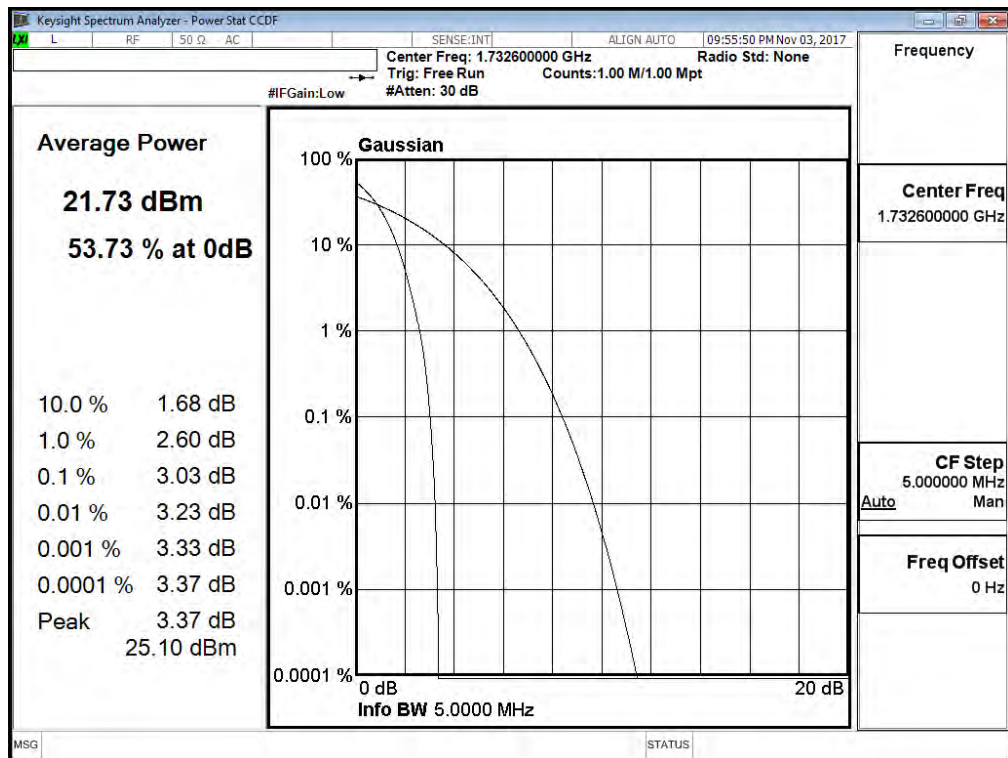

Product	DCM (Data Communication Module)		
Test Mode	Peak to Average Ratio		
Date of Test	2017/11/03	Test Site	CTR
Test Condition	WCDMA BAND 5		

WCDMA BAND 5 Channel 4183 836.6MHz

