



FCC TEST REPORT (PART 24)

REPORT NO.: RF141119C42

MODEL NO.: 9961 Home Cell V1

FCC ID: H8N9961V1

RECEIVED: Nov. 19, 2014

TESTED: Dec. 09 ~ Dec. 12, 2014

ISSUED: Dec. 15, 2014

APPLICANT: ASKEY COMPUTER CORP.

ADDRESS: 10F, NO.119, JIANKANG RD., ZHONGHE DIST.,
NEW TAIPEI CITY 23585, TAIWAN, R.O.C.

ISSUED BY: Bureau Veritas Consumer Products Services
(H.K.) Ltd., Taoyuan Branch

LAB ADDRESS: No. 47-2, 14th Ling, Chia Pau Vil., Lin Kou Dist.,
New Taipei City, Taiwan (R.O.C.)

TEST LOCATION: No. 19, Hwa Ya 2nd Rd, Wen Hwa Tsuen, Kwei
Shan Hsiang, Taoyuan Hsien 333, Taiwan, R.O.C.

This report should not be used by the client to claim product certification, approval, or endorsement by TAF or any government agencies.



This report is for your exclusive use. Any copying or replication of this report to or for any other person or entity, or use of our name or trademark, is permitted only with our prior written permission. This report sets forth our findings solely with respect to the test samples identified herein. The results set forth in this report are not indicative or representative of the quality or characteristics of the lot from which a test sample was taken or any similar or identical product unless specifically and expressly noted. Our report includes all of the tests requested by you and the results thereof based upon the information that you provided to us. You have 60 days from date of issuance of this report to notify us of any material error or omission caused by our negligence, provided, however, that such notice shall be in writing and shall specifically address the issue you wish to raise. A failure to raise such issue within the prescribed time shall constitute your unqualified acceptance of the completeness of this report, the tests conducted and the correctness of the report contents. Unless specific mention, the uncertainty of measurement has been explicitly taken into account to declare the compliance or non-compliance to the specification.



TABLE OF CONTENTS

RELEASE CONTROL RECORD	4
1 CERTIFICATION	5
2 SUMMARY OF TEST RESULTS	6
2.1 MEASUREMENT UNCERTAINTY	6
2.2 TEST INSTRUMENTS	7
3 GENERAL INFORMATION	8
3.1 GENERAL DESCRIPTION OF EUT	8
3.2 CONFIGURATION OF SYSTEM UNDER TEST	9
3.3 DESCRIPTION OF SUPPORT UNITS	9
3.4 DESCRIPTION OF TEST MODES	10
3.5 EUT OPERATING CONDITIONS	11
3.6 GENERAL DESCRIPTION OF APPLIED STANDARDS	11
4 TEST TYPES AND RESULTS	12
4.1 OUTPUT POWER MEASUREMENT	12
4.1.1 LIMITS OF OUTPUT POWER MEASUREMENT	12
4.1.2 TEST PROCEDURES	12
4.1.3 TEST SETUP	13
4.1.4 TEST RESULTS	14
4.2 FREQUENCY STABILITY MEASUREMENT	15
4.2.1 LIMITS OF FREQUENCY STABILITY MEASUREMENT	15
4.2.2 TEST PROCEDURE	15
4.2.3 TEST SETUP	15
4.2.4 TEST RESULTS	16
4.3 OCCUPIED BANDWIDTH MEASUREMENT	17
4.3.1 TEST PROCEDURES	17
4.3.2 TEST SETUP	17
4.3.3 TEST RESULTS	18
4.4 PEAK TO AVERAGE RATIO	19
4.4.1 LIMITS OF PEAK TO AVERAGE RATIO MEASUREMENT	19
4.4.2 TEST SETUP	19
4.4.3 TEST PROCEDURES	19
4.4.4 TEST RESULTS	20
4.5 BAND EDGE MEASUREMENT	21
4.5.1 LIMITS OF BAND EDGE MEASUREMENT	21
4.5.2 TEST SETUP	21



A D T

4.5.3	TEST PROCEDURES	21
4.5.4	TEST RESULTS	22
4.6	CONDUCTED SPURIOUS EMISSIONS	23
4.6.1	LIMITS OF CONDUCTED SPURIOUS EMISSIONS MEASUREMENT.....	23
4.6.2	TEST PROCEDURE.....	23
4.6.3	TEST SETUP.....	23
4.6.4	TEST RESULTS	24
4.7	RADIATED EMISSION MEASUREMENT	27
4.7.1	LIMITS OF RADIATED EMISSION MEASUREMENT	27
4.7.2	TEST PROCEDURES	27
4.7.3	DEVIATION FROM TEST STANDARD.....	27
4.7.4	TEST SETUP.....	28
4.7.5	TEST RESULTS	29
5	PHOTOGRAPHS OF THE TEST CONFIGURATION.....	33
6	INFORMATION ON THE TESTING LABORATORIES	34
7	APPENDIX A – MODIFICATIONS RECORDERS FOR ENGINEERING CHANGES TO THE EUT BY THE LAB	35



RELEASE CONTROL RECORD

ISSUE NO.	REASON FOR CHANGE	DATE ISSUED
RF141119C42	Original release	Dec. 15, 2014



1 CERTIFICATION

PRODUCT: Femtocell
MODEL NO.: 9961 Home Cell V1
BRAND: Askey
APPLICANT: ASKEY COMPUTER CORP.
TEST SAMPLE: ENGINEERING SAMPLE
TESTED: Dec. 09 ~ Dec. 12, 2014
TEST STANDARDS: FCC Part 24, Subpart E
FCC Part 2

The above equipment (model: 9961 Home Cell V1) has been tested by **Bureau Veritas Consumer Products Services (H.K.) Ltd., Taoyuan Branch**, and found compliance with the requirement of the above standards. The test record, data evaluation & Equipment Under Test (EUT) configurations represented herein are true and accurate accounts of the measurements of the sample's EMC characteristics under the conditions specified in this report.

PREPARED BY :  , **DATE :** Dec. 15, 2014
Pettie Chen / Senior Specialist

APPROVED BY :  , **DATE :** Dec. 15, 2014
Dylan Chiou / Project Engineer

2 SUMMARY OF TEST RESULTS

The EUT has been tested according to the following specifications:

STANDARD SECTION	TEST TYPE AND LIMIT	RESULT	REMARK
2.1046 24.232	Equivalent isotropically radiated power	PASS	Meet the requirement of limit.
2.1055 24.235	Frequency Stability	PASS	Meet the requirement of limit.
2.1049 24.238(b)	Occupied Bandwidth	PASS	Meet the requirement of limit.
24.238(b)	Band Edge Measurements	PASS	Meet the requirement of limit.
2.1051 24.238	Conducted Spurious Emissions	PASS	Meet the requirement of limit.
2.1053 24.238	Radiated Spurious Emissions	PASS	Meet the requirement of limit. Minimum passing margin is -4.17dB at 3864.8MHz.

2.1 MEASUREMENT UNCERTAINTY

Where relevant, the following measurement uncertainty levels have been estimated for tests performed on the EUT as specified in CISPR 16-4-2:

MEASUREMENT	FREQUENCY	UNCERTAINTY
Conducted emissions	9kHz~30MHz	2.44 dB
Radiated emissions	30MHz ~ 200MHz	3.59 dB
	200MHz ~1000MHz	3.60 dB
	1GHz ~ 18GHz	2.29 dB
	18GHz ~ 40GHz	2.29 dB

This uncertainty represents an expanded uncertainty expressed at approximately the 95% confidence level using a coverage factor of $k=2$.



2.2 TEST INSTRUMENTS

DESCRIPTION & MANUFACTURER	MODEL NO.	SERIAL NO.	DATE OF CALIBRATION	DUE DATE OF CALIBRATION
Test Receiver ROHDE & SCHWARZ	ESCI	100424	Oct. 06, 2014	Oct. 05, 2015
Spectrum Analyzer ROHDE & SCHWARZ	FSU 43	100115	Dec. 18, 2013	Dec. 17, 2014
BILOG Antenna SCHWARZBECK	VULB9168	9168-155	Feb. 26, 2014	Feb. 25, 2015
HORN Antenna SCHWARZBECK	BBHA 9120D	9120D-404	Jan. 05, 2014	Jan. 04, 2015
HORN Antenna SCHWARZBECK	BBHA 9170	BBHA9170241	Feb. 17, 2014	Feb. 16, 2015
Preamplifier Agilent	8449B	3008A01961	Oct. 18, 2014	Oct. 17, 2015
Preamplifier Agilent	8447D	2944A10738	Oct. 18, 2014	Oct. 17, 2015
RF signal cable HUBER+SUHNNER	SUCOFLEX 104	309220/4	Aug. 09, 2014	Aug. 08, 2015
RF signal cable HUBER+SUHNNER	SUCOFLEX 104	250724/4	Aug. 09, 2014	Aug. 08, 2015
RF signal cable HUBER+SUHNNER	SUCOFLEX 104	295012/4	Aug. 09, 2014	Aug. 08, 2015
Software BV ADT	ADT_Radiated_ V7.6.15.9.4	NA	NA	NA
Antenna Tower inn-co GmbH	MA 4000	010303	NA	NA
Antenna Tower Controller inn-co GmbH	CO2000	019303	NA	NA
Turn Table BV ADT	TT100.	TT93021704	NA	NA
Turn Table Controller BV ADT	SC100.	SC93021704	NA	NA
Mini-Circuits Power Splitter	ZN2PD-9G	NA	Apr. 25, 2014	Apr. 24, 2015
JFW 20dB attenuation	50HF-020-SMA	NA	NA	NA

- NOTE:**
1. The calibration interval of the above test instruments is 12 months and the calibrations are traceable to NML/ROC and NIST/USA.
 2. The test was performed in HwaYa Chamber 4.
 3. The horn antenna and HP preamplifier (model: 8449B) are used only for the measurement of emission frequency above 1GHz if tested.
 4. The FCC Site Registration No. is 460141.
 5. The IC Site Registration No. is IC7450F-4.

3 GENERAL INFORMATION

3.1 GENERAL DESCRIPTION OF EUT

EUT	Femtocell	
MODEL NO.	9961 Home Cell V1	
POWER SUPPLY	12Vdc (Adapter)	
MODULATION TYPE	WCDMA	BPSK
FREQUENCY RANGE	WCDMA Band 2 (Channel Bandwidth: 5MHz)	1932.4MHz ~ 1987.6MHz
MAX. EIRP POWER	WCDMA Band 2 (Channel Bandwidth: 5MHz)	329.610mW (25.18dBm)
EMISSION DESIGNATOR	WCDMA Band 2 (Channel Bandwidth: 5MHz)	4M18F9W
WCDMA RELEASE VERSION	4	
ANTENNA TYPE	Ch 9662: Dipole antenna with 4.37dBi gain Ch 9800: Dipole antenna with 3.97dBi gain Ch 9938: Dipole antenna with 3.64dBi gain	
ANTENNA CONNECTOR	I-PEX(MHF)	
DATA CABLE	4.572m GPS antenna (Cable Type: RG-174 Coaxial Cable (shielded)) 1.8m Ethernet cable (non-shielded)	
I/O PORTS	Refer to user's manual	
ACCESSORY DEVICES	Adapter	

NOTE:

- The EUT uses following adapters.

Adapter 1	
Brand	AOEM
Model	ADS0248-W 120200
Input Power	100-240Vac~50-60Hz, 0.6A
Output Power	12Vdc, 2.0A
Power Line	1.5m cable without core attached on adapter

Adapter 2	
Brand	Phihong
Model	PSAC24A-120
Input Power	100-240Vac~50/60Hz, 0.6A
Output Power	12Vdc, 2.0A
Power Line	1.8m cable without core attached on adapter

- The above EUT information is declared by manufacturer and for more detailed feature description, please refer to the manufacturer's specifications or User's Manual.

3.2 CONFIGURATION OF SYSTEM UNDER TEST

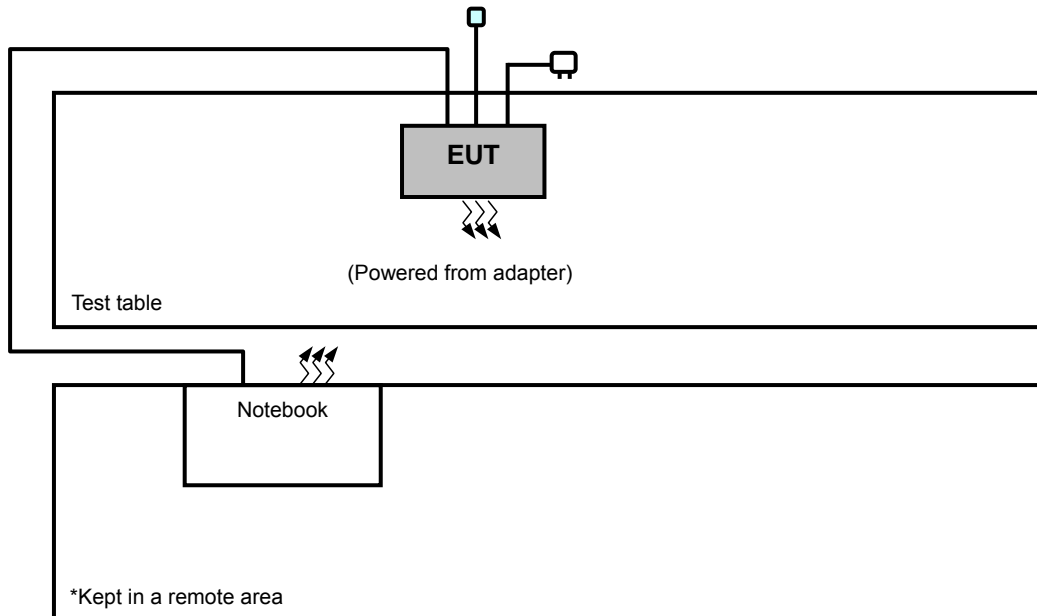

3.3 DESCRIPTION OF SUPPORT UNITS

The EUT has been tested as an independent unit together with other necessary accessories or support units. The following support units or accessories were used to form a representative test configuration during the tests.

NO.	PRODUCT	BRAND	MODEL NO.	SERIAL NO.	FCC ID
1	Notebook	DELL	E5430	FKKCYW1	FCC DoC Approved

NO.	SIGNAL CABLE DESCRIPTION OF THE ABOVE SUPPORT UNITS
1	10m RJ45 UTP cable

NOTE:

1. All power cords of the above support units are non-shielded (1.8m).

3.4 DESCRIPTION OF TEST MODES

Pre-Scan has been conducted to determine the worst-case mode from all possible combinations between available modulations, data rates, XYZ axis and antenna ports. The worst cases were found when positioned on **Z-plane**. Following channel(s) was (were) selected for the final test as listed below:

Test results are presented in the report as below.

Test Mode	Test Condition
A	Power from adapter 1
B	Power from adapter 2

WCDMA Band 2

TEST MODE	TEST ITEM	AVAILABLE CHANNEL	TESTED CHANNEL	CHANNEL BANDWIDTH	MODULATION
A	EIRP	9662 to 9938	9662, 9800, 9938	5MHz	BPSK
A	FREQUENCY STABILITY	9662 to 9938	9800	5MHz	BPSK
A	OCCUPIED BANDWIDTH	9662 to 9938	9662, 9800, 9938	5MHz	BPSK
A	PEAK TO AVERAGE RATIO	9662 to 9938	9662, 9800, 9938	5MHz	BPSK
A	BAND EDGE	9662 to 9938	9662, 9938	5MHz	BPSK
A	CONDCUDED EMISSION	9662 to 9938	9662, 9800, 9938	5MHz	BPSK
A, B	RADIATED EMISSION Below 1GHz	9662 to 9938	9800	5MHz	BPSK
A	RADIATED EMISSION Above 1GHz	9662 to 9938	9662, 9800, 9938	5MHz	BPSK

TEST CONDITION:

TEST ITEM	ENVIRONMENTAL CONDITIONS	INPUT POWER (SYSTEM)	TESTED BY
EIRP	24deg. C, 64%RH	120Vac, 60Hz	Match Tsui
FREQUENCY STABILITY	24deg. C, 64%RH	120Vac, 60Hz	Match Tsui
OCCUPIED BANDWIDTH	24deg. C, 64%RH	120Vac, 60Hz	Match Tsui
PEAK TO AVERAGE RATIO	24deg. C, 64%RH	120Vac, 60Hz	Match Tsui
BAND EDGE	24deg. C, 64%RH	120Vac, 60Hz	Match Tsui
CONDCUDED EMISSION	24deg. C, 64%RH	120Vac, 60Hz	Match Tsui
RADIATED EMISSION	25deg. C, 65%RH	120Vac, 60Hz	Chris Lin



3.5 EUT OPERATING CONDITIONS

The EUT makes a call to the communication simulator. The communication simulator station system controlled a EUT to export maximum output power under transmission mode and specific channel frequency

3.6 GENERAL DESCRIPTION OF APPLIED STANDARDS

The EUT is a RF product. According to the specifications of the manufacturer, it must comply with the requirements of the following standards:

FCC 47 CFR Part 2

FCC 47 CFR Part 24

ANSI/TIA/EIA-603-C 2004

All test items have been performed and recorded as per the above standards.

NOTE: The EUT is also considered as a kind of computer peripheral, because the connection to computer is necessary for typical use. It has been verified to comply with the requirements of FCC Part 15, Subpart B, Class B (DoC). The test report has been issued separately.

4 TEST TYPES AND RESULTS

4.1 OUTPUT POWER MEASUREMENT

4.1.1 LIMITS OF OUTPUT POWER MEASUREMENT

Mobile and portable stations are limited to 2 watts EIRP

4.1.2 TEST PROCEDURES

EIRP MEASUREMENT:

- a. All measurements were done at low, middle and high operational frequency range. RWB and VBW is 10MHz for WCDMA mode.
- b. Substitution method is used for E.I.R.P measurement. In the semi-anechoic chamber, EUT placed on the 0.8m height of Turn Table, rotated the table around 360 degrees to search the maximum radiation power and receiver antenna shall be rotated vertical and horizontal polarization and moved height from 1m to 4m to find the maximum polar radiated power. The “Read Value” is the spectrum reading the maximum power value.
- c. The substitution horn antenna is substituted for EUT at the same position and signals generator export the CW signal to the substitution antenna via a tx cable. Rotated the Turn Table and moved receiving antenna to find the maximum radiation power. Adjust output power level of S.G to get a Value of spectrum reading equal to “Read Value” of step c. Record the power level of S.G
- d. $EIRP = \text{Output power level of S.G} - \text{TX cable loss} + \text{Antenna gain of substitution horn.}$

CONDUCTED POWER MEASUREMENT:

The EUT was set up for the maximum power with WCDMA link data modulation and link up with simulator. Set the EUT to transmit under low, middle and high channel and record the power level shown on simulator.

4.1.3 TEST SETUP

EIRP POWER MEASUREMENT:

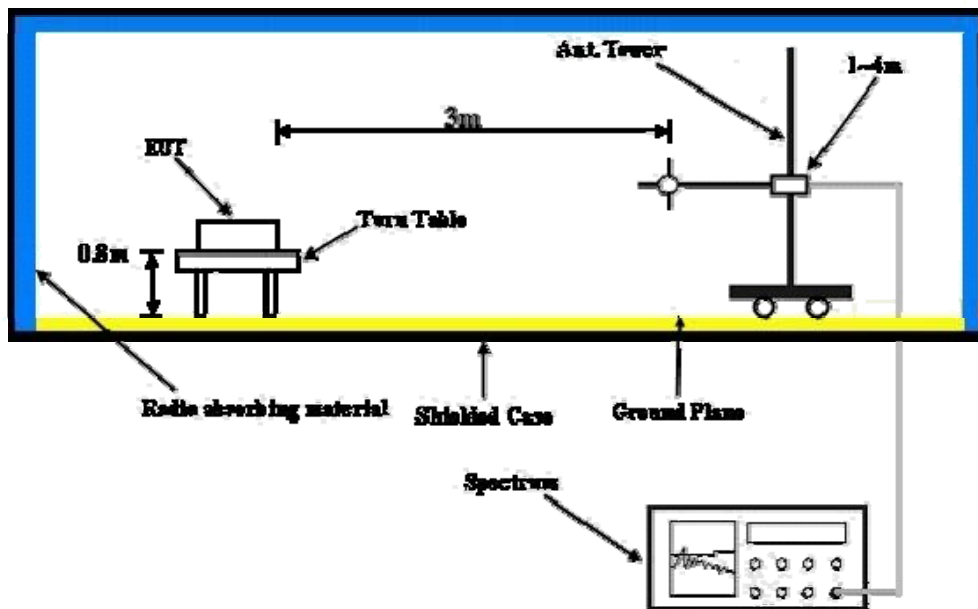

For the actual test configuration, please refer to the attached file (Test Setup Photo).

CONDUCTED POWER MEASUREMENT:

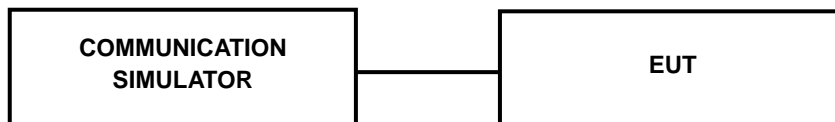

For the actual test configuration, please refer to the attached file (Test Setup Photo).

4.1.4 TEST RESULTS

CONDUCTED OUTPUT POWER (dBm)

Band	WCDMA		
Channel	9662	9800	9938
Frequency	1932.4	1960	1987.6
BPSK	20.75	21.71	20.65

EIRP POWER

WCDMA Band 2 (Channel Bandwidth 5MHz)

MODE		TX channel 9662					
ANTENNA POLARITY & TEST DISTANCE: HORIZONTAL AT 3 M							
No.	Freq. (MHz)	Reading (dBm)	S.G Power Value (dBm)	Correction Factor (dB)	EIRP (dBm)	Limit (dBm)	Margin (dB)
1	1932.4	-14.74	23.86	0.77	24.63	33.00	-8.37
ANTENNA POLARITY & TEST DISTANCE: VERTICAL AT 3 M							
No.	Freq. (MHz)	Reading (dBm)	S.G Power Value (dBm)	Correction Factor (dB)	EIRP (dBm)	Limit (dBm)	Margin (dB)
1	1932.4	-20.95	16.82	0.77	17.59	33.00	-15.41

MODE		TX channel 9800					
ANTENNA POLARITY & TEST DISTANCE: HORIZONTAL AT 3 M							
No.	Freq. (MHz)	Reading (dBm)	S.G Power Value (dBm)	Correction Factor (dB)	EIRP (dBm)	Limit (dBm)	Margin (dB)
1	1960.0	-14.18	24.42	0.76	25.18	33.00	-7.82
ANTENNA POLARITY & TEST DISTANCE: VERTICAL AT 3 M							
No.	Freq. (MHz)	Reading (dBm)	S.G Power Value (dBm)	Correction Factor (dB)	EIRP (dBm)	Limit (dBm)	Margin (dB)
1	1960.0	-20.79	17.15	0.76	17.91	33.00	-15.09

MODE		TX channel 9938					
ANTENNA POLARITY & TEST DISTANCE: HORIZONTAL AT 3 M							
No.	Freq. (MHz)	Reading (dBm)	S.G Power Value (dBm)	Correction Factor (dB)	EIRP (dBm)	Limit (dBm)	Margin (dB)
1	1987.6	-15.56	23.03	0.76	23.79	33.00	-9.21
ANTENNA POLARITY & TEST DISTANCE: VERTICAL AT 3 M							
No.	Freq. (MHz)	Reading (dBm)	S.G Power Value (dBm)	Correction Factor (dB)	EIRP (dBm)	Limit (dBm)	Margin (dB)
1	1987.6	-21.96	16.14	0.76	16.90	33.00	-16.10

NOTE: Power Value (dBm) = S.G Power Value (dBm) + Correction Factor (dB).

4.2 FREQUENCY STABILITY MEASUREMENT

4.2.1 LIMITS OF FREQUENCY STABILITY MEASUREMENT

The frequency stability shall be sufficient to ensure that the fundamental emission stays within the authorized frequency block.

4.2.2 TEST PROCEDURE

- a. Device is placed at the oven room. The oven room could control the temperatures and humidity. Power warm up is at least 15 min and power applied should perform before recording frequency error.
- b. EUT is connected the external power supply to control the AC input power. The test voltage range is from minimum to maximum working voltage. Each step shall be record the frequency error rate.
- c. The temperature range step is 10 degrees in this test items. All temperature levels shall be hold the $\pm 0.5^{\circ}\text{C}$ during the measurement testing. The each temperature step shall be at least 0.5 hours, consider the EUT could be test under the stability condition.

NOTE: The frequency error was recorded frequency error from the communication simulator.

4.2.3 TEST SETUP

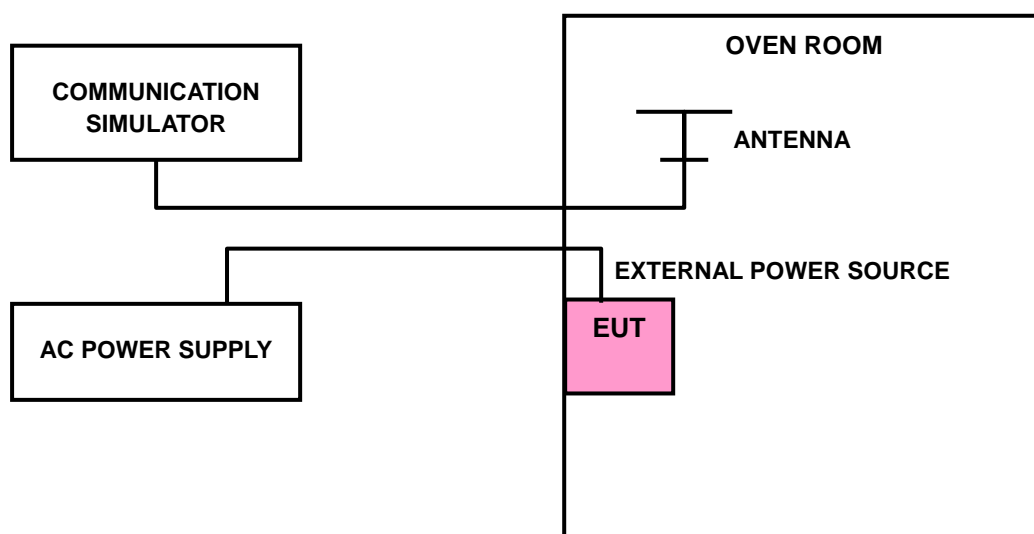



4.2.4 TEST RESULTS

FREQUENCY ERROR VS. VOLTAGE

VOLTAGE (Volts)	FREQUENCY ERROR (ppm)		LIMIT (ppm)
	WCDMA Band 2		
	5MHz		
132	-0.007		2.5
120	-0.007		2.5
108	-0.007		2.5

NOTE: The applicant defined the normal working voltage of the battery is from 108Vac to 132Vac.

FREQUENCY ERROR vs. TEMPERATURE

TEMP. (°C)	FREQUENCY ERROR (ppm)		LIMIT (ppm)
	WCDMA Band 2		
	5MHz		
50	-0.010		2.5
40	-0.009		2.5
30	-0.008		2.5
20	-0.007		2.5
10	-0.009		2.5
0	-0.010		2.5
-10	-0.012		2.5
-20	-0.015		2.5

4.3 OCCUPIED BANDWIDTH MEASUREMENT

4.3.1 TEST PROCEDURES

The EUT makes a call to the communication simulator. All measurements were done at low, middle and high operational frequency range. The communication simulator station system controlled a EUT to export maximum output power under transmission mode and specific channel frequency. Use OBW measurement function of Spectrum analyzer to measure 99 % occupied bandwidth.

4.3.2 TEST SETUP

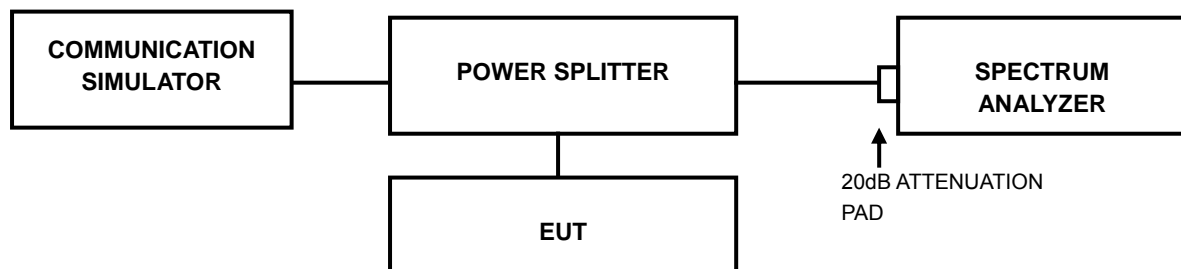

4.3.3 TEST RESULTS

WCDMA Band 2

CHANNEL BANDWIDTH 5MHz		
CHANNEL	FREQUENCY (MHz)	99% OCCUPIED BANDWIDTH (MHz)
		BPSK
9662	1932.4	4.17
9800	1960	4.18
9938	1987.6	4.15

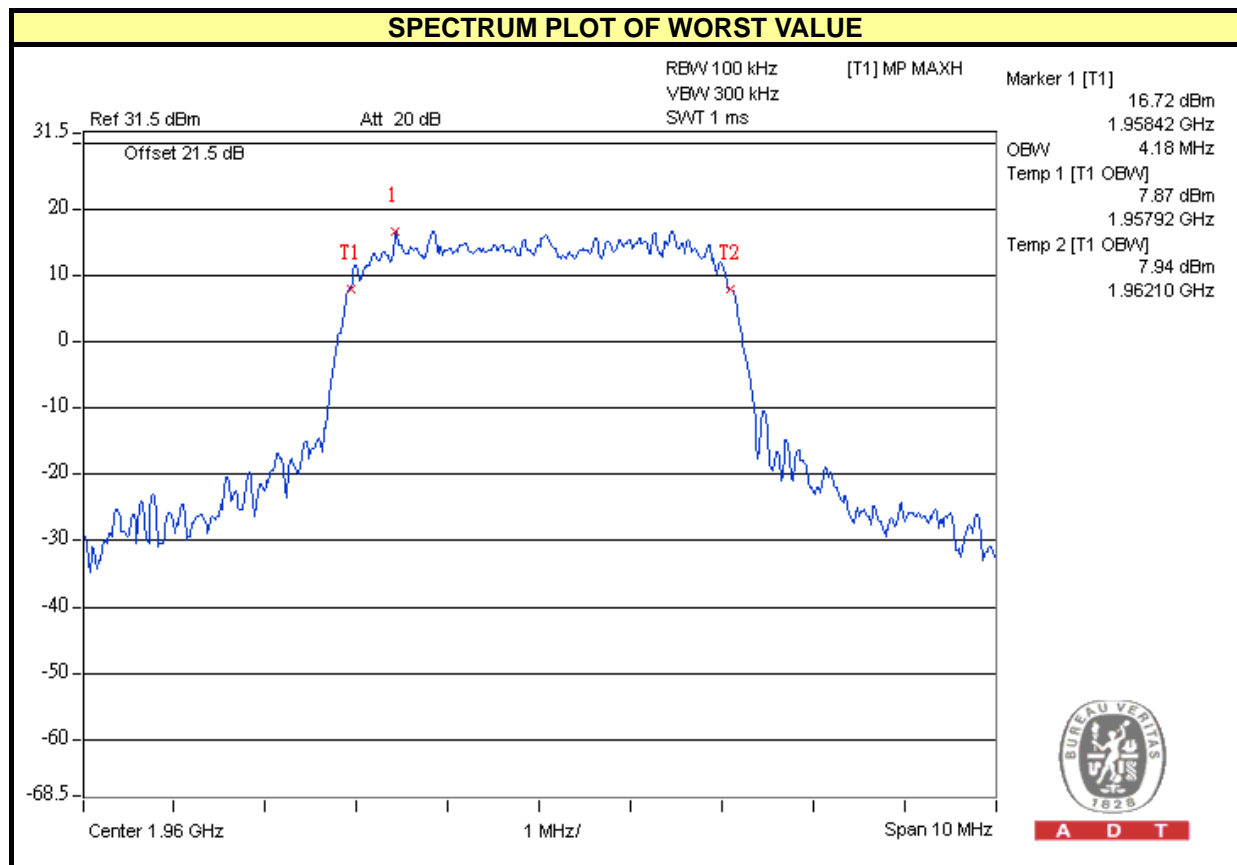

4.4 PEAK TO AVERAGE RATIO

4.4.1 LIMITS OF PEAK TO AVERAGE RATIO MEASUREMENT

In measuring transmissions in this band using an average power technique, the peak to average ratio (PAR) of the transmission may not exceed 13 dB

4.4.2 TEST SETUP

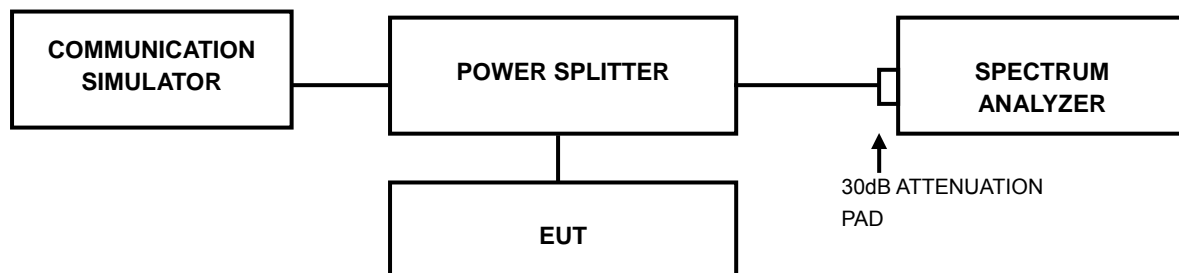

4.4.3 TEST PROCEDURES

1. Set resolution/measurement bandwidth \geq signal's occupied bandwidth;
2. Set the number of counts to a value that stabilizes the measured CCDF curve;
3. Record the maximum PAPR level associated with a probability of 0.1%.

4.4.4 TEST RESULTS

WCDMA Band 2

CHANNEL	FREQUENCY (MHz)	PEAK TO AVERAGE RATIO (dB)
		BPSK
9662	1932.4	7.17
9800	1960	7.23
9938	1987.6	6.68



4.5 BAND EDGE MEASUREMENT

4.5.1 LIMITS OF BAND EDGE MEASUREMENT

Power of any emission outside of the authorized operating frequency ranges must be attenuated below the transmitting power (P) by a factor of at least $43 + 10 \log(P)$ dB. In the 1 MHz bands immediately outside and adjacent to the frequency block a resolution bandwidth of at least one percent of the emission bandwidth of the fundamental emission of the transmitter may be employed.

4.5.2 TEST SETUP

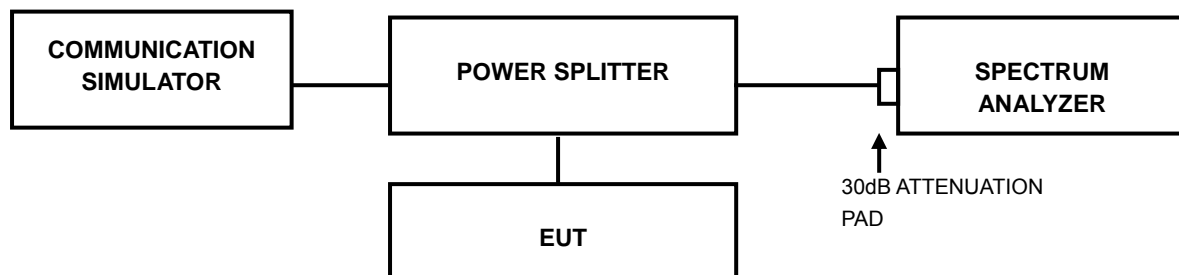

4.5.3 TEST PROCEDURES

- All measurements were done at low and high operational frequency range.
- The center frequency of spectrum is the band edge frequency and span is 10MHz. RB of the spectrum at least 1% of emission bandwidth and $VBW \geq 3RBW$ (WCDMA).
- Record the max trace plot into the test report.



A D T

4.5.4 TEST RESULTS

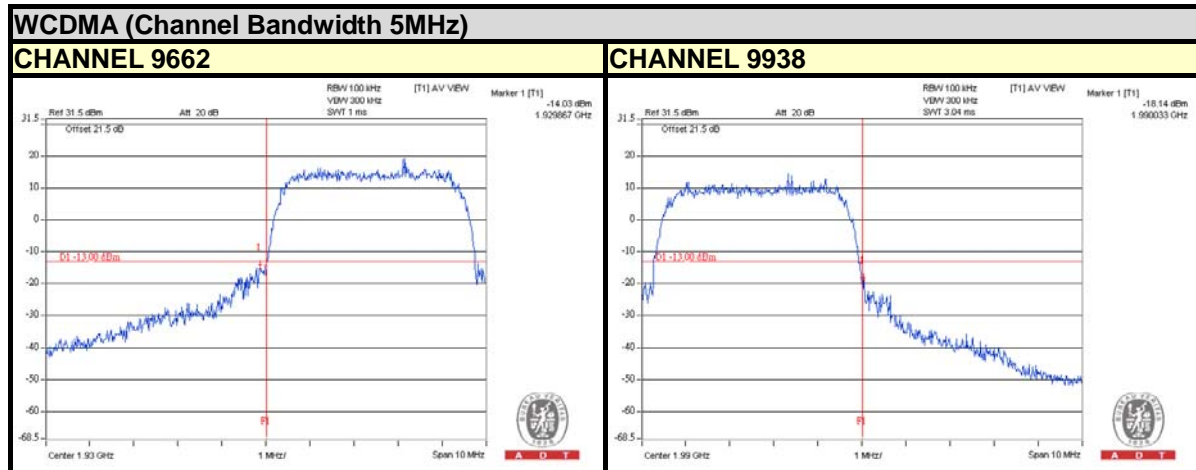

4.6 CONDUCTED SPURIOUS EMISSIONS

4.6.1 LIMITS OF CONDUCTED SPURIOUS EMISSIONS MEASUREMENT

The power of any emission outside of the authorized operating frequency ranges must be attenuated below the transmitting power (P) by a factor of at least $43 + 10 \log(P)$ dB. The emission limit equal to -13dBm .

4.6.2 TEST PROCEDURE

- a. The EUT makes a phone call to the communication simulator. All measurements were done at low, middle and high operational frequency range.
- b. Measuring frequency range is from 9kHz to 20GHz. 20dB attenuation pad is connected with spectrum. RBW=1MHz and VBW=3MHz is used for conducted emission measurement.

4.6.3 TEST SETUP

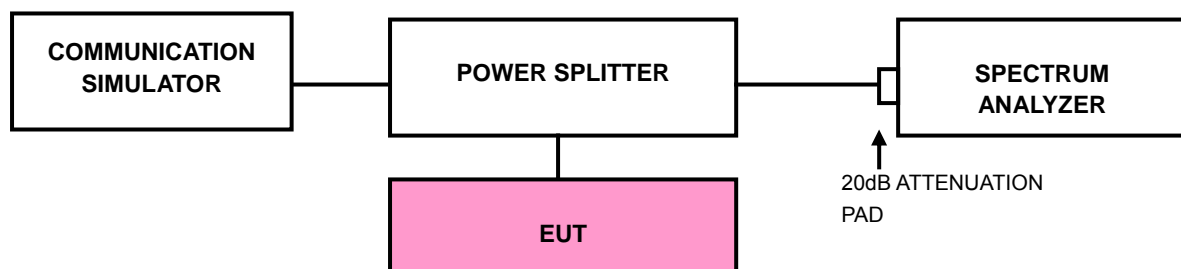



A D T

4.6.4 TEST RESULTS





A D T

WCDMA

CHANNEL 9800

FREQUENCY RANGE : 9kHz~3GHz

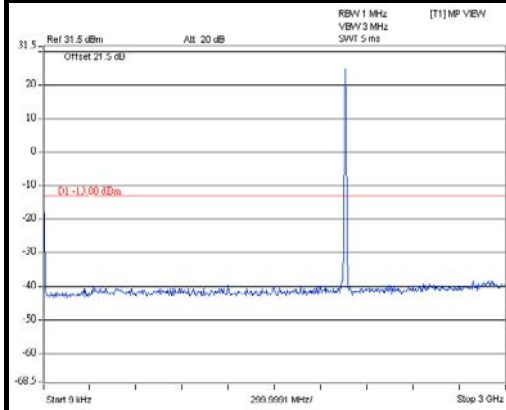

FREQUENCY RANGE : 3GHz~10GHz

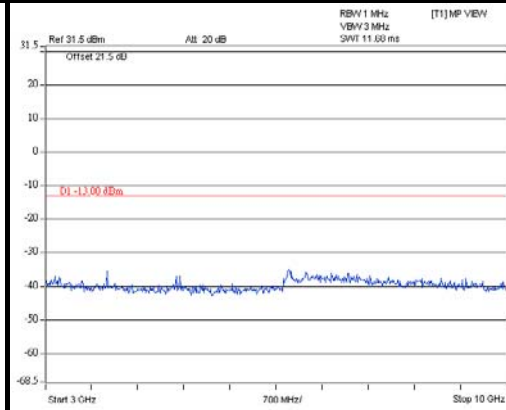

FREQUENCY RANGE : 10GHz~20GHz

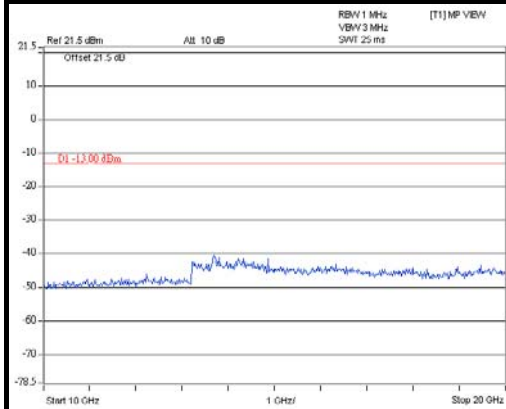



A D T

WCDMA

CHANNEL 9938

FREQUENCY RANGE : 9kHz~3GHz

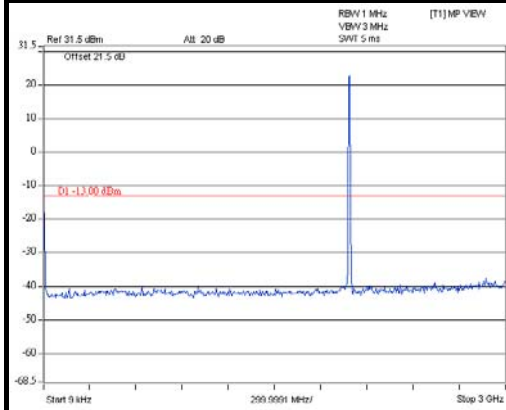

FREQUENCY RANGE : 3GHz~10GHz

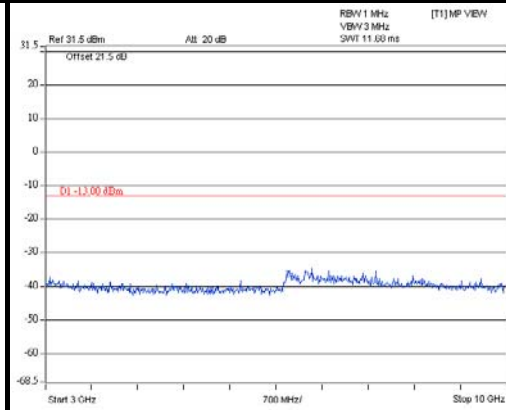

FREQUENCY RANGE : 10GHz~20GHz

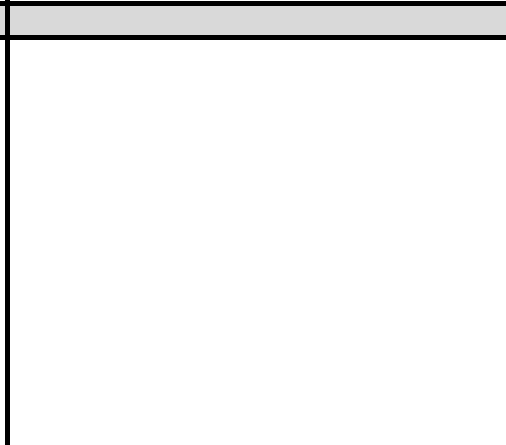
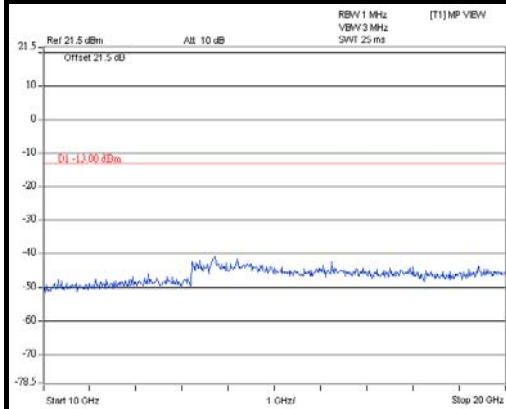

4.7 RADIATED EMISSION MEASUREMENT

4.7.1 LIMITS OF RADIATED EMISSION MEASUREMENT

The power of any emission outside of the authorized operating frequency ranges must be attenuated below the transmitting power (P) by a factor of at least $43 + 10 \log(P)$ dB. The emission limit equal to -13dBm .

4.7.2 TEST PROCEDURES

- a. Substitution method is used for E.I.R.P measurement. In the semi-anechoic chamber, EUT placed on the 0.8m height of Turn Table, rotated the table around 360 degrees to search the maximum radiation power and receiver antenna shall be rotated vertical and horizontal polarization and moved height from 1m to 4m to find the maximum polar radiated power. The "Read Value" is the spectrum reading the maximum power value.
- b. The substitution horn antenna is substituted for EUT at the same position and signals generator export the CW signal to the substitution antenna via a TX cable. Rotated the Turn Table and moved receiving antenna to find the maximum radiation power. Adjust output power level of S.G to get a Value of spectrum reading equal to "Read Value" of step a. Record the power level of S.G
- c. $\text{EIRP} = \text{Output power level of S.G} - \text{TX cable loss} + \text{Antenna gain of substitution horn}$. E.R.P power can be calculated form E.I.R.P power by subtracting the gain of dipole, $\text{E.R.P power} = \text{E.I.R.P power} - 2.15\text{dBi}$.

NOTE: The resolution bandwidth and video bandwidth of test receiver/spectrum analyzer is 1MHz/3MHz.

4.7.3 DEVIATION FROM TEST STANDARD

No deviation

4.7.4 TEST SETUP

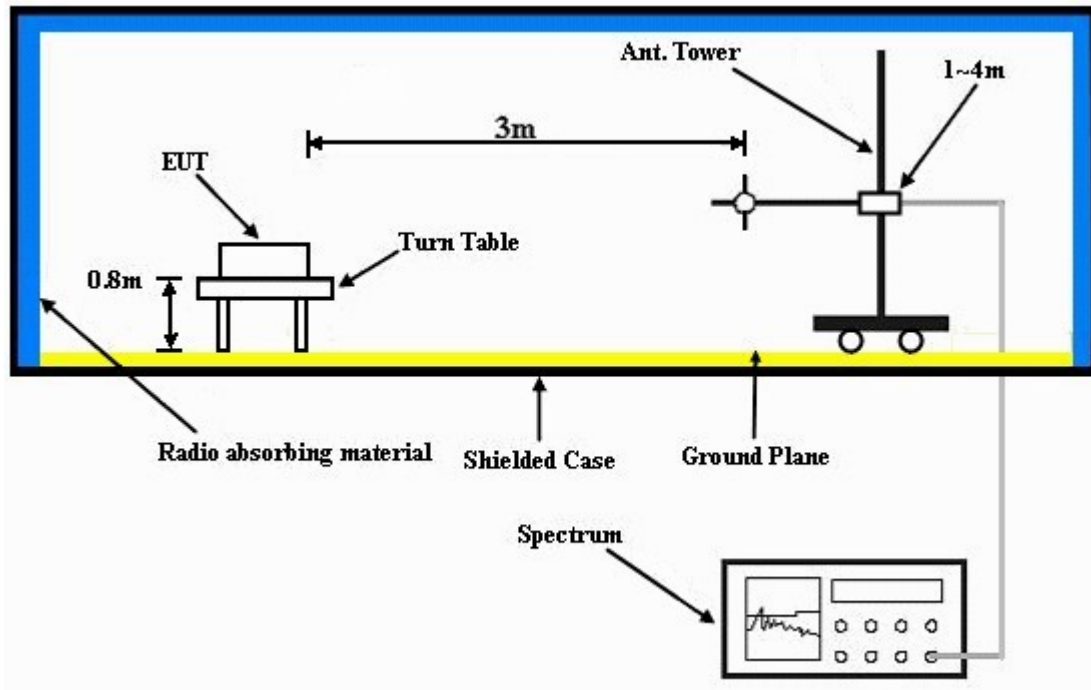

For the actual test configuration, please refer to the attached file (Test Setup Photo).

4.7.5 TEST RESULTS

WCDMA Band 2 (Channel Bandwidth 5MHz)

MODE	TX channel 9800	FREQUENCY RANGE	Below 1000MHz
ENVIRONMENTAL CONDITIONS	25deg. C, 65%RH	INPUT POWER	120Vac, 60 Hz
TEST MODE	A	TESTED BY	Chris Lin

ANTENNA POLARITY & TEST DISTANCE: HORIZONTAL AT 3 M							
No.	Freq. (MHz)	Reading (dBm)	S.G Power Value (dBm)	Correction Factor (dB)	EIRP (dBm)	Limit (dBm)	Margin (dB)
1	111.50	-46.15	-52.32	0.42	-51.90	-13.00	-38.90
2	286.10	-51.21	-60.30	5.20	-55.10	-13.00	-42.10
3	427.70	-62.89	-67.51	5.17	-62.34	-13.00	-49.34
4	712.90	-66.60	-67.14	5.09	-62.05	-13.00	-49.05
5	796.30	-65.93	-63.79	4.07	-59.72	-13.00	-46.72
6	937.90	-62.04	-57.11	3.92	-53.19	-13.00	-40.19
ANTENNA POLARITY & TEST DISTANCE: VERTICAL AT 3 M							
No.	Freq. (MHz)	Reading (dBm)	S.G Power Value (dBm)	Correction Factor (dB)	EIRP (dBm)	Limit (dBm)	Margin (dB)
1	109.50	-37.99	-42.47	0.50	-41.97	-13.00	-28.97
2	175.50	-48.05	-49.57	2.34	-47.23	-13.00	-34.23
3	284.10	-57.37	-63.59	5.21	-58.38	-13.00	-45.38
4	538.30	-60.89	-62.18	4.71	-57.47	-13.00	-44.47
5	800.20	-65.31	-60.17	4.02	-56.15	-13.00	-43.15
6	937.90	-62.01	-53.95	3.92	-50.03	-13.00	-37.03

REMARKS:

1. Power Value (dBm) = S.G Power Value (dBm) + Correction Factor (dB).
2. Correction Factor (dB) = Substitution Antenna Gain (dB) + Cable Loss (dB).



A D T

MODE	TX channel 9800	FREQUENCY RANGE	Below 1000MHz
ENVIRONMENTAL CONDITIONS	25deg. C, 65%RH	INPUT POWER	120Vac, 60 Hz
TEST MODE	B	TESTED BY	Chris Lin

ANTENNA POLARITY & TEST DISTANCE: HORIZONTAL AT 3 M							
No.	Freq. (MHz)	Reading (dBm)	S.G Power Value (dBm)	Correction Factor (dB)	EIRP (dBm)	Limit (dBm)	Margin (dB)
1	30.00	-52.75	-36.78	-12.18	-48.96	-13.00	-35.96
2	125.10	-41.82	-47.96	-0.03	-47.99	-13.00	-34.99
3	239.50	-51.67	-62.33	5.41	-56.92	-13.00	-43.92
4	582.90	-62.09	-65.31	4.52	-60.79	-13.00	-47.79
5	736.20	-60.28	-59.63	4.81	-54.82	-13.00	-41.82
6	937.90	-58.00	-53.07	3.92	-49.15	-13.00	-36.15
ANTENNA POLARITY & TEST DISTANCE: VERTICAL AT 3 M							
No.	Freq. (MHz)	Reading (dBm)	S.G Power Value (dBm)	Correction Factor (dB)	EIRP (dBm)	Limit (dBm)	Margin (dB)
1	51.30	-34.78	-30.52	-9.46	-39.98	-13.00	-26.98
2	127.00	-47.75	-50.81	-0.06	-50.87	-13.00	-37.87
3	291.90	-58.58	-64.65	5.17	-59.48	-13.00	-46.48
4	751.70	-62.01	-57.54	4.60	-52.94	-13.00	-39.94
5	899.10	-59.89	-52.63	3.90	-48.73	-13.00	-35.73
6	937.90	-55.82	-47.76	3.92	-43.84	-13.00	-30.84

REMARKS:

1. Power Value (dBm) = S.G Power Value (dBm) + Correction Factor (dB).
2. Correction Factor (dB) = Substitution Antenna Gain (dB) + Cable Loss (dB).



A D T

MODE	Channel 9662	FREQUENCY RANGE	Above 1000MHz
ENVIRONMENTAL CONDITIONS	25deg. C, 65%RH	INPUT POWER	120Vac, 60 Hz
TESTED BY	Chris Lin		

ANTENNA POLARITY & TEST DISTANCE: HORIZONTAL AT 3 M							
No.	Freq. (MHz)	Reading (dBm)	S.G Power Value (dBm)	Correction Factor (dB)	EIRP (dBm)	Limit (dBm)	Margin (dB)
1	3864.8	-31.52	-25.27	7.05	-18.22	-13.00	-5.22

ANTENNA POLARITY & TEST DISTANCE: VERTICAL AT 3 M							
No.	Freq. (MHz)	Reading (dBm)	S.G Power Value (dBm)	Correction Factor (dB)	EIRP (dBm)	Limit (dBm)	Margin (dB)
1	3864.8	-30.29	-24.22	7.05	-17.17	-13.00	-4.17

REMARKS:

1. Power Value (dBm) = S.G Power Value (dBm) + Correction Factor (dB).
2. Correction Factor (dB) = Substitution Antenna Gain (dB) + Cable Loss (dB).

MODE	Channel 9800	FREQUENCY RANGE	Above 1000MHz
ENVIRONMENTAL CONDITIONS	25deg. C, 65%RH	INPUT POWER	120Vac, 60 Hz
TESTED BY	Chris Lin		

ANTENNA POLARITY & TEST DISTANCE: HORIZONTAL AT 3 M							
No.	Freq. (MHz)	Reading (dBm)	S.G Power Value (dBm)	Correction Factor (dB)	EIRP (dBm)	Limit (dBm)	Margin (dB)
1	3920.0	-33.88	-27.55	7.04	-20.51	-13.00	-7.51

ANTENNA POLARITY & TEST DISTANCE: VERTICAL AT 3 M							
No.	Freq. (MHz)	Reading (dBm)	S.G Power Value (dBm)	Correction Factor (dB)	EIRP (dBm)	Limit (dBm)	Margin (dB)
1	3920.0	-33.11	-26.95	7.04	-19.91	-13.00	-6.91

REMARKS:

1. Power Value (dBm) = S.G Power Value (dBm) + Correction Factor (dB).
2. Correction Factor (dB) = Substitution Antenna Gain (dB) + Cable Loss (dB).



A D T

MODE	Channel 9938	FREQUENCY RANGE	Above 1000MHz
ENVIRONMENTAL CONDITIONS	25deg. C, 65%RH	INPUT POWER	120Vac, 60 Hz
TESTED BY	Chris Lin		

ANTENNA POLARITY & TEST DISTANCE: HORIZONTAL AT 3 M							
No.	Freq. (MHz)	Reading (dBm)	S.G Power Value (dBm)	Correction Factor (dB)	EIRP (dBm)	Limit (dBm)	Margin (dB)
1	3975.2	-32.87	-26.46	7.04	-19.42	-13.00	-6.42

ANTENNA POLARITY & TEST DISTANCE: VERTICAL AT 3 M							
No.	Freq. (MHz)	Reading (dBm)	S.G Power Value (dBm)	Correction Factor (dB)	EIRP (dBm)	Limit (dBm)	Margin (dB)
1	3975.0	-34.46	-28.22	7.04	-21.18	-13.00	-8.18

REMARKS:

1. Power Value (dBm) = S.G Power Value (dBm) + Correction Factor (dB).
2. Correction Factor (dB) = Substitution Antenna Gain (dB) + Cable Loss (dB).



5 PHOTOGRAPHS OF THE TEST CONFIGURATION

Please refer to the attached file (Test Setup Photo).



6 INFORMATION ON THE TESTING LABORATORIES

We, Bureau Veritas Consumer Products Services (H.K.) Ltd., Taoyuan Branch, were founded in 1988 to provide our best service in EMC, Radio, Telecom and Safety consultation. Our laboratories are accredited and approved according to ISO/IEC 17025.

If you have any comments, please feel free to contact us at the following:

Linko EMC/RF Lab:

Tel: 886-2-26052180

Fax: 886-2-26051924

Hsin Chu EMC/RF/Telecom Lab:

Tel: 886-3-5935343

Fax: 886-3-5935342

Hwa Ya EMC/RF/Safety Lab:

Tel: 886-3-3183232

Fax: 886-3-3270892

Email: service.adt@tw.bureauveritas.com

Web Site: www.bureauveritas-adt.com

The address and road map of all our labs can be found in our web site also.



7 APPENDIX A – MODIFICATIONS RECORDERS FOR ENGINEERING CHANGES TO THE EUT BY THE LAB

No modifications were made to the EUT by the lab during the test.

---END---