



5G NR Small Cell NR xCell 46116A User Guide

ASKEY COMPUTER CORPORATION
April 2023

Copyright Notice

Askey owns the copyright to the information in this document. No part of this document may be reproduced in any form or by any means without the prior written consent of Askey.

Disclaimer

The information in this document is subject to change without notice. Askey is not responsible for any errors contained herein. For more information, please consult an Askey technical engineer or support team. Please see the "Contact Us" section below.

Contact us

Askey Computer Corp.

Address : 10F, NO.119, Jiankang Road, Zhonghe District, New Taipei City 23585 TAIWAN, R.O.C.

TEL : +886-2-2228-7588

E-mail: sales@askey.com

Internet Address: <https://www.askey.com.tw/>

Security Information

For the safety of installation engineers and to protect the equipment from damage, please read all safety warnings carefully. If you have any questions about these warnings, please contact the Askey support team before installing or powering up the base station.

Declaration of Conformity

Hereby, Askey declares that the radio equipment type NR xCell 46116A is in compliance with Directive 2014/53/EU. The full text of the EU declaration of conformity is available at the following internet address: <https://askeycloud.askey.com/owncloud/index.php/s/ZA8LBnW6WvQenPo>

Federal Communication Commission Interference Statement

This device complies with Part 15 of the FCC Rules. Operation is subject to the following two conditions: (1) This device may not cause harmful interference, and (2) this device must accept any interference received, including interference that may cause undesired operation.

This equipment has been tested and found to comply with the limits for a Class B digital device, pursuant to Part 15 of the FCC Rules. These limits are designed to provide reasonable protection against harmful interference in a residential installation. This equipment generates, uses and can radiate radio frequency energy and, if not installed and used in accordance with the instructions, may cause harmful interference to radio communications. However, there is no guarantee that interference will not occur in a particular installation. If this equipment does cause harmful interference to radio or television reception, which can be determined by turning the equipment off and on, the user is encouraged to try to correct the interference by one of the following measures:

- Reorient or relocate the receiving antenna.
- Increase the separation between the equipment and receiver.
- Connect the equipment into an outlet on a circuit different from that to which the receiver is connected.
- Consult the dealer or an experienced radio/TV technician for help.

FCC Caution: Any changes or modifications not expressly approved by the party responsible for compliance could void the user's authority to operate this equipment.

This transmitter must not be co-located or operating in conjunction with any other antenna or transmitter.

FOR MOBILE DEVICE USAGE (>20cm/low power)

Radiation Exposure Statement:

This equipment complies with FCC radiation exposure limits set forth for an uncontrolled environment. This equipment should be installed and operated with minimum distance 20cm between the radiator & your body.

Contents

Chapter 1 Introduction	1
1.1 Brief Introduction	1
1.2 Specification	1
1.3 What's in The Box	2
1.4 IO Interfaces	3
Chapter 2 Setup	5
2.1 Setup Procedure	5
2.2 Cable Connection.....	5
2.3 LED Status.....	6
2.4 Installation.....	8
2.5 Route the Cables.....	12
Chapter 3 The Askey 5G NR Small Cell Admin Website	13
3.1 Admin Website Overview	15
3.2 Home.....	19
3.3 Connected Devices	19
3.4 Settings.....	21
3.5 Configuration.....	33
3.6 About.....	59
Chapter 4 The Askey 5G NR Small Cell Support Utilities.....	62
4.1 Small Cell Log Download Mechanism	62
4.2 Access the Admin Website by IPv6 Link-Local Address	63
4.3 The Recommend NR ARFCN Configuration	64

List of Figures

Figure 1. Askey 5G NR Indoor Small Cell NR xCell 46116A	1
Figure 2. IO Interfaces	3
Figure 3. Setup Procedure	5
Figure 4. Cable Connection	6
Figure 5. Fix the Mount Base to NR xCell 46116A	9
Figure 6. Wall Mount Overview	10
Figure 7. T Bar Width	10
Figure 8. Ceiling Mount Overview	11
Figure 9. Pole Mount Overview	12
Figure 10. Align the Mount Base and the Mount Bracket	12
Figure 11. The Network Interfaces of the Askey 5G NR Small Cell	13
Figure 12. Access the Askey 5G NR Small Cell Admin Website via HTTPS	13
Figure 13. The Askey 5G NR Small Cell Admin Website Sign-In Form	15
Figure 14. The Askey 5G NR Small Cell Admin Website Overview	16
Figure 15. The Askey 5G NR Small Cell Quick Reference Icons	17
Figure 16. The Askey 5G NR Small Cell Service Status	17
Figure 17. The Askey 5G NR Small Cell GPS Status	17
Figure 18. Map Illustration	18
Figure 19. The Askey 5G NR Small Cell Home Page	19
Figure 20. The Askey 5G NR Small Cell Connected Devices Page	20
Figure 21. The Askey 5G NR Small Cell Network Page	21
Figure 22. The Askey 5G NR Small Cell Network Page for the 2nd Interface	21
Figure 23. The Multiple Static IP Addresses Dialog Window	22
Figure 24. Add a new Item in Static IP Addresses Dialog Window	23
Figure 25. The Askey 5G NR Small Cell Network Page with the multiple IP addresses	24
Figure 26. The Askey 5G NR Small Cell Admin Website with the alternate static IP address	25
Figure 27. The Askey 5G NR Small Cell Advanced Page	28
Figure 28. The Askey 5G NR Small Cell Sync Source Page	29
Figure 29. The Askey 5G NR Small Cell Time Zone Page	30
Figure 30. The Askey 5G NR Small Cell Reset Page	32
Figure 31. The Askey 5G NR Small Cell Dashboard Page	33
Figure 32. The Askey 5G NR Small Cell gNB Page	35
Figure 33. The Local Provision Method in gNB Configuration	36
Figure 34. The Askey OAM Architecture	37
Figure 35. VLAN IP Address	37
Figure 36. The Askey 5G NR Small Cell Switch CU or DU Configuration	39
Figure 37. The Askey 5G NR Small Cell DU Configuration – Common Items	39
Figure 38. The Askey 5G NR Small Cell DU Configuration – Bandwidth Profile	40
Figure 39. The Askey 5G NR Small Cell DU Configuration – SAS Provider	40
Figure 40. The Askey 5G NR Small Cell DU Configuration – NR ARFCN	43
Figure 41. The Askey 5G NR Small Cell DU Configuration – Time Slot Profile	44
Figure 42. The Askey 5G NR Small Cell DU Configuration – Time Slot Parameters	44
Figure 43. The Askey 5G NR Small Cell Neighbor Cell Page	47
Figure 44. The Askey 5G NR Small Cell RF Antenna Page	49
Figure 45. The Askey 5G NR Small Cell VLAN Page	51
Figure 46. The Askey 5G NR Small Cell VLAN Page – Read Operation	52

Figure 47. The Askey 5G NR Small Cell VLAN Page – Create Operation52
Figure 48. The Askey 5G NR Small Cell VLAN Page – Update Operation53
Figure 49. The Askey 5G NR Small Cell VLAN Page – Delete Operation54
Figure 50. The Askey 5G NR Small Cell Static Routing Page.....55
Figure 51. The Askey 5G NR Small Cell Version Page.....56
Figure 52. The Askey 5G NR Small Cell GPS Page59

ASKEY COMPUTER CORPORATION

List of Tables

Table 1. NR xCell 46116A General Specification	1
Table 2. List of Items in The Box	2
Table 3. NR xCell 46116A IO Interface	3
Table 4. LED Status Overview	7
Table 5. List of Items for Wall Mount	9
Table 6 List of Items for Ceiling Mount	10
Table 7. List of Items for Pole Mount	11
Table 8. The Askey 5G NR Small Cell Home Page	19
Table 9. The Askey 5G NR Small Cell Connected Devices	20
Table 10. The Askey 5G NR Small Cell Network	27
Table 11. The Askey 5G NR Small Cell Advanced	28
Table 12. The Askey 5G NR Small Cell Sync Source	30
Table 13. The Askey 5G NR Small Cell Dashboard	34
Table 14. The Askey 5G NR Small Cell CU Configuration	38
Table 15. The Askey 5G NR Small Cell DU Configuration – Common	39
Table 16. The Askey 5G NR Small Cell DU Configuration – Bandwidth and NR ARFCN	44
Table 17. The Askey 5G NR Small Cell DU Configuration – Time Slot Format	46
Table 18. The Askey 5G NR Small Cell Neighbor Cell Configuration	49
Table 19. The Askey 5G NR Small Cell GPS	61

ASKEY COMPUTER CORPORATION

Chapter 1 Introduction

1.1 Brief Introduction

This user Guide introduces the Askey 5G NR indoor small cell NR xCell 46116A for Enterprise, which supports N48 (3.55~3.7GHz)/N77 (3.7~4.0GHz) band. Meeting the demand for indoor connectivity, it is an ideal and powerful solution to deliver a superior network access experience. This super and compact small cell has integrated baseband and radio into a single product, which can support external antenna and help break installation barriers. The NR xCell 46116A Small Cell is part of the carrier-grade, end-to-end Askey Small Cells solution that is definitely suitable for various scenarios, such as smart buildings, factories, hospitals, shopping malls, elevators, underground parking etc.

Figure 1. Askey 5G NR Indoor Small Cell NR xCell 46116A



1.2 Specification

Table 1. NR xCell 46116A General Specification

Item	Description
Band	N48(3.55~3.7GHz) N77(3.7~4.0GHz)
Bandwidth	N48 : 10/20/30/40 MHz N77 : 40/50/60/70/80/90/100MHz
Max. TX Power	N48: EIRP < 30dBm N77: 24dBm
Antenna	Internal/External 2x2 MIMO
LED	1 LED
Backhaul	10G SFP+/2.5G WAN

Power Supply	DC 12V/POE++
Power Consumption	40W
Active Users	16~32
Data Rates	700Mbps/100 Mbps
Installation	Wall /Ceiling/Pole mount
IP Grade	IP50
Dimensions	W250 x H250 x D65mm
Weight	<2.5kG
Operating Temperature	-5°C – 50°C
Operating Humidity	90% maximum, non-condensing

1.3 What's in The Box





The Askey NR xCell 46116A box contains:

- NR xCell 46116A
- Power Adapter
- GPS antenna

The following optional items are available:

- Ethernet cable (Optional)
- Mounting Accessories (Optional)
- SFP+ module(Optional)

Table 2. List of Items in The Box

Items	Qty	Description	Picture
1. Askey Small Cell NR xCell 46116A	1	The Askey 5G NR indoor small cell NR xCell 46116A. Please check the label to make sure you have received the correct base station	
2. Power Adapter	1	Length: 2.6m	
3. GPS antenna	1	Length: 7m	
4. Ethernet cable (Optional)	1		
5. Mounting Accessories (Optional)	1	Optional, 3 types for wall mount, ceiling mount, and pole mount, please refer to 2.4 for more details	

6. SFP+ module (Optional)	1	10G SFP+, please note that the highest operating temperature specification of 10G SFP+ module must be workable at minimum 75°C.
---------------------------	---	---

1.4 IO Interfaces

This section will guide you through the interfaces and functions of NR xCell 46116A.

About the RF Antenna, there are two different scenarios,

- Internal antenna. Using the embedded antennas in the housing (Default mode).
- External antenna. If you would like to use the external antennas, you need to connect the external antennas into the ANT1 & ANT2 port, which are SMA connector. There is the description about the operation function of antenna switching in Section 3.5.3 **RF Antenna**. Users can directly operate in the web UI to switch to the external antenna they want to use.

About Synchronization, there are two different scenarios,

- With GPS. The GPS antenna is required for the automated setup process and search for the GPS signal for synchronization.
- Without GPS. In this scenario, you must have the grand master and BC Switch for synchronization rather than GPS, so in this scenario the GPS is not necessary.

NR xCell 46116A has a single multicolored LED used to indicate the device connectivity status. Please review Section 2.3 LED status for the LED guide when attempting to troubleshoot the solution.

Figure 2. IO Interfaces



Table 3. NR xCell 46116A IO Interface

Item	Description
SFP+	The SFP+ port allows you to connect a fiber to establish communication between NR xCell 46116A and switch/router.
RESET	The Reset allows you to reset the device to factory defaults.
GPS	The GPS antenna port provides access to a SMA Female interface for the external GPS antenna cable. When GM/BC switch is used, no GPS is

	needed to connect.
1PPS	Output the PPS synchronization signal.
DBG	The DBG port is used for debug.
WAN	The WAN port allows you to connect an Ethernet cable to establish communication between NR xCell 46116A and switch/router.
DC IN	The 12V DC Power port is used to power NR xCell 46116A when connected to the AC power adaptor. Use only the provided power adapter, as using any other power adapter may damage NR xCell 46116A
ANT1	ANT1 for External 3.3-5GHz 5G antenna connection
ANT2	ANT2 for External 3.3-5GHz 5G antenna connection

The equipment is to be connected only to PoE networks without routing to the outside plant

The equipment with a GPS function has not been evaluated for "life-safety" and "non-life-safety" applications.

External antenna ports ANT1/ANT2 are disabled via software for this model and is not modifiable by any third-party / end-user

ASKEY COMPUTER CORPORATION

Chapter 2 Setup

2.1 Setup Procedure

This part outlines the procedures needed to set up NR xCell 46116A.

Figure 3. Setup Procedure

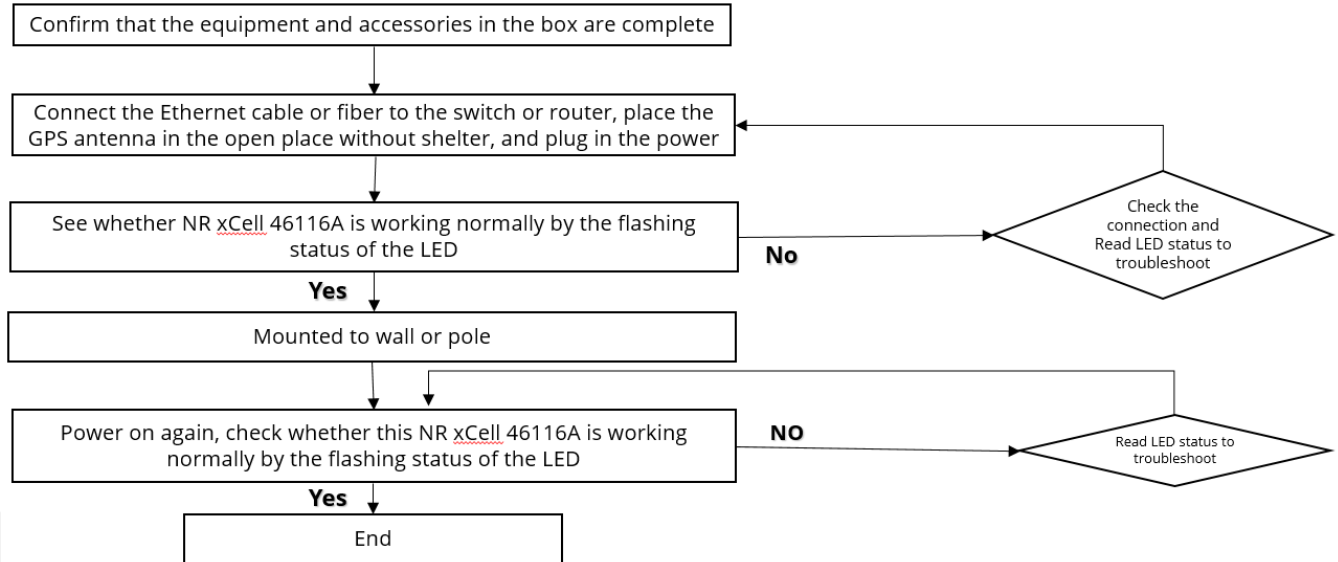

2.2 Cable Connection

Connect the Ethernet cable, power cable and GPS antenna correctly.

- **Indoor GPS antenna**

1. Turn off NR xCell 46116A.
2. Connect the provided Indoor GPS antenna cable to GPS port on the NR xCell 46116A.
3. Place the antenna near a window where the GPS signal is stronger.
4. Turn on the NR xCell 46116A to allow the detection of an available GPS signal.

Noted:

- If using PTP sync solution. there is no need to connect the GPS antenna to the NR xCell 46116A.
- If using fiber transmission. 10G SFP+ module and fiber are needed. **Please note that the highest operating temperature specification of 10G SFP+ module must be workable at minimum 75°C., otherwise the device will be down.**

Figure 4. Cable Connection

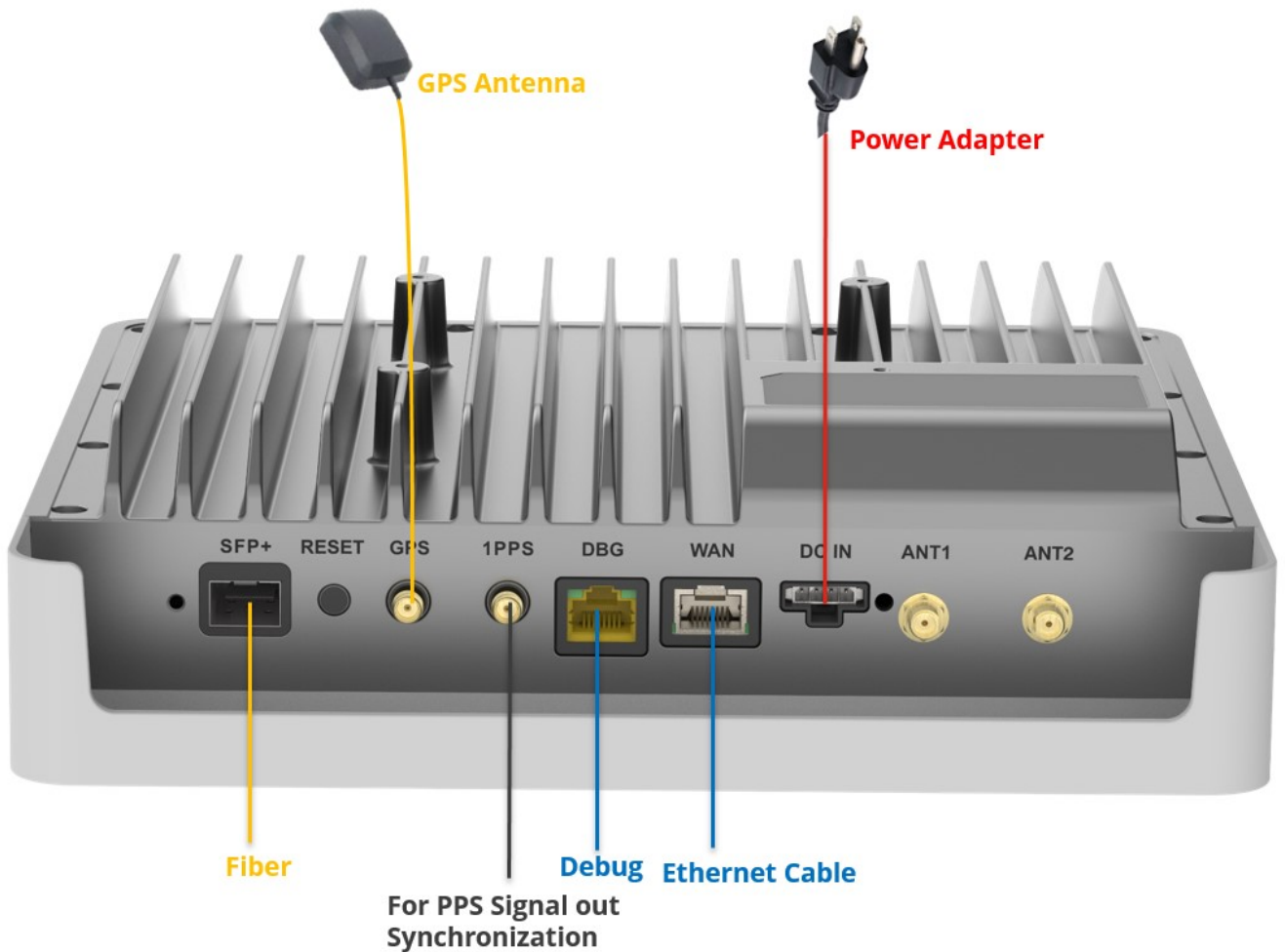

2.3 LED Status

After all the connections are connected and the NR xCell 46116A is powered on, please check the status of LED on the device. The LED will flash according to the LED description provided in Table 4.

If the NR xCell 46116A is operating as expected, continue to Section 2.4. If the NR xCell 46116A is not functioning properly and you have to carefully check all steps.

Table 4. LED Status Overview

Item	Description	LED	User instruction
1	Power On	Solid Red	
2	Network is initializing	Blue Blink (Light on for 3 seconds, light off for 3 seconds)	<ol style="list-style-type: none"> 1. The small cell is acquiring IP address, please wait. 2. If the LED stays at this stage for more than 5 mins, please check the Ethernet cable is firmly connected at both ends, and the switch, router, or internet gateway is turned on.
3	GPS Sync Progressing	Green Blink (Light on for 1 seconds, light off for 3 seconds)	<ol style="list-style-type: none"> 1. The small cell is syncing and acquiring GPS signal, please wait. 2. If the LED stays at this stage for more than 10 mins, the small cell has failed to acquire minimally required GPS signal, please try to move your GPS antenna closer to the window. 3. If the issue persists, please call Customer Service. <p>Note: First GPS sync lock may take 45 minutes</p>
4	OAM Configuring	Blue Blink (Light on for 1 seconds, light off for 3 seconds)	<ol style="list-style-type: none"> 1. The network management server is provisioning the small cell, please wait. 2. If the LED stays at this stage for more than 10 minutes, the small cell has not received all required or correct provisioning parameters from HeMS. Please try reboot your device again. 3. If the issue persists, please call Customer Service.
5	5G Service is initializing	Blue Blink (Light on for 1 seconds, light off for 1 seconds)	<ol style="list-style-type: none"> 1. The small cell is syncing with 5G network, please wait. 2. If the LED stays at this stage for more than 10 minutes, the small cell is still trying to connect to HeNB Gateway, please check the LAN/ firewall setting or contact your network administrator. 3. If the issue persists, please call Customer Service.
6	5G Service Ready	Solid Blue	5G service is ready in the small cell.
7	5G Service In Progress	Green Blink (Light on for 1 seconds, light off for 1 seconds)	UE is connecting to 5G small cell, service is in progress.

8	Overheating	Red Blink (Light on for 3 seconds, light off for 3 seconds)	The small cell is overheating, please place this device in a cool area where the temperature is between 23~122 degrees Fahrenheit.
9	Software Upgrade	Fast Blue Blink	We are upgrading the software in the small cell, please wait.
10	GPS no signal	Red Blink (Light on for 1 seconds, light off for 1 seconds)	<ol style="list-style-type: none"> 1. The small cell has tried to acquire GPS signal for 10 minutes, but failed to acquire minimally required GPS signal. Please try to move your GPS antenna closer to the window. 2. If the issue persists, please call Customer Service.

2.4 Installation

There are mainly 3 ways for NR xCell 46116A installation - wall mount, ceiling mount and pole mount. This section will guide you through all the installation ways for NR xCell 46116A.

2.4.1 Preparation: Fix the mount base to NR xCell 46116A



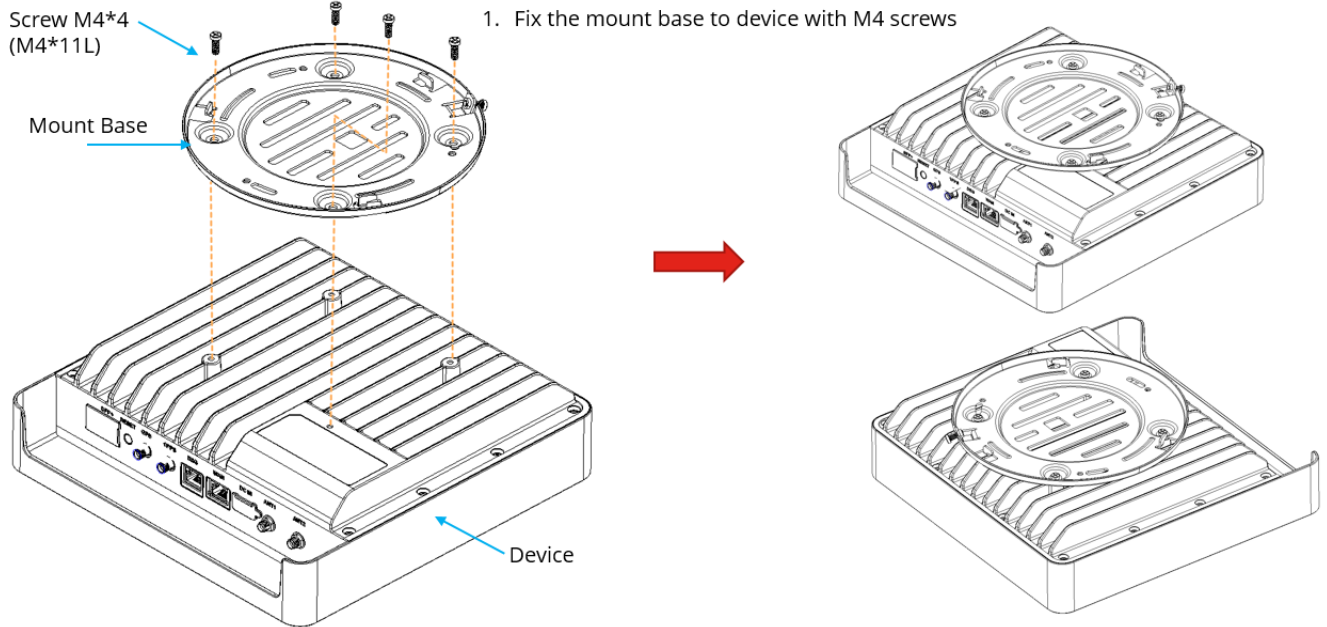

No matter which mount installation method you choose, the first step is to fix the mount base to NR xCell 46116A with M4 screw*4, as shown in the figure 5.

Figure 5. Fix the Mount Base to NR xCell 46116A



2.4.2 Wall Mount

Table 5. List of Items for Wall Mount

Items	Qty	Description	Picture
1. Mount base	1	Fix the mount base to NR xCell 46116A with M4 screw*4	
2. Mount bracket	1	Fixed to the wall, used with the mount base to fix the NR xCell 46116A	
3. Screw anchor	2	To fix the screws (STP3.5-20)	
4. M4 Screw(M4*0.7*11L)	4	To fix the mount base to NR xCell 46116A	
5. Screw(STP3.5-20)	2	To fix the mount bracket to the wall	

Installation steps,

1. Place the mount bracket on the wall. Mark and drill 2 screw holes on the wall.
2. Use a tool to insert 2 screw anchors into the drilled holes on the wall.
3. Align the inserted screw anchors and the screw holes of the bracket. Fix the bracket to the wall by fastening 2 screws(STP3.5-20).
4. End.

Figure 6. Wall Mount Overview

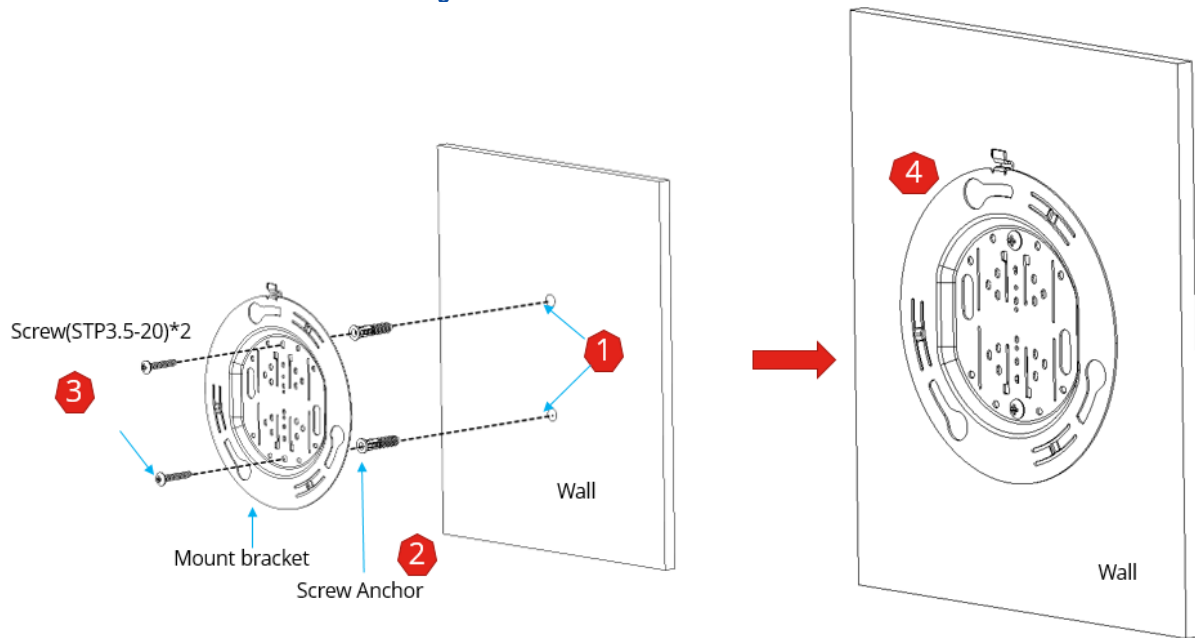

2.4.3 Ceiling Mount

Only 3 widths of T bar are supported, 15mm, 24mm & 38mm.

Figure 7. T Bar Width

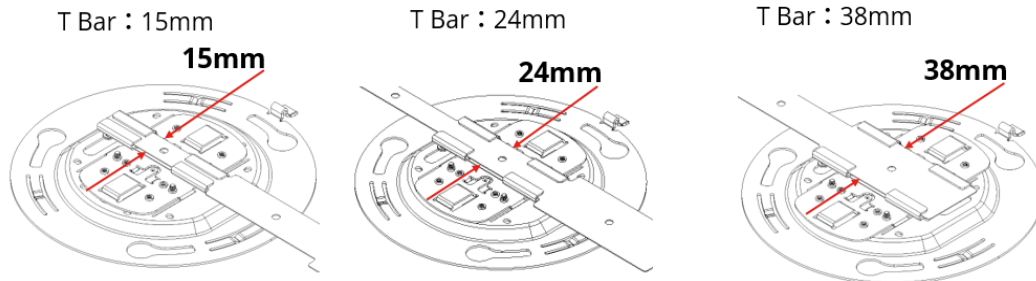

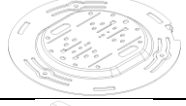



Table 6 List of Items for Ceiling Mount

Items	Qty	Description	Picture
1. Mount base	1	Fix the mount base to NR xCell 46116A with M4 screw*4	
2. Mount bracket	1	Fixed to the T bar, used with the mount base to fix the NR xCell 46116A	
3. Ceiling bracket	2	To fix T bar & mount bracket	
4. M3 Screw	6	To fix the ceiling bracket	
5. M4 Screw	4	To fix the mount base to NR xCell 46116A	

Installation steps,

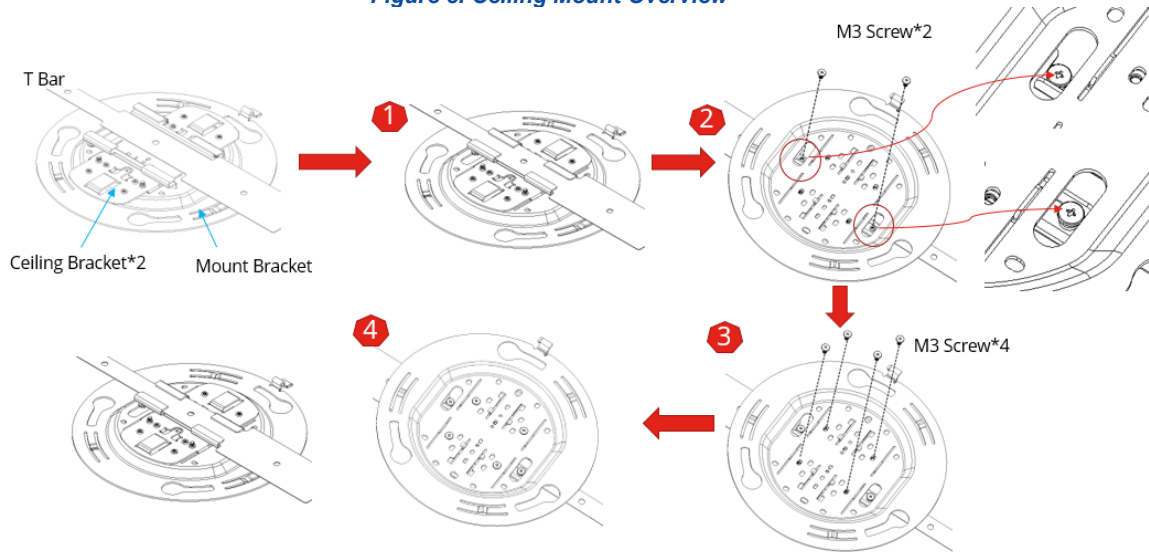

1. Adjust the Ceiling Bracket*2 to fit the width of the T Bar.
2. Fastening M3 screws*2 to fix the Ceiling Bracket on the T Bar.
3. Fastening M3 screws*4 to fix the Ceiling Bracket to the Mount Bracket.
4. End.

Figure 8. Ceiling Mount Overview

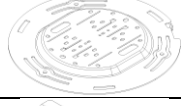
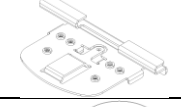
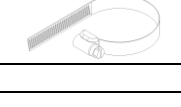

2.4.4 Pole Mount

Table 7. List of Items for Pole Mount

Items	Qty	Description	Picture
1. Mount base	1	Fix the mount base to NR xCell 46116A with M4 screw*4	
2. Mount bracket	1	Used with the mount base to fix the NR xCell 46116A	
3. Ceiling bracket	2	To fix mount bracket & lashing ring	
4. lashing ring	2	Wrapped to a pole	
5. M3 Screw	4	To fix the ceiling bracket to the mount bracket	
6. M4 Screw	4	To fix the mount base to NR xCell 46116A	

Installation steps,

1. Fastening M3 screws*4 to fix the Ceiling Bracket on the Mount Bracket.
2. Pass the lashing ring *2 through the Ceiling Bracket.
3. The lashing ring wraps around the pole and please lock the lashing ring.
4. End.

Figure 9. Pole Mount Overview

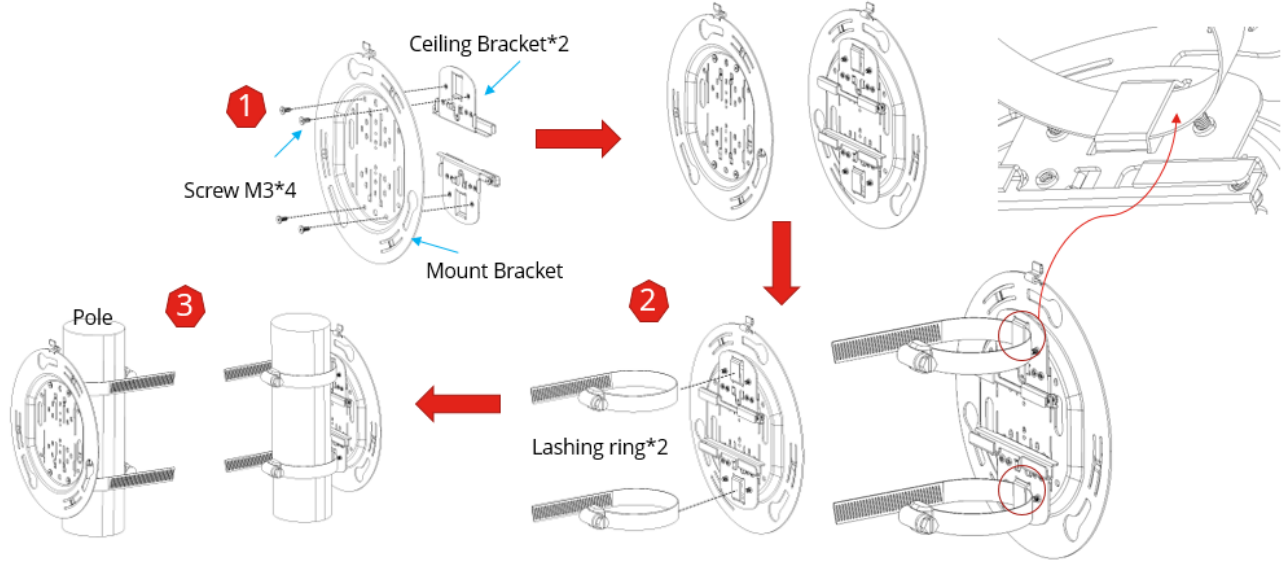

2.4.5 Align the mount base and the mount bracket

1. Align the mount base with the 3 holes on the mount bracket and then turn clockwise to fix it in place.
2. Please note to fasten the screw to prevent NR xCell 46116A from falling.

Figure 10. Align the Mount Base and the Mount Bracket

1. Align the mount base with the 3 holes on the mount bracket and then turn clockwise to fix it in place

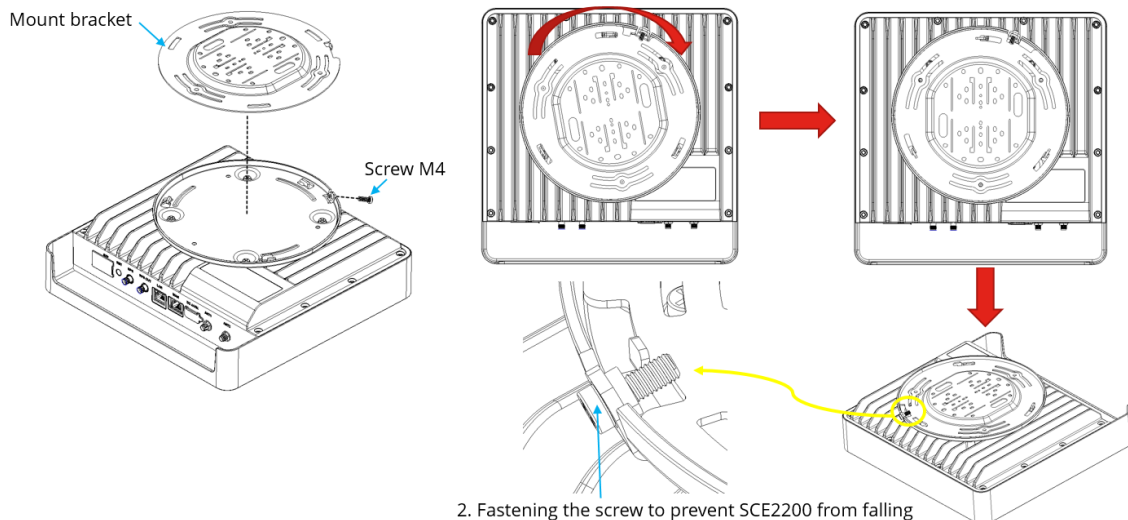

2.5 Route the Cables

After finishing the installation, please connect various cables to the NR xCell 46116A according to Section 2.2, and route the cables in a standard way to keep them looking good. Power on the NR xCell 46116A again, and check the NR xCell 46116A work properly by the status of LED.

Chapter 3 The Askey 5G NR Small Cell Admin Website

This section contains detailed information regarding the Askey 5G NR Small Cell Admin Website, where you can see the device status and make changes in the configurations.

To access the Askey 5G NR Small Cell Admin Website by following these steps:

1. Use a PC/NB connected to the same network as the Askey 5G NR Small Cell
2. Open a browser and enter the IPv4 address of the Askey 5G NR Small Cell as the following URL:
http://<ip address>, or
https://<ip address>

The two primary network ports, WAN and SFP+ in the following Figure, are used to connect the Small Cell backhaul. All the default IP addressing modes are DHCP, and you can change to the Static IP mode on the **Settings: Network** page.

Figure 11. The Network Interfaces of the Askey 5G NR Small Cell



The DBG port is a debug or rescue interface with the default Static IP **192.168.8.100**. You can connect directly to a PC/NB and surf the Admin Web by the URL **http://192.168.8.100** on PC/NB. The network setting of the DBG port could be modified if surfing the Admin Web by the method. But it only supports the Static IP mode starting with **192.168.8.** and doesn't support the gateway and name server.

The IP address of the DBG port will be reset to **192.168.8.100** if performing the factory reset on the Admin Web or holding the RESET button for more than 15 seconds.

The browser might display a warning message for the HTTPS access as the following illustration because the HTTPS server uses a self-signed certificate not signed by the Certificate Chain of Trust. Please click the "Advanced" button and continue surfing the website.

Figure 12. Access the Askey 5G NR Small Cell Admin Website via HTTPS



Your connection isn't private

Attackers might be trying to steal your information from 10.1.108.156 (for example, passwords, messages, or credit cards).

NET::ERR_CERT_AUTHORITY_INVALID

Advanced

Go back



Your connection isn't private

Attackers might be trying to steal your information from 10.1.108.156 (for example, passwords, messages, or credit cards).

NET::ERR_CERT_AUTHORITY_INVALID

Hide advanced

Go back

This server couldn't prove that it's 10.1.108.156; its security certificate is not trusted by your computer's operating system. This may be caused by a misconfiguration or an attacker intercepting your connection.

[Continue to 10.1.108.156 \(unsafe\)](#)

Click here

3.1 Admin Website Overview

3.1.1 Sign In

The homepage of the Admin Website will just be a login form. Please input the default administrator password.

The default password is “AskNodeB” + last 4 digits of the MAC (WAN) (e.g., AskNodeB F504).

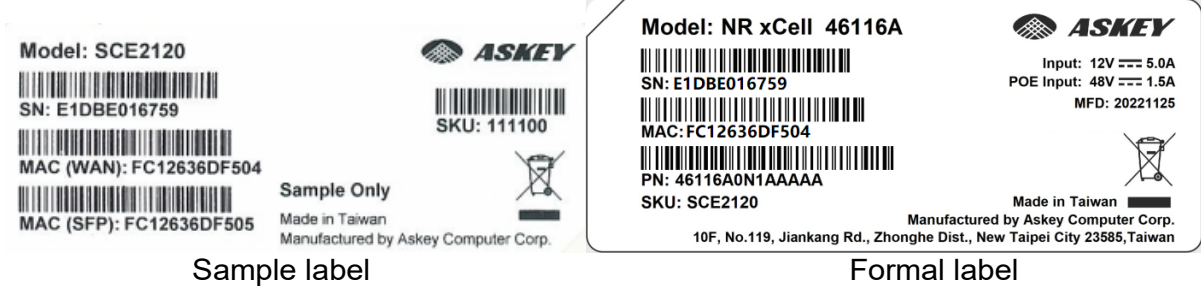

The password is case-sensitive. Letters in the last four digits of the MAC ID should be **UPPER** case.

Figure 13. The Askey 5G NR Small Cell Admin Website Sign-In Form

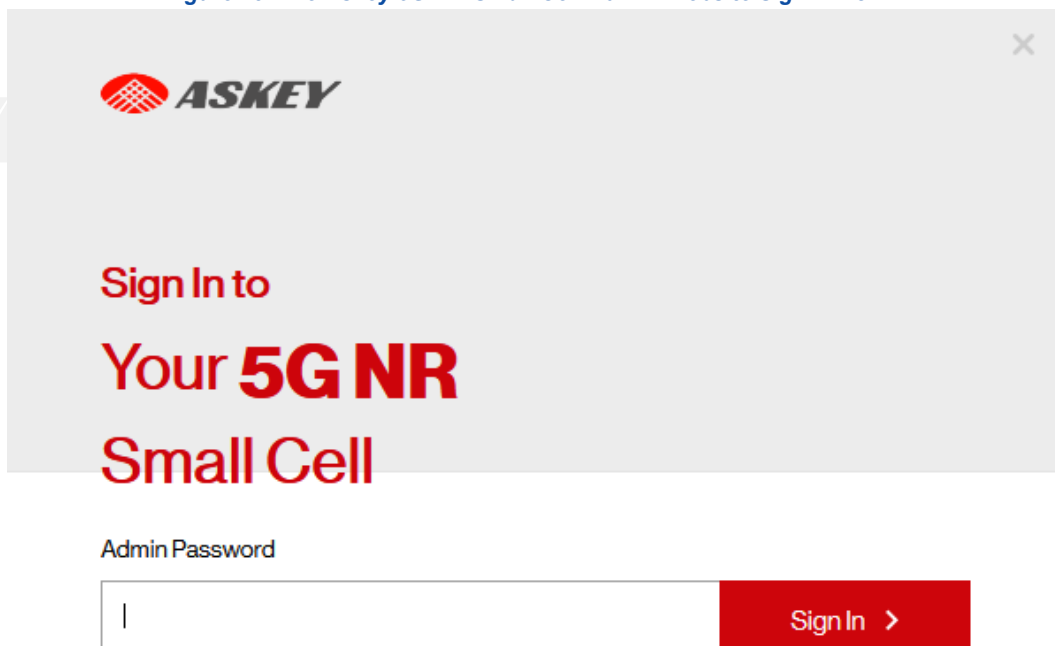

The screenshot shows the sign-in form for the Askey 5G NR Small Cell Admin Website. It features the Askey logo at the top left. The main heading reads 'Sign In to Your 5G NR Small Cell'. Below this is a text input field labeled 'Admin Password' containing a single vertical bar. To the right of the input field is a red button with the text 'Sign In >'.

After the successful login, the Admin Website gives you the device information of the Askey 5G NR Small Cell.

Figure 14. The Askey 5G NR Small Cell Admin Website Overview

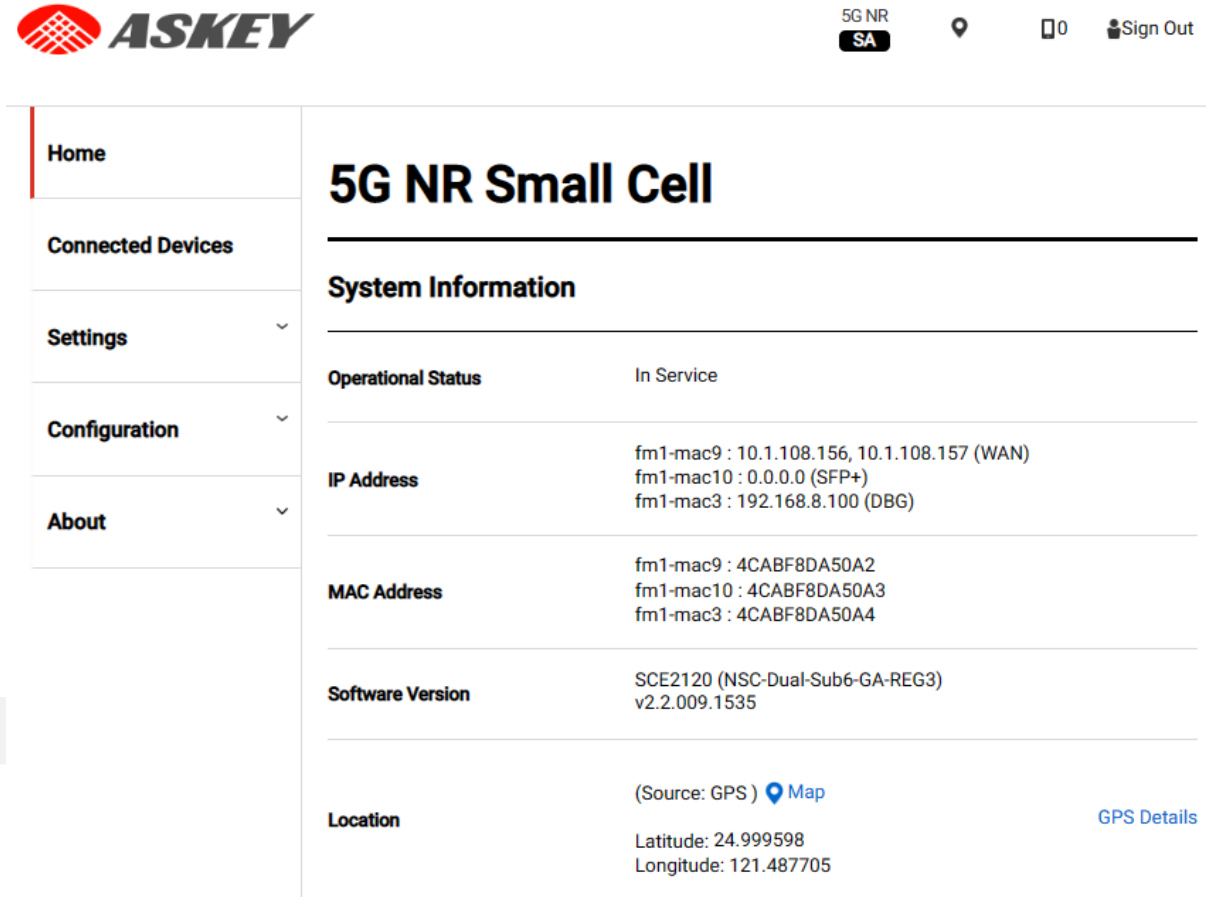

System Information	
Operational Status	In Service
IP Address	fm1-mac9 : 10.1.108.156, 10.1.108.157 (WAN) fm1-mac10 : 0.0.0.0 (SFP+) fm1-mac3 : 192.168.8.100 (DBG)
MAC Address	fm1-mac9 : 4CABF8DA50A2 fm1-mac10 : 4CABF8DA50A3 fm1-mac3 : 4CABF8DA50A4
Software Version	SCE2120 (NSC-Dual-Sub6-GA-REG3) v2.2.009.1535
Location	(Source: GPS) Map Latitude: 24.999598 Longitude: 121.487705 GPS Details

The page shows basic device information such as the Operational Status, IP Address, MAC address, the software version, the GPS fixed location, and the Map illustration.

The quick reference icons on the upper right of the Welcome page indicate service status, GPS status, number of connected devices, and sign-in status as the following illustrators.

Figure 15. The Askey 5G NR Small Cell Quick Reference Icons

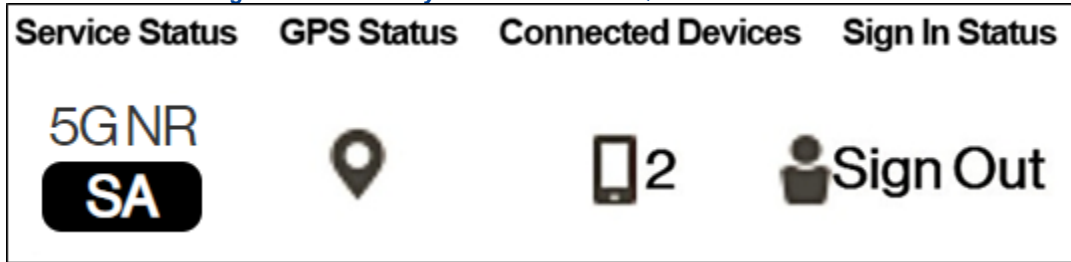
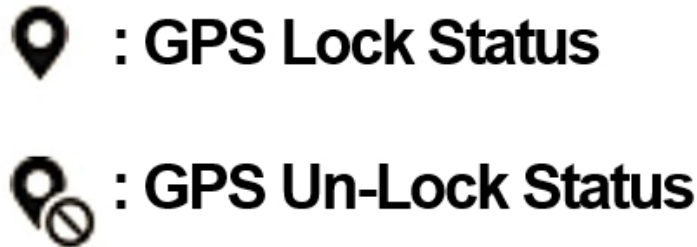

Figure 16. The Askey 5G NR Small Cell Service Status

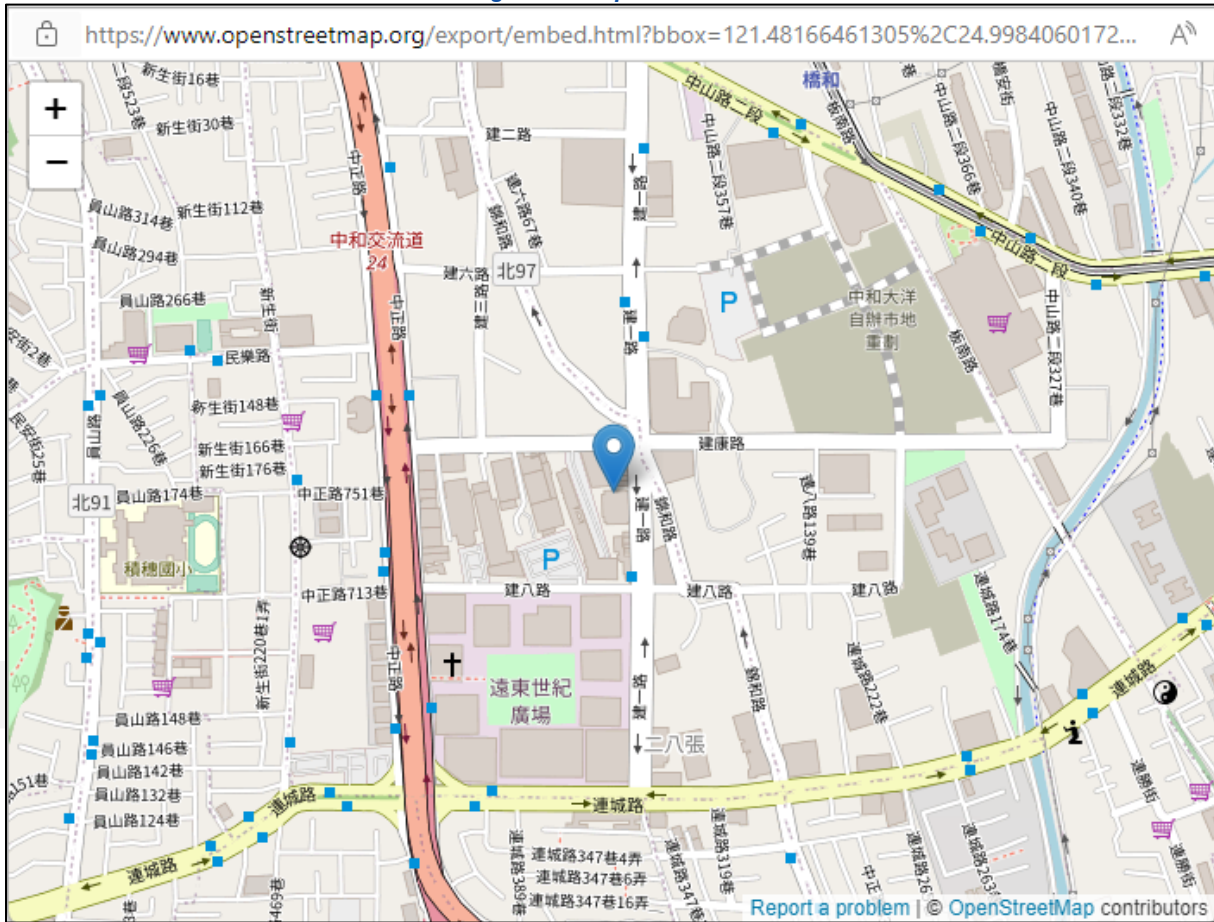

Figure 17. The Askey 5G NR Small Cell GPS Status



The GPS coordinates will be displayed at the bottom of the page if the GPS location is acquired. You can click the “**GPS Detail**” link to surf the GPS information page or click the “**Map**” to open the map illustration generated by ©**OpenStreetMap** as the following:

Figure 18. Map Illustration



3.2 Home

The Homepage provides all the Askey 5G NR Small Cell information.

Figure 19. The Askey 5G NR Small Cell Home Page

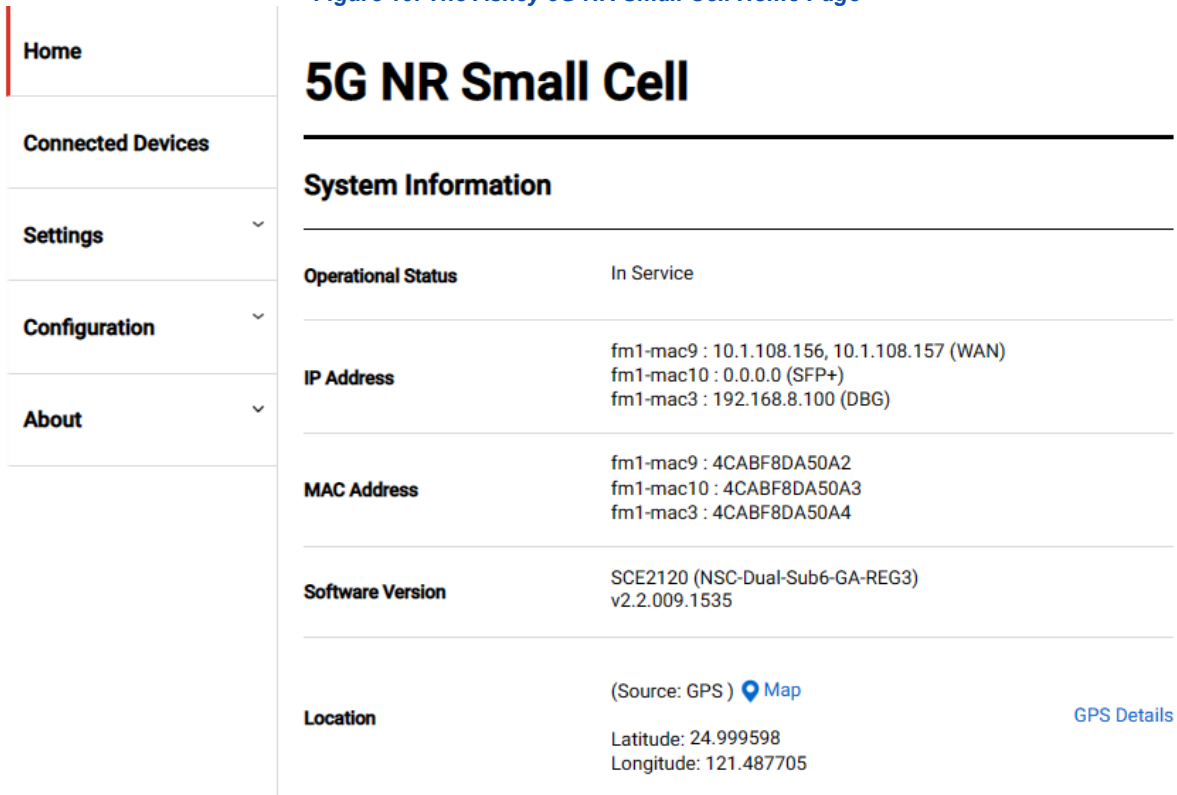



Table 8. The Askey 5G NR Small Cell Home Page

Items	Descriptions
Operational Status	The current operational status of the Askey 5G NR Small Cell.
IP Address	The Internet Protocol (IP) address of the Askey 5G NR Small Cell for the WAN, SFP+, and DBG ports, or Bridge interface (for NSA mode).
MAC Address	The MAC address associated with the device which can also be found on a sticker attached to the Askey 5G NR Small Cell.
Software Version	The current software version of the Askey 5G NR Small Cell includes the model name and access mode.
Location	It is the physical location of the Askey 5G NR Small Cell as reported by GPS.
Map 	Clicking this link plots the location of the Askey 5G NR Small Cell on an Open Street Map. The Open Street Map link is available only if the GPS Status is "Location Acquired".

3.3 Connected Devices

The connected devices page shows the current connected users.

Figure 20. The Askey 5G NR Small Cell Connected Devices Page

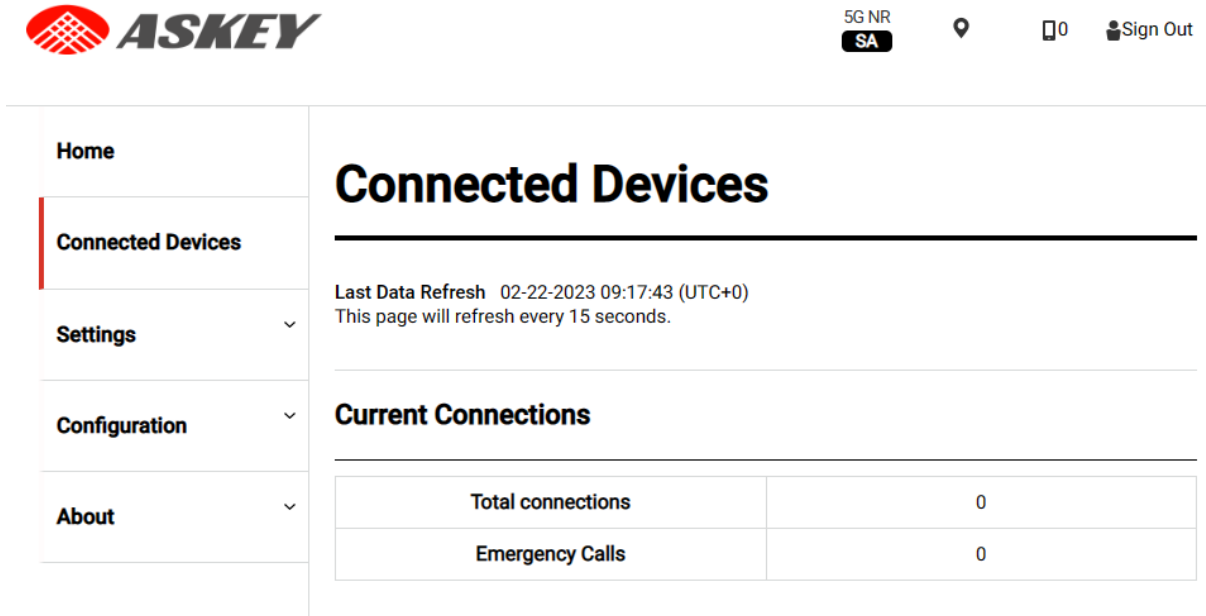

Connected Devices

Last Data Refresh 02-22-2023 09:17:43 (UTC+0)
This page will refresh every 15 seconds.

Current Connections

Total connections	0
Emergency Calls	0

Table 9. The Askey 5G NR Small Cell Connected Devices

Item	Description
Last Data Refresh	The local time when this page was last refreshed.
Total Connections	The number of wireless devices (phone, tablets, or other data devices) currently connected to the Askey 5G NR Small Cell with an active call or data session.
Emergency Calls	The number of wireless devices currently connected to the Askey 5G NR Small Cell with an active call to emergency services.

3.4 Settings

3.4.1 Network

From the Askey 5G NR Small Cell Network page, you can check and modify the detailed network settings. The settings will be effective immediately without rebooting.

Figure 21. The Askey 5G NR Small Cell Network Page

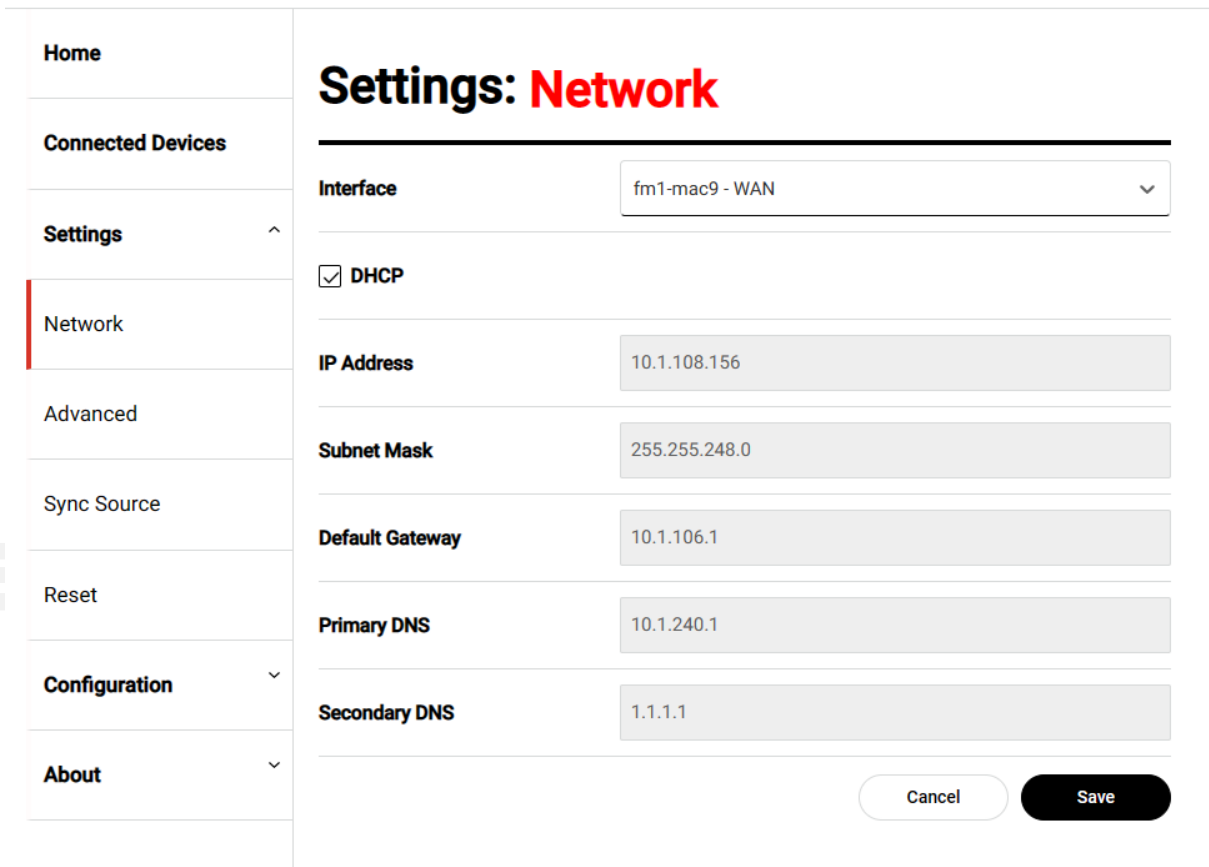

If the device has the multiple network interfaces, you can choose the interface by clicking the select bar as the following illustration:

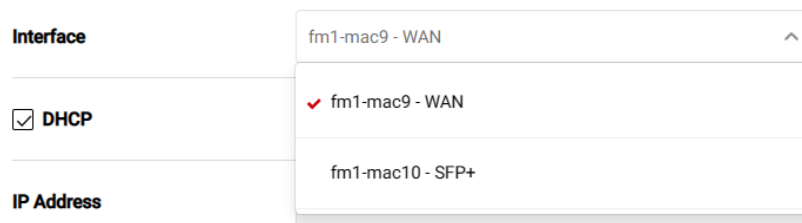

Figure 22. The Askey 5G NR Small Cell Network Page for the 2nd Interface

- Home
- Connected Devices
- Settings ^
- Network
- Advanced
- Sync Source
- Reset
- Configuration v
- About v

Settings: Network

Interface fm1-mac10 - SFP+ v

DHCP

IP Address 0.0.0.0

Subnet Mask 0.0.0.0

Default Gateway

Primary DNS

Secondary DNS

Cancel
Save

When the DHCP checkbox is disabled, you can manually set the network configurations for the specific interface. Click the IP Address or Subnet Mask item will pop up a dialog window to edit the multiple static IP addresses.

Interface fm1-mac9 - WAN v

DHCP

IP Address 10.1.108.156 Click 

Subnet Mask 255.255.248.0

Default Gateway 10.1.106.1

Figure 23. The Multiple Static IP Addresses Dialog Window

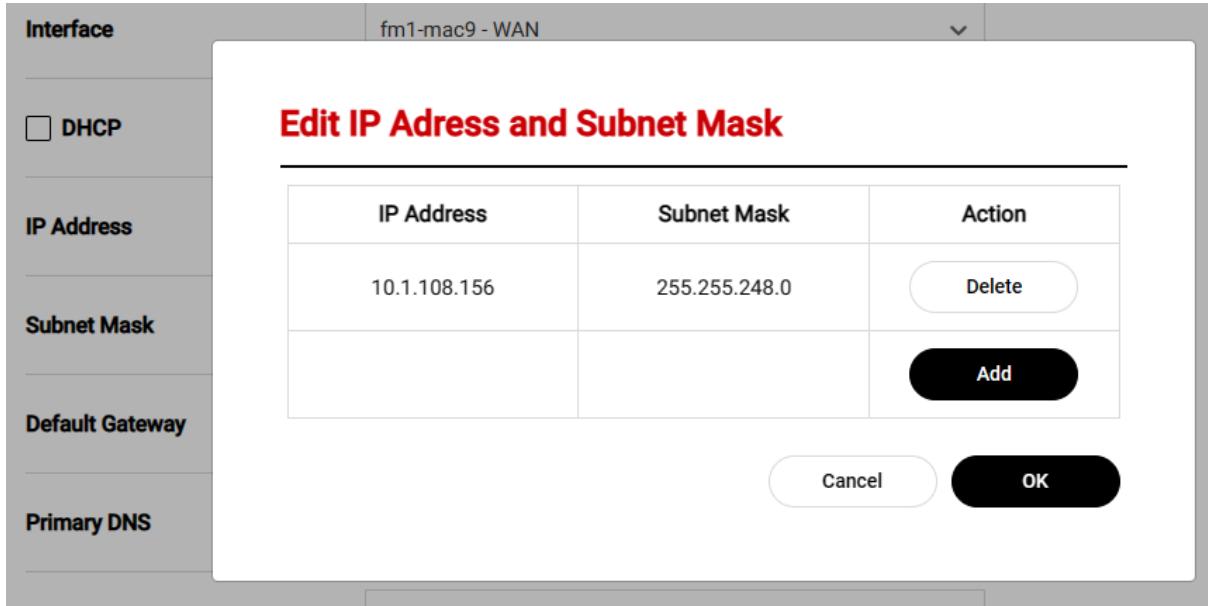

The IP address and subnet mask value can be modified directly on the dialog window, and remove the item by clicking the Delete button. If you want to add a new item, click the Add button and edit the configuration.

Figure 24. Add a new Item in Static IP Addresses Dialog Window

Edit IP Address and Subnet Mask

IP Address	Subnet Mask	Action
10.1.108.156	255.255.248.0	Delete
10.1.108.157	255.255.248.0	Delete
		Add

Buttons: Cancel, OK

All IP addresses and Subnet Mask will display by the comma-separated format on the Admin Website. Click the Save button to activate the multiple IP addresses without rebooting.

Figure 25. The Askey 5G NR Small Cell Network Page with the multiple IP addresses

Settings: Network

Interface	fm1-mac9 - WAN
<input type="checkbox"/> DHCP	
IP Address	10.1.108.156, 10.1.108.157
Subnet Mask	255.255.248.0, 255.255.248.0
Default Gateway	10.1.106.1
Primary DNS	10.1.240.1
Secondary DNS	1.1.1.1
	<input type="button" value="Cancel"/> <input type="button" value="Save"/>

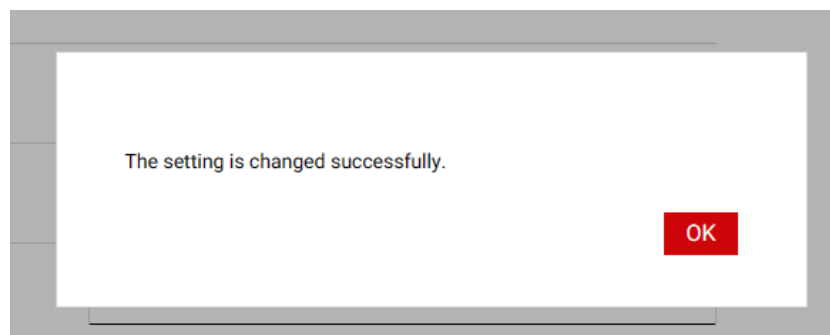

After the setting is changed successfully, you can use the browser to access the Admin Website by the new alternate static IP address.

Figure 26. The Askey 5G NR Small Cell Admin Website with the alternate static IP address

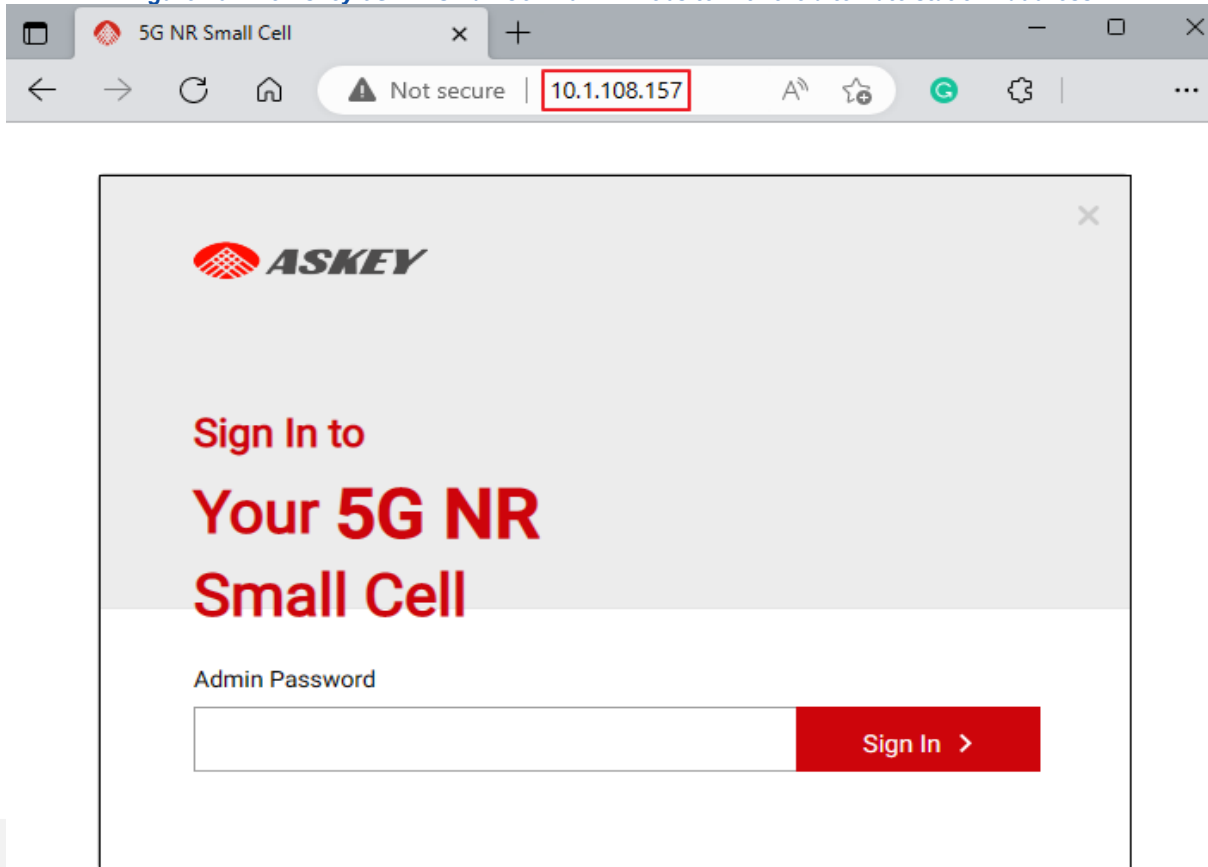

If you access the Admin Web by the IP address of the DBG interface displayed on the homepage, you can find the DBG item in the Interface select box as the following:



It means that you can click the item to modify the IP address of the DBG interface. As per the above statement, the IP address of the DBG interface only supports static IP starting with 192.168.8. and doesn't support to modify the gateway or name server. The GUI has some differences from other ports, as shown in the following illustration:

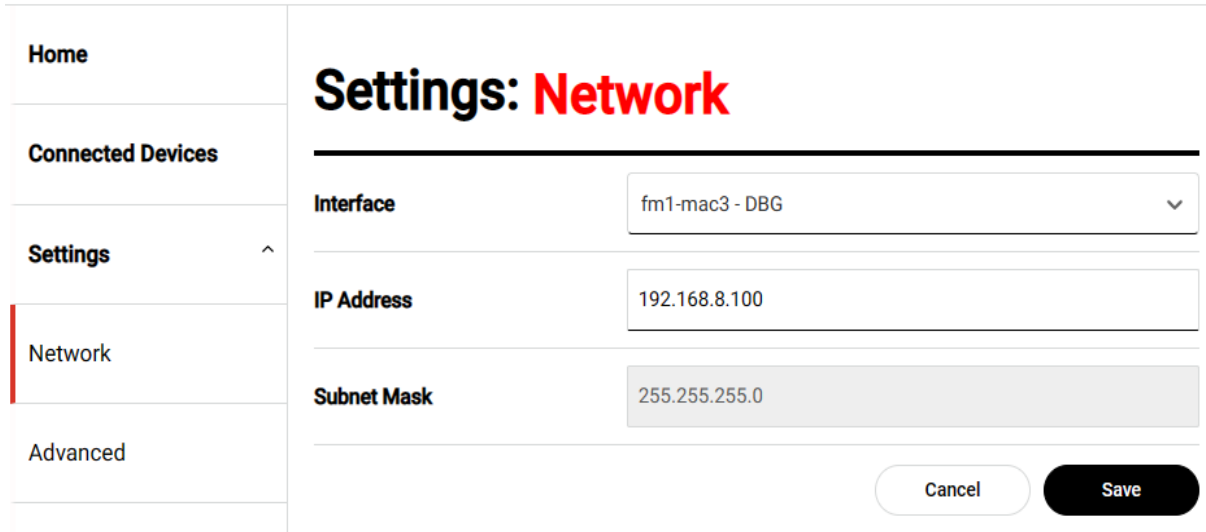

The screenshot shows the 'Settings: Network' page in the ASKEY 5G NR Small Cell Admin Website. The left sidebar contains navigation options: Home, Connected Devices, Settings (expanded), Network (selected), and Advanced. The main content area displays the following settings:

Interface	fm1-mac3 - DBG
IP Address	192.168.8.100
Subnet Mask	255.255.255.0

At the bottom right, there are two buttons: 'Cancel' and 'Save'.

After you modify the new IP Address of the DBG port, you need to re-access the Admin Website with the new IP address.

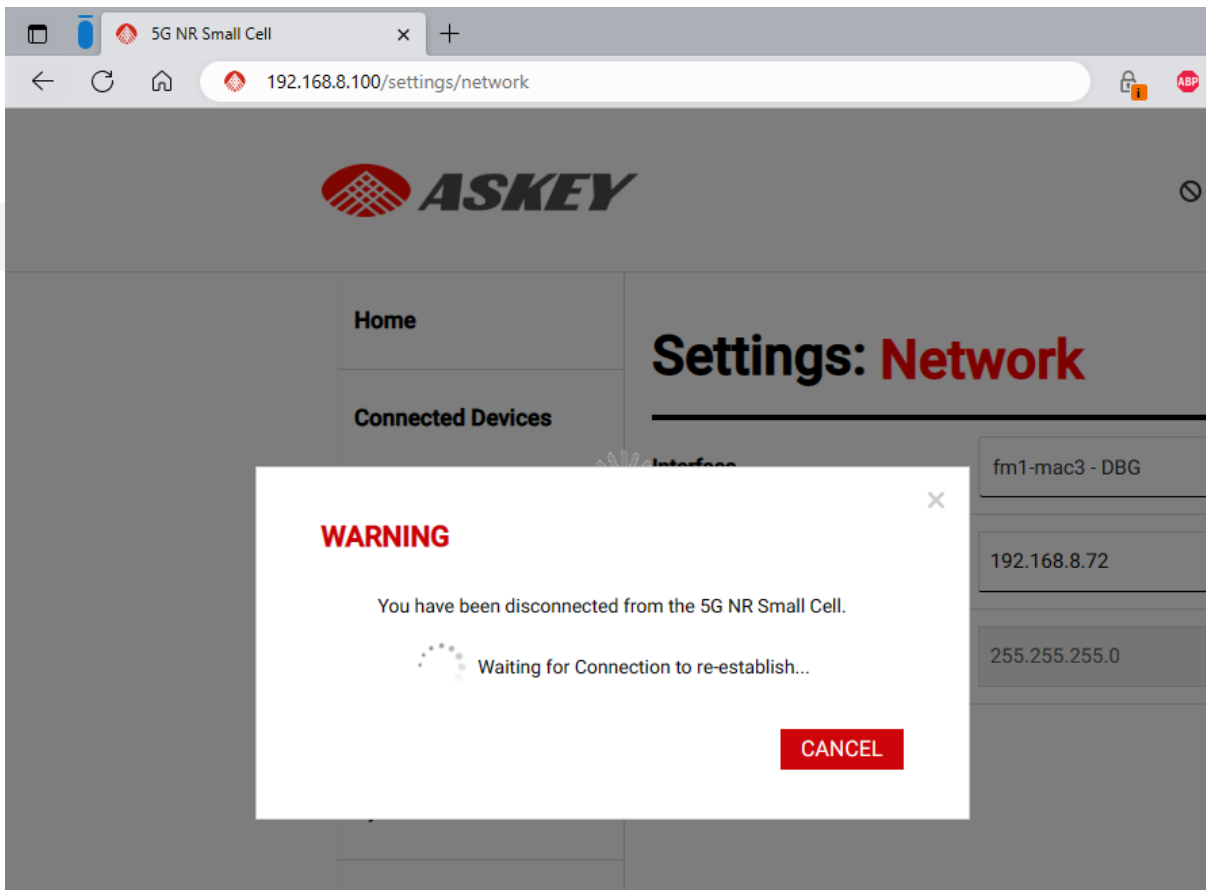

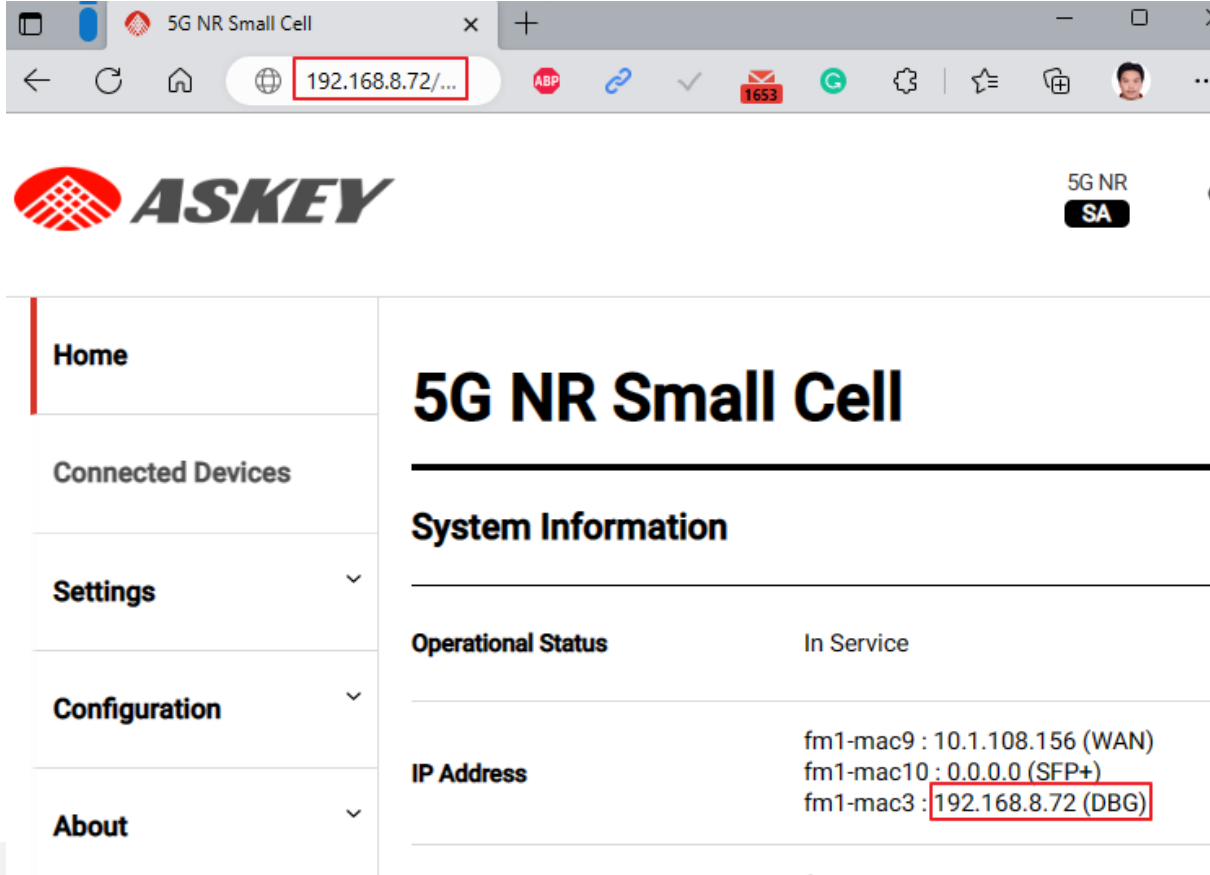

Table 10. The Askey 5G NR Small Cell Network

Item	Description
DHCP	This is a checkbox item. When it is checked (default), the DHCP is enabled, and the local DHCP server shall provide the IP configurations to the device. The user may uncheck this box to specify the multiple static IP configuration.
Default Gateway	If the DHCP is enabled, this field is read-only. It shows the DHCP-allocated default gateway IP address. If the DHCP is disabled, this field is read-write and indicates the user-defined Default Gateway IP address.
IP Address	If the DHCP is enabled, this field is read-only. It shows the DHCP-allocated IPv4 address. If the DHCP is disabled, this field is read-write and indicates the user-defined IPv4 address. It supports multiple combinations of the static IP address and Subnet Mask.
Subnet Mask	If the DHCP is enabled, this field is read-only. It shows the DHCP-allocated Subnet Mask. If the DHCP is disabled, this field is read-write and shows the user-defined Subnet Mask. It supports multiple combinations of the static IP address and Subnet Mask.
Primary DNS	If the DHCP is enabled, this field is read-only. It shows the DHCP allocated Primary DNS Server's IP address. If the DHCP is disabled, this field is read-write and shows the user-defined Primary DNS Server's IP address.
Secondary DNS	If the DHCP is enabled, this field is read-only. It shows the DHCP allocated Secondary DNS Server's IP address. If the DHCP is disabled, this field is read-write and indicates the user-defined Secondary DNS Server's IP address.

3.4.2 Advanced

The Askey 5G NR Small Cell Advanced page provides all cells' information and sync status.

Figure 27. The Askey 5G NR Small Cell Advanced Page

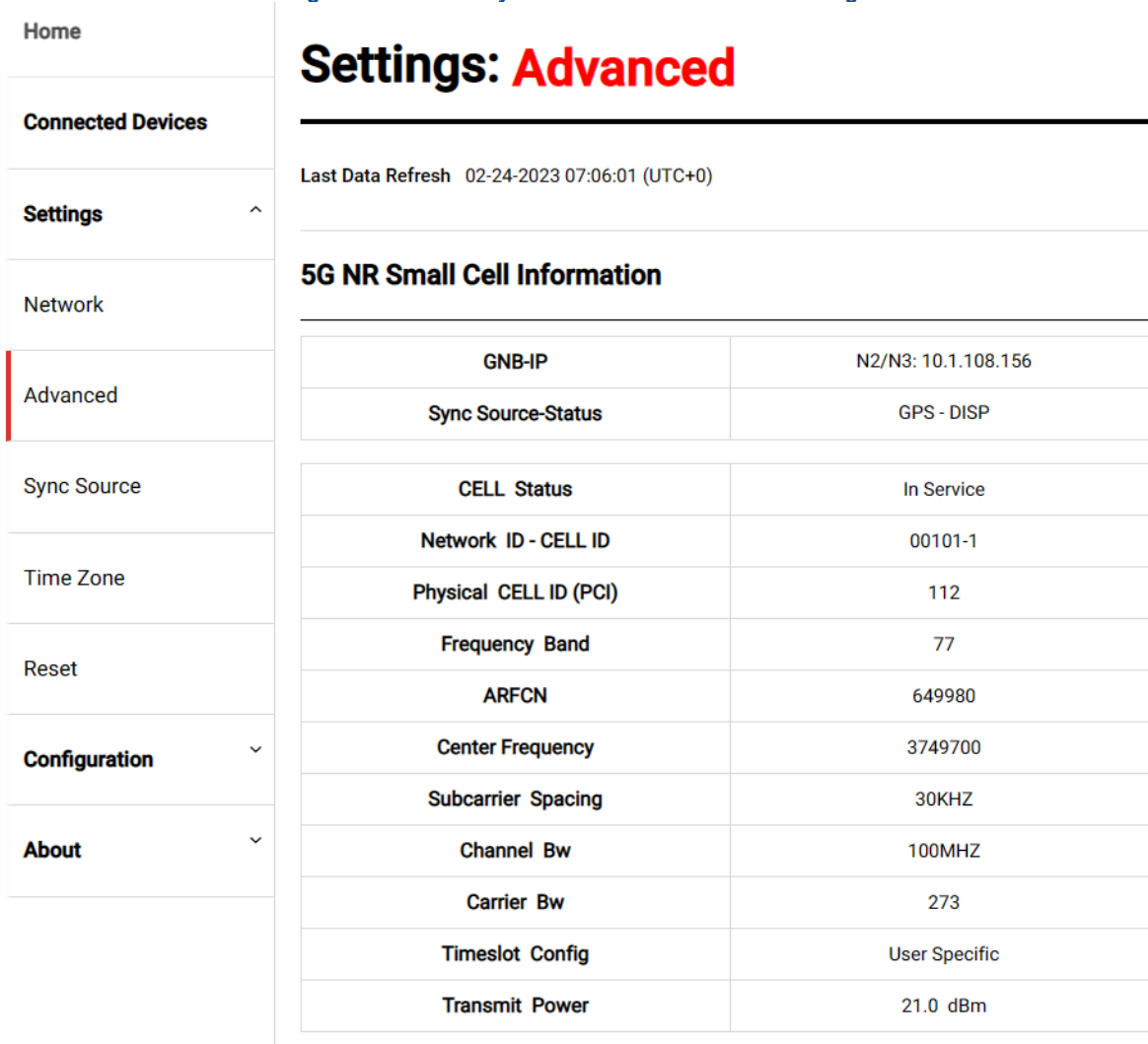

The screenshot shows the 'Settings: Advanced' page for a 5G NR Small Cell. The sidebar menu includes Home, Connected Devices, Settings (expanded), Network, Advanced (selected), Sync Source, Time Zone, Reset, Configuration, and About. The main content area displays the following information:

Settings: Advanced

Last Data Refresh 02-24-2023 07:06:01 (UTC+0)

5G NR Small Cell Information

GNB-IP	N2/N3: 10.1.108.156
Sync Source-Status	GPS - DISP
CELL Status	In Service
Network ID - CELL ID	00101-1
Physical CELL ID (PCI)	112
Frequency Band	77
ARFCN	649980
Center Frequency	3749700
Subcarrier Spacing	30KHZ
Channel Bw	100MHZ
Carrier Bw	273
Timeslot Config	User Specific
Transmit Power	21.0 dBm

Table 11. The Askey 5G NR Small Cell Advanced

Item	Description
Last Data Refresh	The local time when this page was last refreshed.
5G NR Small Cell Information	This table shows the detailed information for The Askey 5G NR Small Cell. Where: •GNB-IP: The IP address of gNodeB •Sync Source-Status: The sync source and sync state
Serving Cell information	If the gNB processes are running, it will show the information of the serving cell(s). Additionally, the transmit power will show the correct value when the cell status is in-service.

3.4.3 Sync Source

The Askey 5G NR Small Cell Sync Source page provides the current sync state and the sync status for each sync source. It also allows the user to modify the sync type, priority, and detailed PTP configurations.

Figure 28. The Askey 5G NR Small Cell Sync Source Page

Home

Connected Devices

Settings ^

Network

Advanced

Sync Source

Time Zone

Reset

Configuration v

About v

Settings: Sync Source

Sync State DISP

Sync Type Auto v

Source	GPS
Priority	255
Status	Active

Source	PTP
Priority	100
Status	Standby
PTP Interface	fm1-mac9 - WAN v
Domain Number	44
PTP Mode	G.8275.2 v
PTP UDP IP	10.1.106.22

Cancel
Save

The sync type can be **Auto** or **Manual**. If the type is **Manual**, you should specify **GPS** or **PTP** as the sync source.

Sync Type Manual v

Sync Source GPS ^

Source	✓ GPS
Priority	PTP

The PTP Mode will be **G.8275.1** or **G.8275.2**. If the mode is **G.8275.2**, it should also specify the PTP UDP IP.

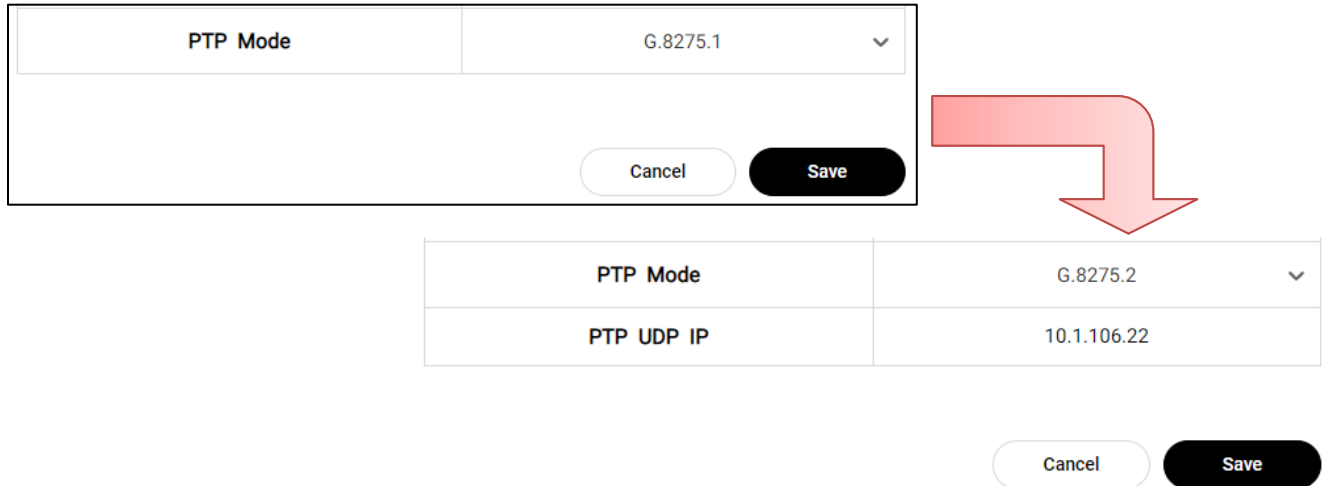

Table 12. The Askey 5G NR Small Cell Sync Source

Item	Description
Sync State	It indicates the current sync state. It should be INIT , HARD_SYNC , DISP , RESYNC , or HOLDOVER . The cell processes will start until the sync state is DISP
Sync Type / Sync Source	It indicates the sync source choice mechanism. The Auto type will try the multiple sync sources based on the priority value. For the Manual type, it should specific the sync source be GPS or PTP . (For the small cell with network bridge mode, the sync source is only GPS)
Priority	If the sync type is Auto, the higher priority value will be tested earlier. The priority value should be the integer from 1 to 255 .
Status	It indicates the sync status for source GPS or PTP. The status will be Standby or Active .
PTP Interface	It indicates which network interface the gNB connects to the PTP server.
Domain Number	Specific the PTP clock domain by an integer in the range of 0 to 127 .
PTP Mode / PTP UDP IP	It indicates the current PTP mode, which supports G.8275.1 and G.8275.2 . If the mode is G.8275.2 , it should also specify the PTP UDP IP .

3.4.4 Time Zone

The Askey 5G NR Small Cell Time Zone page allows the user to adjust the Time Zone Offset for the data refresh time on the Admin Website

Figure 29. The Askey 5G NR Small Cell Time Zone Page

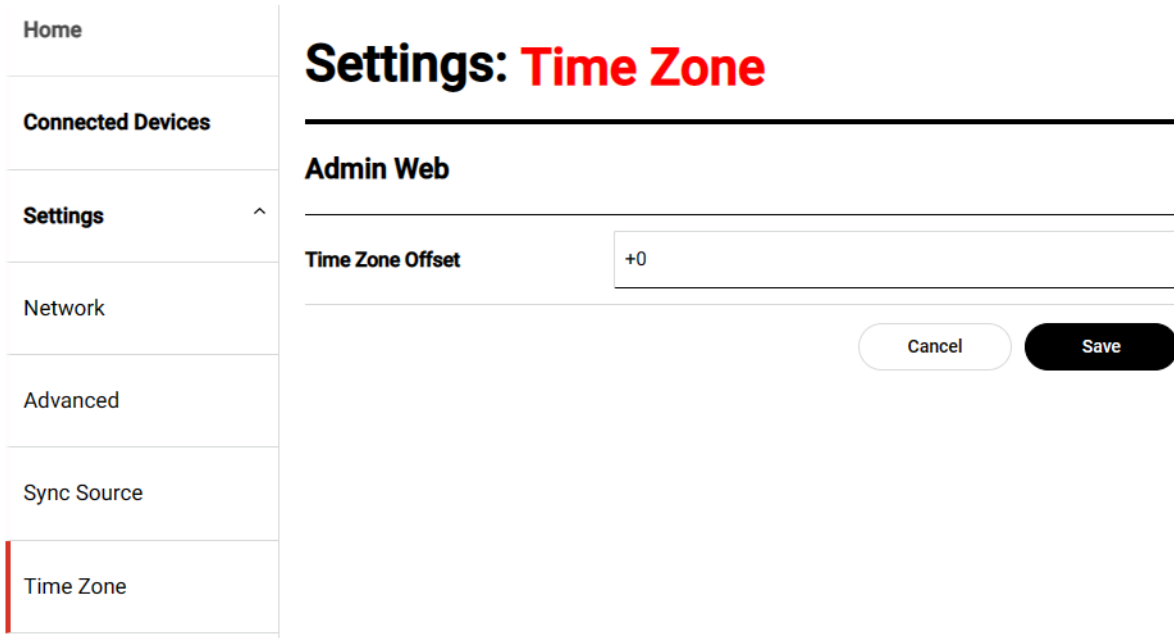

Home

Connected Devices

Settings ^

Network

Advanced

Sync Source

Time Zone

Settings: Time Zone

Admin Web

Time Zone Offset

Cancel Save

The default time zone offset is +0 (UTC). If the page will refresh automatically, the last data refresh will be displayed on the page as the following illustration:

Connected Devices

Last Data Refresh 02-24-2023 07:31:01 (UTC+0)
This page will refresh every 15 seconds.

The Time Zone Offset can adjust as an integer number that ranges from -12 to 14 and activates without rebooting.

Connected Devices

Last Data Refresh 02-24-2023 15:36:21 (UTC+8)
This page will refresh every 15 seconds.

3.4.5 Reset

The Askey 5G NR Small Cell Reset page allows users to remotely restart or factory reset the 5G NR Small Cell.

Figure 30. The Askey 5G NR Small Cell Reset Page

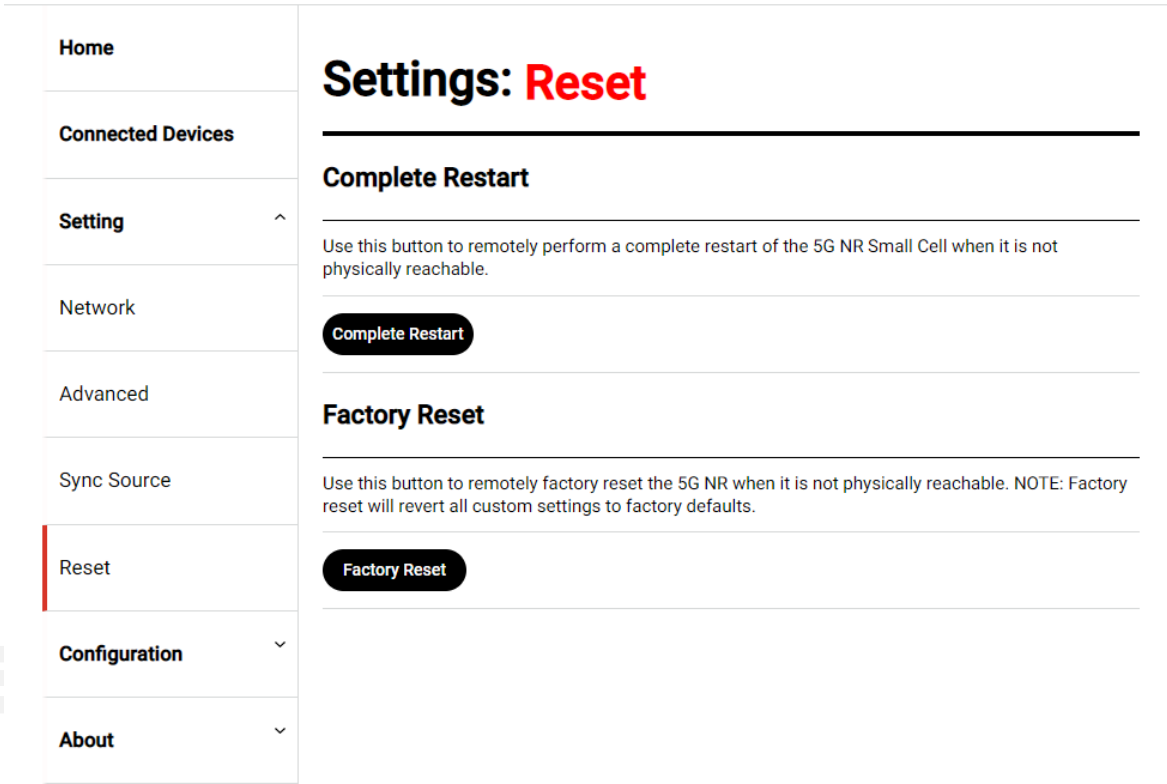

Factory reset will revert the custom settings to factory default settings. The admin website will pop up the following prompt message when clicking the Factory Reset button:

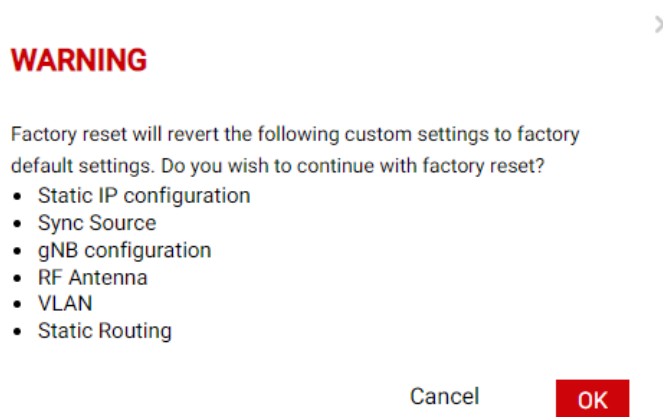

If the network setting of the Askey 5G NR Small Cell is wrong or you cannot get the current IPv4 address, such that you cannot access the Admin Website by IPv4. You can use the MAC to IPv6 link-local address to

access the Admin Website by the URL [http://\[IPv6 Link-Local Address\]/](http://[IPv6 Link-Local Address]/) in the same LAN. Please check the topic “**Access the Admin Website by IPv6 Link-Local Address**” in chapter 4. Or, if the Askey 5G NR Small Cell is near you, you can hold the reset button for more than 15 seconds and release, it will trigger the device to perform the factory reset. The following illustration is the reset button location of the device. After performing the factory reset, the Askey 5G NR Small Cell will get the IPv4 address from the DHCP server.

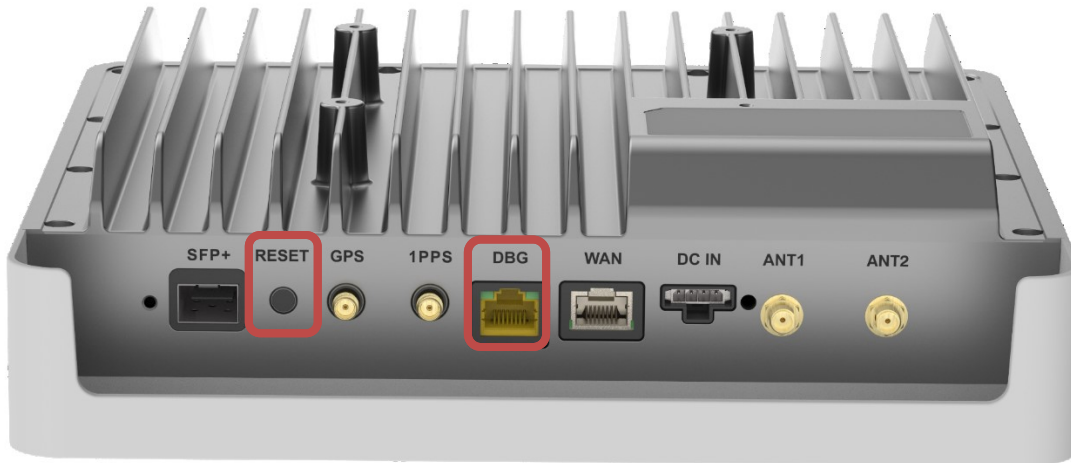

3.5 Configuration

3.5.1 Dashboard

This Askey 5G NR Small Cell Dashboard page shows the integrated small cell information, including the service and location data.

Figure 31. The Askey 5G NR Small Cell Dashboard Page

Home	<h2>Configuration: Dashboard</h2> <hr/> <p>gNB IP Address N2/N3: 10.1.108.156</p> <hr/> <p>Cell State In Service</p> <hr/> <p>Active UEs 0</p> <hr/> <p>GNSS Fixed Status Location Acquired</p> <hr/> <p>Sync Capability GPS</p> <hr/> <p>Sync State DISP</p> <hr/> <p>Ping Status</p> <ul style="list-style-type: none"> ■ AMF (10.1.106.51) ■ EMS (acs6.askey.ga)
Connected Devices	
Settings	
Configuration	
Dashboard	
gNB	
Neighbor Cell	
RF Antenna	
VLAN	

Table 13. The Askey 5G NR Small Cell Dashboard

Items	Descriptions
gNB IP Address	The IP address of gNodeB. Support separately specifying the gNB local interface with AMF (N2 interface) and the UPF (N3 interface) on the gNB configuration page. The IP address is the same value for the N2 and N3 interfaces by default.
Cell State	The current state of the small cell. It will be Not In-Service or In-Service
Active UEs	The number of wireless devices (phone, tablets, or other data devices) currently connected to the Askey 5G NR Small Cell
GNSS Fixed Status	The fixed status of GNSS. It will be Searching signal or Location Acquired
Sync Capability	The sync capability of the device
Sync State	It indicates the current sync state. It should be INIT , HARD_SYNC , DISP , RESYNC , or HOLDOVER . The cell processes will start until the sync state is DISP
Ping Status	Check whether the network connection status of the following server by ping command (ICMP): AMF , EMS , KPI , and SAS

3.5.2 gNB

This Askey 5G NR Small Cell gNB page shows the principal configurations of CU and DU. There are some items different between SA and NSA mode. These items on Web GUI will be read-only in the remote provision method except for gNB IP because the value of gNB IP address may be one of the physical network interfaces or VLAN interfaces.

Figure 32. The Askey 5G NR Small Cell gNB Page

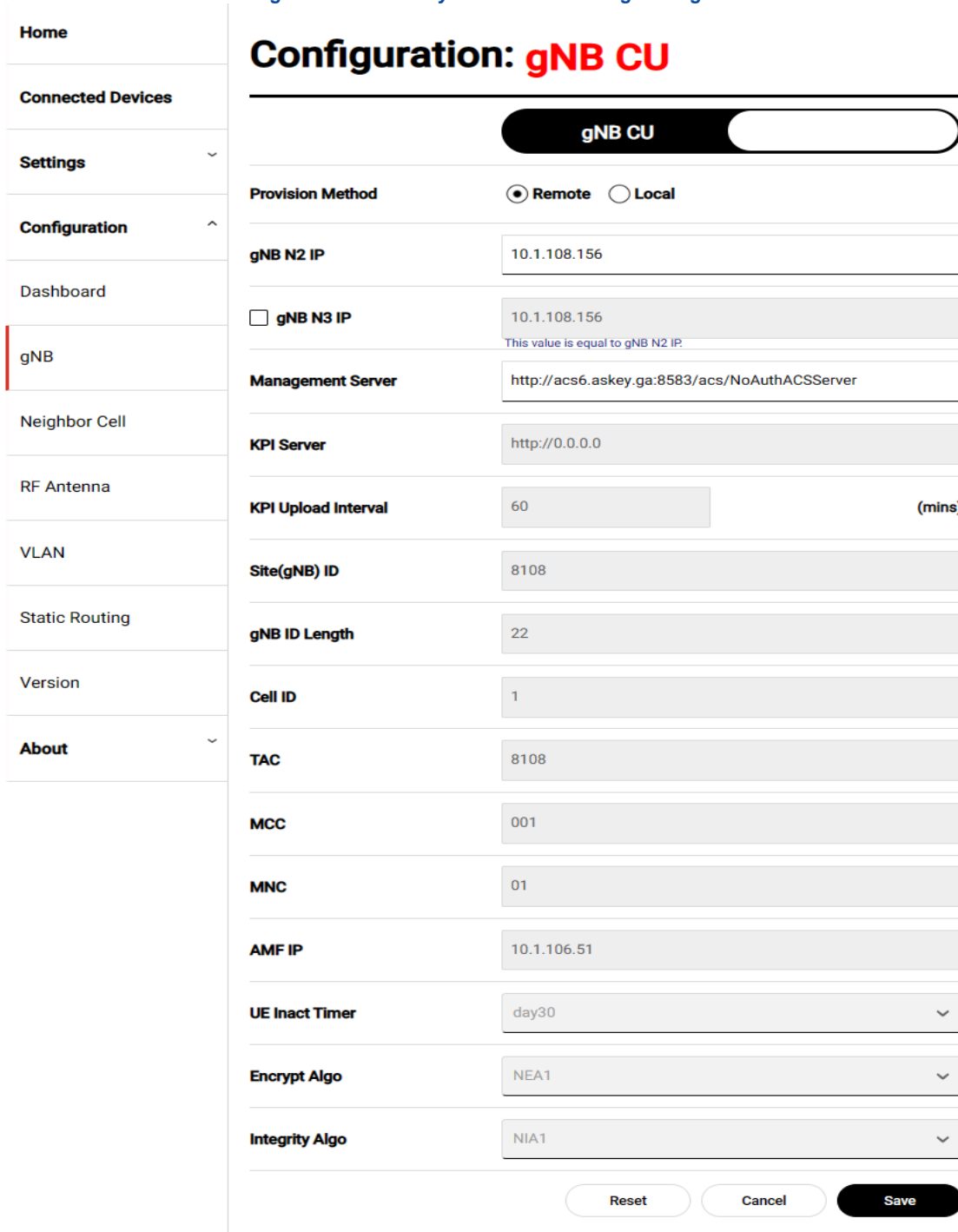

The screenshot displays the 'Configuration: gNB CU' page in the Askey 5G NR Small Cell Admin Website. A left-hand navigation menu includes options like Home, Connected Devices, Settings, Configuration, Dashboard, gNB (highlighted), Neighbor Cell, RF Antenna, VLAN, Static Routing, Version, and About. The main configuration area features a toggle for 'gNB CU' and radio buttons for 'Provision Method' (Remote selected, Local unselected). Below this, various fields are shown, some of which are read-only (greyed out): gNB N2 IP (10.1.108.156), gNB N3 IP (10.1.108.156, with a note that it equals the N2 IP), Management Server (http://acs6.askey.ga:8583/acs/NoAuthACSServer), KPI Server (http://0.0.0.0), KPI Upload Interval (60 mins), Site(gNB) ID (8108), gNB ID Length (22), Cell ID (1), TAC (8108), MCC (001), MNC (01), AMF IP (10.1.106.51), UE Inact Timer (day30), Encrypt Algo (NEA1), and Integrity Algo (NIA1). At the bottom, there are buttons for 'Reset', 'Cancel', and 'Save'.

You can change the local provision method by clicking the option **Local** in the Provision Method. After modifying the configurations, you can save these configurations by clicking the **Save** button. If there are some wrong settings, such that the cell cannot provide the 5G NR service, you can click the Default button to restore the **default** setting.

Figure 33. The Local Provision Method in gNB Configuration

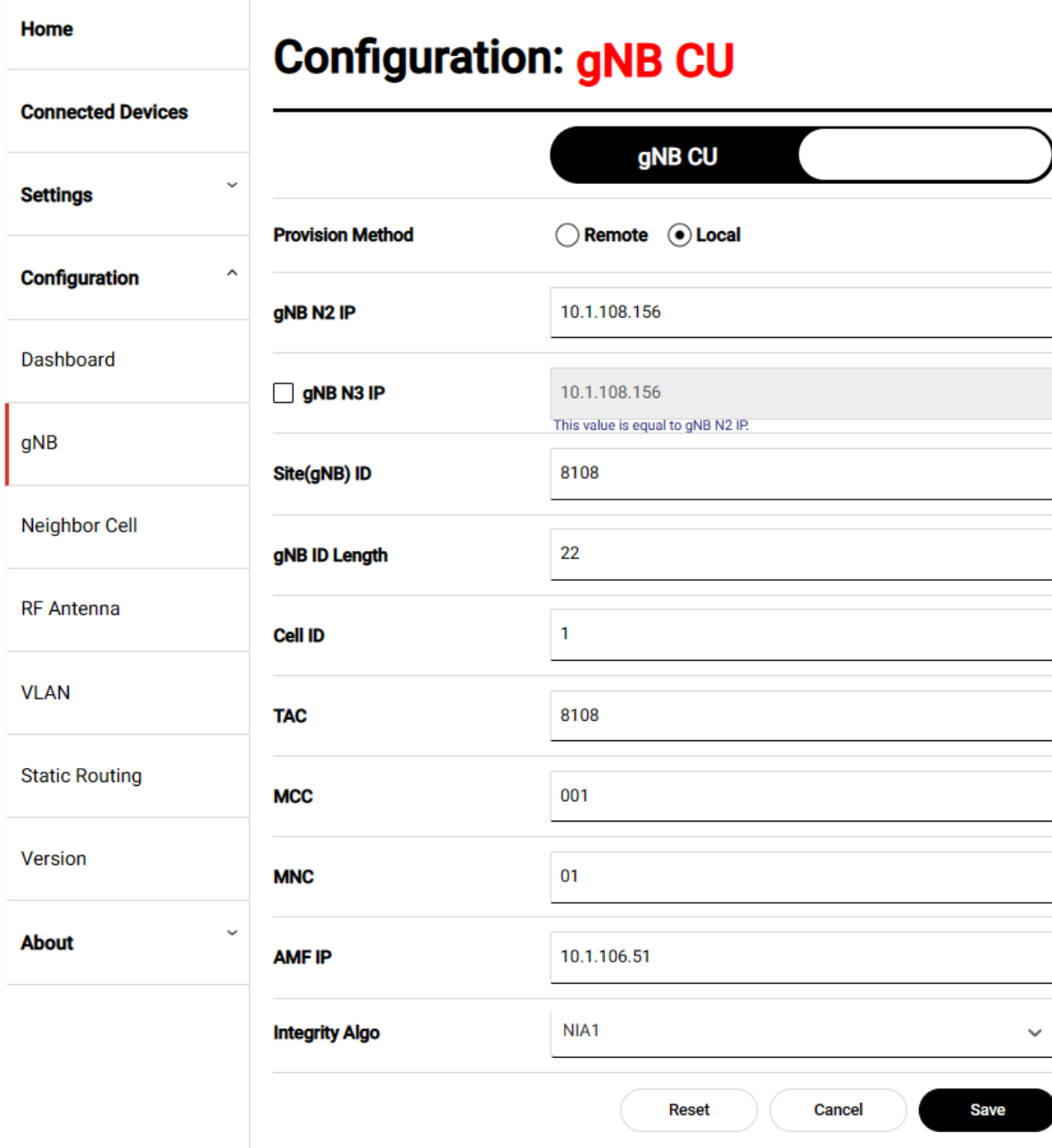

The screenshot shows the 'Configuration: gNB CU' page. On the left is a navigation menu with 'gNB' selected. The main content area has a toggle for 'gNB CU' (currently on) and 'Provision Method' set to 'Local'. Below are several configuration fields:

Field Name	Value
gNB N2 IP	10.1.108.156
<input type="checkbox"/> gNB N3 IP	10.1.108.156 <small>This value is equal to gNB N2 IP.</small>
Site(gNB) ID	8108
gNB ID Length	22
Cell ID	1
TAC	8108
MCC	001
MNC	01
AMF IP	10.1.106.51
Integrity Algo	NIA1

At the bottom right, there are three buttons: 'Reset', 'Cancel', and 'Save'.

After saving these configurations, the Admin Web will trigger to restart the device such that these configurations are effective. The gNB IP address is the same value for the N2 and N3 interfaces by default. You can click the check box to specify the gNB IP for N3 interface.

gNB N2 IP	10.1.108.156
<input checked="" type="checkbox"/> gNB N3 IP	10.1.108.157

According the following figure, you should check whether the gNB IP is correct based on the network setting and whether the cable connects to the WAN port, SFP+ port, or one of the VLAN IP addresses.

Figure 34. The Askey OAM Architecture

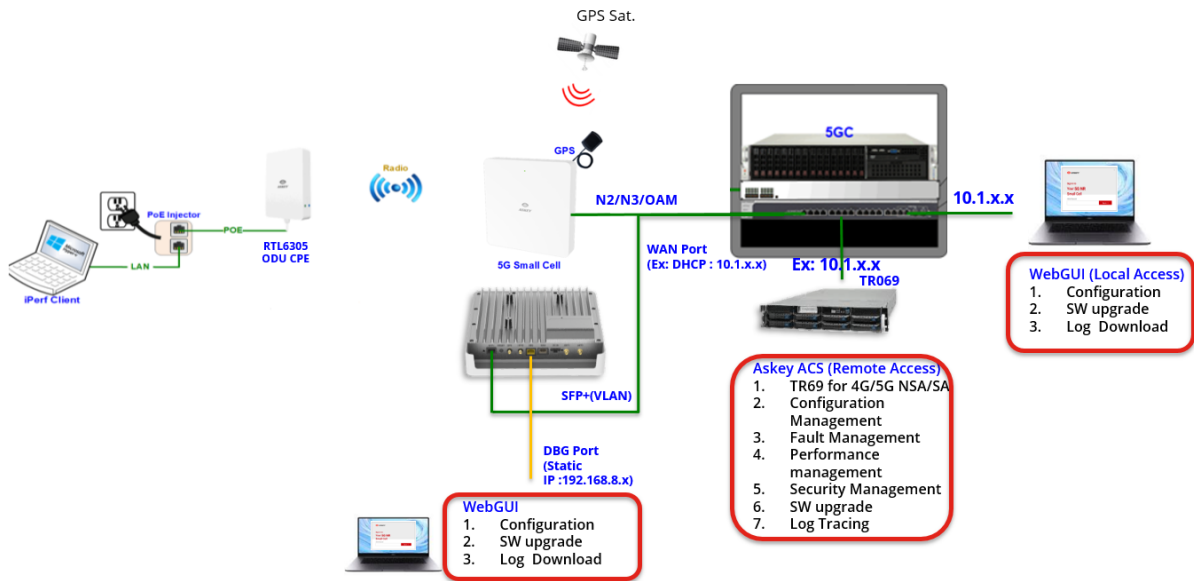

Figure 35. VLAN IP Address

Configuration: VLAN

Interface: fm1-mac9 - WAN

VLAN Interface	Tag ID	DHCP	IP Address	Action
fm1-mac9-vlan5	5	NO	192.148.2.12	Delete Edit
fm1-mac9-vlan22	22	YES	0.0.0.0	Delete Edit
fm1-mac9-vlan23	23	NO	192.158.1.22	Delete Edit

Table 14. The Askey 5G NR Small Cell CU Configuration

Items	Descriptions
Provision Method	The Provision Method should be Remote or Local . 1. The Remote provision method means that the remote server, e.g., ACS, will provision the primary gNB configurations to the 5G NR Small Cell. 2. The Local provision method means that the 5G NR Small Cell will apply all the configurations in the local files. Users can modify the primary gNB configurations on the Admin Web GUI.
gNB N2 IP/gNB N3 IP	The IP address of gNodeB. It should be the IP address of WAN port, SFP+ port, or one of the VLAN interfaces. Support separately specifying the gNB local interface with AMF (N2 interface) and the UPF (N3 interface) on the gNB configuration page. The IP address is the same value for the N2 and N3 interfaces by default.
Site(gNB) ID	It identifies a gNB within a PLMN.
gNB ID Length	The number of bits for encoding the gNB ID.
Cell ID	The physical-layer Cell ID of the signal. The number format
TAC	Tracking Area Code, an element of the tracking area identity (TAI) that serves to uniquely identify the Tracking Area.
MCC	Mobile Country Code
MNC	Mobile Network Code
AMF IP	The Access and Mobility Management Function IP address to carry the signaling traffic
UE Inact Timer	Duration while UE has not received or transmitted any user data
Encrypt Algo	NEA (Encryption Algorithm for 5G). It supports the NEA0 , NEA1 , NEA2 , and NEA3
Integrity Algo	EIA (EPS Integrity Algorithm). It supports the NIA1 , NIA2 , and NIA3

You can click the upper button to switch the configuration from gNB CU to gNB DU, and vice versa.

Figure 36. The Askey 5G NR Small Cell Switch CU or DU Configuration

Configuration: gNB CU

gNB CU

Provision Method Remote Local

gNB IP

Site(gNB) ID

Configuration: gNB DU

gNB DU

Provision Method Remote Local

SST

SD

There are many items in the DU configuration tab; they can be split by Common Items, Bandwidth Profile, NR ARFCN Profile, and Time Slot Profile.

Figure 37. The Askey 5G NR Small Cell DU Configuration – Common Items

Configuration: gNB DU

gNB DU

Provision Method Remote Local

SST

SD

NR Band

Physical Cell ID

Uplink Layer One Layer Two Layers

UL Dmrs-AdditionalPosition Position 1 Position 2

QRxLevMin

QQualMin

Table 15. The Askey 5G NR Small Cell DU Configuration – Common

Items	Descriptions
SST	Slice/Service Type, refers to the expected Network Slice behavior in terms of features and services
SD	Slice Differentiator, complements the SST to differentiate amongst multiple Network Slices of the same SST. The SD value can be disabled for the standardized S-NSSAI that has only SST.
NR Band	Frequency bands for 5G New Radio. It supports the N48, N77
Physical Cell ID	Physical Cell identifier, is used to distinguish cells on the radio side. The value must be small than 512.
Uplink Layer	The channel over which a symbol on the antenna port is conveyed can be inferred from the channel over which another symbol on the same antenna port is conveyed.
UL Dmrs-AdditionalPosition	Position for additional demodulation reference signal (DMRS) in uplink.
QRxLevMin	Minimum required RX level in the cell (dBm)
QQualMin	Minimum required quality level in the cell (dB)

If the device supports the NR Band 48, the SAS Provider item will display in the CU configuration as the NR band is modified to 48.

Figure 38. The Askey 5G NR Small Cell DU Configuration – Bandwidth Profile

Configuration: gNB DU

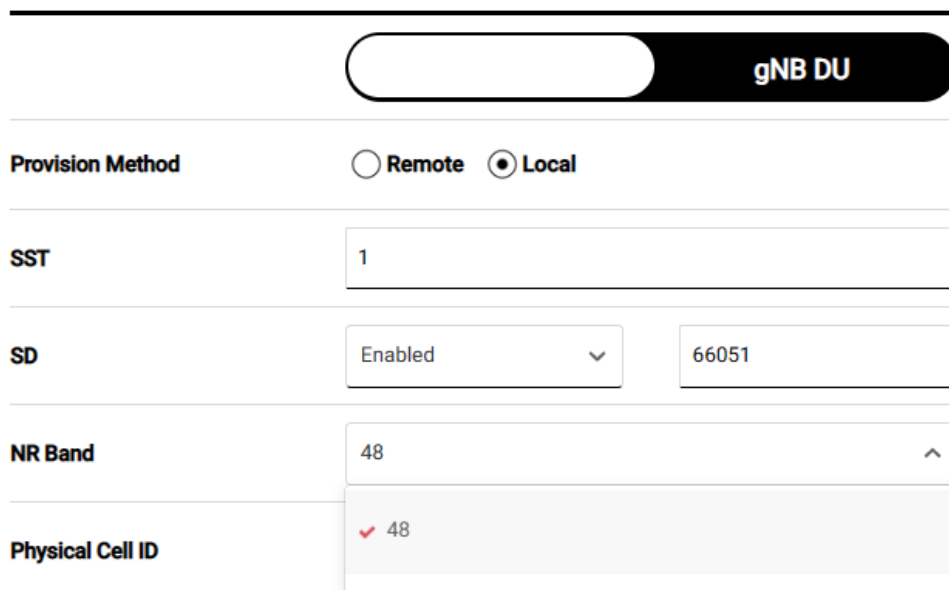

The screenshot displays the configuration page for a gNB DU. At the top, there is a tab labeled 'gNB DU'. Below the tab, the 'Provision Method' is set to 'Local' (indicated by a selected radio button). The configuration parameters are as follows:

- SST:** 1
- SD:** Enabled (dropdown menu), 66051
- NR Band:** 48
- Physical Cell ID:** 48 (with a red checkmark icon)

Figure 39. The Askey 5G NR Small Cell DU Configuration – SAS Provider

Configuration: gNB CU

gNB CU

Provision Method Remote Local

SAS Provider Federated Wireless ^

Site(gNB) ID Disable

gNB ID Length ✓ Federated Wireless

Cell ID Google

After rebooting the 5G NR Small Cell, the device will perform the normal SAS-CBSD procedures. The related messages can be captured by Wireshark with the following capture filter:

host 10.1.108.156 and udp port 17054

Capture

...using this filter: host 10.1.108.156 and udp port 17054

VirtualBox Host-Only Network
HostOnly
WAN
Adapter for loopback traffic capture
區域連線* 10

Capturing from WAN (host 10.1.108.156 and udp port 17054)

File Edit View Go Capture Analyze Statistics Telephony Wireless Tools Help

Apply a display filter: ... <Ctrl-/>

No.	Time	Source	Destination	Protocol	Length	Info
1	0.000000	10.1.108.156	255.255.255.255	UDP	814	40933 → 17054 Len=772
2	1.998030	10.1.108.156	255.255.255.255	UDP	139	46744 → 17054 Len=97
3	4.269195	10.1.108.156	255.255.255.255	UDP	269	55669 → 17054 Len=227
4	6.140853	10.1.108.156	255.255.255.255	UDP	807	42978 → 17054 Len=765
5	8.294572	10.1.108.156	255.255.255.255	UDP	307	44932 → 17054 Len=265
6	10.151894	10.1.108.156	255.255.255.255	UDP	259	32938 → 17054 Len=217
7	12.989377	10.1.108.156	255.255.255.255	UDP	274	53117 → 17054 Len=232
8	206.540265	10.1.108.156	255.255.255.255	UDP	277	55124 → 17054 Len=235
9	208.575108	10.1.108.156	255.255.255.255	UDP	246	53143 → 17054 Len=204

For check the content of the SAS-CBSD procedures, you can click the right mouse on the raw data and choose the item “**Show Packet Bytes**”.

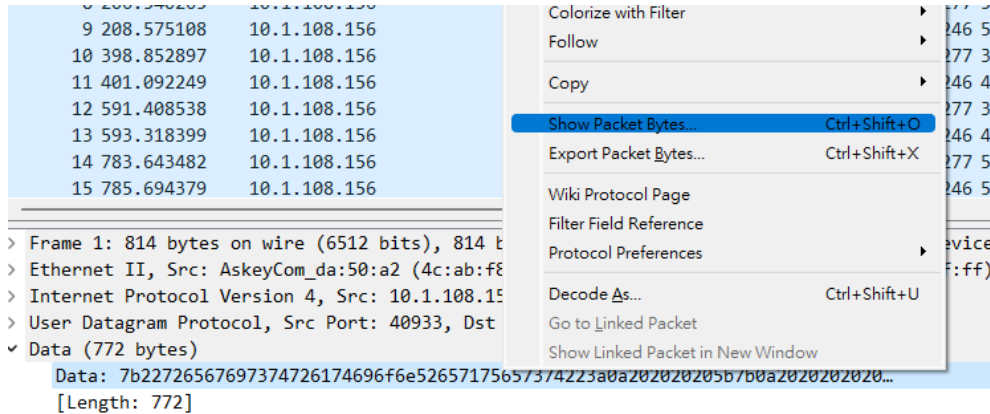

The message content will be displayed on the new window of the Wireshark as the following illustration:

Wireshark · Data (data.data) · WAN (host 10.1.108.156 and udp port 17054)

```

{"registrationRequest":
  [
    {
      "cbsdSerialNumber": "84301498175650",
      "fccId": "Askeyfccid22A",
      "userId": "MdwtmV",
      "cbsdCategory": "A",
      "airInterface": {
        "radioTechnology": "NR"
      },
      "measCapability": [""],
      "installationParam": {
        "latitude": 62.5,
        "longitude": -155.5,
        "heightType": "AGL",
        "height": 1.0,
        "antennaGain": 5,
        "eirpCapability": 29,
        "indoorDeployment": true
      },
      "cbsdInfo": {
        "vendor": "Askey Corporation",
        "model": "SCE2120",
        "softwareVersion": "v2.2.008.685",
        "hardwareVersion": "SCE2120_ES0",
        "firmwareVersion": "0.4.6.48.ev0"
      }
    }
  ]
}
    
```

In the bandwidth and NR ARFCN configurations, the Admin Website provides the supported item for each NR band. After choosing the profile option, the recommended values will be filled in the related items. For the more configurations, you can read the Chapter “**The Recommend NR ARFCN Configuration**” in the bottom of this document.

For the NR ARFCN, the Admin Website provide some profile options, and the recommended values will be filled in the related items. For the more configurations, you can read the Chapter “**The Recommend NR ARFCN Configuration**” in the bottom of this document.

Figure 40. The Askey 5G NR Small Cell DU Configuration – NR ARFCN

NR ARFCN

Profile	3.52G
DL NR ARFCN	635208
UL NR ARFCN	635208
DL CenterFreq	3528120
UL CenterFreq	3528120
DL AbsArfcnPointA	633936
UL AbsArfcnPointA	633936
DL AbsFreqPointA	3509040
UL AbsFreqPointA	3509040
AbsArfcnSsb	634464
AbsFreqSsb	3516960

Table 16. The Askey 5G NR Small Cell DU Configuration – Bandwidth and NR ARFCN

Items	Descriptions
Bandwidth Profile	N48 : 20/30/40 MHz N77 : 40/50/60/70/80/90/100MHz
ARFCN Profile	It provides the recommended ARFCN configuration
DL NR ARFCN	The downlink NR ARFCN of the whole bandwidth
UL NR ARFCN	The uplink NR ARFCN of the whole bandwidth
DL CenterFreq	The downlink center frequency value in KHz
UL CenterFreq	The uplink center frequency value in KHz
DL AbsFreqPointA	The downlink absolute frequency point A configuration in KHz
UL AbsFreqPointA	The uplink absolute frequency point A configuration in KHz
DL AbsArfcnPointA	The downlink absolute ARFCN point A configuration
UL AbsArfcnPointA	The uplink absolute ARFCN point A configuration
AbsFreqSsb	The absolute frequency SSB configuration in KHz
AbsArfcnSsb	The absolute ARFCN SSB configuration

For the Time Slot Format, the Admin Website provides some typical profiles and the recommended value of the related items. You can click the profile option, and the related values will be filled in these detailed items.

Figure 41. The Askey 5G NR Small Cell DU Configuration – Time Slot Profile

Time Slot Format

Profile	DDDSU(4:1) ^
NumDISlot	User Specific
NumDISlotP2	✓ DDDSU(4:1)
NumDISymbol	DDSUU(3:2)
NumDISymbolP2	DSUUU(2:3)
	DDDSUDDSUU(7:3) v

Figure 42. The Askey 5G NR Small Cell DU Configuration – Time Slot Parameters

Time Slot Format



Profile	DDDSU(4:1) 
NumDISlot	3
NumDISlotP2	0
NumDISymbol	10
NumDISymbolP2	0
NumUISlot	1
NumUISlotP2	0
NumUISymbol	2
NumUISymbolP2	0
P2 Pres	0
PrachCfIdx	159
PreambleFormat	RACH_FORMAT_B4 

Table 17. The Askey 5G NR Small Cell DU Configuration – Time Slot Format

Items	Descriptions
Profile	List the common time slot patterns and provide the default value for detailed setting
numDISlot	The number of downlink slots
numDISlot2	The number of P2 downlink slots
numDISymbol	The number of downlink symbols for slot format
numDISymbolP2	The number of P2 downlink symbols for slot format
numUISlot	The number of uplink slots
numUISlotP2	The number of P2 uplink slots
numUISymbol	The number of uplink symbols for slot format
numUISymbolP2	The number of P2 uplink symbols for slot format
p2Pres	The Pattern 2 (P2) presence value
PrachCfIdx	The PRACH configuration index value
PreambleFormat	Long preamble: Format 0, 1, 2, and 3 Short preamble: Format A1, A2, A3, B1, B2, B3, B4, C0, and C2

In the NR ARFCN and Time Slot Format configurations, the detailed items will be read-only for the pre-defined profile. If the user wants to modify the detailed items, the profile should be selected to “**User Specific**”.

NR ARFCN

Profile	<input type="text" value="User Specific"/>
DL NR ARFCN	<input type="text" value="635208"/>
UL NR ARFCN	<input type="text" value="635208"/>

Time Slot Format

Profile	<input type="text" value="User Specific"/>
NumDISlot	<input type="text" value="3"/>
NumDISlotP2	<input type="text" value="0"/>

3.5.3 Neighbor Cell

This Askey 5G NR Small Cell Neighbor Cell displays the related gNB information, and you can modify some items in the local provision. You can also manually add the neighbor cell on the page's bottom. These items will be read-only if the device is under remote provisioning.

Figure 43. The Askey 5G NR Small Cell Neighbor Cell Page

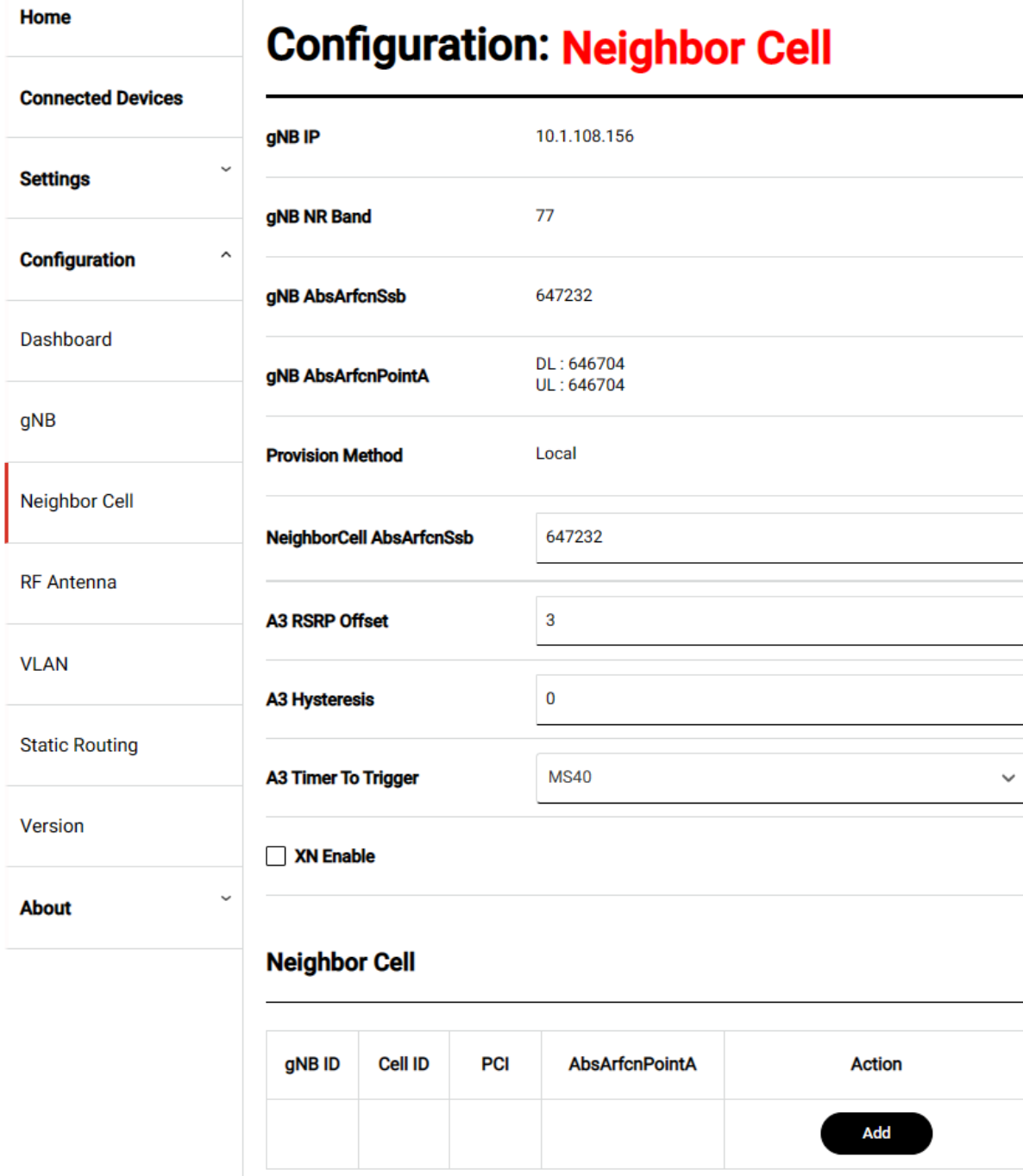

Home

Connected Devices

Settings ▼

Configuration ▲

Dashboard

gNB

Neighbor Cell

RF Antenna

VLAN

Static Routing

Version

About ▼

Configuration: Neighbor Cell

gNB IP 10.1.108.156

gNB NR Band 77

gNB AbsArfcnSsb 647232

gNB AbsArfcnPointA DL : 646704
UL : 646704

Provision Method Local

NeighborCell AbsArfcnSsb

A3 RSRP Offset

A3 Hysteresis

A3 Timer To Trigger

XN Enable

Neighbor Cell

gNB ID	Cell ID	PCI	AbsArfcnPointA	Action
				Add

If the XN Enable is checked, you can choose the server or client side for Xn handover. You should also provide the XN neighbor IP address as the following illustration:

<input checked="" type="checkbox"/> XN Enable	Server Side
XN Neighbor IP	10.1.108.111

You can add the neighbor cell by clicking the **Add** button in the Action column and fill the neighbor data on the popup window.

Add Neighbor Cell

Handover Type	Intra Handover
Neighbor gNB ID	0
Neighbor gNB ID Length	22
Neighbor Cell ID	0
Neighbor PCI	0
Neighbor TAC	0
Neighbor NR Band	77
DL AbsArfcnPointA	646704
UL AbsArfcnPointA	646704

The gNB ID, gNB ID Length, and Cell ID cannot all be the same value as another neighbor cell. It should be noted that the Askey 5G NR Small Cell currently doesn't support the inter handover if the **Neighbor NR Band** or the **AbsArfcnPointA** is not the same as the gNB.

Handover Type	Inter Handover
---------------	----------------

The max number of neighbor cells is 4, and you can perform the delete or edit action to adjust the neighbor cells.

Neighbor Cell

gNB ID	Cell ID	PCI	AbsArfcnPointA	Action
704	12	112	DL : 646704 UL : 646704	<input type="button" value="Delete"/> <input type="button" value="Edit"/>
480	4	74	DL : 630480 UL : 630480	<input type="button" value="Delete"/> <input type="button" value="Edit"/>
112	1	1	DL : 646704 UL : 646704	<input type="button" value="Delete"/> <input type="button" value="Edit"/>
210	10	1	DL : 646704 UL : 646704	<input type="button" value="Delete"/> <input type="button" value="Edit"/>
				<input type="button" value="Add"/>

Table 18. The Askey 5G NR Small Cell Neighbor Cell Configuration

Items	Descriptions
NeighborCell AbsArfcnSsb	The absolute ARFCN point A configuration of the neighbor cell
A3 RSRP Offset	The Reference Signal Received Power (RSRP) offset of event A3. The number range is -30 to 30 (dB).
A3 Hysteresis	The hysteresis value of event A3. The number range is 0 to 30 (dB).
A3 Timer To Trigger	The timer helps to avoid irregular measurement and handover. Support the following items: MS0, MS40, MS64, MS80, MS100, MS128, MS160, MS256, MS320, MS480, MS512, MS640, MS1024, MS1280, MS2560, MS5120
XN Enable	If checked, the device will enable the Xn handover. It needs to choose the server or client side for Xn handover
XN Neighbor IP	The IP address of the peer gNB on the Xn interface

3.5.4 RF Antenna

This Askey 5G NR Small Cell RF Antenna page allows users to modify the max TX power and the RF antenna path.

Figure 44. The Askey 5G NR Small Cell RF Antenna Page

- Home
- Connected Devices
- Settings v
- Configuration ^
- Dashboard
- gNB
- Neighbor Cell
- RF Antenna

Configuration: RF Antenna

RF Power

Max TX Power (dBm)

Antenna Path

The RF Power will be N/A if the Askey 5G NR Small Cell isn't in service.

Configuration: RF Antenna

RF Power

After the cell state is in service, you can turn off the RF power. In the meantime, the MAX TX power will be read-only.

Configuration: RF Antenna

RF Power

Max TX Power (dBm)

This max TX power is the number in one decimal place, and the range is from 0.0 to 24.0

Max TX Power (dBm)

The number range is 0 to 24

This antenna path can be **Internal** or **External**. If the antenna path is switched to External, the RF signal will be transmitted through the **external** antenna connector as the illustration:

External antenna ports ANT1/ANT2 are disabled via software for this model and is not modifiable by any third-party / end-user.



3.5.5 VLAN

This Askey 5G NR Small Cell VLAN page allows users to create, read, update and delete the VLAN (Virtual Local Area Network) configurations.

Figure 45. The Askey 5G NR Small Cell VLAN Page

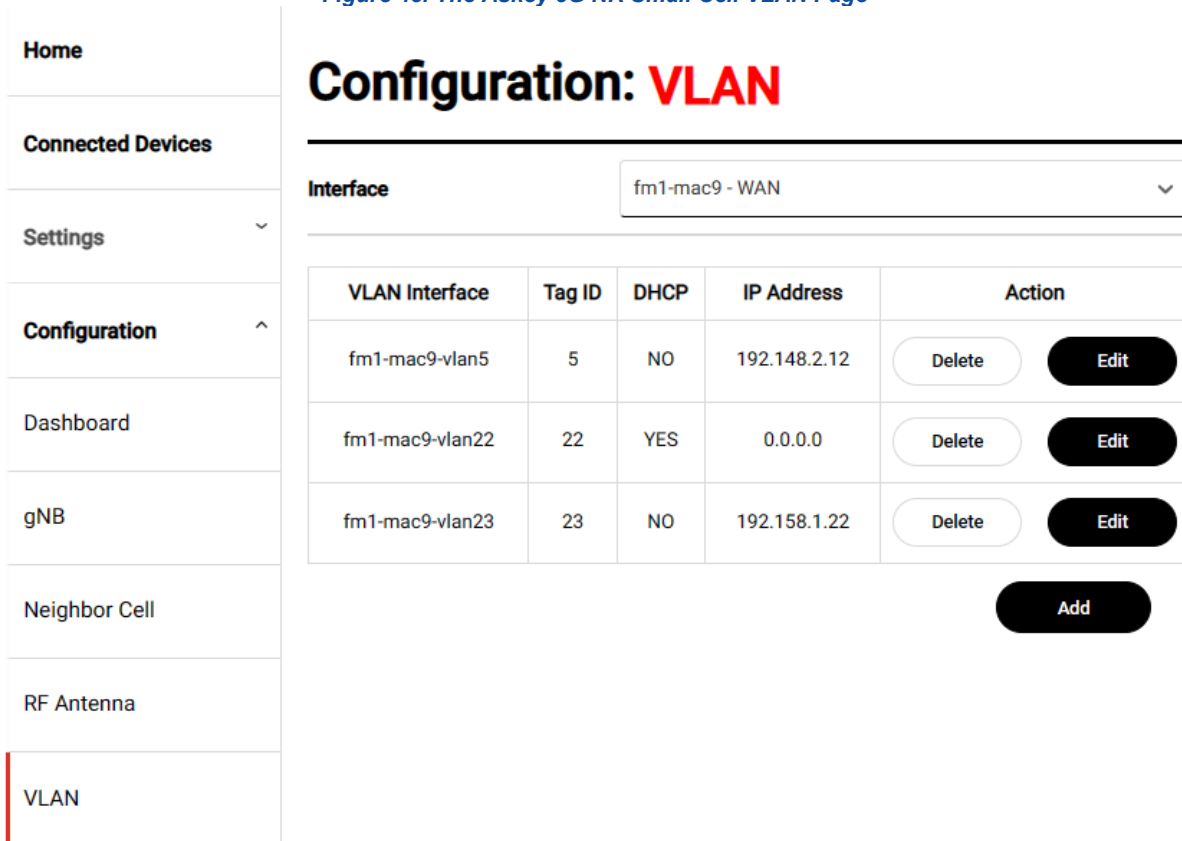

VLAN Interface	Tag ID	DHCP	IP Address	Action
fm1-mac9-vlan5	5	NO	192.148.2.12	Delete Edit
fm1-mac9-vlan22	22	YES	0.0.0.0	Delete Edit
fm1-mac9-vlan23	23	NO	192.158.1.22	Delete Edit

Add

At first, you should choose which physical network interface the VLAN attaches. When the interface is changed, the related VLAN configurations attached on the physical network interface will be displayed on the page.

Interface		fm1-mac9 - WAN
VLAN Interface	Tag ID	<input checked="" type="checkbox"/> fm1-mac9 - WAN fm1-mac10 - SFP+
fm1-mac9-vlan5	5	

Figure 46. The Askey 5G NR Small Cell VLAN Page – Read Operation

Configuration: VLAN

Interface		fm1-mac10 - SFP+		
VLAN Interface	Tag ID	DHCP	IP Address	Action
fm1-mac10-vlan12	12	YES	0.0.0.0	<input type="button" value="Delete"/> <input type="button" value="Edit"/>

Click the **Add** button will prompt a window to create a new VLAN attached to the physical network interface. The DNS configurations are optional for the VLAN with static IP. If the DHCP is enabled, add the ignore default route option Ignore **Routes**.

Figure 47. The Askey 5G NR Small Cell VLAN Page – Create Operation

Add VLAN

Interface fm1-mac10 - SFP+

Tag ID

DHCP

IP Address

Subnet Mask

Default Gateway

Primary DNS

Secondary DNS

Click the **Edit** button in the VLAN list will prompt a window to update the specified VLAN configuration.

Figure 48. The Askey 5G NR Small Cell VLAN Page – Update Operation

Configuration: VLAN

Interface fm1-mac10 - SFP+

VLAN Interface	Tag ID	DHCP	IP Address	Action
fm1-mac10-vlan5	5	NO	192.168.100.80	<input type="button" value="Delete"/> <input type="button" value="Edit"/>
fm1-mac10-vlan12	12	YES	0.0.0.0	<input type="button" value="Delete"/> <input type="button" value="Edit"/>

Edit VLAN

Interface	fm1-mac10 - SFP+
VLAN Interface	fm1-mac10-vlan5
Tag ID	5
<input type="checkbox"/> DHCP	
IP Address	<input type="text" value="192.168.100.60"/>
Subnet Mask	<input type="text" value="255.255.255.0"/>
Default Gateway	<input type="text"/>
Primary DNS	<input type="text"/>
Secondary DNS	<input type="text"/>
<input type="button" value="Cancel"/> <input type="button" value="Save"/>	

In addition, if the VLAN tag ID has existed in the create operation, it will become an update operation that will update the previous VLAN configuration with the tag ID.

Click the **Delete** button in the VLAN list will delete the specified VLAN configuration. It doesn't need to restart the device for the delete operation.

Figure 49. The Askey 5G NR Small Cell VLAN Page – Delete Operation

Configuration: VLAN

Interface: fm1-mac10 - SFP+ ▼

VLAN Interface	Tag ID	DHCP	IP Address	Action
fm1-mac10-vlan5	5	NO	192.168.100.60	<input type="button" value="Delete"/> <input type="button" value="Edit"/>
fm1-mac10-vlan12	12	YES	0.0.0.0	<input type="button" value="Delete"/> <input type="button" value="Edit"/>

3.5.6 Static Routing

This Askey 5G NR Small Cell Static Routing page shows the current routing table and allows users to define the static routing rules. The commands in the static routing rules need to be started with “ip route”; otherwise, the command will be ignored.

Figure 50. The Askey 5G NR Small Cell Static Routing Page

- Home
- Connected Devices
- Settings ▼
- Configuration ^
- Dashboard
- gNB
- Neighbor Cell
- RF Antenna
- VLAN
- Static Routing

Configuration: Static Routing

Routing Table :

```
default via 10.1.106.1 dev fm1-mac9 proto dhcp src 10.1.108.156 metric 100
10.1.104.0/21 dev fm1-mac9 proto kernel scope link src 10.1.108.156
10.1.106.1 dev fm1-mac9 proto dhcp scope link src 10.1.108.156 metric 100
192.148.0.0/24 via 192.158.0.0 dev fm1-mac9-vlan23
192.158.0.0/24 dev fm1-mac9-vlan23 scope link
192.168.66.9 dev fm1-mac9-vlan5 scope link
```

Static Routing :

```
ip route add 192.168.66.9 dev fm1-mac9-vlan5
ip route add 192.158.0.0/24 dev fm1-mac9-vlan23
ip route add 192.148.0.0/24 via 192.158.0.0 dev fm1-mac9-vlan23
```

3.5.7 Version

This Askey 5G NR Small Cell Version page shows the current software, hardware, and web version. In Addition, you can upload an encoded installer with matched access code to perform a local upgrade of the Askey 5G NR Small Cell.

Figure 51. The Askey 5G NR Small Cell Version Page

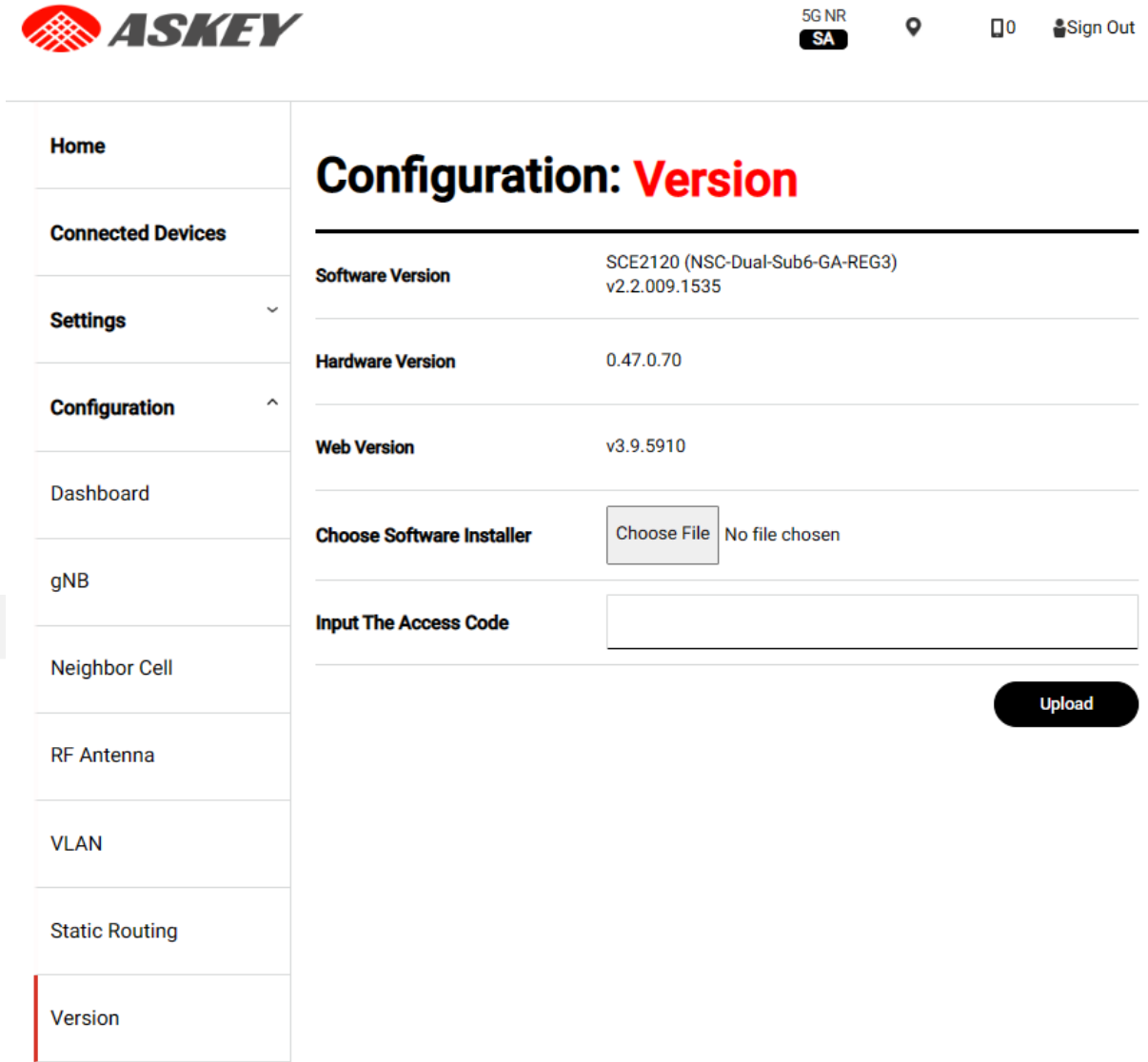

The screenshot shows the 'Configuration: Version' page in the Askey 5G NR Small Cell Admin Website. The page features a sidebar menu on the left with options: Home, Connected Devices, Settings, Configuration (selected), Dashboard, gNB, Neighbor Cell, RF Antenna, VLAN, Static Routing, and Version. The main content area displays the following information:

Software Version	SCE2120 (NSC-Dual-Sub6-GA-REG3) v2.2.009.1535
Hardware Version	0.47.0.70
Web Version	v3.9.5910
Choose Software Installer	Choose File No file chosen
Input The Access Code	<input type="text"/>

An **Upload** button is located at the bottom right of the main content area.

Firstly, you need to choose the encrypted software installer and input the access code provided by Askey. The installer will be uploaded to the DUT after clicking the Upload button..

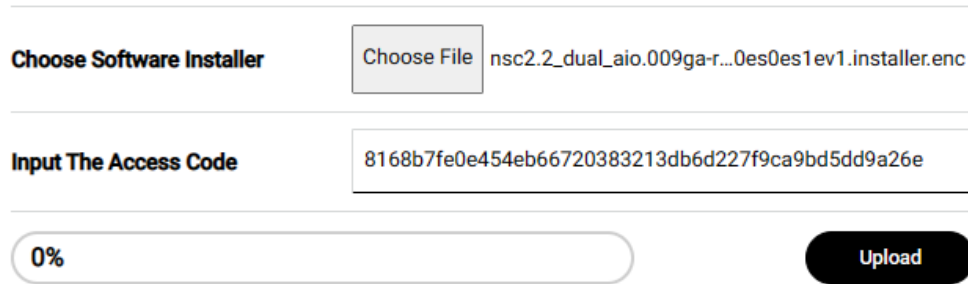

The screenshot shows the software upload interface. At the top, there is a section labeled "Choose Software Installer" with a "Choose File" button and the filename "nsc2.2_dual_aio.009ga-r...0es0es1ev1.installer.enc". Below this is a section labeled "Input The Access Code" with a text input field containing the code "8168b7fe0e454eb66720383213db6d227f9ca9bd5dd9a26e". At the bottom, there is a progress bar showing "0%" and an "Upload" button.

There is a progress bar to indicate the upload processing progress. When the progress is 100%, the API server will concatenate the chunked upload files and check the access code.

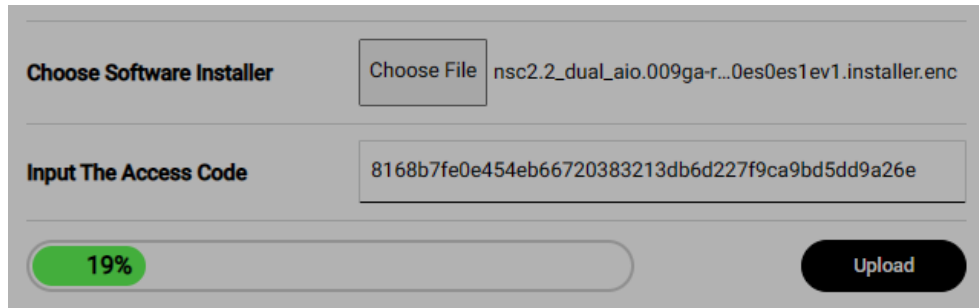

The screenshot shows the software upload interface with a progress bar indicating 19% completion. The "Choose Software Installer" section and "Input The Access Code" section are identical to the previous screenshot. The "Upload" button is still visible.

If the access code is wrong, the Admin Website will provide a warning message as the following illustration. Please check the access code and upload it again with the correct code.

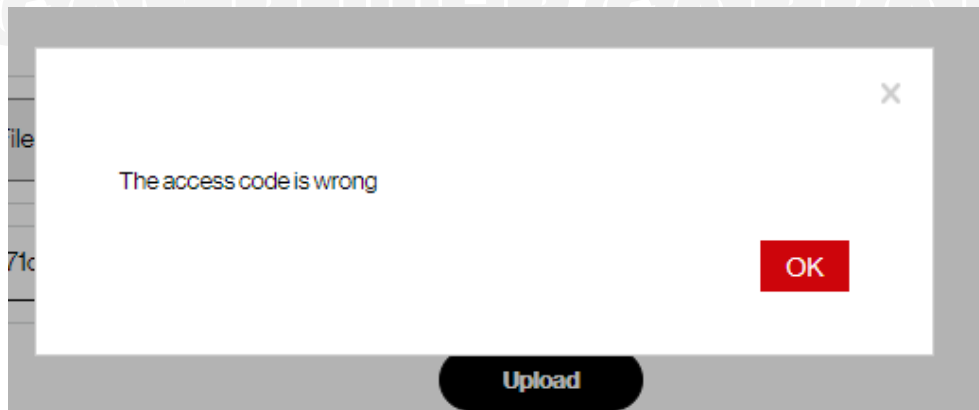

The screenshot shows a modal dialog box with a white background and a grey border. The text inside the dialog reads "The access code is wrong". There is a red "OK" button in the bottom right corner of the dialog. Below the dialog, the "Upload" button from the previous screenshot is visible.

If the access code is correct, the Admin Website will pop-up a message as the following illustration to indicate the upload is successful and the Askey 5G NR Small Cell will start to upgrade the software.

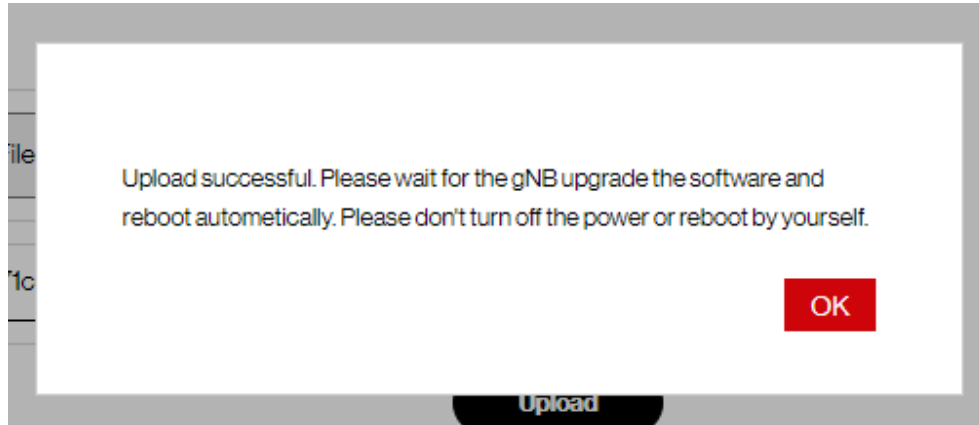

In the meantime, the API server is decoding the installer and perform the local upgrade. Therefore, if you click the “OK” button, the Web GUI cannot do other operations as in the following illustration. After finishing the upgrade, the Admin Website will provide another message as the following illustration.

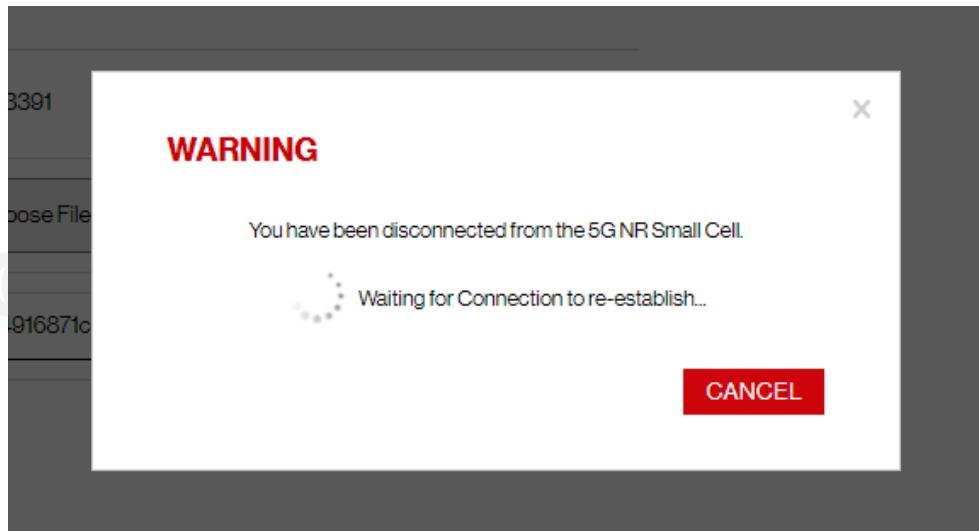

Finally, when the Admin Website provides the following message, the Askey 5G NR Small Cell startup procedure is finished. Click the “OK” button will redirect to the login form to access the Admin Website.

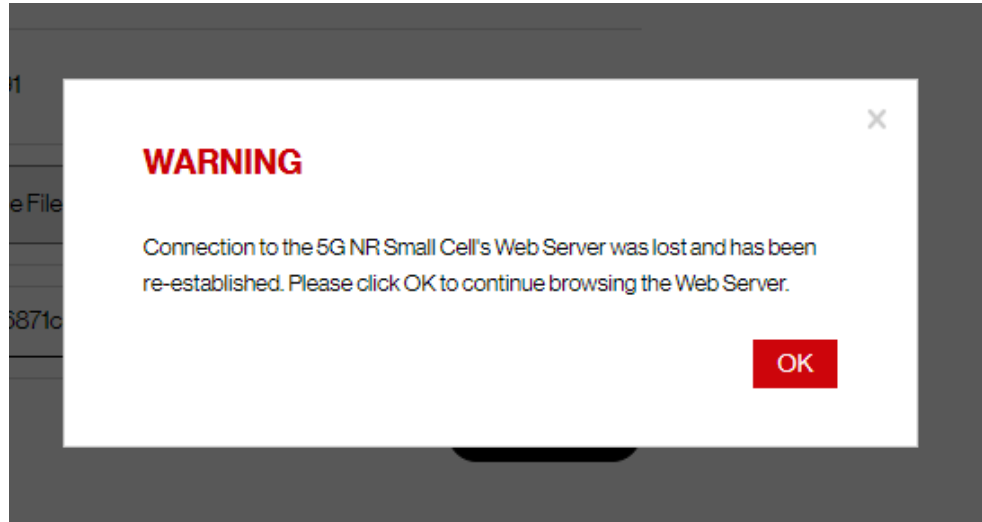

3.6 About

3.6.1 GPS

This Askey 5G NR Small Cell GPS Page shows the GPS status, including GPS Satellite ID, signal quantities, description, etc.

Figure 52. The Askey 5G NR Small Cell GPS Page

Home
Connected Devices
Settings ∨
Configuration ∨
About ∧
GPS

About: GPS

Last Data Refresh 02-27-2023 12:33:00 (UTC+8)
This page will refresh every 15 seconds.

GPS

A minimum of four satellites are required to provide a GPS location fix. Please place the 5G NR Small Cell's GPS antenna in a location where there are at least four strong satellite signals in the table below.

GPS Status : Location Acquired [Map](#)

MSL Altitude : 65.2 m

GPS Satellite ID	GPS Signal Quality (dB)	Description
27	40	■ Strong
8	38	■ Strong
195	38	■ Strong
194	36	■ Strong
4	36	■ Strong
16	35	■ Strong
301	34	■ Strong
199	33	■ Strong
326	33	■ Strong
9	33	■ Strong
31	33	■ Strong
321	31	■ Strong
26	31	■ Strong
21	30	■ Fair
7	30	■ Fair

■ Strong / 31-99

■ Fair / 20-30

■ Weak / 0-19

Table 19. The Askey 5G NR Small Cell GPS

Items	Descriptions
Last Data Refresh	The local time when this page was last refreshed.
Last Data Refresh	The local time when this page was last refreshed.
GPS Status	This indicates if The Askey 5G NR Small Cell has acquired GPS signals or not. The Askey 5G NR Small Cell will not come into service if the status does not say "Location Acquired".
GPS Satellite ID	The list of GPS satellites identifies how many satellites are currently being detected along with each satellite's unique identifier.
GPS Satellite Quality (dB)	This value describes the signal-to-noise ratio for the GPS signal. A higher value means better quality. If the description is either Fair or Weak, you should consider repositioning the unit or GPS antenna. If the signal quality does not improve, an external GPS antenna may be required.
Description	Describes the quality level of the satellite signal as either: Strong, Fair or, Weak. Refer to the legend for the mapping.

ASKEY COMPUTER CORPORATION

Chapter 4 The Askey 5G NR Small Cell Support Utilities

4.1 Small Cell Log Download Mechanism

You can download the runtime or backup log files by the following HTTPS linking URL and send them back to the Askey Small Cell team to analyze.

PS:

1. Please don't modify the downloaded file name
2. Please don't download two log files at the same time

Backup Log Illustration: (The max page size is 3)



The Askey 5G NR Small Cell

Runtime Log:

<https://<ip address>/api/logs/TwpEceURn15qxDYSW88IjddB7LAsiOr64HNg>

Backup Log:

<https://<ip address>/api/logs/TwpEceURn15qxDYSW88IjddB7LAsiOr64HNg/<page size>>

<https://<ip address>/api/logs/TwpEceURn15qxDYSW88IjddB7LAsiOr64HNg/<page size>/<page no>>

Examples:

<https://10.1.108.15/api/logs/TwpEceURn15qxDYSW88IjddB7LAsiOr64HNg>

→ **Runtime log:**

[askeylog_280375459184643_20221025-092816_nsc.tgz.enc](#)

<https://10.1.108.15/api/logs/TwpEceURn15qxDYSW88IjddB7LAsiOr64HNg/3>

→ **Backup log (page size 3, page no 1):**

[askeylog_280375459184643_20221025-092825_nsc_last_01-03.tgz.enc](#)

<https://10.1.108.15/api/logs/TwpEceURn15qxDYSW88IjddB7LAsiOr64HNg/3/3>

→ **Backup log (page size 3, page no 3):**

[askeylog_280375459184643_20221025-092902_nsc_last_07-09.tgz.enc](#)

4.2 Access the Admin Website by IPv6 Link-Local Address

If the network setting of the Askey 5G NR Small Cell is wrong or you cannot get the current IP address, you cannot access the Admin Website by IPv4. You can use the MAC to IPv6 Converter (<https://nettools.club/mac2ipv6>) to get the link-local address of the Askey 5G NR Small Cell. After that, you can access the Admin Website by the URL `http://[IPv6 Link-Local Address]/` in the same LAN.

For example, if the MAC address is “FE:FF:FF:A6:00:03”, you can get the following result by converter.

Just fill in one of the fields and the second will update automatically.

MAC Address:	<input type="text" value="FE:FF:FF:A6:00:03"/>
IPv6 Link-local:	<input type="text" value="fe80::fcff:ffff:fea6:3"/>

Then, you can access the Admin Website by the URL `http://[fe80::fcff:ffff:fea6:3]/` in the same LAN. If you access the Admin Website by the method for the first time, it may need more than one time refresh to finish the IPv6 Neighbor Discovery.

4.3 The Recommend NR ARFCN Configuration

5G Sub6G Band N48

NR ARFCN Profile	40 MHz 3.57G	30 MHz 3.56G	20 MHz 3.62G		
DL Earfcn	637992	637656	641652		
UL Earfcn	637992	637656	641652		
DL CenterFreq	3569880	3564840	3624780		
UL CenterFreq	3569880	3564840	3624780		
DL AbsArfcnPointA	636720	636720	641040		
UL AbsArfcnPointA	636720	636720	641040		
DL AbsFreqPointA	3550800	3550800	3615600		
UL AbsFreqPointA	3550800	3550800	3615600		
AbsArfcnSsb	637248	636960	641280		
AbsFreqSsb	3558720	3554400	3619200		

5G Sub6G Band N77, 100MHz Bandwidth

NR ARFCN Profile	3.75G	3.675G			
DL Earfcn	649980	647772			
UL Earfcn	649980	647772			
DL CenterFreq	3749700	3716580			
UL CenterFreq	3749700	3716580			
DL AbsArfcnPointA	646704	644496			
UL AbsArfcnPointA	646704	644496			
DL AbsFreqPointA	3700560	3667440			
UL AbsFreqPointA	3700560	3667440			
AbsArfcnSsb	647232	645024			
AbsFreqSsb	3708480	3675360			

5G Sub6G Band N77, 90MHz Bandwidth

NR ARFCN Profile	3.75G	3.75G	3.6G	4.05G	
DL Earfcn	649644	649836	640044	669996	
UL Earfcn	649644	649836	640044	669996	
DL CenterFreq	3744660	3747540	3600660	4049940	
UL CenterFreq	3744660	3747540	3600660	4049940	
DL AbsArfcnPointA	646704	646896	637104	667056	
UL AbsArfcnPointA	646704	646896	637104	667056	
DL AbsFreqPointA	3700560	3703440	3556560	4005840	
UL AbsFreqPointA	3700560	3703440	3556560	4005840	
AbsArfcnSsb	647232	647424	637632	667584	
AbsFreqSsb	3708480	3711360	3564480	4013760	

5G Sub6G Band N77, 80MHz Bandwidth

NR ARFCN Profile	4.05G				
DL Earfcn	669996				
UL Earfcn	669996				
DL CenterFreq	4049940				
UL CenterFreq	4049940				
DL AbsArfcnPointA	667392				
UL AbsArfcnPointA	667392				
DL AbsFreqPointA	4010880				
UL AbsFreqPointA	4010880				
AbsArfcnSsb	667968				
AbsFreqSsb	4019520				

5G Sub6G Band N77, 70MHz Bandwidth

NR ARFCN Profile	3.587G				
DL Earfcn	639180				
UL Earfcn	639180				
DL CenterFreq	3587700				
UL CenterFreq	3587700				
DL AbsArfcnPointA	636912				
UL AbsArfcnPointA	636912				
DL AbsFreqPointA	3553680				
UL AbsFreqPointA	3553680				
AbsArfcnSsb	637440				
AbsFreqSsb	3561600				

5G Sub6G Band N77, 60MHz Bandwidth

NR ARFCN Profile	3.675G	3.6966G	4.05G		
DL Earfcn	645000	646440	670008		
UL Earfcn	645000	646440	670008		
DL CenterFreq	3675000	3696600	4050120		
UL CenterFreq	3675000	3696600	4050120		
DL AbsArfcnPointA	643056	644496	668064		
UL AbsArfcnPointA	643056	644496	668064		
DL AbsFreqPointA	3645840	3667440	4020960		
UL AbsFreqPointA	3645840	3667440	4020960		
AbsArfcnSsb	643584	645024	669312		
AbsFreqSsb	3653760	3675360	4039680		

5G Sub6G Band N77, 50MHz Bandwidth

NR ARFCN Profile	3.587G				
DL Earfcn	639180				
UL Earfcn	639180				
DL CenterFreq	3587700				
UL CenterFreq	3587700				
DL AbsArfcnPointA	637584				
UL AbsArfcnPointA	637584				
DL AbsFreqPointA	3563760				
UL AbsFreqPointA	3563760				
AbsArfcnSsb	638112				
AbsFreqSsb	3571680				

5G Sub6G Band N77, 40MHz Bandwidth

NR ARFCN Profile	3.75G	4.05G			
DL Earfcn	649896	670008			
UL Earfcn	649896	670008			
DL CenterFreq	3748440	4050120			
UL CenterFreq	3748440	4050120			
DL AbsArfcnPointA	648624	668736			
UL AbsArfcnPointA	648624	668736			
DL AbsFreqPointA	3729360	4031040			
UL AbsFreqPointA	3729360	4031040			
AbsArfcnSsb	649152	669312			
AbsFreqSsb	3737280	4039680			

ASKEY COMPUTER CORPORATION