

TEST REPORT

CERTIFICATE OF CONFORMITY

Standard: 47 CFR FCC Part 96
47 CFR FCC Part 2

Report No.: RFBCUN-WTW-P23030714-1

FCC ID: H8N46116A

Product: 5G small cell

Brand: ASKEY

Model No.: NR xCell 46116A

Received Date: 2023/3/31

Test Date: 2023/3/31 ~ 2023/5/12

Issued Date: 2023/6/26

Applicant: ASKEY COMPUTER CORP.

Address: 10F, NO. 119, JIANKANG RD., ZHONGHE DIST., NEW TAIPEI CITY
23585, TAIWAN, R.O.C.

Issued By: Bureau Veritas Consumer Products Services (H.K.) Ltd., Taoyuan Branch
Lin Kou Laboratories

Lab Address: No. 47-2, 14th Ling, Chia Pau Vil., Lin Kou Dist., New Taipei City, Taiwan

Test Location: No. 19, Hwa Ya 2nd Rd., Wen Hwa Vil., Kwei Shan Dist., Taoyuan City 33383, TAIWAN

FCC Registration / 788550 / TW0003

Designation Number:

Approved by: _____

Jeremy Lin

Date: _____

2023/6/26

Jeremy Lin / Project Engineer

This test report consists of 101 pages in total. It may be duplicated completely for legal use with the approval of the applicant. It should not be reproduced except in full, without the written approval of our laboratory. The test results in the report only apply to the tested sample. The test results in this report are traceable to the national or international standards.



Prepared by : Pettie Chen / Senior Specialist

This report is governed by, and incorporates by reference, the Conditions of Testing as posted at the date of issuance of this report at <http://www.bureauveritas.com/home/about-us/our-business/cps/about-us/terms-conditions/> and is intended for your exclusive use. Any copying or replication of this report to or for any other person or entity, or use of our name or trademark, is permitted only with our prior written permission. This report sets forth our findings solely with respect to the test samples identified herein. The results set forth in this report are not indicative or representative of the quality or characteristics of the lot from which a test sample was taken or any similar or identical product unless specifically and expressly noted. Our report includes all of the tests requested by you and the results thereof based upon the information that you provided to us. Measurement uncertainty is only provided upon request for accredited tests. Statements of conformity are based on simple acceptance criteria without taking measurement uncertainty into account, unless otherwise requested in writing. You have 60 days from date of issuance of this report to notify us of any material error or omission caused by our negligence or if you require measurement uncertainty; provided, however, that such notice shall be in writing and shall specifically address the issue you wish to raise. A failure to raise such issue within the prescribed time shall constitute your unqualified acceptance of the completeness of this report, the tests conducted and the correctness of the report contents.

Table of Contents

| | |
|---|-----------|
| Release Control Record | 4 |
| 1 Certificate | 5 |
| 2 Summary of Test Results | 6 |
| 2.1 Measurement Uncertainty | 6 |
| 2.2 Supplementary Information | 6 |
| 3 General Information | 7 |
| 3.1 General Description of EUT | 7 |
| 3.2 Antenna Description of EUT | 8 |
| 3.3 Test Mode Applicability and Tested Channel Detail | 9 |
| 3.4 Test Program Used and Operation Descriptions | 11 |
| 3.5 Connection Diagram of EUT and Peripheral Devices | 11 |
| 3.6 Configuration of Peripheral Devices and Cable Connections | 12 |
| 4 Test Instruments | 13 |
| 4.1 Maximum EIRP | 13 |
| 4.2 Modulation Characteristics | 13 |
| 4.3 Maximum Power Spectral Density | 13 |
| 4.4 Peak to Average Ratio | 14 |
| 4.5 Bandwidth | 14 |
| 4.6 Conducted Spurious Emissions | 14 |
| 4.7 Radiated Spurious Emissions below 1GHz | 15 |
| 4.8 Radiated Spurious Emissions above 1GHz | 16 |
| 4.9 Frequency Stability | 17 |
| 5 Limits of Test Items | 18 |
| 5.1 Maximum EIRP | 18 |
| 5.2 Modulation Characteristics | 18 |
| 5.3 Maximum Power Spectral Density | 18 |
| 5.4 Peak to Average Ratio | 18 |
| 5.5 Bandwidth | 18 |
| 5.6 Conducted Spurious Emissions | 18 |
| 5.7 Radiated Spurious Emissions below 1GHz | 19 |
| 5.8 Radiated Spurious Emissions above 1GHz | 19 |
| 5.9 Frequency Stability | 19 |
| 6 Test Arrangements | 20 |
| 6.1 Maximum EIRP | 20 |
| 6.1.1 Test Setup | 20 |
| 6.1.2 Test Procedure | 20 |
| 6.2 Modulation Characteristics | 21 |
| 6.2.1 Test Setup | 21 |
| 6.2.2 Test Procedure | 21 |
| 6.3 Maximum Power Spectral Density | 21 |
| 6.3.1 Test Setup | 21 |
| 6.3.2 Test Procedure | 21 |
| 6.4 Peak to Average Ratio | 22 |
| 6.4.1 Test Setup | 22 |
| 6.4.2 Test Procedure | 22 |
| 6.5 Bandwidth | 22 |
| 6.5.1 Test Setup | 22 |
| 6.5.2 Test Procedure | 23 |
| 6.6 Conducted Spurious Emissions | 25 |
| 6.6.1 Test Setup | 25 |
| 6.6.2 Test Procedure | 25 |
| 6.7 Radiated Spurious Emissions below 1GHz | 26 |
| 6.7.1 Test Setup | 26 |
| 6.7.2 Test Procedure | 26 |



| | | |
|----------|--|------------|
| 6.8 | Radiated Spurious Emissions above 1GHz | 27 |
| 6.8.1 | Test Setup | 27 |
| 6.8.2 | Test Procedure | 27 |
| 6.9 | Frequency Stability | 28 |
| 6.9.1 | Test Setup | 28 |
| 6.9.2 | Test Procedure | 28 |
| 7 | Test Results of Test Item | 29 |
| 7.1 | Maximum EIRP | 29 |
| 7.2 | Modulation Characteristics | 35 |
| 7.3 | Maximum Power Spectral Density | 36 |
| 7.4 | Peak to Average Ratio | 39 |
| 7.5 | Bandwidth | 43 |
| 7.6 | Conducted Spurious Emissions | 47 |
| 7.7 | Radiated Spurious Emissions below 1GHz | 79 |
| 7.8 | Radiated Spurious Emissions above 1GHz | 83 |
| 7.9 | Frequency Stability | 92 |
| 8 | Pictures of Test Arrangements | 100 |
| 9 | Information of the Testing Laboratories | 101 |



Release Control Record

| Issue No. | Description | Date Issued |
|------------------------|-------------------|-------------|
| RFBCUN-WTW-P23030714-1 | Original release. | 2023/6/26 |

1 Certificate

Product: 5G small cell

Brand: ASKEY

Test Model: NR xCell 46116A

Sample Status: Engineering sample

Applicant: ASKEY COMPUTER CORP.

Test Date: 2023/5/2 ~ 2023/5/12

Standard: 47 CFR FCC Part 96
47 CFR FCC Part 2

Measurement ANSI/TIA/EIA-603-E 2016

procedure: ANSI C63.26-2015

KDB 971168 D01 Power Meas License Digital Systems v03r01

KDB 940660 D01 Part 96 CBRS Eqpt v03

KDB 662911 D01 Multiple Transmitter Output v02r01

The above equipment has been tested by **Bureau Veritas Consumer Products Services (H.K.) Ltd., Taoyuan Branch**, and found compliance with the requirement of the above standards. The test record, data evaluation & Equipment Under Test (EUT) configurations represented herein are true and accurate accounts of the measurements of the sample's RF characteristics under the conditions specified in this report.

2 Summary of Test Results

| 47 CFR FCC Part 96 & Part 2 | | | |
|--|--|--------|---|
| Standard / Clause | Test Item | Result | Remark |
| FCC 47 CFR Part 2.1046 FCC 47 CFR Part 96.41(b) | Maximum EIRP | Pass | Meet the requirement of limit. |
| FCC 47 CFR Part 2.1047 | Modulation Characteristics | Pass | Meet the requirement of limit. |
| FCC 47 CFR Part 2.1046 FCC 47 CFR Part 96.41(b) | Maximum Power Spectral Density | Pass | Meet the requirement of limit. |
| FCC 47 CFR Part 96.41(g) | Peak to Average Ratio | Pass | Meet the requirement of limit. |
| FCC 47 CFR Part 2.1049 | Bandwidth | Pass | Meet the requirement of limit. |
| FCC 47 CFR Part 2.1051 FCC 47 CFR Part 96.41(e) | Conducted Spurious Emissions | Pass | Meet the requirement of limit. |
| FCC 47 CFR Part 2.1053 FCC 47 CFR Part 96.41(e) | Radiated Spurious Emissions below 1GHz | Pass | Minimum passing margin is -11.61 dB at 55.22 MHz |
| FCC 47 CFR Part 2.1053 FCC 47 CFR Part 96.41(e) | Radiated Spurious Emissions above 1GHz | Pass | Minimum passing margin is -0.17 dB at 7249.98 MHz |
| FCC 47 CFR Part 2.1055 | Frequency Stability | Pass | Meet the requirement of limit. |

Note: Determining compliance based on the results of the compliance measurement, not taking into account measurement instrumentation uncertainty.

2.1 Measurement Uncertainty

Where relevant, the following measurement uncertainty levels have been estimated for tests performed on the EUT as specified in CISPR 16-4-2:

| Measurement | Specification | Expanded Uncertainty (k=2) (±) |
|--|-----------------|-----------------------------------|
| Radiated Spurious Emissions below 1GHz | 9 kHz ~ 30 MHz | 3.00 dB |
| | 30 MHz ~ 1 GHz | 2.93 dB |
| Radiated Spurious Emissions above 1GHz | 1 GHz ~ 18 GHz | 1.76 dB |
| | 18 GHz ~ 40 GHz | 1.77 dB |

The other instruments specified are routine verified to remain within the calibrated levels, no measurement uncertainty is required to be calculated.

2.2 Supplementary Information

There is not any deviation from the test standards for the test method, and no modifications required for compliance.

3 General Information

3.1 General Description of EUT

| | |
|---------------------|--------------------------|
| Product | 5G small cell |
| Brand | ASKEY |
| Test Model | NR xCell 46116A |
| Status of EUT | Engineering sample |
| Power Supply Rating | 12Vdc or 48Vdc (Adapter) |

Note:

1. EUT Overview

Full Maximum EIRP (dBm/channel bandwidth)

| Band / Bandwidth | TX Frequency Range (MHz) | Max. EIRP Power | | |
|-------------------------------|--------------------------|--------------------------------|--------------------------------|--------------------------------|
| | | QPSK | 64QAM | 256QAM |
| n48 (Channel Bandwidth 10MHz) | 3555.00-3694.98 | 659.174mW (28.19dBm/10MHz) | 650.130mW (28.13dBm/10MHz) | 645.654mW (28.10dBm/10MHz) |
| n48 (Channel Bandwidth 20MHz) | 3560.01-3690.00 | 1766.038mW (32.47dBm/20MHz) | 1753.881mW (32.44dBm/20MHz) | 1725.838mW (32.37dBm/20MHz) |
| n48 (Channel Bandwidth 30MHz) | 3565.02-3684.99 | 1927.525mW (32.85dBm/30MHz) | 1905.461mW (32.80dBm/30MHz) | 1883.649mW (32.75dBm/30MHz) |
| n48 (Channel Bandwidth 40MHz) | 3570.00-3679.98 | 1798.871mW (32.55dBm/40MHz) | 1761.976mW (32.46dBm/40MHz) | 1741.807mW (32.41dBm/40MHz) |

Maximum EIRP (dBm/10MHz)

| Band / Bandwidth | TX Frequency Range (MHz) | Max. EIRP Power | | |
|-------------------------------|--------------------------|-------------------------------|-------------------------------|-------------------------------|
| | | QPSK | 64QAM | 256QAM |
| n48 (Channel Bandwidth 10MHz) | 3555.00-3694.98 | 659.174mW (28.19dBm/10MHz) | 650.130mW (28.13dBm/10MHz) | 645.654mW (28.10dBm/10MHz) |
| n48 (Channel Bandwidth 20MHz) | 3560.01-3690.00 | 957.194mW (29.81dBm/10MHz) | 950.605mW (29.78dBm/10MHz) | 937.562mW (29.72dBm/10MHz) |
| n48 (Channel Bandwidth 30MHz) | 3565.02-3684.99 | 669.885mW (28.26dBm/10MHz) | 662.217mW (28.21dBm/10MHz) | 648.634mW (28.12dBm/10MHz) |
| n48 (Channel Bandwidth 40MHz) | 3570.00-3679.98 | 488.652mW (26.89dBm/10MHz) | 483.059mW (26.84dBm/10MHz) | 476.431mW (26.78dBm/10MHz) |

Emission Designator

| Band / Bandwidth | TX Frequency Range (MHz) | Emission Designator | | |
|-------------------------------|--------------------------|---------------------|---------|---------|
| | | QPSK | 64QAM | 256QAM |
| n48 (Channel Bandwidth 10MHz) | 3555.00-3694.98 | 8M60G7D | 8M60D7W | 8M60D7W |
| n48 (Channel Bandwidth 20MHz) | 3560.01-3690.00 | 18M2G7D | 18M3D7W | 18M3D7W |
| n48 (Channel Bandwidth 30MHz) | 3565.02-3684.99 | 27M9G7D | 27M9D7W | 27M9D7W |
| n48 (Channel Bandwidth 40MHz) | 3570.00-3679.98 | 37M9G7D | 37M9D7W | 37M9D7W |

2. The EUT contains following accessory devices and PoE.

| | | |
|--------------|-----------|---|
| AC Adapter 1 | Brand | FLYPOWER |
| | Model | PS65B120Y5000S |
| | AC Input | 100-240Vac~, 15A, 50/60Hz |
| | DC Output | 12.0Vdc, 5.0A |
| AC Adapter 2 | Brand | Sunny |
| | Model | SYS1649-6548-T2 |
| | AC Input | 100-240Vac~, 15A, 50/60Hz |
| | DC Output | 48.0Vdc, 1.35A |
| Bracket | Brand | LUNG TENG |
| | Model | MOD-SCE2200-Wall_Ceiling_Ploe-Mount-Sub |

| | | |
|-----------------------|-------|-----------|
| Power cord | Brand | WELL SHIN |
| | Model | 1961-0048 |
| PoE (Support unit) | Brand | CERiO |
| | Model | FPOE-DXG |

3. The above EUT information is declared by manufacturer and for more detailed features description, please refers to the manufacturer's specifications or user's manual.
4. The EUT device does not support 16QAM modulation and only supports Full RB mode.

3.2 Antenna Description of EUT

1. The antenna information is listed as below.

| Antenna Type | Antenna Gain(dBi) | | | Connector Type |
|--------------|-------------------|-------|-------|----------------|
| | Frequency(MHz) | Ant 1 | Ant 2 | |
| Dipole | 3300 | 5.54 | 4.80 | I-PEX |
| | 3550 | 4.79 | 5.05 | |
| | 3700 | 4.71 | 5.79 | |
| | 3800 | 5.14 | 6.20 | |

* The above Antenna information is declared by manufacturer and for more detailed features description, please refer to the manufacturer's specifications, the laboratory shall not be held responsible.

3.3 Test Mode Applicability and Tested Channel Detail

| | |
|-------------|--|
| Pre-Scan: | EUT can be used in the following ways: X-axis/ Y-axis/ Z-axis. Pre-scan these ways and find the worst case as a representative test condition. |
| Worst Case: | X-axis/ Y-axis/ Z-axis Worst Condition: Z-axis |

| Test Item | EUT Configure Mode | Tested Channel | Channel Bandwidth | Modulation | Mode |
|--------------------------------|--------------------|--|-------------------|-----------------------|---------|
| EIRP | A | 637000 (3555.00 MHz) 641666 (3624.99 MHz) 646332 (3694.98 MHz) | 10 MHz | QPSK / 64QAM / 256QAM | Full RB |
| | A | 637334 (3560.01 MHz) 641666 (3624.99 MHz) 646000 (3690.00 MHz) | 20 MHz | QPSK / 64QAM / 256QAM | Full RB |
| | A | 637668 (3565.02 MHz) 641666 (3624.99 MHz) 645666 (3684.99 MHz) | 30 MHz | QPSK / 64QAM / 256QAM | Full RB |
| | A | 638000 (3570.00 MHz) 641666 (3624.99 MHz) 645332 (3679.98 MHz) | 40 MHz | QPSK / 64QAM / 256QAM | Full RB |
| Modulation Characteristics | A | 641666 (3624.99 MHz) | 40 MHz | QPSK / 64QAM / 256QAM | Full RB |
| Maximum Power Spectral Density | A | 637000 (3555.00 MHz) 641666 (3624.99 MHz) 646332 (3694.98 MHz) | 10 MHz | QPSK / 64QAM / 256QAM | Full RB |
| | A | 637334 (3560.01 MHz) 641666 (3624.99 MHz) 646000 (3690.00 MHz) | 20 MHz | QPSK / 64QAM / 256QAM | Full RB |
| | A | 637668 (3565.02 MHz) 641666 (3624.99 MHz) 645666 (3684.99 MHz) | 30 MHz | QPSK / 64QAM / 256QAM | Full RB |
| | A | 638000 (3570.00 MHz) 641666 (3624.99 MHz) 645332 (3679.98 MHz) | 40 MHz | QPSK / 64QAM / 256QAM | Full RB |
| Peak to Average Ratio | A | 637000 (3555.00 MHz) 641666 (3624.99 MHz) 646332 (3694.98 MHz) | 10 MHz | QPSK / 64QAM / 256QAM | Full RB |
| | A | 637334 (3560.01 MHz) 641666 (3624.99 MHz) 646000 (3690.00 MHz) | 20 MHz | QPSK / 64QAM / 256QAM | Full RB |
| | A | 637668 (3565.02 MHz) 641666 (3624.99 MHz) 645666 (3684.99 MHz) | 30 MHz | QPSK / 64QAM / 256QAM | Full RB |
| | A | 638000 (3570.00 MHz) 641666 (3624.99 MHz) 645332 (3679.98 MHz) | 40 MHz | QPSK / 64QAM / 256QAM | Full RB |

| Test Item | EUT Configure Mode | Tested Channel | Channel Bandwidth | Modulation | Mode |
|---------------------|--------------------|--|-------------------|--------------------------|---------|
| Occupied Bandwidth | A | 637000 (3555.00 MHz) 641666 (3624.99 MHz) 646332 (3694.98 MHz) | 10 MHz | QPSK / 64QAM / 256QAM | Full RB |
| | A | 637334 (3560.01 MHz) 641666 (3624.99 MHz) 646000 (3690.00 MHz) | 20 MHz | QPSK / 64QAM / 256QAM | Full RB |
| | A | 637668 (3565.02 MHz) 641666 (3624.99 MHz) 645666 (3684.99 MHz) | 30 MHz | QPSK / 64QAM / 256QAM | Full RB |
| | A | 638000 (3570.00 MHz) 641666 (3624.99 MHz) 645332 (3679.98 MHz) | 40 MHz | QPSK / 64QAM / 256QAM | Full RB |
| Conducted Emission | A | 637000 (3555.00 MHz) 641666 (3624.99 MHz) 646332 (3694.98 MHz) | 10 MHz | QPSK | Full RB |
| | A | 637334 (3560.01 MHz) 641666 (3624.99 MHz) 646000 (3690.00 MHz) | 20 MHz | QPSK | Full RB |
| | A | 637668 (3565.02 MHz) 641666 (3624.99 MHz) 645666 (3684.99 MHz) | 30 MHz | QPSK | Full RB |
| | A | 638000 (3570.00 MHz) 641666 (3624.99 MHz) 645332 (3679.98 MHz) | 40 MHz | QPSK | Full RB |
| RE Below 1GHz | A, B | 641666 (3624.99 MHz) | 40 MHz | QPSK | Full RB |
| RE Above 1GHz | A | 637000 (3555.00 MHz) 641666 (3624.99 MHz) 646332 (3694.98 MHz) | 10 MHz | QPSK | Full RB |
| | A | 637334 (3560.01 MHz) 641666 (3624.99 MHz) 646000 (3690.00 MHz) | 20 MHz | QPSK | Full RB |
| | A | 638000 (3570.00 MHz) 641666 (3624.99 MHz) 645332 (3679.98 MHz) | 40 MHz | QPSK | Full RB |
| Frequency Stability | A | 637000 (3555.00 MHz) 646332 (3694.98 MHz) | 10 MHz | QPSK | Full RB |
| | A | 637334 (3560.01 MHz) 646000 (3690.00 MHz) | 20 MHz | QPSK | Full RB |
| | A | 637668 (3565.02 MHz) 645666 (3684.99 MHz) | 30 MHz | QPSK | Full RB |
| | A | 638000 (3570.00 MHz) 645332 (3679.98 MHz) | 40 MHz | QPSK | Full RB |
| EUT Configure Mode | Mode | Power | | | |
| | A | Power from Adapter 1 | | | |
| | B | Power from Adapter 2 | | | |

3.4 Test Program Used and Operation Descriptions

There is no need to controlling software during the test, and the EUT can be paired with the 5G Wireless Test Platforms to test the connection when it is powered on.

3.5 Connection Diagram of EUT and Peripheral Devices

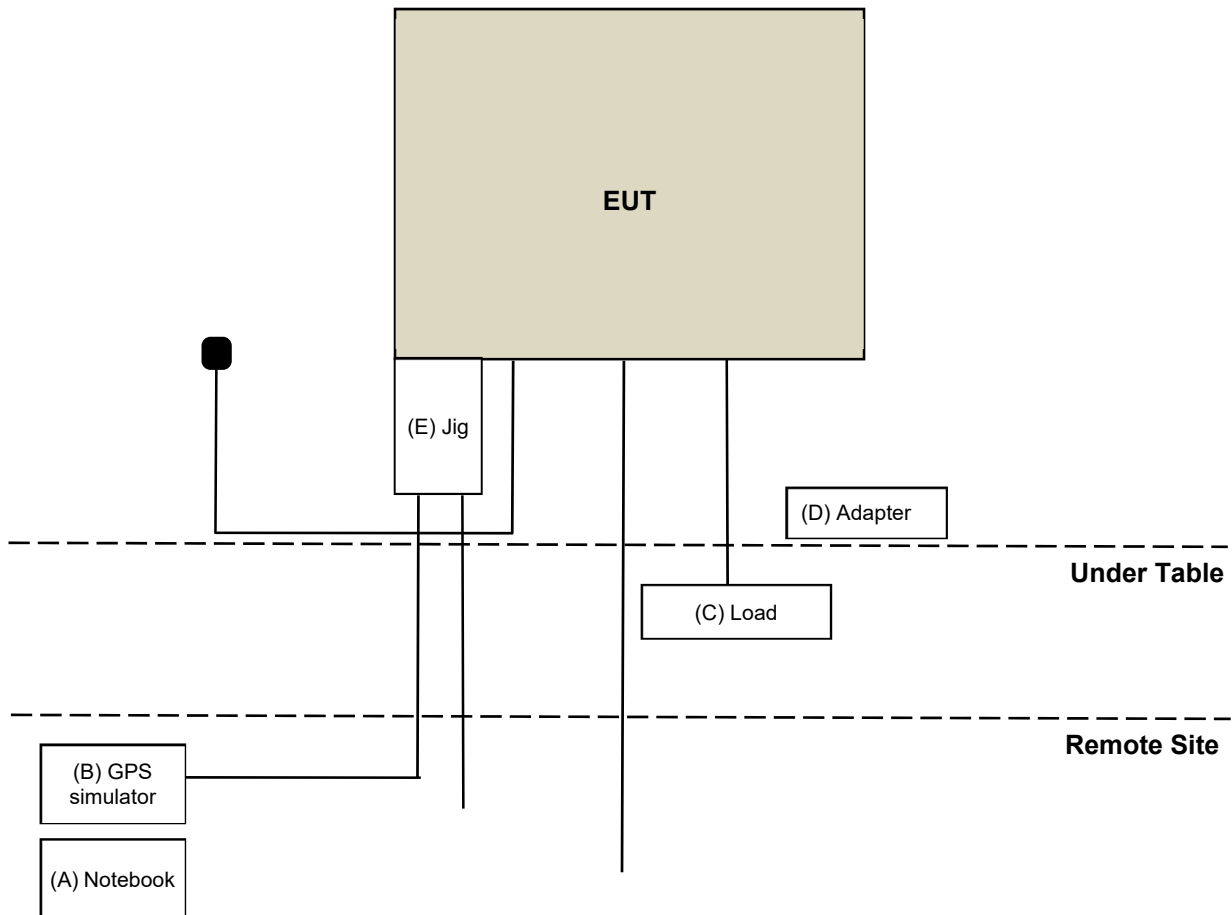

3.6 Configuration of Peripheral Devices and Cable Connections

| ID | Product | Brand | Model No. | Serial No. | FCC ID | Remarks |
|----|---------------|------------------------|-----------------|------------|--------|-------------------------|
| A | Notebook | NA | NA | NA | NA | Supplied by applicant |
| B | GPS simulator | T&E Communication LTD. | GSG-5 | 201062 | NA | Provided by Lab |
| C | Load | NA | NA | NA | NA | Provided by Lab |
| D | Adapter | FLYPOWER | PS65B120Y5000S | NA | NA | Accessory (Test Mode A) |
| | | Sunny | SYS1649-6548-T2 | NA | NA | Accessory (Test Mode B) |
| E | Jig | NA | NA | NA | NA | Supplied by applicant |
| F | GPS ANT | NA | NA | NA | NA | Supplied by applicant |

| ID | Cable Descriptions | Qty. | Length (m) | Shielding (Yes/No) | Cores (Qty.) | Remarks |
|----|--------------------|------|------------|--------------------|--------------|-----------------|
| 1 | RJ-45 Cable | 1 | 6 | N | N | Provided by Lab |
| 2 | RF Cable | 1 | 6 | N | N | Provided by Lab |
| 3 | RF Cable | 1 | 6 | N | N | Provided by Lab |
| 4 | Fiber optic cable | 1 | 3 | N | N | Provided by Lab |
| 5 | RJ-45 Cable | 1 | 1.5 | N | N | Provided by Lab |

4 Test Instruments

The calibration interval of the all test instruments are 12 months and the calibrations are traceable to NML/ROC and NIST/USA.

4.1 Maximum EIRP

| Description Manufacturer | Model No. | Serial No. | Calibrated Date | Calibrated Until |
|--|----------------------------------|------------|--------------------|---------------------|
| PXA Signal Analyzer Keysight | N9030B | MY57140488 | 2023/3/6 | 2024/03/05 |
| 5G Wireless Test Platforms Keysight | E7515B | MY60102114 | 2022/5/20 | 2023/5/19 |
| Software BV | ADT_RF Test Software V6.6.5.4 | N/A | N/A | N/A |

Notes:

1. The test was performed in Oven room.
2. Tested Date: 2023/5/5

4.2 Modulation Characteristics

| Description Manufacturer | Model No. | Serial No. | Calibrated Date | Calibrated Until |
|--|----------------------------------|------------|--------------------|---------------------|
| PXA Signal Analyzer Keysight | N9030B | MY57140488 | 2023/3/6 | 2024/03/05 |
| 5G Wireless Test Platforms Keysight | E7515B | MY60102114 | 2022/5/20 | 2023/5/19 |
| Software BV | ADT_RF Test Software V6.6.5.4 | N/A | N/A | N/A |

Notes:

1. The test was performed in Oven room.
2. Tested Date: 2023/5/4

4.3 Maximum Power Spectral Density

Refer to section 4.2 to get information of the instruments.

4.4 Peak to Average Ratio

| Description Manufacturer | Model No. | Serial No. | Calibrated Date | Calibrated Until |
|--|----------------------------------|------------|--------------------|---------------------|
| PXA Signal Analyzer Keysight | N9030B | MY57140488 | 2023/3/6 | 2024/03/05 |
| 5G Wireless Test Platforms Keysight | E7515B | MY60102114 | 2022/5/20 | 2023/5/19 |
| Software BV | ADT_RF Test Software V6.6.5.4 | N/A | N/A | N/A |

Notes:

1. The test was performed in Oven room.
2. Tested Date: 2023/3/31 ~ 2023/4/7

4.5 Bandwidth

Refer to section 4.4 to get information of the instruments.

4.6 Conducted Spurious Emissions

Refer to section 4.4 to get information of the instruments.

4.7 Radiated Spurious Emissions below 1GHz

| Description Manufacturer | Model No. | Serial No. | Calibrated Date | Calibrated Until |
|---------------------------------|------------------------------|---------------|--------------------|---------------------|
| Software BV ADT | ADT_Radiated_ V7.6.15.9.5 | NA | NA | NA |
| Antenna Tower & Turn BV ADT | AT100 | AT93021705 | NA | NA |
| Turn Table BV ADT | TT100 | TT93021705 | NA | NA |
| Turn Table Controller BV ADT | SC100 | SC93021705 | NA | NA |
| Test Receiver Keysight | N9038A | MY55420137 | 2023/5/3 | 2024/5/2 |
| Spectrum Analyzer R&S | FSW43 | 101867 | 2022/12/30 | 2023/12/29 |
| Loop Antenna TESEQ | HLA 6121 | 45745 | 2022/7/27 | 2023/7/26 |
| Loop Antenna EMCI | EM-6879 | 269 | 2022/9/19 | 2023/9/18 |
| Pre-amplifier EMCI | EMC001340 | 980201 | 2022/9/23 | 2023/9/22 |
| RF Coaxial Cable EMCI | 5D-NM-BM | 140903+140902 | 2023/1/7 | 2024/1/6 |
| Preamplifier Agilent | 8447D | 2944A10638 | 2023/5/7 | 2024/5/6 |
| Bi_Log Antenna Schwarbeck | VULB9168 | 9168-160 | 2022/10/20 | 2023/10/19 |
| RF Coaxial Cable WOKEN | 8D-FB | Cable-CH9-01 | 2023/5/7 | 2024/5/6 |

Notes:

1. The test was performed in HY - 966 chamber 4.
2. Tested Date: 2023/5/12

4.8 Radiated Spurious Emissions above 1GHz

| Description Manufacturer | Model No. | Serial No. | Calibrated Date | Calibrated Until |
|---------------------------------------|-----------------------------------|---------------------------------|--------------------|---------------------|
| Software BV ADT | ADT_Radiated_ V7.6.15.9.5 | NA | NA | NA |
| Antenna Tower & Turn BV ADT | AT100 | AT93021705 | NA | NA |
| Turn Table BV ADT | TT100 | TT93021705 | NA | NA |
| Turn Table Controller BV ADT | SC100 | SC93021705 | NA | NA |
| Horn Antenna Schwarzbeck | 9120D | 9120D-1169 | 2022/11/13 | 2023/11/12 |
| Pre-amplifier Agilent | 8449B | 3008A02367 | 2023/2/15 | 2024/2/14 |
| RF Coaxial Cable HUBER+SUHNER&EMCI | SUCOFLEX 104& EMC104-SM-SM8000 | CABLE-CH9-02 (248780+171006) | 2023/1/7 | 2024/1/6 |
| RF Coaxial Cable HUBER+SUHNER | SUCOFLEX 104 | CABLE-CH9-(250795/4) | 2023/1/7 | 2024/1/6 |
| RF FILTER MICRO-TRONICS | BRM50716 | 060 | 2023/1/11 | 2024/1/10 |
| RF FILTER MICRO-TRONICS | BRM17690 | 004 | 2023/1/11 | 2024/1/10 |
| Pre-Amplifier EMCI | EMC 184045 | 980116 | 2022/10/1 | 2023/9/30 |
| Horn Antenna Schwarzbeck | BBHA 9170 | 9170-480 | 2022/11/13 | 2023/11/12 |
| Horn Antenna Schwarzbeck | BBHA 9170 | BBHA9170243 | 2022/11/13 | 2023/11/12 |
| RF Coaxial Cable EMCI | EMC102-KM-KM-3000 | 150929 | 2022/7/9 | 2023/7/8 |
| RF Coaxial Cable EMCI | EMC102-KM-KM-600 | 150928 | 2022/7/9 | 2023/7/8 |
| Boresight antenna tower fixture BV | BAF-02 | 5 | NA | NA |

Notes:

1. The test was performed in HY - 966 chamber 4.
2. Tested Date: 2023/5/12

4.9 Frequency Stability

| Description Manufacturer | Model No. | Serial No. | Calibrated Date | Calibrated Until |
|---|----------------------------------|----------------|--------------------|---------------------|
| 3-channel DC power supply JIN YIH Technology | ODP3033 | ODP30332128138 | N/A | N/A |
| Digital Multimeter Fluke | 87-III | 70360742 | 2022/6/23 | 2023/6/22 |
| Software BV | ADT_RF Test Software V6.6.5.4 | N/A | N/A | N/A |
| Spectrum Analyzer R&S | FSV40 | 101544 | 2022/5/9 | 2023/5/8 |
| Temperature & Humidity Chamber TERCHY | HRM-120RF | 931022 | 2022/12/27 | 2023/12/26 |
| 5G Wireless Test Platforms Keysight | E7515B | MY60102114 | 2022/5/20 | 2023/5/19 |

Notes:

1. The test was performed in Oven room.
2. Tested Date: 2023/5/2 ~ 2023/5/4

5 Limits of Test Items

5.1 Maximum EIRP

| Device | | Maximum EIRP (dBm/10 MHz) |
|-------------------------------------|-----------------|------------------------------|
| <input type="checkbox"/> | End User Device | 23 |
| <input checked="" type="checkbox"/> | Category A CBSD | 30 |
| <input type="checkbox"/> | Category B CBSD | 47 |

5.2 Modulation Characteristics

A curve or equivalent data which shows that the equipment will meet the modulation requirements of the rules under which the equipment is to be licensed.

5.3 Maximum Power Spectral Density

| Device | | Maximum PSD (dBm/MHz) |
|-------------------------------------|-----------------|-----------------------|
| <input type="checkbox"/> | End User Device | n/a |
| <input checked="" type="checkbox"/> | Category A CBSD | 20 |
| <input type="checkbox"/> | Category B CBSD | 37 |

5.4 Peak to Average Ratio

In measuring transmissions in this band using an average power technique, the peak to-average ratio (PAR) of the transmission may not exceed 13 dB.

5.5 Bandwidth

According to FCC 47 CFR part 2.1049, the occupied bandwidth, that is the frequency bandwidth such that, below its lower and above its upper frequency limits, the mean powers radiated are each equal to 0.5% of the total mean power radiated by a given emission.

5.6 Conducted Spurious Emissions

| Power of any emissions outside the Fundamental | Limit |
|--|-------------|
| Within 0-10MHz above the Assigned Channel | -13 dBm/MHz |
| Within 0-10MHz below the Assigned Channel | |
| Greater than 10MHz above the Assigned Channel | -25 dBm/MHz |
| Greater than 10MHz below the Assigned Channel | |
| Power of any emission below 3530MHz | -40 dBm/MHz |
| Power of any emission above 3720MHz | |

Note: The device has MIMO function, so the limit of conducted spurious emissions need to be reduced by $10\log(\text{Numbers}_{\text{ANT}})$ according to FCC KDB 662911 D01 guidance.

5.7 Radiated Spurious Emissions below 1GHz

| Power of any emissions outside the Fundamental | Limit |
|--|-------------|
| Within 0-10MHz above the Assigned Channel | -13 dBm/MHz |
| Within 0-10MHz below the Assigned Channel | |
| Greater than 10MHz above the Assigned Channel | -25 dBm/MHz |
| Greater than 10MHz below the Assigned Channel | |
| Power of any emission below 3530MHz | -40 dBm/MHz |
| Power of any emission above 3720MHz | |

5.8 Radiated Spurious Emissions above 1GHz

| Power of any emissions outside the Fundamental | Limit |
|--|-------------|
| Within 0-10MHz above the Assigned Channel | -13 dBm/MHz |
| Within 0-10MHz below the Assigned Channel | |
| Greater than 10MHz above the Assigned Channel | -25 dBm/MHz |
| Greater than 10MHz below the Assigned Channel | |
| Power of any emission below 3530MHz | -40 dBm/MHz |
| Power of any emission above 3720MHz | |

5.9 Frequency Stability

The frequency stability shall be sufficient to ensure that the fundamental emissions stay within the authorized bands of operation (authorized frequency block).

6 Test Arrangements

6.1 Maximum EIRP

6.1.1 Test Setup

Conducted Power Measurement:

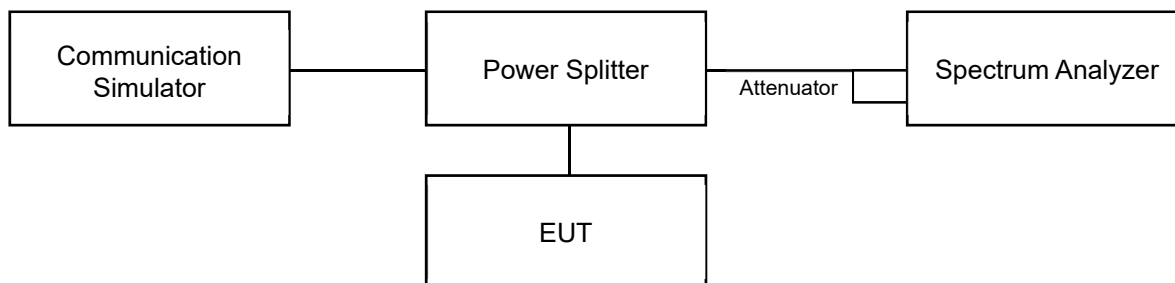

6.1.2 Test Procedure

Conducted Power Measurement:

The EUT is configured by test software or key-in commands to set data modulation and maximum power using WWAN technology and link to spectrum analyzer measurements. Set the EUT to transmit under low, middle and high channel and record the power level shown on spectrum analyzer. Power measurements use detector average (rms).

Measurement method refers to ANSI C63.26 section 5.2.4.4.

- a. Set span to $1.5 \times$ the OBW.
- b. Set RBW = 1% to 5% of the OBW.
- c. Set VBW $\geq 3 \times$ RBW.
- d. Set number of measurement points in sweep $\geq 2 \times$ span / RBW.
- e. Set Sweep time = auto-couple.
- f. Detector = power averaging (rms).
- g. Set sweep trigger to "free run."
- h. Trace average at least 100 traces in power averaging (rms) mode.
- i. Compute power by integrating the spectrum across the OBW of the signal using the instrument's band or channel power measurement function with band/channel limits set equal to the OBW band edges.
- j. If Duty cycle < 98%, Add $10 \log (1/\text{duty cycle})$ to the measured power level to compute the average power during continuous transmission.
- k. For per 10MHz method, channel power integrating bandwidth 10MHz is used for bandwidth 20M and 40M. For full power method, channel power integrating bandwidth 20MHz is used for bandwidth 20M, integrating bandwidth 40MHz is used for bandwidth 40M.

Maximum EIRP / ERP

The relevant equation for determining the maximum ERP or EIRP from the measured RF output power is given in Equation as follows:

$$\text{EIRP} = P_{\text{Meas}} + G_{\text{T}}$$

$$\text{ERP} = P_{\text{Meas}} + G_{\text{T}} - 2.15$$

where

ERP or EIRP effective radiated power or equivalent isotropically radiated power, respectively

(expressed in the same units as P_{Meas} , e.g., dBm or dBW)

P_{Meas} measured transmitter output power or PSD, in dBm or dBW

G_{T} gain of the transmitting antenna, in dBd (ERP) or dBi (EIRP)

6.2 Modulation Characteristics

6.2.1 Test Setup

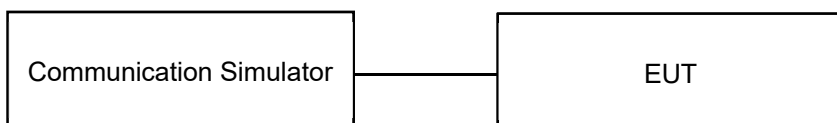

6.2.2 Test Procedure

Connect the EUT to Communication Simulator via the antenna connector, the frequency band is set as EUT supported Modulation and Channels, the EUT output is matched with 50 ohm load, the waveform quality and constellation of the EUT was tested.

6.3 Maximum Power Spectral Density

6.3.1 Test Setup

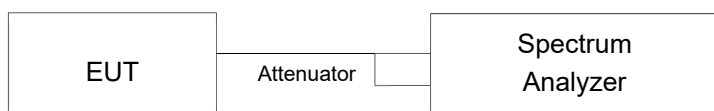

6.3.2 Test Procedure

- a. Connect the transmitter to the spectrum analyzer via coaxial cable while ensuring proper impedance matching.
- b. Set instrument center frequency to OBW center frequency.
- c. Set span to $2 \times$ to $3 \times$ the OBW.
- d. Set the RBW to the specified reference bandwidth (often 1 MHz).
- e. Set VBW $\geq 3 \times$ RBW.
- f. Detector = RMS (power averaging).
- g. Ensure that the number of measurement points in the sweep $\geq 2 \times$ span/RBW.
- h. Sweep time = auto couple.
- i. Employ trace averaging (RMS) mode over a minimum of 100 traces.
- j. Use the peak marker function to determine the maximum amplitude level within the reference bandwidth (PSD).

6.4 Peak to Average Ratio

6.4.1 Test Setup

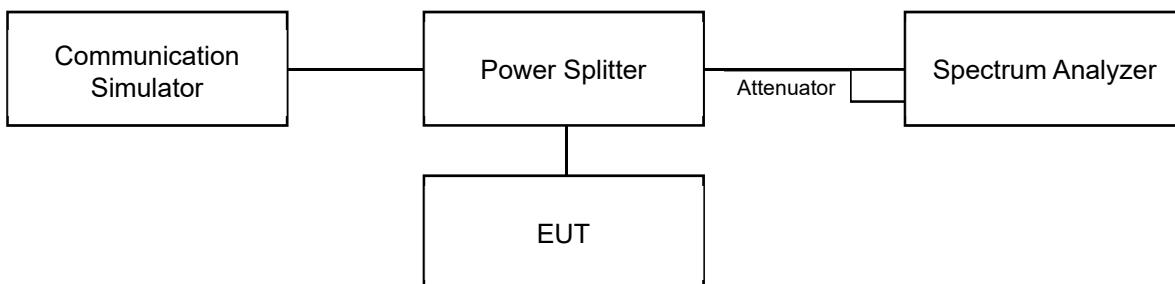

6.4.2 Test Procedure

- Set resolution/measurement bandwidth \geq signal's occupied bandwidth;
- Set the number of counts to a value that stabilizes the measured CCDF curve;
- Record the maximum PAPR level associated with a probability of 0.1%.

6.5 Bandwidth

6.5.1 Test Setup

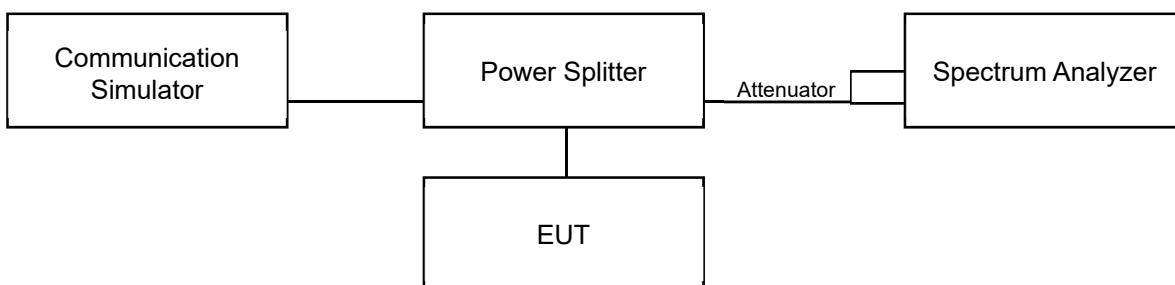

6.5.2 Test Procedure

For the 26 dBc bandwidth measurement method, please refer to section 5.4.3 of ANSI C63.26.

- a. The spectrum analyzer center frequency is set to the nominal EUT channel center frequency. The span range for the spectrum analyzer shall be wide enough to see sufficient roll off of the signal to make the measurement.
- b. The nominal RBW shall be in the range of 1% to 5% of the anticipated OBW, and the VBW shall be set $\geq 3 \times$ RBW.
- c. Set the reference level of the instrument as required to prevent the signal amplitude from exceeding the maximum spectrum analyzer input mixer level for linear operation. See guidance provided in 4.2.3.
- d. The dynamic range of the spectrum analyzer at the selected RBW shall be more than 10 dB below the target “-X dB” requirement, i.e., if the requirement calls for measuring the -26 dB OBW, the spectrum analyzer noise floor at the selected RBW shall be at least 36 dB below the reference level.
- e. Set spectrum analyzer detection mode to peak, and the trace mode to max hold.
- f. Determine the following reference values: Set the EUT to transmit a modulated signal. Allow the trace to stabilize. Set the spectrum analyzer marker to the highest level of the displayed trace (this is the reference value).
- g. Determine the “-X dB amplitude” as equal to (Reference Value - X). Alternatively, this calculation can be performed on the spectrum analyzer using the delta-marker measurement function.
- h. Place two markers, one at the lowest and the other at the highest frequency of the envelope of the spectral display such that each marker is at or slightly below the “-X dB amplitude” determined in step f). If a marker is below this “-X dB amplitude” value it should be as close as possible to this value. The OBW is the positive frequency difference between the two markers.
- i. The OBW shall be reported by providing plot(s) of the measuring instrument display, to include markers depicting the relevant frequency and amplitude information (e.g., marker table). The frequency and amplitude axis and scale shall be clearly labeled. Tabular data may be reported in addition to the plot(s).

For the occupied bandwidth measurement method, please refer to section 5.4.4 of ANSI C63.26.

- a. The spectrum analyzer center frequency is set to the nominal EUT channel center frequency. The span range for the spectrum analyzer shall be wide enough to see sufficient roll off of the signal to make the measurement.
- b. The nominal RBW shall be in the range of 1% to 5% of the anticipated OBW, and the VBW shall be set $\geq 3 \times$ RBW.
- c. Set the reference level of the instrument as required to prevent the signal amplitude from exceeding the maximum spectrum analyzer input mixer level for linear operation. See guidance provided in 4.2.3.
- d. The dynamic range of the spectrum analyzer at the selected RBW shall be more than 10 dB below the target “-X dB” requirement, i.e., if the requirement calls for measuring the -26 dB OBW, the spectrum analyzer noise floor at the selected RBW shall be at least 36 dB below the reference level.
- e. Set spectrum analyzer detection mode to peak, and the trace mode to max hold.
- f. Determine the reference value by either of the following:
 - g. 1) Set the EUT to transmit a modulated signal. Allow the trace to stabilize. Set the spectrum analyzer marker to the highest level of the displayed trace (this is the reference value).
 - h. 2) Set the EUT to transmit an unmodulated carrier. Set the spectrum analyzer marker to the level of the carrier.
- i. Determine the “-X dB amplitude” as equal to (Reference Value - X). Alternatively, this calculation can be performed on the spectrum analyzer using the delta-marker measurement function.
- j. If the reference value was determined using an unmodulated carrier, turn the EUT modulation on, then either clear the existing trace or start a new trace on the spectrum analyzer and allow the new trace to stabilize. Otherwise the trace from step f) shall be used for step i).
- k. Place two markers, one at the lowest and the other at the highest frequency of the envelope of the spectral display such that each marker is at or slightly below the “-X dB amplitude” determined in step f). If a marker is below this “-X dB amplitude” value it should be as close as possible to this value. The OBW is the positive frequency difference between the two markers. The spectral envelope can cross the “-X dB amplitude” at multiple points. The lowest or highest frequency shall be selected as the frequencies that are the farthest away from the center frequency at which the spectral envelope crosses the “-X dB amplitude.”
- l. The OBW shall be reported by providing plot(s) of the measuring instrument display, to include markers depicting the relevant frequency and amplitude information (e.g., marker table). The frequency and amplitude axis and scale shall be clearly labeled. Tabular data may be reported in addition to the plot(s).

6.6 Conducted Spurious Emissions

6.6.1 Test Setup

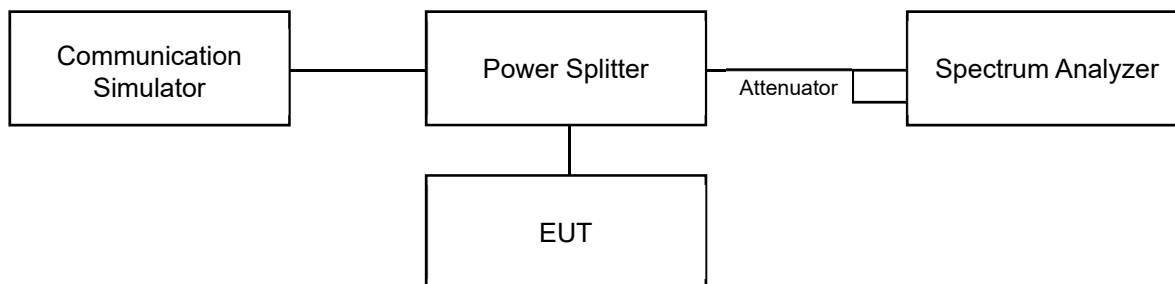

6.6.2 Test Procedure

- a. Measurement refer to ANSI C63.26 section 5.7.
- b. All measurements were done at 3 channels: low, middle and high operational frequency range.
- c. Measuring frequency range is from 9 kHz up to the tenth harmonic of the highest fundamental frequency or to 40 GHz, whichever is lower. 20 dB attenuation pad is connected with spectrum.
- d. The fundamental frequency above 1 GHz, the spectrum set RBW = 1 MHz, VBW = 3 MHz, Detector = Average.
- e. The fundamental frequency below 1 GHz, the spectrum set RBW \geq 100 kHz, VBW \geq 3 x RBW, Detector = Average.
- f. Measuring frequency band edge, narrow RBW (no less than 1% of the OBW) is used for conducted emission measurement.

6.7 Radiated Spurious Emissions below 1GHz

6.7.1 Test Setup

For radiated emission 30 MHz to 1 GHz

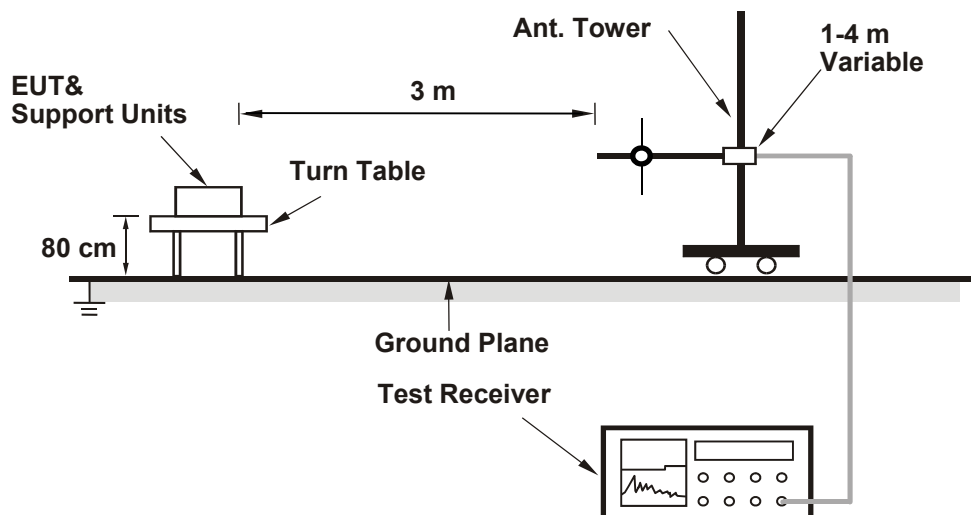

For the actual test configuration, please refer to the attached file (Test Setup Photo).

6.7.2 Test Procedure

The EUT is configured by test software or key-in commands to set data modulation and maximum power using WWAN technology.

- In the semi-anechoic chamber, EUT placed on the 0.8 m (below or equal 1 GHz) height of turn table, rotated the table around 360 degrees to search the maximum radiation power and receiver antenna shall be rotated vertical and horizontal polarization and moved height from 1 m to 4 m to find the maximum polar radiated power. The "Read Value" is the spectrum reading the maximum power value.
- The height of antenna is varied from one meter to four meters above the ground to determine the maximum value of the field strength. Both horizontal and vertical polarizations of the antenna are set to make the measurement.
- Perform a field strength measurement and record the worse read value, is the field strength value via a spectrum reading obtained corrected for antenna factor, cable loss and pre-amplifier factor and then mathematically convert the measured field strength level to EIRP/ERP level.
- Following C63.26 section 5.5 and 5.2.7
- $EIRP (dBm) = E (dB\mu V/m) + 20\log(D) - 104.8$; where D is the measurement distance (in the far field region) in m.
- $ERP (dBm) = E (dB\mu V/m) + 20\log(D) - 104.8 - 2.15$; where D is the measurement distance (in the far field region) in m.

Note:

- The resolution bandwidth and video bandwidth of test receiver/spectrum analyzer is 1 MHz/3 MHz. Set detector = average.
- The emission levels were against the limit of frequency range 9 kHz ~ 30 MHz:
The amplitude of spurious emissions attenuated more than 20 dB below the permissible value is not required to be report.

6.8 Radiated Spurious Emissions above 1GHz

6.8.1 Test Setup

For radiated emission above 1 GHz

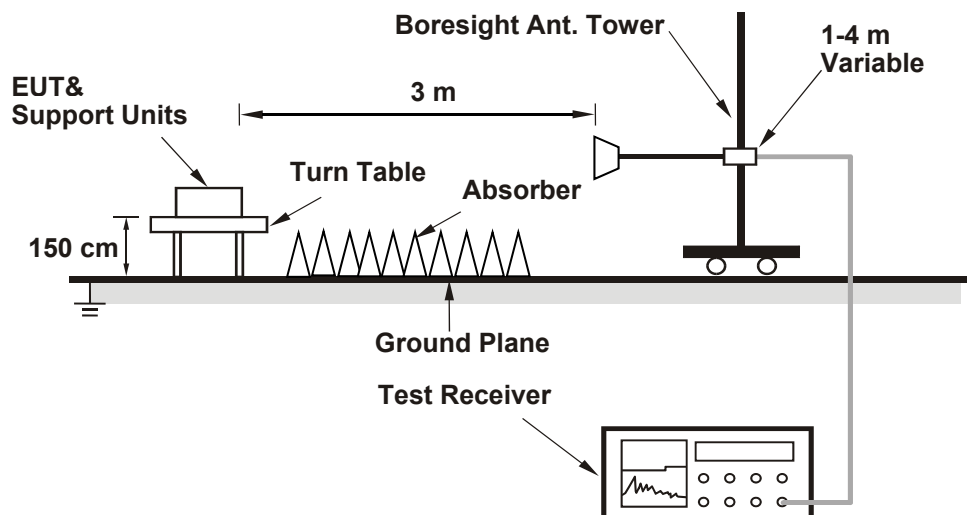

For the actual test configuration, please refer to the attached file (Test Setup Photo).

6.8.2 Test Procedure

The EUT is configured by test software or key-in commands to set data modulation and maximum power using WWAN technology.

- In the semi-anechoic chamber, EUT placed on the 1.5 m height of turn table, rotated the table around 360 degrees to search the maximum radiation power and receiver antenna shall be rotated vertical and horizontal polarization and moved height from 1 m to 4 m to find the maximum polar radiated power. The "Read Value" is the spectrum reading the maximum power value.
- The height of antenna is varied from one meter to four meters above the ground to determine the maximum value of the field strength. Both horizontal and vertical polarizations of the antenna are set to make the measurement.
- Perform a field strength measurement and record the worse read value, is the field strength value via a spectrum reading obtained corrected for antenna factor, cable loss and pre-amplifier factor and then mathematically convert the measured field strength level to EIRP/ERP level.
- Following C63.26 section 5.5 and 5.2.7
- $EIRP (dBm) = E (dB\mu V/m) + 20\log(D) - 104.8$; where D is the measurement distance (in the far field region) in m.
- $ERP (dBm) = E (dB\mu V/m) + 20\log(D) - 104.8 - 2.15$; where D is the measurement distance (in the far field region) in m.

Note:

- The resolution bandwidth and video bandwidth of test receiver/spectrum analyzer is 1 MHz/3 MHz. Set detector = average.

6.9 Frequency Stability

6.9.1 Test Setup

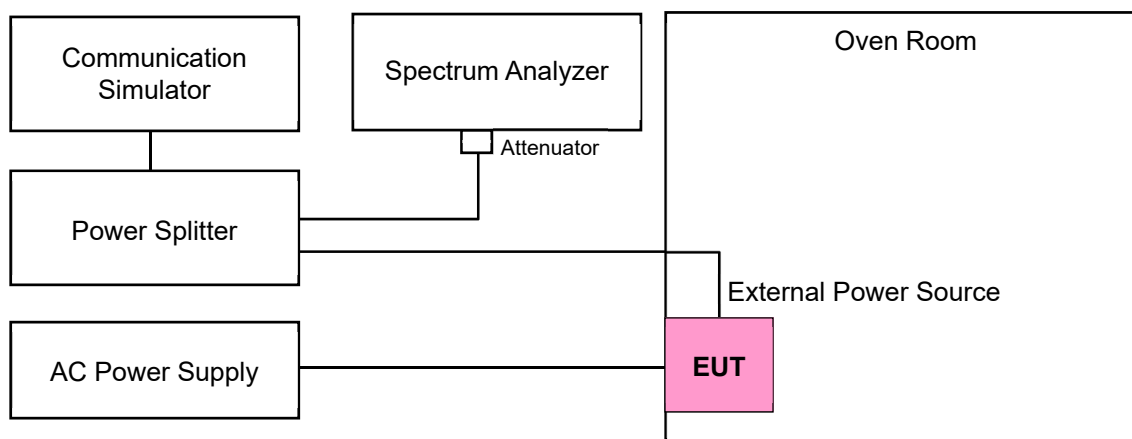

6.9.2 Test Procedure

The EUT is configured by test software or key-in commands to set data modulation and maximum power using WWAN technology.

- Device is placed at the oven room. The oven room could control the temperatures and humidity. Power warm up is at least 15 min and power applied should perform before recording frequency error.
- EUT is connected the external power supply to control the AC input power. The test voltage range is from minimum to maximum working voltage. Each step shall be record the frequency error rate.
- The temperature range step is 10 degrees in this test items. All temperature levels shall be hold the $\pm 0.5^{\circ}\text{C}$ during the measurement testing. The each temperature step shall be at least 0.5 hours, consider the EUT could be test under the stability condition.

Note: The frequency error was recorded frequency error from the communication simulator.

7 Test Results of Test Item

7.1 Maximum EIRP

| | | | | | |
|--------------|---------------|---------------------------|--------------|------------|------------|
| Input Power: | 120 Vac, 60Hz | Environmental Conditions: | 22°C, 70% RH | Tested By: | James Yang |
|--------------|---------------|---------------------------|--------------|------------|------------|

Per 10M Power

| NR Band 48_Per 10M (dBm) | | | | | |
|--------------------------|----------------------|---------------|-------|-------|--------|
| BW | Channel | Chain | QPSK | 64QAM | 256QAM |
| 40 MHz | 638000 3570MHz | 0 | 14.48 | 14.44 | 14.41 |
| | | 1 | 16.44 | 16.38 | 16.31 |
| | | Total Power | 18.58 | 18.53 | 18.47 |
| | | E.I.R.P. | 26.89 | 26.84 | 26.78 |
| | | Power Setting | 225 | | |
| | 641666 3624.99MHz | 0 | 13.44 | 13.39 | 13.30 |
| | | 1 | 14.53 | 14.46 | 14.38 |
| | | Total Power | 17.03 | 16.97 | 16.88 |
| | | E.I.R.P. | 25.34 | 25.28 | 25.19 |
| | | Power Setting | 220 | | |
| | 645332 3679.98MHz | 0 | 14.75 | 14.71 | 14.68 |
| | | 1 | 16.07 | 16.03 | 15.99 |
| | | Total Power | 18.47 | 18.43 | 18.39 |
| | | E.I.R.P. | 26.78 | 26.74 | 26.70 |
| | | Power Setting | 245 | | |
| BW | Channel | Chain | QPSK | 64QAM | 256QAM |
| 30 MHz | 637668 3565.02MHz | 0 | 16.54 | 15.50 | 15.46 |
| | | 1 | 16.84 | 16.79 | 16.72 |
| | | Total Power | 19.70 | 19.20 | 19.15 |
| | | E.I.R.P. | 28.01 | 27.51 | 27.46 |
| | | Power Setting | 245 | | |
| | 641666 3624.99MHz | 0 | 17.09 | 17.02 | 16.94 |
| | | 1 | 16.67 | 16.66 | 16.60 |
| | | Total Power | 19.90 | 19.85 | 19.78 |
| | | E.I.R.P. | 28.21 | 28.16 | 28.09 |
| | | Power Setting | 245 | | |
| | 645666 3684.99MHz | 0 | 17.03 | 16.96 | 16.85 |
| | | 1 | 16.85 | 16.82 | 16.75 |
| | | Total Power | 19.95 | 19.90 | 19.81 |
| | | E.I.R.P. | 28.26 | 28.21 | 28.12 |
| | | Power Setting | 245 | | |

*EIRP (dBm/10MHz) = Conducted Output Power (dBm/10MHz) + Directional Gain (dBi).

*Directional Gain (dBi) = $10 \log[(10^{G1/20} + 10^{G2/20} + \dots + 10^{GN/20})^2/2] = 10 \log[(10^{4.79/20} + 10^{5.79/20})^2/2] = 8.31 \text{ dBi}$



| NR Band 48_Per 10M (dBm) | | | | | |
|--------------------------|----------------------|---------------|-------|-------|--------|
| BW | Channel | Chain | QPSK | 64QAM | 256QAM |
| 20 MHz | 637334 3560.01MHz | 0 | 17.84 | 17.78 | 17.72 |
| | | 1 | 18.26 | 18.21 | 18.00 |
| | | Total Power | 21.07 | 21.01 | 20.87 |
| | | E.I.R.P. | 29.38 | 29.32 | 29.18 |
| | | Power Setting | 215 | | |
| | 641666 3624.99MHz | 0 | 17.54 | 17.48 | 14.41 |
| | | 1 | 18.01 | 17.95 | 17.88 |
| | | Total Power | 20.79 | 20.73 | 19.49 |
| | | E.I.R.P. | 29.10 | 29.04 | 27.80 |
| | | Power Setting | 225 | | |
| | 646000 3690MHz | 0 | 18.51 | 18.48 | 18.43 |
| | | 1 | 18.47 | 18.44 | 18.36 |
| | | Total Power | 21.50 | 21.47 | 21.41 |
| | | E.I.R.P. | 29.81 | 29.78 | 29.72 |
| | | Power Setting | 235 | | |
| BW | Channel | Chain | QPSK | 64QAM | 256QAM |
| 10 MHz | 637000 3555MHz | 0 | 16.22 | 16.15 | 16.11 |
| | | 1 | 17.15 | 17.09 | 17.04 |
| | | Total Power | 19.72 | 19.66 | 19.61 |
| | | E.I.R.P. | 28.03 | 27.97 | 27.92 |
| | | Power Setting | 180 | | |
| | 641666 3624.99MHz | 0 | 16.53 | 16.48 | 16.42 |
| | | 1 | 17.06 | 17.04 | 17.00 |
| | | Total Power | 19.81 | 19.78 | 19.73 |
| | | E.I.R.P. | 28.12 | 28.09 | 28.04 |
| | | Power Setting | 190 | | |
| | 646332 3694.98MHz | 0 | 16.62 | 16.55 | 16.53 |
| | | 1 | 17.10 | 17.06 | 17.01 |
| | | Total Power | 19.88 | 19.82 | 19.79 |
| | | E.I.R.P. | 28.19 | 28.13 | 28.10 |
| | | Power Setting | 195 | | |

*EIRP (dBm/10MHz) = Conducted Output Power (dBm/10MHz) + Directional Gain (dBi).

*Directional Gain (dBi) = $10 \log[(10^{G1/20} + 10^{G2/20} + \dots + 10^{GN/20})^2/2] = 10 \log[(10^{4.79/20} + 10^{5.79/20})^2/2] = 8.31 \text{ dBi}$

Spectrum Plot of Worst Value

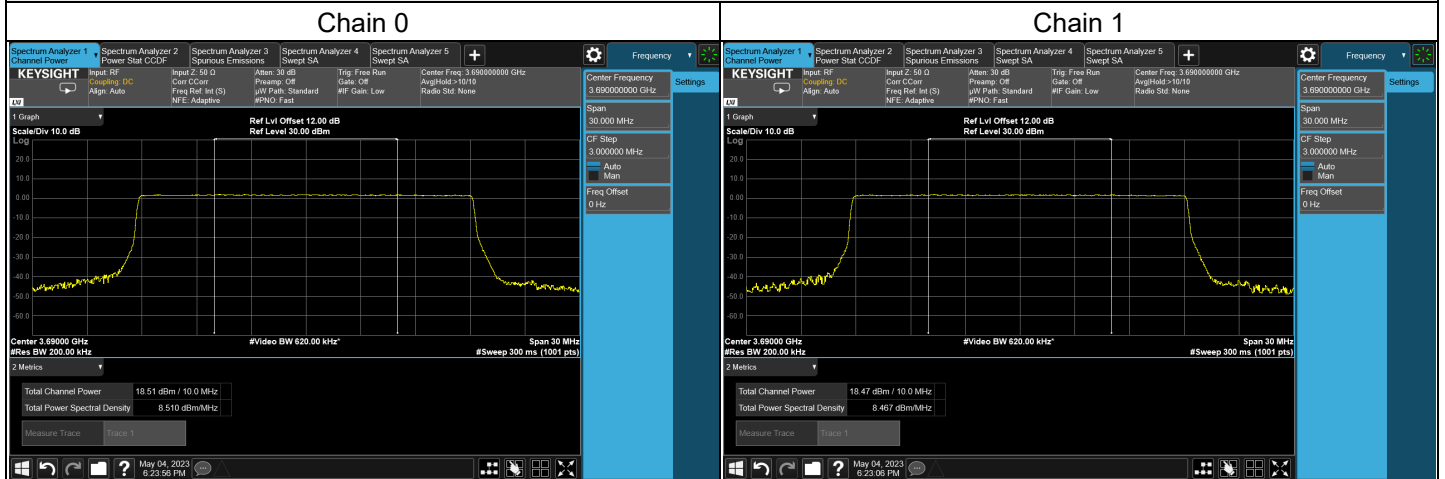

Full Power

| NR Band 48_Full power (dBm/40MHz) | | | | | |
|-----------------------------------|----------------------|---------------|-------|-------|--------|
| BW | Channel | Chain | QPSK | 64QAM | 256QAM |
| 40 MHz | 638000 3570MHz | 0 | 20.50 | 20.46 | 20.44 |
| | | 1 | 21.54 | 21.50 | 21.47 |
| | | Total Power | 24.06 | 24.02 | 24.00 |
| | | E.I.R.P. | 32.37 | 32.33 | 32.31 |
| | | Power Setting | 225 | | |
| | 641666 3624.99MHz | 0 | 19.61 | 19.60 | 19.53 |
| | | 1 | 19.78 | 19.65 | 19.62 |
| | | Total Power | 22.71 | 22.64 | 22.59 |
| | | E.I.R.P. | 31.02 | 30.95 | 30.90 |
| | | Power Setting | 245 | | |
| | 645332 3679.98MHz | 0 | 21.09 | 21.02 | 21.00 |
| | | 1 | 21.36 | 21.26 | 21.17 |
| | | Total Power | 24.24 | 24.15 | 24.10 |
| | | E.I.R.P. | 32.55 | 32.46 | 32.41 |
| | | Power Setting | 245 | | |

*EIRP (dBm/40MHz) = Conducted Output Power (dBm/40MHz) + Directional Gain (dBi).

*Directional Gain (dBi) = $10 \log[(10^{G1/20} + 10^{G2/20} + \dots + 10^{GN/20})^2/2] = 10 \log[(10^{4.79/20} + 10^{5.79/20})^2/2] = 8.31 \text{ dBi}$

| NR Band 48_Full power (dBm/30MHz) | | | | | |
|-----------------------------------|----------------------|---------------|-------|-------|--------|
| BW | Channel | Chain | QPSK | 64QAM | 256QAM |
| 30 MHz | 637668 3565.02MHz | 0 | 21.09 | 21.02 | 20.96 |
| | | 1 | 21.55 | 21.50 | 21.45 |
| | | Total Power | 24.34 | 24.28 | 24.22 |
| | | E.I.R.P. | 32.65 | 32.59 | 32.53 |
| | | Power Setting | 245 | | |
| | 641666 3624.99MHz | 0 | 21.49 | 21.43 | 21.37 |
| | | 1 | 21.24 | 21.20 | 21.13 |
| | | Total Power | 24.38 | 24.33 | 24.26 |
| | | E.I.R.P. | 32.69 | 32.64 | 32.57 |
| | | Power Setting | 245 | | |
| | 645666 3684.99MHz | 0 | 21.63 | 21.55 | 21.49 |
| | | 1 | 21.43 | 21.40 | 21.37 |
| | | Total Power | 24.54 | 24.49 | 24.44 |
| | | E.I.R.P. | 32.85 | 32.80 | 32.75 |
| | | Power Setting | 245 | | |

*EIRP (dBm/30MHz) = Conducted Output Power (dBm/30MHz) + Directional Gain (dBi).

*Directional Gain (dBi) = $10 \log[(10^{G1/20} + 10^{G2/20} + \dots + 10^{GN/20})^2/2] = 10 \log[(10^{4.79/20} + 10^{5.79/20})^2/2] = 8.31 \text{ dBi}$

| NR Band 48_Full power (dBm/20MHz) | | | | | |
|-----------------------------------|----------------------|---------------|-------|-------|--------|
| NR Band 48_Full power | | | | | |
| BW | Channel | Chain | QPSK | 64QAM | 256QAM |
| 20 MHz | 637334 3560.01MHz | 0 | 20.46 | 20.40 | 20.34 |
| | | 1 | 20.88 | 20.81 | 20.73 |
| | | Total Power | 23.69 | 23.62 | 23.55 |
| | | E.I.R.P. | 32.00 | 31.93 | 31.86 |
| | | Power Setting | 215 | | |
| | 641666 3624.99MHz | 0 | 20.28 | 20.22 | 20.16 |
| | | 1 | 20.79 | 20.73 | 20.68 |
| | | Total Power | 23.55 | 23.49 | 23.44 |
| | | E.I.R.P. | 31.86 | 31.80 | 31.75 |
| | | Power Setting | 225 | | |
| | 646000 3690MHz | 0 | 21.17 | 21.13 | 21.06 |
| | | 1 | 21.13 | 21.11 | 21.03 |
| | | Total Power | 24.16 | 24.13 | 24.06 |
| | | E.I.R.P. | 32.47 | 32.44 | 32.37 |
| | | Power Setting | 235 | | |

*EIRP (dBm/20MHz) = Conducted Output Power (dBm/20MHz) + Directional Gain (dBi).

*Directional Gain (dBi) = $10 \log[(10^{G1/20} + 10^{G2/20} + \dots + 10^{GN/20})^2/2] = 10 \log[(10^{4.79/20} + 10^{5.79/20})^2/2] = 8.31 \text{ dBi}$

| NR Band 48_Full power (dBm/10MHz) | | | | | |
|-----------------------------------|----------------------|---------------|-------|-------|--------|
| BW | Channel | Chain | QPSK | 64QAM | 256QAM |
| 10 MHz | 637000 3555MHz | 0 | 16.22 | 16.15 | 16.11 |
| | | 1 | 17.15 | 17.09 | 17.04 |
| | | Total Power | 19.72 | 19.66 | 19.61 |
| | | E.I.R.P. | 28.03 | 27.97 | 27.92 |
| | | Power Setting | 180 | | |
| | 641666 3624.99MHz | 0 | 16.53 | 16.48 | 16.42 |
| | | 1 | 17.06 | 17.04 | 17.00 |
| | | Total Power | 19.81 | 19.78 | 19.73 |
| | | E.I.R.P. | 28.12 | 28.09 | 28.04 |
| | | Power Setting | 190 | | |
| | 646332 3694.98MHz | 0 | 16.62 | 16.55 | 16.53 |
| | | 1 | 17.10 | 17.06 | 17.01 |
| | | Total Power | 19.88 | 19.82 | 19.79 |
| | | E.I.R.P. | 28.19 | 28.13 | 28.10 |
| | | Power Setting | 195 | | |

*EIRP (dBm/10MHz) = Conducted Output Power (dBm/10MHz) + Directional Gain (dBi).

*Directional Gain (dBi) = $10 \log[(10^{G1/20} + 10^{G2/20} + \dots + 10^{GN/20})^2/2] = 10 \log[(10^{4.79/20} + 10^{5.79/20})^2/2] = 8.31 \text{ dBi}$

Spectrum Plot of Worst Value

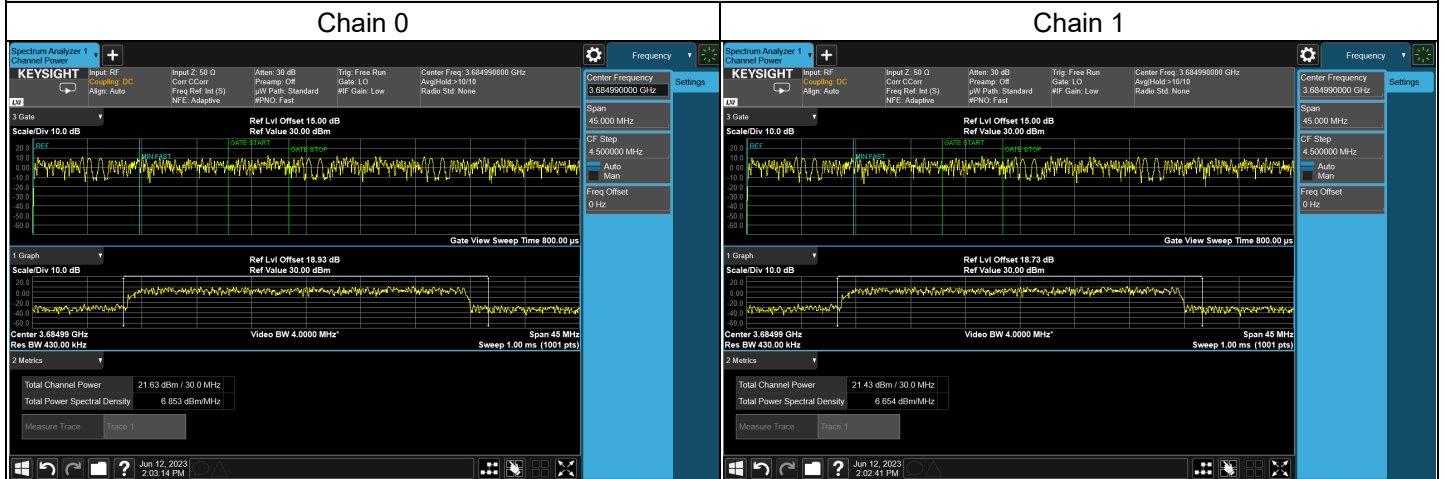

7.2 Modulation Characteristics

| | | | | | |
|--------------|---------------|---------------------------|--------------|------------|------------|
| Input Power: | 120 Vac, 60Hz | Environmental Conditions: | 22°C, 70% RH | Tested By: | James Yang |
|--------------|---------------|---------------------------|--------------|------------|------------|

NR n48 SCS 15 kHz, Channel Bandwidth: 40 MHz

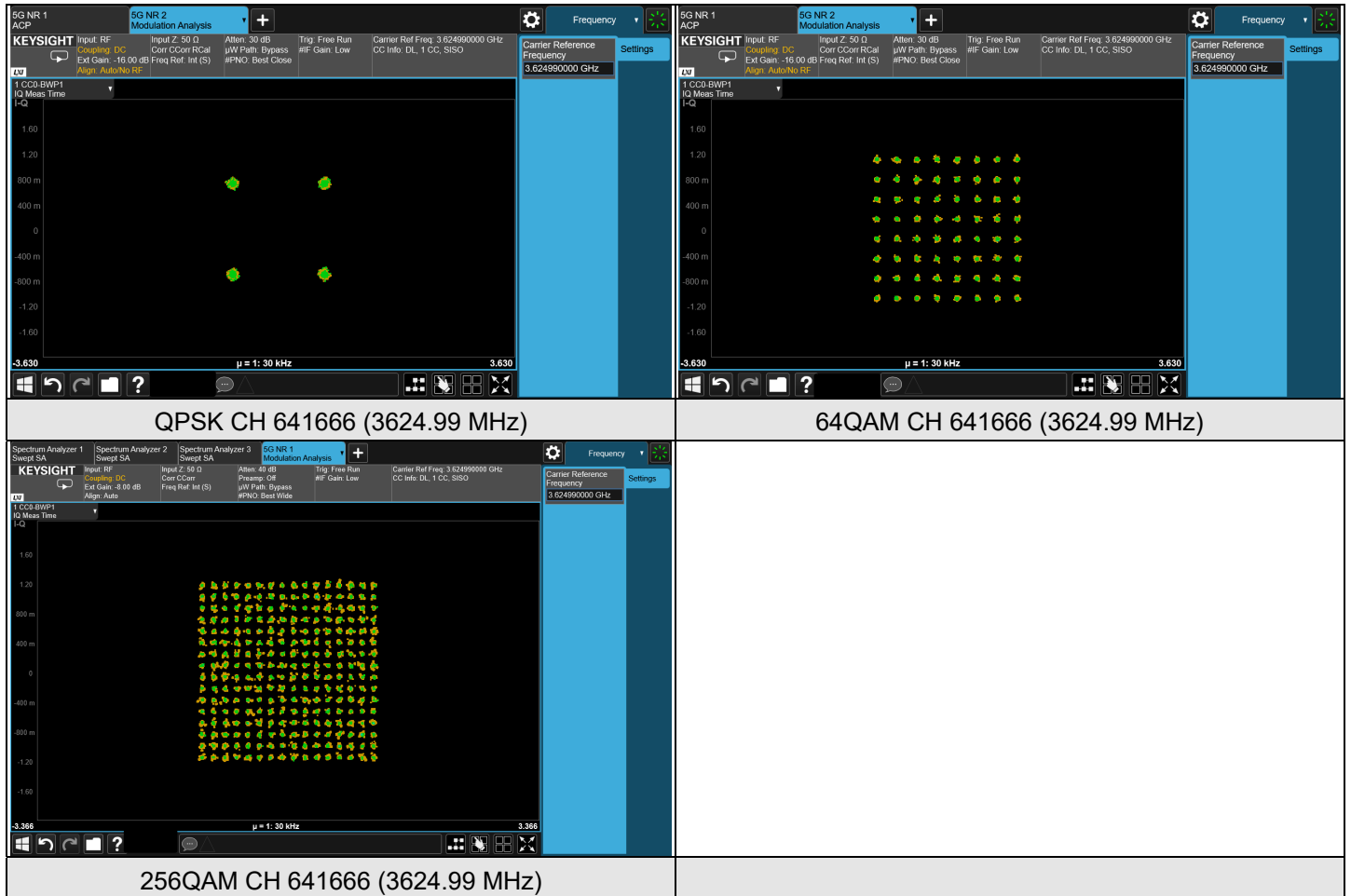

7.3 Maximum Power Spectral Density

| | | | | | |
|--------------|---------------|---------------------------|--------------|------------|------------|
| Input Power: | 120 Vac, 60Hz | Environmental Conditions: | 22°C, 70% RH | Tested By: | James Yang |
|--------------|---------------|---------------------------|--------------|------------|------------|

Power Spectral Density (dBm/MHz)

| NR Band 48 | | | |
|------------|----------------------|----------|-------|
| BW | Channel | Chain | QPSK |
| 40 MHz | 638000 3570MHz | 0 | 5.42 |
| | | 1 | 6.39 |
| | | Total | 8.94 |
| | | E.I.R.P. | 17.25 |
| | 641666 3624.99MHz | 0 | 4.97 |
| | | 1 | 5.05 |
| | | Total | 8.02 |
| | | E.I.R.P. | 16.33 |
| | 645332 3679.98MHz | 0 | 6.00 |
| | | 1 | 5.82 |
| | | Total | 8.92 |
| | | E.I.R.P. | 17.23 |
| NR Band 48 | | | |
| BW | Channel | Chain | QPSK |
| 30 MHz | 637668 3565.02MHz | 0 | 6.99 |
| | | 1 | 7.48 |
| | | Total | 10.25 |
| | | E.I.R.P. | 18.56 |
| | 641666 3624.99MHz | 0 | 7.06 |
| | | 1 | 7.03 |
| | | Total | 10.06 |
| | | E.I.R.P. | 18.37 |
| | 645666 3684.99MHz | 0 | 7.13 |
| | | 1 | 7.22 |
| | | Total | 10.19 |
| | | E.I.R.P. | 18.50 |

*EIRP (dBm/MHz) = Conducted (dBm/MHz) + Directional Gain (dBi).

*Directional Gain (dBi) = $10 \log[(10^{G1/20} + 10^{G2/20} + \dots + 10^{GN/20})^2/2] = 10 \log[(10^{4.79/20} + 10^{5.79/20})^2/2] = 8.31 \text{ dBi}$

| NR Band 48 | | | |
|------------|----------------------|----------|-------|
| BW | Channel | Chain | QPSK |
| 20 MHz | 637334 3560.01MHz | 0 | 8.48 |
| | | 1 | 8.39 |
| | | Total | 11.45 |
| | | E.I.R.P. | 19.76 |
| | 641666 3624.99MHz | 0 | 7.90 |
| | | 1 | 8.64 |
| | | Total | 11.30 |
| | | E.I.R.P. | 19.61 |
| | 646000 3690MHz | 0 | 8.72 |
| | | 1 | 8.45 |
| | | Total | 11.60 |
| | | E.I.R.P. | 19.91 |
| NR Band 48 | | | |
| BW | Channel | Chain | QPSK |
| 10 MHz | 637000 3555MHz | 0 | 7.93 |
| | | 1 | 8.53 |
| | | Total | 11.25 |
| | | E.I.R.P. | 19.57 |
| | 641666 3624.99MHz | 0 | 7.94 |
| | | 1 | 8.49 |
| | | Total | 11.23 |
| | | E.I.R.P. | 19.55 |
| | 646332 3694.98MHz | 0 | 7.80 |
| | | 1 | 8.58 |
| | | Total | 11.22 |
| | | E.I.R.P. | 19.53 |

*EIRP (dBm/MHz) = Conducted (dBm/MHz) + Directional Gain (dBi).

*Directional Gain (dBi) = $10 \log[(10^{G1/20} + 10^{G2/20} + \dots + 10^{GN/20})^2/2] = 10 \log[(10^{4.79/20} + 10^{5.79/20})^2/2] = 8.31 \text{ dBi}$

7.4 Peak to Average Ratio

| | | | | | |
|--------------|---------------|---------------------------|--------------|------------|------------|
| Input Power: | 120 Vac, 60Hz | Environmental Conditions: | 22°C, 70% RH | Tested By: | James Yang |
|--------------|---------------|---------------------------|--------------|------------|------------|

NR n48 SCS 30 kHz, Channel Bandwidth: 10 MHz

| Channel | Frequency (MHz) | Peak to Average Ratio (dB) | | | | | | Limit |
|---------|-----------------|----------------------------|-------|--------|---------|-------|--------|-------|
| | | Chain 0 | | | Chain 1 | | | |
| | | QPSK | 64QAM | 256QAM | QPSK | 64QAM | 256QAM | |
| 637000 | 3555 | 8.53 | 8.90 | 8.87 | 8.90 | 8.88 | 8.72 | 13.00 |
| 641666 | 3624.99 | 8.56 | 8.77 | 8.54 | 9.24 | 8.74 | 8.72 | |
| 646333 | 3694.98 | 8.62 | 8.66 | 8.81 | 8.97 | 8.44 | 8.61 | |

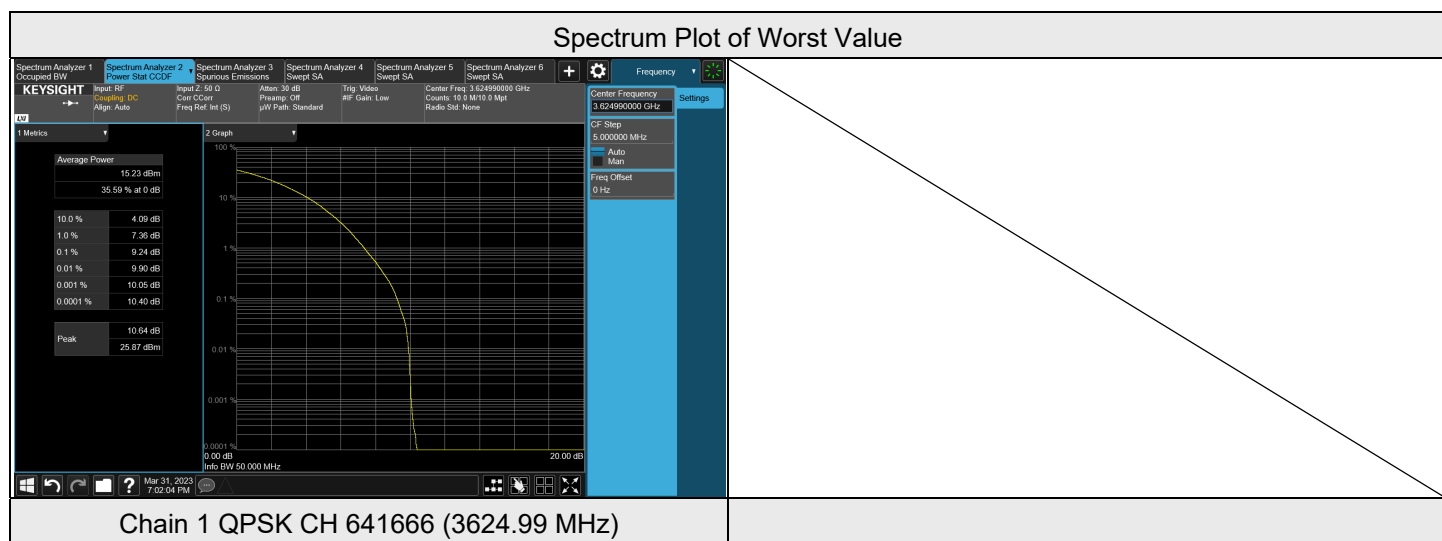



NR n48 SCS 30 kHz, Channel Bandwidth: 20 MHz

| Channel | Frequency (MHz) | Peak to Average Ratio (dB) | | | | | | Limit |
|---------|-----------------|----------------------------|-------|--------|---------|-------|--------|-------|
| | | Chain 0 | | | Chain 1 | | | |
| | | QPSK | 64QAM | 256QAM | QPSK | 64QAM | 256QAM | |
| 637334 | 3560.01 | 8.71 | 8.81 | 8.86 | 8.81 | 8.87 | 9.09 | 13.00 |
| 641666 | 3624.99 | 8.78 | 8.57 | 8.77 | 8.75 | 8.62 | 8.67 | |
| 646000 | 3690 | 8.92 | 8.63 | 8.48 | 8.57 | 8.53 | 8.64 | |

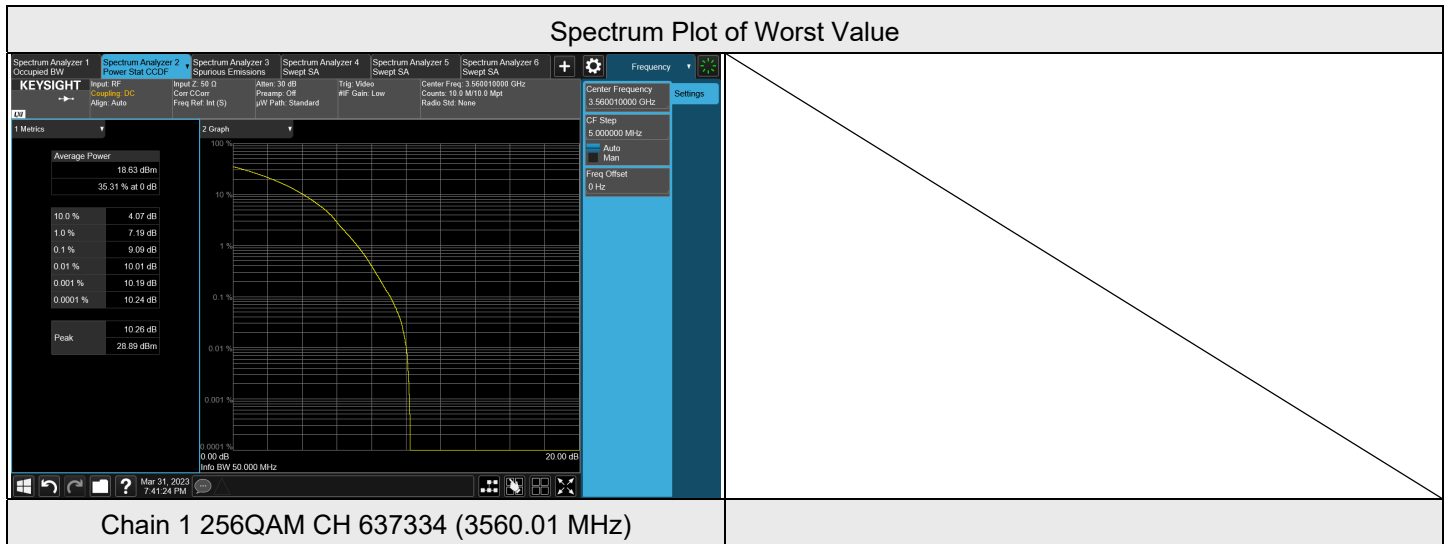

NR n48 SCS 30 kHz, Channel Bandwidth: 30 MHz

| Channel | Frequency (MHz) | Peak to Average Ratio (dB) | | | | | | Limit |
|---------|-----------------|----------------------------|-------|--------|---------|-------|--------|-------|
| | | Chain 0 | | | Chain 1 | | | |
| | | QPSK | 64QAM | 256QAM | QPSK | 64QAM | 256QAM | |
| 637668 | 3565.02 | 8.91 | 8.72 | 8.67 | 8.52 | 8.51 | 8.67 | 13.00 |
| 641666 | 3624.99 | 8.49 | 8.67 | 8.57 | 8.81 | 8.70 | 8.64 | |
| 645666 | 3684.99 | 8.89 | 8.64 | 8.82 | 8.87 | 8.74 | 8.92 | |

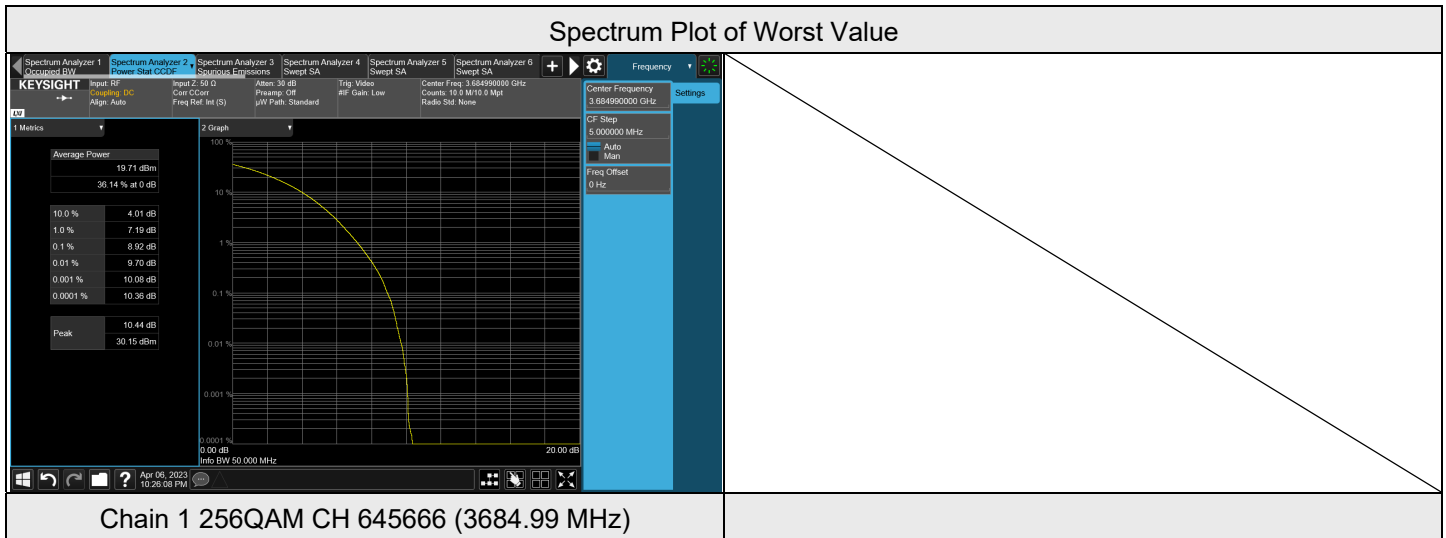

NR n48 SCS 30 kHz, Channel Bandwidth: 40 MHz

| Channel | Frequency (MHz) | Peak to Average Ratio (dB) | | | | | | Limit |
|---------|-----------------|----------------------------|-------|--------|---------|-------|--------|-------|
| | | Chain 0 | | | Chain 1 | | | |
| | | QPSK | 64QAM | 256QAM | QPSK | 64QAM | 256QAM | |
| 638000 | 3570 | 8.54 | 8.70 | 8.62 | 8.71 | 8.85 | 8.74 | 13.00 |
| 641666 | 3624.99 | 8.55 | 8.45 | 8.52 | 8.50 | 8.43 | 8.58 | |
| 645332 | 3679.98 | 8.49 | 8.31 | 8.61 | 8.75 | 8.57 | 8.81 | |

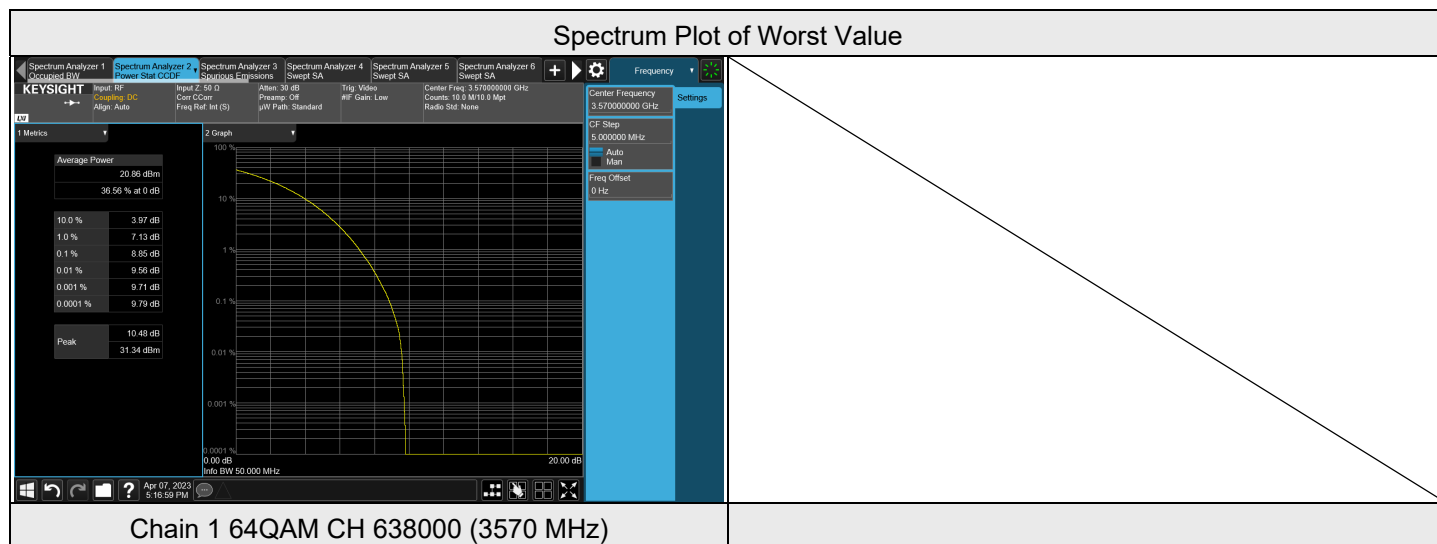

7.5 Bandwidth

| | | | | | |
|--------------|---------------|---------------------------|--------------|------------|------------|
| Input Power: | 120 Vac, 60Hz | Environmental Conditions: | 22°C, 70% RH | Tested By: | James Yang |
|--------------|---------------|---------------------------|--------------|------------|------------|

NR n48 SCS 30 kHz, Channel Bandwidth: 10 MHz

| Channel | Frequency (MHz) | Occupied Bandwidth (MHz) | | | | | |
|---------|-----------------|--------------------------|-------|--------|---------|-------|--------|
| | | Chain 0 | | | Chain 1 | | |
| | | QPSK | 64QAM | 256QAM | QPSK | 64QAM | 256QAM |
| 637000 | 3555 | 8.587 | 8.564 | 8.585 | 8.586 | 8.602 | 8.603 |
| 641666 | 3624.99 | 8.585 | 8.572 | 8.569 | 8.600 | 8.604 | 8.604 |
| 646333 | 3694.98 | 8.590 | 8.576 | 8.570 | 8.588 | 8.576 | 8.570 |

| Channel | Frequency (MHz) | 26 dB Bandwidth (MHz) | | | | | |
|---------|-----------------|-----------------------|-------|--------|---------|-------|--------|
| | | Chain 0 | | | Chain 1 | | |
| | | QPSK | 64QAM | 256QAM | QPSK | 64QAM | 256QAM |
| 637000 | 3555 | 9.53 | 9.44 | 9.52 | 9.68 | 9.50 | 9.50 |
| 641666 | 3624.99 | 9.51 | 9.48 | 9.45 | 9.68 | 9.48 | 9.48 |
| 646333 | 3694.98 | 9.48 | 9.47 | 9.47 | 9.67 | 9.47 | 9.47 |

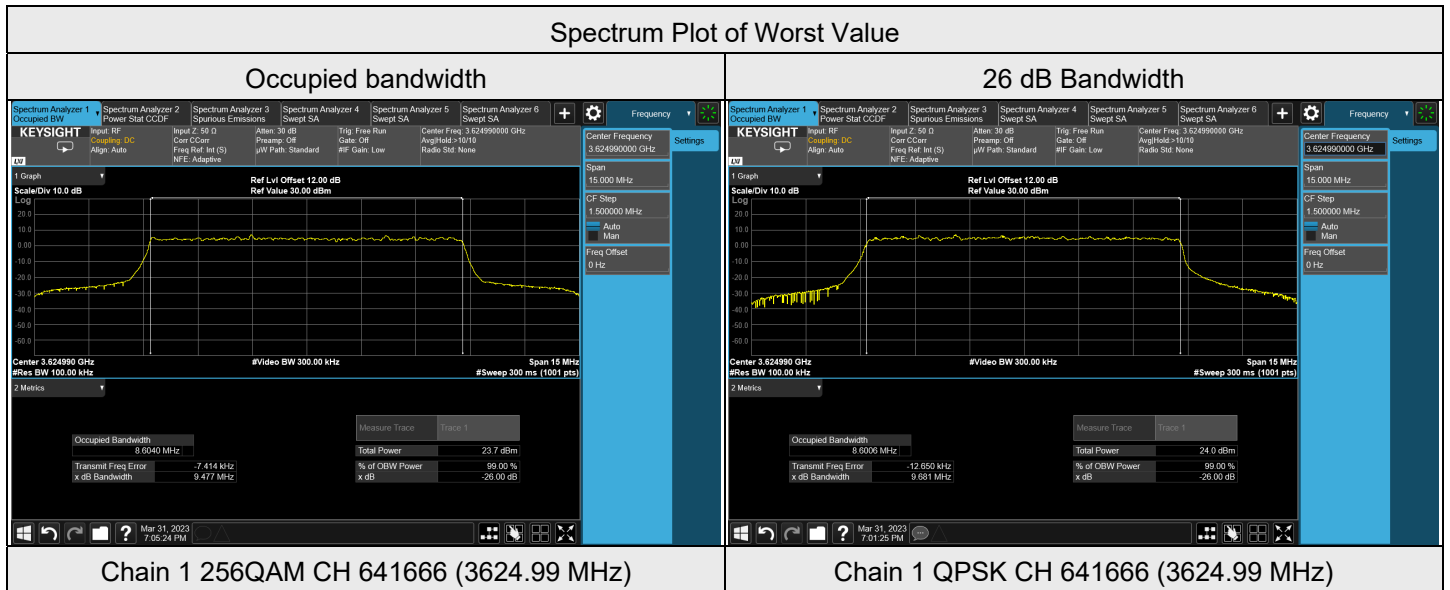



NR n48 SCS 30 kHz, Channel Bandwidth: 20 MHz

| Channel | Frequency (MHz) | Occupied Bandwidth (MHz) | | | | | |
|---------|-----------------|--------------------------|--------|--------|---------|--------|--------|
| | | Chain 0 | | | Chain 1 | | |
| | | QPSK | 64QAM | 256QAM | QPSK | 64QAM | 256QAM |
| 637334 | 3560.01 | 18.206 | 18.194 | 18.187 | 18.189 | 18.251 | 18.252 |
| 641666 | 3624.99 | 18.182 | 18.245 | 18.247 | 18.203 | 18.242 | 18.245 |
| 646000 | 3690 | 18.196 | 18.253 | 18.250 | 18.237 | 18.234 | 18.233 |

| Channel | Frequency (MHz) | 26 dB Bandwidth (MHz) | | | | | |
|---------|-----------------|-----------------------|-------|--------|---------|-------|--------|
| | | Chain 0 | | | Chain 1 | | |
| | | QPSK | 64QAM | 256QAM | QPSK | 64QAM | 256QAM |
| 637334 | 3560.01 | 19.63 | 19.68 | 19.68 | 19.52 | 19.76 | 19.75 |
| 641666 | 3624.99 | 19.73 | 19.70 | 19.72 | 19.67 | 19.82 | 19.83 |
| 646000 | 3690 | 19.67 | 19.79 | 19.77 | 19.86 | 19.78 | 19.75 |

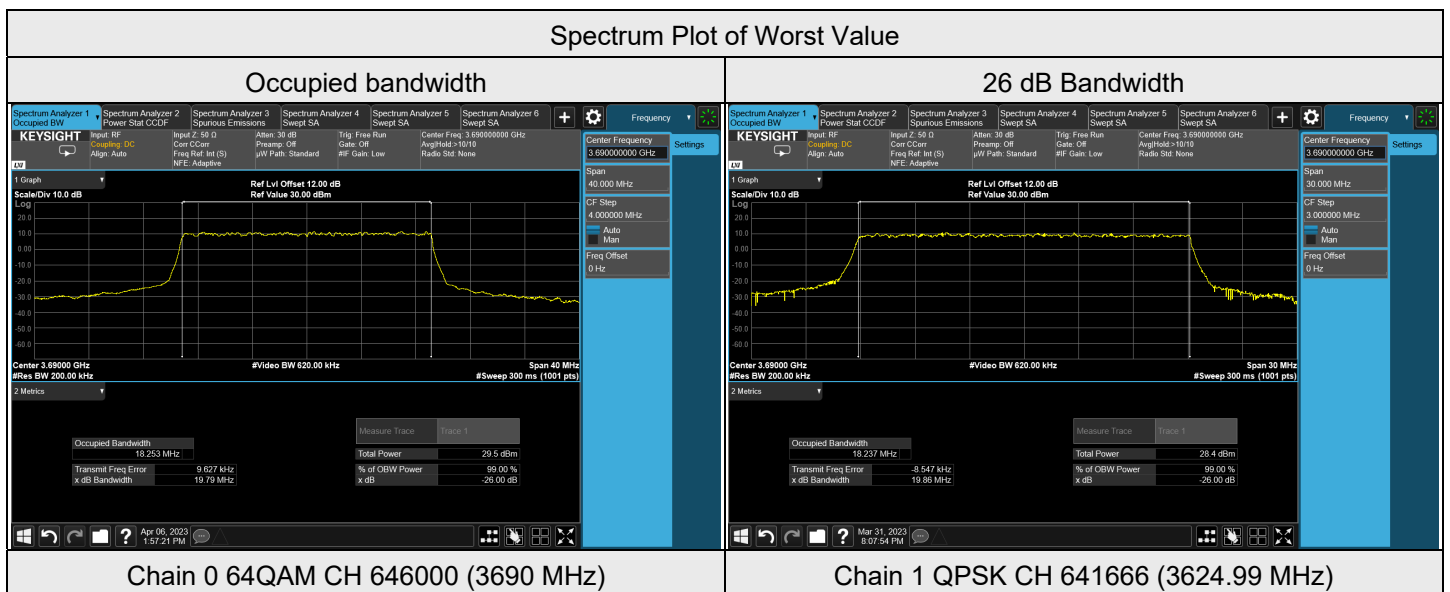



NR n48 SCS 30 kHz, Channel Bandwidth: 30 MHz

| Channel | Frequency (MHz) | Occupied Bandwidth (MHz) | | | | | |
|---------|-----------------|--------------------------|--------|--------|---------|--------|--------|
| | | Chain 0 | | | Chain 1 | | |
| | | QPSK | 64QAM | 256QAM | QPSK | 64QAM | 256QAM |
| 637668 | 3565.02 | 27.820 | 27.823 | 27.824 | 27.883 | 27.892 | 27.876 |
| 641666 | 3624.99 | 27.855 | 27.841 | 27.842 | 27.879 | 27.887 | 27.892 |
| 645666 | 3684.99 | 27.843 | 27.826 | 27.828 | 27.879 | 27.883 | 27.876 |

| Channel | Frequency (MHz) | 26 dB Bandwidth (MHz) | | | | | |
|---------|-----------------|-----------------------|-------|--------|---------|-------|--------|
| | | Chain 0 | | | Chain 1 | | |
| | | QPSK | 64QAM | 256QAM | QPSK | 64QAM | 256QAM |
| 637668 | 3565.02 | 29.66 | 29.48 | 29.51 | 29.78 | 29.81 | 29.75 |
| 641666 | 3624.99 | 29.78 | 29.65 | 29.63 | 29.62 | 29.71 | 29.72 |
| 645666 | 3684.99 | 29.66 | 29.60 | 29.59 | 29.66 | 29.68 | 29.68 |

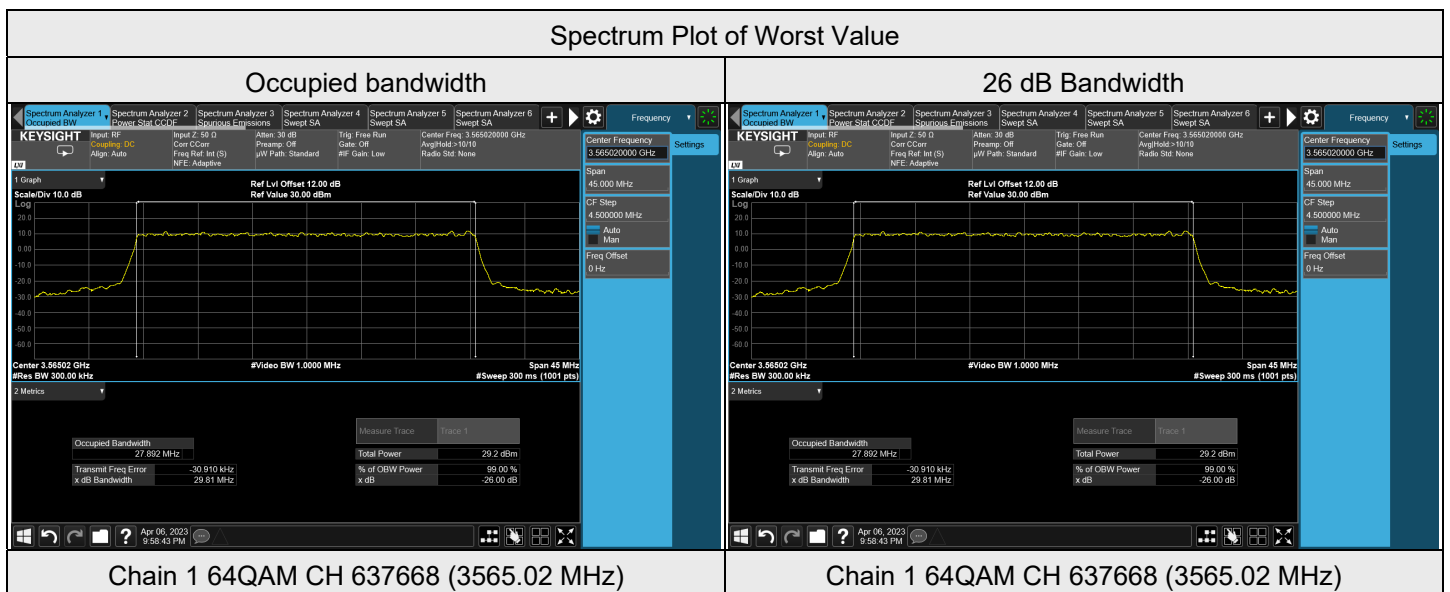



NR n48 SCS 30 kHz, Channel Bandwidth: 40 MHz

| Channel | Frequency (MHz) | Occupied Bandwidth (MHz) | | | | | |
|---------|-----------------|--------------------------|--------|--------|---------|--------|--------|
| | | Chain 0 | | | Chain 1 | | |
| | | QPSK | 64QAM | 256QAM | QPSK | 64QAM | 256QAM |
| 638000 | 3570 | 37.848 | 37.846 | 37.848 | 37.914 | 37.904 | 37.909 |
| 641666 | 3624.99 | 37.852 | 37.851 | 37.852 | 37.901 | 37.905 | 37.902 |
| 645332 | 3679.98 | 37.863 | 37.862 | 37.858 | 37.904 | 37.909 | 37.916 |

| Channel | Frequency (MHz) | 26 dB Bandwidth (MHz) | | | | | |
|---------|-----------------|-----------------------|-------|--------|---------|-------|--------|
| | | Chain 0 | | | Chain 1 | | |
| | | QPSK | 64QAM | 256QAM | QPSK | 64QAM | 256QAM |
| 638000 | 3570 | 39.97 | 39.98 | 39.96 | 40.37 | 40.40 | 40.41 |
| 641666 | 3624.99 | 39.86 | 39.87 | 39.87 | 40.46 | 40.44 | 40.48 |
| 645332 | 3679.98 | 39.85 | 39.80 | 39.81 | 40.39 | 40.41 | 40.38 |

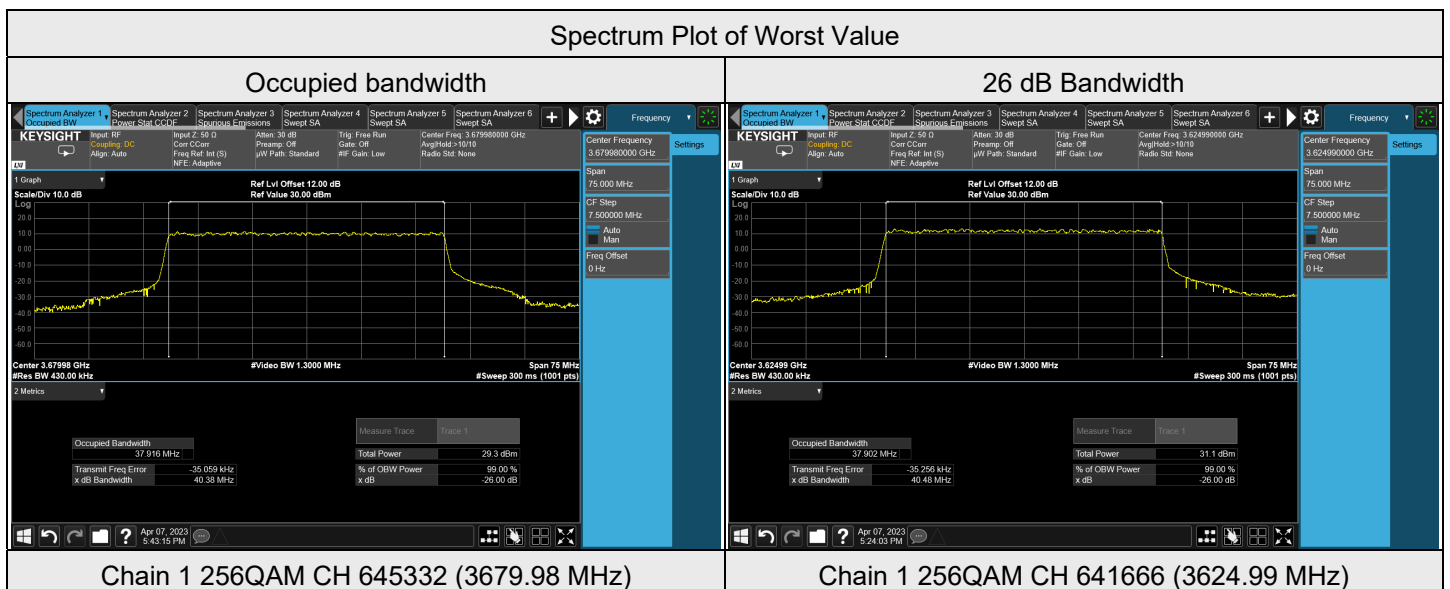



7.6 Conducted Spurious Emissions

| | | | | | |
|--------------|---------------|---------------------------|--------------|------------|------------|
| Input Power: | 120 Vac, 60Hz | Environmental Conditions: | 22°C, 70% RH | Tested By: | James Yang |
|--------------|---------------|---------------------------|--------------|------------|------------|

NR n48 SCS 30 kHz, Channel Bandwidth: 10 MHz

Chain 0

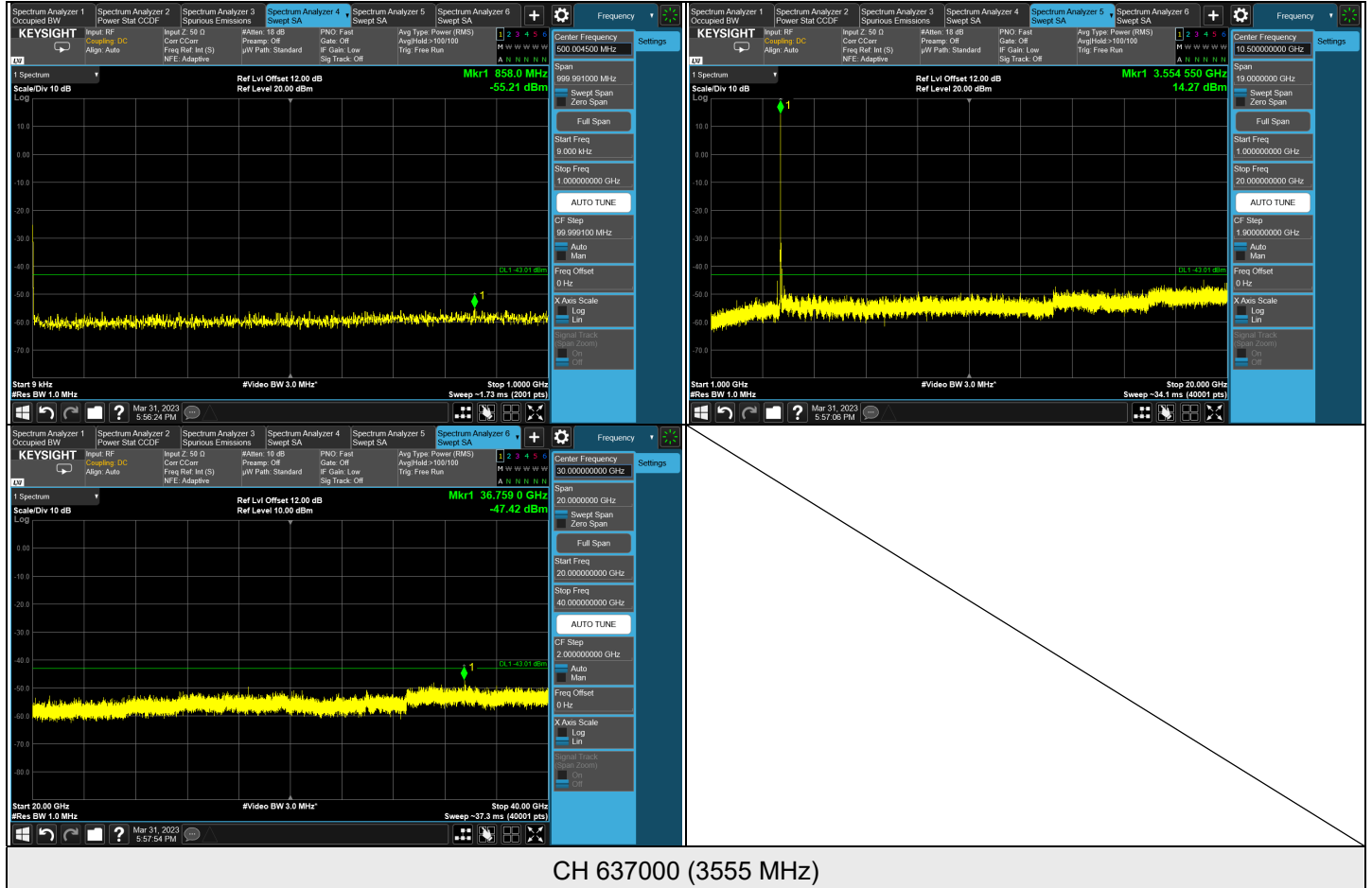

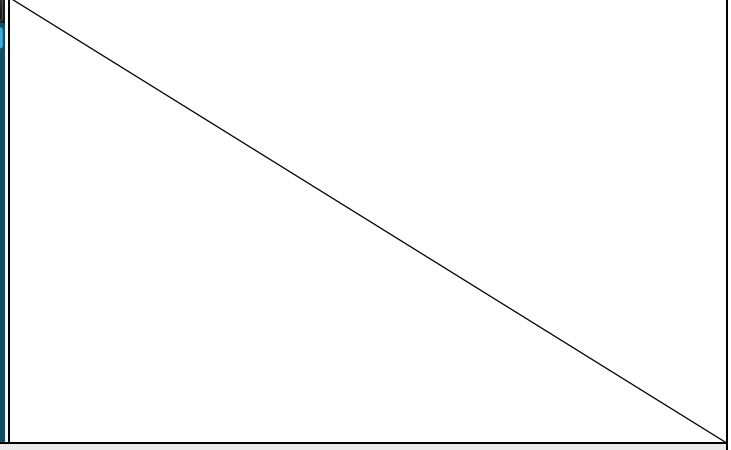
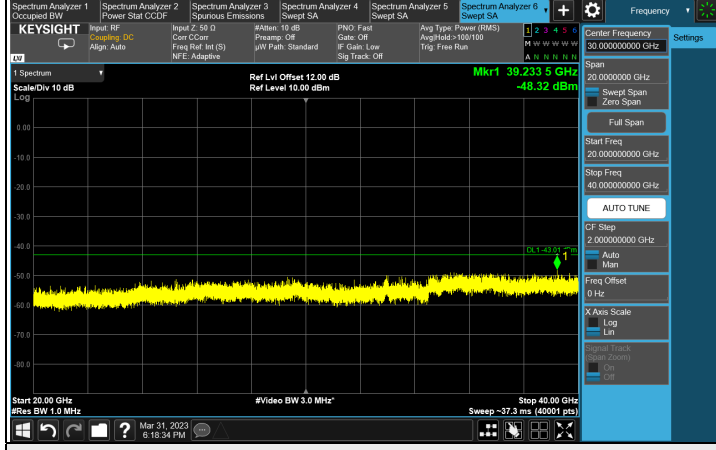
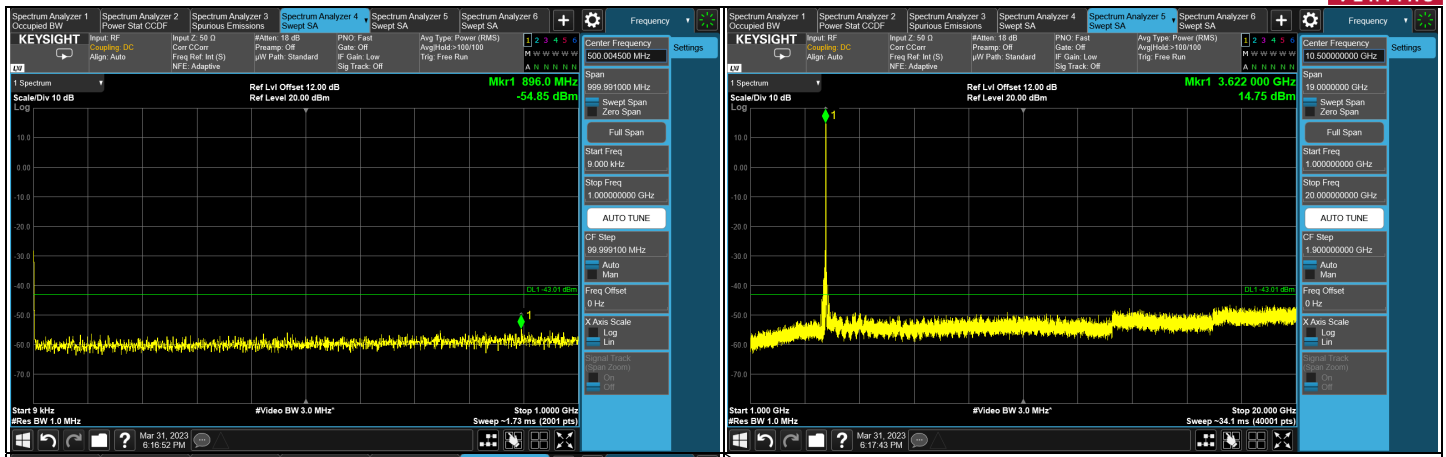

CH 641666 (3624.99 MHz)

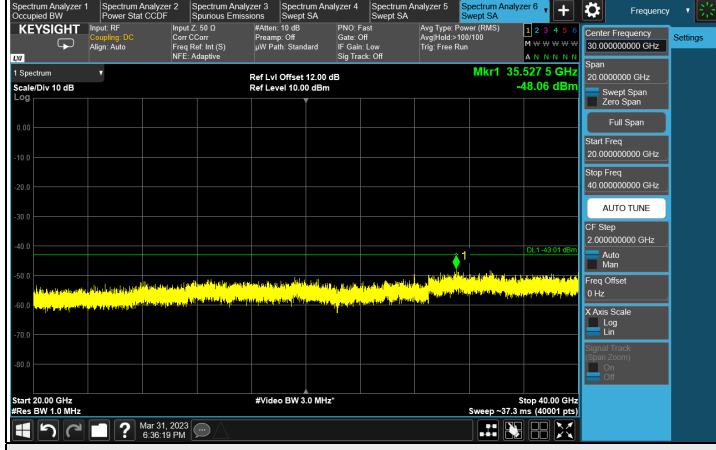
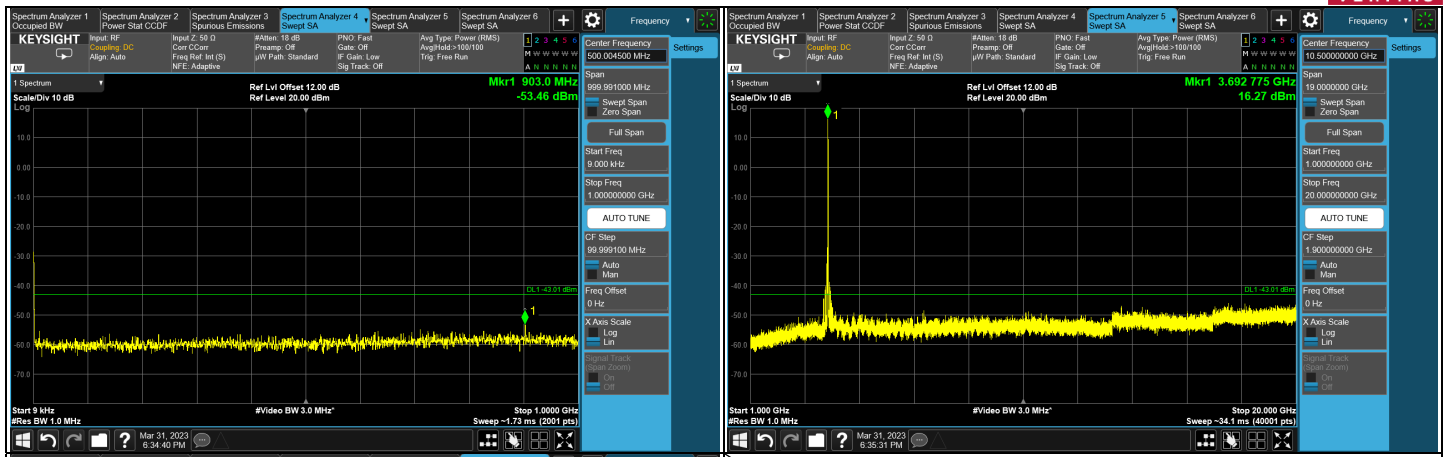

CH 646333 (3694.98 MHz)

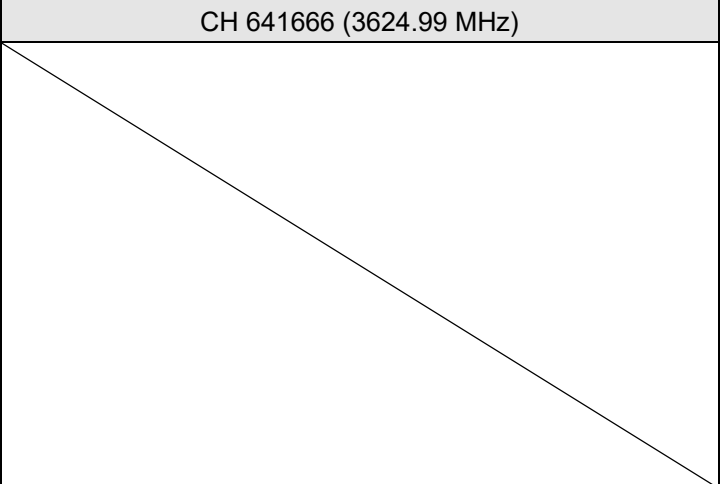
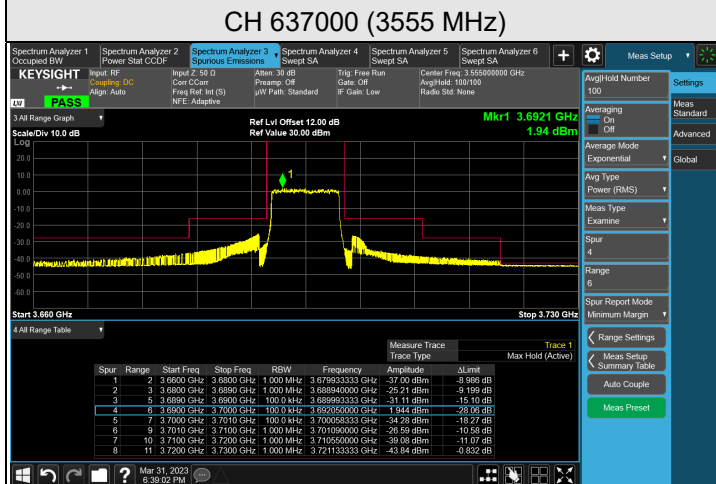
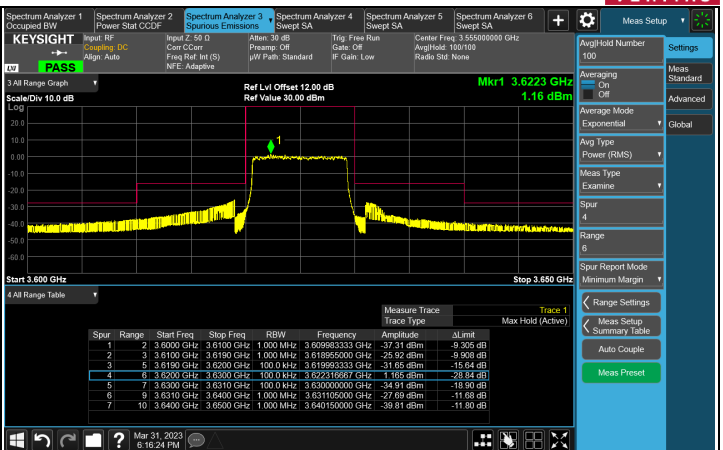
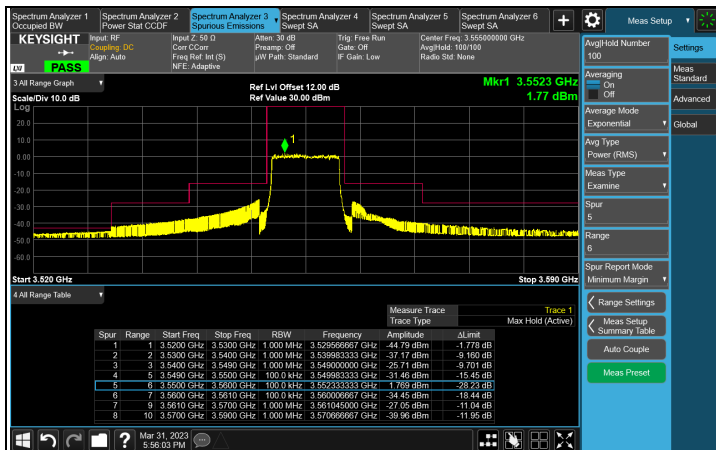

CH 646333 (3694.98 MHz)



Chain 1

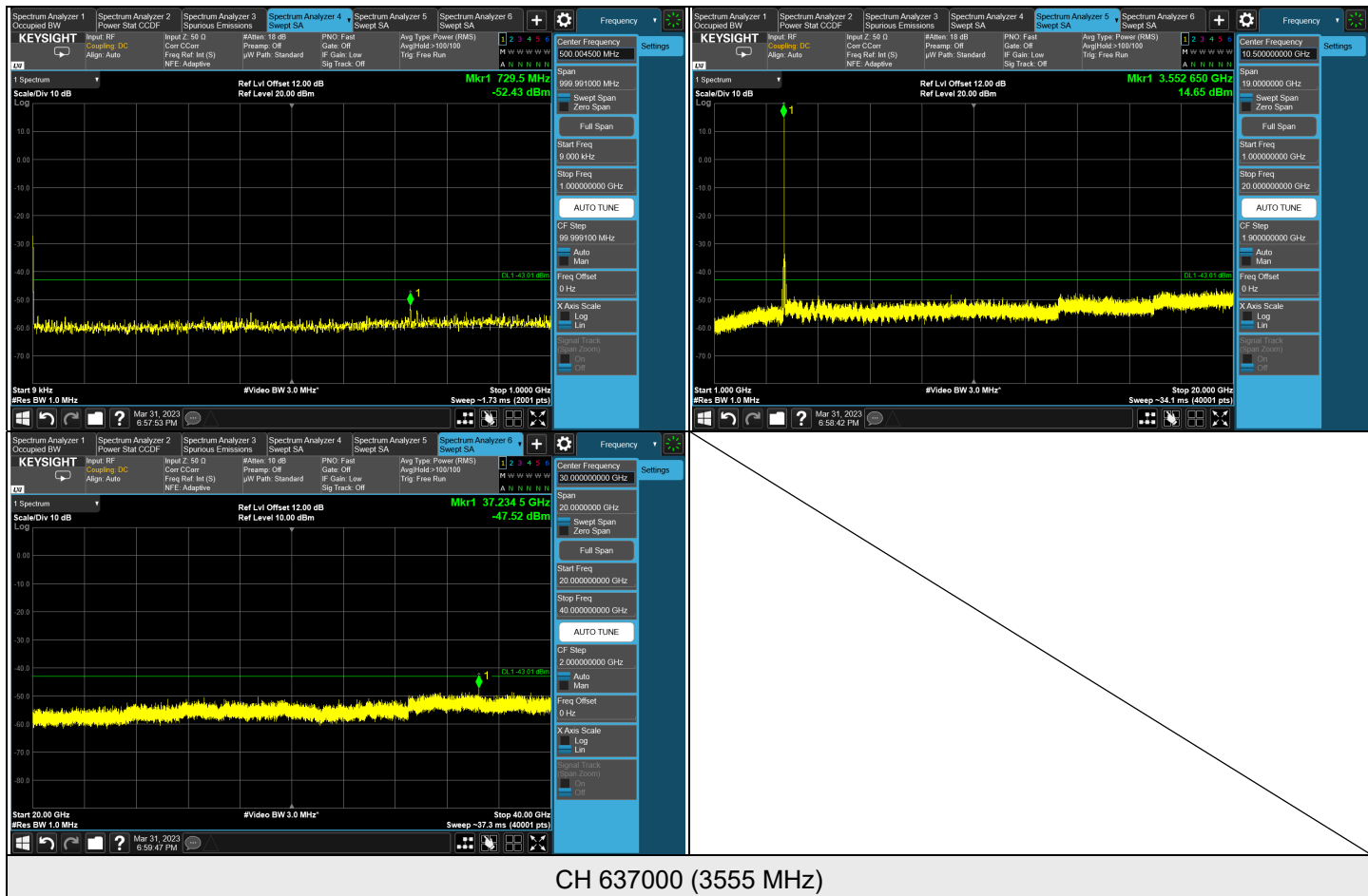

CH 637000 (3555 MHz)

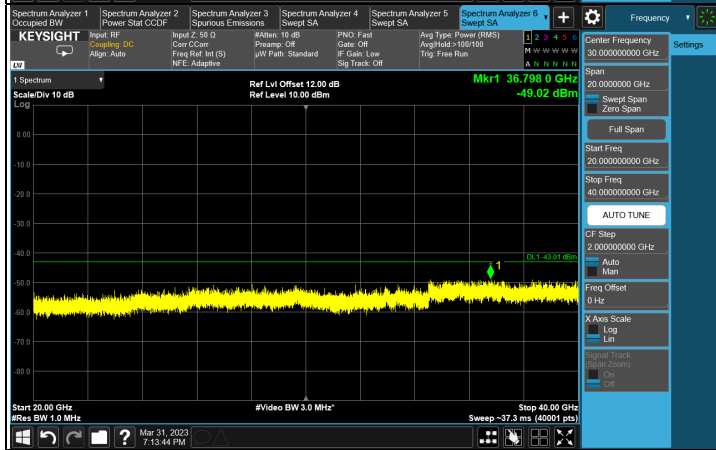
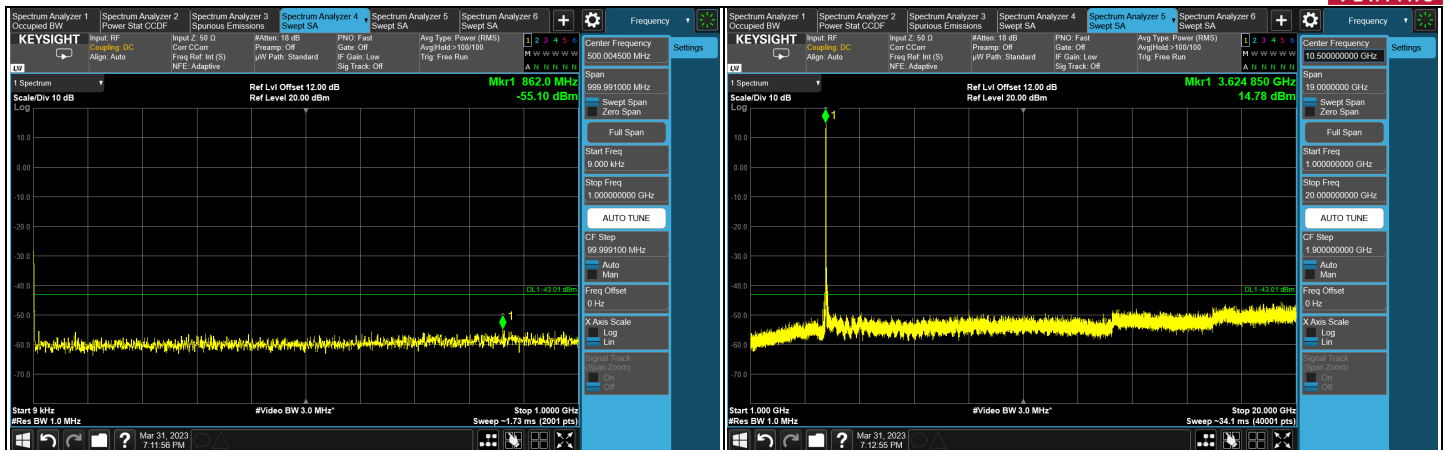

CH 641666 (3624.99 MHz)

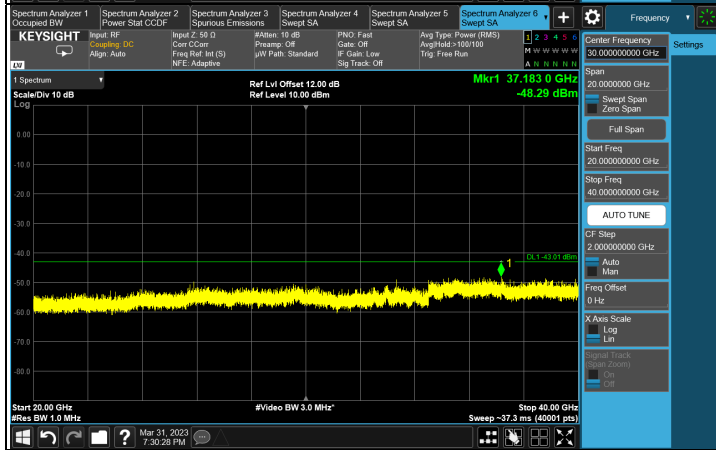
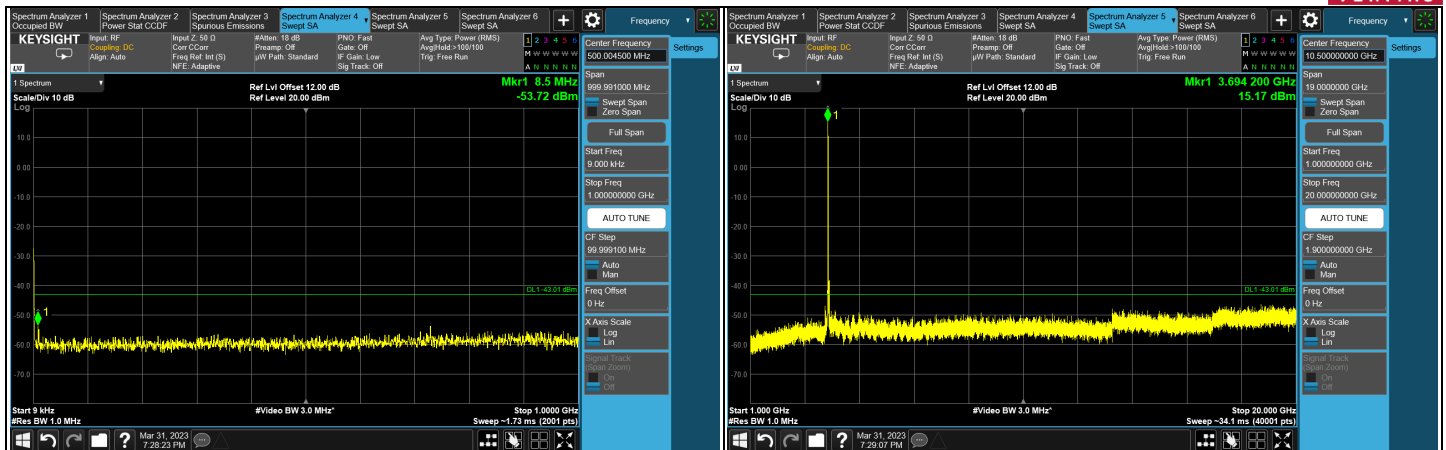

CH 646333 (3694.98 MHz)

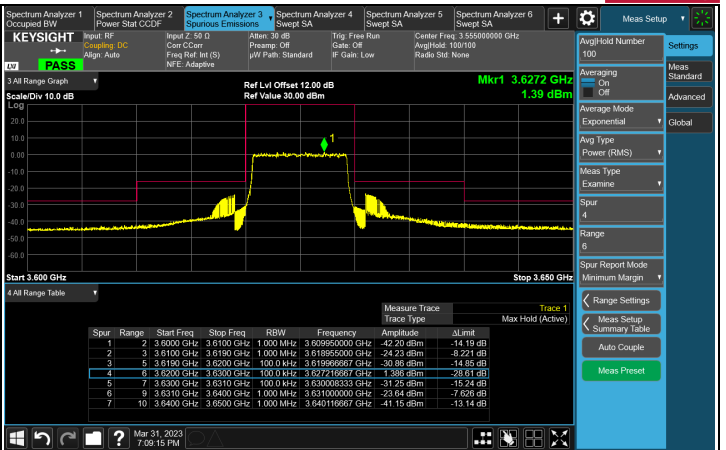
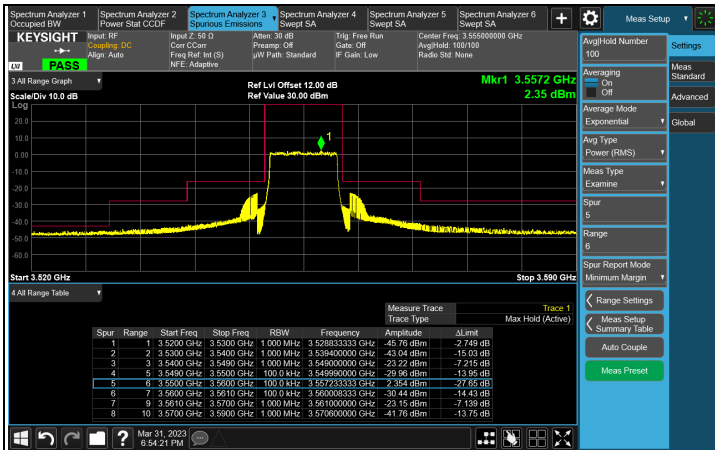

CH 637000 (3557 MHz)

CH 641666 (3624.99 MHz)

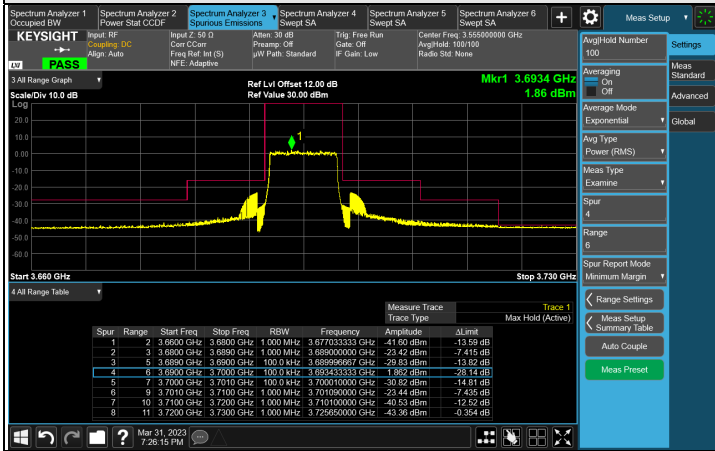

CH 646333 (3694.98 MHz)