

RF Test Report

Applicant : Askey Computer Corp

Product Type : Remote Worker Kit

Trade Name : Askey, Unisys

Model Number : 2326RWK

Applicable Standard : FCC 47 CFR PART 15 SUBPART C
ANSI C63.10:2013

Received Date : Oct. 13, 2021

Test Period : Oct. 15 ~ Oct. 30, 2021

Issued Date : Jan. 06, 2022

Issued by

A Test Lab Techno Corp.
No. 140-1, Changan Street, Bade District,
Taoyuan City 33465, Taiwan (R.O.C.)
Tel : +886-3-2710188 / Fax : +886-3-2710190



Taiwan Accreditation Foundation accreditation number: 1330

Frequency Range : 9 kHz to 40 GHz

Test Firm MRA designation number: TW0010

Note:

- 1.The test results are valid only for samples provided by customers and under the test conditions described in this report.
- 2.This report shall not be reproduced except in full, without the written approval of A Test Lab Technology Corporation.
- 3.The relevant information is provided by customers in this test report. According to the correctness, appropriateness or completeness of the information provided by the customer, if there is any doubt or error in the information which affects the validity of the test results, the laboratory does not take the responsibility.

Revision History

Rev.	Issued Date	Revisions	Revised By
00	Dec. 24, 2021	Initial Issue	Emma Chao
01	Jan. 06, 2022	Update Trade Name (P.1/ P.3/ P.7)	Emma Chao

Verification of Compliance

Applicant : Askey Computer Corp
Product Type : Remote Worker Kit
Trade Name : Askey, Unisys
Model Number : 2326RWK
FCC ID : H8N2326RWK
EUT Rated Voltage : DC 12.0 V, 3.0 A
Test Voltage : 120 Vac / 60 Hz
Applicable Standard : FCC 47 CFR PART 15 SUBPART C
ANSI C63.10:2013

Test Result : Complied

Performing Lab. : A Test Lab Techno Corp.
No. 140-1, Changan Street, Bade District,
Taoyuan City 33465, Taiwan (R.O.C.)
Tel : +886-3-2710188 / Fax : +886-3-2710190
Taiwan Accreditation Foundation accreditation number: 1330
<http://www.atl-lab.com.tw/e-index.htm>



A Test Lab Techno Corp. tested the above equipment in accordance with the requirements set forth in the above standards. All indications of Pass/Fail in this report are opinions expressed by A Test Lab Techno Corp. based on interpretations and/or observations of test results. The test results show that the equipment tested is capable of demonstrating compliance with the requirements as documented in this report.

Approved By :

(Kai Yu Yang)

TABLE OF CONTENTS

1	General Information	5
1.1.	Summary of Test Result	5
1.2.	Measurement Uncertainty	6
2	EUT Description.....	7
3	Test Methodology.....	9
3.1.	Mode of Operation.....	9
3.2.	EUT Test Step.....	15
3.3.	Configuration of Test System Details.....	16
3.4.	Test Instruments	18
3.5.	Test Site Environment.....	20
4	Measurement Procedure.....	21
4.1.	AC Power Line Conducted Emission Measurement.....	21
4.2.	Radiated Emission Measurement.....	23
4.3.	Maximum Conducted Output Power Measurement.....	27
4.4.	6 dB RF Bandwidth Measurement.....	28
4.5.	Maximum Power Spectral Density Measurement.....	29
4.6.	Out of Band Conducted Emissions Measurement.....	31
4.7.	Antenna Measurement	32
5	Test Results	34
5.1	Conducted Emission.....	34
5.2	Conducted Test Results.....	36
5.3	Radiated Emission Measurement.....	156

Appendix A. Test Setup Photographs

1 General Information

1.1. Summary of Test Result

Standard	Item	Result	Remark
15.207	AC Power Conducted Emission	PASS	----
15.247(d)	Transmitter Radiated Emissions	PASS	----
15.247(b)(3)	Max. Output Power	PASS	----
15.247(a)(2)	6 dB RF Bandwidth	PASS	----
15.247(e)	Maximum Power Spectral Density	PASS	----
15.247(d)	Out of Band Conducted Spurious Emission	PASS	----
15.203	Antenna Requirement	PASS	----

Decision Rule

- Uncertainty is not included.
- Uncertainty is included.

Standard	Description
CFR47, Part 15, Subpart C	Intentional Radiators
ANSI C63. 10: 2013	American National Standard of Procedures for Compliance Testing of Unlicensed Wireless Devices
KDB 558074 D01 15.247 Meas Guidance v05r02	GUIDANCE FOR COMPLIANCE MEASUREMENTS ON DIGITAL TRANSMISSION SYSTEM, FREQUENCY HOPPING SPREAD SPECTRUM SYSTEM, AND HYBRID SYSTEM DEVICES OPERATING UNDER SECTION 15.247 OF THE FCC RULES
KDB 662911 D01 v02r01	Emissions Testing of Transmitters with Multiple Outputs in the Same Band (e.g., MIMO, Smart Antenna, etc)

1.2. Measurement Uncertainty

Test Item	Frequency Range	Uncertainty
Conducted Emission	150 kHz ~ 30 MHz	2.7 dB
Radiated Emission	9 kHz ~ 30 MHz	2.2 dB
	30 MHz ~ 1000 MHz	5.1 dB
	1000 MHz ~ 18000 MHz	5.2 dB
	18000 MHz ~ 26500 MHz	4.6 dB
	26500 MHz ~ 40000 MHz	4.6 dB
Conducted Output Power	1.1 dB	
RF Bandwidth	4.7 %	
Power Spectral Density	1.1 dB	

2 EUT Description

Applicant	Askey Computer Corp 10F, No. 119, JIANKANG RD. ZHONGHE DIST, NEW TAIPEI CITY, Taiwan			
Manufacturer	Askey Computer Corp 10F, No. 119, JIANKANG RD. ZHONGHE DIST, NEW TAIPEI CITY, Taiwan			
Product Type	Remote Worker Kit			
Trade Name	Askey, Unisys			
Model Number	2326RWK			
FCC ID	H8N2326RWK			
Operate Freq. Band	Frequency Range (MHz)	Modulation	Channel Bandwidth	Data Rate 400 / 800 GI (ns)
IEEE 802.11b	2412 ~ 2472	DSSS	20 MHz	Up to 11 Mbps
IEEE 802.11g	2412 ~ 2472	OFDM	20 MHz	Up to 54 Mbps
IEEE 802.11n 2.4 GHz 20 MHz	2412 ~ 2472	OFDM(64QAM)	20 MHz	Up to 144.4 bps
IEEE 802.11n 2.4 GHz 40 MHz	2422 ~ 2462	OFDM(64QAM)	40 MHz	Up to 300 Mbps
IEEE 802.11n 2.4 GHz 20 MHz	2412 ~ 2472	OFDM(256QAM)	20 MHz	Up to 173.3 Mbps
IEEE 802.11n 2.4 GHz 40 MHz	2422 ~ 2462	OFDM(256QAM)	40 MHz	Up to 400 Mbps
IEEE 802.11ax 2.4 GHz 20 MHz	2412 ~ 2472	OFDMA	20 MHz	Up to 286.8 Mbps
IEEE 802.11ax 2.4 GHz 40 MHz	2422 ~ 2462	OFDMA	40 MHz	Up to 573.5 Mbps
Antenna information	ANT	Model Number	Type	Max. Gain (dBi)
	ANT-0	N03AKANF-T-PK1-E140U	PCB Antenna	5.8
	ANT-1	N03AKANG-T-PK1-K195U	PCB Antenna	5.4
	ANT-2	N03AKANH-T-PK1-P85U	PCB Antenna	4.1
	ANT-3	N03AKANJ-T-PK1-R65U	PCB Antenna	4.5
Antenna Delivery	See section 3.1			
Operate Temp. Range	0 ~ +40 °C			

Frequency Band	Max. RF Output Power (W)
IEEE 802.11b	0.463
IEEE 802.11g	0.806
IEEE 802.11n 2.4 GHz 20 MHz(64QAM)	0.589
IEEE 802.11n 2.4 GHz 40 MHz(64QAM)	0.292
IEEE 802.11n 2.4 GHz 20 MHz(256QAM)	0.600
IEEE 802.11n 2.4 GHz 40 MHz(256QAM)	0.298
IEEE 802.11ax 2.4 GHz 20 MHz	0.741
IEEE 802.11ax 2.4 GHz 40 MHz	0.321

Beamforming on

Frequency Band	Max. RF Output Power (W)
IEEE 802.11n 2.4 GHz 20 MHz(64QAM)	0.238
IEEE 802.11n 2.4 GHz 40 MHz(64QAM)	0.239
IEEE 802.11n 2.4 GHz 20 MHz(256QAM)	0.242
IEEE 802.11n 2.4 GHz 40 MHz(256QAM)	0.242
IEEE 802.11ax 2.4 GHz 20 MHz	0.245
IEEE 802.11ax 2.4 GHz 40 MHz	0.247

3 Test Methodology

3.1. Mode of Operation

Decision of Test ATL has verified the construction and function in typical operation. All the test modes were carried out with the EUT in normal operation, which was shown in this test report and defined as:

Pre-Test Mode
Mode 1: Transmit mode
Mode 2: IEEE 802.11b Continuous TX mode
Mode 3: IEEE 802.11g Continuous TX mode
Mode 4: IEEE 802.11n 2.4 GHz 20 MHz(64QAM) Continuous TX mode
Mode 5: IEEE 802.11n 2.4 GHz 40 MHz(64QAM) Continuous TX mode
Mode 6: IEEE 802.11n 2.4 GHz 20 MHz(256QAM) Continuous TX mode
Mode 7: IEEE 802.11n 2.4 GHz 40 MHz(256QAM) Continuous TX mode
Mode 8: IEEE 802.11ax 2.4 GHz 20 MHz Continuous TX mode
Mode 9: IEEE 802.11ax 2.4 GHz 40 MHz Continuous TX mode

Final-Test Mode
Mode 1: Transmit mode
Mode 2: IEEE 802.11b Continuous TX mode
Mode 3: IEEE 802.11g Continuous TX mode
Mode 8: IEEE 802.11ax 2.4 GHz 20 MHz Continuous TX mode
Mode 9: IEEE 802.11ax 2.4 GHz 40 MHz Continuous TX mode

Software used to control the EUT for staying in continuous transmitting mode was programmed.

After verification, all tests were carried out with the worst case test modes.

By preliminary testing and verifying three axis (X, Y and Z) position of EUT transmitted status, it was found that "X axis" position was the worst, then the final test was executed the worst condition and test data were recorded in this report.

Test Mode	ANT-0	ANT-1	ANT-2	ANT-3	ANT-0+1+2+3
Mode 2	V	---	---	---	---
Mode 3	V	V	V	V	V
Mode 4	V	V	V	V	V
Mode 5	V	V	V	V	V
Mode 6	V	V	V	V	V
Mode 7	V	V	V	V	V
Mode 8	V	V	V	V	V
Mode 9	V	V	V	V	V

Test Mode	Antenna Delivery	Data Rate (Mbps)	Test Channel
Mode 2	1TX / 1RX (Only)	1	1, 6, 11
Mode 3	4TX / 4RX (CDD /Beamforming on)	6	1, 6, 11
Mode 4	4TX / 4RX (CDD /Beamforming on)	26	1, 6, 11
Mode 5	4TX / 4RX (CDD /Beamforming on)	54	3, 6, 9
Mode 6	4TX / 4RX (CDD /Beamforming on)	26	1, 6, 11
Mode 7	4TX / 4RX (CDD /Beamforming on)	54	3, 6, 9
Mode 8	4TX / 4RX (CDD /Beamforming on)	MCS0	1, 6, 11
Mode 9	4TX / 4RX (CDD /Beamforming on)	MCS0	3, 6, 9

Duty cycle

Test Mode	Frequency (MHz)	on time (ms)	on+off time (ms)	Duty cycle	Duty Factor (dB)	1/T Minimum VBW (kHz)
Mode 2	2412.0	1.420	2.130	0.667	1.761	0.704
Mode 3	2412.0	2.011	2.072	0.971	0.130	0.497
Mode 8	2412.0	5.490	5.730	0.958	0.186	0.182
Mode 9	2422.0	5.490	5.760	0.953	0.209	0.182

Beamforming on

Test Mode	Frequency (MHz)	on time (ms)	on+off time (ms)	Duty cycle	Duty Factor (dB)	1/T Minimum VBW (kHz)
Mode 8	2412.0	1.800	1.920	0.938	0.280	0.556
Mode 9	2422.0	1.800	1.960	0.918	0.370	0.556

Duty Cycle Graphs

Mode 2: IEEE 802.11b Continuous TX mode

On+off time

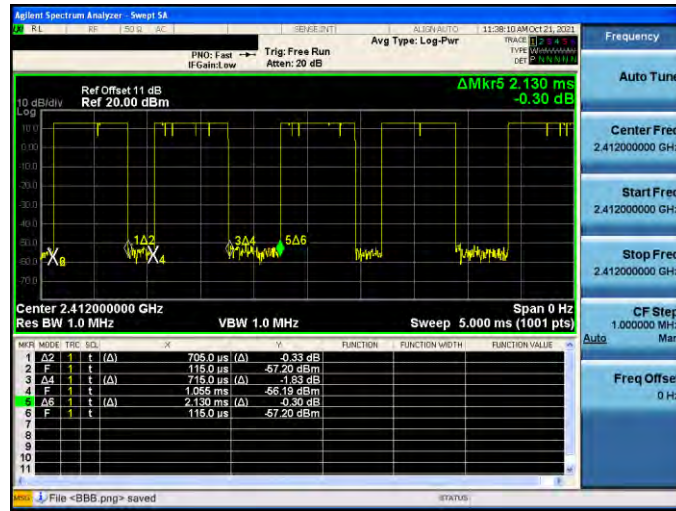

Mode 3: IEEE 802.11g Continuous TX mode

On+off time

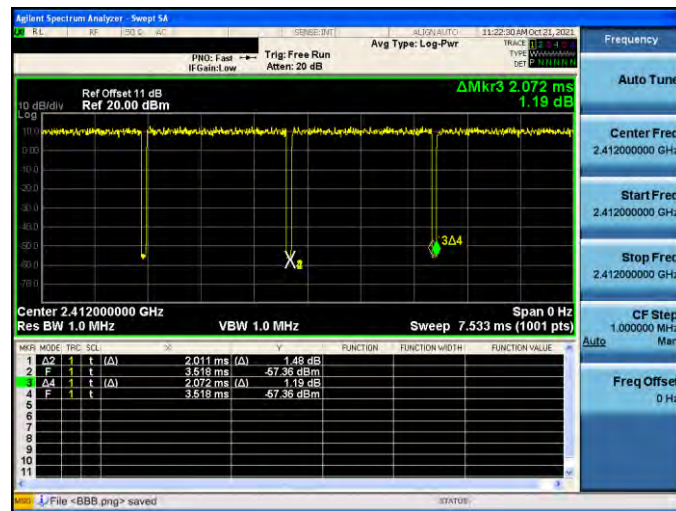

Mode 8: IEEE 802.11ax 2.4 GHz 20 MHz Continuous TX mode

On+off time

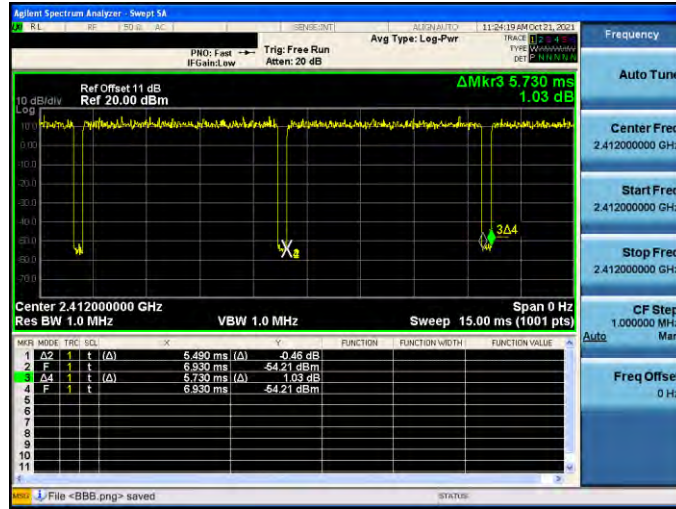

Mode 9: IEEE 802.11ax 2.4 GHz 40 MHz Continuous TX mode

On+off time

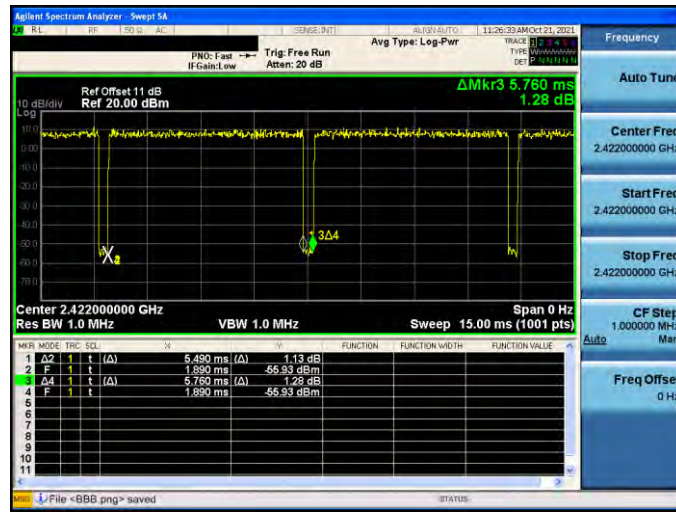

Beamforming on

Mode 8: IEEE 802.11ax 2.4 GHz 20 MHz Continuous TX mode

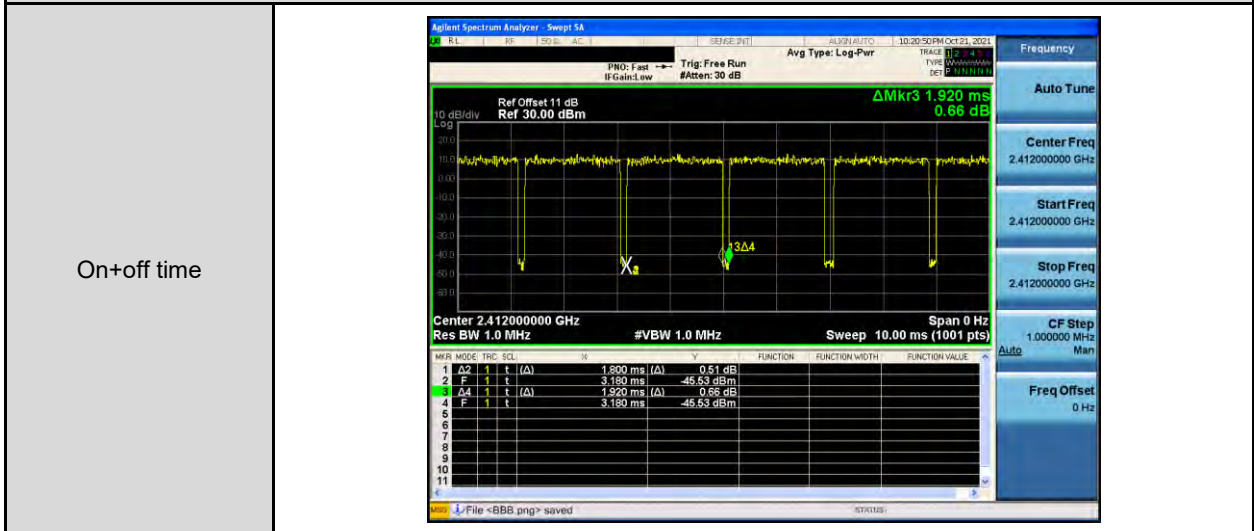

Mode 9: IEEE 802.11ax 2.4 GHz 40 MHz Continuous TX mode



3.2. EUT Test Step

1.	Setup the EUT shown on "Configuration of Test System Details".
2.	Turn on the power of all equipment.
3.	Turn on TX function.
4.	EUT run test program.

Measurement Software			
No.	Description	Software	Version
1	Conducted Emission	EZ EMC	1.1.4.3
2	Radiated Emission	EZ EMC	1.1.4.4

3.3. Configuration of Test System Details

Conducted Emissions

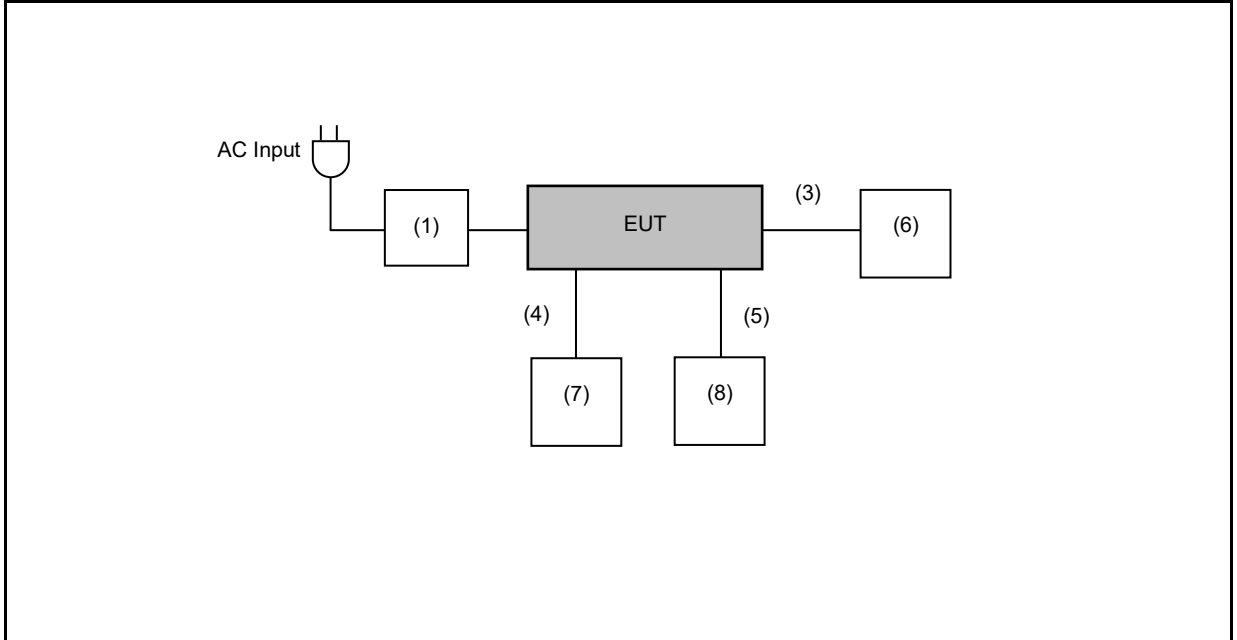

Radiated Emission

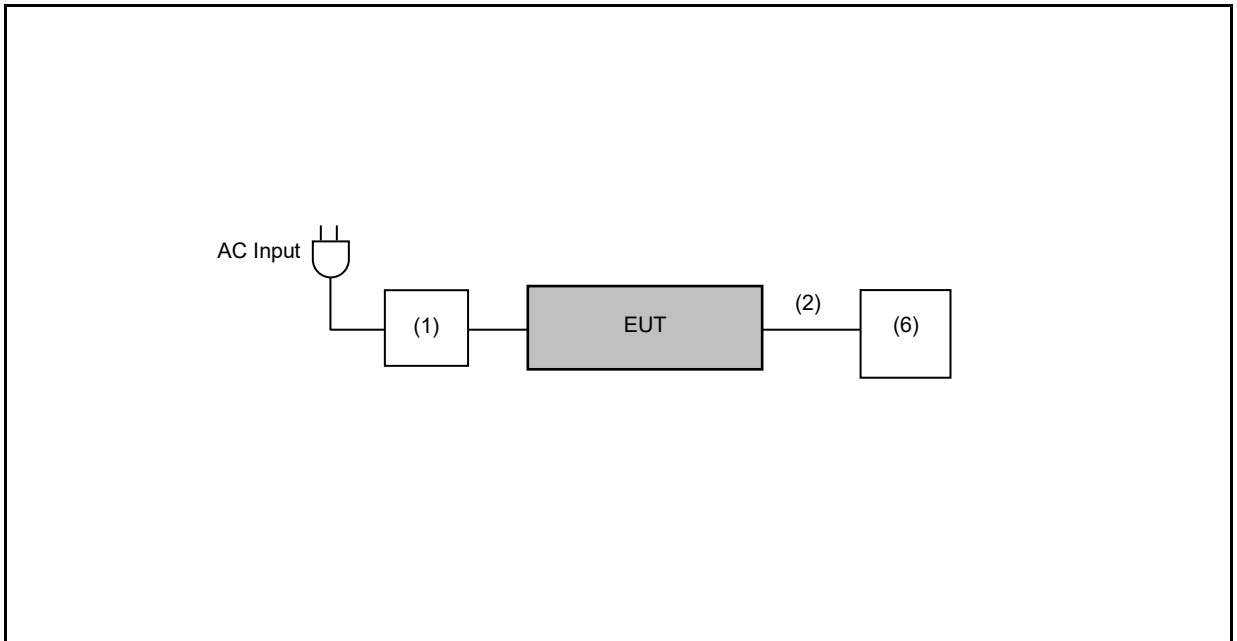

Devices Description					
	Product	Manufacturer	Model Number	Serial Number	Power Cord
(1)	AC Adapter	Sunny	SYS1618-3612-W2	---	---
(2)	Lan Cable	TATUNG	CAT5E	---	---
(3)	Lan Cable	LIOU YUANE	SP-YX-MF-860	---	---
(4)	Lan Cable	LIOU YUANE	SP-YX-MF-860	---	---
(5)	Lan Cable	HUAWEI	UL2464	---	---
(6)	Notebook	HP	TPN-I130	---	---
(7)	Notebook	ASUS	P2430U	---	---
(8)	Notebook	ASUS	P1448U	---	---

3.4. Test Instruments

For Conducted Emission

Test Period: Oct. 30, 2021

Testing Engineer: Louis Shen

Use	Equipment	Manufacturer	Model Number	Serial Number	Cal. Date	Cal. Period
<input checked="" type="checkbox"/>	Test Receiver	R&S	ESCI	100367	05/21/2021	1 year
<input type="checkbox"/>	Test Receiver	R&S	ESCI	100722	10/28/2020	1 year
<input type="checkbox"/>	Test Receiver	R&S	ESCI	101000	11/27/2020	1 year
<input checked="" type="checkbox"/>	LISN	R&S	ENV216	101040	03/29/2021	1 year
<input checked="" type="checkbox"/>	LISN	R&S	ENV216	101041	04/08/2021	1 year
<input checked="" type="checkbox"/>	RF Cable	Woken	00100D1380194M	TE-02-03	05/28/2021	1 year

Note: N.C.R. = No Calibration Request.

For Radiated Emissions
 Test Period: Oct. 15 ~ Oct. 19, 2021
 Testing Engineer: Pink Li, Marc Yeh

Radiation test sites		Semi Anechoic Room				
Use	Equipment	Manufacturer	Model Number	Serial Number	Cal. Date	Cal. Period
<input type="checkbox"/>	Spectrum Analyzer (10 Hz~44 GHz)	Keysight	N9010A	MY52221312	01/18/2021	1 year
<input type="checkbox"/>	Spectrum Analyzer (3 Hz~50 GHz)	Agilent	N9030A	MY53120541	01/08/2021	1 year
<input checked="" type="checkbox"/>	Spectrum Analyzer (2 Hz~50 GHz)	Keysight	N9030B	MY57143537	04/19/2021	1 year
<input checked="" type="checkbox"/>	Amplifier (100 kHz~1.3 GHz)	Agilent	8447D	2944A11119	01/15/2021	1 year
<input type="checkbox"/>	Amplifier (100 kHz~1.3 GHz)	Agilent	8447D	2944A10961	07/06/2021	1 year
<input type="checkbox"/>	Broadband Amplifier (100 kHz~1 GHz)	Titan	T0910E00014330A1F	001	07/23/2021	1 year
<input type="checkbox"/>	Amplifier (1 GHz~26.5 GHz)	Agilent	8449B	3008A02237	10/21/2020	1 year
<input checked="" type="checkbox"/>	Broadband Amplifier (1 GHz~26.5 GHz)	Titan	T0912E01263025A1F	002	07/26/2021	1 year
<input type="checkbox"/>	Preamplifier (26.5 GHz~40 GHz)	EMCI	EMC2654045	980028	08/19/2021	1 year
<input checked="" type="checkbox"/>	Loop Antenna (9 kHz~30 MHz)	COM-POWER CORPORATION	AL-130	121014	04/07/2021	1 year
<input checked="" type="checkbox"/>	Trilog Broadband Antenna (30 kHz~1 GHz)	Schwarzbeck Mess-Elektronik	VULB9168	01146	07/19/2021	1 year
<input type="checkbox"/>	Trilog Broadband Antenna (30 kHz~1 GHz)	Schwarzbeck Mess-Elektronik	VULB9168	416	11/11/2020	1 year
<input checked="" type="checkbox"/>	Broadband Horn Antenna (1 GHz~18 GHz)	Schwarzbeck Mess-Elektronik	9120D	02207	07/09/2021	1 year
<input type="checkbox"/>	Broadband Horn Antenna (1 GHz~18 GHz)	Schwarzbeck Mess-Elektronik	9120D	9120D-550	08/24/2021	1 year
<input checked="" type="checkbox"/>	Broadband Horn Antenna (18 GHz~40 GHz)	Schwarzbeck Mess-Elektronik	9170	9170-320	08/24/2021	1 year
<input type="checkbox"/>	Horn Antenna (18 GHz~40 GHz)	ETS	3116	00086467	12/03/2020	1 year
<input type="checkbox"/>	RF Cable	EMCI	EMC104-N-N-6000	TE01-1	02/19/2021	1 year
<input type="checkbox"/>	Microwave Cable	EMCI	EMC104-SM-SM-130 00	170814	02/19/2021	1 year
<input type="checkbox"/>	Microwave Cable	EMCI	EMC102-KM-KM-140 00	151001	02/19/2021	1 year
<input checked="" type="checkbox"/>	Coaxial Cable	Titan	T0710AT327A10A100	J11005	08/06/2021	1 year
<input checked="" type="checkbox"/>	Coaxial Cable	Titan	T0710AT327A10A900	J11004	08/06/2021	1 year
<input checked="" type="checkbox"/>	Coaxial Cable	Titan	CFD400NL-LW	001	08/06/2021	1 year
<input type="checkbox"/>	Bluetooth Tester	R&S	CBT	100350	03/17/2021	2 years
<input type="checkbox"/>	Wireless Connectivity Tester	R&S	CMW270	102208	06/02/2021	1 year
<input type="checkbox"/>	Power Supply	KEITHLEY	2303	4045290	02/01/2021	1 year

Note: N.C.R. = No Calibration Request.

For Conducted

Test Period: Oct. 21 ~ Oct. 22, 2021

Testing Engineer: Brain Lin, Andy Lu

Use	Equipment	Manufacturer	Model Number	Serial Number	Cal. Date	Cal. Period
<input checked="" type="checkbox"/>	Power Sensor	Anritsu	MA2411B	1126022	09/03/2021	1 year
<input checked="" type="checkbox"/>	Power Meter	Anritsu	ML2495A	1135009	09/03/2021	1 year
<input type="checkbox"/>	Power Sensor	Agilent	N1921A	MY45241957	12/09/2020	1 year
<input type="checkbox"/>	Power Meter	Agilent	N1911A	MY45101619	12/09/2020	1 year
<input type="checkbox"/>	Spectrum Analyzer (10 Hz~26.5 GHz)	Keysight	N9010B	MY59071418	03/17/2021	1 year
<input type="checkbox"/>	Spectrum Analyzer (9 kHz~26.5 GHz)	Agilent	N9010A	MY48030518	07/23/2021	1 year
<input checked="" type="checkbox"/>	Spectrum Analyzer (20 Hz~26.5 GHz)	Agilent	N9020A	US47520902	09/09/2021	1 year
<input type="checkbox"/>	Spectrum Analyzer (3 Hz~50 GHz)	Agilent	N9030A	MY53120541	01/08/2021	1 year
<input type="checkbox"/>	Temperature & Humidity Chamber	TAICHY	MHU-225LA	980729	03/30/2021	1 year
<input type="checkbox"/>	Signal Generator	Keysight	N5182B	MY53052569	04/20/2021	1 year
<input type="checkbox"/>	Signal Generator	Keysight	N5182BX07	MY59360221	04/20/2021	1 year
<input type="checkbox"/>	Bluetooth Tester	R&S	CBT	100350	03/17/2021	2 years
<input type="checkbox"/>	Wireless Connectivity Tester	R&S	CMW270	102208	06/02/2021	1 year
<input type="checkbox"/>	Power Supply	KEITHLEY	2303	4045290	02/01/2021	1 year
<input type="checkbox"/>	RF Communication Test Set	HP	8920A	3344A03297	08/10/2021	1 year

Note: N.C.R. = No Calibration Request.

3.5. Test Site Environment

Items	Required (IEC 60068-1)	Actual
Temperature (°C)	15-35	20-30
Humidity (%RH)	25-75	45-75

4 Measurement Procedure

4.1. AC Power Line Conducted Emission Measurement

■ Limit

Frequency (MHz)	Quasi-peak	Average
0.15 - 0.5	66 to 56	56 to 46
0.50 - 5.0	56	46
5.0 - 30.0	60	50

■ Test Setup

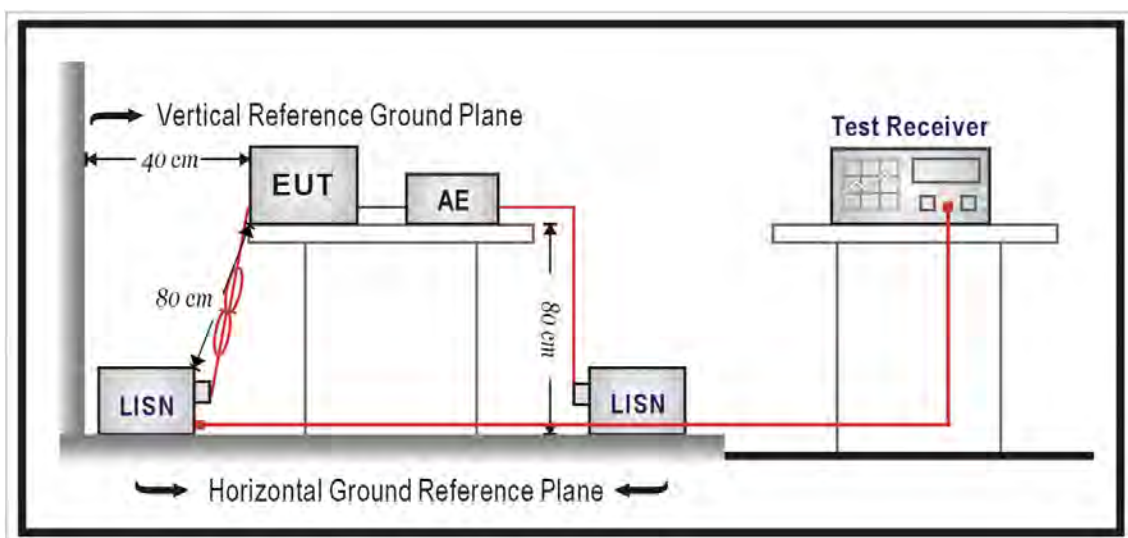

■ Test Procedure

The EUT and simulators are connected to the main power through a line impedance stabilization network (L.I.S.N.). This provides a $50 \Omega // 50 \mu\text{H}$ coupling impedance for the measuring equipment. The peripheral devices are also connected to the main power through a LISN that provides a $50 \Omega // 50 \mu\text{H}$ coupling impedance with 50 ohm termination.

Tabletop device shall be placed on a non-conducting platform, of nominal size 1 m by 1.5 m, raised 80 cm above the reference ground plane. The wall of screened room shall be located 40 cm to the rear of the EUT. Other surfaces of tabletop or floor standing EUT shall be at least 80 cm from any other ground conducting surface including one or more LISNs. For floor-standing device shall be placed under the EUT with a 12 mm insulating material.

Conducted emissions were investigated over the frequency range from 0.15 MHz to 30 MHz using a resolution bandwidth of 9 kHz. The equipment under test (EUT) shall be meet the limits in section 4.1, as applicable, including the average limit and the quasi-peak limit when using respectively, an average detector and quasi-peak detector measured in accordance with the methods described of related standard. When all of peak value were complied with quasi-peak and average limit from 150 kHz to 30 MHz then quasi-peak and average measurement was unnecessary.

The AMN shall be placed 0.8 m from the boundary of the unit under test and bonded to a ground reference plane for AMNs mounted on top of the ground reference plane. This distance is between the closest points of the AMN and the EUT. All other units of the EUT and associated equipment shall be at least 0.8 m from the AMN. If the mains power cable is longer than 1 m then the cable shall be folded back and forth at the centre of the lead to form a bundle no longer than 0.4 m. All of interconnecting cables that hang closer than 40 cm to the ground plane shall be folded back and forth in the center forming a bundle 30 cm to 40 cm long. All of EUT and AE shall be separate place more than 0.1 m. All 50Ω ports of the LISN shall be resistively terminated into 50Ω loads when not connected to the measuring instrument.

If the reading of the measuring receiver shows fluctuations close to the limit, the reading shall be observed for at least 15 s at each measurement frequency; the higher reading shall be recorded with the exception of any brief isolated high reading which shall be ignored.

4.2. Radiated Emission Measurement

■ Limit

According to §15.209(a), except as provided elsewhere in this subpart, the emissions from an intentional radiator shall not exceed the field strength levels specified in the following table:

Frequency (MHz)	Field Strength ($\mu\text{V}/\text{m}$ at meter)	Measurement Distance (meters)
0.009 – 0.490	$2400 / F$ (kHz)	300
0.490 – 1.705	$24000 / F$ (kHz)	30
1.705 – 30.0	30	30
30 - 88	100**	3
88-216	150**	3
216-960	200**	3
Above 960	500	3

** Except as provided in paragraph (g), fundamental emissions from intentional radiators operating under this Section shall not be located in the frequency bands 54-72 MHz, 76-88 MHz, 174-216 MHz or 470-806 MHz. However, operation within these frequency bands is permitted under other sections of this Part, e.g., Sections 15.231 and 15.241.

■ Setup

9 kHz ~ 30 MHz

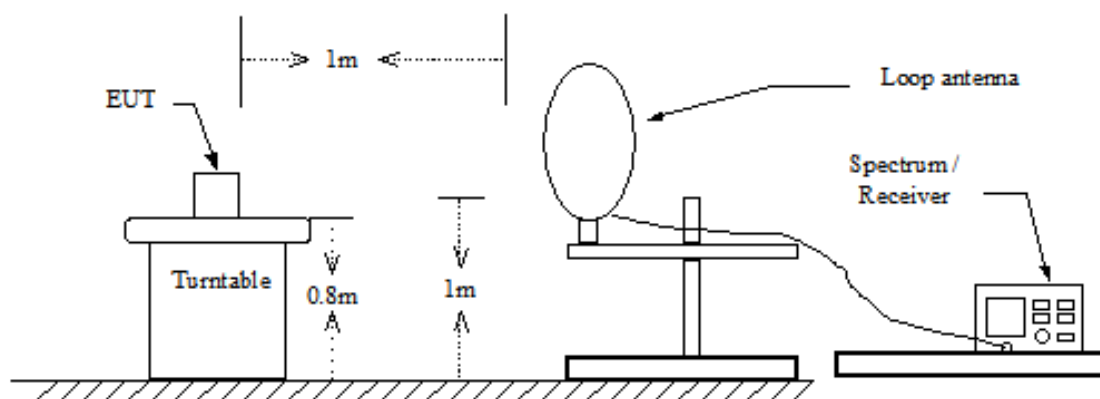

Below 1 GHz

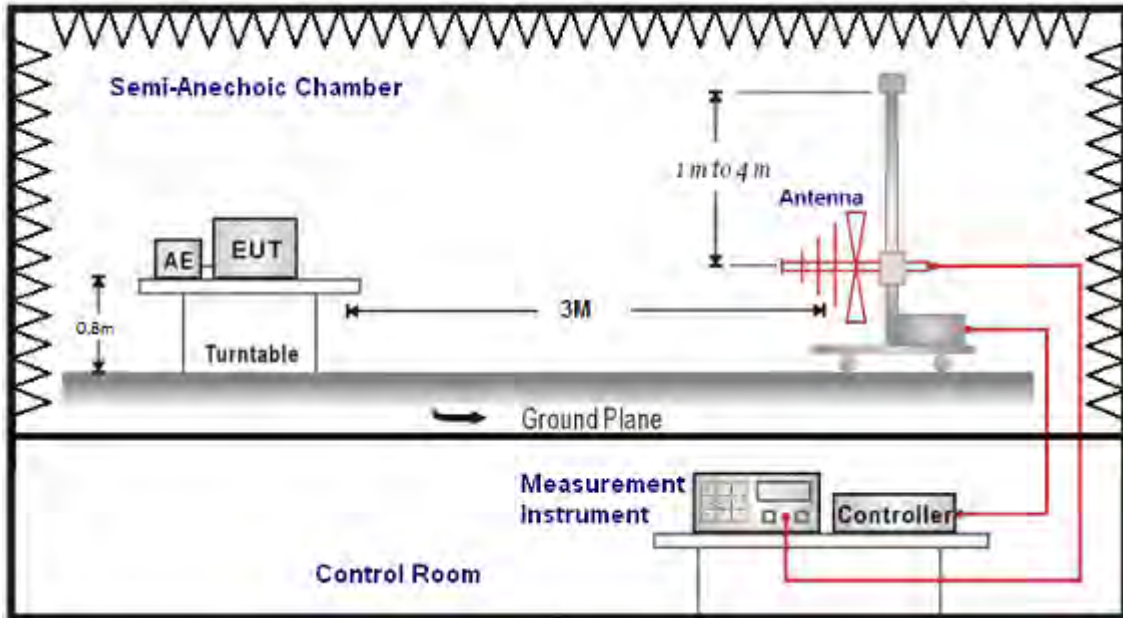

Above 1 GHz

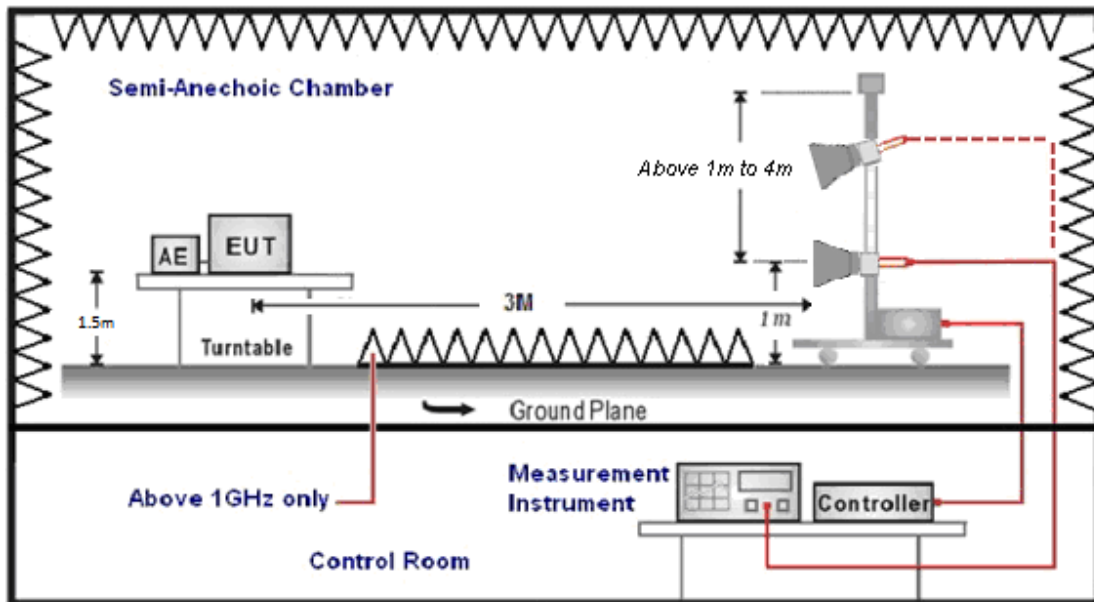

■ Test Procedure

Final radiation measurements were made on a three-meter, Semi Anechoic Chamber. The EUT system was placed on a nonconductive turntable which is 0.8 or 1.5 meters height, top surface 1.0 x 1.5 meter. The spectrum was examined from 250 MHz to 2.5 GHz in order to cover the whole spectrum below 10th harmonic which could generate from the EUT. During the test, EUT was set to transmit continuously & Measurements spectrum range from 9 kHz to 26.5 GHz is investigated.

For measurements below 1 GHz the resolution bandwidth is set to 100 kHz for peak detection measurements or 120 kHz for quasi-peak detection measurements. Peak detection is used unless otherwise noted as quasi-peak.

For measurements above 1 GHz the resolution bandwidth is set to 1 MHz, and then the video bandwidth is set to 3 MHz for peak measurements and 10 Hz for average measurements when Duty cycle >0.98 / $1/T$ for average measurements when Duty cycle <0.98 . A nonconductive material surrounded the EUT to supporting the EUT for standing on three orthogonal planes. At each condition, the EUT was rotated 360 degrees, and the antenna was raised and lowered from one to four meters to find the maximum emission levels. Measurements were taken using both horizontal and vertical antenna polarization.

SCHWARZBECK MESS-ELEKTRONIK Biconilog Antenna at 3 Meter and the SCHWARZBECK Double Ridged Guide Antenna was used in frequencies 1 –26.5 GHz at a distance of 3 meter. The antenna at an angle toward the source of the emission. All test results were extrapolated to equivalent signal at 3 meters utilizing an inverse linear distance extrapolation Factor (20 dB/decade).

For testing above 1 GHz, the emission level of the EUT in peak mode was 20 dB lower than average limit (that means the emission level in peak mode also complies with the limit in average mode), then testing will be stopped and peak values of EUT will be reported, otherwise, the emissions will be measured in average mode again and reported.

Appropriate preamplifiers were used for improving sensitivity and precautions were taken to avoid overloading or desensitizing the spectrum analyzer. No post – detector video filters were used in the test.

The spectrum analyzer's 6 dB bandwidth was set to 1 MHz, and the analyzer was operated in the peak detection mode, for frequencies both below and up 1 GHz. The average levels were obtained by subtracting the duty cycle correction factor from the peak readings.

The following procedures were used to convert the emission levels measured in decibels referenced to 1 microvolt (dBuV) into field intensity in micro volts pre meter (uV/m).

The actual field intensity in decibels referenced to 1 microvolt in to field intensity in micro volts per meter (dBuV/m).

The actual field intensity in referenced to 1 microvolt per meter (dBuV/m) is determined by algebraically adding the measured reading in dBuV, the antenna factor (dB), and cable loss (dB) and Subtracting the gain of preamplifier (dB) is auto calculate in spectrum analyzer.

$$(1) \text{ Amplitude (dBuV/m) = FI (dBuV) +AF (dBuV) +CL (dBuV)-Gain (dB)}$$

FI= Reading of the field intensity.

AF= Antenna factor.

CL= Cable loss.

P.S Amplitude is auto calculate in spectrum analyzer.

$$(2) \text{ Actual Amplitude (dBuV/m) = Amplitude (dBuV)-Dis(dB)}$$

The FCC specified emission limits were calculated according the EUT operating frequency and by following linear interpolation equations:

(a) For fundamental frequency : Transmitter Output < +30 dBm

(b) For spurious frequency : Spurious emission limits = fundamental emission limit /10

Data of measurement within this frequency range without mark in the table above means the reading of emissions are attenuated more than 20 dB below the permissible limits or the field strength is too small to be measured.

4.3. Maximum Conducted Output Power Measurement

■ **Limit**

For systems using digital modulation in the 2400-2483.5 MHz, the limit for maximum output power is 30 dBm.

And According to 15.247 (b), if transmitting antennas of directional gain greater than 6 dBi are used, the power shall be reduced by the amount in dB that the directional gain of the antenna exceeds 6 dBi.

IEEE 802.11g / IEEE 802.11n 2.4 GHz 20 MHz(64QAM) / IEEE 802.11n 2.4 GHz 40 MHz(64QAM) /

IEEE 802.11n 2.4 GHz 20 MHz(256QAM) / IEEE 802.11n 2.4 GHz 40 MHz(256QAM) /

IEEE 802.11ax 2.4 GHz 20 MHz / IEEE 802.11ax 2.4 GHz 40 MHz

CDD mode:

Directional = Max. Gain : 5 dBi < 6 dBi

IEEE 802.11n 2.4 GHz 20 MHz(64QAM) / IEEE 802.11n 2.4 GHz 40 MHz(64QAM) /

IEEE 802.11n 2.4 GHz 20 MHz(256QAM) / IEEE 802.11n 2.4 GHz 40 MHz(256QAM) /

IEEE 802.11ax 2.4 GHz 20 MHz / IEEE 802.11ax 2.4 GHz 40 MHz

BF mode:

Directional Gain = $10 \cdot \log\{[10^{G1/20} + 10^{G2/20} + \dots + 10^{Gn/20}]^2 / NANT\}$ = 11 dBi > 6dBi

* power limit shall be reduced = 30 – 5 = 25 dBm

■ **Test Setup**

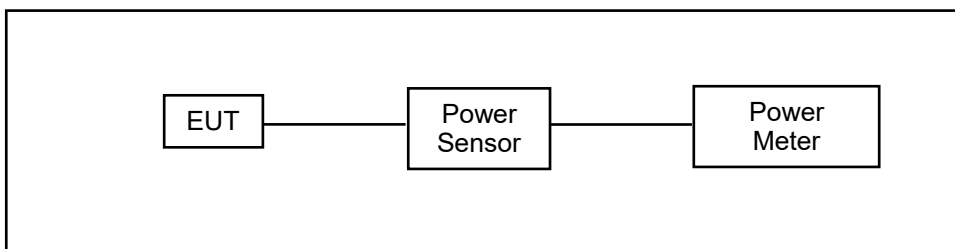

■ **Test Procedure**

The testing follows the Measurement Procedure of ANSI C63.10:2013 section 11.9.2.3.2 Method AVGPM.

The tests below are run with the EUT's transmitter set at high power in TX mode. The EUT is needed to force selection of output power level and channel number. While testing, EUT was set to transmit continuously. Remove the Subjective device's antenna and connect the RF output port to power sensor.

4.4. 6 dB RF Bandwidth Measurement

■ Limit

6 dB RF Bandwidth: Systems using digital modulation techniques may operate in the 2400–2483.5 MHz bands. The minimum 6 dB band-width shall be at least 500 kHz.

■ Test Setup

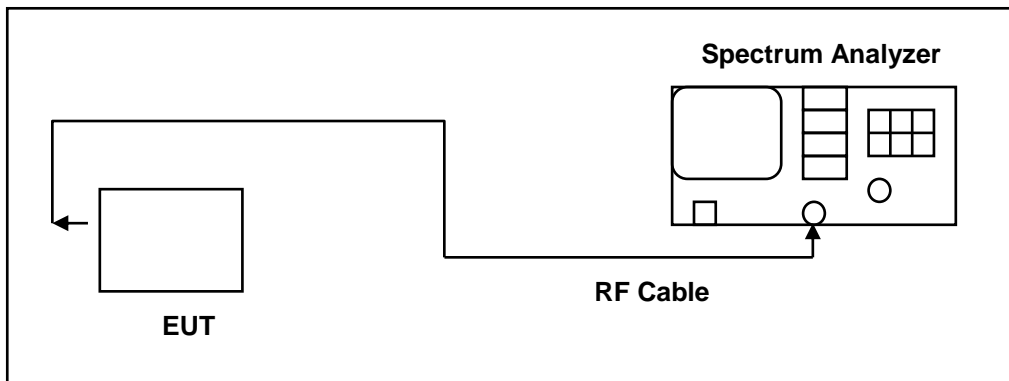

■ Test Procedure

The EUT tested to DTS test procedure of ANSI C63.10:2013 section 11.8.2 option2 for compliance to FCC 47CFR 15.247 requirements.

6 dB RF Bandwidth: The antenna port of the EUT was connected to the input of a spectrum analyzer. Analyzer RBW was set to 100 kHz. For each RF output channel investigated, the spectrum analyzer center frequency was set to the channel carrier. A peak output reading was taken, a DISPLAY line was drawn 6 dB lower than peak level. The 6 dB bandwidth was determined from where the channel output spectrum intersected the display line.

The test was performed at 3 channels (Channel low, middle, high)

4.5. Maximum Power Spectral Density Measurement

■ Limit

For digitally modulated systems, the power spectral density conducted from the intentional radiator to the antenna shall not be greater than 8 dBm in any 3 kHz band during any time interval of continuous transmission.

IEEE 802.11g / IEEE 802.11ax 2.4 GHz 20 MHz / IEEE 802.11ax 2.4 GHz 40 MHz

CDD mode:

Directional Gain = $10 \cdot \log\{[10^{(G1/20)} + 10^{(G2/20)} + \dots + 10^{(Gn/20)}]^2 / NANT\}$ = 11 dBi > 6 dBi;

* power spectral density limit shall be reduced = 8 - 5 = 3 dBm/3 kHz

IEEE 802.11ax 2.4 GHz 20 MHz / IEEE 802.11ax 2.4 GHz 40 MHz

BF mode:

Directional Gain = $10 \cdot \log\{[10^{(G1/20)} + 10^{(G2/20)} + \dots + 10^{(Gn/20)}]^2 / NANT\}$ = 11 dBi > 6 dBi;

* power spectral density limit shall be reduced = 8 - 5 = 3 dBm/3 kHz

■ **Test Setup**

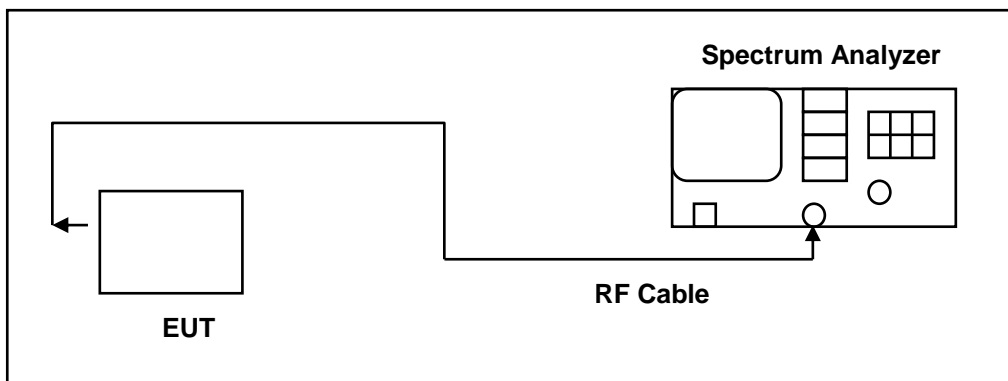

■ **Test Procedure**

The EUT tested to DTS test procedure of ANSI C63.10:2013 section 11.10.2 Method PKPSD for compliance to FCC 47CFR 15.247 requirements.

1. Set analyzer center frequency to DTS channel center frequency.
2. Set the span to 1.5 times the DTS bandwidth.
3. Set the RBW to: $3 \text{ kHz} \leq \text{RBW} \leq 100 \text{ kHz}$.
4. Set the VBW $\geq 3 \times \text{RBW}$.
5. Detector = peak.
6. Sweep time = auto couple.
7. Trace mode = max hold.
8. Allow trace to fully stabilize.
9. Use the peak marker function to determine the maximum amplitude level within the RBW.
10. If measured value exceeds limit, reduce RBW (no less than 3 kHz) and repeat.

4.6. Out of Band Conducted Emissions Measurement

■ Limit

In any 100 kHz bandwidth outside the frequency band in which the spread spectrum or digitally modulated intentional radiator is operating, the radio frequency power that is produced by the intentional radiator shall be at least 30 dB below that in the 100 kHz bandwidth within the band that contains the highest level of the desired power

■ Test Setup

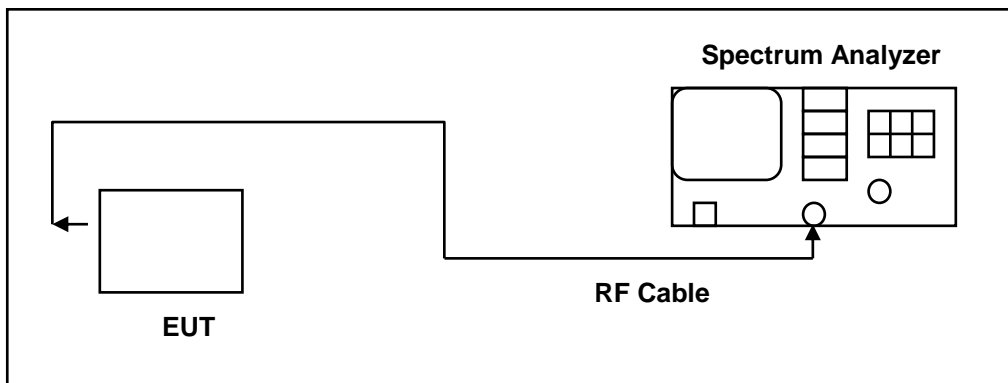

■ Test Procedure

In any 100 kHz bandwidth outside the EUT pass band, the RF power produced by the modulation products of the spreading sequence, the information sequence, and the carrier frequency shall be at least 30 dB below that of the maximum in-band 100 kHz emission, antenna output of the EUT was coupled directly to spectrum analyzer; if an external attenuator and/or cable was used, these losses are compensated for with the analyzer OFFSET function.

All other types of emissions from the EUT shall meet the general limits for radiated frequencies outside the pass band. The test was performed at 3 channels.

4.7. Antenna Measurement

■ Limit

For intentional device, according to 15.203, an intentional radiator shall be designed to ensure that no antenna other than that furnished by the responsible party shall be used with the device.

And According to 15.247 (b), if transmitting antennas of directional gain greater than 6 dBi are used, the power shall be reduced by the amount in dB that the directional gain of the antenna exceeds 6 dBi.

■ Antenna Description

See section 2 – antenna information.

■ Directional Gain Calculated

For Maximum Conducted Output Power

$$\text{Directional Gain} = 10 \cdot \log\left\{\frac{10^{G1/10} + 10^{G2/10} + \dots + 10^{Gn/10}}{NANT}\right\}$$

Operate Freq. Band	Directional Gain (dBi)
IEEE 802.11b	5.8
IEEE 802.11g	5
IEEE 802.11n 2.4 GHz 20 MHz(64QAM)	5
IEEE 802.11n 2.4 GHz 40 MHz(64QAM)	5
IEEE 802.11n 2.4 GHz 20 MHz(256QAM)	5
IEEE 802.11n 2.4 GHz 40 MHz(256QAM)	5
IEEE 802.11ax 2.4 GHz 20 MHz	5
IEEE 802.11ax 2.4 GHz 40 MHz	5

For Maximum Power Density

$$\text{Directional Gain} = 10 \cdot \log\left\{\frac{10^{G1/20} + 10^{G2/20} + \dots + 10^{Gn/20}}{NANT}\right\}^2$$

Operate Freq. Band	Directional Gain (dBi)
IEEE 802.11b	5.8
IEEE 802.11g	11
IEEE 802.11ax 2.4 GHz 20 MHz	11
IEEE 802.11ax 2.4 GHz 40 MHz	11

Beamforming on

For Maximum Conducted Output Power

$$\text{Directional Gain} = 10 \cdot \log\left\{\frac{10^{G1/10} + 10^{G2/10} + \dots + 10^{Gn/10}}{NANT}\right\}$$

Operate Freq. Band	Directional Gain (dBi)
IEEE 802.11n 2.4 GHz 20 MHz(64QAM)	11
IEEE 802.11n 2.4 GHz 40 MHz(64QAM)	11
IEEE 802.11n 2.4 GHz 20 MHz(256QAM)	11
IEEE 802.11n 2.4 GHz 40 MHz(256QAM)	11
IEEE 802.11ax 2.4 GHz 20 MHz	11
IEEE 802.11ax 2.4 GHz 40 MHz	11

For Maximum Power Density

$$\text{Directional Gain} = 10 \cdot \log\left\{\frac{10^{G1/20} + 10^{G2/20} + \dots + 10^{Gn/20}}{NANT}\right\}^2$$

Operate Freq. Band	Directional Gain (dBi)
IEEE 802.11ax 2.4 GHz 20 MHz	11
IEEE 802.11ax 2.4 GHz 40 MHz	11

5 Test Results

5.1 Conducted Emission

Standard:	FCC Part 15.247	Line:	L1
Test item:	Conducted Emission	Power:	AC 120 V/60 Hz
Mode:	Mode 1		
Description:			

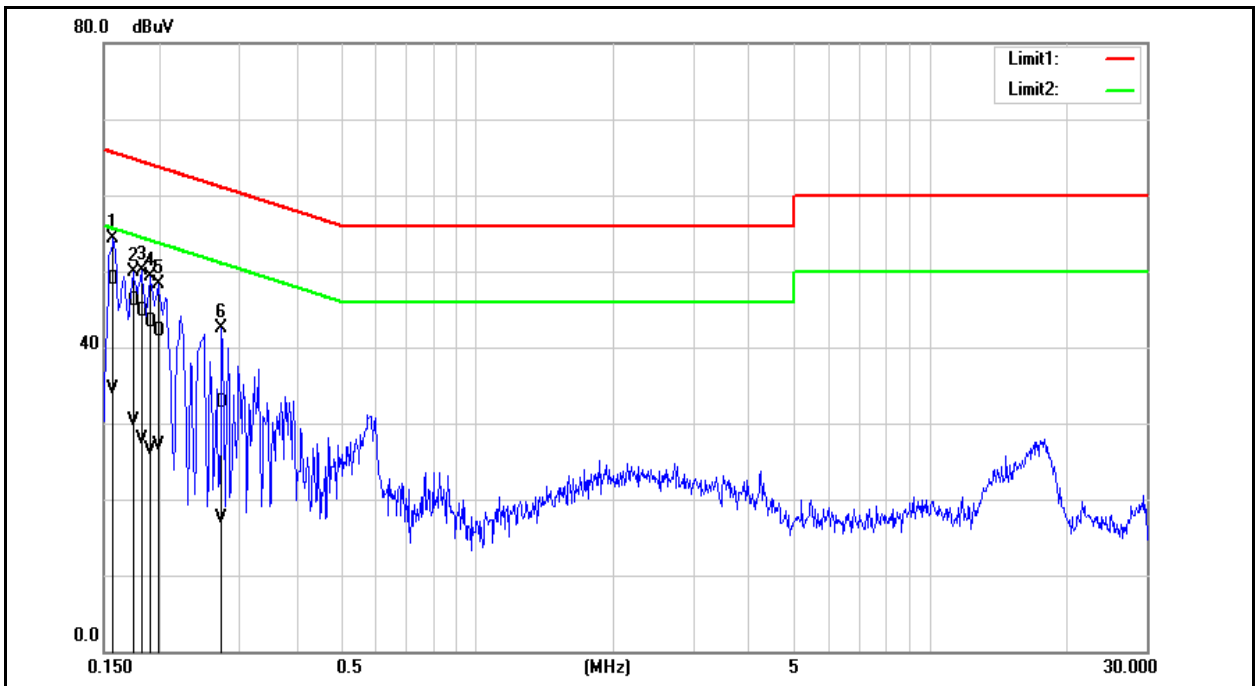

No.	Frequency (MHz)	QP reading (dBuV)	AVG reading (dBuV)	Correction factor (dB)	QP result (dBuV)	AVG result (dBuV)	QP limit (dBuV)	AVG limit (dBuV)	QP margin (dB)	AVG margin (dB)	Remark
1	0.1580	39.10	24.71	9.74	48.84	34.45	65.57	55.57	-16.73	-21.12	Pass
2	0.1740	36.45	20.59	9.74	46.19	30.33	64.77	54.77	-18.58	-24.44	Pass
3	0.1820	35.02	18.13	9.74	44.76	27.87	64.39	54.39	-19.63	-26.52	Pass
4	0.1900	33.57	16.74	9.74	43.31	26.48	64.04	54.04	-20.73	-27.56	Pass
5	0.1980	32.46	17.37	9.74	42.20	27.11	63.69	53.69	-21.49	-26.58	Pass
6	0.2740	22.99	7.67	9.74	32.73	17.41	61.00	51.00	-28.27	-33.59	Pass

Note: 1. Result (dBuV) = Correction factor (dB) + Reading(dBuV).

2. Correction factor (dB) = Cable loss (dB) + L.I.S.N. factor (dB).

Standard:	FCC Part 15.247	Line:	N
Test item:	Conducted Emission	Power:	AC 120 V/60 Hz
Mode:	Mode 1		
Description:			

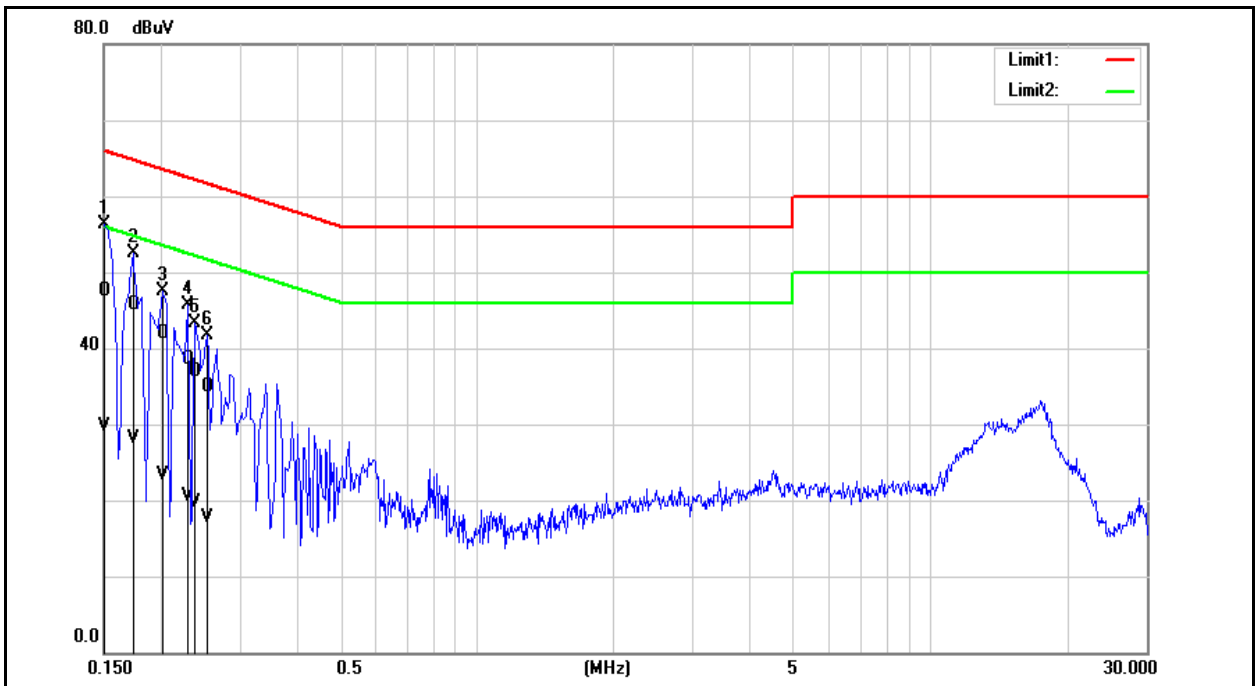

No.	Frequency (MHz)	QP reading (dBuV)	AVG reading (dBuV)	Correction factor (dB)	QP result (dBuV)	AVG result (dBuV)	QP limit (dBuV)	AVG limit (dBuV)	QP margin (dB)	AVG margin (dB)	Remark
1	0.1500	37.83	19.88	9.74	47.57	29.62	66.00	56.00	-18.43	-26.38	Pass
2	0.1740	35.90	18.44	9.74	45.64	28.18	64.77	54.77	-19.13	-26.59	Pass
3	0.2020	32.18	13.61	9.73	41.91	23.34	63.53	53.53	-21.62	-30.19	Pass
4	0.2300	28.79	10.68	9.73	38.52	20.41	62.45	52.45	-23.93	-32.04	Pass
5	0.2380	27.12	9.94	9.73	36.85	19.67	62.17	52.17	-25.32	-32.50	Pass
6	0.2540	25.10	7.93	9.73	34.83	17.66	61.63	51.63	-26.80	-33.97	Pass

Note: 1. Result (dBuV) = Correction factor (dB) + Reading(dBuV).
2. Correction factor (dB) = Cable loss (dB) + L.I.S.N. factor (dB).

5.2 Conducted Test Results

Maximum Conducted Output Power Measurement

Test Mode	Frequency (MHz)	RF Power setting in Test Software				Test Software Version
		ANT-0	ANT-1	ANT-2	ANT-3	
Mode 2	2412	24.0	24.0	24.0	24.0	QSPR Version 5.0-00196
	2437	24.0	24.0	24.0	24.0	
	2462	24.0	24.0	24.0	24.0	
Mode 3	2412	19.5	19.5	19.5	19.5	
	2437	24.0	24.0	24.0	24.0	
	2462	19.5	19.5	19.5	19.5	
Mode 4	2412	19.0	19.0	19.0	19.0	
	2437	24.0	24.0	24.0	24.0	
	2462	18.0	18.0	18.0	18.0	
Mode 5	2422	18.5	18.5	18.5	18.5	
	2437	19.5	19.5	19.5	19.5	
	2452	17.0	17.0	17.0	17.0	
Mode 6	2412	19.0	19.0	19.0	19.0	
	2437	24.0	24.0	24.0	24.0	
	2462	18.0	18.0	18.0	18.0	
Mode 7	2422	18.5	18.5	18.5	18.5	
	2437	19.5	19.5	19.5	19.5	
	2452	17.0	17.0	17.0	17.0	
Mode 8	2412	19.0	19.0	19.0	19.0	
	2437	24.0	24.0	24.0	24.0	
	2462	18.0	18.0	18.0	18.0	
Mode 9	2422	18.5	18.5	18.5	18.5	
	2437	19.5	19.5	19.5	19.5	
	2452	17.0	17.0	17.0	17.0	

Test Mode	Frequency (MHz)	Data Rate	ANT-0		ANT-1		Limit
			Average Output Power		Average Output Power		
			Measurement Results		Measurement Results		
			dBm	W	dBm	W	dBm
Mode 2	2412	1M	23.40	0.219	---	---	≤ 30.00
	2437		23.70	0.234	---	---	≤ 30.00
	2462		26.66	0.463	---	---	≤ 30.00
Mode 3	2412	6M	19.00	0.079	18.85	0.077	≤ 30.00
	2437		23.40	0.219	23.08	0.203	≤ 30.00
	2462		19.26	0.084	19.23	0.084	≤ 30.00
Mode 4	2412	26M	18.21	0.066	18.12	0.065	≤ 30.00
	2437		22.08	0.161	21.83	0.152	≤ 30.00
	2462		17.39	0.055	17.31	0.054	≤ 30.00
Mode 5	2422	54M	17.86	0.061	17.70	0.059	≤ 30.00
	2437		18.90	0.078	18.82	0.076	≤ 30.00
	2452		16.37	0.043	16.31	0.043	≤ 30.00
Mode 6	2412	26M	18.26	0.067	18.22	0.066	≤ 30.00
	2437		22.11	0.163	21.91	0.155	≤ 30.00
	2462		17.44	0.055	17.50	0.056	≤ 30.00
Mode 7	2422	54M	17.91	0.062	17.83	0.061	≤ 30.00
	2437		19.02	0.080	18.84	0.077	≤ 30.00
	2452		16.40	0.044	16.40	0.044	≤ 30.00
Mode 8	2412	MCS0	18.58	0.072	18.53	0.071	≤ 30.00
	2437		23.04	0.201	22.79	0.190	≤ 30.00
	2462		17.87	0.061	17.82	0.061	≤ 30.00
Mode 9	2422	MCS0	18.25	0.067	18.21	0.066	≤ 30.00
	2437		19.35	0.086	19.15	0.082	≤ 30.00
	2452		16.77	0.048	16.80	0.048	≤ 30.00

Note: The relevant measured result has the offset with cable loss already.

Test Mode	Frequency (MHz)	Data Rate	ANT-2		ANT-3		Limit
			Average Output Power		Average Output Power		
			Measurement Results		Measurement Results		
			dBm	W	dBm	W	dBm
Mode 3	2412	6M	18.91	0.078	18.88	0.077	≤ 30.00
	2437		22.78	0.190	22.88	0.194	≤ 30.00
	2462		18.87	0.077	18.75	0.075	≤ 30.00
Mode 4	2412	26M	17.80	0.060	17.84	0.061	≤ 30.00
	2437		21.37	0.137	21.41	0.138	≤ 30.00
	2462		16.84	0.048	16.95	0.050	≤ 30.00
Mode 5	2422	54M	17.70	0.059	17.75	0.060	≤ 30.00
	2437		18.46	0.070	18.35	0.068	≤ 30.00
	2452		15.86	0.039	16.23	0.042	≤ 30.00
Mode 6	2412	26M	17.91	0.062	17.99	0.063	≤ 30.00
	2437		21.43	0.139	21.56	0.143	≤ 30.00
	2462		16.99	0.050	17.09	0.051	≤ 30.00
Mode 7	2422	54M	17.77	0.060	17.83	0.061	≤ 30.00
	2437		18.50	0.071	18.51	0.071	≤ 30.00
	2452		15.96	0.039	16.33	0.043	≤ 30.00
Mode 8	2412	MCS0	18.32	0.068	18.40	0.069	≤ 30.00
	2437		22.35	0.172	22.49	0.177	≤ 30.00
	2462		17.41	0.055	17.42	0.055	≤ 30.00
Mode 9	2422	MCS0	18.08	0.064	18.22	0.066	≤ 30.00
	2437		18.85	0.077	18.81	0.076	≤ 30.00
	2452		16.33	0.043	16.71	0.047	≤ 30.00

Note: The relevant measured result has the offset with cable loss already.

Test Mode	Frequency (MHz)	Data Rate	ANT-0+1+2+3		Limit
			Average Output Power		
			Measurement Results		
			dBm	W	
Mode 3	2412	6M	24.93	0.311	≤ 30.00
	2437		29.06	0.805	≤ 30.00
	2462		25.05	0.320	≤ 30.00
Mode 4	2412	26M	24.02	0.252	≤ 30.00
	2437		27.70	0.589	≤ 30.00
	2462		23.15	0.207	≤ 30.00
Mode 5	2422	54M	23.77	0.238	≤ 30.00
	2437		24.66	0.292	≤ 30.00
	2452		22.22	0.167	≤ 30.00
Mode 6	2412	26M	24.12	0.258	≤ 30.00
	2437		27.78	0.600	≤ 30.00
	2462		23.28	0.213	≤ 30.00
Mode 7	2422	54M	23.86	0.243	≤ 30.00
	2437		24.74	0.298	≤ 30.00
	2452		22.30	0.170	≤ 30.00
Mode 8	2412	MCS0	24.48	0.281	≤ 30.00
	2437		28.70	0.741	≤ 30.00
	2462		23.66	0.232	≤ 30.00
Mode 9	2422	MCS0	24.21	0.264	≤ 30.00
	2437		25.07	0.321	≤ 30.00
	2452		22.68	0.185	≤ 30.00

Note: The relevant measured result has the offset with cable loss already.

Beamforming on

Test Mode	Frequency (MHz)	Data Rate	ANT-0		ANT-1		Limit
			Average Output Power		Average Output Power		
			Measurement Results		Measurement Results		
			dBm	W	dBm	W	
Mode 4	2412	26M	16.41	0.044	16.56	0.045	≤ 25.00
	2437		17.50	0.056	17.54	0.057	≤ 25.00
	2462		17.98	0.063	17.42	0.055	≤ 25.00
Mode 5	2422	54M	17.84	0.061	17.59	0.057	≤ 25.00
	2437		17.33	0.054	17.33	0.054	≤ 25.00
	2452		17.96	0.063	17.72	0.059	≤ 25.00
Mode 6	2412	26M	16.53	0.045	16.59	0.046	≤ 25.00
	2437		17.59	0.057	17.67	0.058	≤ 25.00
	2462		18.07	0.064	17.46	0.056	≤ 25.00
Mode 7	2422	54M	17.90	0.062	17.61	0.058	≤ 25.00
	2437		17.42	0.055	17.39	0.055	≤ 25.00
	2452		18.03	0.064	17.79	0.060	≤ 25.00
Mode 8	2412	MCS0	16.63	0.046	16.68	0.047	≤ 25.00
	2437		17.64	0.058	17.70	0.059	≤ 25.00
	2462		18.08	0.064	17.51	0.056	≤ 25.00
Mode 9	2422	MCS0	18.01	0.063	17.74	0.059	≤ 25.00
	2437		17.53	0.057	17.41	0.055	≤ 25.00
	2452		18.10	0.065	17.85	0.061	≤ 25.00

Note: The relevant measured result has the offset with cable loss already.

Test Mode	Frequency (MHz)	Data Rate	ANT-2		ANT-3		Limit
			Average Output Power		Average Output Power		
			Measurement Results		Measurement Results		
			dBm	W	dBm	W	
Mode 4	2412	26M	16.83	0.048	16.34	0.043	≤ 25.00
	2437		17.83	0.061	17.57	0.057	≤ 25.00
	2462		18.00	0.063	17.54	0.057	≤ 25.00
Mode 5	2422	54M	17.62	0.058	17.98	0.063	≤ 25.00
	2437		17.69	0.059	17.21	0.053	≤ 25.00
	2452		17.74	0.059	17.46	0.056	≤ 25.00
Mode 6	2412	26M	16.90	0.049	16.44	0.044	≤ 25.00
	2437		17.89	0.062	17.63	0.058	≤ 25.00
	2462		18.09	0.064	17.62	0.058	≤ 25.00
Mode 7	2422	54M	17.75	0.060	18.03	0.064	≤ 25.00
	2437		17.74	0.059	17.34	0.054	≤ 25.00
	2452		17.83	0.061	17.49	0.056	≤ 25.00
Mode 8	2412	MCS0	17.01	0.050	16.52	0.045	≤ 25.00
	2437		18.01	0.063	17.66	0.058	≤ 25.00
	2462		18.12	0.065	17.71	0.059	≤ 25.00
Mode 9	2422	MCS0	17.82	0.061	18.05	0.064	≤ 25.00
	2437		17.75	0.060	17.40	0.055	≤ 25.00
	2452		17.92	0.062	17.61	0.058	≤ 25.00

Note: The relevant measured result has the offset with cable loss already.

Test Mode	Frequency (MHz)	Data Rate	ANT-0+1+2+3		Limit
			Average Output Power		
			Measurement Results		
			dBm	W	
Mode 4	2412	26M	22.56	0.180	≤ 25.00
	2437		23.63	0.231	≤ 25.00
	2462		23.76	0.238	≤ 25.00
Mode 5	2422	54M	23.78	0.239	≤ 25.00
	2437		23.41	0.219	≤ 25.00
	2452		23.74	0.237	≤ 25.00
Mode 6	2412	26M	22.64	0.184	≤ 25.00
	2437		23.72	0.236	≤ 25.00
	2462		23.84	0.242	≤ 25.00
Mode 7	2422	54M	23.85	0.243	≤ 25.00
	2437		23.50	0.224	≤ 25.00
	2452		23.81	0.240	≤ 25.00
Mode 8	2412	MCS0	22.73	0.187	≤ 25.00
	2437		23.78	0.239	≤ 25.00
	2462		23.88	0.244	≤ 25.00
Mode 9	2422	MCS0	23.93	0.247	≤ 25.00
	2437		23.55	0.226	≤ 25.00
	2452		23.89	0.245	≤ 25.00

Note: The relevant measured result has the offset with cable loss already.

6 dB RF Bandwidth Measurement

ANT-0			
Test Mode	Frequency (MHz)	Measurement (kHz)	Limit (kHz)
Mode 2	2412	7548	≥ 500
	2437	7122	≥ 500
	2462	7610	≥ 500
Mode 3	2412	16080	≥ 500
	2437	16290	≥ 500
	2462	16100	≥ 500
Mode 8	2412	18890	≥ 500
	2437	18900	≥ 500
	2462	18850	≥ 500
Mode 9	2422	37890	≥ 500
	2437	37830	≥ 500
	2452	37530	≥ 500

ANT-1			
Test Mode	Frequency (MHz)	Measurement (kHz)	Limit (kHz)
Mode 3	2412	16090	≥ 500
	2437	16090	≥ 500
	2462	16110	≥ 500
Mode 8	2412	18720	≥ 500
	2437	18870	≥ 500
	2462	18940	≥ 500
Mode 9	2422	37450	≥ 500
	2437	37800	≥ 500
	2452	37720	≥ 500

ANT-2			
Test Mode	Frequency (MHz)	Measurement (kHz)	Limit (kHz)
Mode 3	2412	15920	≥ 500
	2437	15970	≥ 500
	2462	15920	≥ 500
Mode 8	2412	18120	≥ 500
	2437	18880	≥ 500
	2462	18540	≥ 500
Mode 9	2422	37940	≥ 500
	2437	37990	≥ 500
	2452	37920	≥ 500

ANT-3			
Test Mode	Frequency (MHz)	Measurement (kHz)	Limit (kHz)
Mode 3	2412	16360	≥ 500
	2437	15960	≥ 500
	2462	16360	≥ 500
Mode 8	2412	18830	≥ 500
	2437	18860	≥ 500
	2462	18920	≥ 500
Mode 9	2422	37920	≥ 500
	2437	37630	≥ 500
	2452	37830	≥ 500

Beamforming on

ANT-0			
Test Mode	Frequency (MHz)	Measurement (kHz)	Limit (kHz)
Mode 8	2412	17640	≥ 500
	2437	16350	≥ 500
	2462	16340	≥ 500
Mode 9	2412	37430	≥ 500
	2437	37000	≥ 500
	2462	36110	≥ 500

ANT-1			
Test Mode	Frequency (MHz)	Measurement (kHz)	Limit (kHz)
Mode 8	2412	15940	≥ 500
	2437	17320	≥ 500
	2462	16340	≥ 500
Mode 9	2412	37760	≥ 500
	2437	37610	≥ 500
	2462	37570	≥ 500

ANT-2			
Test Mode	Frequency (MHz)	Measurement (kHz)	Limit (kHz)
Mode 8	2412	16640	≥ 500
	2437	17600	≥ 500
	2462	16350	≥ 500
Mode 9	2412	38120	≥ 500
	2437	37410	≥ 500
	2462	37520	≥ 500

ANT-3			
Test Mode	Frequency (MHz)	Measurement (kHz)	Limit (kHz)
Mode 8	2412	18610	≥ 500
	2437	17520	≥ 500
	2462	16790	≥ 500
Mode 9	2412	37320	≥ 500
	2437	37890	≥ 500
	2462	37840	≥ 500

■ Test Graphs

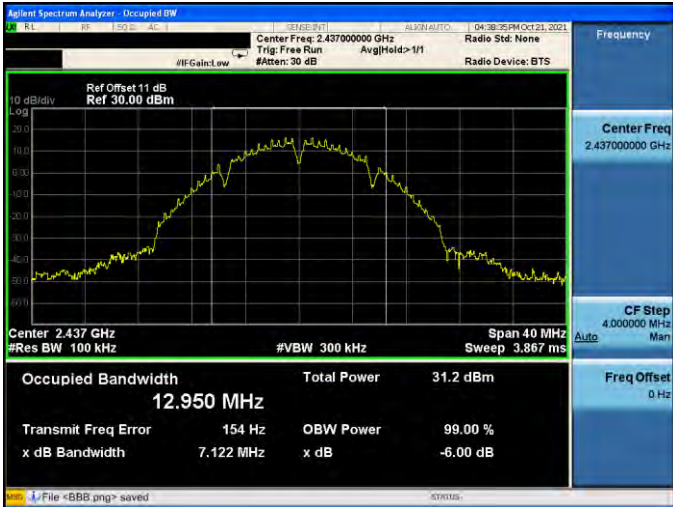
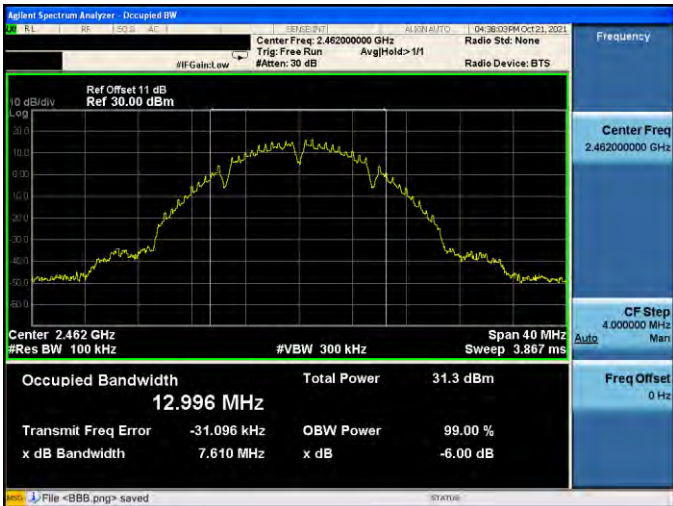
Mode 2: IEEE 802.11b Continuous TX mode_ANT-0																			
2412 MHz	 <p>Agilent Spectrum Analyzer - Occupied BW</p> <p>Center Freq: 2.412000000 GHz Trig: Free Run #Atten: 30 dB AvgHold: 1/1 Radio Std: None Radio Device: BTS</p> <p>Ref Offset: 11 dB Ref: 30.00 dBm</p> <p>Center 2.412 GHz #Res BW 100 kHz #VBW 300 kHz Span 40 MHz Sweep 3.867 ms</p> <table border="1"> <tr> <td>Occupied Bandwidth</td> <td>Total Power</td> <td>31.0 dBm</td> </tr> <tr> <td>13.005 MHz</td> <td></td> <td></td> </tr> <tr> <td>Transmit Freq Error</td> <td>OBW Power</td> <td>99.00 %</td> </tr> <tr> <td>47.794 kHz</td> <td>x dB</td> <td>-6.00 dB</td> </tr> <tr> <td>x dB Bandwidth</td> <td></td> <td></td> </tr> <tr> <td>7.548 MHz</td> <td></td> <td></td> </tr> </table> <p>File <BBB.png> saved</p>	Occupied Bandwidth	Total Power	31.0 dBm	13.005 MHz			Transmit Freq Error	OBW Power	99.00 %	47.794 kHz	x dB	-6.00 dB	x dB Bandwidth			7.548 MHz		
Occupied Bandwidth	Total Power	31.0 dBm																	
13.005 MHz																			
Transmit Freq Error	OBW Power	99.00 %																	
47.794 kHz	x dB	-6.00 dB																	
x dB Bandwidth																			
7.548 MHz																			
2437 MHz	 <p>Agilent Spectrum Analyzer - Occupied BW</p> <p>Center Freq: 2.437000000 GHz Trig: Free Run #Atten: 30 dB AvgHold: 1/1 Radio Std: None Radio Device: BTS</p> <p>Ref Offset: 11 dB Ref: 30.00 dBm</p> <p>Center 2.437 GHz #Res BW 100 kHz #VBW 300 kHz Span 40 MHz Sweep 3.867 ms</p> <table border="1"> <tr> <td>Occupied Bandwidth</td> <td>Total Power</td> <td>31.2 dBm</td> </tr> <tr> <td>12.950 MHz</td> <td></td> <td></td> </tr> <tr> <td>Transmit Freq Error</td> <td>OBW Power</td> <td>99.00 %</td> </tr> <tr> <td>154 Hz</td> <td>x dB</td> <td>-6.00 dB</td> </tr> <tr> <td>x dB Bandwidth</td> <td></td> <td></td> </tr> <tr> <td>7.122 MHz</td> <td></td> <td></td> </tr> </table> <p>File <BBB.png> saved</p>	Occupied Bandwidth	Total Power	31.2 dBm	12.950 MHz			Transmit Freq Error	OBW Power	99.00 %	154 Hz	x dB	-6.00 dB	x dB Bandwidth			7.122 MHz		
Occupied Bandwidth	Total Power	31.2 dBm																	
12.950 MHz																			
Transmit Freq Error	OBW Power	99.00 %																	
154 Hz	x dB	-6.00 dB																	
x dB Bandwidth																			
7.122 MHz																			
2462 MHz	 <p>Agilent Spectrum Analyzer - Occupied BW</p> <p>Center Freq: 2.462000000 GHz Trig: Free Run #Atten: 30 dB AvgHold: 1/1 Radio Std: None Radio Device: BTS</p> <p>Ref Offset: 11 dB Ref: 30.00 dBm</p> <p>Center 2.462 GHz #Res BW 100 kHz #VBW 300 kHz Span 40 MHz Sweep 3.867 ms</p> <table border="1"> <tr> <td>Occupied Bandwidth</td> <td>Total Power</td> <td>31.3 dBm</td> </tr> <tr> <td>12.996 MHz</td> <td></td> <td></td> </tr> <tr> <td>Transmit Freq Error</td> <td>OBW Power</td> <td>99.00 %</td> </tr> <tr> <td>-31.096 kHz</td> <td>x dB</td> <td>-6.00 dB</td> </tr> <tr> <td>x dB Bandwidth</td> <td></td> <td></td> </tr> <tr> <td>7.610 MHz</td> <td></td> <td></td> </tr> </table> <p>File <BBB.png> saved</p>	Occupied Bandwidth	Total Power	31.3 dBm	12.996 MHz			Transmit Freq Error	OBW Power	99.00 %	-31.096 kHz	x dB	-6.00 dB	x dB Bandwidth			7.610 MHz		
Occupied Bandwidth	Total Power	31.3 dBm																	
12.996 MHz																			
Transmit Freq Error	OBW Power	99.00 %																	
-31.096 kHz	x dB	-6.00 dB																	
x dB Bandwidth																			
7.610 MHz																			

Mode 3: IEEE 802.11g Continuous TX mode_ANT-0

2412 MHz

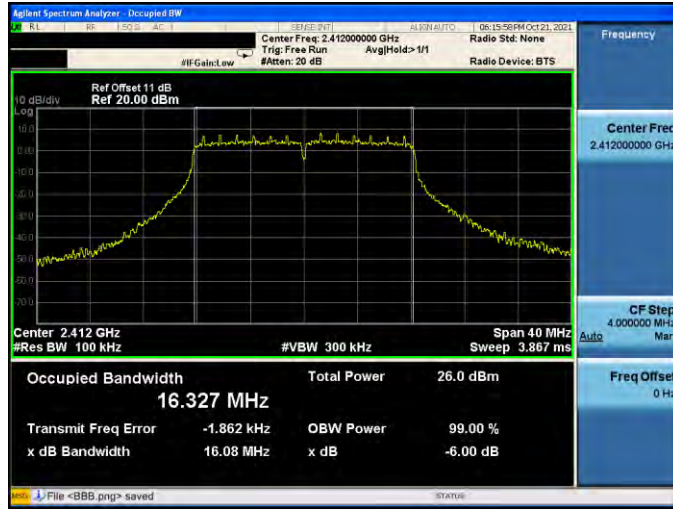

2437 MHz

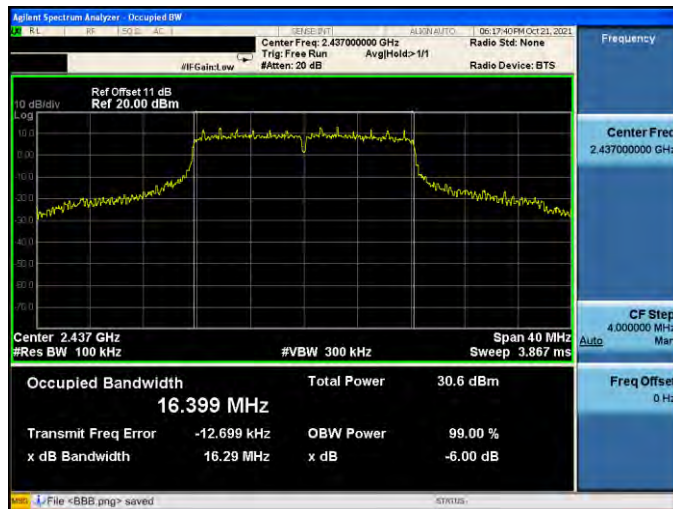

2462 MHz



Mode 8: IEEE 802.11ax 2.4 GHz 20 MHz Continuous TX mode_ANT-0

2412 MHz

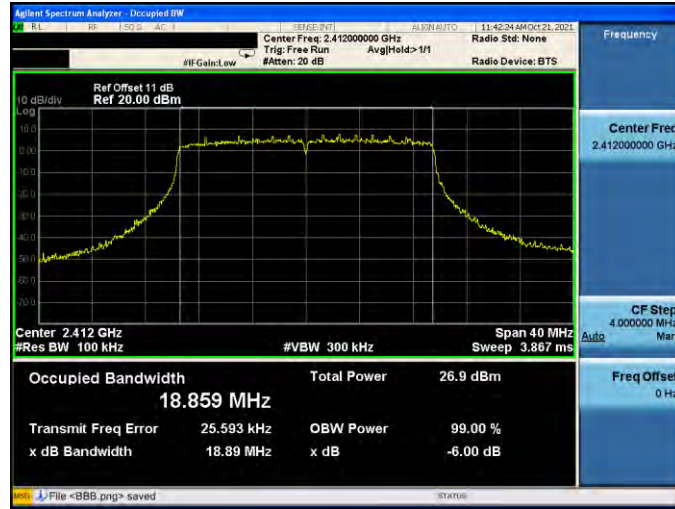

2437 MHz

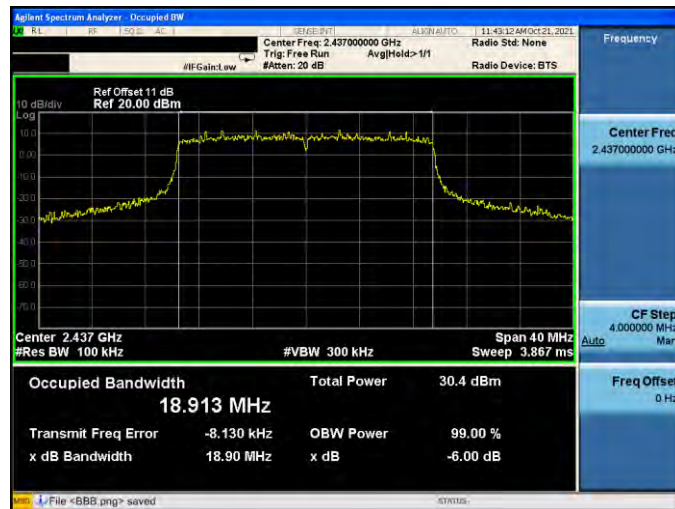

2462 MHz

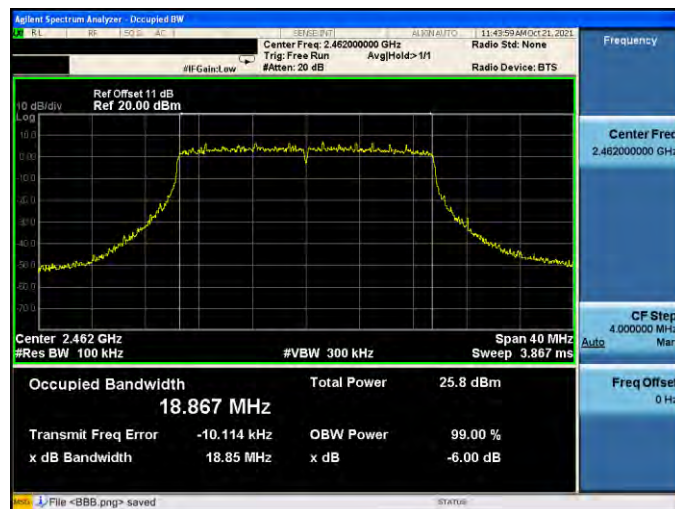

Mode 9: IEEE 802.11ax 2.4 GHz 40 MHz Continuous TX mode_ANT-0

2422 MHz

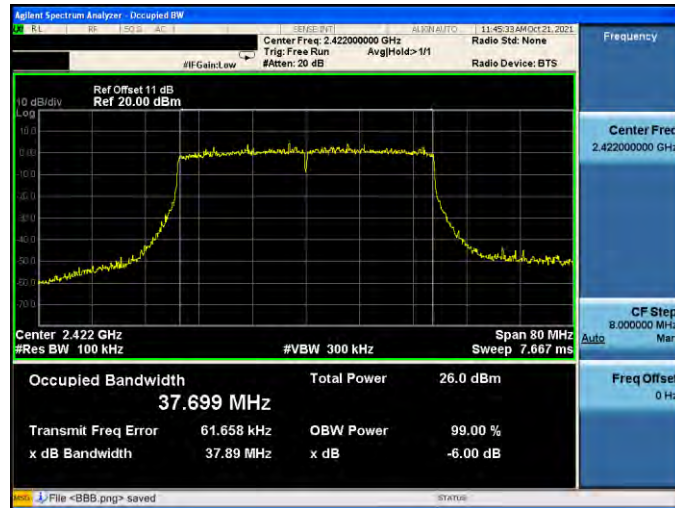

2437 MHz

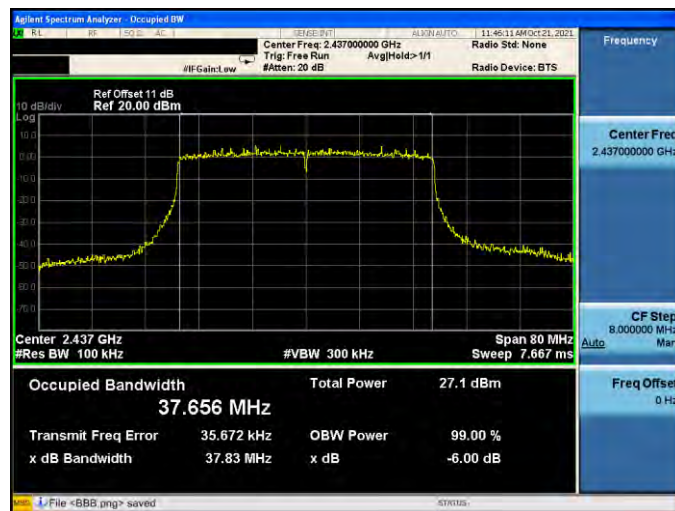

2452 MHz

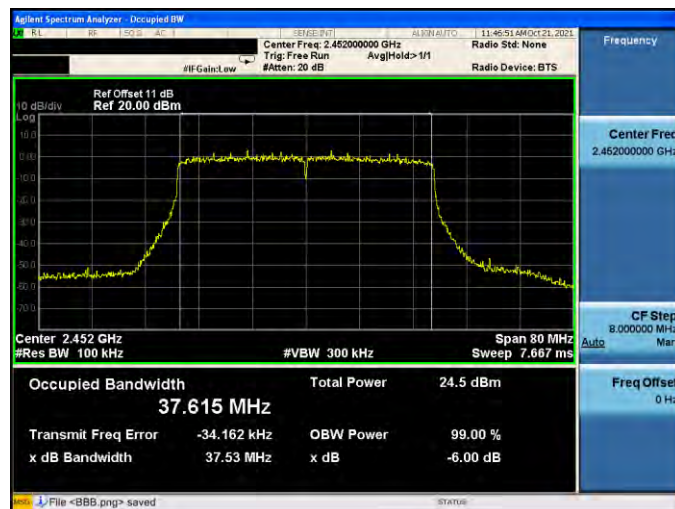

Mode 3: IEEE 802.11g Continuous TX mode_ANT-1

2412 MHz



2437 MHz

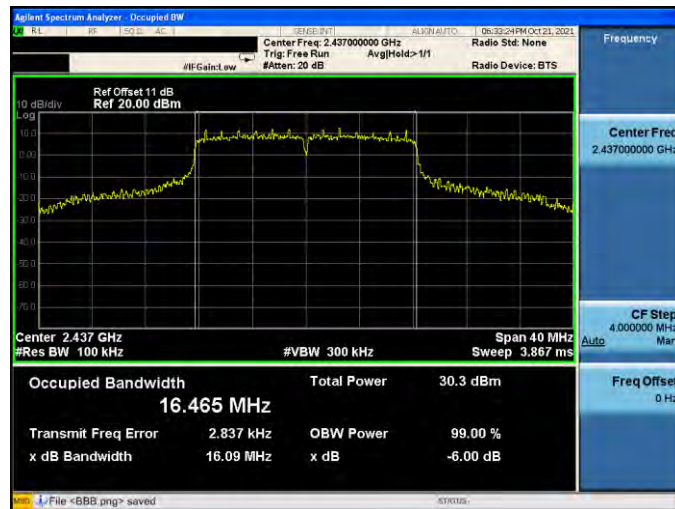

2462 MHz

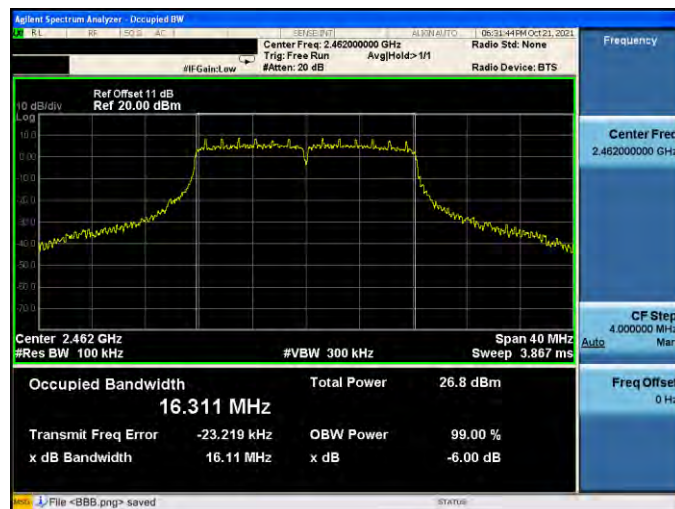

Mode 8: IEEE 802.11ax 2.4 GHz 20 MHz Continuous TX mode_ANT-1

2412 MHz



2437 MHz



2462 MHz

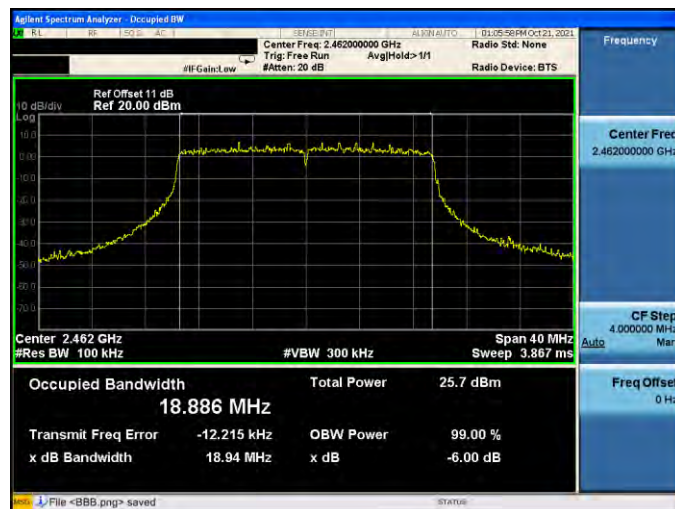

Mode 9: IEEE 802.11ax 2.4 GHz 40 MHz Continuous TX mode_ANT-1

2422 MHz



2437 MHz

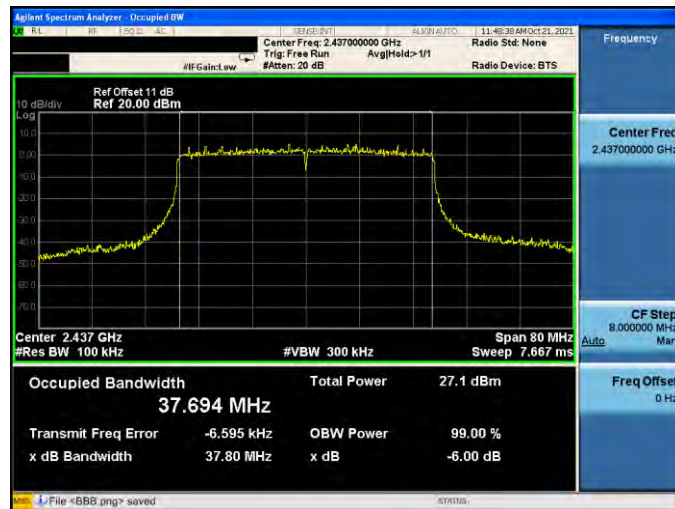

2452 MHz

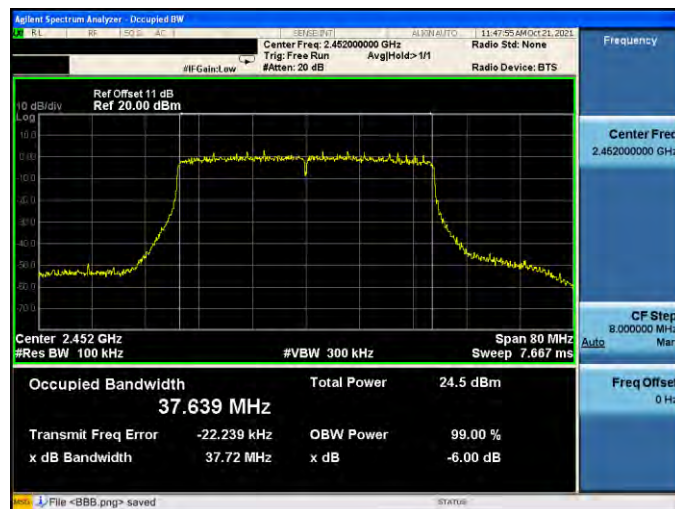

Mode 3: IEEE 802.11g Continuous TX mode_ANT-2

2412 MHz

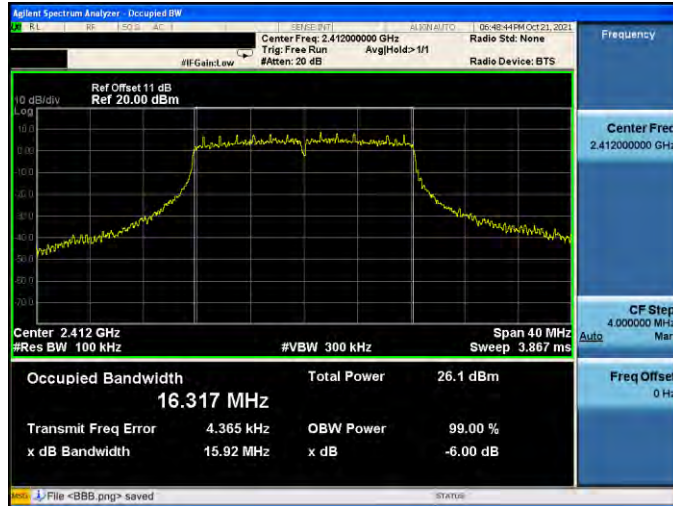

2437 MHz

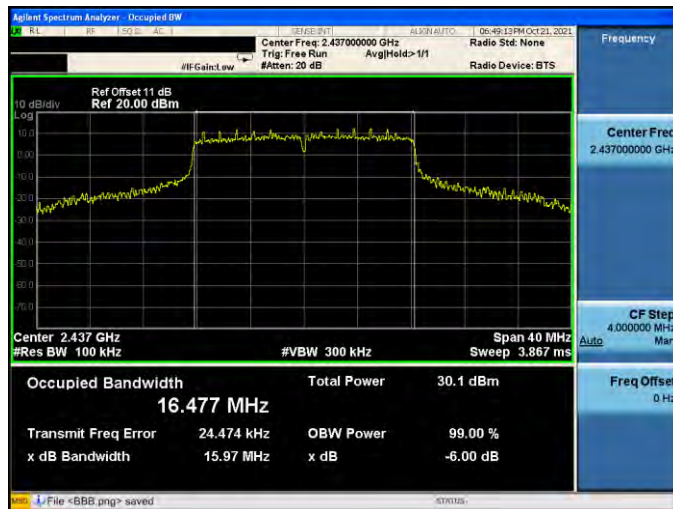

2462 MHz

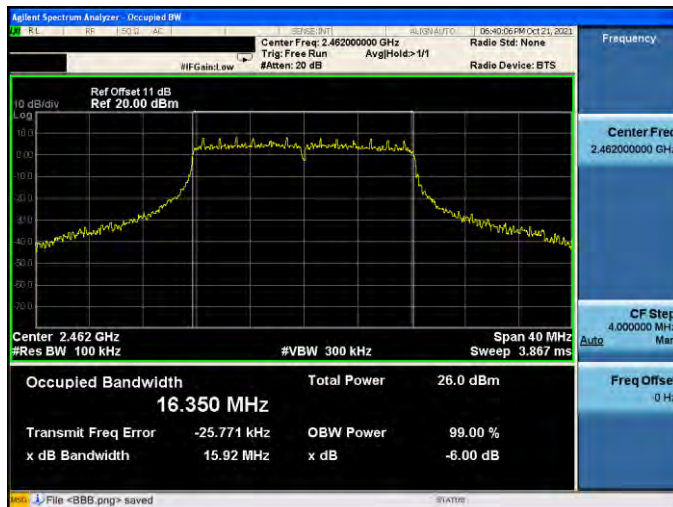

Mode 8: IEEE 802.11ax 2.4 GHz 20 MHz Continuous TX mode_ANT-2

2412 MHz

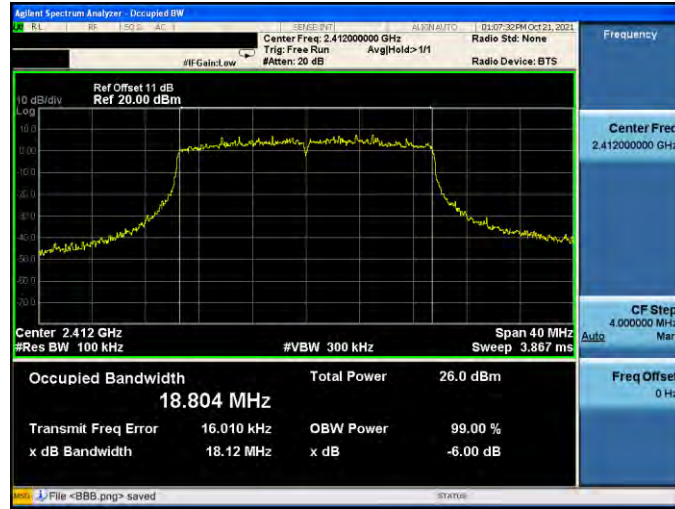

2437 MHz

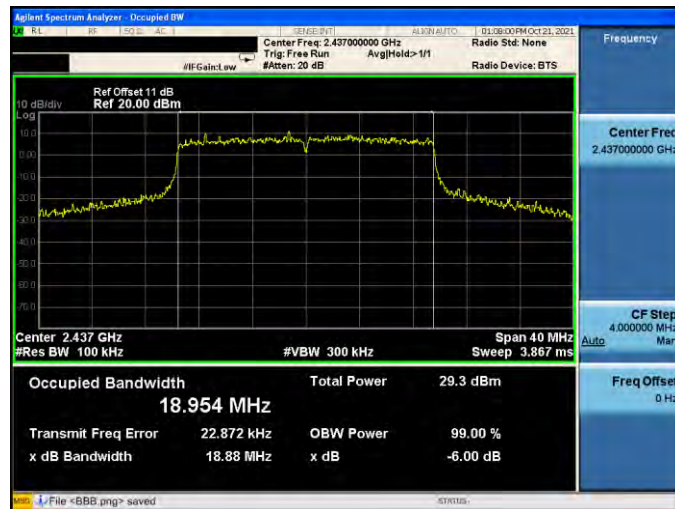

2462 MHz

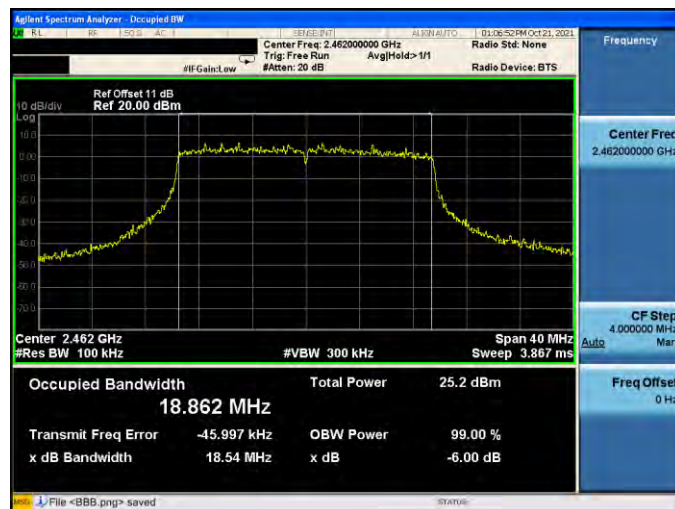

Mode 9: IEEE 802.11ax 2.4 GHz 40 MHz Continuous TX mode_ANT-2

2422 MHz



2437 MHz

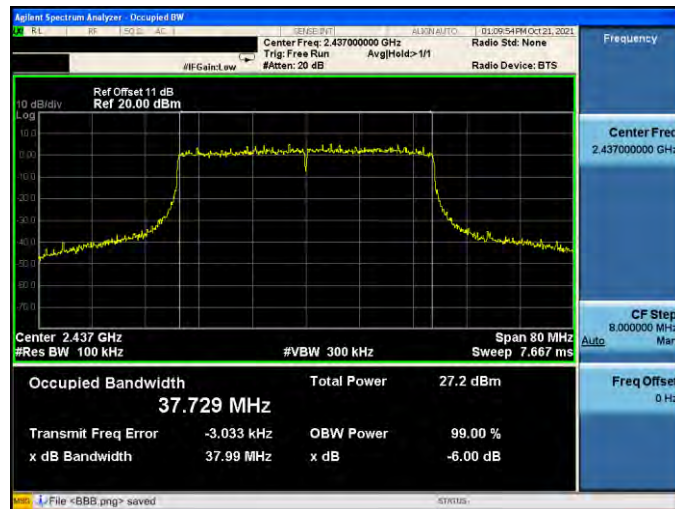

2452 MHz

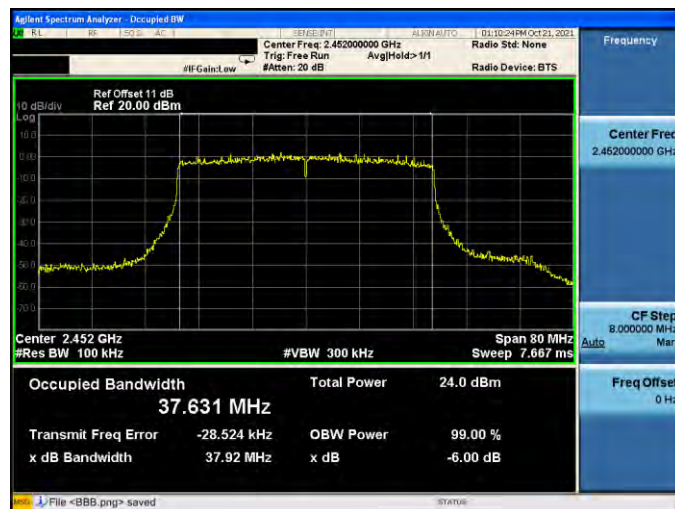

Mode 3: IEEE 802.11g Continuous TX mode_ANT-3

2412 MHz

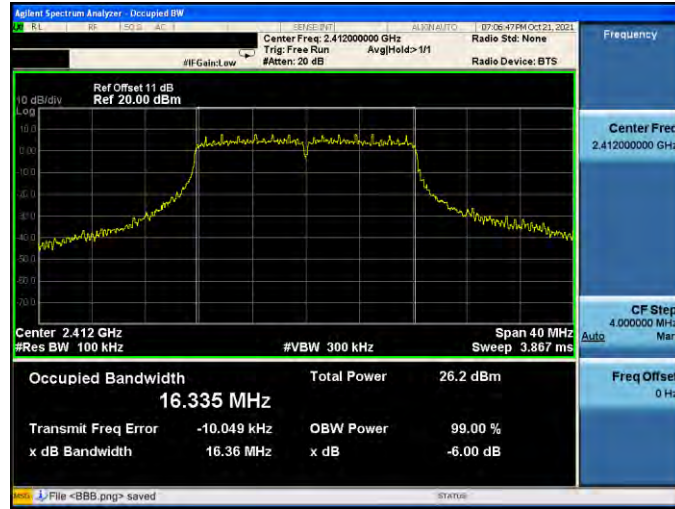

2437 MHz

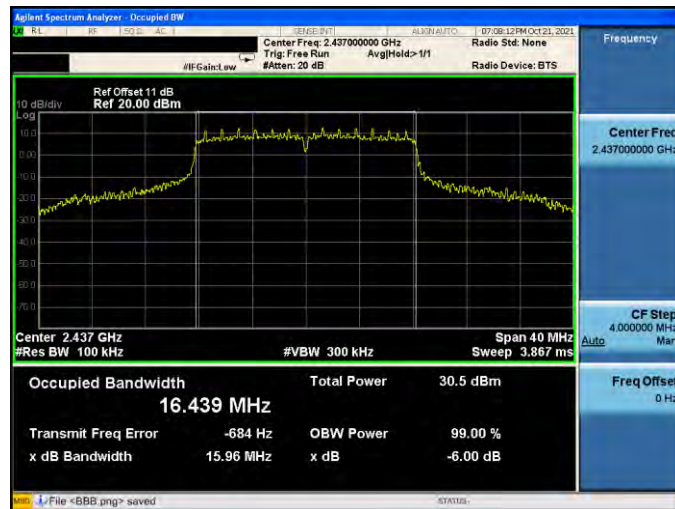

2462 MHz

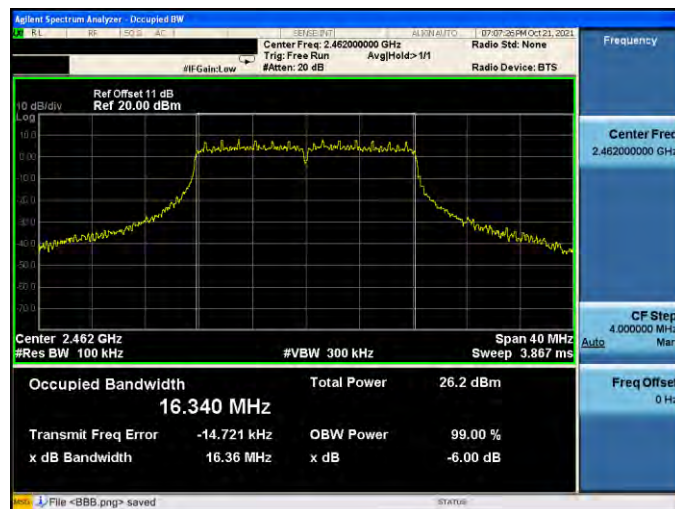

Mode 8: IEEE 802.11ax 2.4 GHz 20 MHz Continuous TX mode_ANT-3

2412 MHz

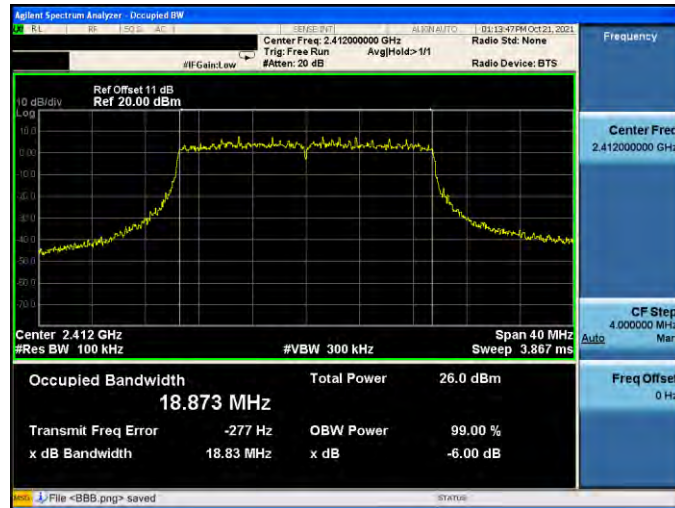

2437 MHz

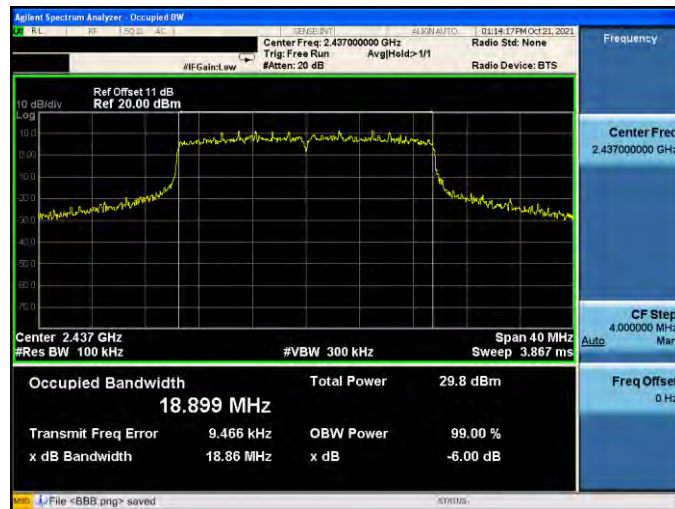

2462 MHz



Mode 9: IEEE 802.11ax 2.4 GHz 40 MHz Continuous TX mode_ANT-3

2422 MHz

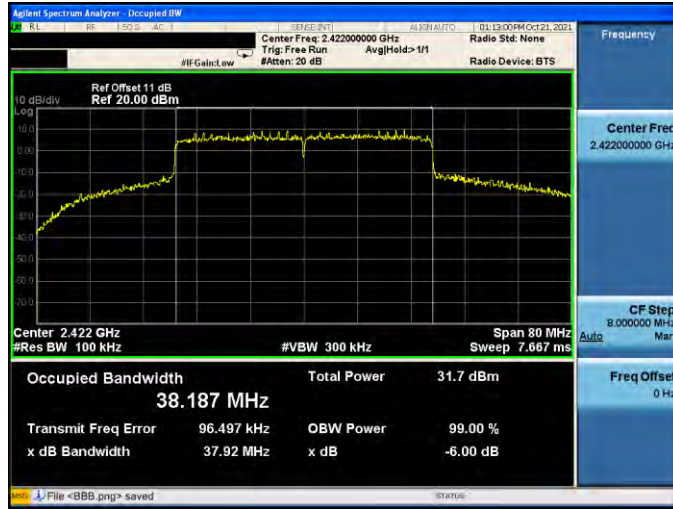

2437 MHz



2452 MHz

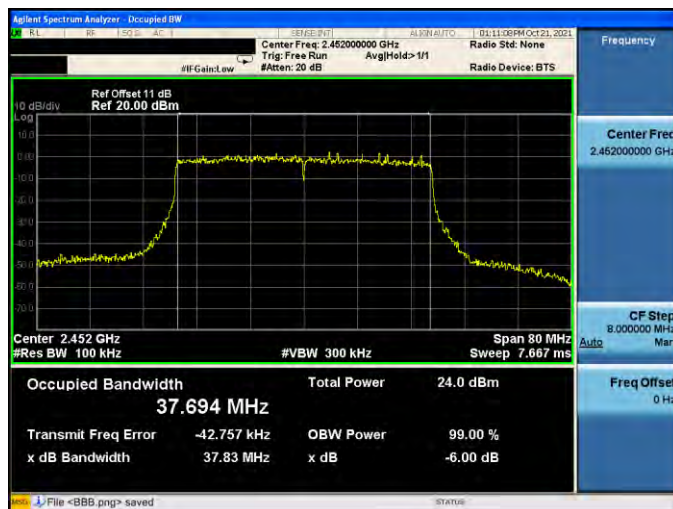

Beamforming on

Mode 8: IEEE 802.11ax 2.4 GHz 20 MHz Continuous TX mode_ANT-0

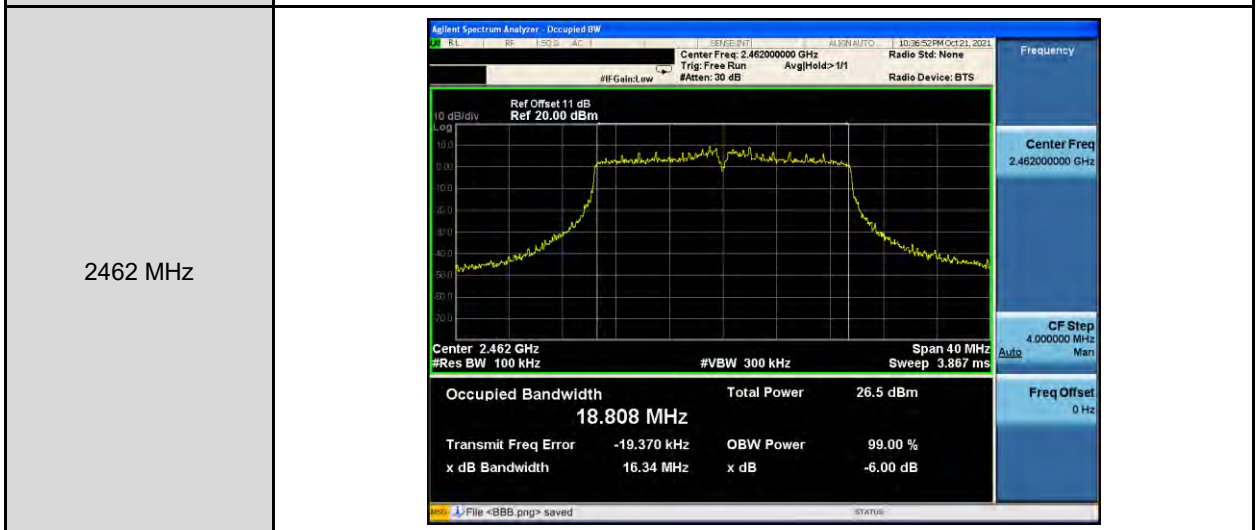
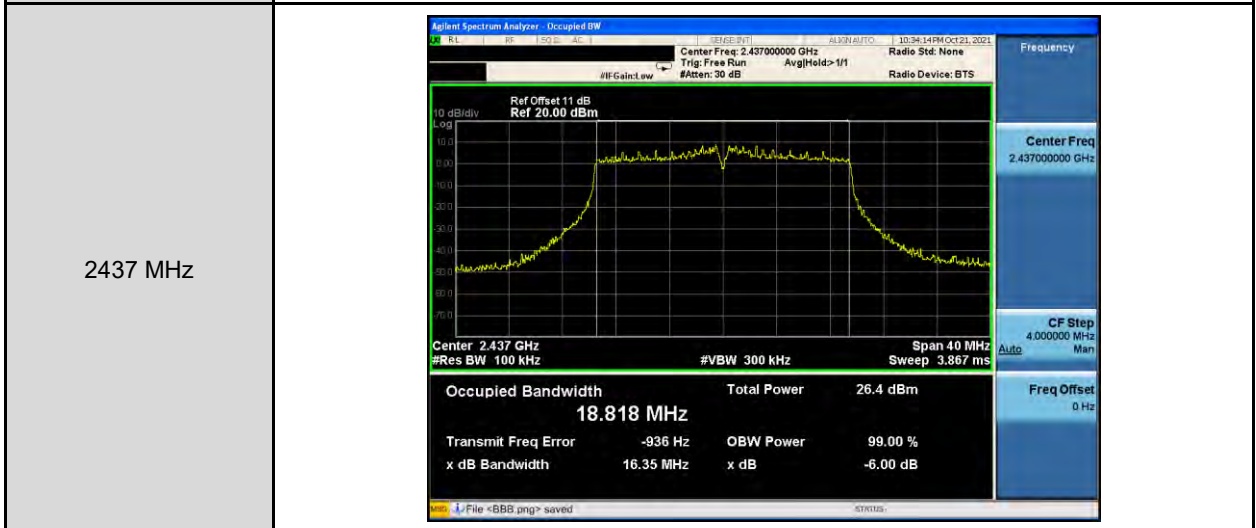
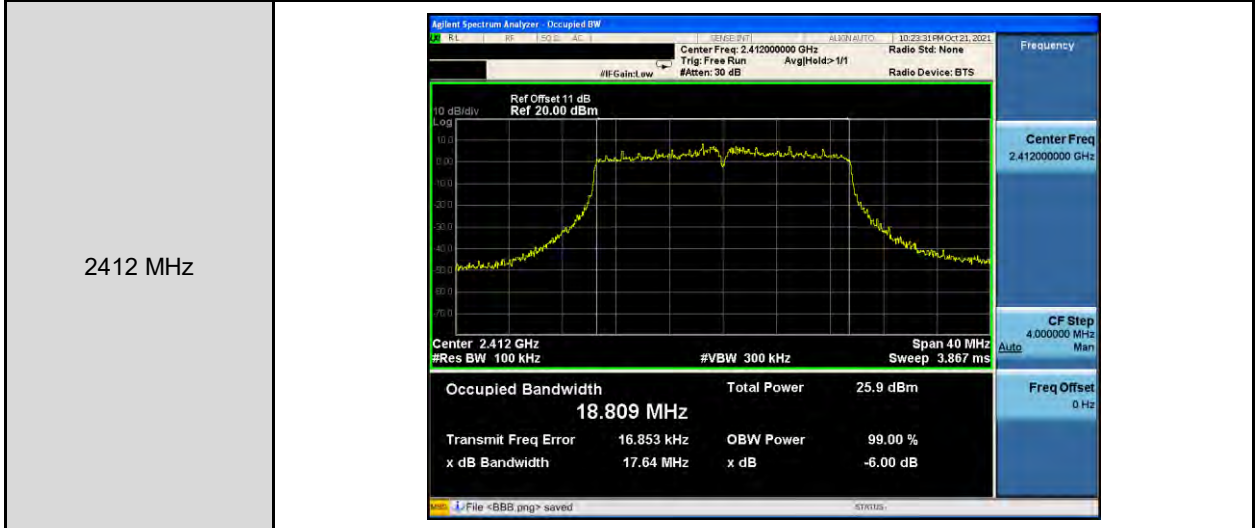

Mode 9: IEEE 802.11ax 2.4 GHz 40 MHz Continuous TX mode_ANT-0

2422 MHz

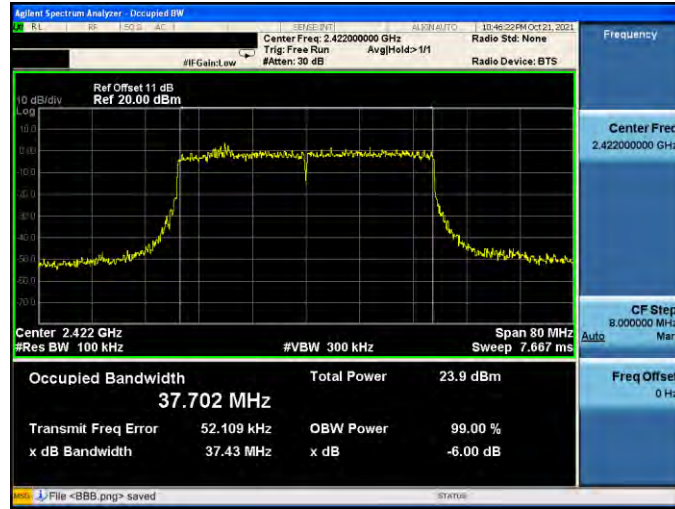

2437 MHz

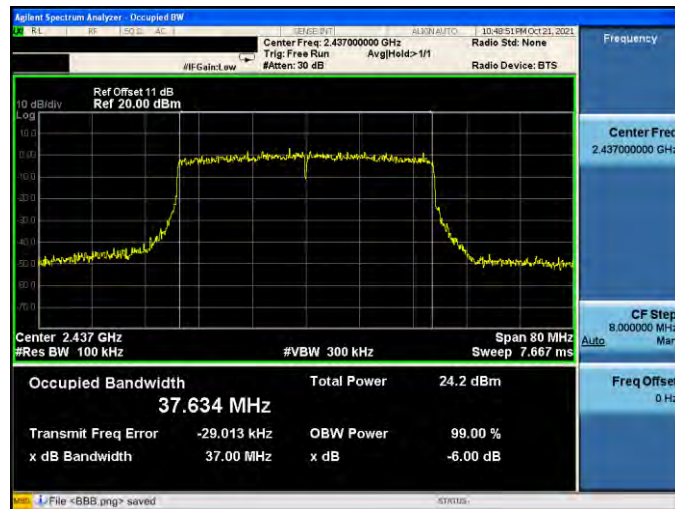

2452 MHz

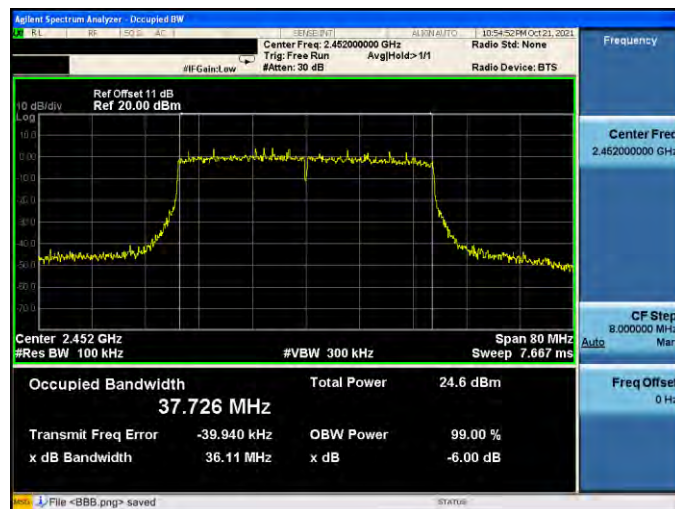

Mode 8: IEEE 802.11ax 2.4 GHz 20 MHz Continuous TX mode_ANT-1

2412 MHz

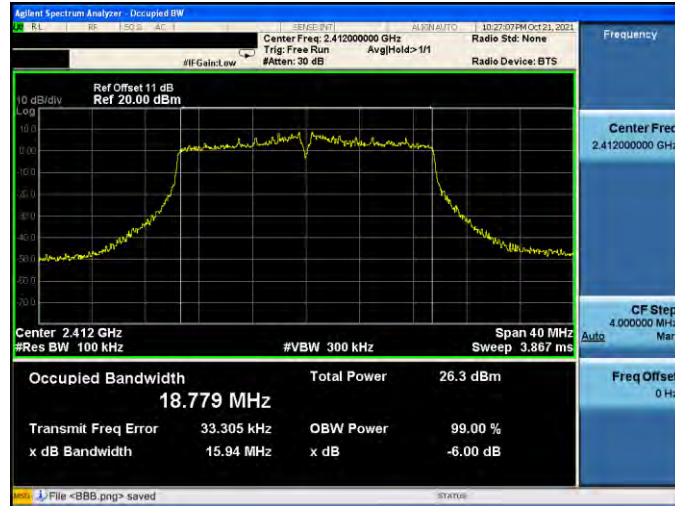

2437 MHz



2462 MHz



Mode 9: IEEE 802.11ax 2.4 GHz 40 MHz Continuous TX mode_ANT-1

2422 MHz

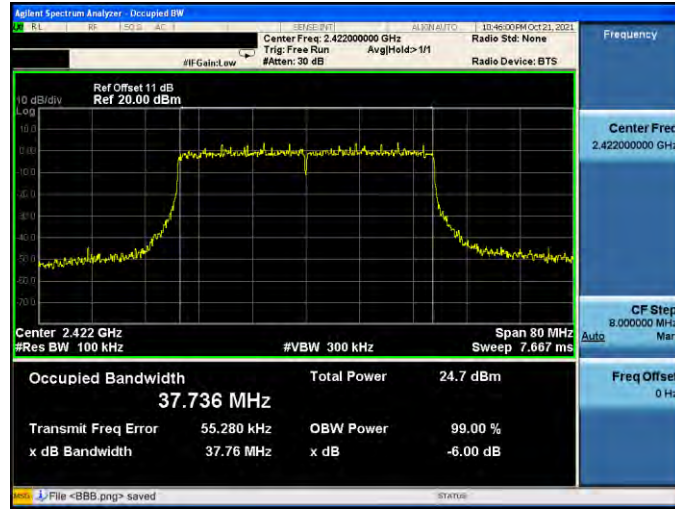

2437 MHz

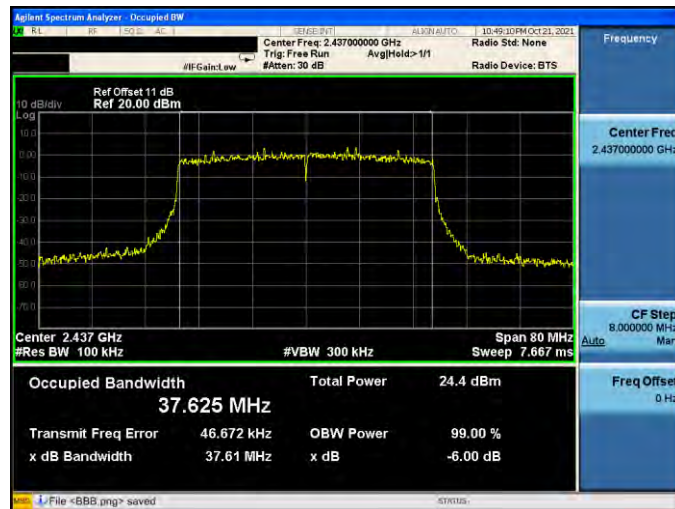

2452 MHz

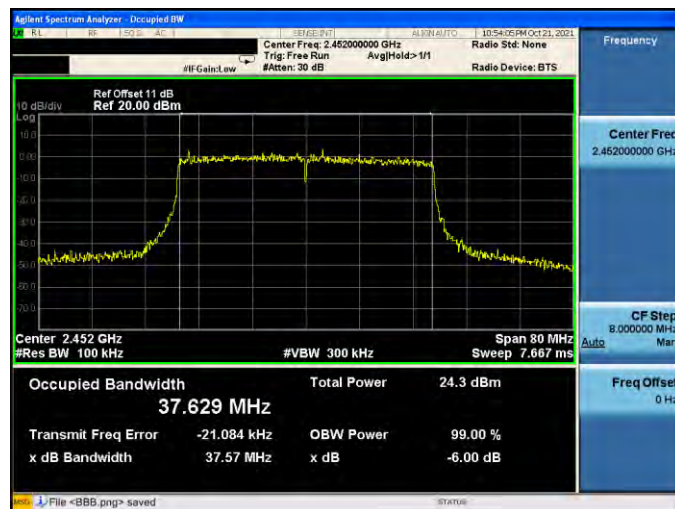

Mode 8: IEEE 802.11ax 2.4 GHz 20 MHz Continuous TX mode_ANT-2

2412 MHz



2437 MHz



2462 MHz



Mode 9: IEEE 802.11ax 2.4 GHz 40 MHz Continuous TX mode_ANT-2

2422 MHz

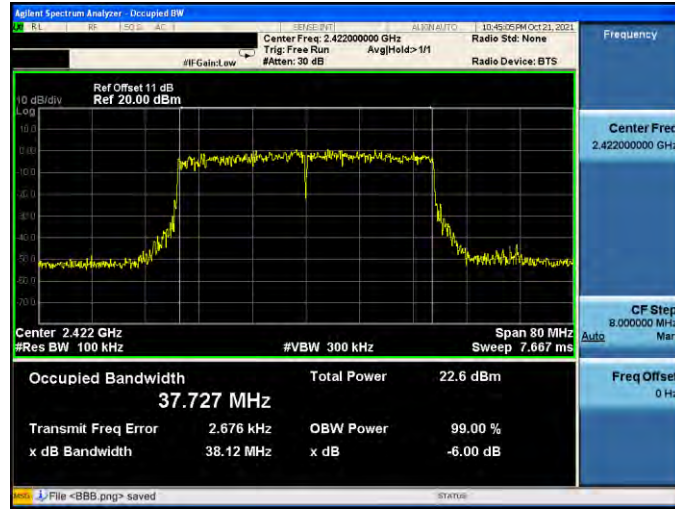

2437 MHz

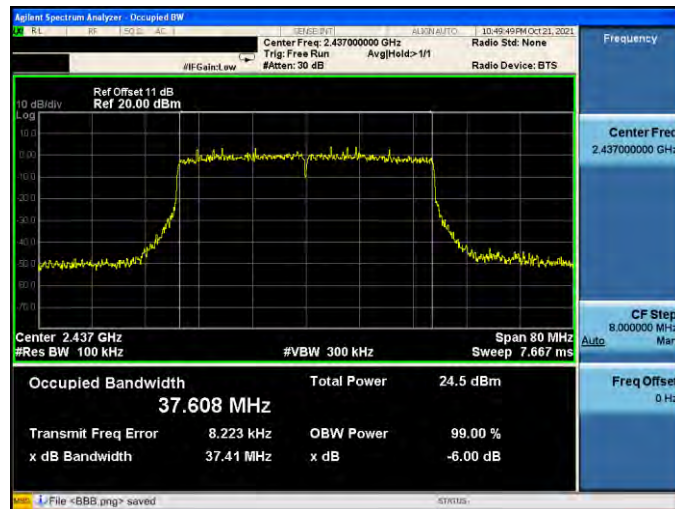

2452 MHz

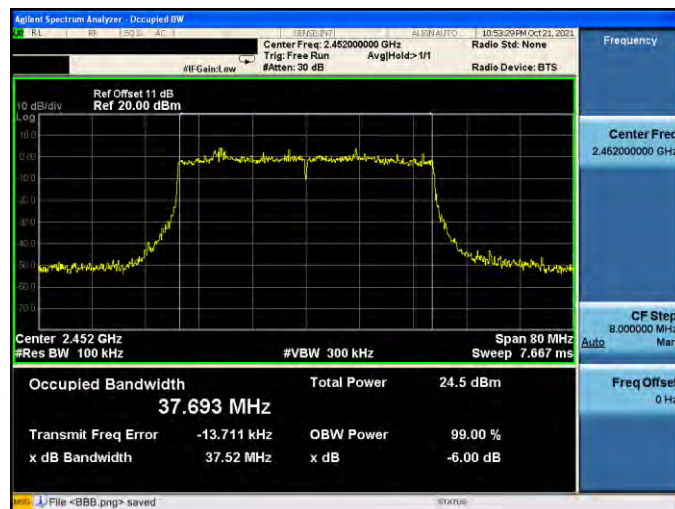

Mode 8: IEEE 802.11ax 2.4 GHz 20 MHz Continuous TX mode_ANT-3

2412 MHz



2437 MHz



2462 MHz



Mode 9: IEEE 802.11ax 2.4 GHz 40 MHz Continuous TX mode_ANT-3

2422 MHz

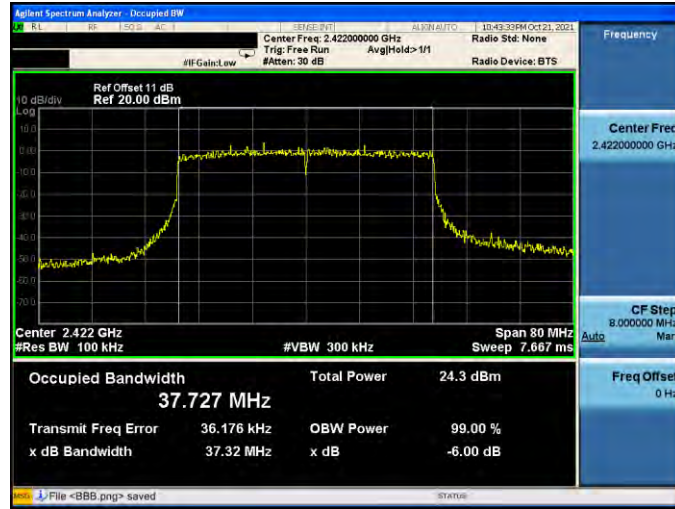

2437 MHz

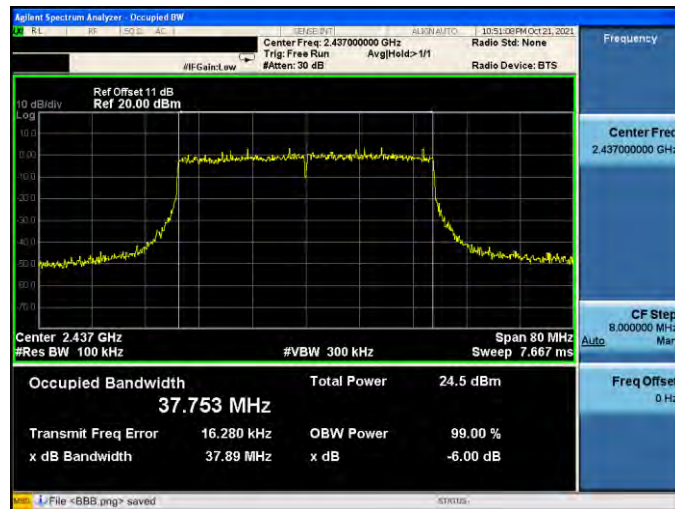

2452 MHz

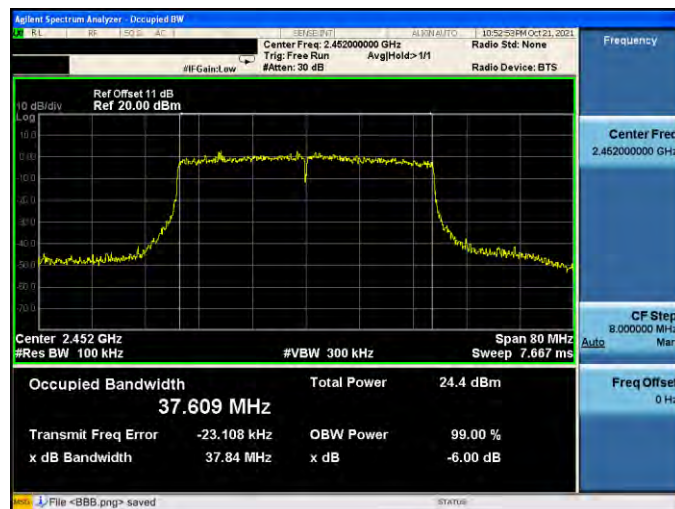

Maximum Power Spectral Density Measurement

ANT-0			
Test Mode	Frequency (MHz)	Measurement (dBm/3 kHz)	Limit (dBm/ 3 kHz)
Mode 2	2412	1.244	≤ 8.00
	2437	0.799	≤ 8.00
	2462	1.477	≤ 8.00
Mode 3	2412	-7.879	≤ 3.00
	2437	-3.836	≤ 3.00
	2462	-7.599	≤ 3.00
Mode 8	2412	-7.617	≤ 3.00
	2437	-4.038	≤ 3.00
	2462	-8.538	≤ 3.00
Mode 9	2422	-10.365	≤ 3.00
	2437	-9.170	≤ 3.00
	2452	-11.795	≤ 3.00

ANT-1			
Test Mode	Frequency (MHz)	Measurement (dBm/3 kHz)	Limit (dBm/ 3 kHz)
Mode 3	2412	-7.423	≤ 3.00
	2437	-3.688	≤ 3.00
	2462	-7.052	≤ 3.00
Mode 8	2412	-7.947	≤ 3.00
	2437	-3.934	≤ 3.00
	2462	-7.590	≤ 3.00
Mode 9	2422	-10.094	≤ 3.00
	2437	-10.152	≤ 3.00
	2452	-11.938	≤ 3.00

ANT-2			
Test Mode	Frequency (MHz)	Measurement (dBm/3 kHz)	Limit (dBm/ 3 kHz)
Mode 3	2412	-8.560	≤ 3.00
	2437	-4.078	≤ 3.00
	2462	-7.602	≤ 3.00
Mode 8	2412	-7.943	≤ 3.00
	2437	-3.438	≤ 3.00
	2462	-8.939	≤ 3.00
Mode 9	2422	-11.104	≤ 3.00
	2437	-8.960	≤ 3.00
	2452	-11.662	≤ 3.00

ANT-2			
Test Mode	Frequency (MHz)	Measurement (dBm/3 kHz)	Limit (dBm/ 3 kHz)
Mode 3	2412	-8.692	≤ 3.00
	2437	-3.744	≤ 3.00
	2462	-8.509	≤ 3.00
Mode 8	2412	-7.809	≤ 3.00
	2437	-3.493	≤ 3.00
	2462	-8.478	≤ 3.00
Mode 9	2422	-9.209	≤ 3.00
	2437	-10.489	≤ 3.00
	2452	-11.936	≤ 3.00

ANT-0+1+2+3			
Test Mode	Frequency (MHz)	Measurement (dBm/3 kHz)	Limit (dBm/ 3 kHz)
Mode 3	2412	-2.087	≤ 3.00
	2437	2.187	≤ 3.00
	2462	-1.639	≤ 3.00
Mode 8	2412	-1.806	≤ 3.00
	2437	2.303	≤ 3.00
	2462	-2.337	≤ 3.00
Mode 9	2422	-4.119	≤ 3.00
	2437	-3.625	≤ 3.00
	2452	-5.811	≤ 3.00

Beamforming on

ANT-0			
Test Mode	Frequency (MHz)	Measurement (dBm/3 kHz)	Limit (dBm/ 3 kHz)
Mode 8	2412	-6.184	≤ 3.00
	2437	-6.271	≤ 3.00
	2462	-5.166	≤ 3.00
Mode 9	2422	-6.852	≤ 3.00
	2437	-6.173	≤ 3.00
	2452	-7.196	≤ 3.00

ANT-1			
Test Mode	Frequency (MHz)	Measurement (dBm/3 kHz)	Limit (dBm/ 3 kHz)
Mode 8	2412	-5.904	≤ 3.00
	2437	-6.553	≤ 3.00
	2462	-6.410	≤ 3.00
Mode 9	2422	-7.279	≤ 3.00
	2437	-6.491	≤ 3.00
	2452	-6.713	≤ 3.00

ANT-2			
Test Mode	Frequency (MHz)	Measurement (dBm/3 kHz)	Limit (dBm/ 3 kHz)
Mode 8	2412	-6.492	≤ 3.00
	2437	-5.265	≤ 3.00
	2462	-6.030	≤ 3.00
Mode 9	2422	-6.080	≤ 3.00
	2437	-6.129	≤ 3.00
	2452	-7.256	≤ 3.00

ANT-3			
Test Mode	Frequency (MHz)	Measurement (dBm/3 kHz)	Limit (dBm/ 3 kHz)
Mode 8	2412	-6.690	≤ 3.00
	2437	-5.841	≤ 3.00
	2462	-5.745	≤ 3.00
Mode 9	2422	-7.219	≤ 3.00
	2437	-5.577	≤ 3.00
	2452	-5.542	≤ 3.00

ANT-0+1+2+3			
Test Mode	Frequency (MHz)	Measurement (dBm/3 kHz)	Limit (dBm/ 3 kHz)
Mode 8	2412	-0.287	≤ 3.00
	2437	0.066	≤ 3.00
	2462	0.207	≤ 3.00
Mode 9	2422	-0.810	≤ 3.00
	2437	-0.059	≤ 3.00
	2452	-0.599	≤ 3.00

Mode 2: IEEE 802.11b Continuous TX mode_ANT-0

2412 MHz



2437 MHz



2462 MHz



Mode 3: IEEE 802.11g Continuous TX mode_ANT-0

2412 MHz

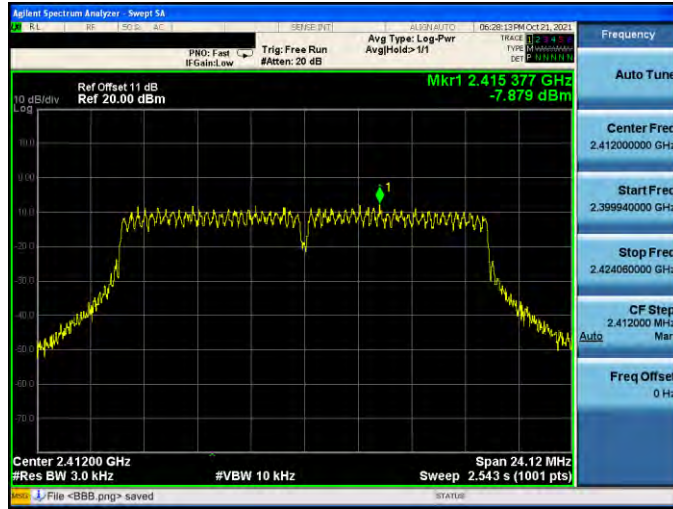

2437 MHz



2462 MHz

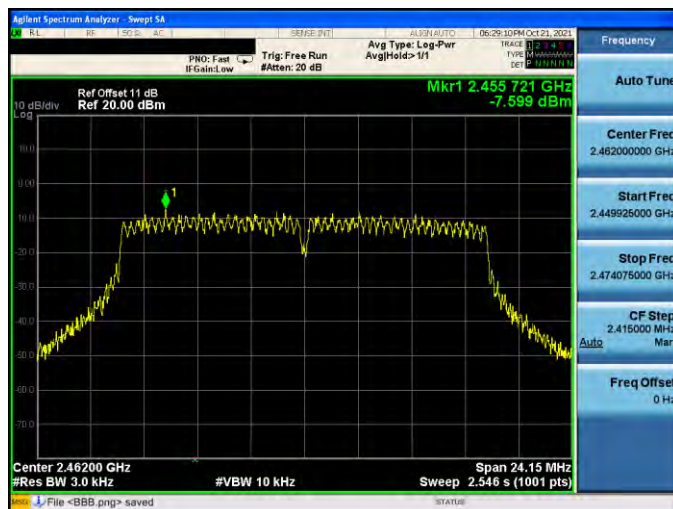

Mode 8: IEEE 802.11ax 2.4 GHz 20 MHz Continuous TX mode_ANT-0

2412 MHz

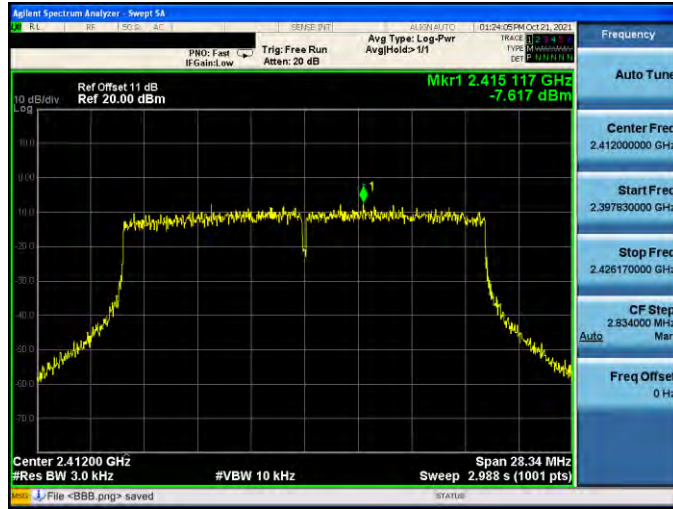

2437 MHz

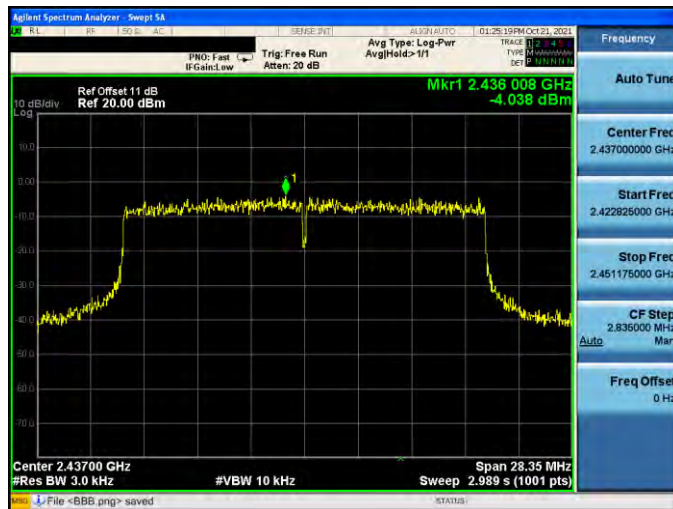

2462 MHz

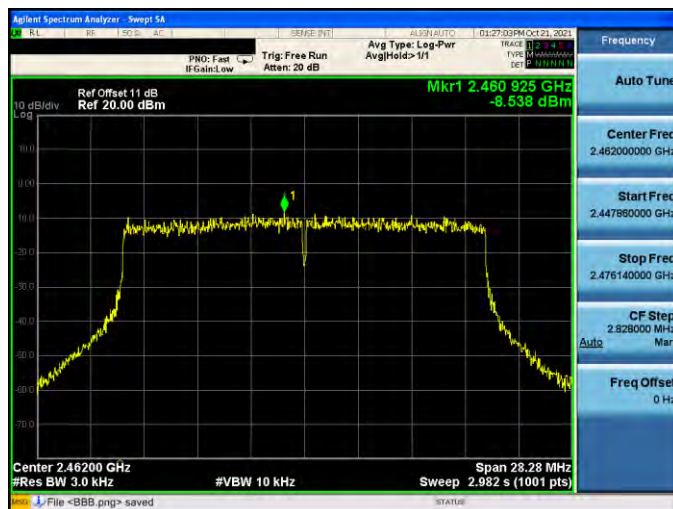

Mode 9: IEEE 802.11ax 2.4 GHz 40 MHz Continuous TX mode_ANT-0

2422 MHz

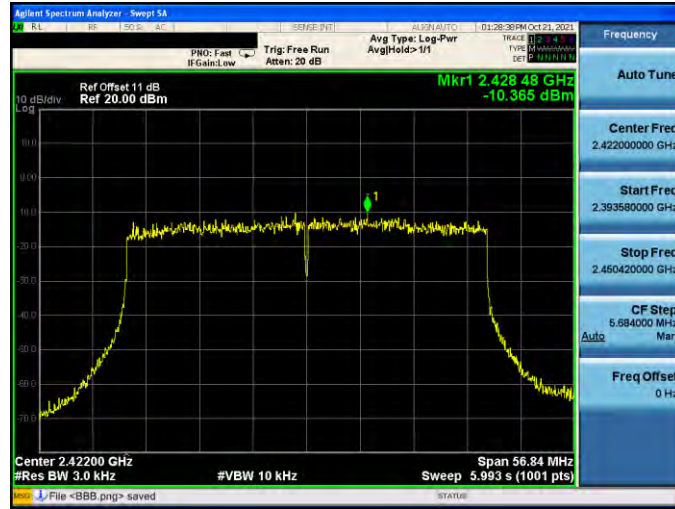

2437 MHz



2452 MHz

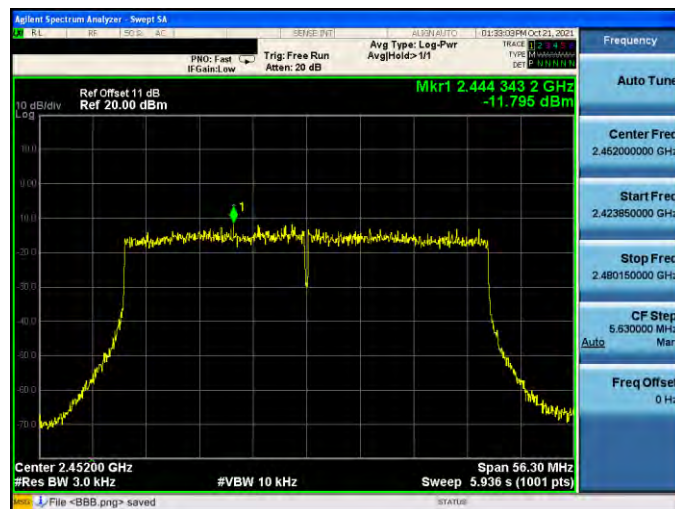

Mode 3: IEEE 802.11g Continuous TX mode_ANT-1

2412 MHz

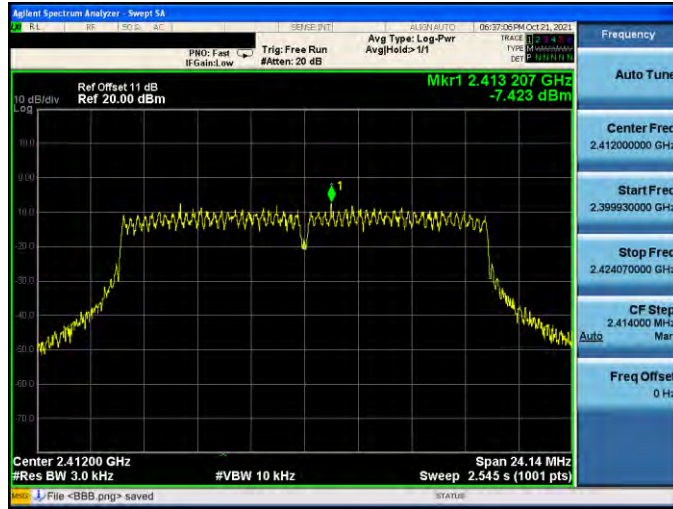

2437 MHz

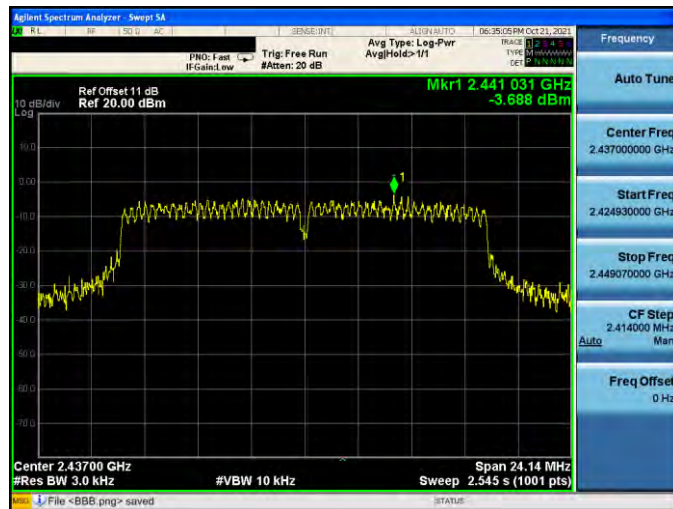

2462 MHz

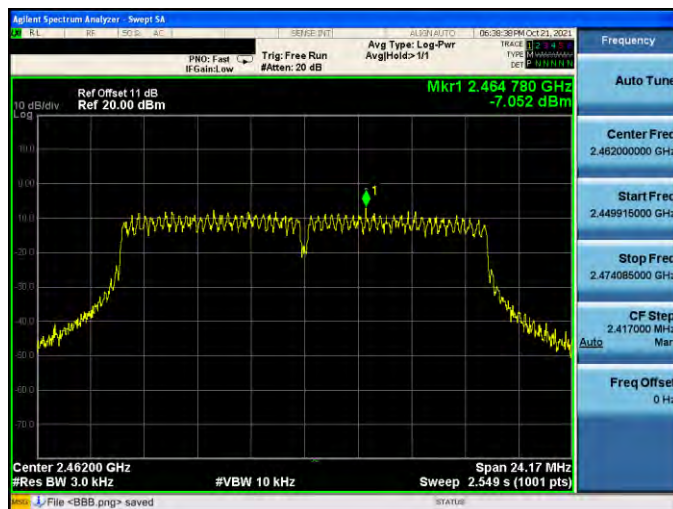

Mode 8: IEEE 802.11ax 2.4 GHz 20 MHz Continuous TX mode_ANT-1

2412 MHz

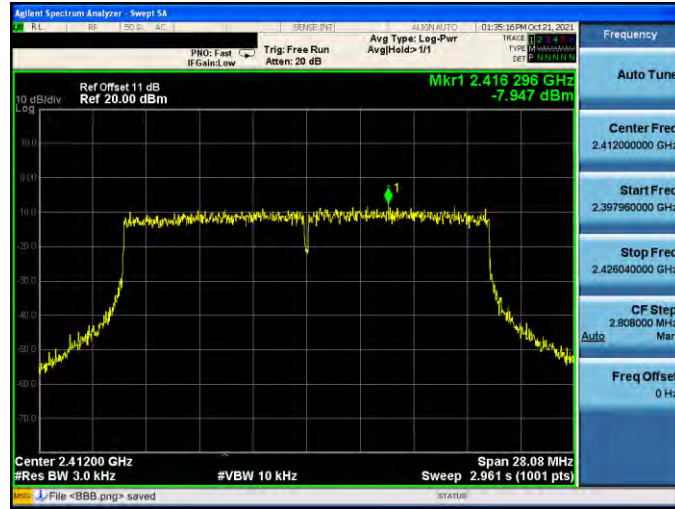

2437 MHz



2462 MHz

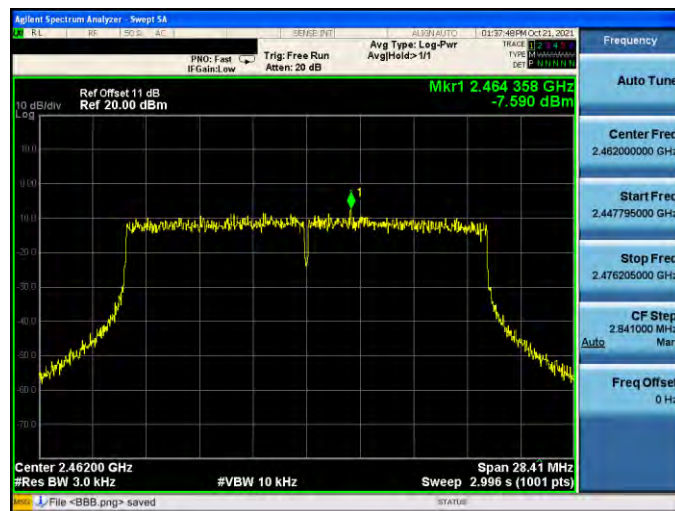

Mode 9: IEEE 802.11ax 2.4 GHz 40 MHz Continuous TX mode_ANT-1

2422 MHz

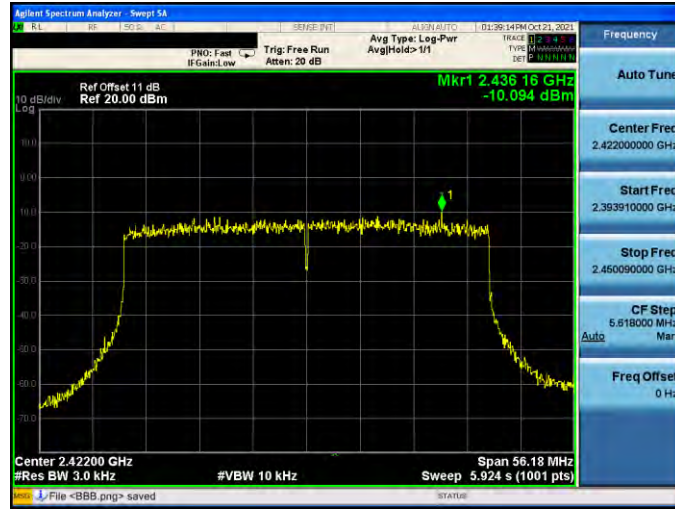

2437 MHz



2452 MHz

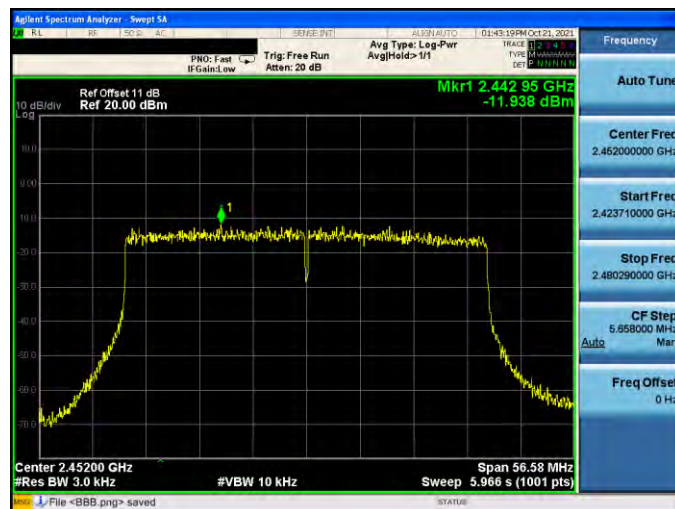

Mode 3: IEEE 802.11g Continuous TX mode_ANT-2

2412 MHz

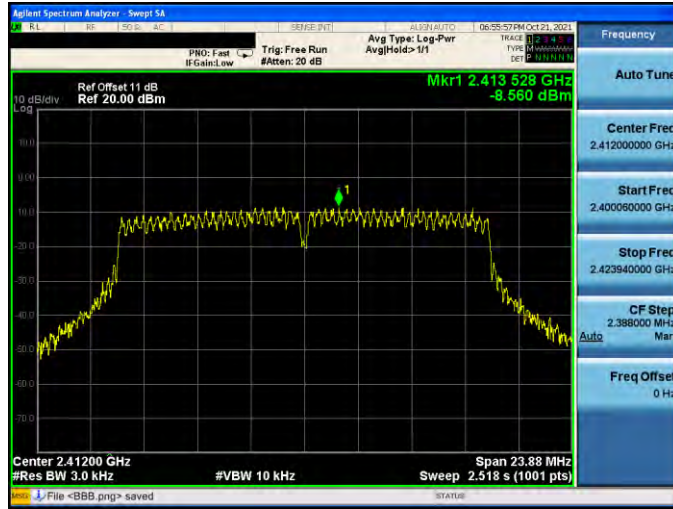

2437 MHz



2462 MHz

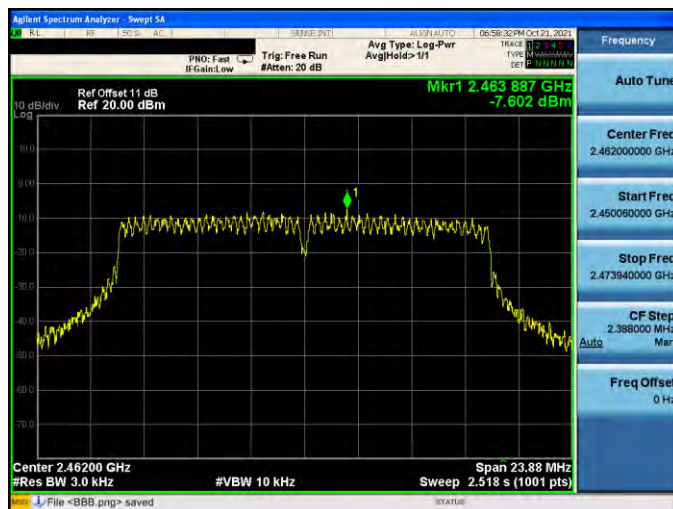

Mode 8: IEEE 802.11ax 2.4 GHz 20 MHz Continuous TX mode_ANT-2

2412 MHz

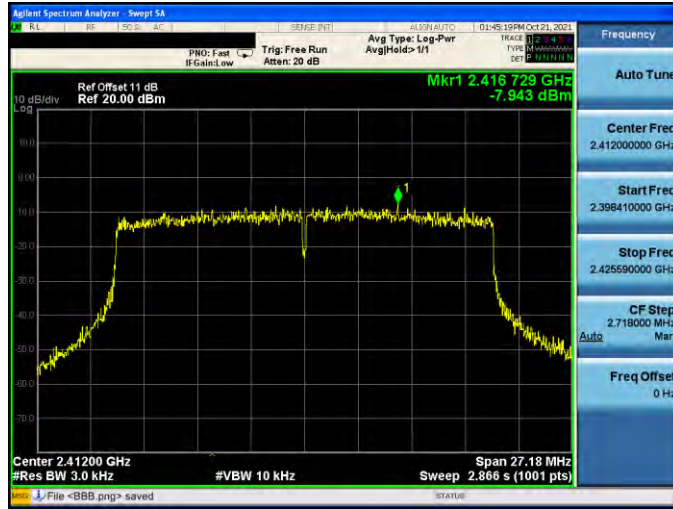

2437 MHz



2462 MHz

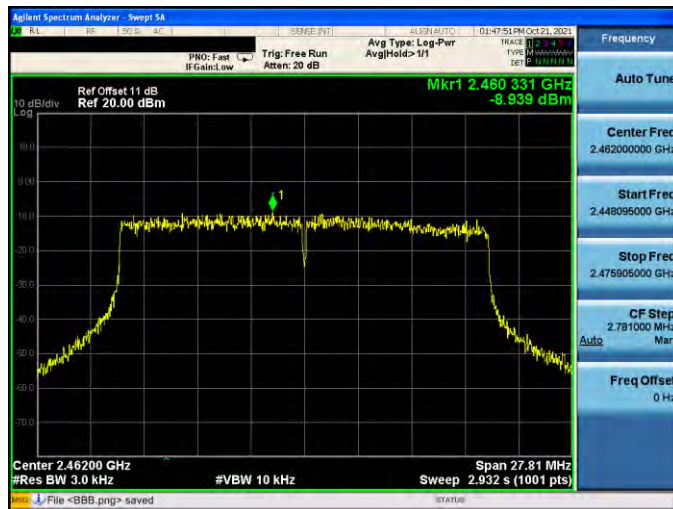

Mode 9: IEEE 802.11ax 2.4 GHz 40 MHz Continuous TX mode_ANT-2

2422 MHz



2437 MHz



2452 MHz

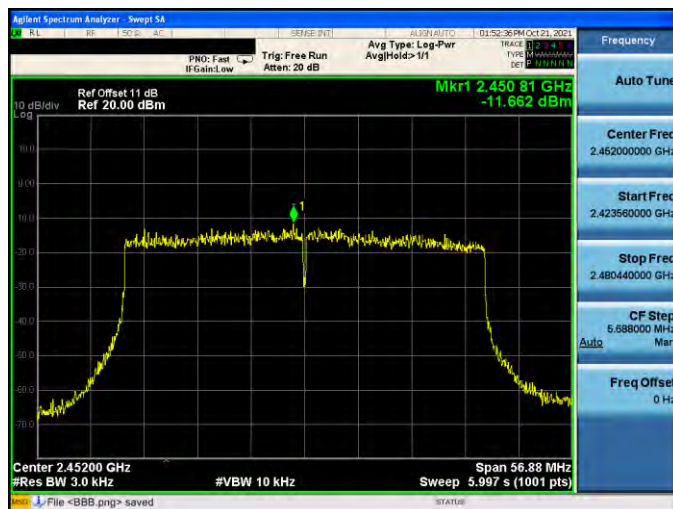

Mode 3: IEEE 802.11g Continuous TX mode_ANT-3

2412 MHz

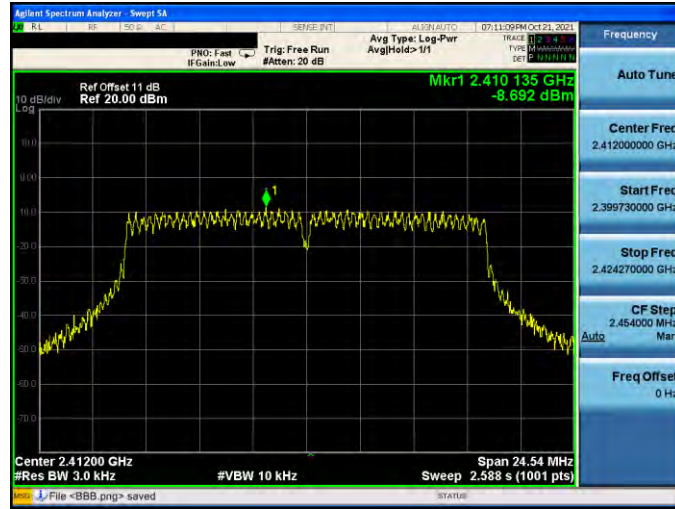

2437 MHz



2462 MHz

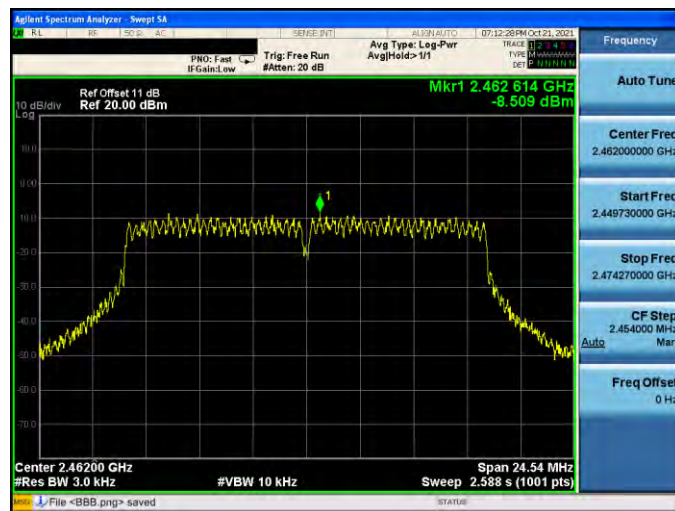

Mode 8: IEEE 802.11ax 2.4 GHz 20 MHz Continuous TX mode_ANT-3

2412 MHz

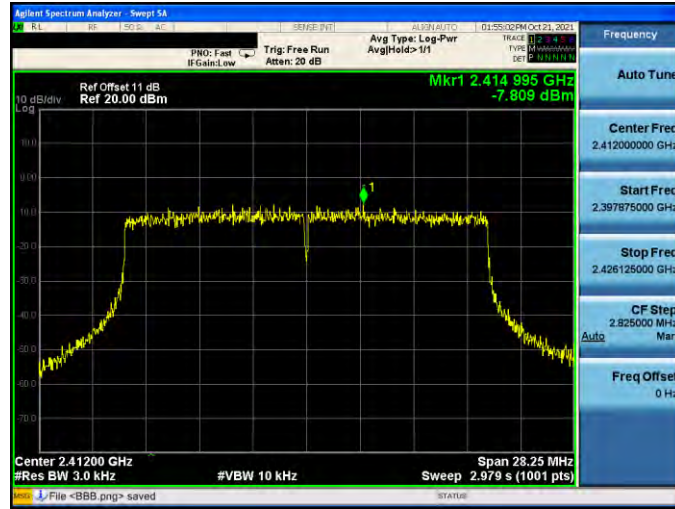

2437 MHz



2462 MHz

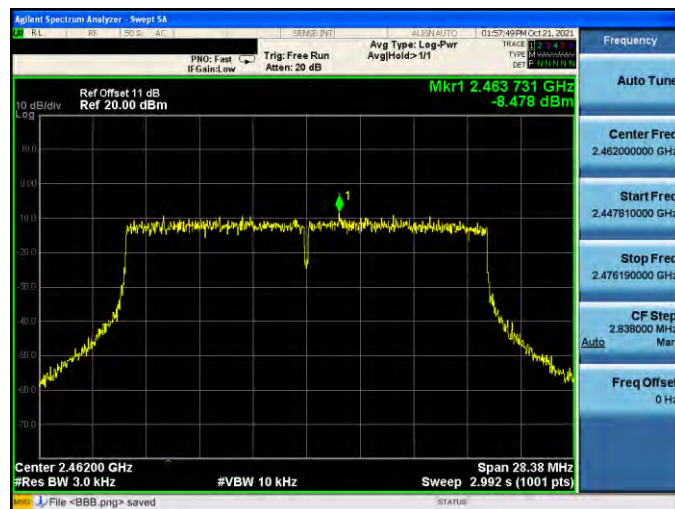

Mode 9: IEEE 802.11ax 2.4 GHz 40 MHz Continuous TX mode_ANT-3

2422 MHz



2437 MHz



2452 MHz

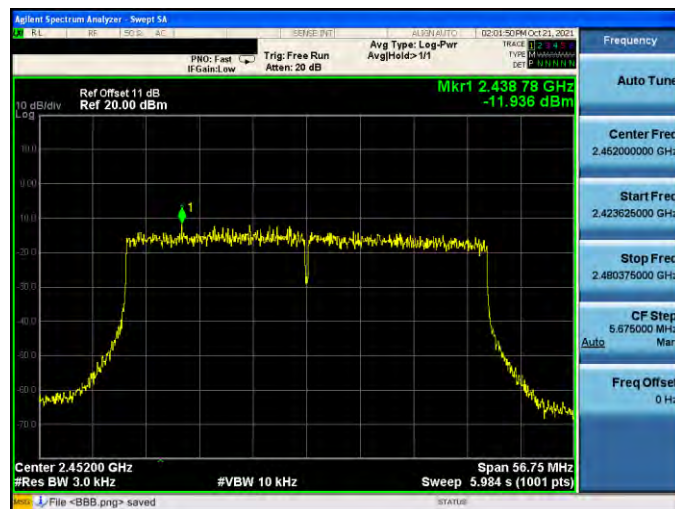

Beamforming on

Mode 8: IEEE 802.11ax 2.4 GHz 20 MHz Continuous TX mode_ANT-0

<p>2412 MHz</p>	
<p>2437 MHz</p>	
<p>2462 MHz</p>	

Mode 9: IEEE 802.11ax 2.4 GHz 40 MHz Continuous TX mode_ANT-0

2422 MHz

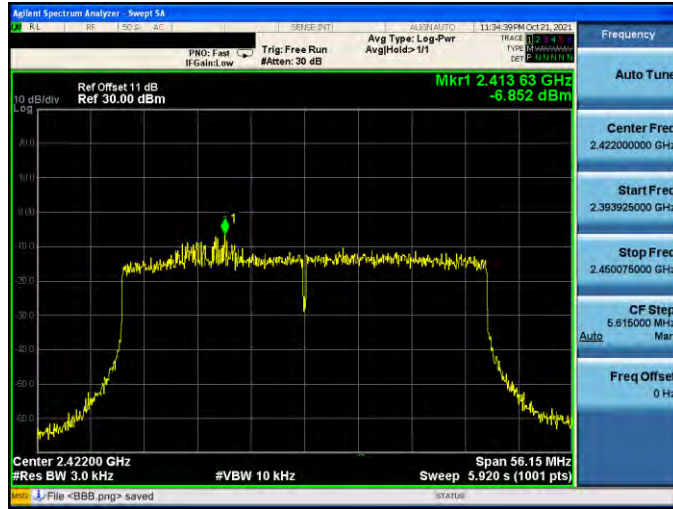

2437 MHz

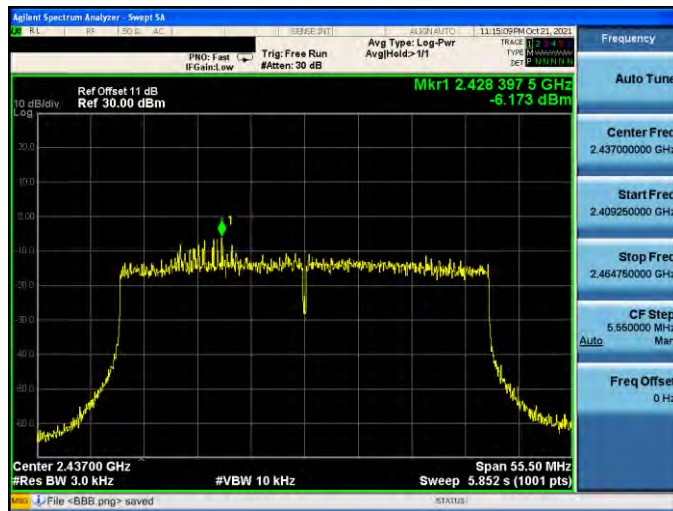

2452 MHz

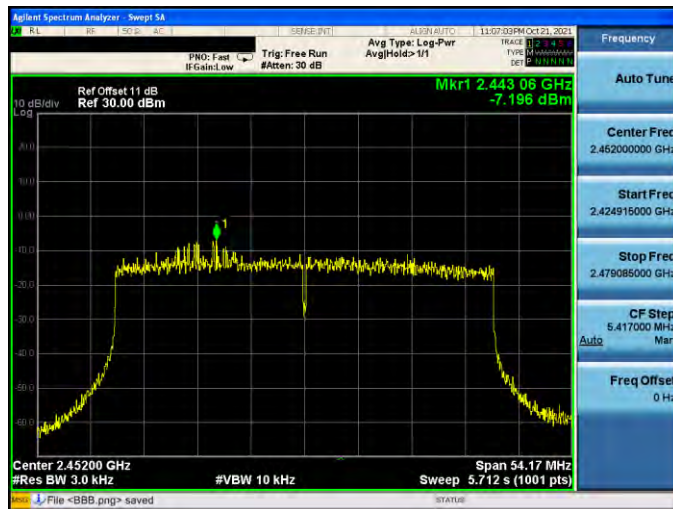

Mode 8: IEEE 802.11ax 2.4 GHz 20 MHz Continuous TX mode_ANT-1

2412 MHz

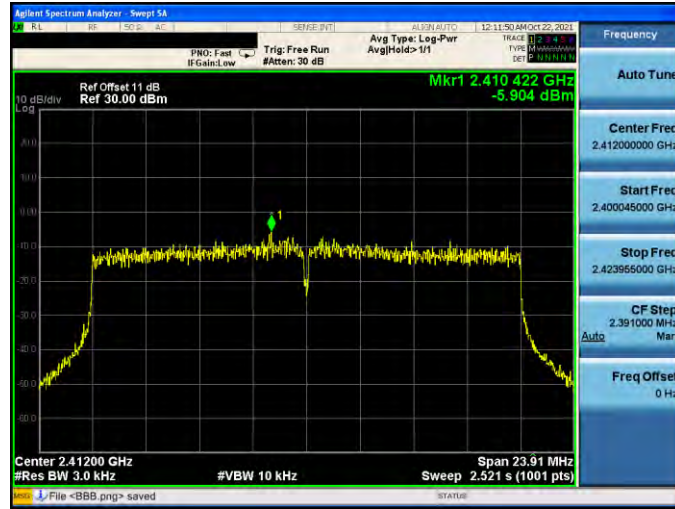

2437 MHz

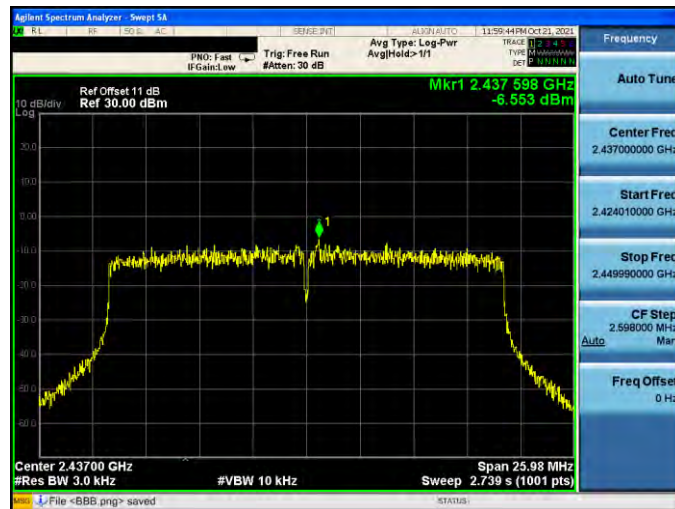

2462 MHz

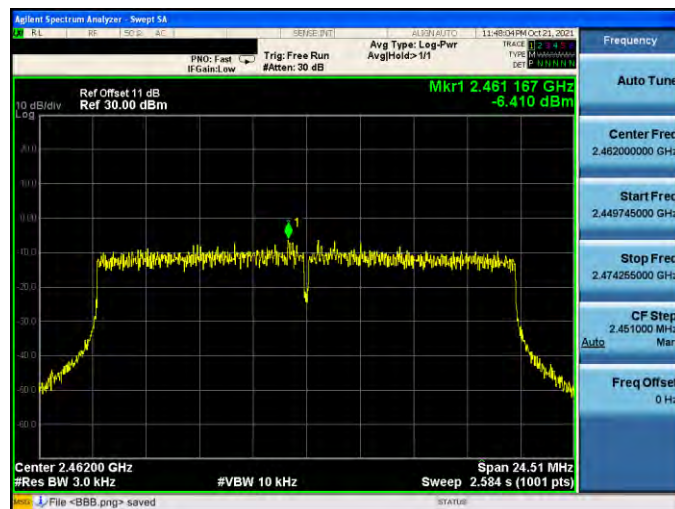

Mode 9: IEEE 802.11ax 2.4 GHz 40 MHz Continuous TX mode_ANT-1

2422 MHz

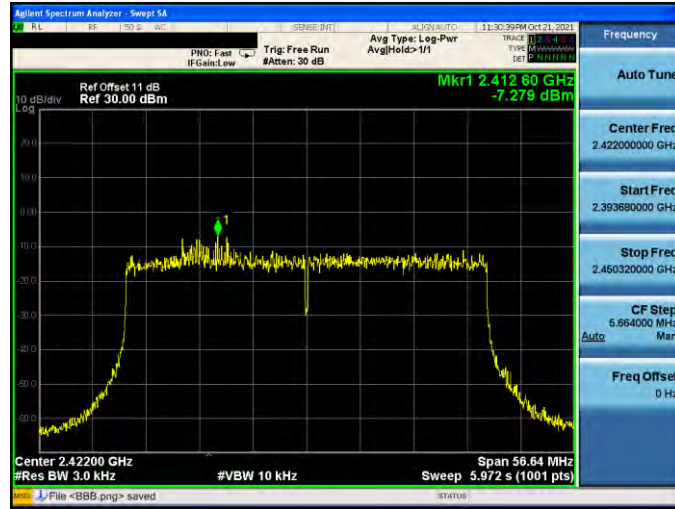

2437 MHz

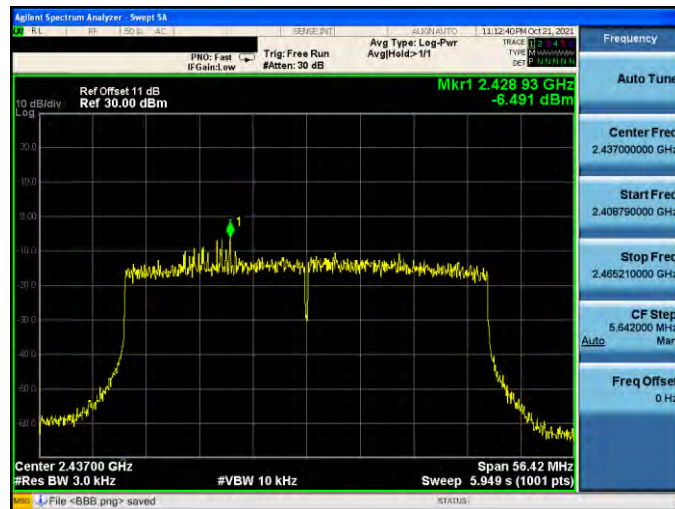

2452 MHz

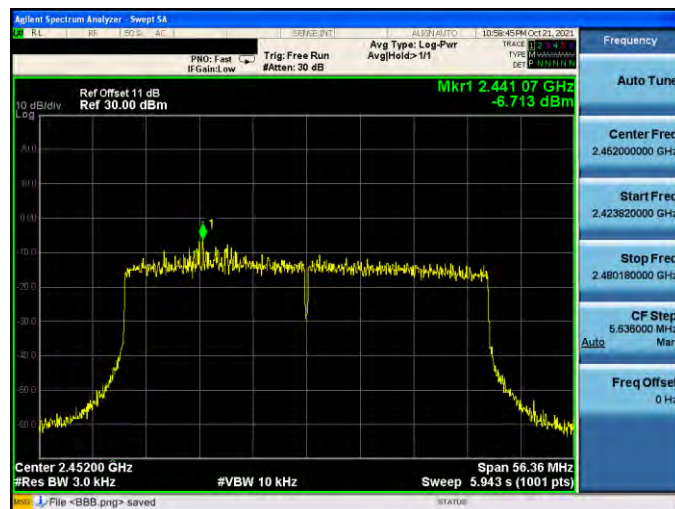

Mode 8: IEEE 802.11ax 2.4 GHz 20 MHz Continuous TX mode_ANT-2

2412 MHz

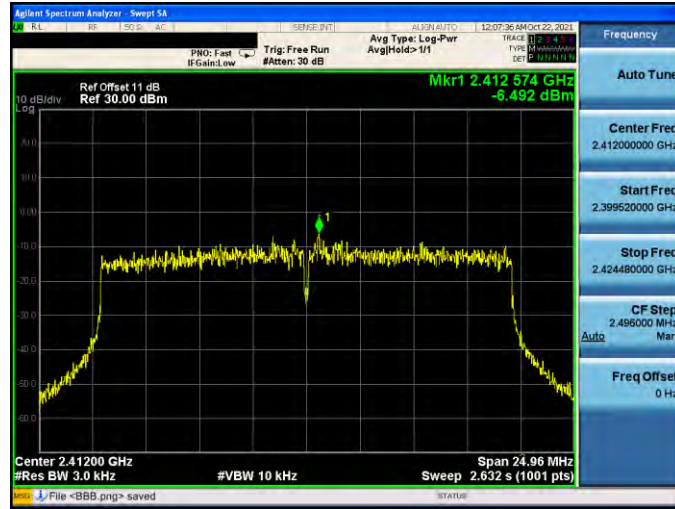

2437 MHz

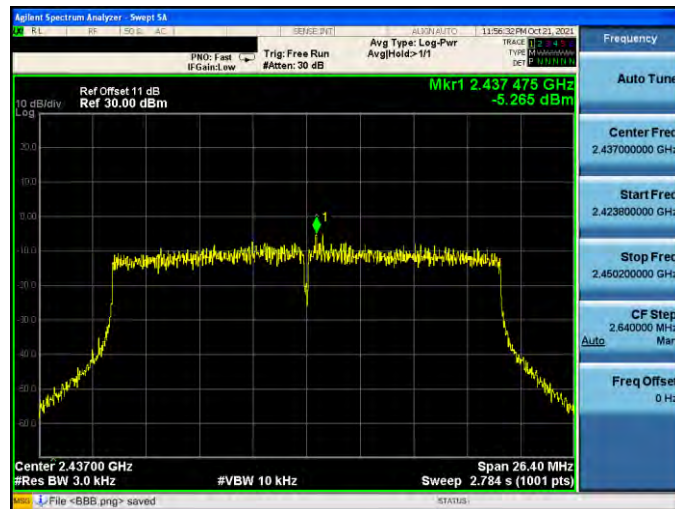

2462 MHz

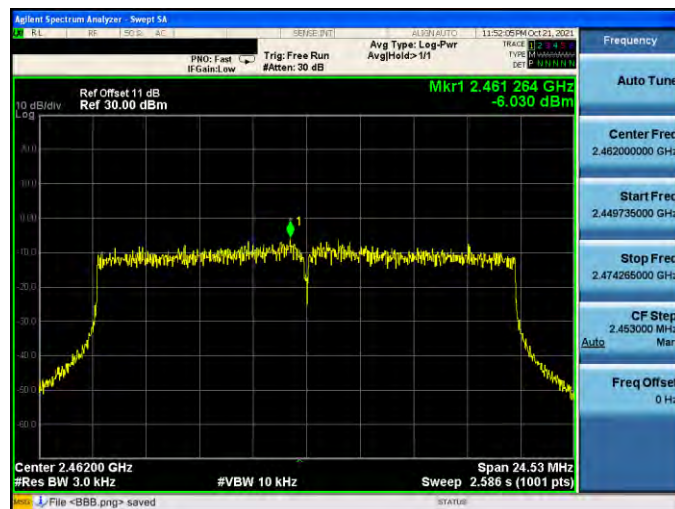

Mode 9: IEEE 802.11ax 2.4 GHz 40 MHz Continuous TX mode_ANT-2

2422 MHz

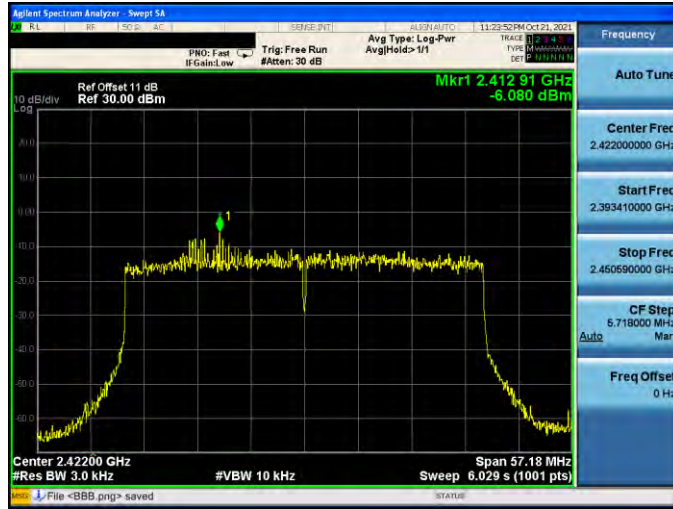

2437 MHz

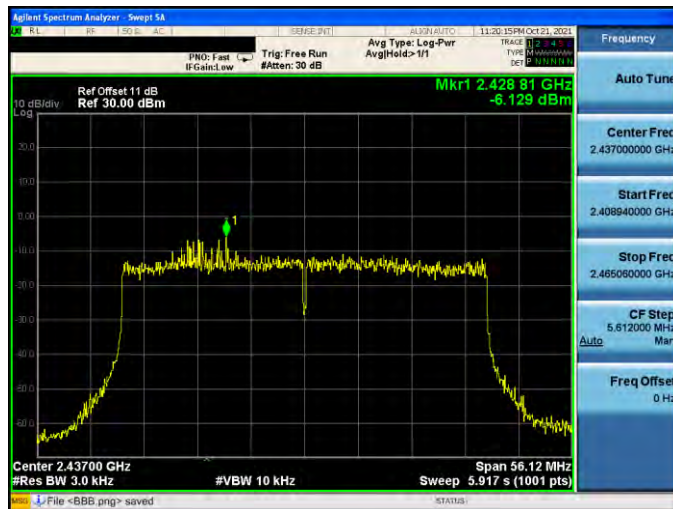

2452 MHz

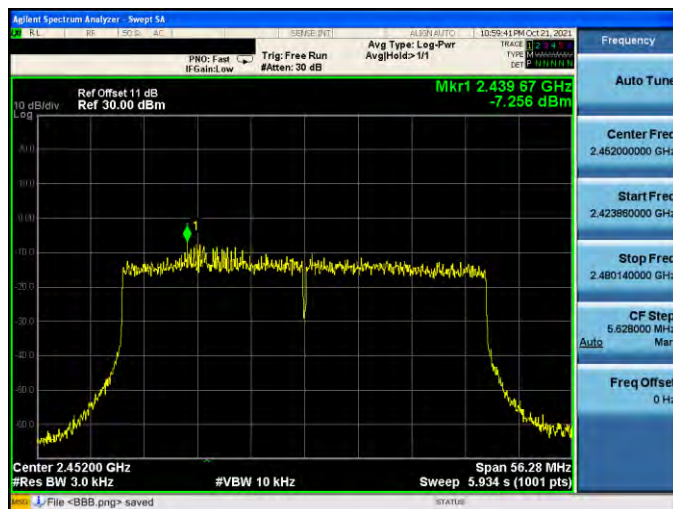

Mode 8: IEEE 802.11ax 2.4 GHz 20 MHz Continuous TX mode_ANT-3

2412 MHz

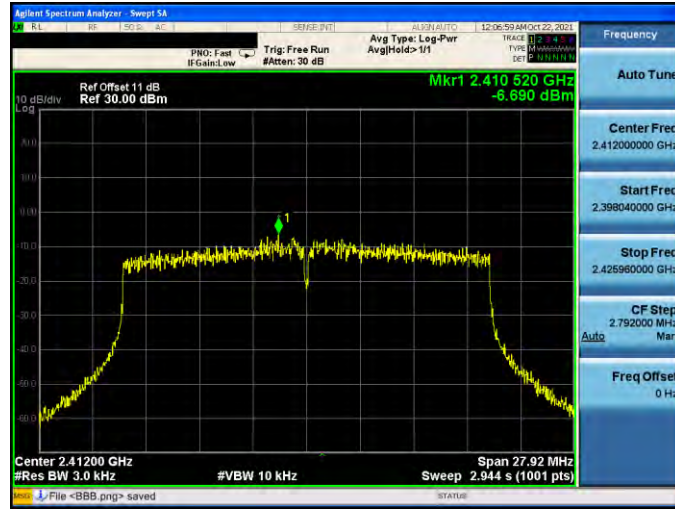

2437 MHz

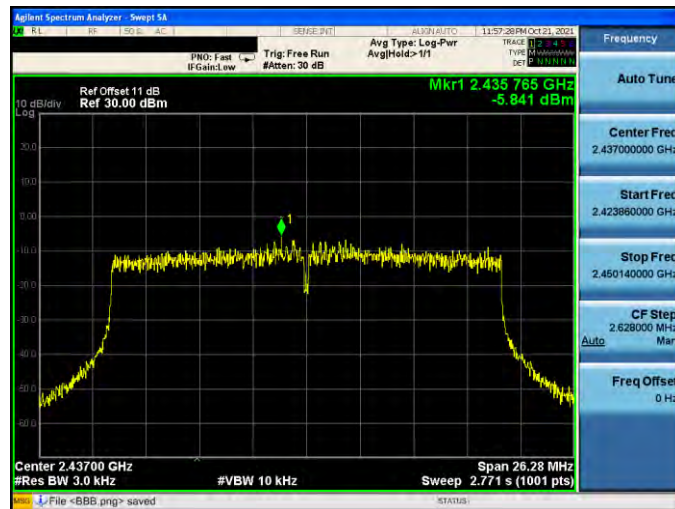

2462 MHz

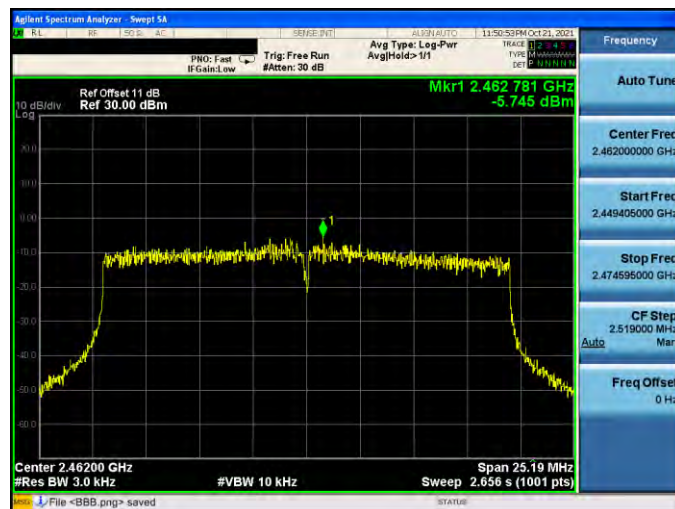

Mode 9: IEEE 802.11ax 2.4 GHz 40 MHz Continuous TX mode_ANT-3

2422 MHz

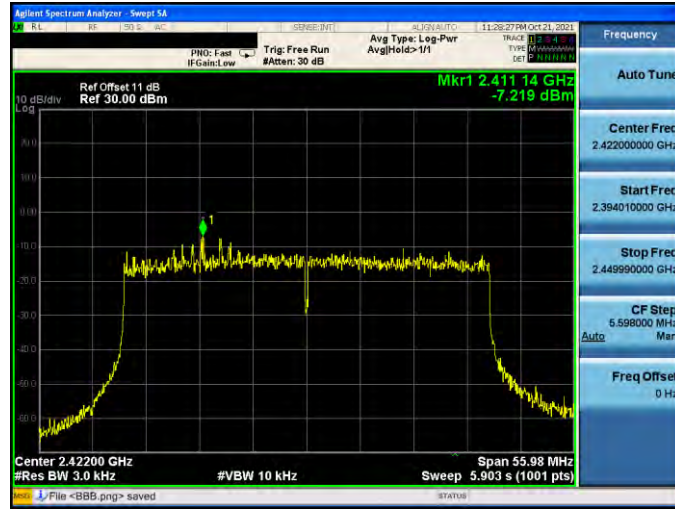

2437 MHz

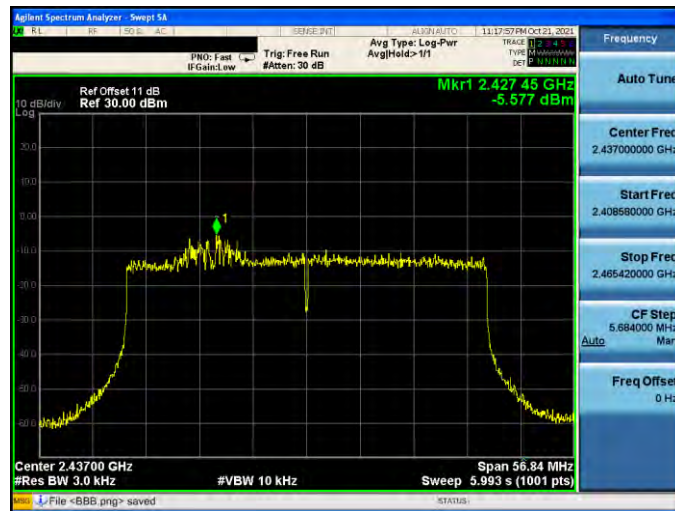

2452 MHz

