



FCC TEST REPORT (15.407)

REPORT NO.: RF130308C12-1

MODEL NO.: WLU5054-D84

FCC ID: H8N-WLU5054

RECEIVED: Mar. 08, 2013

TESTED: Mar. 13 ~ Mar. 15, 2013

ISSUED: Mar. 22, 2013

APPLICANT: Askey Computer Corp

ADDRESS: 10F, No. 119, Chienkang Rd Chung-Ho, Taipei
235, Taiwan

ISSUED BY: Bureau Veritas Consumer Products Services
(H.K.) Ltd., Taoyuan Branch

LAB ADDRESS: No. 47, 14th Ling, Chia Pau Vil., Lin Kou Dist.,
New Taipei City, Taiwan, R.O.C.

TEST LOCATION: No. 19, Hwa Ya 2nd Rd, Wen Hwa Tsuen, Kwei
Shan Hsiang, Taoyuan Hsien 333, Taiwan, R.O.C.

This report should not be used by the client to claim product certification, approval, or endorsement by TAF or any government agencies.



This report is for your exclusive use. Any copying or replication of this report to or for any other person or entity, or use of our name or trademark, is permitted only with our prior written permission. This report sets forth our findings solely with respect to the test samples identified herein. The results set forth in this report are not indicative or representative of the quality or characteristics of the lot from which a test sample was taken or any similar or identical product unless specifically and expressly noted. Our report includes all of the tests requested by you and the results thereof based upon the information that you provided to us. You have 60 days from date of issuance of this report to notify us of any material error or omission caused by our negligence, provided, however, that such notice shall be in writing and shall specifically address the issue you wish to raise. A failure to raise such issue within the prescribed time shall constitute your unqualified acceptance of the completeness of this report, the tests conducted and the correctness of the report contents. Unless specific mention, the uncertainty of measurement has been explicitly taken into account to declare the compliance or non-compliance to the specification.



TABLE OF CONTENTS

RELEASE CONTROL RECORD	4
1. CERTIFICATION.....	5
2. SUMMARY OF TEST RESULTS	6
2.1 MEASUREMENT UNCERTAINTY	6
3. GENERAL INFORMATION.....	7
3.1 GENERAL DESCRIPTION OF EUT	7
3.2 DESCRIPTION OF TEST MODES.....	8
3.2.1 TEST MODE APPLICABILITY AND TESTED CHANNEL DETAIL.....	9
3.3 DUTY CYCLE OF TEST SIGNAL.....	11
3.4 DESCRIPTION OF SUPPORT UNITS	12
3.4.1 CONFIGURATION OF SYSTEM UNDER TEST	12
3.5 GENERAL DESCRIPTION OF APPLIED STANDARDS	13
4. TEST TYPES AND RESULTS	14
4.1 RADIATED EMISSION AND BANDEDGE MEASUREMENT	14
4.1.1 LIMITS OF RADIATED EMISSION AND BANDEDGE MEASUREMENT.....	14
4.1.2 LIMITS OF UNWANTED EMISSION OUT OF THE RESTRICTED BANDS	14
4.1.3 TEST INSTRUMENTS.....	15
4.1.4 TEST PROCEDURES	16
4.1.5 DEVIATION FROM TEST STANDARD	16
4.1.6 TEST SETUP.....	17
4.1.7 EUT OPERATING CONDITION	17
4.1.8 TEST RESULTS	18
4.2 CONDUCTED EMISSION MEASUREMENT	45
4.2.1 LIMITS OF CONDUCTED EMISSION MEASUREMENT	45
4.2.2 TEST INSTRUMENTS.....	45
4.2.3 TEST PROCEDURES	46
4.2.4 DEVIATION FROM TEST STANDARD	46
4.2.5 TEST SETUP.....	46
4.2.6 EUT OPERATING CONDITIONS	46
4.2.7 TEST RESULTS	47
4.3 PEAK TRANSMIT POWER MEASUREMENT	51
4.3.1 LIMITS OF PEAK TRANSMIT POWER MEASUREMENT	51
4.3.2 TEST SETUP.....	51
4.3.3 TEST INSTRUMENTS.....	52
4.3.4 TEST PROCEDURE.....	52
4.3.5 DEVIATION FROM TEST STANDARD	52
4.3.6 EUT OPERATING CONDITIONS	52
4.3.7 TEST RESULTS	53
4.4 PEAK POWER SPECTRAL DENSITY MEASUREMENT	57
4.4.1 LIMITS OF PEAK POWER SPECTRAL DENSITY MEASUREMENT	57
4.4.2 TEST SETUP.....	57
4.4.3 TEST INSTRUMENTS.....	57
4.4.4 TEST PROCEDURES	57
4.4.5 DEVIATION FROM TEST STANDARD	57
4.4.6 EUT OPERATING CONDITIONS	57
4.4.7 TEST RESULTS	58
4.5 PEAK POWER EXCURSION MEASUREMENT	61



4.5.1	LIMITS OF PEAK POWER EXCURSION MEASUREMENT	61
4.5.2	TEST SETUP	61
4.5.3	TEST INSTRUMENTS.....	61
4.5.4	TEST PROCEDURE.....	61
4.5.5	DEVIATION FROM TEST STANDARD	61
4.5.6	EUT OPERATING CONDITIONS	61
4.5.7	TEST RESULTS	62
4.6	FREQUENCY STABILITY	65
4.6.1	LIMITS OF FREQUENCY STABILITY MEASUREMENT.....	65
4.6.2	TEST SETUP.....	65
4.6.3	TEST INSTRUMENTS.....	65
4.6.4	TEST PROCEDURE.....	66
4.6.5	DEVIATION FROM TEST STANDARD	66
4.6.6	EUT OPERATING CONDITION	66
4.6.7	TEST RESULTS	67
5.	PHOTOGRAPHS OF THE TEST CONFIGURATION	68
6.	INFORMATION ON THE TESTING LABORATORIES.....	69
7.	APPENDIX A - MODIFICATIONS RECORDERS FOR ENGINEERING CHANGES TO THE EUT BY THE LAB	70



A D T

RELEASE CONTROL RECORD

ISSUE NO.	REASON FOR CHANGE	DATE ISSUED
RF130308C12-1	Original release	Mar. 22, 2013



1. CERTIFICATION

PRODUCT: Wireless LAN module

MODEL: WLU5054-D84

BRAND: Askey

APPLICANT: Askey Computer Corp

TESTED: Mar. 13 ~ Mar. 15, 2013

TEST SAMPLE: ENGINEERING SAMPLE

STANDARDS: FCC Part 15, Subpart E (Section 15.407)

ANSI C63.10-2009

The above equipment (model: WLU5054-D84) has been tested by **Bureau Veritas Consumer Products Services (H.K.) Ltd., Taoyuan Branch**, and found compliance with the requirement of the above standards. The test record, data evaluation & Equipment Under Test (EUT) configurations represented herein are true and accurate accounts of the measurements of the sample's EMC characteristics under the conditions specified in this report.

PREPARED BY : Ivy Lin DATE : Mar. 22, 2013
Ivy Lin / Specialist

APPROVED BY : Ken Liu , DATE : Mar. 22, 2013
Ken Liu / Senior Manager

2. SUMMARY OF TEST RESULTS

The EUT has been tested according to the following specifications:

APPLIED STANDARD: FCC PART 15, SUBPART E (SECTION 15.407)			
STANDARD SECTION	TEST TYPE	RESULT	REMARK
15.407(b)(6)	AC Power Conducted Emission	PASS	Meet the requirement of limit. Minimum passing margin is -15.14dB at 7.41406MHz.
15.407(b/1/2/3) (b)(6)	Spurious Emissions	PASS	Meet the requirement of limit. Minimum passing margin is -1.0dB at 5350.00MHz & 5470.00MHz.
15.407(a/1/2)	Max Average Transmit Power	PASS	Meet the requirement of limit.
15.407(a)(6)	Peak Power Excursion	PASS	Meet the requirement of limit.
15.407(a/1/2)	Peak Power Spectral Density	PASS	Meet the requirement of limit.
15.407(g)	Frequency Stability	PASS	Meet the requirement of limit.
15.203	Antenna Requirement	PASS	Antenna connector is U.FL-R not a standard connector.

2.1 MEASUREMENT UNCERTAINTY

Where relevant, the following measurement uncertainty levels have been estimated for tests performed on the EUT as specified in CISPR 16-4-2:

MEASUREMENT	FREQUENCY	UNCERTAINTY
Conducted emissions	9kHz~30MHz	2.44 dB
Radiated emissions	30MHz ~ 200MHz	2.93 dB
	200MHz ~ 1000MHz	2.95 dB
	1GHz ~ 18GHz	2.26 dB
	18GHz ~ 40GHz	1.94 dB

This uncertainty represents an expanded uncertainty expressed at approximately the 95% confidence level using a coverage factor of $k = 2$.

3. GENERAL INFORMATION

3.1 GENERAL DESCRIPTION OF EUT

EUT	Wireless LAN module
MODEL NO.	WLU5054-D84
POWER SUPPLY	5.0Vdc (Host equipment)
MODULATION TYPE	64QAM, 16QAM, QPSK, BPSK
MODULATION TECHNOLOGY	OFDM
TRANSFER RATE	802.11a: 54.0/ 48.0/ 36.0/ 24.0/ 18.0/ 12.0/ 9.0/ 6.0Mbps 802.11n: up to 300.0Mbps
OPERATING FREQUENCY	5180 ~ 5240MHz, 5260 ~ 5320MHz & 5500 ~ 5700MHz
NUMBER OF CHANNEL	5180 ~ 5240MHz: 4 for 802.11a, 802.11n (20MHz) 2 for 802.11n (40MHz) 5260 ~ 5320MHz: 4 for 802.11a, 802.11n (20MHz) 2 for 802.11n (40MHz) 5500 ~ 5700MHz: 8 for 802.11a, 802.11n (20MHz) 3 for 802.11n (40MHz)
OUTPUT POWER	49.995mW for 5180 ~ 5240MHz 67.834mW for 5260 ~ 5320MHz 64.691mW for 5500 ~ 5700MHz
ANTENNA TYPE	Refer to Note as below
ANTENNA CONNECTOR	U.FL-R
DATA CABLE	N/A
I/O PORTS	Refer to user's manual
ACCESSORY DEVICES	NA

NOTE:

1. The EUT provides two completed transmitters and two receivers.

MODULATION MODE	TX FUNCTION
802.11b	1TX
802.11g	1TX
802.11a	1TX
802.11n (20MHz)	1TX/ 2TX
802.11n (40MHz)	1TX/ 2TX

* After pre-testing, 2TX was the worst case for 802.11n (20MHz)/ 802.11n (40MHz).

2. The following antenna is provided to the EUT.

Antenna type	Antenna gain (dBi)				
	2.4GHz	5.18 ~ 5.24GHz	5.26 ~ 5.32GHz	5.50 ~ 5.70GHz	5.745 ~ 5.825GHz
Printed (Ant. 0)	2.95	3.74	4.00	4.13	3.48
Printed (Ant. 1)	1.64	2.78	3.16	3.21	3.28

3. *After pre-testing, ant. 0 was the worst case for 802.11 a/ b/ g.
4. The above EUT information is declared by manufacturer and for more detailed features description, please refer to the manufacturer's specifications or user's manual.

3.2 DESCRIPTION OF TEST MODES

FOR 5180 ~ 5240MHz

4 channels are provided for 802.11a, 802.11n (20MHz):

CHANNEL	FREQUENCY	CHANNEL	FREQUENCY
36	5180 MHz	44	5220 MHz
40	5200 MHz	48	5240 MHz

2 channels are provided for 802.11n (40MHz):

CHANNEL	FREQUENCY	CHANNEL	FREQUENCY
38	5190 MHz	46	5230 MHz

FOR 5260 ~ 5320MHz

4 channels are provided for 802.11a, 802.11n (20MHz):

CHANNEL	FREQUENCY	CHANNEL	FREQUENCY
52	5260 MHz	60	5300 MHz
56	5280 MHz	64	5320 MHz

2 channels are provided for 802.11n (40MHz):

CHANNEL	FREQUENCY	CHANNEL	FREQUENCY
54	5270 MHz	62	5310 MHz

FOR 5500 ~ 5700MHz

8 channels are provided for 802.11a, 802.11n (20MHz):

CHANNEL	FREQUENCY	CHANNEL	FREQUENCY
100	5500 MHz	116	5580 MHz
104	5520 MHz	132	5660 MHz
108	5540 MHz	136	5680 MHz
112	5560 MHz	140	5700 MHz

3 channels are provided for 802.11n (40MHz):

CHANNEL	FREQUENCY	CHANNEL	FREQUENCY
102	5510 MHz	134	5670 MHz
110	5550 MHz		

3.2.1 TEST MODE APPLICABILITY AND TESTED CHANNEL DETAIL

EUT CONFIGURE MODE	APPLICABLE TO				DESCRIPTION
	RE \geq 1G	RE<1G	PLC	APCM	
-	√	√	√	√	-

Where **RE \geq 1G**: Radiated Emission above 1GHz **RE<1G**: Radiated Emission below 1GHz
PLC: Power Line Conducted Emission **APCM**: Antenna Port Conducted Measurement

NOTE:
The EUT had been pre-tested on the positioned of each 3 axis. The worst case was found when positioned on **X-plane**.

RADIATED EMISSION TEST (ABOVE 1GHz):

- Pre-Scan has been conducted to determine the worst-case mode from all possible combinations between available modulations, data rates and antenna ports (if EUT with antenna diversity architecture).
- Following channel(s) was (were) selected for the final test as listed below.

EUT CONFIGURE MODE	MODE	FREQ. BAND (MHz)	AVAILABLE CHANNEL	TESTED CHANNEL	MODULATION TECHNOLOGY	MODULATION TYPE	DATA RATE (Mbps)
-	802.11a	5180-5240	36 to 48	36, 40, 48	OFDM	BPSK	6.0
-	802.11n (20MHz)		36 to 48	36, 40, 48	OFDM	BPSK	7.2
-	802.11n (40MHz)		38 to 46	38, 46	OFDM	BPSK	15.0
-	802.11a	5260-5320	52 to 64	52, 60, 64	OFDM	BPSK	6.0
-	802.11n (20MHz)		52 to 64	52, 60, 64	OFDM	BPSK	7.2
-	802.11n (40MHz)		54 to 62	54, 62	OFDM	BPSK	15.0
-	802.11a	5500-5700	100 to 140	100, 116, 140	OFDM	BPSK	6.0
-	802.11n (20MHz)		100 to 140	100, 116, 140	OFDM	BPSK	7.2
-	802.11n (40MHz)		102 to 134	102, 110, 134	OFDM	BPSK	15.0

RADIATED EMISSION TEST (BELOW 1GHz):

- Pre-Scan has been conducted to determine the worst-case mode from all possible combinations between available modulations, data rates and antenna ports (if EUT with antenna diversity architecture).
- Following channel(s) was (were) selected for the final test as listed below.

EUT CONFIGURE MODE	MODE	FREQ. BAND (MHz)	AVAILABLE CHANNEL	TESTED CHANNEL	MODULATION TECHNOLOGY	MODULATION TYPE	DATA RATE (Mbps)
-	802.11n (20MHz)	5180-5320	36 to 64	60	OFDM	BPSK	7.2
-	802.11n (20MHz)	5500-5700	100 to 140	116	OFDM	BPSK	7.2

POWER LINE CONDUCTED EMISSION TEST:

- Pre-Scan has been conducted to determine the worst-case mode from all possible combinations between available modulations, data rates and antenna ports (if EUT with antenna diversity architecture).
- Following channel(s) was (were) selected for the final test as listed below.

EUT CONFIGURE MODE	MODE	FREQ. BAND (MHz)	AVAILABLE CHANNEL	TESTED CHANNEL	MODULATION TECHNOLOGY	MODULATION TYPE	DATA RATE (Mbps)
-	802.11n (20MHz)	5180-5320	36 to 64	60	OFDM	BPSK	7.2
-	802.11n (20MHz)	5500-5700	100 to 140	116	OFDM	BPSK	7.2

ANTENNA PORT CONDUCTED MEASUREMENT:

- This item includes all test value of each mode, but only includes spectrum plot of worst value of each mode.
- Pre-Scan has been conducted to determine the worst-case mode from all possible combinations between available modulations, data rates and antenna ports (if EUT with antenna diversity architecture).
- Following channel(s) was (were) selected for the final test as listed below.

EUT CONFIGURE MODE	MODE	FREQ. BAND (MHz)	AVAILABLE CHANNEL	TESTED CHANNEL	MODULATION TECHNOLOGY	MODULATION TYPE	DATA RATE (Mbps)
-	802.11a	5180-5240	36 to 48	36, 40, 48	OFDM	BPSK	6.0
-	802.11n (20MHz)		36 to 48	36, 40, 48	OFDM	BPSK	7.2
-	802.11n (40MHz)		38 to 46	38, 46	OFDM	BPSK	15.0
-	802.11a	5260-5320	52 to 64	52, 60, 64	OFDM	BPSK	6.0
-	802.11n (20MHz)		52 to 64	52, 60, 64	OFDM	BPSK	7.2
-	802.11n (40MHz)		54 to 62	54, 62	OFDM	BPSK	15.0
-	802.11a	5500-5700	100 to 140	100, 116, 140	OFDM	BPSK	6.0
-	802.11n (20MHz)		100 to 140	100, 116, 140	OFDM	BPSK	7.2
-	802.11n (40MHz)		102 to 134	102, 110, 134	OFDM	BPSK	15.0

TEST CONDITION:

APPLICABLE TO	ENVIRONMENTAL CONDITIONS	INPUT POWER	TESTED BY
RE≥1G	23deg. C, 71%RH	120Vac, 60Hz	Alan Wu, Cedric Wu
RE<1G	23deg. C, 71%RH	120Vac, 60Hz	Martin Lee
PLC	24deg. C, 64%RH	120Vac, 60Hz	Match Tsui
APCM	20deg. C, 60%RH	120Vac, 60Hz	Jun Wu

3.3 DUTY CYCLE OF TEST SIGNAL

If duty cycle is < 98%, duty factor shall be considered.

802.11a: Duty cycle = $1.90500/2.00625 = 0.950$, Duty factor = $10 * \log(1/0.950) = 0.22$

802.11n (20MHz): Duty cycle = $1.907500/2.00625 = 0.950$, Duty factor = $10 * \log(1/0.950) = 0.22$

802.11n (40MHz): Duty cycle = $0.93125/1.03000 = 0.904$, Duty factor = $10 * \log(1/0.904) = 0.44$

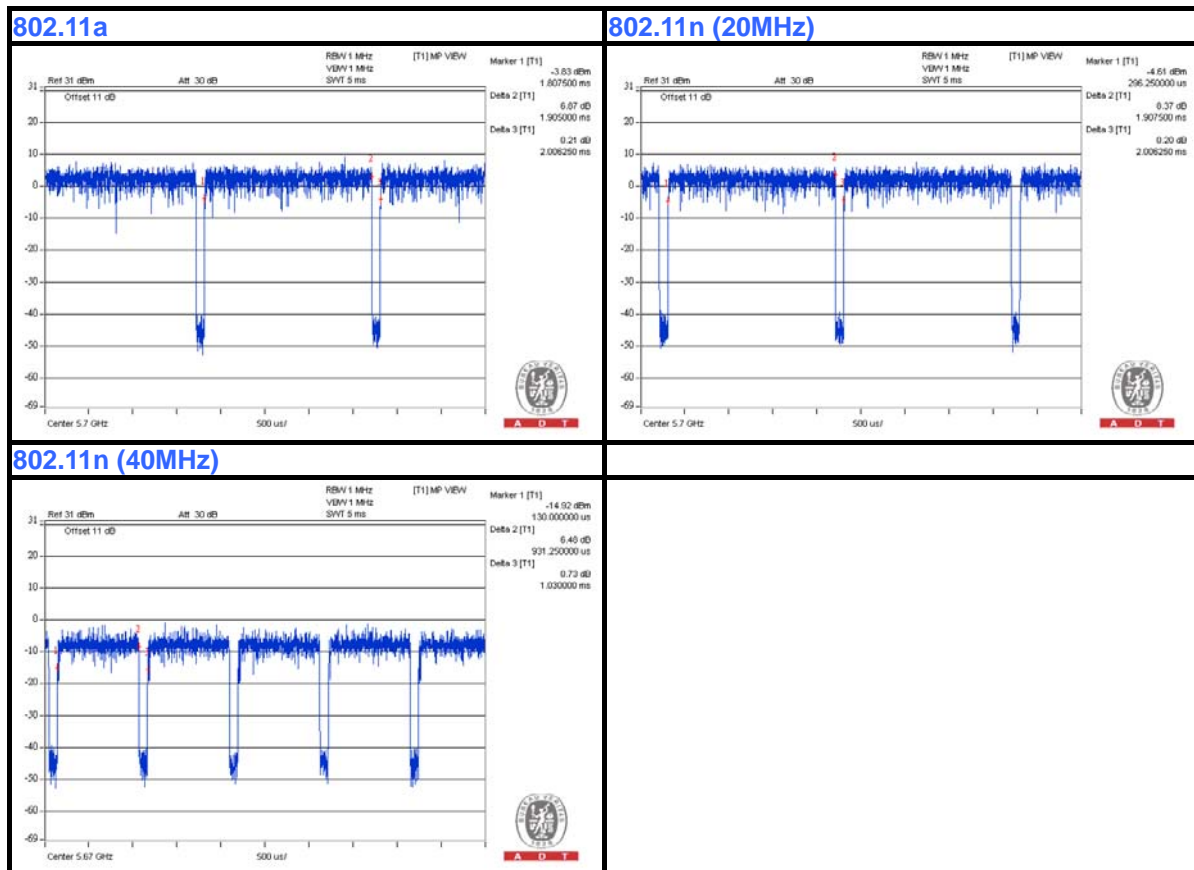

3.4 DESCRIPTION OF SUPPORT UNITS

The EUT has been tested as an independent unit together with other necessary accessories or support units. The following support units or accessories were used to form a representative test configuration during the tests.

NO.	PRODUCT	BRAND	MODEL NO.	SERIAL NO.	FCC ID
1	NOTEBOOK	Dell	E5420	D9VMBT1	FCC DoC Approved

NO.	SIGNAL CABLE DESCRIPTION OF THE ABOVE SUPPORT UNITS
1	0.1m USB cable without core.

NOTE: All power cords of the above support units are non shielded (1.8m).

3.4.1 CONFIGURATION OF SYSTEM UNDER TEST

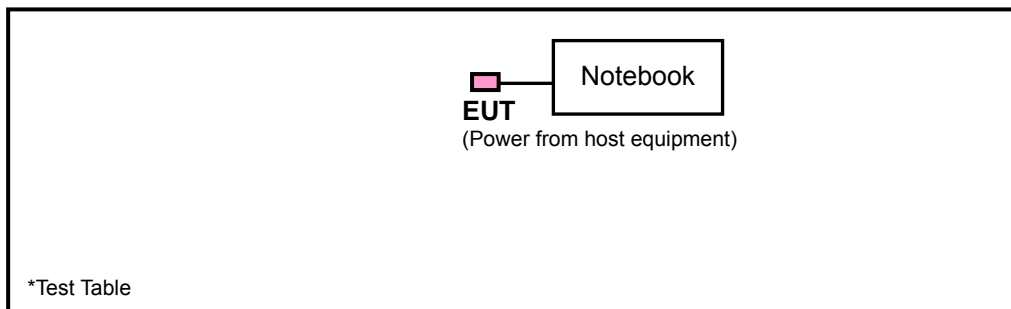

3.5 GENERAL DESCRIPTION OF APPLIED STANDARDS

The EUT is a RF Product. According to the specifications of the manufacturer, it must comply with the requirements of the following standards:

FCC Part 15, Subpart E (15.407)

789033 D01 General UNII Test Procedures v01 r02

662911 D01 Multiple Transmitter Output v01 r02

ANSI C63.10-2009

All test items have been performed and recorded as per the above standards.

NOTE: The EUT is also considered as a kind of computer peripheral, because the connection to computer is necessary for typical use. It has been verified to comply with the requirements of FCC Part 15, Subpart B, Class B (DoC). The test report has been issued separately.

4. TEST TYPES AND RESULTS

4.1 RADIATED EMISSION AND BANDEDGE MEASUREMENT

4.1.1 LIMITS OF RADIATED EMISSION AND BANDEDGE MEASUREMENT

Radiated emissions which fall in the restricted bands must comply with the radiated emission limits specified as below table:

FREQUENCIES (MHz)	FIELD STRENGTH (microvolts/meter)	MEASUREMENT DISTANCE (meters)
0.009 ~ 0.490	2400/F(kHz)	300
0.490 ~ 1.705	24000/F(kHz)	30
1.705 ~ 30.0	30	30
30 ~ 88	100	3
88 ~ 216	150	3
216 ~ 960	200	3
Above 960	500	3

NOTE:

1. The lower limit shall apply at the transition frequencies.
2. Emission level (dBuV/m) = 20 log Emission level (uV/m).
3. For frequencies above 1000MHz, the field strength limits are based on average detector, however, the peak field strength of any emission shall not exceed the maximum permitted average limits, specified above by more than 20dB under any condition of modulation.

4.1.2 LIMITS OF UNWANTED EMISSION OUT OF THE RESTRICTED BANDS

APPLICABLE TO	LIMIT	
√	FIELD STRENGTH AT 3m (dBμV/m)	
	PK	AV
	74	54
	EIRP LIMIT (dBm)	EQUIVALENT FIELD STRENGTH AT 3m (dBμV/m)
	PK	PK
	-27	68.3

NOTE: The following formula is used to convert the equipment isotropic radiated power (eirp) to field strength:

$$E = \frac{1000000\sqrt{30P}}{3} \mu\text{V/m, where P is the eirp (Watts).}$$

4.1.3 TEST INSTRUMENTS

DESCRIPTION & MANUFACTURER	MODEL NO.	SERIAL NO.	DATE OF CALIBRATION	DUE DATE OF CALIBRATION
Test Receiver ROHDE & SCHWARZ	ESCI	100744	Apr. 19, 2012	Apr. 18, 2013
Spectrum Analyzer ROHDE & SCHWARZ	FSP40	100269	Jan. 28, 2013	Jan. 27, 2014
BILOG Antenna SCHWARZBECK	VULB9168	9168-156	Apr. 03, 2012	Apr. 02, 2013
HORN Antenna SCHWARZBECK	BBHA 9120 D	9120D-209	Sep. 03, 2012	Sep. 02, 2013
HORN Antenna SCHWARZBECK	BBHA 9170	148	Jul. 11, 2012	Jul. 10, 2013
Preamplifier Agilent	8449B	3008A01911	Oct. 25, 2012	Oct. 24, 2013
Preamplifier Agilent	8447D	2944A10638	Oct. 25, 2012	Oct. 24, 2013
RF signal cable HUBER+SUHNNER	SUCOFLEX 104	295013/4 283403/4	Aug. 28, 2012	Aug. 27, 2013
RF signal cable Worken	8D-FB	Cable-HYCH9-01	Aug. 11, 2012	Aug. 10, 2013
Software	ADT_Radiated_ V7.6.15.9.2	NA	NA	NA
Antenna Tower EMCO	2070/2080	512.835.4684	NA	NA
Turn Table EMCO	2087-2.03	NA	NA	NA
Antenna Tower & Turn Table Controller EMCO	2090	NA	NA	NA
26GHz ~ 40GHz Amplifier	EM26400	815221	Oct. 25, 2012	Oct. 24, 2013
High Speed Peak Power Meter	ML2495A	0824011	Jul. 30, 2012	Jul. 29, 2013
Power Sensor	MA2411B	0738171	Jul. 30, 2012	Jul. 29, 2013
WIT Standard Temperature And Humidity Chamber	TH-4S-C	W981030	Jun. 13, 2012	Jun. 12, 2013

- NOTE:**
1. The calibration interval of the above test instruments is 12 months and the calibrations are traceable to NML/ROC and NIST/USA.
 2. The test was performed in HwaYa Chamber 9.
 3. The horn antenna and HP preamplifier (model: 8449B) are used only for the measurement of emission frequency above 1GHz if tested.
 4. The FCC Site Registration No. is 215374.
 5. The IC Site Registration No. is IC 7450F-9.

4.1.4 TEST PROCEDURES

- a. The EUT was placed on the top of a rotating table 0.8 meters above the ground at a 3 meter semi-anechoic chamber. The table was rotated 360 degrees to determine the position of the highest radiation.
- b. The EUT was set 3 meters away from the interference-receiving antenna, which was mounted on the top of a variable-height antenna tower.
- c. The antenna is a broadband antenna, and its height is varied from one meter to four meters above the ground to determine the maximum value of the field strength. Both horizontal and vertical polarizations of the antenna are set to make the measurement.
- d. For each suspected emission, the EUT was arranged to its worst case and then the antenna was tuned to heights from 1 meter to 4 meters and the rotatable table was turned from 0 degrees to 360 degrees to find the maximum reading.
- e. The test-receiver system was set to Peak Detect Function and Specified Bandwidth with Maximum Hold Mode.
- f. If the emission level of the EUT in peak mode was 10dB lower than the limit specified, then testing could be stopped and the peak values of the EUT would be reported. Otherwise the emissions that did not have 10dB margin would be re-tested one by one using peak, quasi-peak or average method as specified and then reported in a data sheet.

NOTE:

1. The resolution bandwidth and video bandwidth of test receiver/spectrum analyzer is 120kHz for Peak detection (PK) and Quasi-peak detection (QP) at frequency below 1GHz.
2. The resolution bandwidth of test receiver/spectrum analyzer is 1MHz and video bandwidth is 3MHz for Peak detection at frequency above 1GHz.
3. The resolution bandwidth of test receiver/spectrum analyzer is 1MHz and the video bandwidth is 1kHz for Average detection (AV) at frequency above 1GHz.
4. All modes of operation were investigated and the worst-case emissions are reported.

4.1.5 DEVIATION FROM TEST STANDARD

No deviation.

4.1.6 TEST SETUP

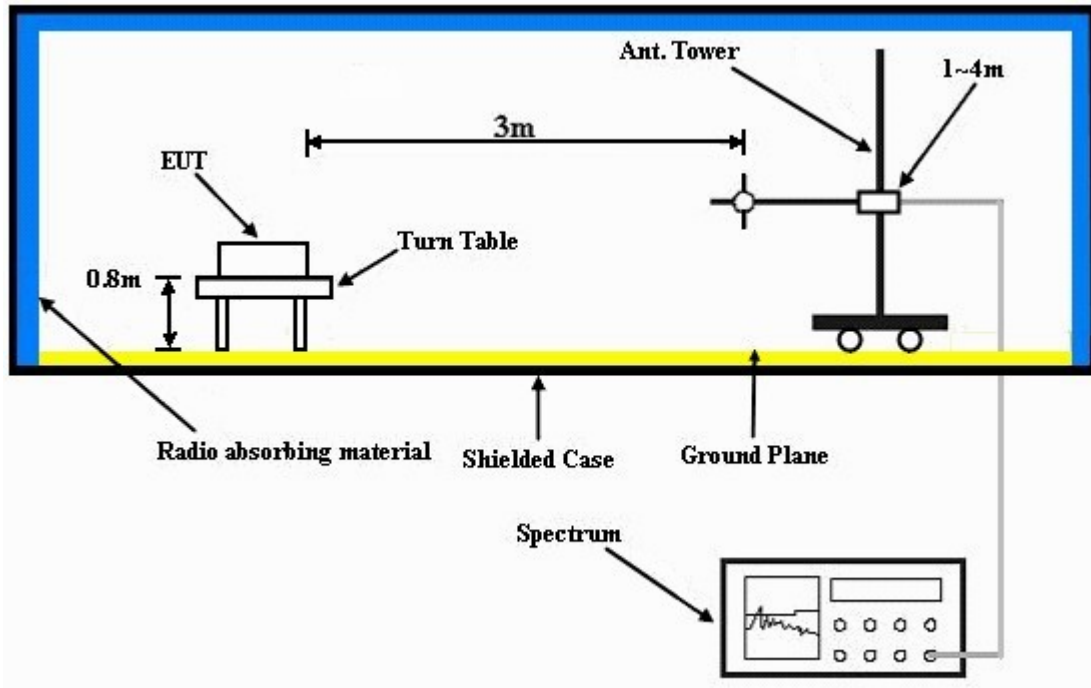

For the actual test configuration, please refer to the attached file (Test Setup Photo).

4.1.7 EUT OPERATING CONDITION

- Connected EUT to notebook system and placed on the testing table.
- The notebook system ran a test program (provided by manufacturer) to enable EUT under transmission condition continuously at specific channel frequency.

4.1.8 TEST RESULTS

802.11a

EUT TEST CONDITION		MEASUREMENT DETAIL	
CHANNEL	Channel 36	FREQUENCY RANGE	1 ~ 40GHz
INPUT POWER (SYSTEM)	120Vac, 60Hz	DETECTOR FUNCTION	Peak (PK) Average (AV)
ENVIRONMENTAL CONDITIONS	23deg. C, 71%RH	TESTED BY	Alan Wu

ANTENNA POLARITY & TEST DISTANCE: HORIZONTAL AT 3 M								
NO.	FREQ. (MHz)	EMISSION LEVEL (dBuV/m)	LIMIT (dBuV/m)	MARGIN (dB)	ANTENNA HEIGHT (m)	TABLE ANGLE (Degree)	RAW VALUE (dBuV)	CORRECTION FACTOR (dB/m)
1	5150.00	64.2 PK	74.0	-9.8	1.00 H	30	24.70	39.50
2	5150.00	46.9 AV	54.0	-7.1	1.00 H	30	7.40	39.50
3	*5180.00	106.5 PK			1.00 H	33	67.00	39.50
4	*5180.00	92.8 AV			1.00 H	33	53.30	39.50
5	#10360.00	58.4 PK	74.0	-15.6	1.20 H	10	11.70	46.70
6	#10360.00	44.9 AV	54.0	-9.1	1.20 H	10	-1.80	46.70
ANTENNA POLARITY & TEST DISTANCE: VERTICAL AT 3 M								
NO.	FREQ. (MHz)	EMISSION LEVEL (dBuV/m)	LIMIT (dBuV/m)	MARGIN (dB)	ANTENNA HEIGHT (m)	TABLE ANGLE (Degree)	RAW VALUE (dBuV)	CORRECTION FACTOR (dB/m)
1	5150.00	63.6 PK	74.0	-10.4	1.00 V	141	24.10	39.50
2	5150.00	45.5 AV	54.0	-8.5	1.00 V	141	6.00	39.50
3	*5180.00	100.4 PK			1.00 V	141	60.90	39.50
4	*5180.00	87.6 AV			1.00 V	141	48.10	39.50
5	#10360.00	58.2 PK	74.0	-15.8	1.31 V	60	11.50	46.70
6	#10360.00	44.3 AV	54.0	-9.7	1.31 V	60	-2.40	46.70

REMARKS:

1. Emission level (dBuV/m) = Raw Value (dBuV) + Correction Factor (dB/m).
2. Correction Factor (dB/m) = Antenna Factor (dB/m) + Cable Factor (dB).
3. The other emission levels were very low against the limit.
4. Margin value = Emission level – Limit value.
5. " * ": Fundamental frequency.
6. " # ": The radiated frequency is out of the restricted band.



A D T

EUT TEST CONDITION		MEASUREMENT DETAIL	
CHANNEL	Channel 40	FREQUENCY RANGE	1 ~ 40GHz
INPUT POWER (SYSTEM)	120Vac, 60Hz	DETECTOR FUNCTION	Peak (PK) Average (AV)
ENVIRONMENTAL CONDITIONS	23deg. C, 71%RH	TESTED BY	Alan Wu

ANTENNA POLARITY & TEST DISTANCE: HORIZONTAL AT 3 M								
NO.	FREQ. (MHz)	EMISSION LEVEL (dBuV/m)	LIMIT (dBuV/m)	MARGIN (dB)	ANTENNA HEIGHT (m)	TABLE ANGLE (Degree)	RAW VALUE (dBuV)	CORRECTION FACTOR (dB/m)
1	*5200.00	105.5 PK			1.00 H	34	66.00	39.50
2	*5200.00	91.9 AV			1.00 H	34	52.40	39.50
3	#10400.00	59.3 PK	74.0	-14.7	1.20 H	9	12.60	46.70
4	#10400.00	45.8 AV	54.0	-8.2	1.20 H	9	-0.90	46.70
ANTENNA POLARITY & TEST DISTANCE: VERTICAL AT 3 M								
NO.	FREQ. (MHz)	EMISSION LEVEL (dBuV/m)	LIMIT (dBuV/m)	MARGIN (dB)	ANTENNA HEIGHT (m)	TABLE ANGLE (Degree)	RAW VALUE (dBuV)	CORRECTION FACTOR (dB/m)
1	*5200.00	99.5 PK			1.00 V	141	60.00	39.50
2	*5200.00	87.4 AV			1.00 V	141	47.90	39.50
3	#10400.00	59.2 PK	74.0	-14.8	1.30 V	68	12.50	46.70
4	#10400.00	45.3 AV	54.0	-8.7	1.30 V	68	-1.40	46.70

REMARKS:

1. Emission level (dBuV/m) = Raw Value (dBuV) + Correction Factor (dB/m).
2. Correction Factor (dB/m) = Antenna Factor (dB/m) + Cable Factor (dB).
3. The other emission levels were very low against the limit.
4. Margin value = Emission level – Limit value.
5. " * ": Fundamental frequency.
6. " # ": The radiated frequency is out of the restricted band.



A D T

EUT TEST CONDITION		MEASUREMENT DETAIL	
CHANNEL	Channel 48	FREQUENCY RANGE	1 ~ 40GHz
INPUT POWER (SYSTEM)	120Vac, 60Hz	DETECTOR FUNCTION	Peak (PK) Average (AV)
ENVIRONMENTAL CONDITIONS	23deg. C, 71%RH	TESTED BY	Alan Wu

ANTENNA POLARITY & TEST DISTANCE: HORIZONTAL AT 3 M								
NO.	FREQ. (MHz)	EMISSION LEVEL (dBuV/m)	LIMIT (dBuV/m)	MARGIN (dB)	ANTENNA HEIGHT (m)	TABLE ANGLE (Degree)	RAW VALUE (dBuV)	CORRECTION FACTOR (dB/m)
1	5150.00	62.9 PK	74.0	-11.1	1.00 H	37	23.40	39.50
2	5150.00	45.0 AV	54.0	-9.0	1.00 H	37	5.50	39.50
3	*5240.00	106.0 PK			1.00 H	34	66.40	39.60
4	*5240.00	92.4 AV			1.00 H	34	52.80	39.60
5	#10480.00	58.2 PK	74.0	-15.8	1.20 H	7	11.40	46.80
6	#10480.00	45.2 AV	54.0	-8.8	1.20 H	7	-1.60	46.80
ANTENNA POLARITY & TEST DISTANCE: VERTICAL AT 3 M								
NO.	FREQ. (MHz)	EMISSION LEVEL (dBuV/m)	LIMIT (dBuV/m)	MARGIN (dB)	ANTENNA HEIGHT (m)	TABLE ANGLE (Degree)	RAW VALUE (dBuV)	CORRECTION FACTOR (dB/m)
1	5150.00	62.1 PK	74.0	-11.9	1.19 V	119	22.60	39.50
2	5150.00	44.5 AV	54.0	-9.5	1.19 V	119	5.00	39.50
3	*5240.00	101.4 PK			1.14 V	115	61.80	39.60
4	*5240.00	88.0 AV			1.14 V	115	48.40	39.60
5	#10480.00	58.0 PK	74.0	-16.0	1.39 V	69	11.20	46.80
6	#10480.00	44.7 AV	54.0	-9.3	1.39 V	69	-2.10	46.80

REMARKS:

1. Emission level (dBuV/m) = Raw Value (dBuV) + Correction Factor (dB/m).
2. Correction Factor (dB/m) = Antenna Factor (dB/m) + Cable Factor (dB).
3. The other emission levels were very low against the limit.
4. Margin value = Emission level – Limit value.
5. " * ": Fundamental frequency.
6. " # ": The radiated frequency is out of the restricted band.



A D T

EUT TEST CONDITION		MEASUREMENT DETAIL	
CHANNEL	Channel 52	FREQUENCY RANGE	1 ~ 40GHz
INPUT POWER (SYSTEM)	120Vac, 60Hz	DETECTOR FUNCTION	Peak (PK) Average (AV)
ENVIRONMENTAL CONDITIONS	23deg. C, 71%RH	TESTED BY	Alan Wu

ANTENNA POLARITY & TEST DISTANCE: HORIZONTAL AT 3 M								
NO.	FREQ. (MHz)	EMISSION LEVEL (dBuV/m)	LIMIT (dBuV/m)	MARGIN (dB)	ANTENNA HEIGHT (m)	TABLE ANGLE (Degree)	RAW VALUE (dBuV)	CORRECTION FACTOR (dB/m)
1	*5260.00	105.6 PK			1.03 H	324	66.00	39.60
2	*5260.00	92.6 AV			1.03 H	324	53.00	39.60
3	5350.00	62.3 PK	74.0	-11.7	1.02 H	323	22.50	39.80
4	5350.00	44.9 AV	54.0	-9.1	1.02 H	323	5.10	39.80
5	#10520.00	58.3 PK	74.0	-15.7	1.10 H	20	11.50	46.80
6	#10520.00	44.8 AV	54.0	-9.2	1.10 H	20	-2.00	46.80
ANTENNA POLARITY & TEST DISTANCE: VERTICAL AT 3 M								
NO.	FREQ. (MHz)	EMISSION LEVEL (dBuV/m)	LIMIT (dBuV/m)	MARGIN (dB)	ANTENNA HEIGHT (m)	TABLE ANGLE (Degree)	RAW VALUE (dBuV)	CORRECTION FACTOR (dB/m)
1	*5260.00	100.6 PK			1.00 V	173	61.00	39.60
2	*5260.00	87.9 AV			1.00 V	173	48.30	39.60
3	5350.00	61.5 PK	74.0	-12.5	1.00 V	175	21.70	39.80
4	5350.00	44.3 AV	54.0	-9.7	1.00 V	175	4.50	39.80
5	#10520.00	58.1 PK	74.0	-15.9	1.30 V	65	11.30	46.80
6	#10520.00	44.2 AV	54.0	-9.8	1.30 V	65	-2.60	46.80

REMARKS:

1. Emission level (dBuV/m) = Raw Value (dBuV) + Correction Factor (dB/m).
2. Correction Factor (dB/m) = Antenna Factor (dB/m) + Cable Factor (dB).
3. The other emission levels were very low against the limit.
4. Margin value = Emission level – Limit value.
5. " * ": Fundamental frequency.
6. " # ": The radiated frequency is out of the restricted band.



A D T

EUT TEST CONDITION		MEASUREMENT DETAIL	
CHANNEL	Channel 60	FREQUENCY RANGE	1 ~ 40GHz
INPUT POWER (SYSTEM)	120Vac, 60Hz	DETECTOR FUNCTION	Peak (PK) Average (AV)
ENVIRONMENTAL CONDITIONS	23deg. C, 71%RH	TESTED BY	Alan Wu

ANTENNA POLARITY & TEST DISTANCE: HORIZONTAL AT 3 M								
NO.	FREQ. (MHz)	EMISSION LEVEL (dBuV/m)	LIMIT (dBuV/m)	MARGIN (dB)	ANTENNA HEIGHT (m)	TABLE ANGLE (Degree)	RAW VALUE (dBuV)	CORRECTION FACTOR (dB/m)
1	*5300.00	105.4 PK			1.03 H	335	65.70	39.70
2	*5300.00	92.4 AV			1.03 H	335	52.70	39.70
3	10600.00	58.9 PK	74.0	-15.1	1.14 H	29	12.10	46.80
4	10600.00	45.6 AV	54.0	-8.4	1.14 H	29	-1.20	46.80
ANTENNA POLARITY & TEST DISTANCE: VERTICAL AT 3 M								
NO.	FREQ. (MHz)	EMISSION LEVEL (dBuV/m)	LIMIT (dBuV/m)	MARGIN (dB)	ANTENNA HEIGHT (m)	TABLE ANGLE (Degree)	RAW VALUE (dBuV)	CORRECTION FACTOR (dB/m)
1	*5300.00	100.8 PK			1.00 V	172	61.10	39.70
2	*5300.00	89.0 AV			1.00 V	172	49.30	39.70
3	10600.00	58.7 PK	74.0	-15.3	1.37 V	69	11.90	46.80
4	10600.00	45.1 AV	54.0	-8.9	1.37 V	69	-1.70	46.80

REMARKS:

1. Emission level (dBuV/m) = Raw Value (dBuV) + Correction Factor (dB/m).
2. Correction Factor (dB/m) = Antenna Factor (dB/m) + Cable Factor (dB).
3. The other emission levels were very low against the limit.
4. Margin value = Emission level – Limit value.
5. " * ": Fundamental frequency.



A D T

EUT TEST CONDITION		MEASUREMENT DETAIL	
CHANNEL	Channel 64	FREQUENCY RANGE	1 ~ 40GHz
INPUT POWER (SYSTEM)	120Vac, 60Hz	DETECTOR FUNCTION	Peak (PK) Average (AV)
ENVIRONMENTAL CONDITIONS	23deg. C, 71%RH	TESTED BY	Alan Wu

ANTENNA POLARITY & TEST DISTANCE: HORIZONTAL AT 3 M								
NO.	FREQ. (MHz)	EMISSION LEVEL (dBuV/m)	LIMIT (dBuV/m)	MARGIN (dB)	ANTENNA HEIGHT (m)	TABLE ANGLE (Degree)	RAW VALUE (dBuV)	CORRECTION FACTOR (dB/m)
1	*5320.00	105.3 PK			1.03 H	334	65.60	39.70
2	*5320.00	91.8 AV			1.03 H	334	52.10	39.70
3	5350.00	60.4 PK	74.0	-13.6	1.02 H	337	20.60	39.80
4	5350.00	47.9 AV	54.0	-6.1	1.02 H	337	8.10	39.80
5	10640.00	59.5 PK	74.0	-14.5	1.27 H	2	12.60	46.90
6	10640.00	45.6 AV	54.0	-8.4	1.27 H	2	-1.30	46.90
ANTENNA POLARITY & TEST DISTANCE: VERTICAL AT 3 M								
NO.	FREQ. (MHz)	EMISSION LEVEL (dBuV/m)	LIMIT (dBuV/m)	MARGIN (dB)	ANTENNA HEIGHT (m)	TABLE ANGLE (Degree)	RAW VALUE (dBuV)	CORRECTION FACTOR (dB/m)
1	*5320.00	101.5 PK			1.70 V	109	61.80	39.70
2	*5320.00	88.8 AV			1.70 V	109	49.10	39.70
3	5350.00	59.4 PK	74.0	-14.6	1.66 V	102	19.60	39.80
4	5350.00	46.6 AV	54.0	-7.4	1.66 V	102	6.80	39.80
5	10640.00	58.4 PK	74.0	-15.6	1.32 V	66	11.50	46.90
6	10640.00	45.1 AV	54.0	-8.9	1.32 V	66	-1.80	46.90

REMARKS:

1. Emission level (dBuV/m) = Raw Value (dBuV) + Correction Factor (dB/m).
2. Correction Factor (dB/m) = Antenna Factor (dB/m) + Cable Factor (dB).
3. The other emission levels were very low against the limit.
4. Margin value = Emission level – Limit value.
5. " * ": Fundamental frequency.



A D T

EUT TEST CONDITION		MEASUREMENT DETAIL	
CHANNEL	Channel 100	FREQUENCY RANGE	1 ~ 40GHz
INPUT POWER (SYSTEM)	120Vac, 60Hz	DETECTOR FUNCTION	Peak (PK) Average (AV)
ENVIRONMENTAL CONDITIONS	23deg. C, 71%RH	TESTED BY	Cedric Wu

ANTENNA POLARITY & TEST DISTANCE: HORIZONTAL AT 3 M								
NO.	FREQ. (MHz)	EMISSION LEVEL (dBuV/m)	LIMIT (dBuV/m)	MARGIN (dB)	ANTENNA HEIGHT (m)	TABLE ANGLE (Degree)	RAW VALUE (dBuV)	CORRECTION FACTOR (dB/m)
1	5460.00	58.3 PK	74.0	-15.7	1.00 H	6	18.30	40.00
2	5460.00	46.2 AV	54.0	-7.8	1.00 H	6	6.20	40.00
3	#5470.00	60.1 PK	74.0	-13.9	1.00 H	5	20.10	40.00
4	#5470.00	39.8 AV	54.0	-14.2	1.00 H	5	-0.20	40.00
5	*5500.00	102.0 PK			1.00 H	4	62.00	40.00
6	*5500.00	90.2 AV			1.00 H	4	50.20	40.00
7	11000.00	56.7 PK	74.0	-17.3	1.00 H	14	9.00	47.70
8	11000.00	44.9 AV	54.0	-9.1	1.00 H	14	-2.80	47.70
ANTENNA POLARITY & TEST DISTANCE: VERTICAL AT 3 M								
NO.	FREQ. (MHz)	EMISSION LEVEL (dBuV/m)	LIMIT (dBuV/m)	MARGIN (dB)	ANTENNA HEIGHT (m)	TABLE ANGLE (Degree)	RAW VALUE (dBuV)	CORRECTION FACTOR (dB/m)
1	5460.00	58.1 PK	74.0	-15.9	1.00 V	354	18.10	40.00
2	5460.00	45.3 AV	54.0	-8.7	1.00 V	354	5.30	40.00
3	#5470.00	63.2 PK	74.0	-10.8	1.00 V	357	23.20	40.00
4	#5470.00	45.9 AV	54.0	-8.1	1.00 V	357	5.90	40.00
5	*5500.00	97.4 PK			1.00 V	359	57.40	40.00
6	*5500.00	85.0 AV			1.00 V	359	45.00	40.00
7	11000.00	55.5 PK	74.0	-18.5	1.00 V	60	7.80	47.70
8	11000.00	43.8 AV	54.0	-10.2	1.00 V	60	-3.90	47.70

REMARKS:

1. Emission level (dBuV/m) = Raw Value (dBuV) + Correction Factor (dB/m).
2. Correction Factor (dB/m) = Antenna Factor (dB/m) + Cable Factor (dB).
3. The other emission levels were very low against the limit.
4. Margin value = Emission level – Limit value.
5. " * ": Fundamental frequency.
6. " # ": The radiated frequency is out of the restricted band.



A D T

EUT TEST CONDITION		MEASUREMENT DETAIL	
CHANNEL	Channel 116	FREQUENCY RANGE	1 ~ 40GHz
INPUT POWER (SYSTEM)	120Vac, 60Hz	DETECTOR FUNCTION	Peak (PK) Average (AV)
ENVIRONMENTAL CONDITIONS	23deg. C, 71%RH	TESTED BY	Cedric Wu

ANTENNA POLARITY & TEST DISTANCE: HORIZONTAL AT 3 M								
NO.	FREQ. (MHz)	EMISSION LEVEL (dBuV/m)	LIMIT (dBuV/m)	MARGIN (dB)	ANTENNA HEIGHT (m)	TABLE ANGLE (Degree)	RAW VALUE (dBuV)	CORRECTION FACTOR (dB/m)
1	*5580.00	100.4 PK			1.00 H	6	60.30	40.10
2	*5580.00	90.9 AV			1.00 H	6	50.80	40.10
3	11160.00	55.7 PK	74.0	-18.3	1.00 H	25	7.90	47.80
4	11160.00	41.6 AV	54.0	-12.4	1.00 H	25	-6.20	47.80
ANTENNA POLARITY & TEST DISTANCE: VERTICAL AT 3 M								
NO.	FREQ. (MHz)	EMISSION LEVEL (dBuV/m)	LIMIT (dBuV/m)	MARGIN (dB)	ANTENNA HEIGHT (m)	TABLE ANGLE (Degree)	RAW VALUE (dBuV)	CORRECTION FACTOR (dB/m)
1	*5580.00	95.5 PK			1.00 V	196	55.40	40.10
2	*5580.00	85.7 AV			1.00 V	196	45.60	40.10
3	11160.00	54.3 PK	74.0	-19.7	1.00 V	200	6.50	47.80
4	11160.00	40.3 AV	54.0	-13.7	1.00 V	200	-7.50	47.80

REMARKS:

1. Emission level (dBuV/m) = Raw Value (dBuV) + Correction Factor (dB/m).
2. Correction Factor (dB/m) = Antenna Factor (dB/m) + Cable Factor (dB).
3. The other emission levels were very low against the limit.
4. Margin value = Emission level – Limit value.
5. " * ": Fundamental frequency.



A D T

EUT TEST CONDITION		MEASUREMENT DETAIL	
CHANNEL	Channel 140	FREQUENCY RANGE	1 ~ 40GHz
INPUT POWER (SYSTEM)	120Vac, 60Hz	DETECTOR FUNCTION	Peak (PK) Average (AV)
ENVIRONMENTAL CONDITIONS	23deg. C, 71%RH	TESTED BY	Cedric Wu

ANTENNA POLARITY & TEST DISTANCE: HORIZONTAL AT 3 M								
NO.	FREQ. (MHz)	EMISSION LEVEL (dBuV/m)	LIMIT (dBuV/m)	MARGIN (dB)	ANTENNA HEIGHT (m)	TABLE ANGLE (Degree)	RAW VALUE (dBuV)	CORRECTION FACTOR (dB/m)
1	*5700.00	101.8 PK			1.04 H	296	61.60	40.20
2	*5700.00	91.3 AV			1.04 H	296	51.10	40.20
3	#5725.00	56.8 PK	74.0	-17.2	1.05 H	296	16.50	40.30
4	#5725.00	44.5 AV	54.0	-9.5	1.05 H	296	4.20	40.30
5	11400.00	56.3 PK	74.0	-17.7	1.00 H	35	8.10	48.20
6	11400.00	42.2 AV	54.0	-11.8	1.00 H	35	-6.00	48.20
ANTENNA POLARITY & TEST DISTANCE: VERTICAL AT 3 M								
NO.	FREQ. (MHz)	EMISSION LEVEL (dBuV/m)	LIMIT (dBuV/m)	MARGIN (dB)	ANTENNA HEIGHT (m)	TABLE ANGLE (Degree)	RAW VALUE (dBuV)	CORRECTION FACTOR (dB/m)
1	*5700.00	96.3 PK			1.00 V	194	56.10	40.20
2	*5700.00	84.8 AV			1.00 V	194	44.60	40.20
3	#5725.00	53.9 PK	74.0	-20.1	1.00 V	190	13.60	40.30
4	#5725.00	42.1 AV	54.0	-11.9	1.00 V	190	1.80	40.30
5	11400.00	55.0 PK	74.0	-19.0	1.00 V	216	6.80	48.20
6	11400.00	40.8 AV	54.0	-13.2	1.00 V	216	-7.40	48.20

REMARKS:

1. Emission level (dBuV/m) = Raw Value (dBuV) + Correction Factor (dB/m).
2. Correction Factor (dB/m) = Antenna Factor (dB/m) + Cable Factor (dB).
3. The other emission levels were very low against the limit.
4. Margin value = Emission level – Limit value.
5. " * " : Fundamental frequency.
6. " # " : The radiated frequency is out of the restricted band.

802.11n (20MHz)

EUT TEST CONDITION		MEASUREMENT DETAIL	
CHANNEL	Channel 36	FREQUENCY RANGE	1 ~ 40GHz
INPUT POWER (SYSTEM)	120Vac, 60Hz	DETECTOR FUNCTION	Peak (PK) Average (AV)
ENVIRONMENTAL CONDITIONS	23deg. C, 71%RH	TESTED BY	Alan Wu

ANTENNA POLARITY & TEST DISTANCE: HORIZONTAL AT 3 M								
NO.	FREQ. (MHz)	EMISSION LEVEL (dBuV/m)	LIMIT (dBuV/m)	MARGIN (dB)	ANTENNA HEIGHT (m)	TABLE ANGLE (Degree)	RAW VALUE (dBuV)	CORRECTION FACTOR (dB/m)
1	5150.00	64.1 PK	74.0	-9.9	1.00 H	39	24.60	39.50
2	5150.00	46.7 AV	54.0	-7.3	1.00 H	39	7.20	39.50
3	*5180.00	106.1 PK			1.00 H	34	66.60	39.50
4	*5180.00	92.7 AV			1.00 H	34	53.20	39.50
5	#10360.00	58.1 PK	74.0	-15.9	1.20 H	9	11.40	46.70
6	#10360.00	44.2 AV	54.0	-9.8	1.20 H	9	-2.50	46.70
ANTENNA POLARITY & TEST DISTANCE: VERTICAL AT 3 M								
NO.	FREQ. (MHz)	EMISSION LEVEL (dBuV/m)	LIMIT (dBuV/m)	MARGIN (dB)	ANTENNA HEIGHT (m)	TABLE ANGLE (Degree)	RAW VALUE (dBuV)	CORRECTION FACTOR (dB/m)
1	5150.00	63.5 PK	74.0	-10.5	1.48 V	98	24.00	39.50
2	5150.00	46.6 AV	54.0	-7.4	1.48 V	98	7.10	39.50
3	*5180.00	103.6 PK			1.45 V	92	64.10	39.50
4	*5180.00	91.4 AV			1.45 V	92	51.90	39.50
5	#10360.00	57.9 PK	74.0	-16.1	1.38 V	68	11.20	46.70
6	#10360.00	43.6 AV	54.0	-10.4	1.38 V	68	-3.10	46.70

REMARKS:

1. Emission level (dBuV/m) = Raw Value (dBuV) + Correction Factor (dB/m).
2. Correction Factor (dB/m) = Antenna Factor (dB/m) + Cable Factor (dB).
3. The other emission levels were very low against the limit.
4. Margin value = Emission level – Limit value.
5. " * ": Fundamental frequency.
6. " # ": The radiated frequency is out of the restricted band.



A D T

EUT TEST CONDITION		MEASUREMENT DETAIL	
CHANNEL	Channel 40	FREQUENCY RANGE	1 ~ 40GHz
INPUT POWER (SYSTEM)	120Vac, 60Hz	DETECTOR FUNCTION	Peak (PK) Average (AV)
ENVIRONMENTAL CONDITIONS	23deg. C, 71%RH	TESTED BY	Alan Wu

ANTENNA POLARITY & TEST DISTANCE: HORIZONTAL AT 3 M								
NO.	FREQ. (MHz)	EMISSION LEVEL (dBuV/m)	LIMIT (dBuV/m)	MARGIN (dB)	ANTENNA HEIGHT (m)	TABLE ANGLE (Degree)	RAW VALUE (dBuV)	CORRECTION FACTOR (dB/m)
1	*5200.00	105.3 PK			1.00 H	34	65.80	39.50
2	*5200.00	92.7 AV			1.00 H	34	53.20	39.50
3	#10400.00	59.7 PK	74.0	-14.3	1.29 H	10	13.00	46.70
4	#10400.00	45.8 AV	54.0	-8.2	1.29 H	10	-0.90	46.70
ANTENNA POLARITY & TEST DISTANCE: VERTICAL AT 3 M								
NO.	FREQ. (MHz)	EMISSION LEVEL (dBuV/m)	LIMIT (dBuV/m)	MARGIN (dB)	ANTENNA HEIGHT (m)	TABLE ANGLE (Degree)	RAW VALUE (dBuV)	CORRECTION FACTOR (dB/m)
1	*5200.00	103.2 PK			1.44 V	85	63.70	39.50
2	*5200.00	91.7 AV			1.44 V	85	52.20	39.50
3	#10400.00	58.6 PK	74.0	-15.4	1.33 V	66	11.90	46.70
4	#10400.00	45.2 AV	54.0	-8.8	1.33 V	66	-1.50	46.70

REMARKS:

1. Emission level (dBuV/m) = Raw Value (dBuV) + Correction Factor (dB/m).
2. Correction Factor (dB/m) = Antenna Factor (dB/m) + Cable Factor (dB).
3. The other emission levels were very low against the limit.
4. Margin value = Emission level – Limit value.
5. " * ": Fundamental frequency.
6. " # ": The radiated frequency is out of the restricted band.



A D T

EUT TEST CONDITION		MEASUREMENT DETAIL	
CHANNEL	Channel 48	FREQUENCY RANGE	1 ~ 40GHz
INPUT POWER (SYSTEM)	120Vac, 60Hz	DETECTOR FUNCTION	Peak (PK) Average (AV)
ENVIRONMENTAL CONDITIONS	23deg. C, 71%RH	TESTED BY	Alan Wu

ANTENNA POLARITY & TEST DISTANCE: HORIZONTAL AT 3 M								
NO.	FREQ. (MHz)	EMISSION LEVEL (dBuV/m)	LIMIT (dBuV/m)	MARGIN (dB)	ANTENNA HEIGHT (m)	TABLE ANGLE (Degree)	RAW VALUE (dBuV)	CORRECTION FACTOR (dB/m)
1	5150.00	62.8 PK	74.0	-11.2	1.00 H	33	23.30	39.50
2	5150.00	46.2 AV	54.0	-7.8	1.00 H	33	6.70	39.50
3	*5240.00	105.5 PK			1.00 H	39	65.90	39.60
4	*5240.00	92.3 AV			1.00 H	39	52.70	39.60
5	#10480.00	58.5 PK	74.0	-15.5	1.23 H	3	11.70	46.80
6	#10480.00	46.1 AV	54.0	-7.9	1.23 H	3	-0.70	46.80
ANTENNA POLARITY & TEST DISTANCE: VERTICAL AT 3 M								
NO.	FREQ. (MHz)	EMISSION LEVEL (dBuV/m)	LIMIT (dBuV/m)	MARGIN (dB)	ANTENNA HEIGHT (m)	TABLE ANGLE (Degree)	RAW VALUE (dBuV)	CORRECTION FACTOR (dB/m)
1	5150.00	62.0 PK	74.0	-12.0	1.46 V	90	22.50	39.50
2	5150.00	45.8 AV	54.0	-8.2	1.46 V	90	6.30	39.50
3	*5240.00	103.4 PK			1.44 V	93	63.80	39.60
4	*5240.00	91.5 AV			1.44 V	93	51.90	39.60
5	#10480.00	58.3 PK	74.0	-15.7	1.30 V	66	11.50	46.80
6	#10480.00	45.7 AV	54.0	-8.3	1.30 V	66	-1.10	46.80

REMARKS:

1. Emission level (dBuV/m) = Raw Value (dBuV) + Correction Factor (dB/m).
2. Correction Factor (dB/m) = Antenna Factor (dB/m) + Cable Factor (dB).
3. The other emission levels were very low against the limit.
4. Margin value = Emission level – Limit value.
5. " * " : Fundamental frequency.
6. " # " : The radiated frequency is out of the restricted band.



A D T

EUT TEST CONDITION		MEASUREMENT DETAIL	
CHANNEL	Channel 52	FREQUENCY RANGE	1 ~ 40GHz
INPUT POWER (SYSTEM)	120Vac, 60Hz	DETECTOR FUNCTION	Peak (PK) Average (AV)
ENVIRONMENTAL CONDITIONS	23deg. C, 71%RH	TESTED BY	Alan Wu

ANTENNA POLARITY & TEST DISTANCE: HORIZONTAL AT 3 M								
NO.	FREQ. (MHz)	EMISSION LEVEL (dBuV/m)	LIMIT (dBuV/m)	MARGIN (dB)	ANTENNA HEIGHT (m)	TABLE ANGLE (Degree)	RAW VALUE (dBuV)	CORRECTION FACTOR (dB/m)
1	*5260.00	108.3 PK			1.45 H	293	68.70	39.60
2	*5260.00	96.0 AV			1.45 H	293	56.40	39.60
3	5350.00	63.6 PK	74.0	-10.4	1.45 H	296	23.80	39.80
4	5350.00	46.7 AV	54.0	-7.3	1.45 H	296	6.90	39.80
5	#10520.00	59.2 PK	74.0	-14.8	1.16 H	25	12.40	46.80
6	#10520.00	45.6 AV	54.0	-8.4	1.16 H	25	-1.20	46.80
ANTENNA POLARITY & TEST DISTANCE: VERTICAL AT 3 M								
NO.	FREQ. (MHz)	EMISSION LEVEL (dBuV/m)	LIMIT (dBuV/m)	MARGIN (dB)	ANTENNA HEIGHT (m)	TABLE ANGLE (Degree)	RAW VALUE (dBuV)	CORRECTION FACTOR (dB/m)
1	*5260.00	104.6 PK			1.02 V	95	65.00	39.60
2	*5260.00	91.9 AV			1.02 V	95	52.30	39.60
3	5350.00	62.9 PK	74.0	-11.1	1.06 V	95	23.10	39.80
4	5350.00	46.3 AV	54.0	-7.7	1.06 V	95	6.50	39.80
5	#10520.00	58.1 PK	74.0	-15.9	1.35 V	66	11.30	46.80
6	#10520.00	45.1 AV	54.0	-8.9	1.35 V	66	-1.70	46.80

REMARKS:

1. Emission level (dBuV/m) = Raw Value (dBuV) + Correction Factor (dB/m).
2. Correction Factor (dB/m) = Antenna Factor (dB/m) + Cable Factor (dB).
3. The other emission levels were very low against the limit.
4. Margin value = Emission level – Limit value.
5. " * ": Fundamental frequency.
6. " # ": The radiated frequency is out of the restricted band.



A D T

EUT TEST CONDITION		MEASUREMENT DETAIL	
CHANNEL	Channel 60	FREQUENCY RANGE	1 ~ 40GHz
INPUT POWER (SYSTEM)	120Vac, 60Hz	DETECTOR FUNCTION	Peak (PK) Average (AV)
ENVIRONMENTAL CONDITIONS	23deg. C, 71%RH	TESTED BY	Alan Wu

ANTENNA POLARITY & TEST DISTANCE: HORIZONTAL AT 3 M								
NO.	FREQ. (MHz)	EMISSION LEVEL (dBuV/m)	LIMIT (dBuV/m)	MARGIN (dB)	ANTENNA HEIGHT (m)	TABLE ANGLE (Degree)	RAW VALUE (dBuV)	CORRECTION FACTOR (dB/m)
1	*5300.00	109.0 PK			1.44 H	268	69.30	39.70
2	*5300.00	95.8 AV			1.44 H	268	56.10	39.70
3	10600.00	60.1 PK	74.0	-13.9	1.19 H	26	13.30	46.80
4	10600.00	47.1 AV	54.0	-6.9	1.19 H	26	0.30	46.80
ANTENNA POLARITY & TEST DISTANCE: VERTICAL AT 3 M								
NO.	FREQ. (MHz)	EMISSION LEVEL (dBuV/m)	LIMIT (dBuV/m)	MARGIN (dB)	ANTENNA HEIGHT (m)	TABLE ANGLE (Degree)	RAW VALUE (dBuV)	CORRECTION FACTOR (dB/m)
1	*5300.00	104.0 PK			1.00 V	96	64.30	39.70
2	*5300.00	92.2 AV			1.00 V	96	52.50	39.70
3	10600.00	59.1 PK	74.0	-14.9	1.30 V	65	12.30	46.80
4	10600.00	45.8 AV	54.0	-8.2	1.30 V	65	-1.00	46.80

REMARKS:

1. Emission level (dBuV/m) = Raw Value (dBuV) + Correction Factor (dB/m).
2. Correction Factor (dB/m) = Antenna Factor (dB/m) + Cable Factor (dB).
3. The other emission levels were very low against the limit.
4. Margin value = Emission level – Limit value.
5. " * ": Fundamental frequency.



A D T

EUT TEST CONDITION		MEASUREMENT DETAIL	
CHANNEL	Channel 64	FREQUENCY RANGE	1 ~ 40GHz
INPUT POWER (SYSTEM)	120Vac, 60Hz	DETECTOR FUNCTION	Peak (PK) Average (AV)
ENVIRONMENTAL CONDITIONS	23deg. C, 71%RH	TESTED BY	Alan Wu

ANTENNA POLARITY & TEST DISTANCE: HORIZONTAL AT 3 M								
NO.	FREQ. (MHz)	EMISSION LEVEL (dBuV/m)	LIMIT (dBuV/m)	MARGIN (dB)	ANTENNA HEIGHT (m)	TABLE ANGLE (Degree)	RAW VALUE (dBuV)	CORRECTION FACTOR (dB/m)
1	*5320.00	108.4 PK			1.71 H	269	68.70	39.70
2	*5320.00	95.8 AV			1.71 H	269	56.10	39.70
3	5350.00	64.5 PK	74.0	-9.5	1.72 H	261	24.70	39.80
4	5350.00	48.6 AV	54.0	-5.4	1.72 H	261	8.80	39.80
5	10640.00	60.0 PK	74.0	-14.0	1.11 H	22	13.10	46.90
6	10640.00	46.3 AV	54.0	-7.7	1.11 H	22	-0.60	46.90
ANTENNA POLARITY & TEST DISTANCE: VERTICAL AT 3 M								
NO.	FREQ. (MHz)	EMISSION LEVEL (dBuV/m)	LIMIT (dBuV/m)	MARGIN (dB)	ANTENNA HEIGHT (m)	TABLE ANGLE (Degree)	RAW VALUE (dBuV)	CORRECTION FACTOR (dB/m)
1	*5320.00	104.2 PK			1.00 V	97	64.50	39.70
2	*5320.00	91.3 AV			1.00 V	97	51.60	39.70
3	5350.00	64.1 PK	74.0	-9.9	1.00 V	97	24.30	39.80
4	5350.00	47.4 AV	54.0	-6.6	1.00 V	97	7.60	39.80
5	10640.00	59.5 PK	74.0	-14.5	1.37 V	69	12.60	46.90
6	10640.00	45.9 AV	54.0	-8.1	1.37 V	69	-1.00	46.90

REMARKS:

1. Emission level (dBuV/m) = Raw Value (dBuV) + Correction Factor (dB/m).
2. Correction Factor (dB/m) = Antenna Factor (dB/m) + Cable Factor (dB).
3. The other emission levels were very low against the limit.
4. Margin value = Emission level – Limit value.
5. " * ": Fundamental frequency.



A D T

EUT TEST CONDITION		MEASUREMENT DETAIL	
CHANNEL	Channel 100	FREQUENCY RANGE	1 ~ 40GHz
INPUT POWER (SYSTEM)	120Vac, 60Hz	DETECTOR FUNCTION	Peak (PK) Average (AV)
ENVIRONMENTAL CONDITIONS	23deg. C, 71%RH	TESTED BY	Cedric Wu

ANTENNA POLARITY & TEST DISTANCE: HORIZONTAL AT 3 M								
NO.	FREQ. (MHz)	EMISSION LEVEL (dBuV/m)	LIMIT (dBuV/m)	MARGIN (dB)	ANTENNA HEIGHT (m)	TABLE ANGLE (Degree)	RAW VALUE (dBuV)	CORRECTION FACTOR (dB/m)
1	5460.00	58.9 PK	74.0	-15.1	1.00 H	235	18.90	40.00
2	5460.00	44.5 AV	54.0	-9.5	1.00 H	235	4.50	40.00
3	#5470.00	66.7 PK	74.0	-7.3	1.00 H	238	26.70	40.00
4	#5470.00	47.4 AV	54.0	-6.6	1.00 H	238	7.40	40.00
5	*5500.00	104.0 PK			1.00 H	237	64.00	40.00
6	*5500.00	93.6 AV			1.00 H	237	53.60	40.00
7	11000.00	53.3 PK	74.0	-20.7	1.00 H	20	5.60	47.70
8	11000.00	41.3 AV	54.0	-12.7	1.00 H	20	-6.40	47.70
ANTENNA POLARITY & TEST DISTANCE: VERTICAL AT 3 M								
NO.	FREQ. (MHz)	EMISSION LEVEL (dBuV/m)	LIMIT (dBuV/m)	MARGIN (dB)	ANTENNA HEIGHT (m)	TABLE ANGLE (Degree)	RAW VALUE (dBuV)	CORRECTION FACTOR (dB/m)
1	5460.00	58.6 PK	74.0	-15.4	1.32 V	64	18.60	40.00
2	5460.00	44.2 AV	54.0	-9.8	1.32 V	64	4.20	40.00
3	#5470.00	62.9 PK	74.0	-11.1	1.30 V	68	22.90	40.00
4	#5470.00	46.1 AV	54.0	-7.9	1.30 V	68	6.10	40.00
5	*5500.00	103.1 PK			1.34 V	68	63.10	40.00
6	*5500.00	93.4 AV			1.34 V	68	53.40	40.00
7	11000.00	52.5 PK	74.0	-21.5	1.00 V	70	4.80	47.70
8	11000.00	40.6 AV	54.0	-13.4	1.00 V	70	-7.10	47.70

REMARKS:

1. Emission level (dBuV/m) = Raw Value (dBuV) + Correction Factor (dB/m).
2. Correction Factor (dB/m) = Antenna Factor (dB/m) + Cable Factor (dB).
3. The other emission levels were very low against the limit.
4. Margin value = Emission level – Limit value.
5. " * ": Fundamental frequency.
6. " # ": The radiated frequency is out of the restricted band.



A D T

EUT TEST CONDITION		MEASUREMENT DETAIL	
CHANNEL	Channel 116	FREQUENCY RANGE	1 ~ 40GHz
INPUT POWER (SYSTEM)	120Vac, 60Hz	DETECTOR FUNCTION	Peak (PK) Average (AV)
ENVIRONMENTAL CONDITIONS	23deg. C, 71%RH	TESTED BY	Cedric Wu

ANTENNA POLARITY & TEST DISTANCE: HORIZONTAL AT 3 M								
NO.	FREQ. (MHz)	EMISSION LEVEL (dBuV/m)	LIMIT (dBuV/m)	MARGIN (dB)	ANTENNA HEIGHT (m)	TABLE ANGLE (Degree)	RAW VALUE (dBuV)	CORRECTION FACTOR (dB/m)
1	*5580.00	103.2 PK			1.00 H	236	63.10	40.10
2	*5580.00	93.2 AV			1.00 H	236	53.10	40.10
3	11160.00	53.9 PK	74.0	-20.1	1.00 H	35	6.10	47.80
4	11160.00	41.8 AV	54.0	-12.2	1.00 H	35	-6.00	47.80
ANTENNA POLARITY & TEST DISTANCE: VERTICAL AT 3 M								
NO.	FREQ. (MHz)	EMISSION LEVEL (dBuV/m)	LIMIT (dBuV/m)	MARGIN (dB)	ANTENNA HEIGHT (m)	TABLE ANGLE (Degree)	RAW VALUE (dBuV)	CORRECTION FACTOR (dB/m)
1	*5580.00	102.6 PK			1.32 V	95	62.50	40.10
2	*5580.00	93.5 AV			1.32 V	95	53.40	40.10
3	11160.00	53.0 PK	74.0	-21.0	1.00 V	76	5.20	47.80
4	11160.00	41.1 AV	54.0	-12.9	1.00 V	76	-6.70	47.80

REMARKS:

1. Emission level (dBuV/m) = Raw Value (dBuV) + Correction Factor (dB/m).
2. Correction Factor (dB/m) = Antenna Factor (dB/m) + Cable Factor (dB).
3. The other emission levels were very low against the limit.
4. Margin value = Emission level – Limit value.
5. " * ": Fundamental frequency.



A D T

EUT TEST CONDITION		MEASUREMENT DETAIL	
CHANNEL	Channel 140	FREQUENCY RANGE	1 ~ 40GHz
INPUT POWER (SYSTEM)	120Vac, 60Hz	DETECTOR FUNCTION	Peak (PK) Average (AV)
ENVIRONMENTAL CONDITIONS	23deg. C, 71%RH	TESTED BY	Cedric Wu

ANTENNA POLARITY & TEST DISTANCE: HORIZONTAL AT 3 M								
NO.	FREQ. (MHz)	EMISSION LEVEL (dBuV/m)	LIMIT (dBuV/m)	MARGIN (dB)	ANTENNA HEIGHT (m)	TABLE ANGLE (Degree)	RAW VALUE (dBuV)	CORRECTION FACTOR (dB/m)
1	*5700.00	103.4 PK			1.02 H	271	63.20	40.20
2	*5700.00	92.6 AV			1.02 H	271	52.40	40.20
3	#5725.00	59.7 PK	74.0	-14.3	1.03 H	270	19.40	40.30
4	#5725.00	44.7 AV	54.0	-9.3	1.03 H	270	4.40	40.30
5	11400.00	53.0 PK	74.0	-21.0	1.00 H	17	4.80	48.20
6	11400.00	40.9 AV	54.0	-13.1	1.00 H	17	-7.30	48.20
ANTENNA POLARITY & TEST DISTANCE: VERTICAL AT 3 M								
NO.	FREQ. (MHz)	EMISSION LEVEL (dBuV/m)	LIMIT (dBuV/m)	MARGIN (dB)	ANTENNA HEIGHT (m)	TABLE ANGLE (Degree)	RAW VALUE (dBuV)	CORRECTION FACTOR (dB/m)
1	*5700.00	102.5 PK			1.42 V	69	62.30	40.20
2	*5700.00	92.7 AV			1.42 V	69	52.50	40.20
3	#5725.00	56.6 PK	74.0	-17.4	1.40 V	67	16.30	40.30
4	#5725.00	43.8 AV	54.0	-10.2	1.40 V	67	3.50	40.30
5	11400.00	52.1 PK	74.0	-21.9	1.00 V	79	3.90	48.20
6	11400.00	40.3 AV	54.0	-13.7	1.00 V	79	-7.90	48.20

REMARKS:

1. Emission level (dBuV/m) = Raw Value (dBuV) + Correction Factor (dB/m).
2. Correction Factor (dB/m) = Antenna Factor (dB/m) + Cable Factor (dB).
3. The other emission levels were very low against the limit.
4. Margin value = Emission level – Limit value.
5. " * ": Fundamental frequency.
6. " # ": The radiated frequency is out of the restricted band.

802.11n (40MHz)

EUT TEST CONDITION		MEASUREMENT DETAIL	
CHANNEL	Channel 38	FREQUENCY RANGE	1 ~ 40GHz
INPUT POWER (SYSTEM)	120Vac, 60Hz	DETECTOR FUNCTION	Peak (PK) Average (AV)
ENVIRONMENTAL CONDITIONS	23deg. C, 71%RH	TESTED BY	Alan Wu

ANTENNA POLARITY & TEST DISTANCE: HORIZONTAL AT 3 M								
NO.	FREQ. (MHz)	EMISSION LEVEL (dBuV/m)	LIMIT (dBuV/m)	MARGIN (dB)	ANTENNA HEIGHT (m)	TABLE ANGLE (Degree)	RAW VALUE (dBuV)	CORRECTION FACTOR (dB/m)
1	5150.00	69.1 PK	74.0	-4.9	1.00 H	34	29.60	39.50
2	5150.00	52.6 AV	54.0	-1.4	1.00 H	34	13.10	39.50
3	*5190.00	100.5 PK			1.00 H	36	61.00	39.50
4	*5190.00	90.2 AV			1.00 H	36	50.70	39.50
5	#10380.00	57.4 PK	74.0	-16.6	1.29 H	6	10.70	46.70
6	#10380.00	44.1 AV	54.0	-9.9	1.29 H	6	-2.60	46.70
ANTENNA POLARITY & TEST DISTANCE: VERTICAL AT 3 M								
NO.	FREQ. (MHz)	EMISSION LEVEL (dBuV/m)	LIMIT (dBuV/m)	MARGIN (dB)	ANTENNA HEIGHT (m)	TABLE ANGLE (Degree)	RAW VALUE (dBuV)	CORRECTION FACTOR (dB/m)
1	5150.00	67.0 PK	74.0	-7.0	1.44 V	135	27.50	39.50
2	5150.00	50.8 AV	54.0	-3.2	1.44 V	135	11.30	39.50
3	*5190.00	98.2 PK			1.40 V	314	58.70	39.50
4	*5190.00	87.9 AV			1.40 V	314	48.40	39.50
5	#10380.00	57.1 PK	74.0	-16.9	1.35 V	64	10.40	46.70
6	#10380.00	43.5 AV	54.0	-10.5	1.35 V	64	-3.20	46.70

REMARKS:

1. Emission level (dBuV/m) = Raw Value (dBuV) + Correction Factor (dB/m).
2. Correction Factor (dB/m) = Antenna Factor (dB/m) + Cable Factor (dB).
3. The other emission levels were very low against the limit.
4. Margin value = Emission level – Limit value.
5. " * ": Fundamental frequency.
6. " # ": The radiated frequency is out of the restricted band.



A D T

EUT TEST CONDITION		MEASUREMENT DETAIL	
CHANNEL	Channel 46	FREQUENCY RANGE	1 ~ 40GHz
INPUT POWER (SYSTEM)	120Vac, 60Hz	DETECTOR FUNCTION	Peak (PK) Average (AV)
ENVIRONMENTAL CONDITIONS	23deg. C, 71%RH	TESTED BY	Alan Wu

ANTENNA POLARITY & TEST DISTANCE: HORIZONTAL AT 3 M								
NO.	FREQ. (MHz)	EMISSION LEVEL (dBuV/m)	LIMIT (dBuV/m)	MARGIN (dB)	ANTENNA HEIGHT (m)	TABLE ANGLE (Degree)	RAW VALUE (dBuV)	CORRECTION FACTOR (dB/m)
1	5150.00	63.5 PK	74.0	-10.5	1.00 H	39	24.00	39.50
2	5150.00	46.8 AV	54.0	-7.2	1.00 H	39	7.30	39.50
3	*5230.00	101.4 PK			1.00 H	34	61.80	39.60
4	*5230.00	90.6 AV			1.00 H	34	51.00	39.60
5	#10460.00	58.9 PK	74.0	-15.1	1.30 H	19	12.20	46.70
6	#10460.00	46.0 AV	54.0	-8.0	1.30 H	19	-0.70	46.70
ANTENNA POLARITY & TEST DISTANCE: VERTICAL AT 3 M								
NO.	FREQ. (MHz)	EMISSION LEVEL (dBuV/m)	LIMIT (dBuV/m)	MARGIN (dB)	ANTENNA HEIGHT (m)	TABLE ANGLE (Degree)	RAW VALUE (dBuV)	CORRECTION FACTOR (dB/m)
1	5150.00	62.8 PK	74.0	-11.2	1.38 V	134	23.30	39.50
2	5150.00	46.4 AV	54.0	-7.6	1.38 V	134	6.90	39.50
3	*5230.00	99.5 PK			1.40 V	135	59.90	39.60
4	*5230.00	89.8 AV			1.40 V	135	50.20	39.60
5	#10460.00	57.7 PK	74.0	-16.3	1.34 V	68	11.00	46.70
6	#10460.00	44.5 AV	54.0	-9.5	1.34 V	68	-2.20	46.70

REMARKS:

1. Emission level (dBuV/m) = Raw Value (dBuV) + Correction Factor (dB/m).
2. Correction Factor (dB/m) = Antenna Factor (dB/m) + Cable Factor (dB).
3. The other emission levels were very low against the limit.
4. Margin value = Emission level – Limit value.
5. " * ": Fundamental frequency.
6. " # ": The radiated frequency is out of the restricted band.



A D T

EUT TEST CONDITION		MEASUREMENT DETAIL	
CHANNEL	Channel 54	FREQUENCY RANGE	1 ~ 40GHz
INPUT POWER (SYSTEM)	120Vac, 60Hz	DETECTOR FUNCTION	Peak (PK) Average (AV)
ENVIRONMENTAL CONDITIONS	23deg. C, 71%RH	TESTED BY	Alan Wu

ANTENNA POLARITY & TEST DISTANCE: HORIZONTAL AT 3 M								
NO.	FREQ. (MHz)	EMISSION LEVEL (dBuV/m)	LIMIT (dBuV/m)	MARGIN (dB)	ANTENNA HEIGHT (m)	TABLE ANGLE (Degree)	RAW VALUE (dBuV)	CORRECTION FACTOR (dB/m)
1	*5270.00	103.5 PK			1.42 H	292	63.80	39.70
2	*5270.00	93.2 AV			1.42 H	292	53.50	39.70
3	5350.00	64.1 PK	74.0	-9.9	1.42 H	293	24.30	39.80
4	5350.00	46.9 AV	54.0	-7.1	1.42 H	293	7.10	39.80
5	#10540.00	59.4 PK	74.0	-14.6	1.13 H	22	12.60	46.80
6	#10540.00	45.4 AV	54.0	-8.6	1.13 H	22	-1.40	46.80
ANTENNA POLARITY & TEST DISTANCE: VERTICAL AT 3 M								
NO.	FREQ. (MHz)	EMISSION LEVEL (dBuV/m)	LIMIT (dBuV/m)	MARGIN (dB)	ANTENNA HEIGHT (m)	TABLE ANGLE (Degree)	RAW VALUE (dBuV)	CORRECTION FACTOR (dB/m)
1	*5270.00	98.9 PK			1.00 V	100	59.20	39.70
2	*5270.00	88.5 AV			1.00 V	100	48.80	39.70
3	5350.00	63.5 PK	74.0	-10.5	1.00 V	102	23.70	39.80
4	5350.00	45.5 AV	54.0	-8.5	1.00 V	102	5.70	39.80
5	#10540.00	58.3 PK	74.0	-15.7	1.32 V	60	11.50	46.80
6	#10540.00	44.9 AV	54.0	-9.1	1.32 V	60	-1.90	46.80

REMARKS:

1. Emission level (dBuV/m) = Raw Value (dBuV) + Correction Factor (dB/m).
2. Correction Factor (dB/m) = Antenna Factor (dB/m) + Cable Factor (dB).
3. The other emission levels were very low against the limit.
4. Margin value = Emission level – Limit value.
5. " * ": Fundamental frequency.
6. " # ": The radiated frequency is out of the restricted band.



A D T

EUT TEST CONDITION		MEASUREMENT DETAIL	
CHANNEL	Channel 62	FREQUENCY RANGE	1 ~ 40GHz
INPUT POWER (SYSTEM)	120Vac, 60Hz	DETECTOR FUNCTION	Peak (PK) Average (AV)
ENVIRONMENTAL CONDITIONS	23deg. C, 71%RH	TESTED BY	Alan Wu

ANTENNA POLARITY & TEST DISTANCE: HORIZONTAL AT 3 M								
NO.	FREQ. (MHz)	EMISSION LEVEL (dBuV/m)	LIMIT (dBuV/m)	MARGIN (dB)	ANTENNA HEIGHT (m)	TABLE ANGLE (Degree)	RAW VALUE (dBuV)	CORRECTION FACTOR (dB/m)
1	*5310.00	103.3 PK			1.45 H	271	63.60	39.70
2	*5310.00	93.1 AV			1.45 H	271	53.40	39.70
3	5350.00	70.4 PK	74.0	-3.6	1.40 H	276	30.60	39.80
4	5350.00	53.0 AV	54.0	-1.0	1.40 H	276	13.20	39.80
5	10620.00	59.1 PK	74.0	-14.9	1.16 H	20	12.20	46.90
6	10620.00	45.3 AV	54.0	-8.7	1.16 H	20	-1.60	46.90
ANTENNA POLARITY & TEST DISTANCE: VERTICAL AT 3 M								
NO.	FREQ. (MHz)	EMISSION LEVEL (dBuV/m)	LIMIT (dBuV/m)	MARGIN (dB)	ANTENNA HEIGHT (m)	TABLE ANGLE (Degree)	RAW VALUE (dBuV)	CORRECTION FACTOR (dB/m)
1	*5310.00	98.7 PK			1.00 V	95	59.00	39.70
2	*5310.00	87.5 AV			1.00 V	95	47.80	39.70
3	5350.00	65.4 PK	74.0	-8.6	1.00 V	98	25.60	39.80
4	5350.00	48.0 AV	54.0	-6.0	1.00 V	98	8.20	39.80
5	10620.00	58.0 PK	74.0	-16.0	1.38 V	60	11.10	46.90
6	10620.00	42.8 AV	54.0	-11.2	1.38 V	60	-4.10	46.90

REMARKS:

1. Emission level (dBuV/m) = Raw Value (dBuV) + Correction Factor (dB/m).
2. Correction Factor (dB/m) = Antenna Factor (dB/m) + Cable Factor (dB).
3. The other emission levels were very low against the limit.
4. Margin value = Emission level – Limit value.
5. " * ": Fundamental frequency.



A D T

EUT TEST CONDITION		MEASUREMENT DETAIL	
CHANNEL	Channel 102	FREQUENCY RANGE	1 ~ 40GHz
INPUT POWER (SYSTEM)	120Vac, 60Hz	DETECTOR FUNCTION	Peak (PK) Average (AV)
ENVIRONMENTAL CONDITIONS	23deg. C, 71%RH	TESTED BY	Cedric Wu

ANTENNA POLARITY & TEST DISTANCE: HORIZONTAL AT 3 M								
NO.	FREQ. (MHz)	EMISSION LEVEL (dBuV/m)	LIMIT (dBuV/m)	MARGIN (dB)	ANTENNA HEIGHT (m)	TABLE ANGLE (Degree)	RAW VALUE (dBuV)	CORRECTION FACTOR (dB/m)
1	5460.00	60.5 PK	74.0	-13.5	1.00 H	231	20.50	40.00
2	5460.00	46.3 AV	54.0	-7.7	1.00 H	231	6.30	40.00
3	#5470.00	69.1 PK	74.0	-4.9	1.00 H	240	29.10	40.00
4	#5470.00	52.2 AV	54.0	-1.8	1.00 H	240	12.20	40.00
5	*5510.00	97.9 PK			1.00 H	237	57.90	40.00
6	*5510.00	87.3 AV			1.00 H	237	47.30	40.00
7	11020.00	56.0 PK	74.0	-18.0	1.00 H	45	8.30	47.70
8	11020.00	43.3 AV	54.0	-10.7	1.00 H	45	-4.40	47.70
ANTENNA POLARITY & TEST DISTANCE: VERTICAL AT 3 M								
NO.	FREQ. (MHz)	EMISSION LEVEL (dBuV/m)	LIMIT (dBuV/m)	MARGIN (dB)	ANTENNA HEIGHT (m)	TABLE ANGLE (Degree)	RAW VALUE (dBuV)	CORRECTION FACTOR (dB/m)
1	5460.00	61.3 PK	74.0	-12.7	1.32 V	90	21.30	40.00
2	5460.00	47.1 AV	54.0	-6.9	1.32 V	90	7.10	40.00
3	#5470.00	70.9 PK	74.0	-3.1	1.36 V	93	30.90	40.00
4	#5470.00	53.0 AV	54.0	-1.0	1.36 V	93	13.00	40.00
5	*5510.00	97.2 PK			1.36 V	95	57.20	40.00
6	*5510.00	87.5 AV			1.36 V	95	47.50	40.00
7	11020.00	55.2 PK	74.0	-18.8	1.00 V	100	7.50	47.70
8	11020.00	42.5 AV	54.0	-11.5	1.00 V	100	-5.20	47.70

REMARKS:

1. Emission level (dBuV/m) = Raw Value (dBuV) + Correction Factor (dB/m).
2. Correction Factor (dB/m) = Antenna Factor (dB/m) + Cable Factor (dB).
3. The other emission levels were very low against the limit.
4. Margin value = Emission level – Limit value.
5. " * ": Fundamental frequency.
6. " # ": The radiated frequency is out of the restricted band.



A D T

EUT TEST CONDITION		MEASUREMENT DETAIL	
CHANNEL	Channel 110	FREQUENCY RANGE	1 ~ 40GHz
INPUT POWER (SYSTEM)	120Vac, 60Hz	DETECTOR FUNCTION	Peak (PK) Average (AV)
ENVIRONMENTAL CONDITIONS	23deg. C, 71%RH	TESTED BY	Cedric Wu

ANTENNA POLARITY & TEST DISTANCE: HORIZONTAL AT 3 M								
NO.	FREQ. (MHz)	EMISSION LEVEL (dBuV/m)	LIMIT (dBuV/m)	MARGIN (dB)	ANTENNA HEIGHT (m)	TABLE ANGLE (Degree)	RAW VALUE (dBuV)	CORRECTION FACTOR (dB/m)
1	5460.00	60.5 PK	74.0	-13.5	1.00 H	231	20.50	40.00
2	5460.00	46.3 AV	54.0	-7.7	1.00 H	231	6.30	40.00
3	#5470.00	69.1 PK	74.0	-4.9	1.00 H	240	29.10	40.00
4	#5470.00	52.2 AV	54.0	-1.8	1.00 H	240	12.20	40.00
5	*5510.00	97.9 PK			1.00 H	237	57.90	40.00
6	*5510.00	87.3 AV			1.00 H	237	47.30	40.00
7	11020.00	56.0 PK	74.0	-18.0	1.00 H	45	8.30	47.70
8	11020.00	43.3 AV	54.0	-10.7	1.00 H	45	-4.40	47.70
ANTENNA POLARITY & TEST DISTANCE: VERTICAL AT 3 M								
NO.	FREQ. (MHz)	EMISSION LEVEL (dBuV/m)	LIMIT (dBuV/m)	MARGIN (dB)	ANTENNA HEIGHT (m)	TABLE ANGLE (Degree)	RAW VALUE (dBuV)	CORRECTION FACTOR (dB/m)
1	5460.00	61.3 PK	74.0	-12.7	1.32 V	90	21.30	40.00
2	5460.00	47.1 AV	54.0	-6.9	1.32 V	90	7.10	40.00
3	#5470.00	70.9 PK	74.0	-3.1	1.36 V	93	30.90	40.00
4	#5470.00	53.0 AV	54.0	-1.0	1.36 V	93	13.00	40.00
5	*5510.00	97.2 PK			1.36 V	95	57.20	40.00
6	*5510.00	87.5 AV			1.36 V	95	47.50	40.00
7	11020.00	55.2 PK	74.0	-18.8	1.00 V	100	7.50	47.70
8	11020.00	42.5 AV	54.0	-11.5	1.00 V	100	-5.20	47.70

REMARKS:

1. Emission level (dBuV/m) = Raw Value (dBuV) + Correction Factor (dB/m).
2. Correction Factor (dB/m) = Antenna Factor (dB/m) + Cable Factor (dB).
3. The other emission levels were very low against the limit.
4. Margin value = Emission level – Limit value.
5. " # ": The radiated frequency is out of the restricted band.



A D T

EUT TEST CONDITION		MEASUREMENT DETAIL	
CHANNEL	Channel 134	FREQUENCY RANGE	1 ~ 40GHz
INPUT POWER (SYSTEM)	120Vac, 60Hz	DETECTOR FUNCTION	Peak (PK) Average (AV)
ENVIRONMENTAL CONDITIONS	23deg. C, 71%RH	TESTED BY	Cedric Wu

ANTENNA POLARITY & TEST DISTANCE: HORIZONTAL AT 3 M								
NO.	FREQ. (MHz)	EMISSION LEVEL (dBuV/m)	LIMIT (dBuV/m)	MARGIN (dB)	ANTENNA HEIGHT (m)	TABLE ANGLE (Degree)	RAW VALUE (dBuV)	CORRECTION FACTOR (dB/m)
1	*5670.00	99.4 PK			1.38 H	277	59.20	40.20
2	*5670.00	89.4 AV			1.38 H	277	49.20	40.20
3	#5725.00	57.5 PK	74.0	-16.5	1.35 H	270	17.20	40.30
4	#5725.00	43.5 AV	54.0	-10.5	1.35 H	270	3.20	40.30
5	11340.00	56.8 PK	74.0	-17.2	1.00 H	55	8.60	48.20
6	11340.00	44.2 AV	54.0	-9.8	1.00 H	55	-4.00	48.20
ANTENNA POLARITY & TEST DISTANCE: VERTICAL AT 3 M								
NO.	FREQ. (MHz)	EMISSION LEVEL (dBuV/m)	LIMIT (dBuV/m)	MARGIN (dB)	ANTENNA HEIGHT (m)	TABLE ANGLE (Degree)	RAW VALUE (dBuV)	CORRECTION FACTOR (dB/m)
1	*5670.00	97.0 PK			1.27 V	131	56.80	40.20
2	*5670.00	87.2 AV			1.27 V	131	47.00	40.20
3	#5725.00	55.4 PK	74.0	-18.6	1.28 V	133	15.10	40.30
4	#5725.00	42.8 AV	54.0	-11.2	1.28 V	133	2.50	40.30
5	11340.00	56.0 PK	74.0	-18.0	1.00 V	113	7.80	48.20
6	11340.00	43.2 AV	54.0	-10.8	1.00 V	113	-5.00	48.20

REMARKS:

1. Emission level (dBuV/m) = Raw Value (dBuV) + Correction Factor (dB/m).
2. Correction Factor (dB/m) = Antenna Factor (dB/m) + Cable Factor (dB).
3. The other emission levels were very low against the limit.
4. Margin value = Emission level – Limit value.
5. " * ": Fundamental frequency.
6. " # ": The radiated frequency is out of the restricted band.



A D T

BELOW 1GHz WORST-CASE DATA : 802.11n (20MHz)

EUT TEST CONDITION		MEASUREMENT DETAIL	
CHANNEL	Channel 60	FREQUENCY RANGE	Below 1000MHz
INPUT POWER (SYSTEM)	120Vac, 60Hz	DETECTOR FUNCTION	Quasi-Peak
ENVIRONMENTAL CONDITIONS	23deg. C, 71%RH	TESTED BY	Martin Lee

ANTENNA POLARITY & TEST DISTANCE: HORIZONTAL AT 3 M								
NO.	FREQ. (MHz)	EMISSION LEVEL (dBuV/m)	LIMIT (dBuV/m)	MARGIN (dB)	ANTENNA HEIGHT (m)	TABLE ANGLE (Degree)	RAW VALUE (dBuV)	CORRECTION FACTOR (dB/m)
1	111.48	33.7 QP	43.5	-9.8	1.36 H	10	23.40	10.30
2	150.28	37.0 QP	43.5	-6.5	1.00 H	113	23.40	13.60
3	198.78	38.8 QP	43.5	-4.7	1.50 H	145	27.90	10.90
4	288.02	32.9 QP	46.0	-13.1	1.77 H	213	18.50	14.40
5	359.80	30.8 QP	46.0	-15.2	1.69 H	177	14.40	16.40
6	528.58	31.2 QP	46.0	-14.8	1.55 H	84	10.50	20.70
ANTENNA POLARITY & TEST DISTANCE: VERTICAL AT 3 M								
NO.	FREQ. (MHz)	EMISSION LEVEL (dBuV/m)	LIMIT (dBuV/m)	MARGIN (dB)	ANTENNA HEIGHT (m)	TABLE ANGLE (Degree)	RAW VALUE (dBuV)	CORRECTION FACTOR (dB/m)
1	49.40	36.0 QP	40.0	-4.0	1.44 V	311	22.50	13.50
2	123.12	28.9 QP	43.5	-14.6	1.85 V	147	17.30	11.60
3	198.78	30.1 QP	43.5	-13.4	1.00 V	284	19.20	10.90
4	340.40	28.6 QP	46.0	-17.4	2.25 V	195	12.70	15.90
5	439.34	26.5 QP	46.0	-19.5	1.75 V	94	8.10	18.40
6	949.56	35.3 QP	46.0	-10.7	2.25 V	314	8.30	27.00

REMARKS:

1. Emission level (dBuV/m) = Raw Value (dBuV) + Correction Factor (dB/m).
2. Correction Factor (dB/m) = Antenna Factor (dB/m) + Cable Factor (dB).
3. The other emission levels were very low against the limit.
4. Margin value = Emission level – Limit value.



A D T

EUT TEST CONDITION		MEASUREMENT DETAIL	
CHANNEL	Channel 116	FREQUENCY RANGE	Below 1000MHz
INPUT POWER (SYSTEM)	120Vac, 60Hz	DETECTOR FUNCTION	Quasi-Peak
ENVIRONMENTAL CONDITIONS	23deg. C, 71%RH	TESTED BY	Martin Lee

ANTENNA POLARITY & TEST DISTANCE: HORIZONTAL AT 3 M								
NO.	FREQ. (MHz)	EMISSION LEVEL (dBuV/m)	LIMIT (dBuV/m)	MARGIN (dB)	ANTENNA HEIGHT (m)	TABLE ANGLE (Degree)	RAW VALUE (dBuV)	CORRECTION FACTOR (dB/m)
1	111.48	35.0 QP	43.5	-8.5	1.50 H	336	24.70	10.30
2	150.28	35.8 QP	43.5	-7.7	1.00 H	109	22.20	13.60
3	198.78	38.9 QP	43.5	-4.6	1.75 H	126	28.00	10.90
4	239.52	34.0 QP	46.0	-12.0	2.00 H	192	21.50	12.50
5	359.80	31.9 QP	46.0	-14.1	1.25 H	162	15.50	16.40
6	749.74	35.9 QP	46.0	-10.1	1.00 H	25	11.70	24.20
ANTENNA POLARITY & TEST DISTANCE: VERTICAL AT 3 M								
NO.	FREQ. (MHz)	EMISSION LEVEL (dBuV/m)	LIMIT (dBuV/m)	MARGIN (dB)	ANTENNA HEIGHT (m)	TABLE ANGLE (Degree)	RAW VALUE (dBuV)	CORRECTION FACTOR (dB/m)
1	31.94	32.5 QP	40.0	-7.5	2.00 V	76	20.30	12.20
2	49.40	35.3 QP	40.0	-4.7	1.50 V	326	21.80	13.50
3	127.00	28.9 QP	43.5	-14.6	1.14 V	119	17.00	11.90
4	198.78	31.7 QP	43.5	-11.8	1.63 V	278	20.80	10.90
5	340.40	28.1 QP	46.0	-17.9	1.58 V	203	12.20	15.90
6	895.24	34.2 QP	46.0	-11.8	1.65 V	3	7.80	26.40

REMARKS:

1. Emission level (dBuV/m) = Raw Value (dBuV) + Correction Factor (dB/m).
2. Correction Factor (dB/m) = Antenna Factor (dB/m) + Cable Factor (dB).
3. The other emission levels were very low against the limit.
4. Margin value = Emission level – Limit value.

4.2 CONDUCTED EMISSION MEASUREMENT

4.2.1 LIMITS OF CONDUCTED EMISSION MEASUREMENT

FREQUENCY OF EMISSION (MHz)	CONDUCTED LIMIT (dB μ V)	
	Quasi-peak	Average
0.15 ~ 0.5	66 to 56	56 to 46
0.5 ~ 5	56	46
5 ~ 30	60	50

- NOTE:** 1. The lower limit shall apply at the transition frequencies.
2. The limit decreases in line with the logarithm of the frequency in the range of 0.15 to 0.50MHz.
3. All emanations from a class A/B digital device or system, including any network of conductors and apparatus connected thereto, shall not exceed the level of field strengths specified above.

4.2.2 TEST INSTRUMENTS

DESCRIPTION & MANUFACTURER	MODEL NO.	SERIAL NO.	DATE OF CALIBRATION	DUE DATE OF CALIBRATION
Test Receiver ROHDE & SCHWARZ	ESCS30	100288	Nov. 09, 2012	Nov. 08, 2013
RF signal cable Woken	5D-FB	Cable-HYCO2-01	Dec. 28, 2012	Dec. 27, 2013
LISN ROHDE & SCHWARZ (EUT)	ESH2-Z5	100100	Dec. 21, 2012	Dec. 20, 2013
LISN ROHDE & SCHWARZ (Peripheral)	ESH3-Z5	100311	Jul. 06, 2012	Jul. 05, 2013
Software ADT	BV ADT_Cond_ V7.3.7.3	NA	NA	NA

- NOTE:** 1. The calibration interval of the above test instruments is 12 months and the calibrations are traceable to NML/ROC and NIST/USA.
2. The test was performed in HwaYa Shielded Room 2.
3. The VCCI Site Registration No. is C-2047.

4.2.3 TEST PROCEDURES

- The EUT was placed 0.4 meters from the conducting wall of the shielded room with EUT being connected to the power mains through a line impedance stabilization network (LISN). Other support units were connected to the power mains through another LISN. The two LISNs provide 50 ohm/ 50uH of coupling impedance for the measuring instrument.
- Both lines of the power mains connected to the EUT were checked for maximum conducted interference.
- The frequency range from 150kHz to 30MHz was searched. Emission levels under (Limit - 20dB) was not recorded.

NOTE: All modes of operation were investigated and the worst-case emissions are reported.

4.2.4 DEVIATION FROM TEST STANDARD

No deviation.

4.2.5 TEST SETUP

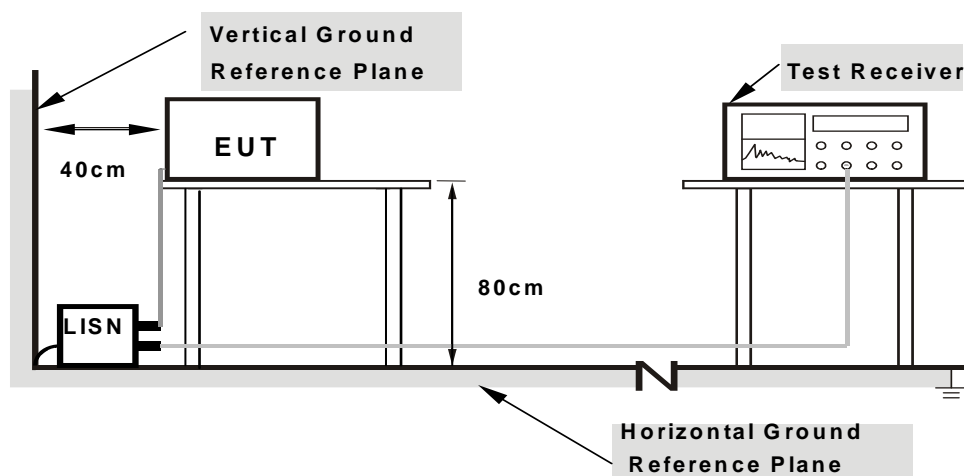

- Note:**
- Support units were connected to second LISN.
 - Both of LISNs (AMN) are 80 cm from EUT and at least 80 from other units and other metal planes

For the actual test configuration, please refer to the attached file (Test Setup Photo).

4.2.6 EUT OPERATING CONDITIONS

Same as 4.1.6.

4.2.7 TEST RESULTS

CONDUCTED WORST-CASE DATA : 802.11n (20MHz)

PHASE	Line 1	6dB BANDWIDTH	9kHz
CHANNEL	Channel 60		

No	Freq. [MHz]	Corr. Factor (dB)	Reading Value		Emission Level		Limit		Margin	
			[dB (uV)]		[dB (uV)]		[dB (uV)]		(dB)	
			Q.P.	AV.	Q.P.	AV.	Q.P.	AV.	Q.P.	AV.
1	0.20469	0.12	47.86	36.53	47.98	36.65	63.42	53.42	-15.44	-16.77
2	0.31007	0.14	36.12	27.75	36.26	27.89	59.97	49.97	-23.71	-22.08
3	0.41172	0.15	30.58	25.75	30.73	25.90	57.61	47.61	-26.88	-21.71
4	0.61739	0.17	28.93	28.43	29.10	28.60	56.00	46.00	-26.90	-17.40
5	7.41406	0.52	36.88	34.34	37.40	34.86	60.00	50.00	-22.60	-15.14
6	10.50781	0.68	31.44	28.04	32.12	28.72	60.00	50.00	-27.88	-21.28

REMARKS:

1. Q.P. and AV. are abbreviations of quasi-peak and average individually.
2. The emission levels of other frequencies were very low against the limit.
3. Margin value = Emission level - Limit value
4. Correction factor = Insertion loss + Cable loss
5. Emission Level = Correction Factor + Reading Value.

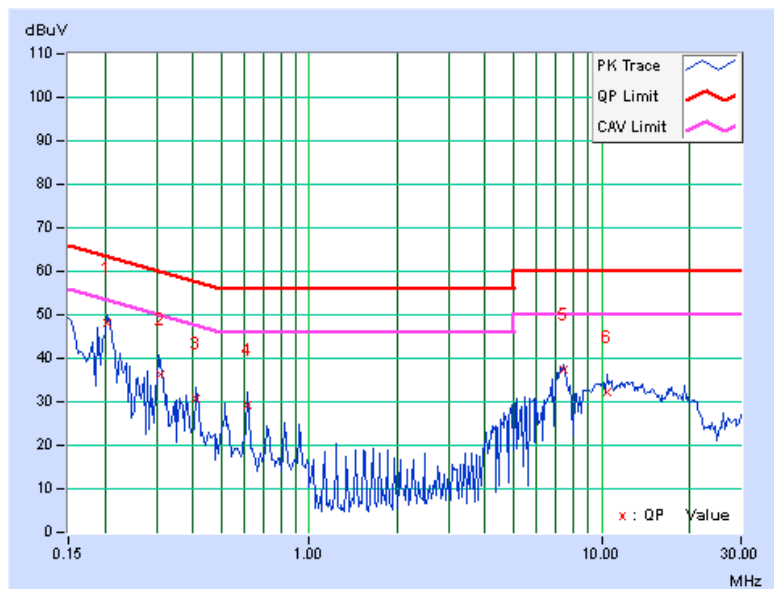



A D T

PHASE	Line 2	6dB BANDWIDTH	9kHz
CHANNEL	Channel 60		

No	Freq. [MHz]	Corr. Factor (dB)	Reading Value		Emission Level		Limit		Margin	
			[dB (uV)]		[dB (uV)]		[dB (uV)]		(dB)	
			Q.P.	AV.	Q.P.	AV.	Q.P.	AV.	Q.P.	AV.
1	0.20731	0.17	46.36	37.89	46.53	38.06	63.31	53.31	-16.78	-15.25
2	0.31016	0.19	34.78	30.49	34.97	30.68	59.97	49.97	-24.99	-19.28
3	0.51719	0.22	29.50	27.56	29.72	27.78	56.00	46.00	-26.28	-18.22
4	0.72413	0.23	24.66	21.44	24.89	21.67	56.00	46.00	-31.11	-24.33
5	7.69141	0.51	27.41	23.95	27.92	24.46	60.00	50.00	-32.08	-25.54
6	10.24609	0.60	22.25	20.55	22.85	21.15	60.00	50.00	-37.15	-28.85

REMARKS:

1. Q.P. and AV. are abbreviations of quasi-peak and average individually.
2. The emission levels of other frequencies were very low against the limit.
3. Margin value = Emission level - Limit value
4. Correction factor = Insertion loss + Cable loss
5. Emission Level = Correction Factor + Reading Value.

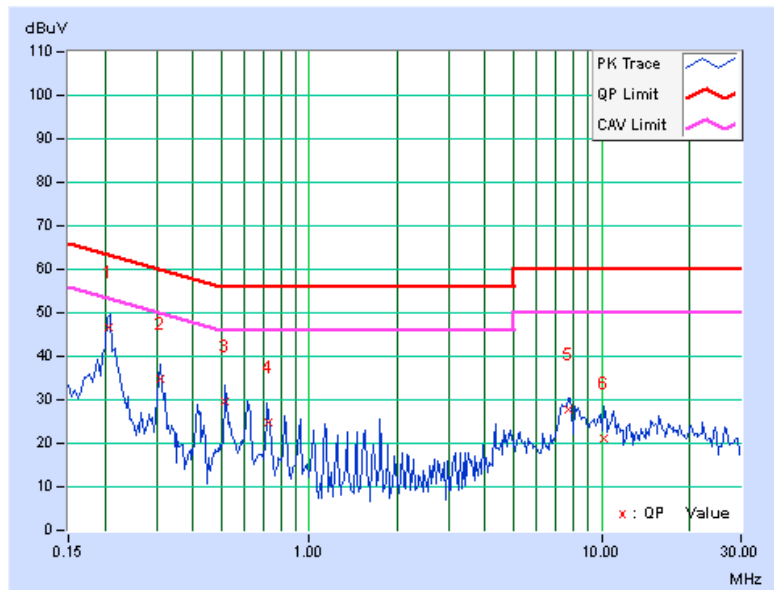



A D T

PHASE	Line 1	6dB BANDWIDTH	9kHz
CHANNEL	Channel 116		

No	Freq. [MHz]	Corr. Factor (dB)	Reading Value		Emission Level		Limit		Margin	
			[dB (uV)]		[dB (uV)]		[dB (uV)]		(dB)	
			Q.P.	AV.	Q.P.	AV.	Q.P.	AV.	Q.P.	AV.
1	0.20469	0.12	47.62	36.65	47.74	36.77	63.42	53.42	-15.68	-16.65
2	0.30625	0.14	34.82	26.73	34.96	26.87	60.07	50.07	-25.12	-23.21
3	0.41172	0.15	28.31	24.47	28.46	24.62	57.61	47.61	-29.15	-22.99
4	0.61875	0.17	27.37	26.65	27.54	26.82	56.00	46.00	-28.46	-19.18
5	7.31250	0.52	33.97	29.81	34.49	30.33	60.00	50.00	-25.51	-19.67
6	10.60429	0.69	30.64	26.79	31.33	27.48	60.00	50.00	-28.67	-22.52

REMARKS:

1. Q.P. and AV. are abbreviations of quasi-peak and average individually.
2. The emission levels of other frequencies were very low against the limit.
3. Margin value = Emission level - Limit value
4. Correction factor = Insertion loss + Cable loss
5. Emission Level = Correction Factor + Reading Value.

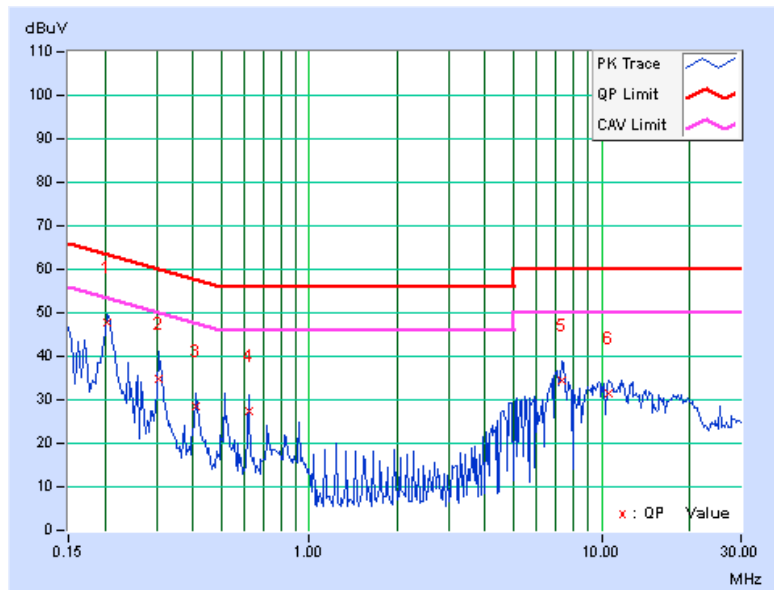



A D T

PHASE	Line 2	6dB BANDWIDTH	9kHz
CHANNEL	Channel 116		

No	Freq. [MHz]	Corr. Factor (dB)	Reading Value		Emission Level		Limit		Margin	
			[dB (uV)]		[dB (uV)]		[dB (uV)]		(dB)	
			Q.P.	AV.	Q.P.	AV.	Q.P.	AV.	Q.P.	AV.
1	0.20469	0.17	46.40	37.71	46.57	37.88	63.42	53.42	-16.85	-15.54
2	0.31016	0.19	34.82	27.67	35.01	27.86	59.97	49.97	-24.95	-22.10
3	0.51719	0.22	29.10	28.06	29.32	28.28	56.00	46.00	-26.68	-17.72
4	0.72159	0.23	24.99	23.03	25.22	23.26	56.00	46.00	-30.78	-22.74
5	7.73438	0.51	25.22	21.46	25.73	21.97	60.00	50.00	-34.27	-28.03
6	16.78125	0.82	21.11	15.71	21.93	16.53	60.00	50.00	-38.07	-33.47

REMARKS:

1. Q.P. and AV. are abbreviations of quasi-peak and average individually.
2. The emission levels of other frequencies were very low against the limit.
3. Margin value = Emission level - Limit value
4. Correction factor = Insertion loss + Cable loss
5. Emission Level = Correction Factor + Reading Value.

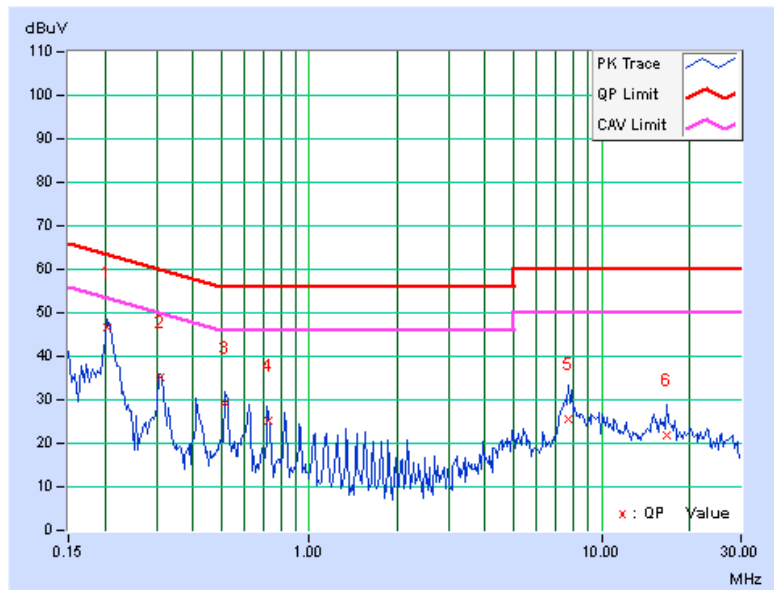

4.3 PEAK TRANSMIT POWER MEASUREMENT

4.3.1 LIMITS OF PEAK TRANSMIT POWER MEASUREMENT

FREQUENCY BAND	LIMIT
5.150 ~ 5.250GHz	The lesser of 50mW (17dBm) or 4dBm + 10logB
5.250 ~ 5.350GHz	The lesser of 250mW (24dBm) or 11dBm + 10logB
5.470 ~ 5.725GHz	The lesser of 250mW (24dBm) or 11dBm + 10logB

NOTE: Where B is the 26dB emission bandwidth in MHz.

Per KDB 662911 D01 Multiple Transmitter Output v01r02 Method of conducted output power measurement on IEEE 802.11 devices,

Array Gain = 0 dB (i.e., no array gain) for NANT ≤ 4;

Array Gain = 0 dB (i.e., no array gain) for channel widths ≥ 40 MHz for any NANT;

Array Gain = 5 log(NANT/NSS) dB or 3 dB, whichever is less for 20-MHz channel widths with NANT ≥ 5.

For power measurements on all other devices: Array Gain = 10 log(NANT/NSS) dB.

4.3.2 TEST SETUP

FOR POWER OUTPUT MEASUREMENT

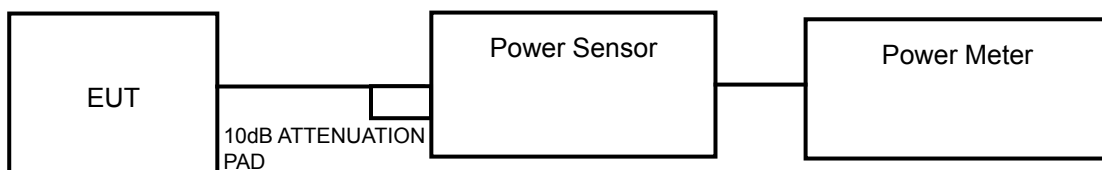

FOR 26dB BANDWIDTH

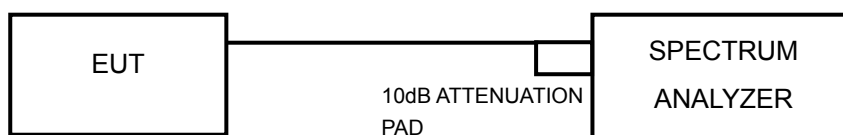

4.3.3 TEST INSTRUMENTS

Refer to section 4.1.3 to get information of above instrument.

4.3.4 TEST PROCEDURE

FOR AVERAGE POWER MEASUREMENT

Duty cycle of test signal is < 98 %. Method PM is used to perform output power measurement, trigger and gating function of wide band power meter is enabled to measure max output power of TX on burst. Duty factor is not added to measured value.

FOR 26dB BANDWIDTH

- 1) Set RBW = approximately 1% of the emission bandwidth.
- 2) Set the VBW > RBW.
- 3) Detector = Peak.
- 4) Trace mode = max hold.
- 5) Measure the maximum width of the emission that is 26 dB down from the peak of the emission. Compare this with the RBW setting of the analyzer. Readjust RBW and repeat measurement as needed until the RBW/EBW ratio is approximately 1%.

4.3.5 DEVIATION FROM TEST STANDARD

No deviation.

4.3.6 EUT OPERATING CONDITIONS

The software provided by client to enable the EUT under transmission condition continuously at specific channel frequencies individually.

4.3.7 TEST RESULTS

POWER OUTPUT:

802.11a

CHANNEL	CHANNEL FREQUENCY (MHz)	AVERAGE POWER (mW)	AVERAGE POWER (dBm)	POWER LIMIT (dBm)	PASS/FAIL
36	5180	31.769	15.02	17	PASS
40	5200	35.075	15.45	17	PASS
48	5240	31.696	15.01	17	PASS
52	5260	31.915	15.04	24	PASS
60	5300	32.961	15.18	24	PASS
64	5320	32.509	15.12	24	PASS
100	5500	33.420	15.24	24	PASS
116	5580	32.211	15.08	24	PASS
140	5700	33.420	15.24	24	PASS

802.11n (20MHz)

CHAN.	CHAN. FREQ. (MHz)	AVERAGE POWER (dBm)		TOTAL POWER (mW)	TOTAL POWER (dBm)	POWER LIMIT (dBm)	PASS / FAIL
		CHAIN 0	CHAIN 1				
36	5180	14.42	13.40	49.547	16.95	17	PASS
40	5200	14.50	13.22	49.173	16.92	17	PASS
48	5240	14.34	13.32	48.642	16.87	17	PASS
52	5260	15.13	14.76	62.507	17.96	24	PASS
60	5300	15.49	15.11	67.834	18.31	24	PASS
64	5320	15.18	14.56	61.537	17.89	24	PASS
100	5500	15.15	14.81	63.003	17.99	24	PASS
116	5580	15.26	14.93	64.691	18.11	24	PASS
140	5700	15.14	14.64	61.766	17.91	24	PASS



802.11n (40MHz)

CHAN.	CHAN. FREQ. (MHz)	AVERAGE POWER (dBm)		TOTAL POWER (mW)	TOTAL POWER (dBm)	POWER LIMIT (dBm)	PASS / FAIL
		CHAIN 0	CHAIN 1				
38	5190	13.69	13.26	44.572	16.49	17	PASS
46	5230	14.25	13.69	49.995	16.99	17	PASS
54	5270	14.26	13.94	51.443	17.11	24	PASS
62	5310	13.78	14.21	50.241	17.01	24	PASS
102	5510	14.21	14.07	51.890	17.15	24	PASS
110	5550	13.15	13.49	42.990	16.33	24	PASS
134	5670	14.22	14.19	52.666	17.22	24	PASS

**26dB BANDWIDTH:****802.11a**

CHANNEL	CHANNEL FREQUENCY (MHz)	26dBc BANDWIDTH (MHz)	PASS / FAIL
36	5180	19.13	PASS
40	5200	19.08	PASS
48	5240	19.25	PASS
52	5260	19.23	PASS
60	5300	19.11	PASS
64	5320	19.14	PASS
100	5500	19.31	PASS
116	5580	19.26	PASS
140	5700	19.19	PASS

802.11n (20MHz)

CHANNEL	CHANNEL FREQUENCY (MHz)	26dBc BANDWIDTH (MHz)		PASS / FAIL
		CHAIN 0	CHAIN 1	
36	5180	19.16	19.09	PASS
40	5200	19.19	19.40	PASS
48	5240	19.15	19.26	PASS
52	5260	19.14	19.27	PASS
60	5300	19.32	19.12	PASS
64	5320	19.19	19.47	PASS
100	5500	19.41	19.29	PASS
116	5580	19.38	19.24	PASS
140	5700	19.30	19.11	PASS

802.11n (40MHz)

CHANNEL	CHANNEL FREQUENCY (MHz)	26dBc BANDWIDTH (MHz)		PASS / FAIL
		CHAIN 0	CHAIN 1	
38	5190	42.23	40.19	PASS
46	5230	46.35	43.68	PASS
54	5270	45.63	42.31	PASS
62	5310	61.21	57.65	PASS
102	5510	66.09	65.34	PASS
110	5550	60.27	40.97	PASS
134	5670	61.33	54.02	PASS

EUT MAXIMUM CONDUCTED POWER

802.11a

FREQUENCY BAND (MHz)	MAX. POWER	
	OUTPUT POWER (mW)	OUTPUT POWER (dBm)
5250~5350	32.961	15.18
5470~5725	33.420	15.24

NOTE: Manufacturer provides Transmit Power Control description to meet this requirement.

802.11n (20MHz)

FREQUENCY BAND (MHz)	MAX. POWER	
	OUTPUT POWER (mW)	OUTPUT POWER (dBm)
5250~5350	67.834	18.31
5470~5725	64.691	18.11

NOTE: Manufacturer provides Transmit Power Control description to meet this requirement.

802.11n (40MHz)

FREQUENCY BAND (MHz)	MAX. POWER	
	OUTPUT POWER (mW)	OUTPUT POWER (dBm)
5250~5350	51.443	17.11
5470~5725	52.666	17.22

NOTE: Manufacturer provides Transmit Power Control description to meet this requirement.

4.4 PEAK POWER SPECTRAL DENSITY MEASUREMENT

4.4.1 LIMITS OF PEAK POWER SPECTRAL DENSITY MEASUREMENT

FREQUENCY BAND	LIMIT
5.150 ~ 5.250GHz	4dBm
5.250 ~ 5.350GHz	11dBm
5.470 ~ 5.725GHz	11dBm

4.4.2 TEST SETUP

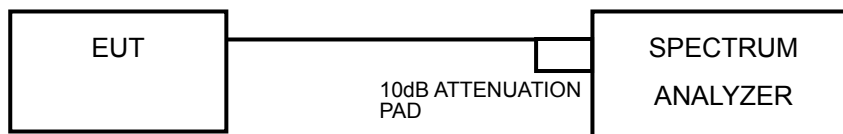

4.4.3 TEST INSTRUMENTS

Refer to section 4.1.3 to get information of above instrument.

4.4.4 TEST PROCEDURES

Using method SA-2 alternative

- 1) Set span to encompass the entire emission bandwidth (EBW) of the signal.
- 2) Set RBW = 30 KHz, Set VBW \geq 1 MHz, Detector = RMS
- 3) Set Channel power measure = 1MHz
- 4) Sweep time = 3 second.
- 5) Perform a single sweep.
- 6) Record the max value and add 10 log (1/duty cycle)

4.4.5 DEVIATION FROM TEST STANDARD

No deviation.

4.4.6 EUT OPERATING CONDITIONS

Same as 4.3.6.



4.4.7 TEST RESULTS

802.11a

CHANNEL	FREQUENCY (MHz)	PSD W/O DUTY FACTOR (dBm)	DUTY FACTOR	PSD WITH DUTY FACTOR (dBm)	MAXIMUM LIMIT (dBm)	PASS/FAIL
36	5180	-0.92	0.22	-0.70	4	PASS
40	5200	-1.17	0.22	-0.95	4	PASS
48	5240	-0.95	0.22	-0.73	4	PASS
52	5260	-0.82	0.22	-0.60	11	PASS
60	5300	-1.63	0.22	-1.41	11	PASS
64	5320	-2.45	0.22	-2.23	11	PASS
100	5500	-0.58	0.22	-0.36	11	PASS
116	5580	-1.69	0.22	-1.47	11	PASS
140	5700	-0.78	0.22	-0.56	11	PASS

NOTE: Refer to section 3.3 for duty cycle spectrum plot.



802.11n (20MHz)

CHAN.	CHAN. FREQ. (MHz)	PSD (dBm)		TOTAL PSD W/O DUTY FACTOR (dBm)	DUTY FACTOR	TOTAL PSD WITH DUTY FACTOR (dBm)	MAX. LIMIT (dBm)	PASS / FAIL
		CHAIN 0	CHAIN 1					
36	5180	-1.75	-1.77	1.25	0.22	1.47	3.72	PASS
40	5200	-1.80	-3.06	0.63	0.22	0.85	3.72	PASS
48	5240	-1.74	-2.11	1.09	0.22	1.31	3.72	PASS
52	5260	-1.24	-1.10	1.84	0.22	2.06	10.40	PASS
60	5300	-1.87	-1.07	1.56	0.22	1.78	10.40	PASS
64	5320	-2.70	-0.76	1.39	0.22	1.61	10.40	PASS
100	5500	-0.72	-2.25	1.59	0.22	1.81	10.31	PASS
116	5580	-1.18	-5.53	0.18	0.22	0.40	10.31	PASS
140	5700	-1.36	-4.08	0.50	0.22	0.72	10.31	PASS

NOTE:

1. Method 1 of power density measurement of KDB 662911 is using for calculating total power density. Total power density is summing entire spectra across corresponding frequency bins on the various outputs by computer.

2. For 5180~5240MHz:

$10 \log[(10^{G1/20} + 10^{G2/20} + \dots + 10^{GN/20})^2 / N_{ANT}] = 6.28\text{dBi} > 6\text{dBi}$, so the power density limit shall be reduced to $4 - (6.28 - 6) = 3.72\text{dBm}$.

For 5260~5320MHz:

$10 \log[(10^{G1/20} + 10^{G2/20} + \dots + 10^{GN/20})^2 / N_{ANT}] = 6.60\text{dBi} > 6\text{dBi}$, so the power density limit shall be reduced to $11 - (6.60 - 6) = 10.40\text{dBm}$.

For 5500~5700MHz:

$10 \log[(10^{G1/20} + 10^{G2/20} + \dots + 10^{GN/20})^2 / N_{ANT}] = 6.69\text{dBi} > 6\text{dBi}$, so the power density limit shall be reduced to $11 - (6.69 - 6) = 10.31\text{dBm}$.

3. Refer to section 3.3 for duty cycle spectrum plot.



802.11n (40MHz)

CHAN.	CHAN. FREQ. (MHz)	PSD (dBm)		TOTAL PSD W/O DUTY FACTOR (dBm)	DUTY FACTOR	TOTAL PSD WITH DUTY FACTOR (dBm)	MAX. LIMIT (dBm)	PASS / FAIL
		CHAIN 0	CHAIN 1					
38	5190	-6.12	-6.63	-3.36	0.44	-2.92	3.72	PASS
46	5230	-5.33	-6.01	-2.65	0.44	-2.21	3.72	PASS
54	5270	-6.16	-5.87	-3.00	0.44	-2.56	10.40	PASS
62	5310	-6.68	-6.82	-3.74	0.44	-3.30	10.40	PASS
102	5510	-6.98	-7.76	-4.34	0.44	-3.90	10.31	PASS
110	5550	-9.90	-11.03	-7.42	0.44	-6.98	10.31	PASS
134	5670	-8.99	-10.42	-6.64	0.44	-6.20	10.31	PASS

NOTE:

- Method 1 of power density measurement of KDB 662911 is using for calculating total power density. Total power density is summing entire spectra across corresponding frequency bins on the various outputs by computer.
- For 5180~5240MHz:**
 $10 \log[(10^{G^1/20} + 10^{G^2/20} + \dots + 10^{G^N/20})^2 / N_{ANT}] = 6.28\text{dBi} > 6\text{dBi}$, so the power density limit shall be reduced to $4-(6.28-6) = 3.72\text{dBm}$.

For 5260~5320MHz:
 $10 \log[(10^{G^1/20} + 10^{G^2/20} + \dots + 10^{G^N/20})^2 / N_{ANT}] = 6.60\text{dBi} > 6\text{dBi}$, so the power density limit shall be reduced to $11-(6.60-6) = 10.40\text{dBm}$.

For 5500~5700MHz:
 $10 \log[(10^{G^1/20} + 10^{G^2/20} + \dots + 10^{G^N/20})^2 / N_{ANT}] = 6.69\text{dBi} > 6\text{dBi}$, so the power density limit shall be reduced to $11-(6.69-6) = 10.31\text{dBm}$.
- Refer to section 3.3 for duty cycle spectrum plot.

4.5 PEAK POWER EXCURSION MEASUREMENT

4.5.1 LIMITS OF PEAK POWER EXCURSION MEASUREMENT

Shall not exceed 13 dB.

4.5.2 TEST SETUP

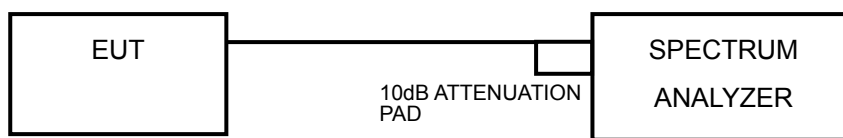

4.5.3 TEST INSTRUMENTS

Refer to section 4.1.3 to get information of above instrument.

4.5.4 TEST PROCEDURE

- 1) Set RBW = 1 MHz, VBW \geq 3 MHz, Detector = peak.
- 2) Trace mode = max-hold. Allow the sweeps to continue until the trace stabilizes.
- 3) Use the peak search function to find the peak of the spectrum.
- 4) Measure the PPSD.
- 5) Compute the ratio of the maximum of the peak-max-hold spectrum to the PPSD.

4.5.5 DEVIATION FROM TEST STANDARD

No deviation.

4.5.6 EUT OPERATING CONDITIONS

Same as 4.2.6

4.5.7 TEST RESULTS

802.11a

CHAN.	CHANNEL FREQ. (MHz)	PEAK VALUE (dBm)	PPSD WITHOUT DUTY FACTOR (dBm)	PPSD WITH DUTY FACTOR (dBm)	PEAK EXCURSION (dB)	LIMIT (dB)	PASS /FAIL
36	5180	8.63	-0.92	-0.70	9.55	13	PASS
40	5200	8.02	-1.17	-0.95	9.19	13	PASS
48	5240	7.78	-0.95	-0.73	8.73	13	PASS
52	5260	8.76	-0.82	-0.60	9.58	13	PASS
60	5300	7.23	-1.63	-1.41	8.86	13	PASS
64	5320	6.93	-2.45	-2.23	9.38	13	PASS
100	5500	8.05	-0.58	-0.36	8.63	13	PASS
116	5580	7.59	-1.69	-1.47	9.28	13	PASS
140	5700	7.78	-0.78	-0.56	8.56	13	PASS

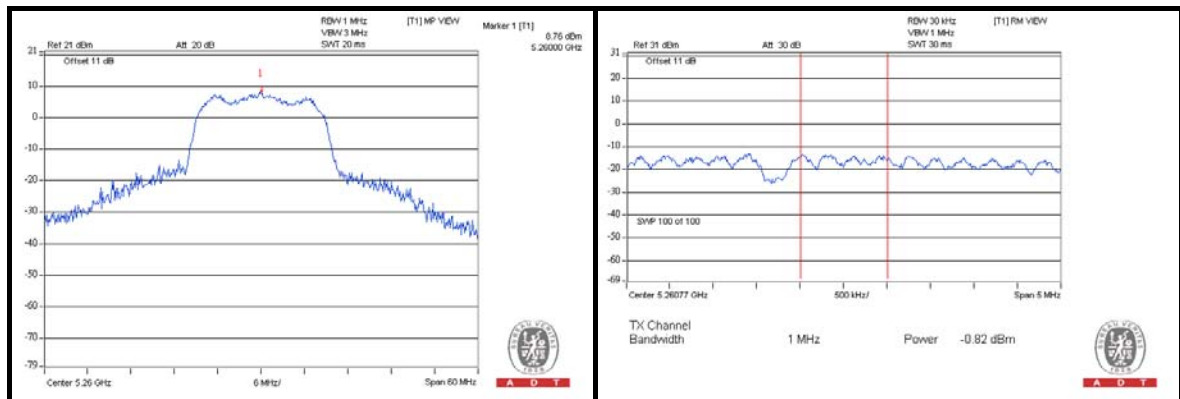



802.11n (20MHz)

CHAN.	CHAN. FREQ. (MHz)	PEAK VALUE (dBm)		PPSD WITHOUT DUTY FACTOR (dBm)		PPSD WITH DUTY FACTOR (dBm)		PEAK EXCURSION (dB)		LIMIT (dB)	PASS /FAIL
		CHAIN 0	CHAIN 1	CHAIN 0	CHAIN 1	CHAIN 0	CHAIN 1	CHAIN 0	CHAIN 1		
36	5180	7.42	7.26	-1.75	-1.77	-1.53	-1.55	8.95	8.81	13	PASS
40	5200	6.53	7.02	-1.80	-3.06	-1.58	-2.84	8.11	9.86	13	PASS
48	5240	6.52	6.91	-1.74	-2.11	-1.52	-1.89	8.04	8.80	13	PASS
52	5260	8.00	8.98	-1.24	-1.10	-1.02	-0.88	9.02	9.86	13	PASS
60	5300	6.86	9.50	-1.87	-1.07	-1.65	-0.85	8.51	10.35	13	PASS
64	5320	6.56	8.93	-2.70	-0.76	-2.48	-0.54	9.04	9.47	13	PASS
100	5500	8.21	8.16	-0.72	-2.25	-0.50	-2.03	8.71	10.19	13	PASS
116	5580	7.84	4.62	-1.18	-5.53	-0.96	-5.31	8.80	9.93	13	PASS
140	5700	7.67	6.12	-1.36	-4.08	-1.14	-3.86	8.81	9.98	13	PASS

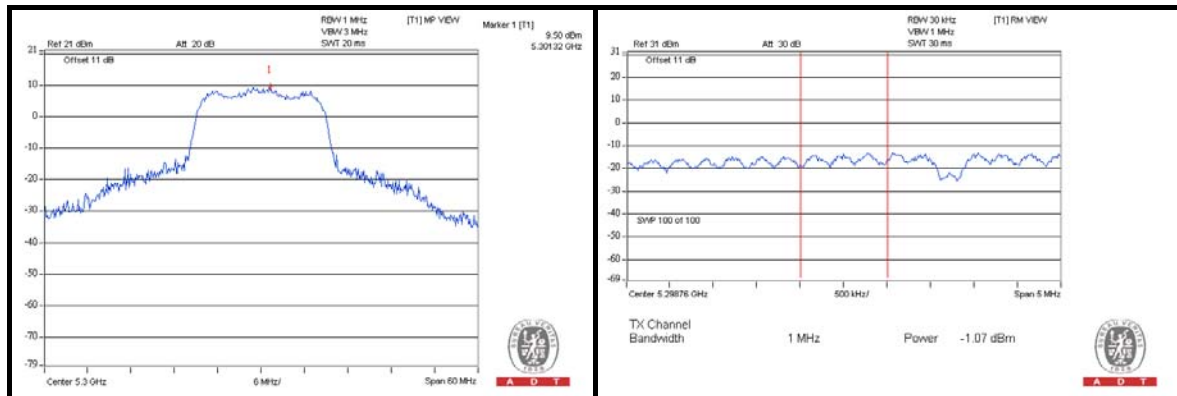



802.11n (40MHz)

CHAN.	CHAN. FREQ. (MHz)	PEAK VALUE (dBm)		PPSD WITHOUT DUTY FACTOR (dBm)		PPSD WITH DUTY FACTOR (dBm)		PEAK EXCURSION (dB)		LIMIT (dB)	PASS /FAIL
		CHAIN 0	CHAIN 1	CHAIN 0	CHAIN 1	CHAIN 0	CHAIN 1	CHAIN 0	CHAIN 1		
38	5190	4.30	4.94	-6.12	-6.63	-5.68	-6.19	9.98	11.13	13	PASS
46	5230	4.61	5.28	-5.33	-6.01	-4.89	-5.57	9.50	10.85	13	PASS
54	5270	4.76	5.15	-6.16	-5.87	-5.72	-5.43	10.48	10.58	13	PASS
62	5310	3.12	4.20	-6.68	-6.82	-6.24	-6.38	9.36	10.58	13	PASS
102	5510	2.74	3.07	-6.98	-7.76	-6.54	-7.32	9.28	10.39	13	PASS
110	5550	0.19	-0.02	-9.90	-11.03	-9.46	-10.59	9.65	10.57	13	PASS
134	5670	1.00	0.45	-8.99	-10.42	-8.55	-9.98	9.55	10.43	13	PASS

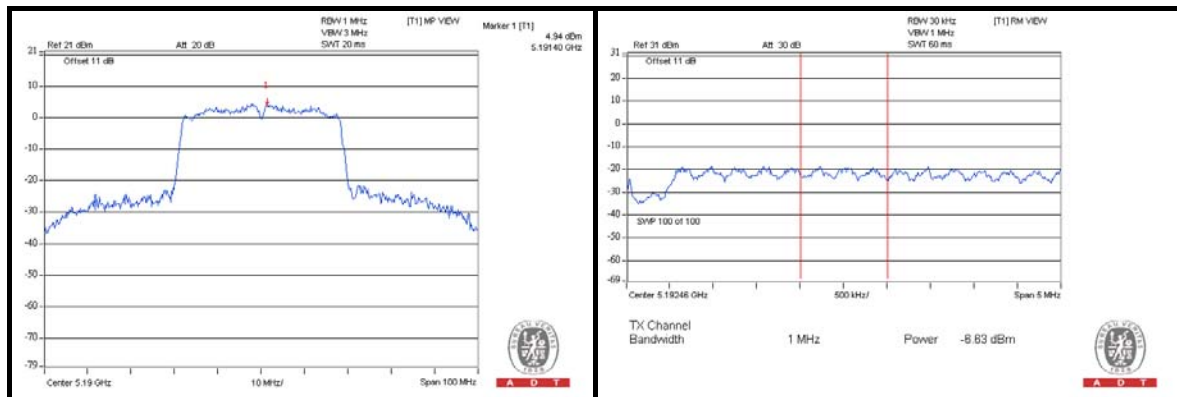

4.6 FREQUENCY STABILITY

4.6.1 LIMITS OF FREQUENCY STABILITY MEASUREMENT

The frequency of the carrier signal shall be maintained within band of operation

4.6.2 TEST SETUP

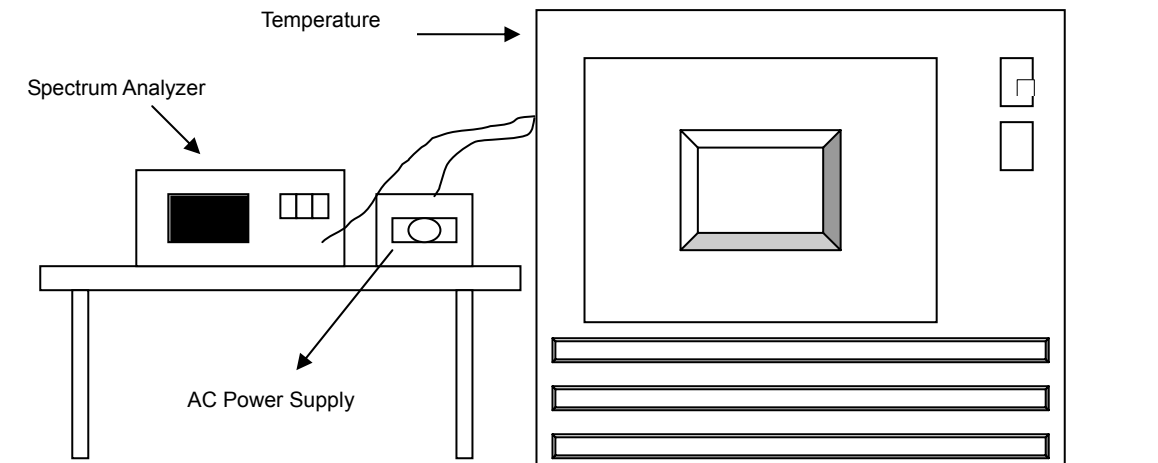

4.6.3 TEST INSTRUMENTS

Refer to section 4.1.3 to get information of above instrument.

4.6.4 TEST PROCEDURE

- a. The EUT was placed inside the environmental test chamber and powered by nominal AC voltage.
- b. Turn the EUT on and couple its output to a spectrum analyzer.
- c. Turn the EUT off and set the chamber to the highest temperature specified.
- d. Allow sufficient time (approximately 30 min) for the temperature of the chamber to stabilize, turn the EUT on and measure the operating frequency after 2, 5, and 10 minutes.
- e. Repeat step 2 and 3 with the temperature chamber set to the lowest temperature.
- f. The test chamber was allowed to stabilize at +20 degree C for a minimum of 30 minutes. The supply voltage was then adjusted on the EUT from 85% to 115% and the frequency record.

4.6.5 DEVIATION FROM TEST STANDARD

No deviation.

4.6.6 EUT OPERATING CONDITION

Set the EUT transmit at un-modulation mode to test frequency stability.



4.6.7 TEST RESULTS

FREQUENCY STABILITY VERSUS TEMP.									
OPERATING FREQUENCY: 5200MHz									
TEMP. (°C)	POWER SUPPLY (Vdc)	0 MINUTE		2 MINUTE		5 MINUTE		10 MINUTE	
		Measured Frequency (MHz)	Frequency Drift (%)	Measured Frequency (MHz)	Frequency Drift (%)	Measured Frequency (MHz)	Frequency Drift (%)	Measured Frequency (MHz)	Frequency Drift (%)
55	5	5200.0232	0.00045	5200.0188	0.00036	5200.025	0.00048	5200.019	0.00037
50	5	5200.0132	0.00025	5200.0186	0.00036	5200.0164	0.00032	5200.0192	0.00037
40	5	5200.0151	0.00029	5200.0168	0.00032	5200.0185	0.00036	5200.0152	0.00029
30	5	5200.002	0.00004	5199.9986	-0.00003	5200.0001	0.00000	5200.002	0.00004
20	5	5199.9726	-0.00053	5199.9709	-0.00056	5199.9716	-0.00055	5199.9736	-0.00051
10	5	5199.9787	-0.00041	5199.9747	-0.00049	5199.9827	-0.00033	5199.9798	-0.00039
0	5	5199.9743	-0.00049	5199.9814	-0.00036	5199.9741	-0.00050	5199.9749	-0.00048
-10	5	5200.0058	0.00011	5200.0112	0.00022	5200.0135	0.00026	5200.0114	0.00022
-20	5	5200.0153	0.00029	5200.0187	0.00036	5200.0242	0.00047	5200.0176	0.00034

FREQUENCY STABILITY VERSUS VOLTAGE									
OPERATING FREQUENCY: 5200MHz									
TEMP. (°C)	POWER SUPPLY (Vac)	0 MINUTE		2 MINUTE		5 MINUTE		10 MINUTE	
		Measured Frequency (MHz)	Frequency Drift (%)	Measured Frequency (MHz)	Frequency Drift (%)	Measured Frequency (MHz)	Frequency Drift (%)	Measured Frequency (MHz)	Frequency Drift (%)
20	5.75	5199.9723	-0.00053	5199.9718	-0.00054	5199.9708	-0.00056	5199.975	-0.00048
	5.00	5199.9726	-0.00053	5199.9709	-0.00056	5199.9716	-0.00055	5199.9736	-0.00051
	4.25	5199.973	-0.00052	5199.9709	-0.00056	5199.9703	-0.00057	5199.9738	-0.00050

5. PHOTOGRAPHS OF THE TEST CONFIGURATION

Please refer to the attached file (Test Setup Photo).



6. INFORMATION ON THE TESTING LABORATORIES

We, Bureau Veritas Consumer Products Services (H.K.) Ltd., Taoyuan Branch, were founded in 1988 to provide our best service in EMC, Radio, Telecom and Safety consultation. Our laboratories are accredited and approved according to ISO/IEC 17025.

If you have any comments, please feel free to contact us at the following:

Linko EMC/RF Lab:
Tel: 886-2-26052180
Fax: 886-2-26051924

Hsin Chu EMC/RF Lab:
Tel: 886-3-5935343
Fax: 886-3-5935342

Hwa Ya EMC/RF/Safety Telecom Lab:
Tel: 886-3-3183232
Fax: 886-3-3270892

Email: service.adt@tw.bureauveritas.com
Web Site: www.bureauveritas-adt.com

The address and road map of all our labs can be found in our web site also.



A D T

7. APPENDIX A – MODIFICATIONS RECORDERS FOR ENGINEERING CHANGES TO THE EUT BY THE LAB

No modifications were made to the EUT by the lab during the test.

---END---