



A D T

FCC TEST REPORT (15.247)

REPORT NO.: RF130308C12

MODEL NO.: WLU5054-D84

FCC ID: H8N-WLU5054

RECEIVED: Mar. 08, 2013

TESTED: Mar. 13 ~ Mar. 15, 2013

ISSUED: Mar. 22, 2013

APPLICANT: Askey Computer Corp

ADDRESS: 10F, No. 119, Chienkang Rd Chung-Ho, Taipei
235, Taiwan

ISSUED BY: Bureau Veritas Consumer Products Services
(H.K.) Ltd., Taoyuan Branch

LAB ADDRESS: No. 47, 14th Ling, Chia Pau Vil., Lin Kou Dist.,
New Taipei City, Taiwan, R.O.C.

TEST LOCATION: No. 19, Hwa Ya 2nd Rd, Wen Hwa Tsuen, Kwei
Shan Hsiang, Taoyuan Hsien 333, Taiwan, R.O.C.

This report should not be used by the client to claim product certification, approval, or endorsement by TAF or any government agencies.



This report is for your exclusive use. Any copying or replication of this report to or for any other person or entity, or use of our name or trademark, is permitted only with our prior written permission. This report sets forth our findings solely with respect to the test samples identified herein. The results set forth in this report are not indicative or representative of the quality or characteristics of the lot from which a test sample was taken or any similar or identical product unless specifically and expressly noted. Our report includes all of the tests requested by you and the results thereof based upon the information that you provided to us. You have 60 days from date of issuance of this report to notify us of any material error or omission caused by our negligence, provided, however, that such notice shall be in writing and shall specifically address the issue you wish to raise. A failure to raise such issue within the prescribed time shall constitute your unqualified acceptance of the completeness of this report, the tests conducted and the correctness of the report contents. Unless specific mention, the uncertainty of measurement has been explicitly taken into account to declare the compliance or non-compliance to the specification.



A D T

TABLE OF CONTENTS

RELEASE CONTROL RECORD.....	5
1. CERTIFICATION.....	6
2. SUMMARY OF TEST RESULTS.....	7
2.1 MEASUREMENT UNCERTAINTY.....	7
3. GENERAL INFORMATION.....	8
3.1 GENERAL DESCRIPTION OF EUT.....	8
3.2 DESCRIPTION OF TEST MODES.....	10
3.2.1 TEST MODE APPLICABILITY AND TESTED CHANNEL DETAIL.....	11
3.3 DESCRIPTION OF SUPPORT UNITS.....	15
3.3.1 CONFIGURATION OF SYSTEM UNDER TEST.....	15
3.4 GENERAL DESCRIPTION OF APPLIED STANDARDS.....	16
4. TEST TYPES AND RESULTS (FOR 2.4GHz BAND).....	17
4.1 RADIATED EMISSION AND BANDEDGE MEASUREMENT.....	17
4.1.1 LIMITS OF RADIATED EMISSION AND BANDEDGE MEASUREMENT.....	17
4.1.2 TEST INSTRUMENTS.....	18
4.1.3 TEST PROCEDURES.....	19
4.1.4 DEVIATION FROM TEST STANDARD.....	19
4.1.5 TEST SETUP.....	20
4.1.6 EUT OPERATING CONDITIONS.....	20
4.1.7 TEST RESULTS.....	21
4.2 CONDUCTED EMISSION MEASUREMENT.....	34
4.2.1 LIMITS OF CONDUCTED EMISSION MEASUREMENT.....	34
4.2.2 TEST INSTRUMENTS.....	34
4.2.3 TEST PROCEDURES.....	35
4.2.4 DEVIATION FROM TEST STANDARD.....	35
4.2.5 TEST SETUP.....	35
4.2.6 EUT OPERATING CONDITIONS.....	35
4.2.7 TEST RESULTS.....	36
4.3 6dB BANDWIDTH MEASUREMENT.....	38
4.3.1 LIMITS OF 6dB BANDWIDTH MEASUREMENT.....	38
4.3.2 TEST SETUP.....	38
4.3.3 TEST INSTRUMENTS.....	38
4.3.4 TEST PROCEDURE.....	38
4.3.5 DEVIATION FROM TEST STANDARD.....	38
4.3.6 EUT OPERATING CONDITIONS.....	38
4.3.7 TEST RESULTS.....	39
4.4 CONDUCTED OUTPUT POWER.....	40
4.4.1 LIMITS OF CONDUCTED OUTPUT POWER MEASUREMENT.....	40
4.4.2 TEST SETUP.....	40



A D T

4.4.3	TEST INSTRUMENTS	40
4.4.4	TEST PROCEDURES.....	40
4.4.5	DEVIATION FROM TEST STANDARD.....	41
4.4.6	EUT OPERATING CONDITIONS	41
4.4.7	TEST RESULTS.....	42
4.5	POWER SPECTRAL DENSITY MEASUREMENT	44
4.5.1	LIMITS OF POWER SPECTRAL DENSITY MEASUREMENT	44
4.5.2	TEST SETUP	44
4.5.3	TEST INSTRUMENTS	44
4.5.4	TEST PROCEDURE	44
4.5.5	DEVIATION FROM TEST STANDARD.....	44
4.5.6	EUT OPERATING CONDITION.....	44
4.5.7	TEST RESULTS.....	45
4.6	CONDUCTED OUT OF BAND EMISSION MEASUREMENT.....	46
4.6.1	LIMITS OF CONDUCTED OUT OF BAND EMISSION MEASUREMENT	46
4.6.2	TEST SETUP	46
4.6.3	TEST INSTRUMENTS	46
4.6.4	TEST PROCEDURE	46
4.6.5	DEVIATION FROM TEST STANDARD.....	47
4.6.6	EUT OPERATING CONDITION.....	47
4.6.7	TEST RESULTS.....	47
5.	TEST TYPES AND RESULTS (FOR 5.0GHz BAND).....	54
5.1	RADIATED EMISSION MEASUREMENT	54
5.1.1	LIMITS OF RADIATED EMISSION MEASUREMENT.....	54
5.1.2	TEST INSTRUMENTS	55
5.1.3	TEST PROCEDURES.....	55
5.1.4	DEVIATION FROM TEST STANDARD.....	55
5.1.5	TEST SETUP	55
5.1.6	EUT OPERATING CONDITIONS	55
5.1.7	TEST RESULTS.....	56
5.2	CONDUCTED EMISSION MEASUREMENT	65
5.2.1	LIMITS OF CONDUCTED EMISSION MEASUREMENT.....	65
5.2.2	TEST INSTRUMENTS	65
5.2.3	TEST PROCEDURES.....	65
5.2.4	DEVIATION FROM TEST STANDARD.....	65
5.2.5	TEST SETUP	65
5.2.6	EUT OPERATING CONDITIONS	65
5.2.7	TEST RESULTS.....	66
5.3	6dB BANDWIDTH MEASUREMENT	68
5.3.1	LIMITS OF 6dB BANDWIDTH MEASUREMENT	68
5.3.2	TEST SETUP	68



A D T

5.3.3	TEST INSTRUMENTS	68
5.3.4	TEST PROCEDURE	68
5.3.5	DEVIATION FROM TEST STANDARD	68
5.3.6	EUT OPERATING CONDITIONS	68
5.3.7	TEST RESULTS	69
5.4	CONDUCTED OUTPUT POWER.....	70
5.4.1	LIMITS OF CONDUCTED OUTPUT POWER MEASUREMENT	70
5.4.2	TEST SETUP	70
5.4.3	INSTRUMENTS	70
5.4.4	TEST PROCEDURES.....	70
5.4.5	DEVIATION FROM TEST STANDARD	70
5.4.6	EUT OPERATING CONDITIONS	70
5.4.7	TEST RESULTS.....	71
5.5	POWER SPECTRAL DENSITY MEASUREMENT	73
5.5.1	LIMITS OF POWER SPECTRAL DENSITY MEASUREMENT	73
5.5.2	TEST SETUP	73
5.5.3	TEST INSTRUMENTS	73
5.5.4	TEST PROCEDURE	73
5.5.5	DEVIATION FROM TEST STANDARD.....	73
5.5.6	EUT OPERATING CONDITION	73
5.5.7	TEST RESULTS.....	74
5.6	CONDUCTED OUT OF BAND EMISSION MEASUREMENT.....	75
5.6.1	LIMITS OF CONDUCTED OUT OF BAND EMISSION MEASUREMENT	75
5.6.2	TEST SETUP	75
5.6.3	TEST INSTRUMENTS	75
5.6.4	TEST PROCEDURE	75
5.6.5	DEVIATION FROM TEST STANDARD.....	75
5.6.6	EUT OPERATING CONDITION.....	75
5.6.7	TEST RESULTS.....	75
6.	PHOTOGRAPHS OF THE TEST CONFIGURATION.....	81
7.	INFORMATION ON THE TESTING LABORATORIES	82
8.	APPENDIX A – MODIFICATIONS RECORDERS FOR ENGINEERING CHANGES TO THE EUT BY THE LAB	83



A D T

RELEASE CONTROL RECORD

ISSUE NO.	REASON FOR CHANGE	DATE ISSUED
RF130308C12	Original release	Mar. 22, 2013



A D T

1. CERTIFICATION

PRODUCT: Wireless LAN module
MODEL NO.: WLU5054-D84
BRAND: Askey
APPLICANT: Askey Computer Corp
TESTED: Mar. 13 ~ Mar. 15, 2013
TEST SAMPLE: ENGINEERING SAMPLE
STANDARDS: **FCC Part 15, Subpart C (Section 15.247)**
ANSI C63.10-2009

The above equipment (model: WLU5054-D84) has been tested by **Bureau Veritas Consumer Products Services (H.K.) Ltd., Taoyuan Branch**, and found compliance with the requirement of the above standards. The test record, data evaluation & Equipment Under Test (EUT) configurations represented herein are true and accurate accounts of the measurements of the sample's EMC characteristics under the conditions specified in this report.

PREPARED BY : Ivy Lin **DATE :** Mar. 22, 2013
Ivy Lin / Specialist

APPROVED BY : Ken Liu **DATE :** Mar. 22, 2013
Ken Liu / Senior Manager



2. SUMMARY OF TEST RESULTS

The EUT has been tested according to the following specifications:

APPLIED STANDARD: FCC PART 15, SUBPART C (SECTION 15.247)			
STANDARD SECTION	TEST TYPE	RESULT	REMARK
15.207	AC Power Conducted Emission	PASS	Meet the requirement of limit. Minimum passing margin is -14.72dB at 0.20724MHz.
15.247(d) 15.209	Radiated Emissions	PASS	Meet the requirement of limit. Minimum passing margin is -1.0dB at 2483.50MHz.
15.247(d)	Band Edge Measurement	PASS	Meet the requirement of limit.
15.247(a)(2)	6dB bandwidth	PASS	Meet the requirement of limit.
15.247(b)	Conducted power	PASS	Meet the requirement of limit.
15.247(e)	Power Spectral Density	PASS	Meet the requirement of limit.
15.203	Antenna Requirement	PASS	Antenna connector is U.FL-R not a standard connector.

2.1 MEASUREMENT UNCERTAINTY

Where relevant, the following measurement uncertainty levels have been estimated for tests performed on the EUT as specified in CISPR 16-4-2:

MEASUREMENT	FREQUENCY	UNCERTAINTY
Conducted emissions	9kHz~30MHz	2.44 dB
Radiated emissions	30MHz ~ 200MHz	2.93 dB
	200MHz ~1000MHz	2.95 dB
	1GHz ~ 18GHz	2.26 dB
	18GHz ~ 40GHz	1.94 dB

This uncertainty represents an expanded uncertainty expressed at approximately the 95% confidence level using a coverage factor of $k = 2$.



3. GENERAL INFORMATION

3.1 GENERAL DESCRIPTION OF EUT

EUT	Wireless LAN module
MODEL NO.	WLU5054-D84
POWER SUPPLY	5Vdc (Host equipment)
MODULATION TYPE	CCK, DQPSK, DBPSK for DSSS 64QAM, 16QAM, QPSK, BPSK for OFDM
MODULATION TECHNOLOGY	DSSS, OFDM
TRANSFER RATE	802.11b: 11.0/ 5.5/ 2.0/ 1.0Mbps 802.11g: 54.0/ 48.0/ 36.0/ 24.0/ 18.0/ 12.0/ 9.0/ 6.0Mbps 802.11a: 54.0/ 48.0/ 36.0/ 24.0/ 18.0/ 12.0/ 9.0/ 6.0Mbps 802.11n: up to 300Mbps
OPERATING FREQUENCY	2.4GHz: 2412 ~ 2462MHz 5.0GHz: 5745 ~ 5825MHz
NUMBER OF CHANNEL	2.4GHz: 11 for 802.11b, 802.11g, 802.11n (20MHz) 7 for 802.11n (40MHz) 5.0GHz: 5 for 802.11a, 802.11n (20MHz) 2 for 802.11n (40MHz)
OUTPUT POWER	680.231mW for 2412 ~ 2462MHz 388.227mW for 5745 ~ 5825MHz
ANTENNA TYPE	Refer to Note as below
ANTENNA CONNECTOR	U.FL-R
DATA CABLE	N/A
I/O PORTS	Refer to user's manual
ACCESSORY DEVICES	N/A



NOTE:

1. The EUT provides two completed transmitters and two receivers.

MODULATION MODE	TX FUNCTION
802.11b	1TX
802.11g	1TX
802.11a	1TX
802.11n (20MHz)	1TX/ 2TX
802.11n (40MHz)	1TX/ 2TX

* After pre-testing, 2TX was the worst case for 802.11n (20MHz)/ 802.11n (40MHz).

2. The following antenna is provided to the EUT.

Antenna type	Antenna gain (dBi)				
	2.4GHz	5.18 ~ 5.24GHz	5.26 ~ 5.32GHz	5.50 ~ 5.70GHz	5.745 ~ 5.825GHz
Printed (Ant. 0)	2.95	3.74	4.00	4.13	3.48
Printed (Ant. 1)	1.64	2.78	3.16	3.21	3.28

*After pre-testing, ant. 0 was the worst case for 802.11 a/ b/ g.

3. The above EUT information is declared by manufacturer and for more detailed features description, please refer to the manufacturer's specifications or user's manual.



3.2 DESCRIPTION OF TEST MODES

FOR 2.4GHz:

11 channels are provided for 802.11b, 802.11g and 802.11n (20MHz):

CHANNEL	FREQUENCY	CHANNEL	FREQUENCY
1	2412MHz	7	2442MHz
2	2417MHz	8	2447MHz
3	2422MHz	9	2452MHz
4	2427MHz	10	2457MHz
5	2432MHz	11	2462MHz
6	2437MHz		

7 channels are provided for 802.11n (40MHz):

CHANNEL	FREQUENCY	CHANNEL	FREQUENCY
3	2422MHz	7	2442MHz
4	2427MHz	8	2447MHz
5	2432MHz	9	2452MHz
6	2437MHz		

FOR 5.0GHz (5745 ~ 5825MHz):

5 channels are provided for 802.11a, 802.11n (20MHz):

CHANNEL	FREQUENCY	CHANNEL	FREQUENCY
149	5745MHz	161	5805MHz
153	5765MHz	165	5825MHz
157	5785MHz		

2 channels are provided for 802.11n (40MHz):

CHANNEL	FREQUENCY	CHANNEL	FREQUENCY
151	5755MHz	159	5795MHz



3.2.1 TEST MODE APPLICABILITY AND TESTED CHANNEL DETAIL

FOR 2.4GHz:

EUT CONFIGURE MODE	APPLICABLE TO				DESCRIPTION
	RE≥1G	RE<1G	PLC	APCM	
-	√	√	√	√	-

Where **RE≥1G**: Radiated Emission above 1GHz **RE<1G**: Radiated Emission below 1GHz
PLC: Power Line Conducted Emission **APCM**: Antenna Port Conducted Measurement

NOTE:
The EUT had been pre-tested on the positioned of each 3 axis. The worst case was found when positioned on **X-plane**.

RADIATED EMISSION TEST (ABOVE 1GHz):

- Pre-Scan has been conducted to determine the worst-case mode from all possible combinations between available modulations, data rates and antenna ports (if EUT with antenna diversity architecture).
- Following channel(s) was (were) selected for the final test as listed below.

EUT CONFIGURE MODE	MODE	AVAILABLE CHANNEL	TESTED CHANNEL	MODULATION TECHNOLOGY	MODULATION TYPE	DATA RATE (Mbps)
-	802.11b	1 to 11	1, 6, 11	DSSS	DBPSK	1.0
-	802.11g	1 to 11	1, 6, 11	OFDM	BPSK	6.0
-	802.11n (20MHz)	1 to 11	1, 6, 11	OFDM	BPSK	7.2
-	802.11n (40MHz)	3 to 9	3, 6, 9	OFDM	BPSK	15.0

RADIATED EMISSION TEST (BELOW 1GHz):

- Pre-Scan has been conducted to determine the worst-case mode from all possible combinations between available modulations, data rates and antenna ports (if EUT with antenna diversity architecture).
- Following channel(s) was (were) selected for the final test as listed below.

EUT CONFIGURE MODE	MODE	AVAILABLE CHANNEL	TESTED CHANNEL	MODULATION TECHNOLOGY	MODULATION TYPE	DATA RATE (Mbps)
-	802.11n (20MHz)	1 to 11	1	OFDM	BPSK	7.2

POWER LINE CONDUCTED EMISSION TEST:

- Pre-Scan has been conducted to determine the worst-case mode from all possible combinations between available modulations, data rates and antenna ports (if EUT with antenna diversity architecture).
- Following channel(s) was (were) selected for the final test as listed below.

EUT CONFIGURE MODE	MODE	AVAILABLE CHANNEL	TESTED CHANNEL	MODULATION TECHNOLOGY	MODULATION TYPE	DATA RATE (Mbps)
-	802.11n (20MHz)	1 to 11	1	OFDM	BPSK	7.2



BANDEDGE MEASUREMENT:

- Pre-Scan has been conducted to determine the worst-case mode from all possible combinations between available modulations, data rates and antenna ports (if EUT with antenna diversity architecture).
- Following channel(s) was (were) selected for the final test as listed below.

EUT CONFIGURE MODE	MODE	AVAILABLE CHANNEL	TESTED CHANNEL	MODULATION TECHNOLOGY	MODULATION TYPE	DATA RATE (Mbps)
-	802.11b	1 to 11	1, 11	DSSS	DBPSK	1.0
-	802.11g	1 to 11	1, 11	OFDM	BPSK	6.0
-	802.11n (20MHz)	1 to 11	1, 11	OFDM	BPSK	7.2
-	802.11n (40MHz)	3 to 9	3, 9	OFDM	BPSK	15.0

ANTENNA PORT CONDUCTED MEASUREMENT:

- This item includes all test value of each mode, but only includes spectrum plot of worst value of each mode.
- Pre-Scan has been conducted to determine the worst-case mode from all possible combinations between available modulations, data rates and antenna ports (if EUT with antenna diversity architecture).
- Following channel(s) was (were) selected for the final test as listed below.

EUT CONFIGURE MODE	MODE	AVAILABLE CHANNEL	TESTED CHANNEL	MODULATION TECHNOLOGY	MODULATION TYPE	DATA RATE (Mbps)
-	802.11b	1 to 11	1, 6, 11	DSSS	DBPSK	1.0
-	802.11g	1 to 11	1, 6, 11	OFDM	BPSK	6.0
-	802.11n (20MHz)	1 to 11	1, 6, 11	OFDM	BPSK	7.2
-	802.11n (40MHz)	3 to 9	3, 6, 9	OFDM	BPSK	15.0

TEST CONDITION:

APPLICABLE TO	ENVIRONMENTAL CONDITIONS	INPUT POWER	TESTED BY
RE \geq 1G	24deg. C, 68%RH	120Vac, 60Hz	Martin Lee
RE $<$ 1G	23deg. C, 71%RH	120Vac, 60Hz	Martin Lee
PLC	24deg. C, 64%RH	120Vac, 60Hz	Match Tsui
APCM	20deg. C, 60%RH	120Vac, 60Hz	Jun Wu



A D T

FOR 5.0GHz (5745 ~ 5825MHz):

EUT CONFIGURE MODE	APPLICABLE TO				DESCRIPTION
	RE≥1G	RE<1G	PLC	APCM	
-	√	√	√	√	-

Where **RE≥1G**: Radiated Emission above 1GHz **RE<1G**: Radiated Emission below 1GHz
PLC: Power Line Conducted Emission **APCM**: Antenna Port Conducted Measurement

NOTE:
The EUT had been pre-tested on the positioned of each 3 axis. The worst case was found when positioned on **X-plane**.

RADIATED EMISSION TEST (ABOVE 1GHz):

- Pre-Scan has been conducted to determine the worst-case mode from all possible combinations between available modulations, data rates and antenna ports (if EUT with antenna diversity architecture).
- Following channel(s) was (were) selected for the final test as listed below.

EUT CONFIGURE MODE	MODE	AVAILABLE CHANNEL	TESTED CHANNEL	MODULATION TECHNOLOGY	MODULATION TYPE	DATA RATE (Mbps)
-	802.11a	149 to 165	149, 157, 165	OFDM	BPSK	6.0
-	802.11n (20MHz)	149 to 165	149, 157, 165	OFDM	BPSK	7.2
-	802.11n (40MHz)	151 to 159	151, 159	OFDM	BPSK	15.0

RADIATED EMISSION TEST (BELOW 1GHz):

- Pre-Scan has been conducted to determine the worst-case mode from all possible combinations between available modulations, data rates and antenna ports (if EUT with antenna diversity architecture).
- Following channel(s) was (were) selected for the final test as listed below.

EUT CONFIGURE MODE	MODE	AVAILABLE CHANNEL	TESTED CHANNEL	MODULATION TECHNOLOGY	MODULATION TYPE	DATA RATE (Mbps)
-	802.11n (20MHz)	149 to 165	149	OFDM	BPSK	7.2

POWER LINE CONDUCTED EMISSION TEST:

- Pre-Scan has been conducted to determine the worst-case mode from all possible combinations between available modulations, data rates and antenna ports (if EUT with antenna diversity architecture).
- Following channel(s) was (were) selected for the final test as listed below.

EUT CONFIGURE MODE	MODE	AVAILABLE CHANNEL	TESTED CHANNEL	MODULATION TECHNOLOGY	MODULATION TYPE	DATA RATE (Mbps)
-	802.11n (20MHz)	149 to 165	149	OFDM	BPSK	7.2



BANDEDGE MEASUREMENT:

- Pre-Scan has been conducted to determine the worst-case mode from all possible combinations between available modulations, data rates and antenna ports (if EUT with antenna diversity architecture).
- Following channel(s) was (were) selected for the final test as listed below.

EUT CONFIGURE MODE	MODE	AVAILABLE CHANNEL	TESTED CHANNEL	MODULATION TECHNOLOGY	MODULATION TYPE	DATA RATE (Mbps)
-	802.11a	149 to 165	149, 165	OFDM	BPSK	6.0
-	802.11n (20MHz)	149 to 165	149, 165	OFDM	BPSK	7.2
-	802.11n (40MHz)	151 to 159	151, 159	OFDM	BPSK	15.0

ANTENNA PORT CONDUCTED MEASUREMENT:

- This item includes all test value of each mode, but only includes spectrum plot of worst value of each mode.
- Pre-Scan has been conducted to determine the worst-case mode from all possible combinations between available modulations, data rates and antenna ports (if EUT with antenna diversity architecture).
- Following channel(s) was (were) selected for the final test as listed below.

EUT CONFIGURE MODE	MODE	AVAILABLE CHANNEL	TESTED CHANNEL	MODULATION TECHNOLOGY	MODULATION TYPE	DATA RATE (Mbps)
-	802.11a	149 to 165	149, 157, 165	OFDM	BPSK	6.0
-	802.11n (20MHz)	149 to 165	149, 157, 165	OFDM	BPSK	7.2
-	802.11n (40MHz)	151 to 159	151, 159	OFDM	BPSK	15.0

TEST CONDITION:

APPLICABLE TO	ENVIRONMENTAL CONDITIONS	INPUT POWER	TESTED BY
RE≥1G	24deg. C, 68%RH	120Vac, 60Hz	Martin Lee
RE<1G	23deg. C, 71%RH	120Vac, 60Hz	Martin Lee
PLC	24deg. C, 64%RH	120Vac, 60Hz	Match Tsui
APCM	20deg. C, 60%RH	120Vac, 60Hz	Jun Wu

3.3 DESCRIPTION OF SUPPORT UNITS

The EUT has been tested as an independent unit together with other necessary accessories or support units. The following support units or accessories were used to form a representative test configuration during the tests.

NO.	PRODUCT	BRAND	MODEL NO.	SERIAL NO.	FCC ID
1	NOTEBOOK	Dell	E5420	D9VMBT1	FCC DoC Approved

NO.	SIGNAL CABLE DESCRIPTION OF THE ABOVE SUPPORT UNITS
1	0.1m USB cable without core.

NOTE: All power cords of the above support units are non shielded (1.8m).

3.3.1 CONFIGURATION OF SYSTEM UNDER TEST

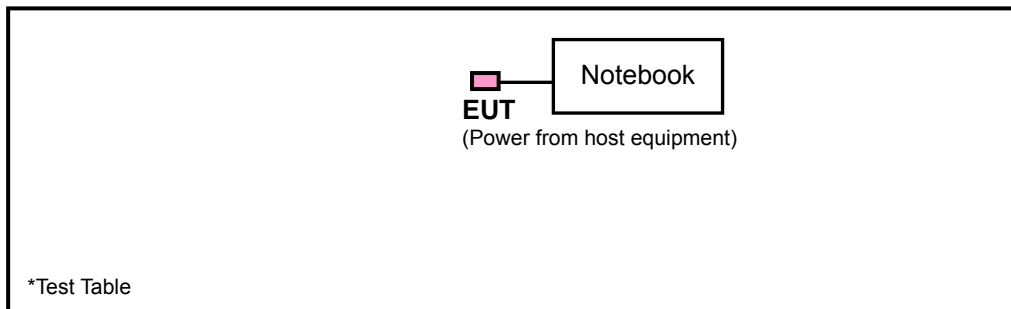



A D T

3.4 GENERAL DESCRIPTION OF APPLIED STANDARDS

The EUT is a RF Product. According to the specifications of the manufacturer, it must comply with the requirements of the following standards:

FCC Part 15, Subpart C (15.247)

558074 D01 DTS Meas Guidance v02

662911 D01 Multiple Transmitter Output v01 r02

ANSI C63.10-2009

All test items have been performed and recorded as per the above standards.

NOTE: The EUT is also considered as a kind of computer peripheral, because the connection to computer is necessary for typical use. It has been verified to comply with the requirements of FCC Part 15, Subpart B, Class B (DoC). The test report has been issued separately.



4. TEST TYPES AND RESULTS (FOR 2.4GHz BAND)

4.1 RADIATED EMISSION AND BANDEDGE MEASUREMENT

4.1.1 LIMITS OF RADIATED EMISSION AND BANDEDGE MEASUREMENT

Radiated emissions which fall in the restricted bands must comply with the radiated emission limits specified as below table. Other emissions shall be at least 20dB below the highest level of the desired power:

FREQUENCIES (MHz)	FIELD STRENGTH (microvolts/meter)	MEASUREMENT DISTANCE (meters)
0.009 ~ 0.490	2400/F(kHz)	300
0.490 ~ 1.705	24000/F(kHz)	30
1.705 ~ 30.0	30	30
30 ~ 88	100	3
88 ~ 216	150	3
216 ~ 960	200	3
Above 960	500	3

NOTE:

1. The lower limit shall apply at the transition frequencies.
2. Emission level (dBuV/m) = 20 log Emission level (uV/m).
3. For frequencies above 1000MHz, the field strength limits are based on average detector, however, the peak field strength of any emission shall not exceed the maximum permitted average limits, specified above by more than 20dB under any condition of modulation.



A D T

4.1.2 TEST INSTRUMENTS

DESCRIPTION & MANUFACTURER	MODEL NO.	SERIAL NO.	DATE OF CALIBRATION	DUE DATE OF CALIBRATION
Test Receiver ROHDE & SCHWARZ	ESCI	100744	Apr. 19, 2012	Apr. 18, 2013
Spectrum Analyzer ROHDE & SCHWARZ	FSP40	100269	Jan. 28, 2013	Jan. 27, 2014
BILOG Antenna SCHWARZBECK	VULB9168	9168-156	Apr. 03, 2012	Apr. 02, 2013
HORN Antenna SCHWARZBECK	BBHA 9120 D	9120D-209	Sep. 03, 2012	Sep. 02, 2013
HORN Antenna SCHWARZBECK	BBHA 9170	148	Jul. 11, 2012	Jul. 10, 2013
Preamplifier Agilent	8449B	3008A01911	Oct. 25, 2012	Oct. 24, 2013
Preamplifier Agilent	8447D	2944A10638	Oct. 25, 2012	Oct. 24, 2013
RF signal cable HUBER+SUHNNER	SUCOFLEX 104	295013/4 283403/4	Aug. 28, 2012	Aug. 27, 2013
RF signal cable Worken	8D-FB	Cable-HYCH9-01	Aug. 11, 2012	Aug. 10, 2013
Software	ADT_Radiated_ V7.6.15.9.2	NA	NA	NA
Antenna Tower EMCO	2070/2080	512.835.4684	NA	NA
Turn Table EMCO	2087-2.03	NA	NA	NA
Antenna Tower & Turn Table Controller EMCO	2090	NA	NA	NA
26GHz ~ 40GHz Amplifier	EM26400	815221	Oct. 25, 2012	Oct. 24, 2013
High Speed Peak Power Meter	ML2495A	0842014	Apr. 28, 2012	Apr. 27, 2013
Power Sensor	MA2411B	0738404	Apr. 28, 2012	Apr. 27, 2013

- NOTE:**
1. The calibration interval of the above test instruments is 12 months and the calibrations are traceable to NML/ROC and NIST/USA.
 2. The test was performed in HwaYa Chamber 9.
 3. The horn antenna and HP preamplifier (model: 8449B) are used only for the measurement of emission frequency above 1GHz if tested.
 4. The FCC Site Registration No. is 215374.
 5. The IC Site Registration No. is IC 7450F-9.



4.1.3 TEST PROCEDURES

- a. The EUT was placed on the top of a rotating table 0.8 meters above the ground at a 3 meters semi-anechoic chamber. The table was rotated 360 degrees to determine the position of the highest radiation.
- b. The EUT was set 3 meters away from the interference-receiving antenna, which was mounted on the top of a variable-height antenna tower.
- c. The antenna is a broadband antenna, and its height is varied from one meter to four meters above the ground to determine the maximum value of the field strength. Both horizontal and vertical polarizations of the antenna are set to make the measurement.
- d. For each suspected emission, the EUT was arranged to its worst case and then the antenna was tuned to heights from 1 meter to 4 meters and the rotatable table was turned from 0 degrees to 360 degrees to find the maximum reading.
- e. The test-receiver system was set to Peak Detect Function and Specified Bandwidth with Maximum Hold Mode.
- f. If the emission level of the EUT in peak mode was lower than the limit specified, then testing could be stopped and the peak values of the EUT would be reported. Otherwise the emissions would be re-tested one by one using peak, quasi-peak or average method as specified and then reported in a data sheet.

NOTE:

1. The resolution bandwidth and video bandwidth of test receiver/spectrum analyzer is 120kHz for Quasi-peak detection at frequency below 1GHz.
2. The resolution bandwidth of test receiver/spectrum analyzer is 100kHz and video bandwidth is 300kHz for Peak detection at frequency above 1GHz.
3. The resolution bandwidth of test receiver/spectrum analyzer is 1MHz and the video bandwidth is 1kHz for Average detection (AV) at frequency above 1GHz.
4. All modes of operation were investigated and the worst-case emissions are reported.

4.1.4 DEVIATION FROM TEST STANDARD

No deviation.

4.1.5 TEST SETUP

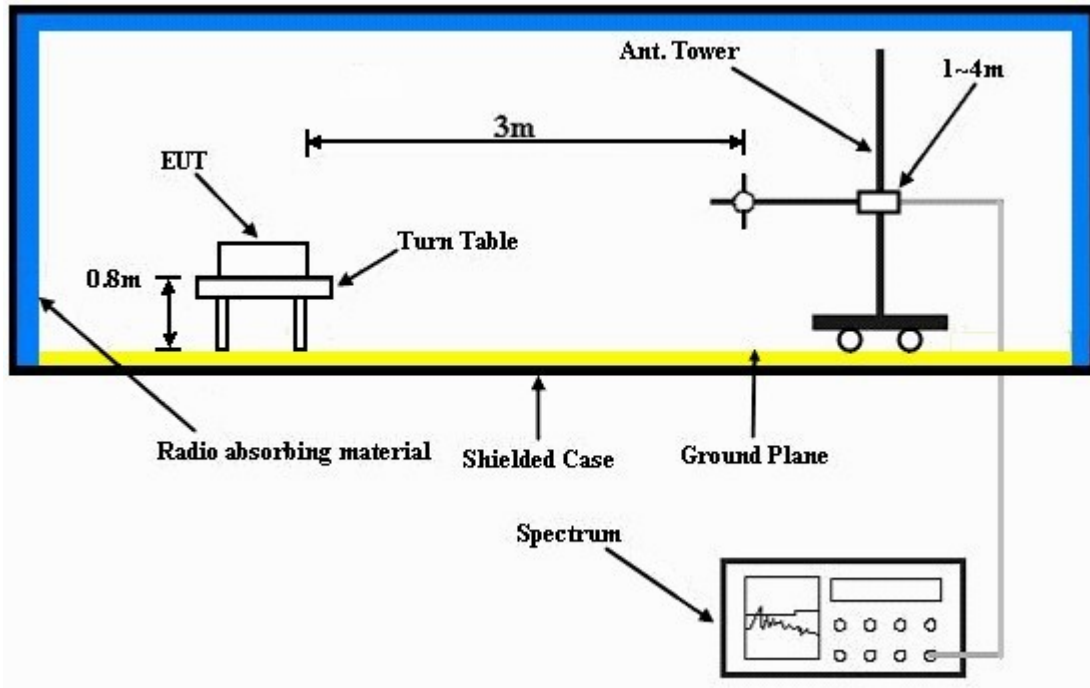

For the actual test configuration, please refer to the attached file (Test Setup Photo).

4.1.6 EUT OPERATING CONDITIONS

- a. Connected EUT to notebook system and placed on the testing table.
- b. The notebook system ran a test program (provided by manufacturer) to enable EUT under transmission condition continuously at specific channel frequency.



A D T

4.1.7 TEST RESULTS

802.11b

EUT TEST CONDITION		MEASUREMENT DETAIL	
CHANNEL	Channel 1	FREQUENCY RANGE	1 ~ 25GHz
INPUT POWER (SYSTEM)	120Vac, 60Hz	DETECTOR FUNCTION	Peak (PK) Average (AV)
ENVIRONMENTAL CONDITIONS	24deg. C, 68%RH	TESTED BY	Martin Lee

ANTENNA POLARITY & TEST DISTANCE: HORIZONTAL AT 3 M								
NO.	FREQ. (MHz)	EMISSION LEVEL (dBuV/m)	LIMIT (dBuV/m)	MARGIN (dB)	ANTENNA HEIGHT (m)	TABLE ANGLE (Degree)	RAW VALUE (dBuV)	CORRECTION FACTOR (dB/m)
1	2390.00	57.3 PK	74.0	-16.7	1.07 H	18	25.30	32.00
2	2390.00	46.7 AV	54.0	-7.3	1.07 H	18	14.70	32.00
3	*2412.00	107.5 PK			1.11 H	15	75.50	32.00
4	*2412.00	103.5 AV			1.11 H	15	71.50	32.00
5	4824.00	48.4 PK	74.0	-25.6	1.09 H	139	9.60	38.80
6	4824.00	40.2 AV	54.0	-13.8	1.09 H	139	1.40	38.80
ANTENNA POLARITY & TEST DISTANCE: VERTICAL AT 3 M								
NO.	FREQ. (MHz)	EMISSION LEVEL (dBuV/m)	LIMIT (dBuV/m)	MARGIN (dB)	ANTENNA HEIGHT (m)	TABLE ANGLE (Degree)	RAW VALUE (dBuV)	CORRECTION FACTOR (dB/m)
1	2390.00	56.5 PK	74.0	-17.5	1.37 V	147	24.50	32.00
2	2390.00	45.7 AV	54.0	-8.3	1.37 V	147	13.70	32.00
3	*2412.00	98.6 PK			1.37 V	347	66.60	32.00
4	*2412.00	94.3 AV			1.37 V	347	62.30	32.00
5	4824.00	47.1 PK	74.0	-26.9	1.20 V	174	8.30	38.80
6	4824.00	36.0 AV	54.0	-18.0	1.20 V	174	-2.80	38.80

REMARKS:

1. Emission level (dBuV/m) = Raw Value (dBuV) + Correction Factor (dB/m).
2. Correction Factor (dB/m) = Antenna Factor (dB/m) + Cable Factor (dB).
3. The other emission levels were very low against the limit.
4. Margin value = Emission level – Limit value.
5. “ * ”: Fundamental frequency.



A D T

EUT TEST CONDITION		MEASUREMENT DETAIL	
CHANNEL	Channel 6	FREQUENCY RANGE	1 ~ 25GHz
INPUT POWER (SYSTEM)	120Vac, 60Hz	DETECTOR FUNCTION	Peak (PK) Average (AV)
ENVIRONMENTAL CONDITIONS	24deg. C, 68%RH	TESTED BY	Martin Lee

ANTENNA POLARITY & TEST DISTANCE: HORIZONTAL AT 3 M								
NO.	FREQ. (MHz)	EMISSION LEVEL (dBuV/m)	LIMIT (dBuV/m)	MARGIN (dB)	ANTENNA HEIGHT (m)	TABLE ANGLE (Degree)	RAW VALUE (dBuV)	CORRECTION FACTOR (dB/m)
1	*2437.00	107.0 PK			1.10 H	18	74.90	32.10
2	*2437.00	102.7 AV			1.10 H	18	70.60	32.10
3	4874.00	48.6 PK	74.0	-25.4	1.10 H	140	9.70	38.90
4	4874.00	40.1 AV	54.0	-13.9	1.10 H	140	1.20	38.90
ANTENNA POLARITY & TEST DISTANCE: VERTICAL AT 3 M								
NO.	FREQ. (MHz)	EMISSION LEVEL (dBuV/m)	LIMIT (dBuV/m)	MARGIN (dB)	ANTENNA HEIGHT (m)	TABLE ANGLE (Degree)	RAW VALUE (dBuV)	CORRECTION FACTOR (dB/m)
1	*2437.00	97.6 PK			1.29 V	151	65.50	32.10
2	*2437.00	93.0 AV			1.29 V	151	60.90	32.10
3	4874.00	47.2 PK	74.0	-26.8	1.22 V	325	8.30	38.90
4	4874.00	36.3 AV	54.0	-17.7	1.22 V	325	-2.60	38.90

REMARKS:

1. Emission level (dBuV/m) = Raw Value (dBuV) + Correction Factor (dB/m).
2. Correction Factor (dB/m) = Antenna Factor (dB/m) + Cable Factor (dB).
3. The other emission levels were very low against the limit.
4. Margin value = Emission level – Limit value.
5. “ * “: Fundamental frequency.



A D T

EUT TEST CONDITION		MEASUREMENT DETAIL	
CHANNEL	Channel 11	FREQUENCY RANGE	1 ~ 25GHz
INPUT POWER (SYSTEM)	120Vac, 60Hz	DETECTOR FUNCTION	Peak (PK) Average (AV)
ENVIRONMENTAL CONDITIONS	24deg. C, 68%RH	TESTED BY	Martin Lee

ANTENNA POLARITY & TEST DISTANCE: HORIZONTAL AT 3 M								
NO.	FREQ. (MHz)	EMISSION LEVEL (dBuV/m)	LIMIT (dBuV/m)	MARGIN (dB)	ANTENNA HEIGHT (m)	TABLE ANGLE (Degree)	RAW VALUE (dBuV)	CORRECTION FACTOR (dB/m)
1	*2462.00	107.6 PK			1.08 H	18	75.50	32.10
2	*2462.00	103.3 AV			1.08 H	18	71.20	32.10
3	2483.50	57.0 PK	74.0	-17.0	1.08 H	18	24.80	32.20
4	2483.50	48.0 AV	54.0	-6.0	1.08 H	18	15.80	32.20
5	4924.00	50.4 PK	74.0	-23.6	1.10 H	146	11.40	39.00
6	4924.00	43.0 AV	54.0	-11.0	1.10 H	146	4.00	39.00
ANTENNA POLARITY & TEST DISTANCE: VERTICAL AT 3 M								
NO.	FREQ. (MHz)	EMISSION LEVEL (dBuV/m)	LIMIT (dBuV/m)	MARGIN (dB)	ANTENNA HEIGHT (m)	TABLE ANGLE (Degree)	RAW VALUE (dBuV)	CORRECTION FACTOR (dB/m)
1	*2462.00	98.5 PK			1.05 V	342	66.40	32.10
2	*2462.00	94.2 AV			1.05 V	342	62.10	32.10
3	2483.50	57.4 PK	74.0	-16.6	1.05 V	342	25.20	32.20
4	2483.50	45.4 AV	54.0	-8.6	1.05 V	342	13.20	32.20
5	4924.00	49.2 PK	74.0	-24.8	1.22 V	175	10.20	39.00
6	4924.00	38.5 AV	54.0	-15.5	1.22 V	175	-0.50	39.00

REMARKS:

1. Emission level (dBuV/m) = Raw Value (dBuV) + Correction Factor (dB/m).
2. Correction Factor (dB/m) = Antenna Factor (dB/m) + Cable Factor (dB).
3. The other emission levels were very low against the limit.
4. Margin value = Emission level – Limit value.
5. “ * “: Fundamental frequency.



A D T

802.11g

EUT TEST CONDITION		MEASUREMENT DETAIL	
CHANNEL	Channel 1	FREQUENCY RANGE	1 ~ 25GHz
INPUT POWER (SYSTEM)	120Vac, 60Hz	DETECTOR FUNCTION	Peak (PK) Average (AV)
ENVIRONMENTAL CONDITIONS	24deg. C, 68%RH	TESTED BY	Martin Lee

ANTENNA POLARITY & TEST DISTANCE: HORIZONTAL AT 3 M								
NO.	FREQ. (MHz)	EMISSION LEVEL (dBuV/m)	LIMIT (dBuV/m)	MARGIN (dB)	ANTENNA HEIGHT (m)	TABLE ANGLE (Degree)	RAW VALUE (dBuV)	CORRECTION FACTOR (dB/m)
1	2390.00	69.9 PK	74.0	-4.1	1.41 H	26	37.90	32.00
2	2390.00	52.5 AV	54.0	-1.5	1.41 H	26	20.50	32.00
3	*2412.00	108.2 PK			1.41 H	26	76.20	32.00
4	*2412.00	97.1 AV			1.41 H	26	65.10	32.00
5	4824.00	47.7 PK	74.0	-26.3	1.32 H	65	8.90	38.80
6	4824.00	34.1 AV	54.0	-19.9	1.32 H	65	-4.70	38.80

ANTENNA POLARITY & TEST DISTANCE: VERTICAL AT 3 M								
NO.	FREQ. (MHz)	EMISSION LEVEL (dBuV/m)	LIMIT (dBuV/m)	MARGIN (dB)	ANTENNA HEIGHT (m)	TABLE ANGLE (Degree)	RAW VALUE (dBuV)	CORRECTION FACTOR (dB/m)
1	2390.00	63.3 PK	74.0	-10.7	1.65 V	3	31.30	32.00
2	2390.00	47.3 AV	54.0	-6.7	1.65 V	3	15.30	32.00
3	*2412.00	99.2 PK			1.65 V	3	67.20	32.00
4	*2412.00	89.9 AV			1.65 V	3	57.90	32.00
5	4824.00	47.5 PK	74.0	-26.5	1.36 V	44	8.70	38.80
6	4824.00	34.0 AV	54.0	-20.0	1.36 V	44	-4.80	38.80

REMARKS:

1. Emission level (dBuV/m) = Raw Value (dBuV) + Correction Factor (dB/m).
2. Correction Factor (dB/m) = Antenna Factor (dB/m) + Cable Factor (dB).
3. The other emission levels were very low against the limit.
4. Margin value = Emission level – Limit value.
5. “ * “: Fundamental frequency.



A D T

EUT TEST CONDITION		MEASUREMENT DETAIL	
CHANNEL	Channel 6	FREQUENCY RANGE	1 ~ 25GHz
INPUT POWER (SYSTEM)	120Vac, 60Hz	DETECTOR FUNCTION	Peak (PK) Average (AV)
ENVIRONMENTAL CONDITIONS	24deg. C, 68%RH	TESTED BY	Martin Lee

ANTENNA POLARITY & TEST DISTANCE: HORIZONTAL AT 3 M								
NO.	FREQ. (MHz)	EMISSION LEVEL (dBuV/m)	LIMIT (dBuV/m)	MARGIN (dB)	ANTENNA HEIGHT (m)	TABLE ANGLE (Degree)	RAW VALUE (dBuV)	CORRECTION FACTOR (dB/m)
1	*2437.00	107.9 PK			1.40 H	25	75.80	32.10
2	*2437.00	97.4 AV			1.40 H	25	65.30	32.10
3	4874.00	47.9 PK	74.0	-26.1	1.12 H	35	9.00	38.90
4	4874.00	34.6 AV	54.0	-19.4	1.12 H	35	-4.30	38.90
ANTENNA POLARITY & TEST DISTANCE: VERTICAL AT 3 M								
NO.	FREQ. (MHz)	EMISSION LEVEL (dBuV/m)	LIMIT (dBuV/m)	MARGIN (dB)	ANTENNA HEIGHT (m)	TABLE ANGLE (Degree)	RAW VALUE (dBuV)	CORRECTION FACTOR (dB/m)
1	*2437.00	99.5 PK			1.65 V	25	67.40	32.10
2	*2437.00	90.1 AV			1.65 V	25	58.00	32.10
3	4874.00	47.6 PK	74.0	-26.4	1.25 V	55	8.70	38.90
4	4874.00	34.0 AV	54.0	-20.0	1.25 V	55	-4.90	38.90

REMARKS:

1. Emission level (dBuV/m) = Raw Value (dBuV) + Correction Factor (dB/m).
2. Correction Factor (dB/m) = Antenna Factor (dB/m) + Cable Factor (dB).
3. The other emission levels were very low against the limit.
4. Margin value = Emission level – Limit value.
5. “ * “: Fundamental frequency.



A D T

EUT TEST CONDITION		MEASUREMENT DETAIL	
CHANNEL	Channel 11	FREQUENCY RANGE	1 ~ 25GHz
INPUT POWER (SYSTEM)	120Vac, 60Hz	DETECTOR FUNCTION	Peak (PK) Average (AV)
ENVIRONMENTAL CONDITIONS	24deg. C, 68%RH	TESTED BY	Martin Lee

ANTENNA POLARITY & TEST DISTANCE: HORIZONTAL AT 3 M								
NO.	FREQ. (MHz)	EMISSION LEVEL (dBuV/m)	LIMIT (dBuV/m)	MARGIN (dB)	ANTENNA HEIGHT (m)	TABLE ANGLE (Degree)	RAW VALUE (dBuV)	CORRECTION FACTOR (dB/m)
1	*2462.00	107.5 PK			1.06 H	17	75.40	32.10
2	*2462.00	97.5 AV			1.06 H	17	65.40	32.10
3	2483.50	71.1 PK	74.0	-2.9	1.06 H	17	38.90	32.20
4	2483.50	52.1 AV	54.0	-1.9	1.06 H	17	19.90	32.20
5	4924.00	48.5 PK	74.0	-25.5	1.33 H	66	9.50	39.00
6	4924.00	34.7 AV	54.0	-19.3	1.33 H	66	-4.30	39.00
ANTENNA POLARITY & TEST DISTANCE: VERTICAL AT 3 M								
NO.	FREQ. (MHz)	EMISSION LEVEL (dBuV/m)	LIMIT (dBuV/m)	MARGIN (dB)	ANTENNA HEIGHT (m)	TABLE ANGLE (Degree)	RAW VALUE (dBuV)	CORRECTION FACTOR (dB/m)
1	*2462.00	100.4 PK			1.64 V	344	68.30	32.10
2	*2462.00	90.7 AV			1.64 V	344	58.60	32.10
3	2483.50	65.7 PK	74.0	-8.3	1.64 V	344	33.50	32.20
4	2483.50	48.7 AV	54.0	-5.3	1.64 V	344	16.50	32.20
5	4924.00	47.3 PK	74.0	-26.7	1.45 V	52	8.30	39.00
6	4924.00	33.9 AV	54.0	-20.1	1.45 V	52	-5.10	39.00

REMARKS:

1. Emission level (dBuV/m) = Raw Value (dBuV) + Correction Factor (dB/m).
2. Correction Factor (dB/m) = Antenna Factor (dB/m) + Cable Factor (dB).
3. The other emission levels were very low against the limit.
4. Margin value = Emission level – Limit value.
5. “ * “: Fundamental frequency.



A D T

802.11n (20MHz)

EUT TEST CONDITION		MEASUREMENT DETAIL	
CHANNEL	Channel 1	FREQUENCY RANGE	1 ~ 25GHz
INPUT POWER (SYSTEM)	120Vac, 60Hz	DETECTOR FUNCTION	Peak (PK) Average (AV)
ENVIRONMENTAL CONDITIONS	24deg. C, 68%RH	TESTED BY	Martin Lee

ANTENNA POLARITY & TEST DISTANCE: HORIZONTAL AT 3 M								
NO.	FREQ. (MHz)	EMISSION LEVEL (dBuV/m)	LIMIT (dBuV/m)	MARGIN (dB)	ANTENNA HEIGHT (m)	TABLE ANGLE (Degree)	RAW VALUE (dBuV)	CORRECTION FACTOR (dB/m)
1	2390.00	72.1 PK	74.0	-1.9	1.34 H	171	40.10	32.00
2	2390.00	52.6 AV	54.0	-1.4	1.34 H	171	20.60	32.00
3	*2412.00	106.3 PK			1.34 H	171	74.30	32.00
4	*2412.00	98.1 AV			1.34 H	171	66.10	32.00
5	4824.00	46.5 PK	74.0	-27.5	1.23 H	55	7.70	38.80
6	4824.00	33.8 AV	54.0	-20.2	1.23 H	55	-5.00	38.80

ANTENNA POLARITY & TEST DISTANCE: VERTICAL AT 3 M								
NO.	FREQ. (MHz)	EMISSION LEVEL (dBuV/m)	LIMIT (dBuV/m)	MARGIN (dB)	ANTENNA HEIGHT (m)	TABLE ANGLE (Degree)	RAW VALUE (dBuV)	CORRECTION FACTOR (dB/m)
1	2390.00	61.7 PK	74.0	-12.3	1.33 V	156	29.70	32.00
2	2390.00	46.7 AV	54.0	-7.3	1.33 V	156	14.70	32.00
3	*2412.00	99.0 PK			1.33 V	156	67.00	32.00
4	*2412.00	89.5 AV			1.33 V	156	57.50	32.00
5	4824.00	47.4 PK	74.0	-26.6	1.05 V	25	8.60	38.80
6	4824.00	34.0 AV	54.0	-20.0	1.05 V	25	-4.80	38.80

REMARKS:

1. Emission level (dBuV/m) = Raw Value (dBuV) + Correction Factor (dB/m).
2. Correction Factor (dB/m) = Antenna Factor (dB/m) + Cable Factor (dB).
3. The other emission levels were very low against the limit.
4. Margin value = Emission level – Limit value.
5. “ * “: Fundamental frequency.



A D T

EUT TEST CONDITION		MEASUREMENT DETAIL	
CHANNEL	Channel 6	FREQUENCY RANGE	1 ~ 25GHz
INPUT POWER (SYSTEM)	120Vac, 60Hz	DETECTOR FUNCTION	Peak (PK) Average (AV)
ENVIRONMENTAL CONDITIONS	24deg. C, 68%RH	TESTED BY	Martin Lee

ANTENNA POLARITY & TEST DISTANCE: HORIZONTAL AT 3 M								
NO.	FREQ. (MHz)	EMISSION LEVEL (dBuV/m)	LIMIT (dBuV/m)	MARGIN (dB)	ANTENNA HEIGHT (m)	TABLE ANGLE (Degree)	RAW VALUE (dBuV)	CORRECTION FACTOR (dB/m)
1	*2437.00	109.8 PK			1.09 H	14	77.70	32.10
2	*2437.00	99.9 AV			1.09 H	14	67.80	32.10
3	4874.00	47.8 PK	74.0	-26.2	1.06 H	63	8.90	38.90
4	4874.00	34.9 AV	54.0	-19.1	1.06 H	63	-4.00	38.90
ANTENNA POLARITY & TEST DISTANCE: VERTICAL AT 3 M								
NO.	FREQ. (MHz)	EMISSION LEVEL (dBuV/m)	LIMIT (dBuV/m)	MARGIN (dB)	ANTENNA HEIGHT (m)	TABLE ANGLE (Degree)	RAW VALUE (dBuV)	CORRECTION FACTOR (dB/m)
1	*2437.00	100.9 PK			1.65 V	342	68.80	32.10
2	*2437.00	91.3 AV			1.65 V	342	59.20	32.10
3	4874.00	47.0 PK	74.0	-27.0	1.05 V	66	8.10	38.90
4	4874.00	34.0 AV	54.0	-20.0	1.05 V	66	-4.90	38.90

REMARKS:

1. Emission level (dBuV/m) = Raw Value (dBuV) + Correction Factor (dB/m).
2. Correction Factor (dB/m) = Antenna Factor (dB/m) + Cable Factor (dB).
3. The other emission levels were very low against the limit.
4. Margin value = Emission level – Limit value.
5. “ * “: Fundamental frequency.



A D T

EUT TEST CONDITION		MEASUREMENT DETAIL	
CHANNEL	Channel 11	FREQUENCY RANGE	1 ~ 25GHz
INPUT POWER (SYSTEM)	120Vac, 60Hz	DETECTOR FUNCTION	Peak (PK) Average (AV)
ENVIRONMENTAL CONDITIONS	24deg. C, 68%RH	TESTED BY	Martin Lee

ANTENNA POLARITY & TEST DISTANCE: HORIZONTAL AT 3 M								
NO.	FREQ. (MHz)	EMISSION LEVEL (dBuV/m)	LIMIT (dBuV/m)	MARGIN (dB)	ANTENNA HEIGHT (m)	TABLE ANGLE (Degree)	RAW VALUE (dBuV)	CORRECTION FACTOR (dB/m)
1	*2462.00	110.4 PK			1.07 H	14	78.30	32.10
2	*2462.00	100.2 AV			1.07 H	14	68.10	32.10
3	2483.50	72.6 PK	74.0	-1.4	1.07 H	14	40.40	32.20
4	2483.50	53.0 AV	54.0	-1.0	1.07 H	14	20.80	32.20
5	4924.00	47.3 PK	74.0	-26.7	1.44 H	57	8.30	39.00
6	4924.00	34.6 AV	54.0	-19.4	1.44 H	57	-4.40	39.00

ANTENNA POLARITY & TEST DISTANCE: VERTICAL AT 3 M								
NO.	FREQ. (MHz)	EMISSION LEVEL (dBuV/m)	LIMIT (dBuV/m)	MARGIN (dB)	ANTENNA HEIGHT (m)	TABLE ANGLE (Degree)	RAW VALUE (dBuV)	CORRECTION FACTOR (dB/m)
1	*2462.00	99.4 PK			1.12 V	139	67.30	32.10
2	*2462.00	90.6 AV			1.12 V	139	58.50	32.10
3	2483.50	62.0 PK	74.0	-12.0	1.12 V	139	29.80	32.20
4	2483.50	48.8 AV	54.0	-5.2	1.12 V	139	16.60	32.20
5	4924.00	47.0 PK	74.0	-27.0	1.65 V	5	8.00	39.00
6	4924.00	33.7 AV	54.0	-20.3	1.65 V	5	-5.30	39.00

REMARKS:

1. Emission level (dBuV/m) = Raw Value (dBuV) + Correction Factor (dB/m).
2. Correction Factor (dB/m) = Antenna Factor (dB/m) + Cable Factor (dB).
3. The other emission levels were very low against the limit.
4. Margin value = Emission level – Limit value.
5. “ * “: Fundamental frequency.



A D T

802.11n (40MHz)

EUT TEST CONDITION		MEASUREMENT DETAIL	
CHANNEL	Channel 3	FREQUENCY RANGE	1 ~ 25GHz
INPUT POWER (SYSTEM)	120Vac, 60Hz	DETECTOR FUNCTION	Peak (PK) Average (AV)
ENVIRONMENTAL CONDITIONS	24deg. C, 68%RH	TESTED BY	Martin Lee

ANTENNA POLARITY & TEST DISTANCE: HORIZONTAL AT 3 M								
NO.	FREQ. (MHz)	EMISSION LEVEL (dBuV/m)	LIMIT (dBuV/m)	MARGIN (dB)	ANTENNA HEIGHT (m)	TABLE ANGLE (Degree)	RAW VALUE (dBuV)	CORRECTION FACTOR (dB/m)
1	2390.00	69.6 PK	74.0	-4.4	1.43 H	8	37.60	32.00
2	2390.00	52.1 AV	54.0	-1.9	1.43 H	8	20.10	32.00
3	*2422.00	99.9 PK			1.43 H	8	67.80	32.10
4	*2422.00	89.9 AV			1.43 H	8	57.80	32.10
5	4844.00	47.5 PK	74.0	-26.5	1.42 H	2	8.70	38.80
6	4844.00	34.6 AV	54.0	-19.4	1.42 H	2	-4.20	38.80
ANTENNA POLARITY & TEST DISTANCE: VERTICAL AT 3 M								
NO.	FREQ. (MHz)	EMISSION LEVEL (dBuV/m)	LIMIT (dBuV/m)	MARGIN (dB)	ANTENNA HEIGHT (m)	TABLE ANGLE (Degree)	RAW VALUE (dBuV)	CORRECTION FACTOR (dB/m)
1	2390.00	60.9 PK	74.0	-13.1	1.43 V	71	28.90	32.00
2	2390.00	46.8 AV	54.0	-7.2	1.43 V	71	14.80	32.00
3	*2422.00	93.4 PK			1.43 V	71	61.30	32.10
4	*2422.00	82.1 AV			1.43 V	71	50.00	32.10
5	4844.00	47.7 PK	74.0	-26.3	1.57 V	74	8.90	38.80
6	4844.00	34.7 AV	54.0	-19.3	1.57 V	74	-4.10	38.80

REMARKS:

1. Emission level (dBuV/m) = Raw Value (dBuV) + Correction Factor (dB/m).
2. Correction Factor (dB/m) = Antenna Factor (dB/m) + Cable Factor (dB).
3. The other emission levels were very low against the limit.
4. Margin value = Emission level – Limit value.
5. “ * “: Fundamental frequency.



A D T

EUT TEST CONDITION		MEASUREMENT DETAIL	
CHANNEL	Channel 6	FREQUENCY RANGE	1 ~ 25GHz
INPUT POWER (SYSTEM)	120Vac, 60Hz	DETECTOR FUNCTION	Peak (PK) Average (AV)
ENVIRONMENTAL CONDITIONS	24deg. C, 68%RH	TESTED BY	Martin Lee

ANTENNA POLARITY & TEST DISTANCE: HORIZONTAL AT 3 M								
NO.	FREQ. (MHz)	EMISSION LEVEL (dBuV/m)	LIMIT (dBuV/m)	MARGIN (dB)	ANTENNA HEIGHT (m)	TABLE ANGLE (Degree)	RAW VALUE (dBuV)	CORRECTION FACTOR (dB/m)
1	2390.00	71.0 PK	74.0	-3.0	1.36 H	8	39.00	32.00
2	2390.00	52.9 AV	54.0	-1.1	1.36 H	8	20.90	32.00
3	*2437.00	103.8 PK			1.36 H	8	71.70	32.10
4	*2437.00	93.5 AV			1.36 H	8	61.40	32.10
5	4874.00	48.2 PK	74.0	-25.8	1.20 H	20	9.30	38.90
6	4874.00	35.2 AV	54.0	-18.8	1.20 H	20	-3.70	38.90
ANTENNA POLARITY & TEST DISTANCE: VERTICAL AT 3 M								
NO.	FREQ. (MHz)	EMISSION LEVEL (dBuV/m)	LIMIT (dBuV/m)	MARGIN (dB)	ANTENNA HEIGHT (m)	TABLE ANGLE (Degree)	RAW VALUE (dBuV)	CORRECTION FACTOR (dB/m)
1	2390.00	62.3 PK	74.0	-11.7	1.39 V	124	30.30	32.00
2	2390.00	47.6 AV	54.0	-6.4	1.39 V	124	15.60	32.00
3	*2437.00	93.2 PK			1.39 V	124	61.10	32.10
4	*2437.00	84.0 AV			1.39 V	124	51.90	32.10
5	4874.00	47.1 PK	74.0	-26.9	1.85 V	52	8.20	38.90
6	4874.00	33.9 AV	54.0	-20.1	1.85 V	52	-5.00	38.90

REMARKS:

1. Emission level (dBuV/m) = Raw Value (dBuV) + Correction Factor (dB/m).
2. Correction Factor (dB/m) = Antenna Factor (dB/m) + Cable Factor (dB).
3. The other emission levels were very low against the limit.
4. Margin value = Emission level – Limit value.
5. “ * “: Fundamental frequency.



A D T

EUT TEST CONDITION		MEASUREMENT DETAIL	
CHANNEL	Channel 9	FREQUENCY RANGE	1 ~ 25GHz
INPUT POWER (SYSTEM)	120Vac, 60Hz	DETECTOR FUNCTION	Peak (PK) Average (AV)
ENVIRONMENTAL CONDITIONS	24deg. C, 68%RH	TESTED BY	Martin Lee

ANTENNA POLARITY & TEST DISTANCE: HORIZONTAL AT 3 M								
NO.	FREQ. (MHz)	EMISSION LEVEL (dBuV/m)	LIMIT (dBuV/m)	MARGIN (dB)	ANTENNA HEIGHT (m)	TABLE ANGLE (Degree)	RAW VALUE (dBuV)	CORRECTION FACTOR (dB/m)
1	*2452.00	104.9 PK			1.09 H	16	72.80	32.10
2	*2452.00	95.0 AV			1.09 H	16	62.90	32.10
3	2483.50	69.9 PK	74.0	-4.1	1.09 H	16	37.70	32.20
4	2483.50	52.8 AV	54.0	-1.2	1.09 H	16	20.60	32.20
5	4904.00	46.4 PK	74.0	-27.6	1.04 H	5	7.50	38.90
6	4904.00	33.9 AV	54.0	-20.1	1.04 H	5	-5.00	38.90
ANTENNA POLARITY & TEST DISTANCE: VERTICAL AT 3 M								
NO.	FREQ. (MHz)	EMISSION LEVEL (dBuV/m)	LIMIT (dBuV/m)	MARGIN (dB)	ANTENNA HEIGHT (m)	TABLE ANGLE (Degree)	RAW VALUE (dBuV)	CORRECTION FACTOR (dB/m)
1	*2452.00	94.4 PK			1.06 V	154	62.30	32.10
2	*2452.00	84.4 AV			1.06 V	154	52.30	32.10
3	2483.50	63.9 PK	74.0	-10.1	1.06 V	154	31.70	32.20
4	2483.50	47.1 AV	54.0	-6.9	1.06 V	154	14.90	32.20
5	4904.00	47.2 PK	74.0	-26.8	1.14 V	52	8.30	38.90
6	4904.00	34.2 AV	54.0	-19.8	1.14 V	52	-4.70	38.90

REMARKS:

1. Emission level (dBuV/m) = Raw Value (dBuV) + Correction Factor (dB/m).
2. Correction Factor (dB/m) = Antenna Factor (dB/m) + Cable Factor (dB).
3. The other emission levels were very low against the limit.
4. Margin value = Emission level – Limit value.
5. “ * “: Fundamental frequency.



A D T

BELOW 1GHz WORST-CASE DATA : 802.11n (20MHz)

EUT TEST CONDITION		MEASUREMENT DETAIL	
CHANNEL	Channel 1	FREQUENCY RANGE	Below 1000MHz
INPUT POWER (SYSTEM)	120Vac, 60Hz	DETECTOR FUNCTION	Quasi-Peak
ENVIRONMENTAL CONDITIONS	23deg. C, 71%RH	TESTED BY	Martin Lee

ANTENNA POLARITY & TEST DISTANCE: HORIZONTAL AT 3 M								
NO.	FREQ. (MHz)	EMISSION LEVEL (dBuV/m)	LIMIT (dBuV/m)	MARGIN (dB)	ANTENNA HEIGHT (m)	TABLE ANGLE (Degree)	RAW VALUE (dBuV)	CORRECTION FACTOR (dB/m)
1	49.40	33.5 QP	40.0	-6.5	1.75 H	49	20.00	13.50
2	119.24	37.8 QP	43.5	-5.7	1.50 H	327	26.50	11.30
3	198.78	38.1 QP	43.5	-5.4	1.00 H	122	27.20	10.90
4	478.14	34.8 QP	46.0	-11.2	1.75 H	208	15.40	19.40
5	499.48	38.3 QP	46.0	-7.7	1.99 H	162	18.30	20.00
6	749.74	35.7 QP	46.0	-10.3	1.00 H	206	11.50	24.20
7	796.30	38.2 QP	46.0	-7.8	1.24 H	110	13.20	25.00

ANTENNA POLARITY & TEST DISTANCE: VERTICAL AT 3 M								
NO.	FREQ. (MHz)	EMISSION LEVEL (dBuV/m)	LIMIT (dBuV/m)	MARGIN (dB)	ANTENNA HEIGHT (m)	TABLE ANGLE (Degree)	RAW VALUE (dBuV)	CORRECTION FACTOR (dB/m)
1	49.40	36.9 QP	40.0	-3.1	1.00 V	287	23.40	13.50
2	115.36	30.5 QP	43.5	-13.0	1.00 V	116	19.70	10.80
3	198.78	30.5 QP	43.5	-13.0	1.25 V	266	19.60	10.90
4	340.40	30.0 QP	46.0	-16.0	1.25 V	192	14.10	15.90
5	478.14	31.1 QP	46.0	-14.9	1.75 V	15	11.70	19.40
6	800.18	38.4 QP	46.0	-7.6	1.25 V	341	13.30	25.10

REMARKS:

1. Emission level (dBuV/m) = Raw Value (dBuV) + Correction Factor (dB/m).
2. Correction Factor (dB/m) = Antenna Factor (dB/m) + Cable Factor (dB).
3. The other emission levels were very low against the limit.
4. Margin value = Emission level – Limit value.



A D T

4.2 CONDUCTED EMISSION MEASUREMENT

4.2.1 LIMITS OF CONDUCTED EMISSION MEASUREMENT

FREQUENCY OF EMISSION (MHz)	CONDUCTED LIMIT (dB μ V)	
	Quasi-peak	Average
0.15 ~ 0.5	66 to 56	56 to 46
0.5 ~ 5	56	46
5 ~ 30	60	50

- NOTE:** 1. The lower limit shall apply at the transition frequencies.
2. The limit decreases in line with the logarithm of the frequency in the range of 0.15 to 0.50MHz.
3. All emanations from a class A/B digital device or system, including any network of conductors and apparatus connected thereto, shall not exceed the level of field strengths specified above.

4.2.2 TEST INSTRUMENTS

DESCRIPTION & MANUFACTURER	MODEL NO.	SERIAL NO.	DATE OF CALIBRATION	DUE DATE OF CALIBRATION
Test Receiver ROHDE & SCHWARZ	ESCS30	100288	Nov. 09, 2012	Nov. 08, 2013
RF signal cable Woken	5D-FB	Cable-HYCO2-01	Dec. 28, 2012	Dec. 27, 2013
LISN ROHDE & SCHWARZ (EUT)	ESH2-Z5	100100	Dec. 21, 2012	Dec. 20, 2013
LISN ROHDE & SCHWARZ (Peripheral)	ESH3-Z5	100311	Jul. 06, 2012	Jul. 05, 2013
Software ADT	BV ADT_Cond_ V7.3.7.3	NA	NA	NA

- NOTE:** 1. The calibration interval of the above test instruments is 12 months and the calibrations are traceable to NML/ROC and NIST/USA.
2. The test was performed in HwaYa Shielded Room 2.
3. The VCCI Site Registration No. is C-2047.

4.2.3 TEST PROCEDURES

- a. The EUT was placed 0.4 meters from the conducting wall of the shielded room with EUT being connected to the power mains through a line impedance stabilization network (LISN). Other support units were connected to the power mains through another LISN. The two LISNs provide 50 ohm/ 50uH of coupling impedance for the measuring instrument.
- b. Both lines of the power mains connected to the EUT were checked for maximum conducted interference.
- c. The frequency range from 150kHz to 30MHz was searched. Emission levels under (Limit - 20dB) was not recorded.

NOTE: All modes of operation were investigated and the worst-case emissions are reported.

4.2.4 DEVIATION FROM TEST STANDARD

No deviation.

4.2.5 TEST SETUP

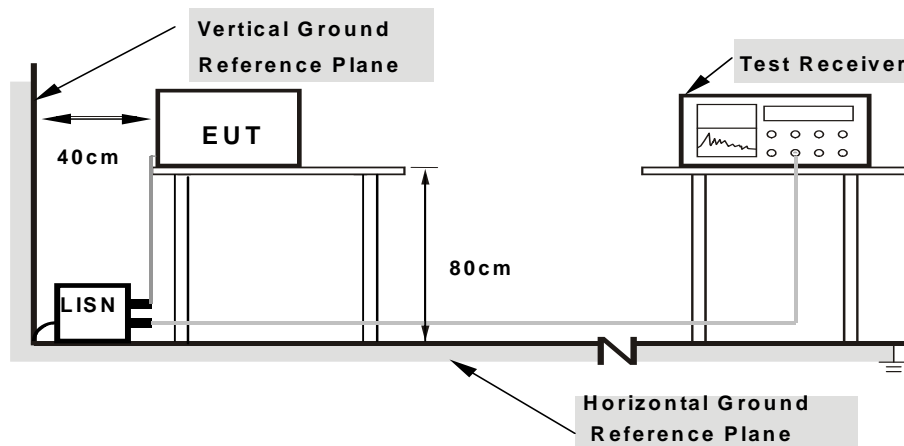

- Note:**
- 1.Support units were connected to second LISN.
 - 2.Both of LISNs (AMN) are 80 cm from EUT and at least 80 from other units and other metal planes

For the actual test configuration, please refer to the attached file (Test Setup Photo).

4.2.6 EUT OPERATING CONDITIONS

Same as 4.1.6.



A D T

4.2.7 TEST RESULTS

CONDUCTED WORST-CASE DATA : 802.11n (20MHz)

PHASE	Line 1	6dB BANDWIDTH	9kHz
-------	--------	---------------	------

No	Freq. [MHz]	Corr. Factor (dB)	Reading Value		Emission Level		Limit		Margin	
			[dB (uV)]		[dB (uV)]		[dB (uV)]		(dB)	
			Q.P.	AV.	Q.P.	AV.	Q.P.	AV.	Q.P.	AV.
1	0.20724	0.12	48.47	37.08	48.59	37.20	63.32	53.32	-14.72	-16.11
2	0.31007	0.14	36.49	28.25	36.63	28.39	59.97	49.97	-23.34	-21.58
3	0.41172	0.15	31.65	26.35	31.80	26.50	57.61	47.61	-25.81	-21.11
4	0.61875	0.17	29.17	28.09	29.34	28.26	56.00	46.00	-26.66	-17.74
5	7.72394	0.54	33.12	30.49	33.66	31.03	60.00	50.00	-26.34	-18.97
6	11.43359	0.73	33.03	30.79	33.76	31.52	60.00	50.00	-26.24	-18.48

- REMARKS:**
1. Q.P. and AV. are abbreviations of quasi-peak and average individually.
 2. The emission levels of other frequencies were very low against the limit.
 3. Margin value = Emission level - Limit value
 4. Correction factor = Insertion loss + Cable loss
 5. Emission Level = Correction Factor + Reading Value.

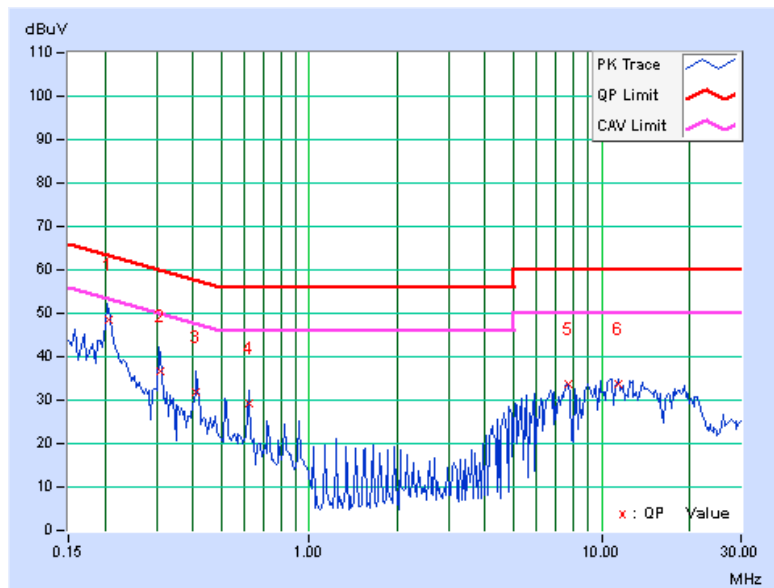

PHASE	Line 2	6dB BANDWIDTH	9kHz
-------	--------	---------------	------

No	Freq. [MHz]	Corr. Factor (dB)	Reading Value		Emission Level		Limit		Margin	
			[dB (uV)]		[dB (uV)]		[dB (uV)]		(dB)	
			Q.P.	AV.	Q.P.	AV.	Q.P.	AV.	Q.P.	AV.
1	0.20731	0.17	46.63	37.75	46.80	37.92	63.31	53.31	-16.51	-15.39
2	0.31016	0.19	34.76	27.45	34.95	27.64	59.97	49.97	-25.01	-22.32
3	0.51719	0.22	30.02	27.56	30.24	27.78	56.00	46.00	-25.76	-18.22
4	0.72422	0.23	25.67	22.37	25.90	22.60	56.00	46.00	-30.10	-23.40
5	7.76172	0.51	26.70	23.22	27.21	23.73	60.00	50.00	-32.79	-26.27
6	11.01563	0.62	22.78	16.77	23.40	17.39	60.00	50.00	-36.60	-32.61

- REMARKS:**
1. Q.P. and AV. are abbreviations of quasi-peak and average individually.
 2. The emission levels of other frequencies were very low against the limit.
 3. Margin value = Emission level - Limit value
 4. Correction factor = Insertion loss + Cable loss
 5. Emission Level = Correction Factor + Reading Value.

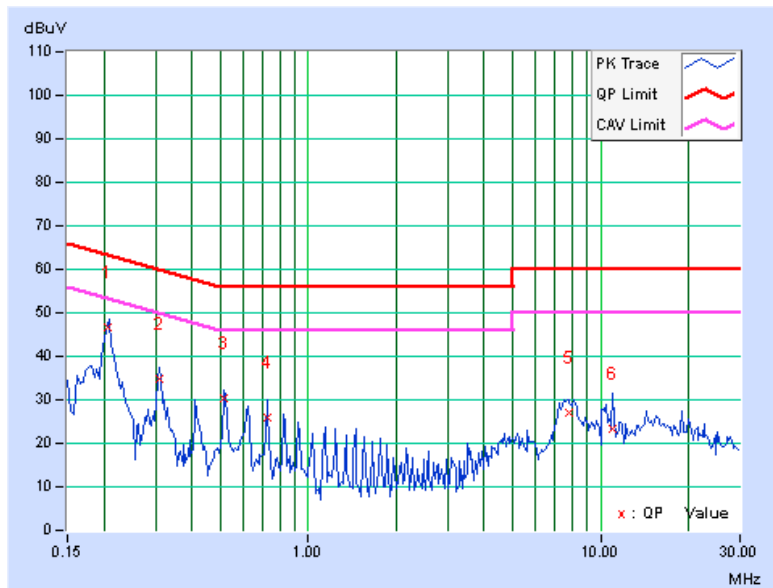

4.3 6dB BANDWIDTH MEASUREMENT

4.3.1 LIMITS OF 6dB BANDWIDTH MEASUREMENT

The minimum of 6dB Bandwidth Measurement is 0.5 MHz.

4.3.2 TEST SETUP

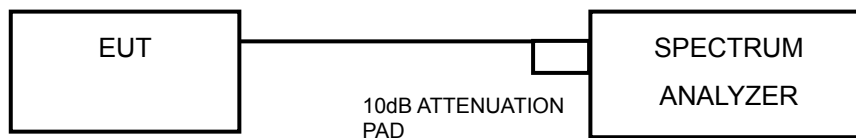

4.3.3 TEST INSTRUMENTS

Refer to section 4.1.2 to get information of above instrument.

4.3.4 TEST PROCEDURE

- a. Set resolution bandwidth (RBW) = approximately 1% of the emission bandwidth
- b. Set the video bandwidth (VBW) $\geq 3 \times$ RBW, Detector = Peak.
- c. Trace mode = max hold.
- d. Sweep = auto couple.
- e. Measure the maximum width of the emission that is constrained by the frequencies associated with the two amplitude points (upper and lower) that are attenuated by 6 dB relative to the maximum level measured in the fundamental emission

4.3.5 DEVIATION FROM TEST STANDARD

No deviation.

4.3.6 EUT OPERATING CONDITIONS

The software provided by client to enable the EUT under transmission condition continuously at lowest, middle and highest channel frequencies individually.



4.3.7 TEST RESULTS

802.11b

CHANNEL	FREQUENCY (MHz)	6dB BANDWIDTH (MHz)	MINIMUM LIMIT (MHz)	PASS / FAIL
1	2412	8.11	0.5	PASS
6	2437	7.84	0.5	PASS
11	2462	8.11	0.5	PASS

802.11g

CHANNEL	FREQUENCY (MHz)	6dB BANDWIDTH (MHz)	MINIMUM LIMIT (MHz)	PASS / FAIL
1	2412	15.16	0.5	PASS
6	2437	15.15	0.5	PASS
11	2462	14.08	0.5	PASS

802.11n (20MHz)

CHANNEL	FREQUENCY (MHz)	6dB BANDWIDTH (MHz)		MINIMUM LIMIT (MHz)	PASS / FAIL
		CHAIN 0	CHAIN 1		
1	2412	15.74	14.52	0.5	PASS
6	2437	15.02	16.58	0.5	PASS
11	2462	15.15	16.29	0.5	PASS

802.11n (40MHz)

CHANNEL	FREQUENCY (MHz)	6dB BANDWIDTH (MHz)		MINIMUM LIMIT (MHz)	PASS / FAIL
		CHAIN 0	CHAIN 1		
3	2422	36.43	36.47	0.5	PASS
6	2437	36.13	35.85	0.5	PASS
9	2452	36.54	36.47	0.5	PASS

4.4 CONDUCTED OUTPUT POWER

4.4.1 LIMITS OF CONDUCTED OUTPUT POWER MEASUREMENT

For systems using digital modulation in the 2400–2483.5 MHz bands: 1 Watt (30dBm)

Per KDB 662911 D01 Multiple Transmitter Output v01r02 Method of conducted output power measurement on IEEE 802.11 devices,

Array Gain = 0 dB (i.e., no array gain) for NANT \leq 4;

Array Gain = 0 dB (i.e., no array gain) for channel widths \geq 40 MHz for any NANT;

Array Gain = $5 \log(\text{NANT}/\text{NSS})$ dB or 3 dB, whichever is less for 20-MHz channel widths with NANT \geq 5.

For power measurements on all other devices: Array Gain = $10 \log(\text{NANT}/\text{NSS})$ dB.

4.4.2 TEST SETUP

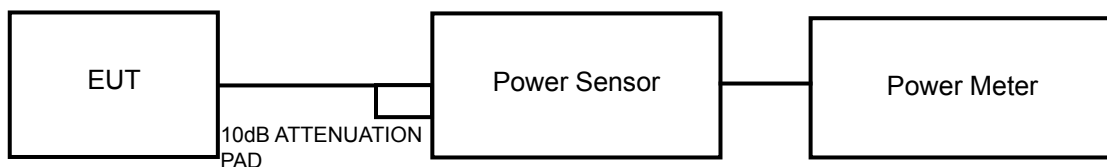

4.4.3 TEST INSTRUMENTS

Refer to section 4.1.2 to get information of above instrument.

4.4.4 TEST PROCEDURES

A peak / average power sensor were used on the output port of the EUT. A power meter was used to read the response of the peak / average power sensor. Record the peak power level.



A D T

4.4.5 DEVIATION FROM TEST STANDARD

No deviation.

4.4.6 EUT OPERATING CONDITIONS

Same as Item 4.3.6.



A D T

4.4.7 TEST RESULTS

FOR PEAK POWER

802.11b

CHANNEL	FREQUENCY (MHz)	PEAK POWER (mW)	PEAK POWER (dBm)	LIMIT (dBm)	PASS/FAIL
1	2412	171.396	22.34	30	PASS
6	2437	169.824	22.30	30	PASS
11	2462	164.816	22.17	30	PASS

802.11g

CHANNEL	FREQUENCY (MHz)	PEAK POWER (mW)	PEAK POWER (dBm)	LIMIT (dBm)	PASS/FAIL
1	2412	326.588	25.14	30	PASS
6	2437	344.350	25.37	30	PASS
11	2462	328.852	25.17	30	PASS

802.11n (20MHz)

CHAN.	FREQ. (MHz)	PEAK POWER (dBm)		TOTAL POWER (mW)	TOTAL POWER (dBm)	LIMIT (dBm)	PASS / FAIL
		CHAIN 0	CHAIN 1				
1	2412	25.21	25.42	680.231	28.33	30	PASS
6	2437	25.04	25.48	672.337	28.28	30	PASS
11	2462	24.18	25.91	651.760	28.14	30	PASS

802.11n (40MHz)

CHAN.	FREQ. (MHz)	PEAK POWER (dBm)		TOTAL POWER (mW)	TOTAL POWER (dBm)	LIMIT (dBm)	PASS / FAIL
		CHAIN 0	CHAIN 1				
3	2422	21.52	22.87	335.548	25.26	30	PASS
6	2437	22.76	23.49	412.156	26.15	30	PASS
9	2452	22.46	25.02	493.885	26.94	30	PASS



A D T

FOR AVERAGE POWER

802.11b

CHANNEL	FREQUENCY (MHz)	AVERAGE POWER (mW)	AVERAGE POWER (dBm)
1	2412	69.984	18.45
6	2437	69.823	18.44
11	2462	70.146	18.46

802.11g

CHANNEL	FREQUENCY (MHz)	AVERAGE POWER (mW)	AVERAGE POWER (dBm)
1	2412	50.466	17.03
6	2437	50.816	17.06
11	2462	50.582	17.04

802.11n (20MHz)

CHAN.	FREQUENCY (MHz)	AVG. POWER (dBm)		TOTAL POWER (mW)	TOTAL POWER (dBm)
		CHAIN 0	CHAIN 1		
1	2412	16.59	16.28	88.066	19.45
6	2437	17.39	17.01	105.062	20.21
11	2462	16.53	16.27	87.342	19.41

802.11n (40MHz)

CHAN.	FREQUENCY (MHz)	AVG. POWER (dBm)		TOTAL POWER (mW)	TOTAL POWER (dBm)
		CHAIN 0	CHAIN 1		
3	2422	13.34	13.97	46.523	16.68
6	2437	15.52	14.51	63.894	18.05
9	2452	14.51	14.91	59.223	17.72

4.5 POWER SPECTRAL DENSITY MEASUREMENT

4.5.1 LIMITS OF POWER SPECTRAL DENSITY MEASUREMENT

The Maximum of Power Spectral Density Measurement is 8dBm.

4.5.2 TEST SETUP

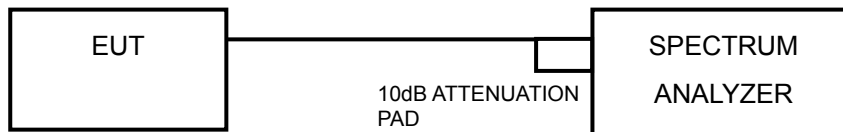

4.5.3 TEST INSTRUMENTS

Refer to section 4.1.2 to get information of above instrument.

4.5.4 TEST PROCEDURE

- Set the RBW = 3 kHz, VBW = 10 kHz, Detector = peak.
- Sweep time = auto couple, Trace mode = max hold, allow trace to fully stabilize.
- Use the peak marker function to determine the maximum power level in any 100 kHz band segment within the fundamental EBW.

4.5.5 DEVIATION FROM TEST STANDARD

No deviation.

4.5.6 EUT OPERATING CONDITION

Same as Item 4.3.6



A D T

4.5.7 TEST RESULTS

802.11b

Channel	Freq. (MHz)	PSD (dBm/3kHz)	Limit (dBm/3kHz)	PASS /FAIL
1	2412	-3.60	8	PASS
6	2437	-5.97	8	PASS
11	2462	-5.76	8	PASS

802.11g

Channel	Freq. (MHz)	PSD (dBm/3kHz)	Limit (dBm/3kHz)	PASS /FAIL
1	2412	-9.27	8	PASS
6	2437	-8.13	8	PASS
11	2462	-9.41	8	PASS

802.11n (20MHz)

TX chain	Channel	Freq. (MHz)	PSD (dBm/3kHz)	10 log (N=2) dB	Total PSD (dBm/3kHz)	Limit (dBm/3kHz)	PASS /FAIL
0	1	2412	-11.17	3.01	-8.16	8	PASS
	6	2437	-7.87	3.01	-4.86	8	PASS
	11	2462	-10.18	3.01	-7.17	8	PASS
1	1	2412	-10.46	3.01	-7.45	8	PASS
	6	2437	-8.51	3.01	-5.50	8	PASS
	11	2462	-10.20	3.01	-7.19	8	PASS

NOTE: Directional gain = $10 \log[(10^{G1/20} + 10^{G2/20} + \dots + 10^{GN/20})^2 / N_{ANT}] = 5.33 < 6\text{dBi}$, so the limit no need to reduced.

802.11n (40MHz)

TX chain	Channel	Freq. (MHz)	PSD (dBm/3kHz)	10 log (N=2) dB	Total PSD (dBm/3kHz)	Limit (dBm/3kHz)	PASS /FAIL
0	3	2422	-16.61	3.01	-13.60	8	PASS
	6	2437	-15.79	3.01	-12.78	8	PASS
	9	2452	-14.20	3.01	-11.19	8	PASS
1	3	2422	-15.87	3.01	-12.86	8	PASS
	6	2437	-15.51	3.01	-12.50	8	PASS
	9	2452	-14.52	3.01	-11.51	8	PASS

NOTE: Directional gain = $10 \log[(10^{G1/20} + 10^{G2/20} + \dots + 10^{GN/20})^2 / N_{ANT}] = 5.33 < 6\text{dBi}$, so the limit no need to reduced.

4.6 CONDUCTED OUT OF BAND EMISSION MEASUREMENT

4.6.1 LIMITS OF CONDUCTED OUT OF BAND EMISSION MEASUREMENT

Below -20dB of the highest emission level of operating band (in 100kHz Resolution Bandwidth).

4.6.2 TEST SETUP

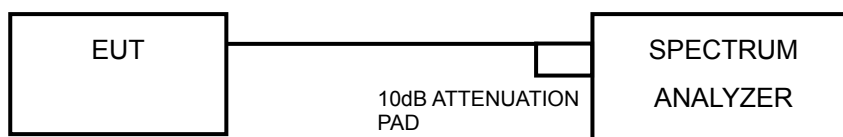

4.6.3 TEST INSTRUMENTS

Refer to section 4.1.2 to get information of above instrument.

4.6.4 TEST PROCEDURE

MEASUREMENT PROCEDURE REF

1. Set the RBW = 100 kHz.
2. Set the VBW \geq 300 kHz.
3. Detector = peak.
4. Sweep time = auto couple.
5. Trace mode = max hold.
6. Allow trace to fully stabilize.
7. Use the peak marker function to determine the maximum power level in any 100 kHz band segment within the fundamental EBW.



A D T

MEASUREMENT PROCEDURE OOB

1. Set RBW = 100 kHz.
2. Set VBW \geq 300 kHz.
3. Set span to encompass the spectrum to be examined.
4. Detector = peak.
5. Trace Mode = max hold.
6. Sweep = auto couple.

4.6.5 DEVIATION FROM TEST STANDARD

No deviation.

4.6.6 EUT OPERATING CONDITION

Same as Item 4.3.6

4.6.7 TEST RESULTS

The conducted emission test is performed on each TX port of operating mode without summing or adding $10\log(N)$ since the limit is relative emission limit.

The spectrum plots are attached on the following pages. D1 line indicates the highest level, and D2 line indicates the 20dB offset below D1. It shows compliance with the requirement.



A D T

802.11b

CH 1

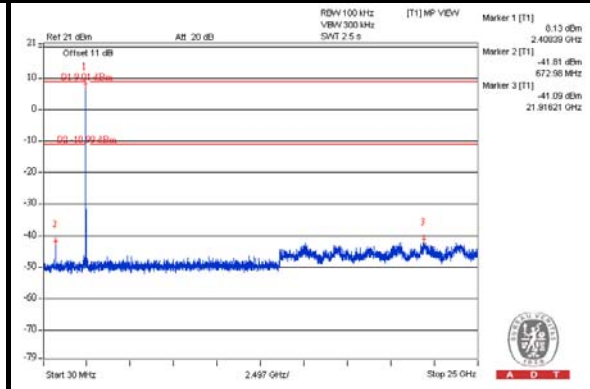
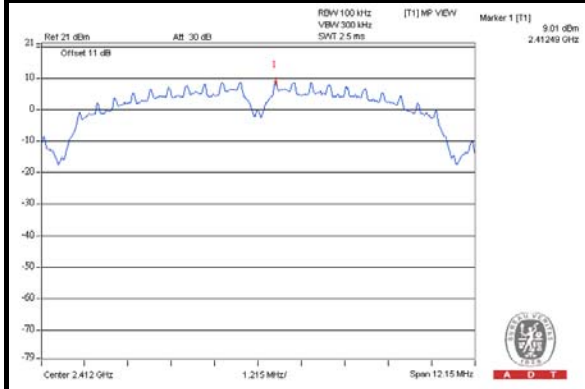

CH 6

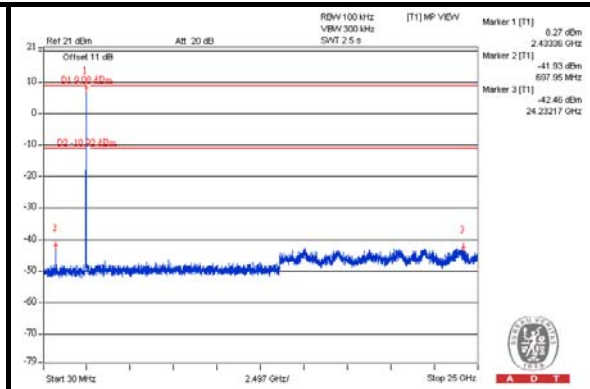
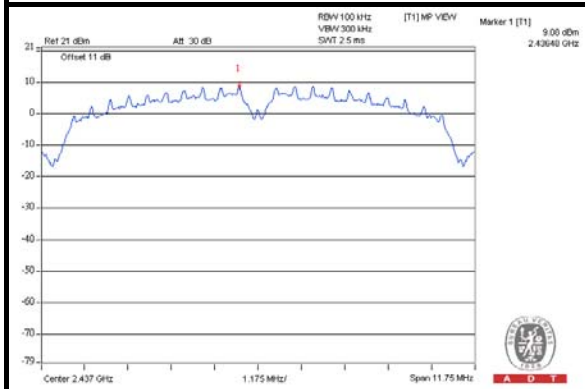

CH 11

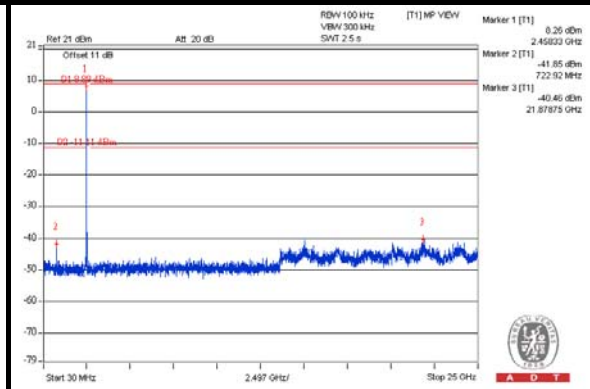
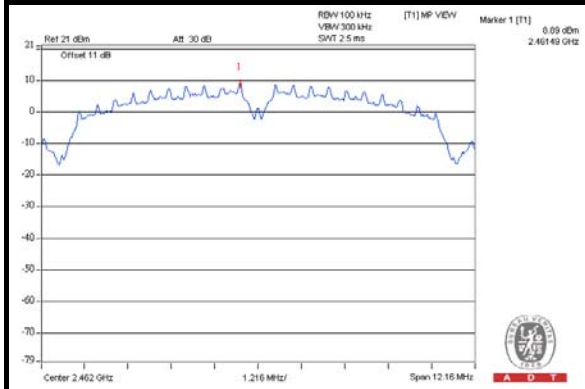



A D T

802.11g

CH 1

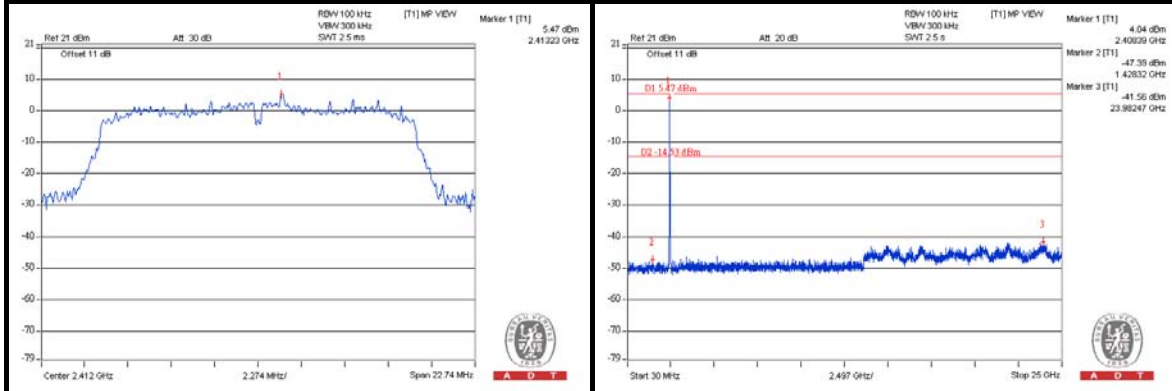

CH 6

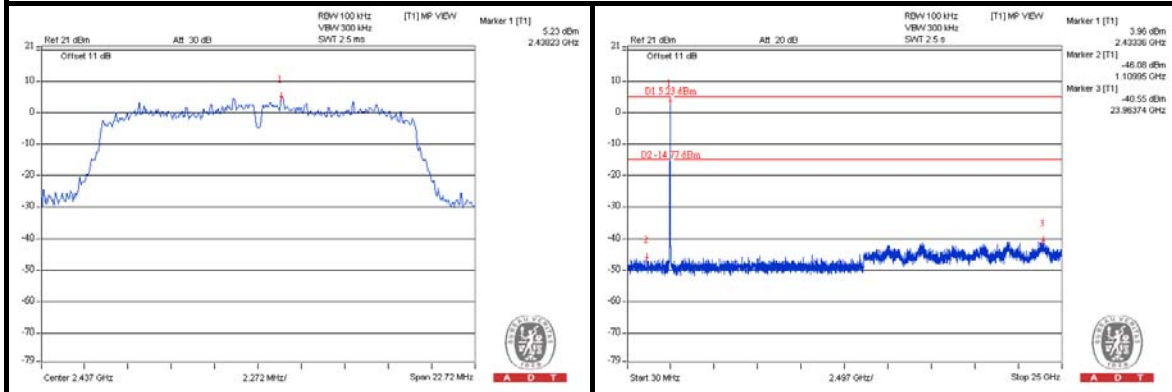

CH 11

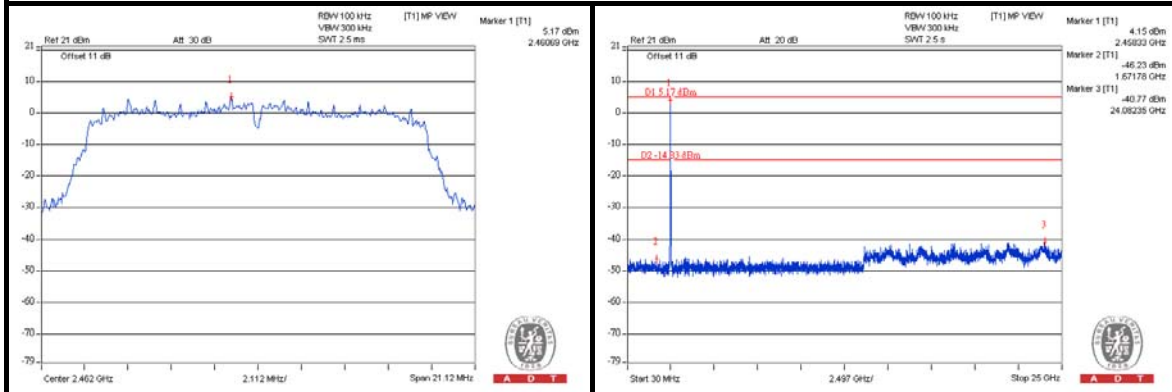



A D T

802.11n (20MHz) CHAIN 0

CH 1

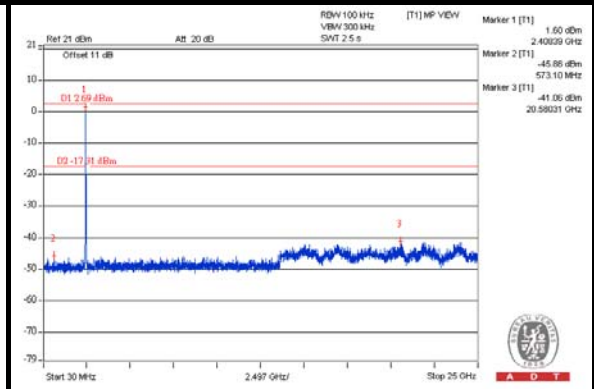
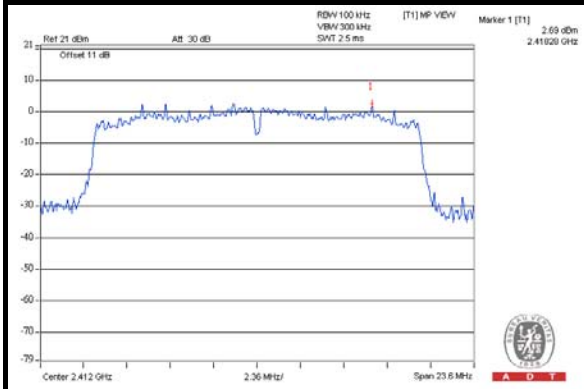

CH 6

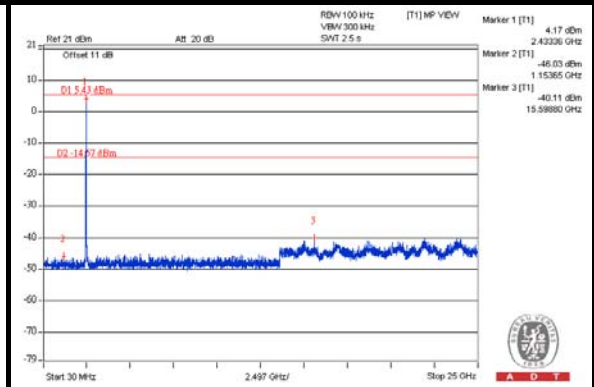
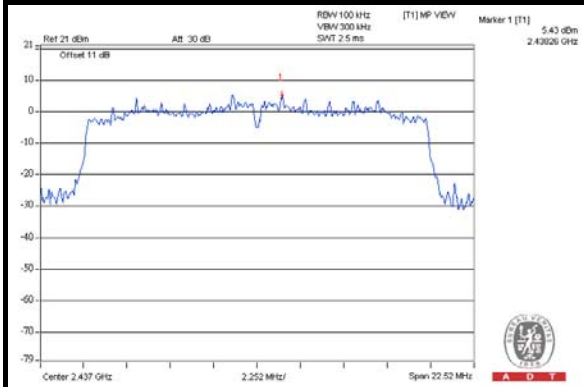

CH 11

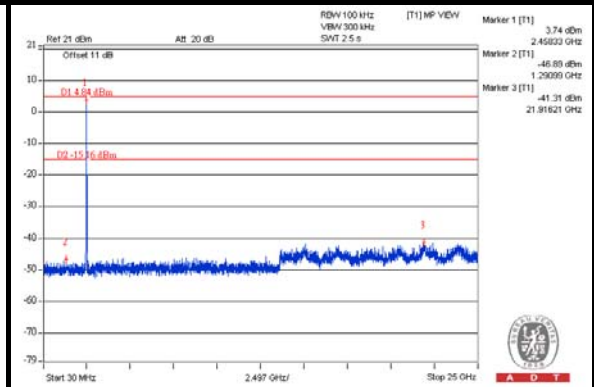
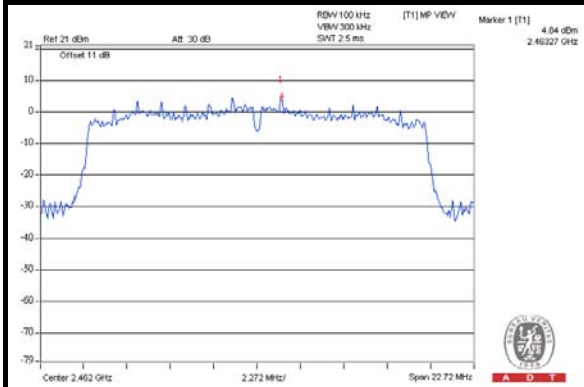

CHAIN 1

CH 1

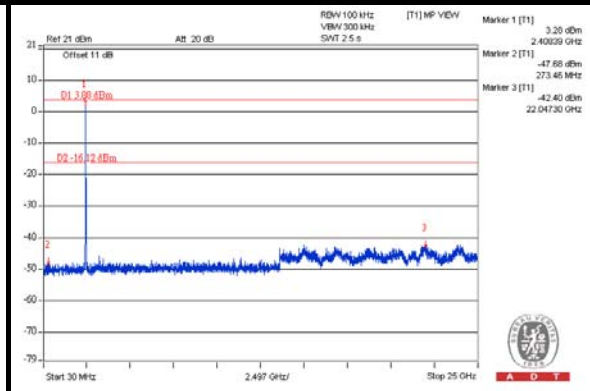
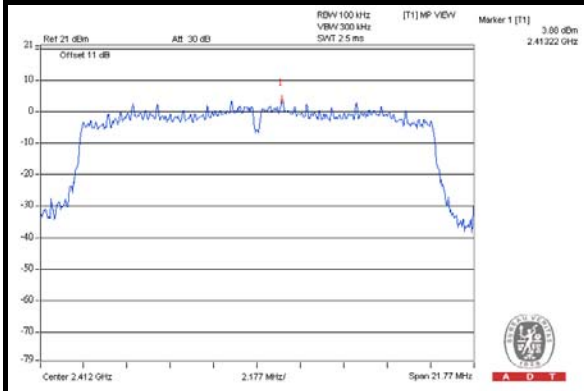

CH 6

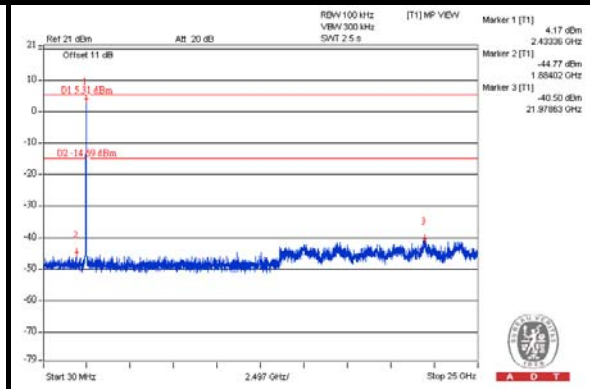
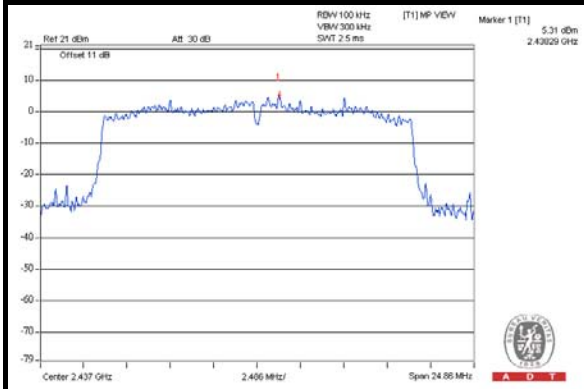

CH 11

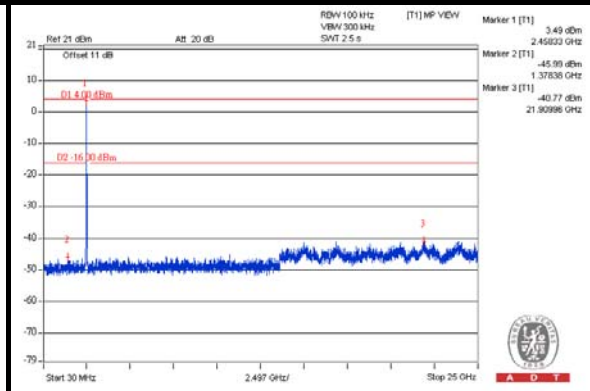
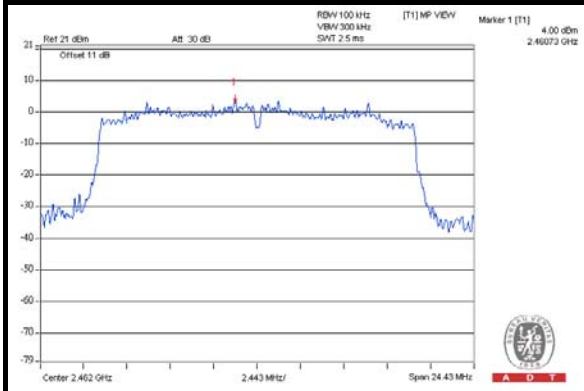



A D T

802.11n (40MHz) CHAIN 0

CH 3

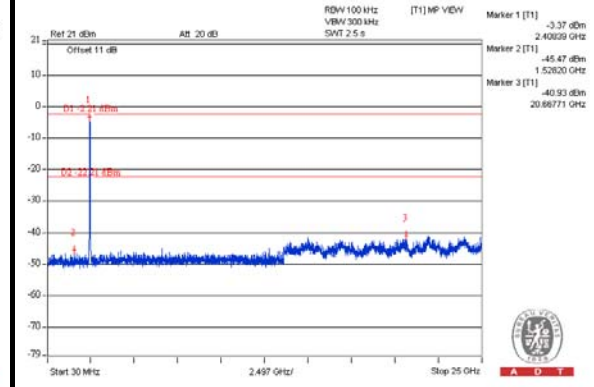
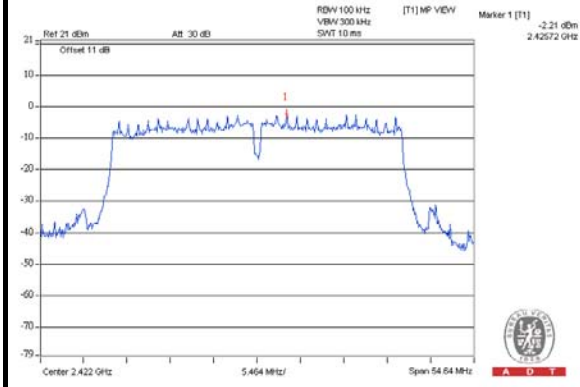

CH 6

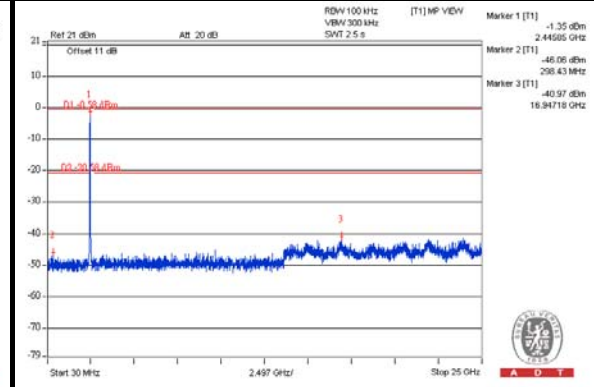
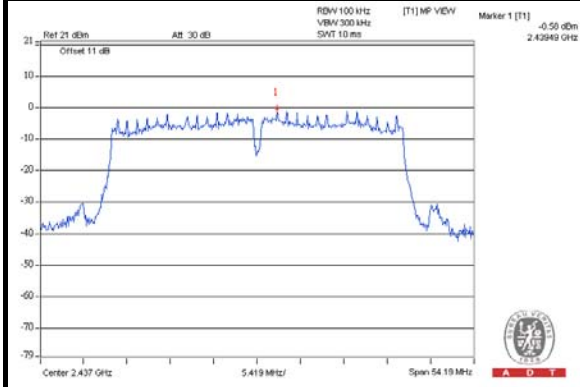

CH 9

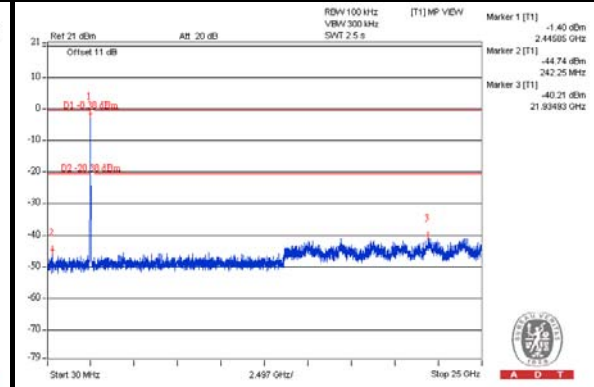
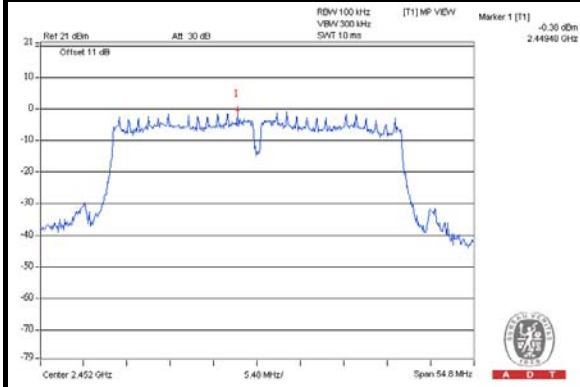



A D T

CHAIN 1

CH 3

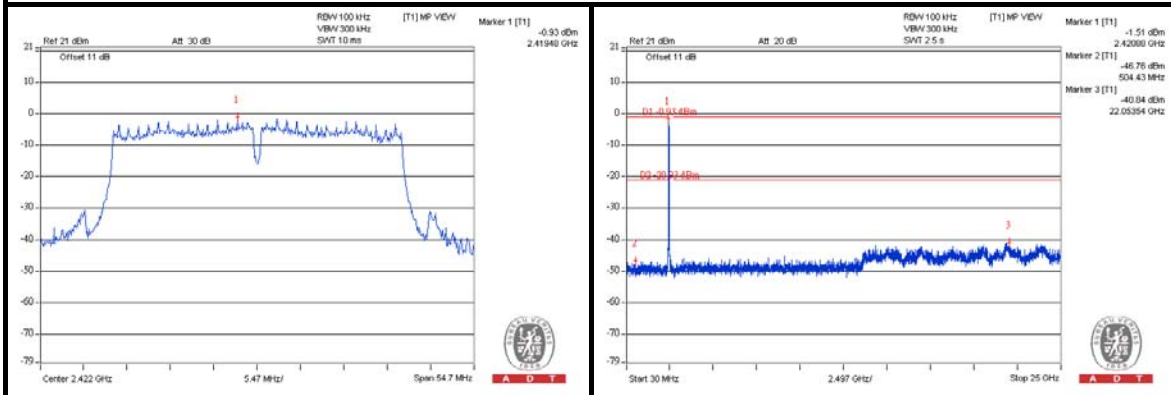

CH 6

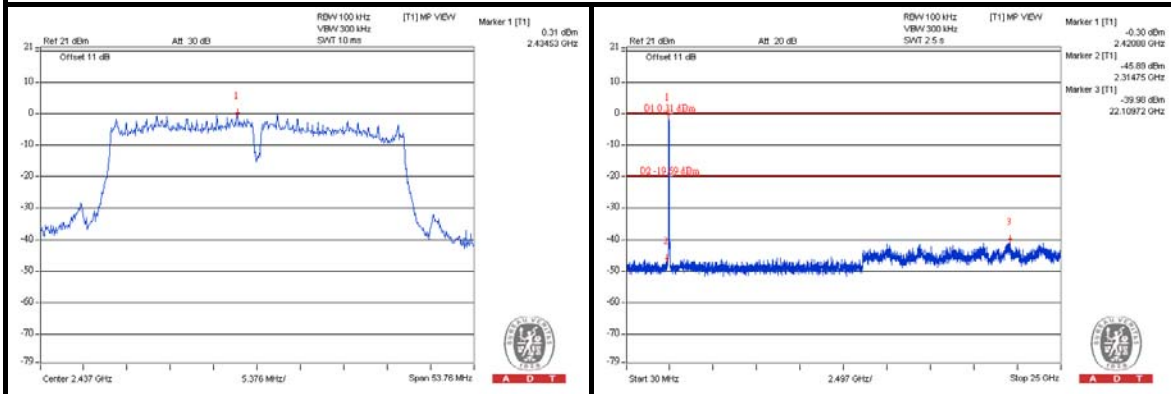

CH 9

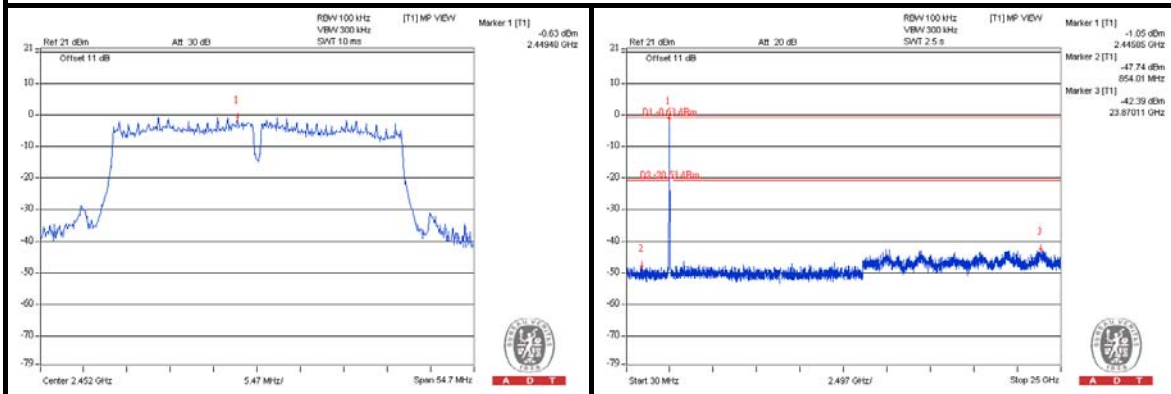



5. TEST TYPES AND RESULTS (FOR 5.0GHz BAND)

5.1 RADIATED EMISSION MEASUREMENT

5.1.1 LIMITS OF RADIATED EMISSION MEASUREMENT

Radiated emissions which fall in the restricted bands must comply with the radiated emission limits specified as below table. Other emissions shall be at least 20dB below the highest level of the desired power:

FREQUENCIES (MHz)	FIELD STRENGTH (microvolts/meter)	MEASUREMENT DISTANCE (meters)
0.009 ~ 0.490	2400/F(kHz)	300
0.490 ~ 1.705	24000/F(kHz)	30
1.705 ~ 30.0	30	30
30 ~ 88	100	3
88 ~ 216	150	3
216 ~ 960	200	3
Above 960	500	3

NOTE:

1. The lower limit shall apply at the transition frequencies.
2. Emission level (dBuV/m) = 20 log Emission level (uV/m).
3. For frequencies above 1000MHz, the field strength limits are based on average detector, however, the peak field strength of any emission shall not exceed the maximum permitted average limits, specified above by more than 20dB under any condition of modulation.



A D T

5.1.2 TEST INSTRUMENTS

Same as item 4.1.2.

5.1.3 TEST PROCEDURES

Same as item 4.1.3.

5.1.4 DEVIATION FROM TEST STANDARD

No deviation.

5.1.5 TEST SETUP

Same as item 4.1.5.

5.1.6 EUT OPERATING CONDITIONS

Same as item 4.1.6.



A D T

5.1.7 TEST RESULTS

802.11a

EUT TEST CONDITION		MEASUREMENT DETAIL	
CHANNEL	Channel 149	FREQUENCY RANGE	1 ~ 40GHz
INPUT POWER (SYSTEM)	120Vac, 60Hz	DETECTOR FUNCTION	Peak (PK) Average (AV)
ENVIRONMENTAL CONDITIONS	24deg. C, 68%RH	TESTED BY	Martin Lee

ANTENNA POLARITY & TEST DISTANCE: HORIZONTAL AT 3 M								
NO.	FREQ. (MHz)	EMISSION LEVEL (dBuV/m)	LIMIT (dBuV/m)	MARGIN (dB)	ANTENNA HEIGHT (m)	TABLE ANGLE (Degree)	RAW VALUE (dBuV)	CORRECTION FACTOR (dB/m)
1	#5725.00	60.4 PK	83.8	-23.4	1.27 H	155	20.10	40.30
2	#5725.00	49.0 AV	72.4	-23.4	1.27 H	155	8.70	40.30
3	*5745.00	103.8 PK			1.27 H	155	63.50	40.30
4	*5745.00	92.4 AV			1.27 H	155	52.10	40.30
5	11490.00	57.7 PK	74.0	-16.3	1.24 H	5	9.30	48.40
6	11490.00	44.5 AV	54.0	-9.5	1.24 H	5	-3.90	48.40
ANTENNA POLARITY & TEST DISTANCE: VERTICAL AT 3 M								
NO.	FREQ. (MHz)	EMISSION LEVEL (dBuV/m)	LIMIT (dBuV/m)	MARGIN (dB)	ANTENNA HEIGHT (m)	TABLE ANGLE (Degree)	RAW VALUE (dBuV)	CORRECTION FACTOR (dB/m)
1	#5725.00	58.1 PK	81.5	-23.4	1.26 V	299	17.80	40.30
2	#5725.00	47.5 AV	70.9	-23.4	1.26 V	299	7.20	40.30
3	*5745.00	101.5 PK			1.27 V	299	61.20	40.30
4	*5745.00	90.9 AV			1.27 V	299	50.60	40.30
5	11490.00	58.0 PK	74.0	-16.0	1.32 V	65	9.60	48.40
6	11490.00	44.8 AV	54.0	-9.2	1.32 V	65	-3.60	48.40

REMARKS:

1. Emission level (dBuV/m) = Raw Value (dBuV) + Correction Factor (dB/m).
2. Correction Factor (dB/m) = Antenna Factor (dB/m) + Cable Factor (dB).
3. The other emission levels were very low against the limit.
4. Margin value = Emission level – Limit value.
5. “ * “: Fundamental frequency.
6. The limit value is defined as per 15.247.
7. "#":The radiated frequency is out the restricted band.



A D T

EUT TEST CONDITION		MEASUREMENT DETAIL	
CHANNEL	Channel 157	FREQUENCY RANGE	1 ~ 40GHz
INPUT POWER (SYSTEM)	120Vac, 60Hz	DETECTOR FUNCTION	Peak (PK) Average (AV)
ENVIRONMENTAL CONDITIONS	24deg. C, 68%RH	TESTED BY	Martin Lee

ANTENNA POLARITY & TEST DISTANCE: HORIZONTAL AT 3 M								
NO.	FREQ. (MHz)	EMISSION LEVEL (dBuV/m)	LIMIT (dBuV/m)	MARGIN (dB)	ANTENNA HEIGHT (m)	TABLE ANGLE (Degree)	RAW VALUE (dBuV)	CORRECTION FACTOR (dB/m)
1	*5785.00	104.8 PK			1.61 H	120	64.50	40.30
2	*5785.00	93.8 AV			1.61 H	120	53.50	40.30
3	11570.00	58.5 PK	74.0	-15.5	1.85 H	44	10.10	48.40
4	11570.00	45.3 AV	54.0	-8.7	1.85 H	44	-3.10	48.40
ANTENNA POLARITY & TEST DISTANCE: VERTICAL AT 3 M								
NO.	FREQ. (MHz)	EMISSION LEVEL (dBuV/m)	LIMIT (dBuV/m)	MARGIN (dB)	ANTENNA HEIGHT (m)	TABLE ANGLE (Degree)	RAW VALUE (dBuV)	CORRECTION FACTOR (dB/m)
1	*5785.00	101.8 PK			1.26 V	302	61.50	40.30
2	*5785.00	91.3 AV			1.26 V	302	51.00	40.30
3	11570.00	57.2 PK	74.0	-16.8	1.32 V	5	8.80	48.40
4	11570.00	43.6 AV	54.0	-10.4	1.32 V	5	-4.80	48.40

REMARKS:

1. Emission level (dBuV/m) = Raw Value (dBuV) + Correction Factor (dB/m).
2. Correction Factor (dB/m) = Antenna Factor (dB/m) + Cable Factor (dB).
3. The other emission levels were very low against the limit.
4. Margin value = Emission level – Limit value.
5. “ * “: Fundamental frequency.
6. The limit value is defined as per 15.247.



A D T

EUT TEST CONDITION		MEASUREMENT DETAIL	
CHANNEL	Channel 165	FREQUENCY RANGE	1 ~ 40GHz
INPUT POWER (SYSTEM)	120Vac, 60Hz	DETECTOR FUNCTION	Peak (PK) Average (AV)
ENVIRONMENTAL CONDITIONS	24deg. C, 68%RH	TESTED BY	Martin Lee

ANTENNA POLARITY & TEST DISTANCE: HORIZONTAL AT 3 M								
NO.	FREQ. (MHz)	EMISSION LEVEL (dBuV/m)	LIMIT (dBuV/m)	MARGIN (dB)	ANTENNA HEIGHT (m)	TABLE ANGLE (Degree)	RAW VALUE (dBuV)	CORRECTION FACTOR (dB/m)
1	*5825.00	105.3 PK			1.61 H	124	64.90	40.40
2	*5825.00	95.0 AV			1.61 H	124	54.60	40.40
3	#5850.00	60.1 PK	85.3	-25.2	1.61 H	124	19.70	40.40
4	#5850.00	49.8 AV	75.0	-25.2	1.61 H	124	9.40	40.40
5	11650.00	57.5 PK	74.0	-16.5	1.25 H	5	9.00	48.50
6	11650.00	44.8 AV	54.0	-9.2	1.25 H	5	-3.70	48.50
ANTENNA POLARITY & TEST DISTANCE: VERTICAL AT 3 M								
NO.	FREQ. (MHz)	EMISSION LEVEL (dBuV/m)	LIMIT (dBuV/m)	MARGIN (dB)	ANTENNA HEIGHT (m)	TABLE ANGLE (Degree)	RAW VALUE (dBuV)	CORRECTION FACTOR (dB/m)
1	*5825.00	102.3 PK			1.50 V	281	61.90	40.40
2	*5825.00	91.3 AV			1.50 V	281	50.90	40.40
3	#5850.00	57.1 PK	82.3	-25.2	1.50 V	281	16.70	40.40
4	#5850.00	46.1 AV	71.3	-25.2	1.50 V	281	5.70	40.40
5	11650.00	57.5 PK	74.0	-16.5	1.36 V	63	9.00	48.50
6	11650.00	43.5 AV	54.0	-10.5	1.36 V	63	-5.00	48.50

REMARKS:

1. Emission level (dBuV/m) = Raw Value (dBuV) + Correction Factor (dB/m).
2. Correction Factor (dB/m) = Antenna Factor (dB/m) + Cable Factor (dB).
3. The other emission levels were very low against the limit.
4. Margin value = Emission level – Limit value.
5. “ * “: Fundamental frequency.
6. The limit value is defined as per 15.247.
7. “#”:The radiated frequency is out the restricted band.



A D T

802.11n (20MHz)

EUT TEST CONDITION		MEASUREMENT DETAIL	
CHANNEL	Channel 149	FREQUENCY RANGE	1 ~ 40GHz
INPUT POWER (SYSTEM)	120Vac, 60Hz	DETECTOR FUNCTION	Peak (PK) Average (AV)
ENVIRONMENTAL CONDITIONS	24deg. C, 68%RH	TESTED BY	Martin Lee

ANTENNA POLARITY & TEST DISTANCE: HORIZONTAL AT 3 M								
NO.	FREQ. (MHz)	EMISSION LEVEL (dBuV/m)	LIMIT (dBuV/m)	MARGIN (dB)	ANTENNA HEIGHT (m)	TABLE ANGLE (Degree)	RAW VALUE (dBuV)	CORRECTION FACTOR (dB/m)
1	#5725.00	60.6 PK	82.9	-22.3	1.32 H	152	20.30	40.30
2	#5725.00	50.6 AV	72.9	-22.3	1.32 H	152	10.30	40.30
3	*5745.00	102.9 PK			1.32 H	152	62.60	40.30
4	*5745.00	92.9 AV			1.32 H	152	52.60	40.30
5	11490.00	57.4 PK	74.0	-16.6	1.36 H	44	9.00	48.40
6	11490.00	43.9 AV	54.0	-10.1	1.36 H	44	-4.50	48.40

ANTENNA POLARITY & TEST DISTANCE: VERTICAL AT 3 M								
NO.	FREQ. (MHz)	EMISSION LEVEL (dBuV/m)	LIMIT (dBuV/m)	MARGIN (dB)	ANTENNA HEIGHT (m)	TABLE ANGLE (Degree)	RAW VALUE (dBuV)	CORRECTION FACTOR (dB/m)
1	#5725.00	60.8 PK	83.1	-22.3	1.27 V	301	20.50	40.30
2	#5725.00	50.3 AV	72.6	-22.3	1.27 V	301	10.00	40.30
3	*5745.00	103.1 PK			1.27 V	301	62.80	40.30
4	*5745.00	92.6 AV			1.27 V	301	52.30	40.30
5	11490.00	57.9 PK	74.0	-16.1	1.63 V	333	9.50	48.40
6	11490.00	44.4 AV	54.0	-9.6	1.63 V	333	-4.00	48.40

REMARKS:

1. Emission level (dBuV/m) = Raw Value (dBuV) + Correction Factor (dB/m).
2. Correction Factor (dB/m) = Antenna Factor (dB/m) + Cable Factor (dB).
3. The other emission levels were very low against the limit.
4. Margin value = Emission level – Limit value.
5. “ * “: Fundamental frequency.
6. The limit value is defined as per 15.247.
7. "#":The radiated frequency is out the restricted band.



A D T

EUT TEST CONDITION		MEASUREMENT DETAIL	
CHANNEL	Channel 157	FREQUENCY RANGE	1 ~ 40GHz
INPUT POWER (SYSTEM)	120Vac, 60Hz	DETECTOR FUNCTION	Peak (PK) Average (AV)
ENVIRONMENTAL CONDITIONS	24deg. C, 68%RH	TESTED BY	Martin Lee

ANTENNA POLARITY & TEST DISTANCE: HORIZONTAL AT 3 M								
NO.	FREQ. (MHz)	EMISSION LEVEL (dBuV/m)	LIMIT (dBuV/m)	MARGIN (dB)	ANTENNA HEIGHT (m)	TABLE ANGLE (Degree)	RAW VALUE (dBuV)	CORRECTION FACTOR (dB/m)
1	*5785.00	106.7 PK			1.62 H	120	66.40	40.30
2	*5785.00	95.8 AV			1.62 H	120	55.50	40.30
3	11570.00	58.9 PK	74.0	-15.1	1.24 H	36	10.50	48.40
4	11570.00	45.3 AV	54.0	-8.7	1.24 H	36	-3.10	48.40
ANTENNA POLARITY & TEST DISTANCE: VERTICAL AT 3 M								
NO.	FREQ. (MHz)	EMISSION LEVEL (dBuV/m)	LIMIT (dBuV/m)	MARGIN (dB)	ANTENNA HEIGHT (m)	TABLE ANGLE (Degree)	RAW VALUE (dBuV)	CORRECTION FACTOR (dB/m)
1	*5785.00	103.6 PK			1.27 V	305	63.30	40.30
2	*5785.00	93.4 AV			1.27 V	305	53.10	40.30
3	11570.00	58.2 PK	74.0	-15.8	1.04 V	42	9.80	48.40
4	11570.00	44.8 AV	54.0	-9.2	1.04 V	42	-3.60	48.40

REMARKS:

1. Emission level (dBuV/m) = Raw Value (dBuV) + Correction Factor (dB/m).
2. Correction Factor (dB/m) = Antenna Factor (dB/m) + Cable Factor (dB).
3. The other emission levels were very low against the limit.
4. Margin value = Emission level – Limit value.
5. “ * ”: Fundamental frequency.
6. The limit value is defined as per 15.247.



A D T

EUT TEST CONDITION		MEASUREMENT DETAIL	
CHANNEL	Channel 165	FREQUENCY RANGE	1 ~ 40GHz
INPUT POWER (SYSTEM)	120Vac, 60Hz	DETECTOR FUNCTION	Peak (PK) Average (AV)
ENVIRONMENTAL CONDITIONS	24deg. C, 68%RH	TESTED BY	Martin Lee

ANTENNA POLARITY & TEST DISTANCE: HORIZONTAL AT 3 M								
NO.	FREQ. (MHz)	EMISSION LEVEL (dBuV/m)	LIMIT (dBuV/m)	MARGIN (dB)	ANTENNA HEIGHT (m)	TABLE ANGLE (Degree)	RAW VALUE (dBuV)	CORRECTION FACTOR (dB/m)
1	*5825.00	106.1 PK			1.58 H	120	65.70	40.40
2	*5825.00	96.0 AV			1.58 H	120	55.60	40.40
3	#5850.00	68.4 PK	86.1	-17.7	1.58 H	120	28.00	40.40
4	#5850.00	58.3 AV	76.0	-17.7	1.58 H	120	17.90	40.40
5	11650.00	57.8 PK	74.0	-16.2	1.77 H	8	9.30	48.50
6	11650.00	45.6 AV	54.0	-8.4	1.77 H	8	-2.90	48.50
ANTENNA POLARITY & TEST DISTANCE: VERTICAL AT 3 M								
NO.	FREQ. (MHz)	EMISSION LEVEL (dBuV/m)	LIMIT (dBuV/m)	MARGIN (dB)	ANTENNA HEIGHT (m)	TABLE ANGLE (Degree)	RAW VALUE (dBuV)	CORRECTION FACTOR (dB/m)
1	*5825.00	102.2 PK			1.25 V	308	61.80	40.40
2	*5825.00	92.7 AV			1.25 V	308	52.30	40.40
3	#5850.00	64.5 PK	82.2	-17.7	1.25 V	308	24.10	40.40
4	#5850.00	55.0 AV	72.7	-17.7	1.25 V	308	14.60	40.40
5	11650.00	58.3 PK	74.0	-15.7	1.14 V	258	9.80	48.50
6	11650.00	45.7 AV	54.0	-8.3	1.14 V	258	-2.80	48.50

REMARKS:

1. Emission level (dBuV/m) = Raw Value (dBuV) + Correction Factor (dB/m).
2. Correction Factor (dB/m) = Antenna Factor (dB/m) + Cable Factor (dB).
3. The other emission levels were very low against the limit.
4. Margin value = Emission level – Limit value.
5. “ * “: Fundamental frequency.
6. The limit value is defined as per 15.247.
7. “#”:The radiated frequency is out the restricted band.



A D T

802.11n (40MHz)

EUT TEST CONDITION		MEASUREMENT DETAIL	
CHANNEL	Channel 151	FREQUENCY RANGE	1 ~ 40GHz
INPUT POWER (SYSTEM)	120Vac, 60Hz	DETECTOR FUNCTION	Peak (PK) Average (AV)
ENVIRONMENTAL CONDITIONS	24deg. C, 68%RH	TESTED BY	Martin Lee

ANTENNA POLARITY & TEST DISTANCE: HORIZONTAL AT 3 M								
NO.	FREQ. (MHz)	EMISSION LEVEL (dBuV/m)	LIMIT (dBuV/m)	MARGIN (dB)	ANTENNA HEIGHT (m)	TABLE ANGLE (Degree)	RAW VALUE (dBuV)	CORRECTION FACTOR (dB/m)
1	#5725.00	62.4 PK	81.3	-18.9	1.36 H	112	22.10	40.30
2	#5725.00	52.4 AV	71.3	-18.9	1.36 H	112	12.10	40.30
3	*5755.00	101.3 PK			1.36 H	112	61.00	40.30
4	*5755.00	91.3 AV			1.36 H	112	51.00	40.30
5	11510.00	57.7 PK	74.0	-16.3	1.47 H	7	9.30	48.40
6	11510.00	44.7 AV	54.0	-9.3	1.47 H	7	-3.70	48.40

ANTENNA POLARITY & TEST DISTANCE: VERTICAL AT 3 M								
NO.	FREQ. (MHz)	EMISSION LEVEL (dBuV/m)	LIMIT (dBuV/m)	MARGIN (dB)	ANTENNA HEIGHT (m)	TABLE ANGLE (Degree)	RAW VALUE (dBuV)	CORRECTION FACTOR (dB/m)
1	#5725.00	58.3 PK	77.2	-18.9	1.13 V	247	18.00	40.30
2	#5725.00	48.9 AV	67.8	-18.9	1.13 V	247	8.60	40.30
3	*5755.00	97.2 PK			1.13 V	247	56.90	40.30
4	*5755.00	87.8 AV			1.13 V	247	47.50	40.30
5	11510.00	57.7 PK	74.0	-16.3	1.36 V	9	9.30	48.40
6	11510.00	43.6 AV	54.0	-10.4	1.36 V	9	-4.80	48.40

REMARKS:

1. Emission level (dBuV/m) = Raw Value (dBuV) + Correction Factor (dB/m).
2. Correction Factor (dB/m) = Antenna Factor (dB/m) + Cable Factor (dB).
3. The other emission levels were very low against the limit.
4. Margin value = Emission level – Limit value.
5. “ * “: Fundamental frequency.
6. The limit value is defined as per 15.247.
7. "#":The radiated frequency is out the restricted band.



A D T

EUT TEST CONDITION		MEASUREMENT DETAIL	
CHANNEL	Channel 159	FREQUENCY RANGE	1 ~ 40GHz
INPUT POWER (SYSTEM)	120Vac, 60Hz	DETECTOR FUNCTION	Peak (PK) Average (AV)
ENVIRONMENTAL CONDITIONS	24deg. C, 68%RH	TESTED BY	Martin Lee

ANTENNA POLARITY & TEST DISTANCE: HORIZONTAL AT 3 M								
NO.	FREQ. (MHz)	EMISSION LEVEL (dBuV/m)	LIMIT (dBuV/m)	MARGIN (dB)	ANTENNA HEIGHT (m)	TABLE ANGLE (Degree)	RAW VALUE (dBuV)	CORRECTION FACTOR (dB/m)
1	*5795.00	102.0 PK			1.61 H	115	61.60	40.40
2	*5795.00	91.5 AV			1.61 H	115	51.10	40.40
3	#5850.00	60.4 PK	82.0	-21.6	1.61 H	115	20.00	40.40
4	#5850.00	49.9 AV	71.5	-21.6	1.61 H	115	9.50	40.40
5	11590.00	58.1 PK	74.0	-15.9	1.32 H	55	9.70	48.40
6	11590.00	45.5 AV	54.0	-8.5	1.32 H	55	-2.90	48.40
ANTENNA POLARITY & TEST DISTANCE: VERTICAL AT 3 M								
NO.	FREQ. (MHz)	EMISSION LEVEL (dBuV/m)	LIMIT (dBuV/m)	MARGIN (dB)	ANTENNA HEIGHT (m)	TABLE ANGLE (Degree)	RAW VALUE (dBuV)	CORRECTION FACTOR (dB/m)
1	*5795.00	99.8 PK			1.49 V	275	59.40	40.40
2	*5795.00	90.6 AV			1.49 V	275	50.20	40.40
3	#5850.00	58.2 PK	79.8	-21.6	1.49 V	275	17.80	40.40
4	#5850.00	49.0 AV	70.6	-21.6	1.49 V	275	8.60	40.40
5	11590.00	57.8 PK	74.0	-16.2	1.58 V	52	9.40	48.40
6	11590.00	44.1 AV	54.0	-9.9	1.58 V	52	-4.30	48.40

REMARKS:

1. Emission level (dBuV/m) = Raw Value (dBuV) + Correction Factor (dB/m).
2. Correction Factor (dB/m) = Antenna Factor (dB/m) + Cable Factor (dB).
3. The other emission levels were very low against the limit.
4. Margin value = Emission level – Limit value.
5. “ * “: Fundamental frequency.
6. The limit value is defined as per 15.247.
7. "#":The radiated frequency is out the restricted band.



A D T

BELOW 1GHz WORST-CASE DATA : 802.11n (20MHz)

EUT TEST CONDITION		MEASUREMENT DETAIL	
CHANNEL	Channel 149	FREQUENCY RANGE	Below 1000MHz
INPUT POWER (SYSTEM)	120Vac, 60Hz	DETECTOR FUNCTION	Quasi-Peak
ENVIRONMENTAL CONDITIONS	23deg. C, 71%RH	TESTED BY	Martin Lee

ANTENNA POLARITY & TEST DISTANCE: HORIZONTAL AT 3 M								
NO.	FREQ. (MHz)	EMISSION LEVEL (dBuV/m)	LIMIT (dBuV/m)	MARGIN (dB)	ANTENNA HEIGHT (m)	TABLE ANGLE (Degree)	RAW VALUE (dBuV)	CORRECTION FACTOR (dB/m)
1	49.40	30.1 QP	40.0	-9.9	1.36 H	37	16.60	13.50
2	101.78	28.8 QP	43.5	-14.7	1.00 H	132	19.60	9.20
3	150.28	36.3 QP	43.5	-7.2	1.75 H	92	22.70	13.60
4	198.78	38.2 QP	43.5	-5.3	1.55 H	120	27.30	10.90
5	359.80	32.8 QP	46.0	-13.2	2.15 H	75	16.40	16.40
6	551.86	33.5 QP	46.0	-12.5	2.55 H	81	12.20	21.30

ANTENNA POLARITY & TEST DISTANCE: VERTICAL AT 3 M								
NO.	FREQ. (MHz)	EMISSION LEVEL (dBuV/m)	LIMIT (dBuV/m)	MARGIN (dB)	ANTENNA HEIGHT (m)	TABLE ANGLE (Degree)	RAW VALUE (dBuV)	CORRECTION FACTOR (dB/m)
1	49.40	36.2 QP	40.0	-3.8	1.55 V	308	22.70	13.50
2	115.36	29.8 QP	43.5	-13.7	1.00 V	108	19.00	10.80
3	198.78	30.7 QP	43.5	-12.8	2.00 V	276	19.80	10.90
4	340.40	28.1 QP	46.0	-17.9	1.36 V	188	12.20	15.90
5	852.56	33.2 QP	46.0	-12.8	1.47 V	359	7.40	25.80
6	949.56	35.8 QP	46.0	-10.2	1.69 V	315	8.80	27.00

REMARKS:

1. Emission level (dBuV/m) = Raw Value (dBuV) + Correction Factor (dB/m).
2. Correction Factor (dB/m) = Antenna Factor (dB/m) + Cable Factor (dB).
3. The other emission levels were very low against the limit.
4. Margin value = Emission level – Limit value.

5.2 CONDUCTED EMISSION MEASUREMENT

5.2.1 LIMITS OF CONDUCTED EMISSION MEASUREMENT

FREQUENCY OF EMISSION (MHz)	CONDUCTED LIMIT (dB μ V)	
	Quasi-peak	Average
0.15 ~ 0.5	66 to 56	56 to 46
0.5 ~ 5	56	46
5 ~ 30	60	50

- NOTE:** 1. The lower limit shall apply at the transition frequencies.
2. The limit decreases in line with the logarithm of the frequency in the range of 0.15 to 0.50MHz.
3. All emanations from a class A/B digital device or system, including any network of conductors and apparatus connected thereto, shall not exceed the level of field strengths specified above.

5.2.2 TEST INSTRUMENTS

Same as item 4.2.2.

5.2.3 TEST PROCEDURES

Same as item 4.2.3.

5.2.4 DEVIATION FROM TEST STANDARD

No deviation.

5.2.5 TEST SETUP

Same as item 4.2.5.

5.2.6 EUT OPERATING CONDITIONS

Same as item 4.1.6.

5.2.7 TEST RESULTS

CONDUCTED WORST-CASE DATA : 802.11n (20MHz)

PHASE	Line 1	6dB BANDWIDTH	9kHz
--------------	--------	----------------------	------

No	Freq. [MHz]	Corr. Factor (dB)	Reading Value		Emission Level		Limit		Margin	
			[dB (uV)]		[dB (uV)]		[dB (uV)]		(dB)	
			Q.P.	AV.	Q.P.	AV.	Q.P.	AV.	Q.P.	AV.
1	0.20597	0.12	46.12	35.31	46.24	35.43	63.37	53.37	-17.13	-17.94
2	0.31016	0.14	34.98	26.23	35.12	26.37	59.97	49.97	-24.85	-23.60
3	0.41563	0.15	25.07	19.88	25.22	20.03	57.54	47.54	-32.31	-27.50
4	0.62130	0.17	24.84	22.09	25.01	22.26	56.00	46.00	-30.99	-23.74
5	7.21094	0.51	26.94	20.05	27.45	20.56	60.00	50.00	-32.55	-29.44
6	10.77344	0.70	21.73	16.59	22.43	17.29	60.00	50.00	-37.57	-32.71

REMARKS:

1. Q.P. and AV. are abbreviations of quasi-peak and average individually.
2. The emission levels of other frequencies were very low against the limit.
3. Margin value = Emission level - Limit value
4. Correction factor = Insertion loss + Cable loss
5. Emission Level = Correction Factor + Reading Value.

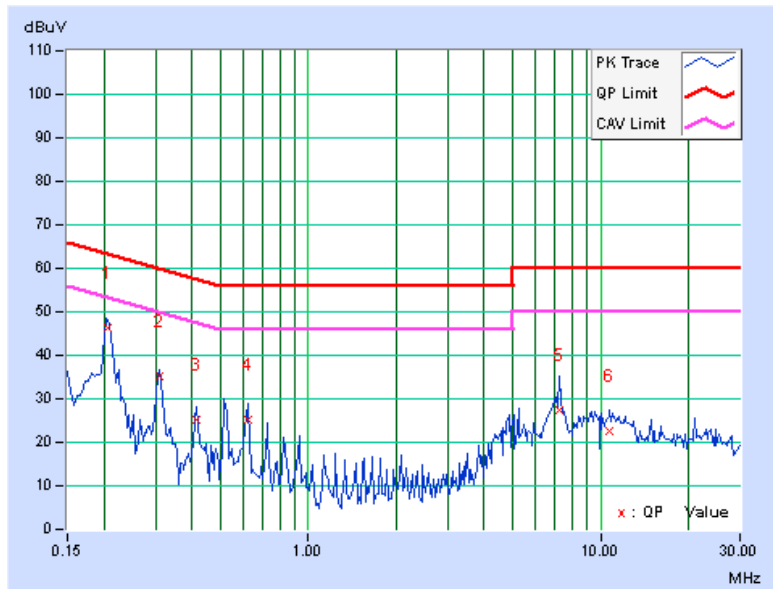

PHASE	Line 2	6dB BANDWIDTH	9kHz
-------	--------	---------------	------

No	Freq. [MHz]	Corr. Factor (dB)	Reading Value		Emission Level		Limit		Margin	
			[dB (uV)]		[dB (uV)]		[dB (uV)]		(dB)	
			Q.P.	AV.	Q.P.	AV.	Q.P.	AV.	Q.P.	AV.
1	0.20859	0.17	45.07	36.30	45.24	36.47	63.26	53.26	-18.02	-16.79
2	0.31016	0.19	34.25	26.63	34.44	26.82	59.97	49.97	-25.52	-23.14
3	0.51710	0.22	27.98	25.74	28.20	25.96	56.00	46.00	-27.80	-20.04
4	0.72794	0.23	23.84	21.97	24.07	22.20	56.00	46.00	-31.93	-23.80
5	7.64063	0.51	25.62	21.70	26.13	22.21	60.00	50.00	-33.87	-27.79
6	9.78516	0.58	21.92	15.99	22.50	16.57	60.00	50.00	-37.50	-33.43

REMARKS:

1. Q.P. and AV. are abbreviations of quasi-peak and average individually.
2. The emission levels of other frequencies were very low against the limit.
3. Margin value = Emission level - Limit value
4. Correction factor = Insertion loss + Cable loss
5. Emission Level = Correction Factor + Reading Value.

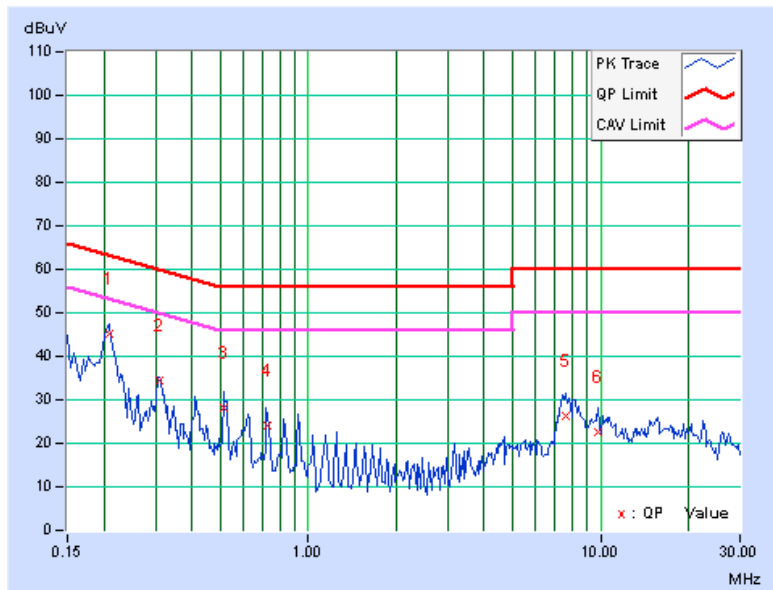



A D T

5.3 6dB BANDWIDTH MEASUREMENT

5.3.1 LIMITS OF 6dB BANDWIDTH MEASUREMENT

The minimum of 6dB Bandwidth Measurement is 0.5MHz.

5.3.2 TEST SETUP

Same as item 4.3.2.

5.3.3 TEST INSTRUMENTS

Refer to section 4.1.2 to get information of above instrument.

5.3.4 TEST PROCEDURE

Same as item 4.3.4.

5.3.5 DEVIATION FROM TEST STANDARD

No deviation.

5.3.6 EUT OPERATING CONDITIONS

Same as item 4.3.6.



5.3.7 TEST RESULTS

802.11a

CHANNEL	FREQUENCY (MHz)	6dB BANDWIDTH (MHz)	MINIMUM LIMIT (MHz)	PASS / FAIL
149	5745	15.53	0.5	PASS
157	5785	15.34	0.5	PASS
165	5825	15.41	0.5	PASS

802.11n (20MHz)

CHANNEL	FREQUENCY (MHz)	6dB BANDWIDTH (MHz)		MINIMUM LIMIT (MHz)	PASS / FAIL
		CHAIN 0	CHAIN 1		
149	5745	15.20	16.01	0.5	PASS
157	5785	15.16	16.31	0.5	PASS
165	5825	15.21	16.32	0.5	PASS

802.11n (40MHz)

CHANNEL	FREQUENCY (MHz)	6dB BANDWIDTH (MHz)		MINIMUM LIMIT (MHz)	PASS / FAIL
		CHAIN 0	CHAIN 1		
151	5755	36.10	36.43	0.5	PASS
159	5795	35.87	36.45	0.5	PASS



A D T

5.4 CONDUCTED OUTPUT POWER

5.4.1 LIMITS OF CONDUCTED OUTPUT POWER MEASUREMENT

For systems using digital modulation in the 5725 –5850 MHz bands: 1 Watt (30dBm)

Per KDB 662911 D01 Multiple Transmitter Output v01r02 Method of conducted output power measurement on IEEE 802.11 devices,

Array Gain = 0 dB (i.e., no array gain) for $NANT \leq 4$;

Array Gain = 0 dB (i.e., no array gain) for channel widths ≥ 40 MHz for any NANT;

Array Gain = $5 \log(NANT/NSS)$ dB or 3 dB, whichever is less for 20-MHz channel widths with $NANT \geq 5$.

For power measurements on all other devices: Array Gain = $10 \log(NANT/NSS)$ dB.

5.4.2 TEST SETUP

Same as Item 4.4.2.

5.4.3 INSTRUMENTS

Refer to section 4.1.2 to get information of above instrument.

5.4.4 TEST PROCEDURES

Same as Item 4.4.4.

5.4.5 DEVIATION FROM TEST STANDARD

No deviation.

5.4.6 EUT OPERATING CONDITIONS

Same as Item 4.3.6.



5.4.7 TEST RESULTS

FOR PEAK POWER

802.11a

CHANNEL	FREQUENCY (MHz)	PEAK POWER (mW)	PEAK POWER (dBm)	LIMIT (dBm)	PASS/FAIL
149	5745	184.077	22.65	30	PASS
157	5785	187.068	22.72	30	PASS
165	5825	207.970	23.18	30	PASS

802.11n (20MHz)

CHAN.	CHAN. FREQ. (MHz)	PEAK POWER (dBm)		TOTAL POWER (mW)	TOTAL POWER (dBm)	LIMIT (dBm)	PASS / FAIL
		CHAIN 0	CHAIN 1				
149	5745	22.81	22.95	388.227	25.89	30	PASS
157	5785	22.77	22.34	360.630	25.57	30	PASS
165	5825	22.13	22.20	329.264	25.18	30	PASS

802.11n (40MHz)

CHAN.	CHAN. FREQ. (MHz)	PEAK POWER (dBm)		TOTAL POWER (mW)	TOTAL POWER (dBm)	LIMIT (dBm)	PASS / FAIL
		CHAIN 0	CHAIN 1				
151	5755	22.25	22.29	337.314	25.28	30	PASS
159	5795	22.30	22.20	335.783	25.26	30	PASS



A D T

FOR AVERAGE POWER

802.11a

CHANNEL	FREQUENCY (MHz)	AVERAGE POWER (mW)	AVERAGE POWER (dBm)
149	5745	29.923	14.76
157	5785	31.842	15.03
165	5825	33.420	15.24

802.11n (20MHz)

CHANNEL	FREQUENCY (MHz)	AVG. POWER (dBm)		TOTAL POWER (mW)	TOTAL POWER (dBm)
		CHAIN 0	CHAIN 1		
149	5745	15.75	15.22	70.850	18.50
157	5785	15.35	15.17	67.162	18.27
165	5825	15.57	15.04	67.973	18.32

802.11n (40MHz)

CHANNEL	FREQUENCY (MHz)	AVG. POWER (dBm)		TOTAL POWER (mW)	TOTAL POWER (dBm)
		CHAIN 0	CHAIN 1		
151	5755	14.88	14.98	62.238	17.94
159	5795	14.92	14.85	61.595	17.90



A D T

5.5 POWER SPECTRAL DENSITY MEASUREMENT

5.5.1 LIMITS OF POWER SPECTRAL DENSITY MEASUREMENT

The Maximum of Power Spectral Density Measurement is 8dBm.

5.5.2 TEST SETUP

Same as item 4.5.2.

5.5.3 TEST INSTRUMENTS

Refer to section 4.1.2 to get information of above instrument.

5.5.4 TEST PROCEDURE.

Same as item 4.5.4.

5.5.5 DEVIATION FROM TEST STANDARD

No deviation.

5.5.6 EUT OPERATING CONDITION

Same as item 4.3.6.



5.5.7 TEST RESULTS

802.11a

Channel	Freq. (MHz)	PSD (dBm/3kHz)	Limit (dBm/3kHz)	PASS /FAIL
149	5745	-14.02	8	PASS
157	5785	-12.93	8	PASS
165	5825	-13.86	8	PASS

802.11n (20MHz)

TX chain	Channel	Freq. (MHz)	PSD (dBm/3kHz)	10 log (N=2) dB	Total PSD (dBm/3kHz)	Limit (dBm/3kHz)	PASS /FAIL
0	149	5745	-13.69	3.01	-10.68	7.61	PASS
	157	5785	-13.63	3.01	-10.62	7.61	PASS
	165	5825	-12.52	3.01	-9.51	7.61	PASS
1	149	5745	-14.33	3.01	-11.32	7.61	PASS
	157	5785	-13.52	3.01	-10.51	7.61	PASS
	165	5825	-13.75	3.01	-10.74	7.61	PASS

NOTE: Directional gain = $10 \log[(10^{G1/20} + 10^{G2/20} + \dots + 10^{GN/20})^2 / N_{ANT}] = 6.39\text{dBi} > 6\text{dBi}$, so the power density limit shall be reduced to $8 - (6.39 - 6) = 7.61\text{dBm}$.

802.11n (40MHz)

TX chain	Channel	Freq. (MHz)	PSD (dBm/3kHz)	10 log (N=2) dB	Total PSD (dBm/3kHz)	Limit (dBm/3kHz)	PASS /FAIL
0	151	5755	-16.35	3.01	-13.34	7.61	PASS
	159	5795	-16.21	3.01	-13.20	7.61	PASS
1	151	5755	-15.77	3.01	-12.76	7.61	PASS
	159	5795	-17.15	3.01	-14.14	7.61	PASS

NOTE: Directional gain = $10 \log[(10^{G1/20} + 10^{G2/20} + \dots + 10^{GN/20})^2 / N_{ANT}] = 6.39\text{dBi} > 6\text{dBi}$, so the power density limit shall be reduced to $8 - (6.39 - 6) = 7.61\text{dBm}$.



A D T

5.6 CONDUCTED OUT OF BAND EMISSION MEASUREMENT

5.6.1 LIMITS OF CONDUCTED OUT OF BAND EMISSION MEASUREMENT

Below -20dB of the highest emission level of operating band (in 100kHz Resolution Bandwidth).

5.6.2 TEST SETUP

Same as Item 4.6.2

5.6.3 TEST INSTRUMENTS

Refer to section 4.1.2 to get information of above instrument.

5.6.4 TEST PROCEDURE

Same as Item 4.6.4

5.6.5 DEVIATION FROM TEST STANDARD

No deviation.

5.6.6 EUT OPERATING CONDITION

Same as Item 4.3.6

5.6.7 TEST RESULTS

The conducted emission test is performed on each TX port of operating mode without summing or adding $10\log(N)$ since the limit is relative emission limit.

The spectrum plots are attached on the following pages. D1 line indicates the highest level, and D2 line indicates the 20dB offset below D1. It shows compliance with the requirement.

802.11a

CH 149

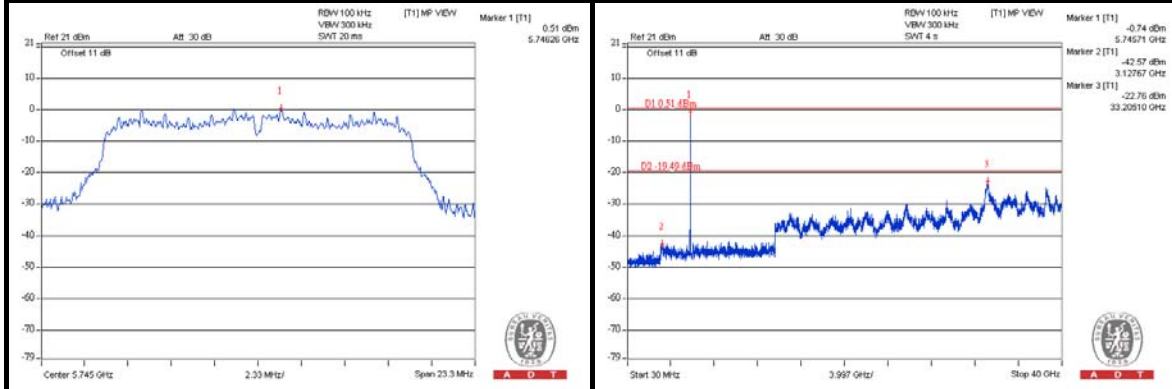

CH 157

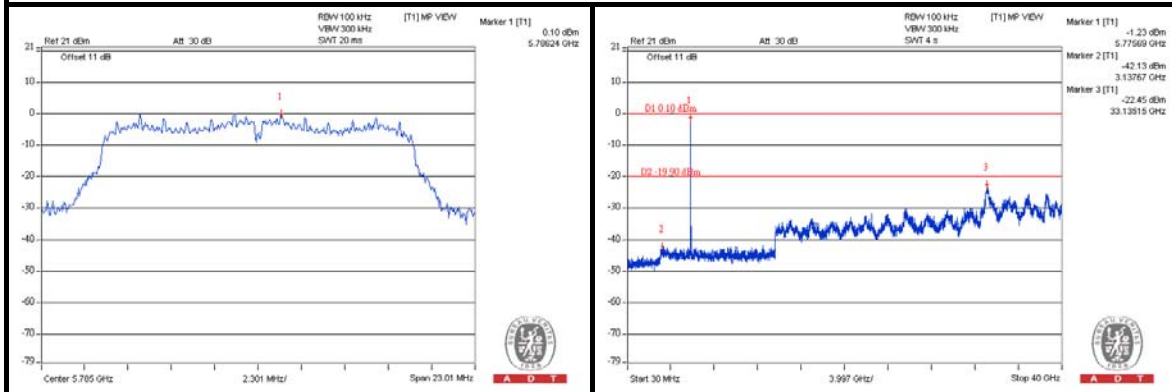

CH 165

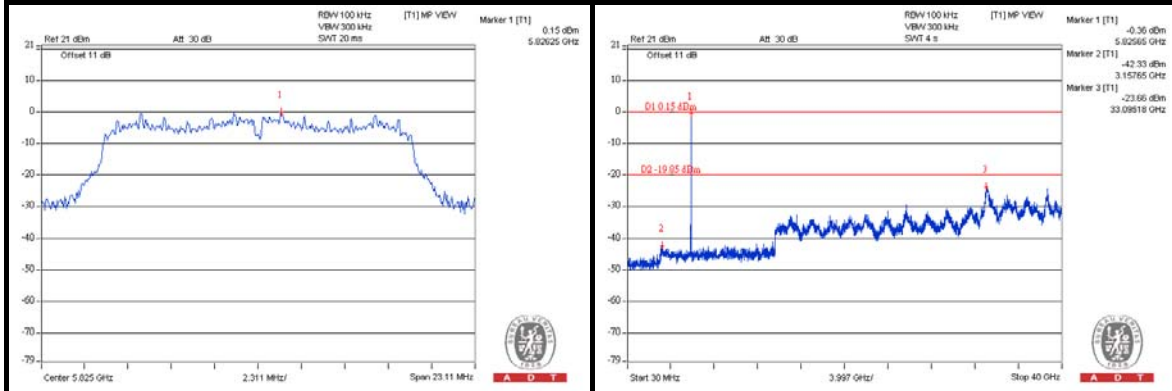



A D T

802.11n (20MHz) CHAIN 0

CH 149

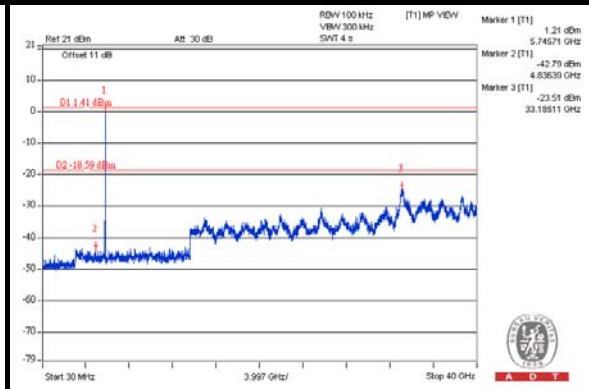
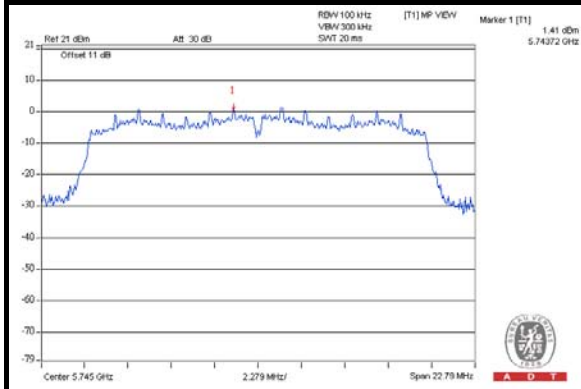

CH 157

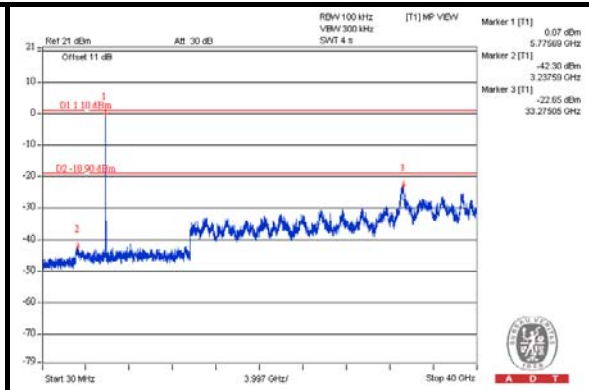
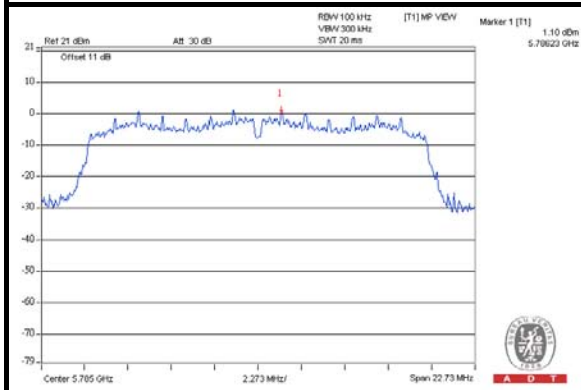

CH 165

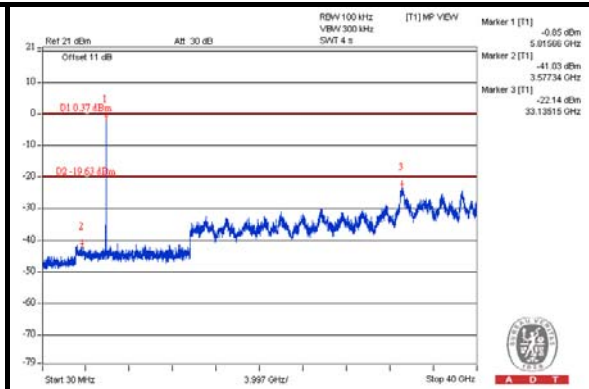
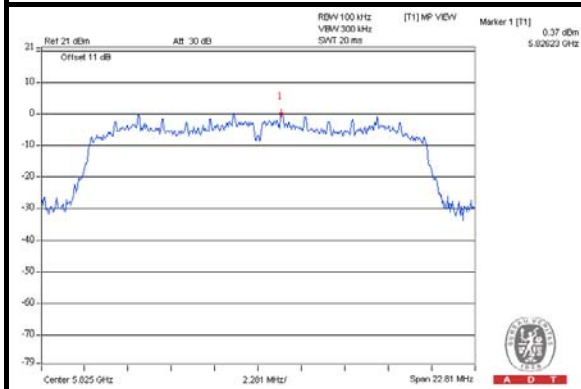

CHAIN 1

CH 149

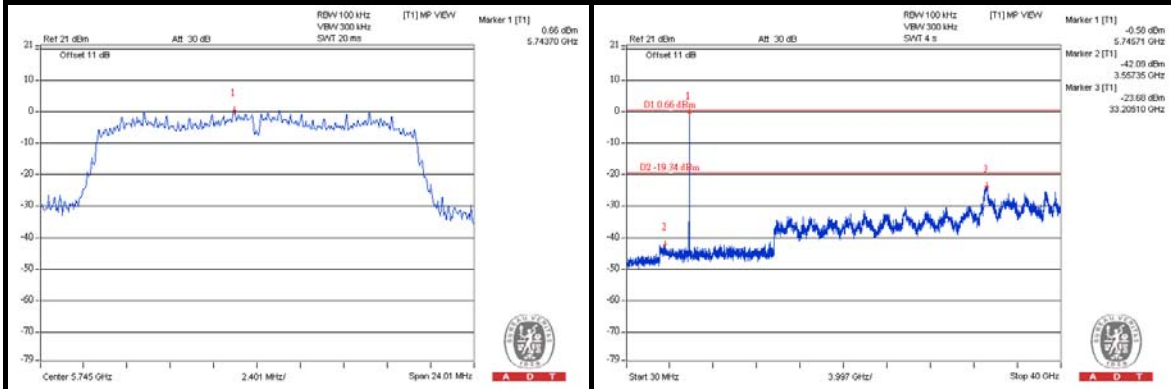

CH 157

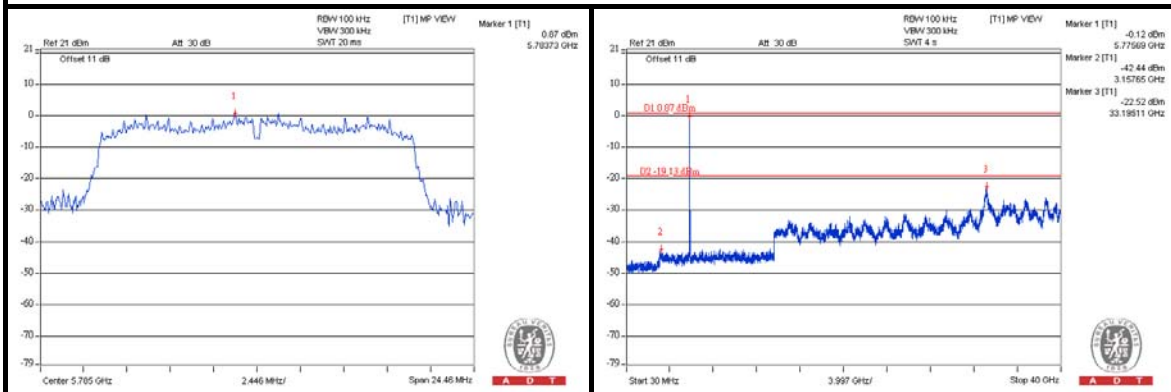

CH 165

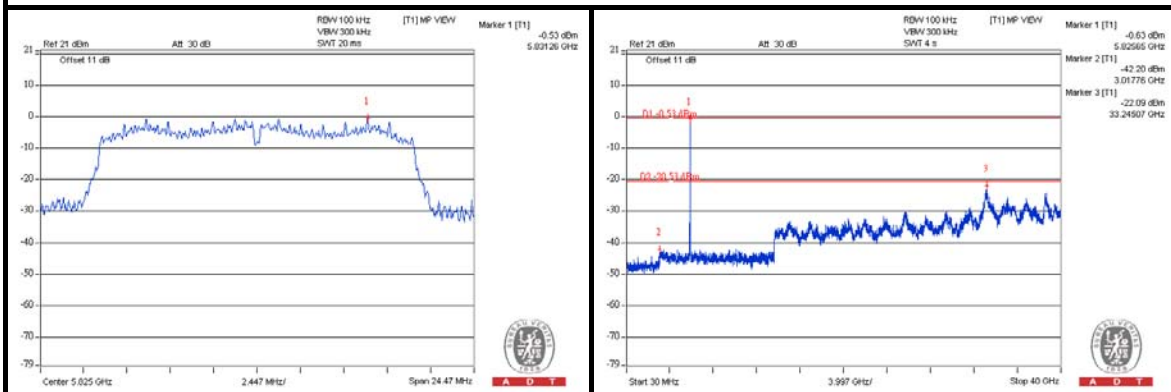



A D T

802.11n (40MHz) CHAIN 0

CH 151

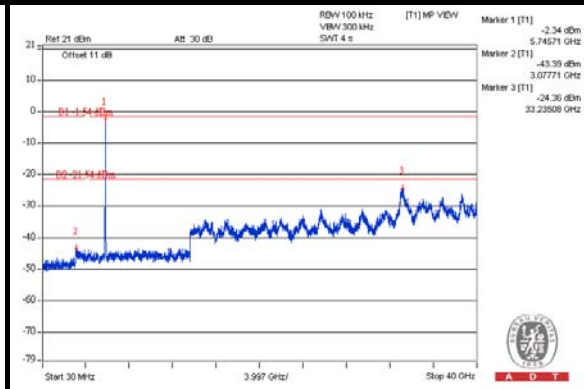
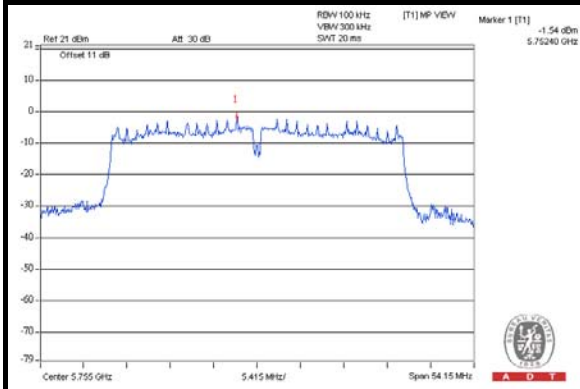

CH 159

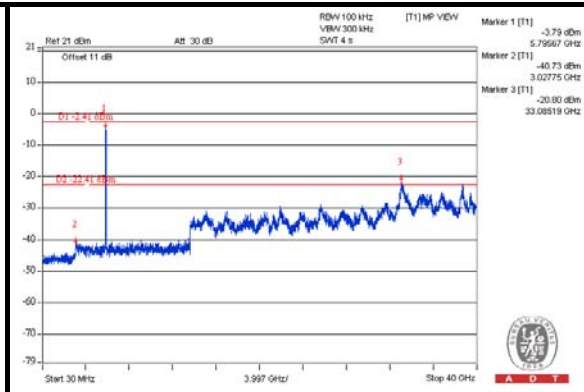
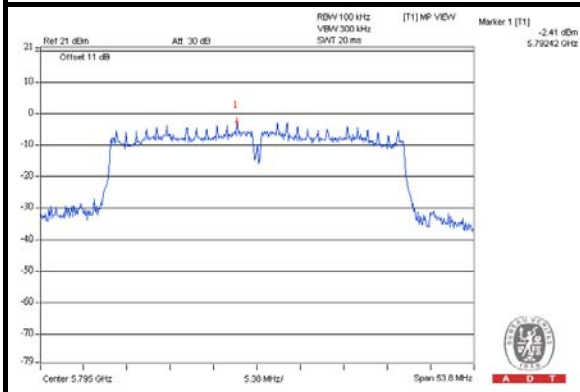



A D T

CHAIN 1

CH 151

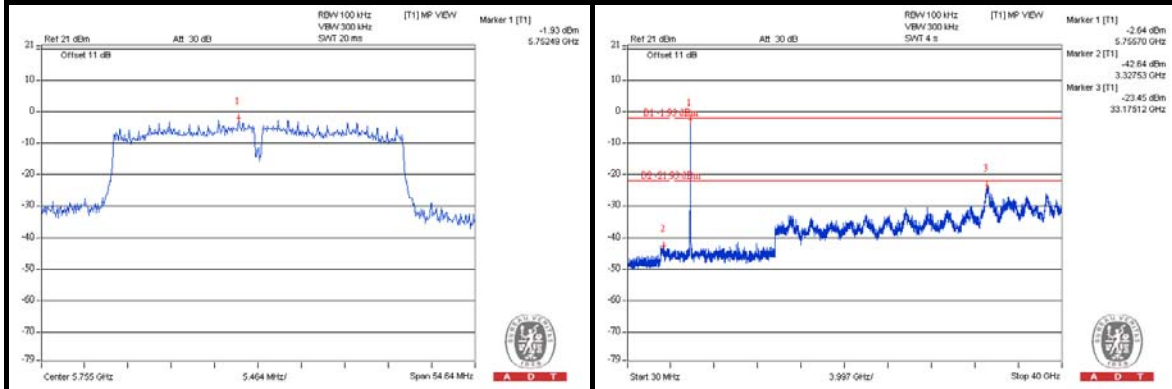

CH 159

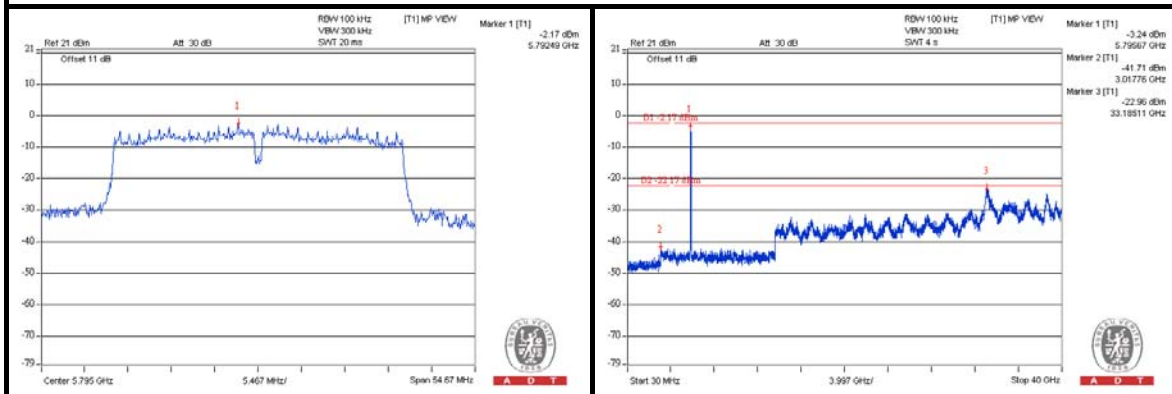



A D T

6. PHOTOGRAPHS OF THE TEST CONFIGURATION

Please refer to the attached file (Test Setup Photo).



A D T

7. INFORMATION ON THE TESTING LABORATORIES

We, Bureau Veritas Consumer Products Services (H.K.) Ltd., Taoyuan Branch, were founded in 1988 to provide our best service in EMC, Radio, Telecom and Safety consultation. Our laboratories are accredited and approved according to ISO/IEC 17025.

If you have any comments, please feel free to contact us at the following:

Linko EMC/RF Lab

Tel: 886-2-26052180

Fax: 886-2-26051924

Hsin Chu EMC/RF Lab

Tel: 886-3-5935343

Fax: 886-3-5935342

Hwa Ya EMC/RF/Safety/Telecom Lab

Tel: 886-3-3183232

Fax: 886-3-3270892

Email: service.adt@tw.bureauveritas.com

Web Site: www.bureauveritas-adt.com

The address and road map of all our labs can be found in our web site also.



A D T

8. APPENDIX A – MODIFICATIONS RECORDERS FOR ENGINEERING CHANGES TO THE EUT BY THE LAB

No modifications were made to the EUT by the lab during the test.

---END---