



FCC RF Test Report

APPLICANT : Askey Computer Corporation
EQUIPMENT : Android Player Card
BRAND NAME : ASUS
MODEL NAME : CA001
FCC ID : H8N-WHD0200
STANDARD : FCC Part 15 Subpart C §15.247
CLASSIFICATION : (DTS) Digital Transmission System

The product was received on May 05, 2016 and testing was completed on Jun. 21, 2016. We, SPORTON INTERNATIONAL (KUNSHAN) INC., would like to declare that the tested sample has been evaluated in accordance with the test procedures and has been in compliance with the applicable technical standards.

The test results in this report apply exclusively to the tested model / sample. Without written approval of SPORTON INTERNATIONAL (KUNSHAN) INC., the test report shall not be reproduced except in full.

Prepared by: James Huang / Manager

Approved by: Jones Tsai / Manager



SPORTON INTERNATIONAL (KUNSHAN) INC.
No. 3-2, PingXiang Road, Kunshan, Jiangsu Province, P. R. China



TABLE OF CONTENTS

1 GENERAL DESCRIPTION 5

1.1 Applicant 5

1.2 Manufacturer 5

1.3 Product Feature of Equipment Under Test 5

1.4 Product Specification of Equipment Under Test 5

1.5 Modification of EUT 6

1.6 Testing Location 6

1.7 Applicable Standards 6

2 TEST CONFIGURATION OF EQUIPMENT UNDER TEST 7

2.1 Carrier Frequency Channel 7

2.2 Pre-Scanned RF Power 8

2.3 Test Mode 9

2.4 Connection Diagram of Test System 10

2.5 Support Unit used in test configuration and system 11

2.6 EUT Operation Test Setup 11

2.7 Measurement Results Explanation Example 12

3 TEST RESULT 13

3.1 6dB and 99% Bandwidth Measurement 13

3.2 Output Power Measurement 15

3.3 Power Spectral Density Measurement 16

3.4 Conducted Band Edges and Spurious Emission Measurement 18

3.5 Radiated Band Edges and Spurious Emission Measurement 31

3.6 AC Conducted Emission Measurement 35

3.7 Antenna Requirements 39

4 LIST OF MEASURING EQUIPMENT 40

5 UNCERTAINTY OF EVALUATION 41

APPENDIX A. CONDUCTED TEST RESULTS

APPENDIX B. RADIATED TEST RESULTS

APPENDIX C. DUTY CYCLE PLOTS

APPENDIX D. SETUP PHOTOGRAPHS



SUMMARY OF TEST RESULT

Report Section	FCC Rule	IC Rule	Description	Limit	Result	Remark
3.1	15.247(a)(2)	RSS-247 5.2(1)	6dB Bandwidth	$\geq 0.5\text{MHz}$	Pass	-
3.1	-	RSS-Gen 6.6	99% Bandwidth	-	Pass	-
3.2	15.247(b)	RSS-247 A5.4(4)	Power Output Measurement	$\leq 30\text{dBm}$	Pass	-
3.3	15.247(e)	RSS-247 5.2(2)	Power Spectral Density	$\leq 8\text{dBm}/3\text{kHz}$	Pass	-
3.4	15.247(d)	RSS-247 5.5	Conducted Band Edges	$\leq 20\text{dBc}$	Pass	-
			Conducted Spurious Emission		Pass	-
3.5	15.247(d)	RSS-247 5.5	Radiated Band Edges and Radiated Spurious Emission	15.209(a) & 15.247(d)	Pass	Under limit 4.96 dB at 37.760 MHz
3.6	15.207	RSS-GEN 8.8	AC Conducted Emission	15.207(a)	Pass	Under limit 16.99 dB at 0.170 MHz
3.7	15.203 & 15.247(b)	N/A	Antenna Requirement	N/A	Pass	-



1 General Description

1.1 Applicant

Askey Computer Corporation

10F, NO.119, JIANKANG RD., ZHONGHE DIST., NEW TAIPEI CITY, TAIWAN, R.O.C.

1.2 Manufacturer

Askey Computer Corporation

10F, NO.119, JIANKANG RD., ZHONGHE DIST., NEW TAIPEI CITY, TAIWAN, R.O.C.

1.3 Product Feature of Equipment Under Test

Product Feature	
Equipment	Android Player Card
Brand Name	ASUS
Model Name	CA001
FCC ID	H8N-WHD0200
EUT supports Radios application	WLAN2.4GHz 802.11b/g/n HT20/HT40 Bluetooth v2.1+EDR Bluetooth v3.0+EDR Bluetooth v4.0 LE
HW Version	REV:4
SW Version	3188-BSP-AS-1-6-B-2016-06-17-1
EUT Stage	Identical Prototype

Remark: The above EUT's information was declared by manufacturer. Please refer to the specifications or user's manual for more detailed description.

1.4 Product Specification of Equipment Under Test

Standards-related Product Specification	
Tx/Rx Channel Frequency Range	802.11b/g/n : 2412 MHz ~ 2462 MHz
Maximum (Peak) Output Power to Antenna	802.11b : 13.94 dBm (0.0248 W) 802.11g : 21.11 dBm (0.1291 W) 802.11n HT20 : 20.73 dBm (0.1183 W) 802.11n HT40 : 20.08 dBm (0.1019 W)
99% Occupied Bandwidth	802.11b : 15.33MHz 802.11g : 18.93MHz 802.11n HT20 : 19.78MHz 802.11n HT40 : 36.76MHz
Antenna Type/Gain	Antenna A:External Antenna with gain 5.00 dBi Antenna B:External Antenna with gain 4.61 dBi
Type of Modulation	802.11b : DSSS (DBPSK / DQPSK / CCK) 802.11g/n : OFDM (BPSK / QPSK / 16QAM / 64QAM)



1.5 Modification of EUT

No modifications are made to the EUT during all test items.

1.6 Testing Location

Test Site	SPORTON INTERNATIONAL (KUNSHAN) INC.			
Test Site Location	No. 3-2, PingXiang Road, Kunshan, Jiangsu Province, P. R. China TEL: +86-0512-5790-0158 FAX: +86-0512-5790-0958			
Test Site No.	Sporton Site No.			FCC/IC Registration No.
	TH01-KS	CO01-KS	03CH03-KS	306251/4086E

Note: The test site complies with ANSI C63.4 2014 requirement.

1.7 Applicable Standards

According to the specifications of the manufacturer, the EUT must comply with the requirements of the following standards:

- FCC Part 15 Subpart C §15.247
- FCC KDB Publication No. 558074 D01 DTS Meas. Guidance v03r05
- ANSI C63.10-2013

Remark:

1. All test items were verified and recorded according to the standards and without any deviation during the test.
2. This EUT has also been tested and complied with the requirements of FCC Part 15, Subpart B, recorded in a separate test report.



2 Test Configuration of Equipment Under Test

The EUT has been associated with peripherals and configuration operated in a manner tended to maximize its emission characteristics in a typical application. Frequency range investigated: conducted emission (150 kHz to 30 MHz) and radiated emission (9 kHz to the 10th harmonic of the highest fundamental frequency or to 40 GHz, whichever is lower). For radiated measurement, pre-scanned in three orthogonal panels, X, Y, Z. The worst cases (X plane) were recorded in this report.

The final configuration from all the combinations and the worst-case data rates were investigated by measuring the maximum power across all the data rates and modulation modes under section 2.2.

Based on the worst configuration found above, the RF power setting is set individually to meet FCC compliance limit for the final conducted and radiated tests shown in section 2.3.

2.1 Carrier Frequency Channel

Frequency Band	Channel	Freq. (MHz)	Channel	Freq. (MHz)
2400-2483.5 MHz	1	2412	7	2442
	2	2417	8	2447
	3	2422	9	2452
	4	2427	10	2457
	5	2432	11	2462
	6	2437	-	-



2.2 Pre-Scanned RF Power

Preliminary tests were performed in different data rate and data rate associated with the highest power were chosen for full test shown in the following tables.

2.4GHz 802.11b RF Output Power (dBm)						
Power vs. Channel			Power vs. Data Rate			
Channel	Frequency (MHz)	Data Rate	Channel	2Mbps	5.5Mbps	11Mbps
		1Mbps				
CH 01	2412	13.94	CH 01	13.88	13.87	13.86
CH 06	2437	13.93				
CH 11	2462	12.31				

2.4GHz 802.11g RF Output Power (dBm)										
Power vs. Channel			Power vs. Data Rate							
Channel	Frequency (MHz)	Data Rate	Channel	9Mbps	12Mbps	18Mbps	24Mbps	36Mbps	48Mbps	54Mbps
		6Mbps								
CH 01	2412	21.11	CH 01	20.70	21.00	20.09	21.07	21.01	20.66	21.10
CH 06	2437	20.67								
CH 11	2462	19.47								

2.4GHz 802.11n HT20 RF Output Power (dBm)										
Power vs. Channel			Power vs. MCS Index							
Channel	Frequency (MHz)	MCS Index	Channel	MCS1	MCS2	MCS3	MCS4	MCS5	MCS6	MCS7
		MCS0								
CH 01	2412	20.73	CH 01	20.70	20.58	20.50	20.57	20.41	20.45	20.72
CH 06	2437	20.14								
CH 11	2462	18.95								

2.4GHz 802.11n HT40 RF Output Power (dBm)										
Power vs. Channel			Power vs. MCS Index							
Channel	Frequency (MHz)	MCS Index	Channel	MCS1	MCS2	MCS3	MCS4	MCS5	MCS6	MCS7
		MCS0								
CH 03	2422	20.08	CH 03	19.90	20.00	20.03	19.82	19.93	19.98	19.91
CH 06	2437	19.73								
CH 09	2452	18.91								



2.3 Test Mode

Final test mode of conducted test items and radiated spurious emissions are considering the modulation and worse data rates from the power table described in section 2.2.

<2.4GHz>

Modulation	Data Rate
802.11b	1 Mbps
802.11g	6 Mbps
802.11n HT20	MCS0
802.11n HT40	MCS0

Test Cases	
AC Conducted Emission	Mode 1 : Bluetooth Link + WLAN Link + LAN load (RJ-45) + SD Card Play Color Bar + Adapter with Test Jig + USB 1 With U disk + USB 2 With U disk + Earphone + VGA With Monitor
Remark: 1. For Radiated TCs, The tests were performance with test Jig with Adapter, Earphone and Antenna A. 2. EUT with Antenna B only verified the worst mode of EUT with Antenna A.	

2.4 Connection Diagram of Test System

<WLAN Tx Mode>

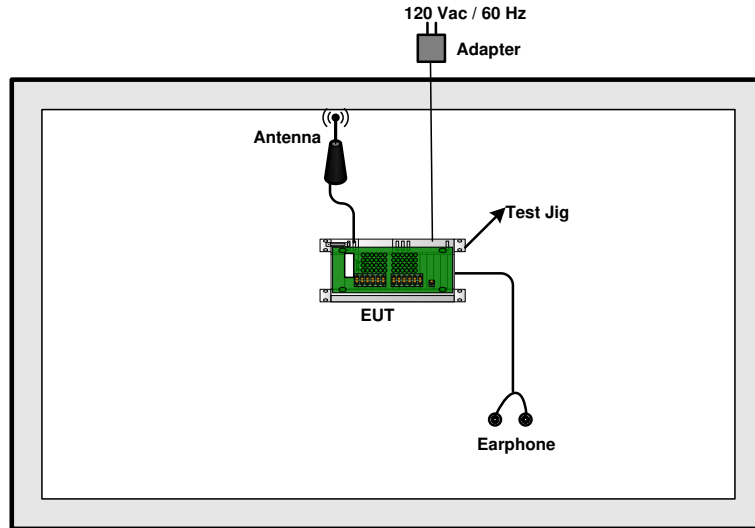

<AC Conducted Emission Mode>

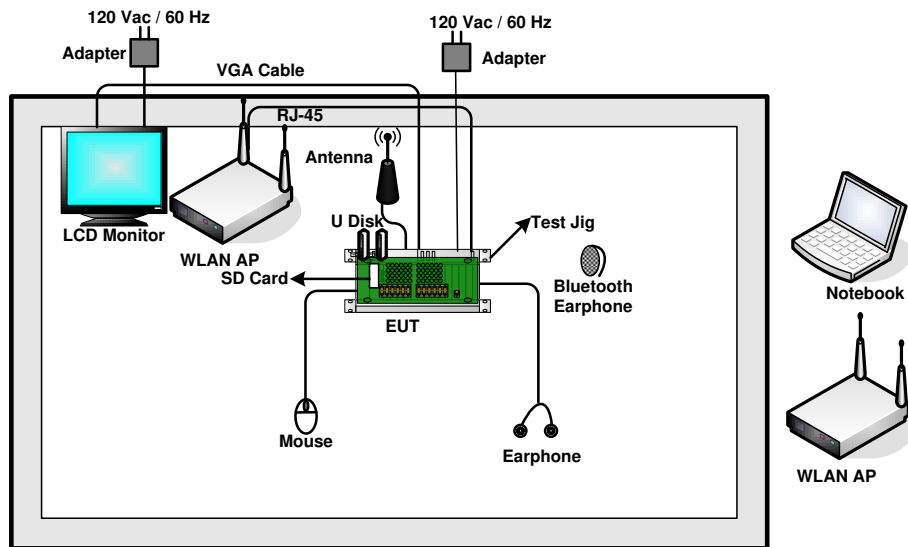



2.5 Support Unit used in test configuration and system

Item	Equipment	Trade Name	Model Name	FCC ID	Data Cable	Power Cord
1.	WLAN AP	D-Link	DIR-855	KA2DIR855A2	N/A	Unshielded,1.8m
2.	Notebook	Lenovo	G480	FCC Doc	N/A	AC I/P: Unshielded, 1.8 m DC O/P: Shielded, 1.8 m
3.	Earphone	Lenovo	SH100	N/A	N/A	N/A
4.	LCD monitor	Dell	IN1930MWc	FCC DoC	Shielded, 1.2m	Unshielded,1.8m
5.	(USB)Mouse	Dell	MS111-P	FCC DoC	Shielded, 1.8m	N/A
6.	Bluetooth Earphone	Nokia	BH-106	QTLBH-106	N/A	Unshielded, 0.53m
7.	Bluetooth Earphone	Nokia	BH-102	PYAHS-107W	N/A	N/A
8.	Test Jig	ASKEY	WHD0200-D6 1/B	N/A	N/A	N/A
9.	VGA Cable	N/A	N/A	N/A	N/A	N/A
10.	RJ-45 Cable	N/A	N/A	N/A	N/A	N/A
11.	Adapter	Ktec	KSAS0121200 100VU	N/A	N/A	Unshielded, 1.6 m
12.	U Disk 4GB	SanDisk	SDCZ50-004G	N/A	N/A	N/A
13.	U Disk 16GB	Kingston	DTSE9 G2	N/A	N/A	N/A
14.	SD Card	Kingston	4GB	N/A	N/A	N/A

2.6 EUT Operation Test Setup

For WLAN function, the engineering test program was provided and enabled to make EUT continuous transmit/receive.

For AC power line conducted emissions, the EUT was set to connect with the WLAN AP under large package sizes transmission.



2.7 Measurement Results Explanation Example

For all conducted test items:

The offset level is set in the spectrum analyzer to compensate the RF cable loss between EUT conducted output port and spectrum analyzer. With the offset compensation, the spectrum analyzer reading level is exactly the EUT RF output level.

Example:

The spectrum analyzer offset is derived from RF cable loss.

Offset = RF cable loss.

Following shows an offset computation example with cable loss 4.5 dB.

$$\begin{aligned} \text{Offset(dB)} &= \text{RF cable loss(dB)}. \\ &= 4.5 \text{ (dB)} \end{aligned}$$

3 Test Result

3.1 6dB and 99% Bandwidth Measurement

3.1.1 Limit of 6dB and 99% Bandwidth

The minimum 6 dB bandwidth shall be at least 500 kHz.

3.1.2 Measuring Instruments

The measuring equipment is listed in the section 4 of this test report.

3.1.3 Test Procedures

1. The testing follows FCC KDB Publication No. 558074 DTS D01 Meas. Guidance v03r05.
2. The RF output of EUT was connected to the spectrum analyzer by RF cable and attenuator. The path loss was compensated to the results for each measurement.
3. Set to the maximum power setting and enable the EUT transmit continuously.
4. Make the measurement with the spectrum analyzer's resolution bandwidth (RBW) = 100 kHz. Set the Video bandwidth (VBW) = 300 kHz. In order to make an accurate measurement. The 6 dB bandwidth must be greater than 500 kHz.
5. For 99% Bandwidth Measurement, the spectrum analyzer's resolution bandwidth (RBW) = 1MHz and set the Video bandwidth (VBW) = 3MHz.
6. Measure and record the results in the test report.

3.1.4 Test Setup

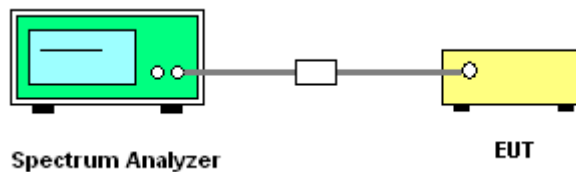



3.1.5 Test Result of 6dB and 99% Occupied Bandwidth

Please refer to Appendix A of this test report.

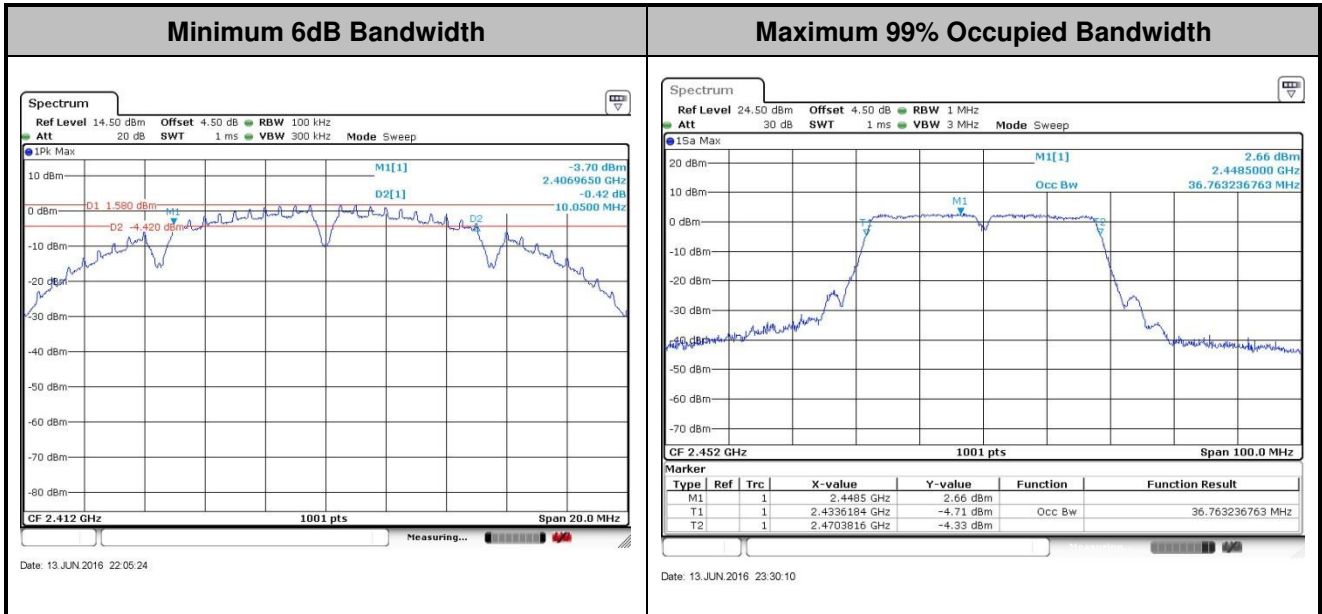

Note : The occupied channel bandwidth is maintained within the band of operation for all of the modulations.

3.2 Output Power Measurement

3.2.1 Limit of Output Power

For systems using digital modulation in the 2400-2483.5MHz, the limit for peak output power is 30dBm. If transmitting Antenna of directional gain greater than 6dBi are used the peak output power from the intentional radiator shall be reduced below the above stated value by the amount in dB that the directional gain of the Antenna exceeds 6 dBi. In case of point-to-point operation, the limit has to be reduced by 1dB for every 3dB that the directional gain of the Antenna exceeds 6dBi.

3.2.2 Measuring Instruments

The measuring equipment is listed in the section 4 of this test report.

3.2.3 Test Procedures

1. The testing follows the Measurement Procedure of FCC KDB No. 558074 DTS D01 Meas. Guidance v03r05 section 9.1.2 PKPM1 Peak power meter method.
2. The RF output of EUT was connected to the power meter by RF cable and attenuator. The path loss was compensated to the results for each measurement.
3. Set to the maximum power setting and enable the EUT transmit continuously.
4. Measure the conducted output power and record the results in the test report.

3.2.4 Test Setup

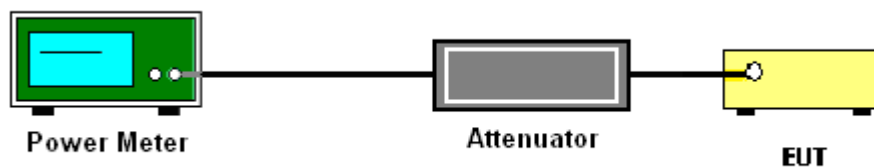

3.2.5 Test Result of Peak Output Power

Please refer to Appendix A of this test report.

3.2.6 Test Result of Average output Power (Reporting Only)

Please refer to Appendix A of this test report.

3.3 Power Spectral Density Measurement

3.3.1 Limit of Power Spectral Density

The peak power spectral density shall not be greater than 8dBm in any 3kHz band at any time interval of continuous transmission.

3.3.2 Measuring Instruments

The measuring equipment is listed in the section 4 of this test report.

3.3.3 Test Procedures

1. The testing follows Measurement Procedure 10.2 Method PKPSD of FCC KDB Publication No. 558074 D01 DTS Meas. Guidance v03r05
2. The RF output of EUT was connected to the spectrum analyzer by RF cable and attenuator. The path loss was compensated to the results for each measurement.
3. Set to the maximum power setting and enable the EUT transmit continuously.
4. Make the measurement with the spectrum analyzer's resolution bandwidth (RBW) = 3 kHz. Video bandwidth VBW = 10 kHz In order to make an accurate measurement, set the span to 1.5 times DTS Channel Bandwidth. (6dB BW)
5. Detector = peak, Sweep time = auto couple, Trace mode = max hold, Allow trace to fully stabilize. Use the peak marker function to determine the maximum power level.
6. Measure and record the results in the test report.

3.3.4 Test Setup

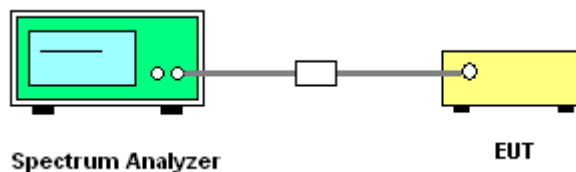



3.3.5 Test Result of Power Spectral Density

Please refer to Appendix A of this test report.

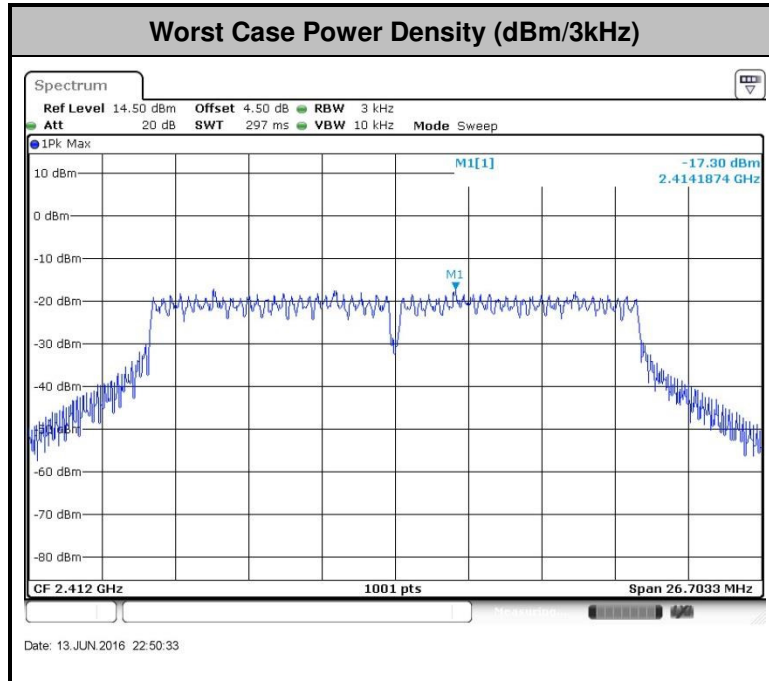

3.4 Conducted Band Edges and Spurious Emission Measurement

3.4.1 Limit of Conducted Band Edges and Spurious Emission Measurement

In any 100 kHz bandwidth outside of the authorized frequency band, the emissions which fall in the non-restricted bands shall be attenuated at least 20 dB / 30dB relative to the maximum PSD level in 100 kHz by RF conducted measurement and radiated emissions which fall in the restricted bands, as defined in Section 15.205(a), must also comply with the radiated emission limits specified in Section 15.209(a).

3.4.2 Measuring Instruments

The measuring equipment is listed in the section 4 of this test report.

3.4.3 Test Procedures

1. The testing follows FCC KDB Publication No. 558074 D01 DTS Meas. Guidance v03r05.
2. The RF output of EUT was connected to the spectrum analyzer by RF cable and attenuator. The path loss was compensated to the results for each measurement.
3. Set to the maximum power setting and enable the EUT transmit continuously.
4. Set RBW = 100 kHz, VBW=300 kHz, Peak Detector. Unwanted Emissions measured in any 100 kHz bandwidth outside of the authorized frequency band shall be attenuated by at least 20 dB relative to the maximum in-band peak PSD level in 100 kHz when maximum peak conducted output power procedure is used. If the transmitter complies with the conducted power limits based on the use of RMS averaging over a time interval, the attenuation required under this paragraph shall be 30 dB instead of 20 dB per 15.247(d).
5. Measure and record the results in the test report.
6. The RF fundamental frequency should be excluded against the limit line in the operating frequency band.

3.4.4 Test Setup

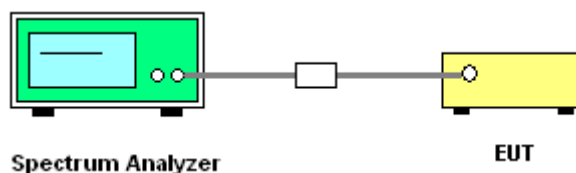



3.4.5 Test Result of Conducted Band Edges and Spurious Emission

Test Mode :	802.11b	Temperature :	24~25°C
Test Band :	2.4GHz Low	Relative Humidity :	54~55%
Test Channel :	01	Test Engineer :	Ivan Zhang

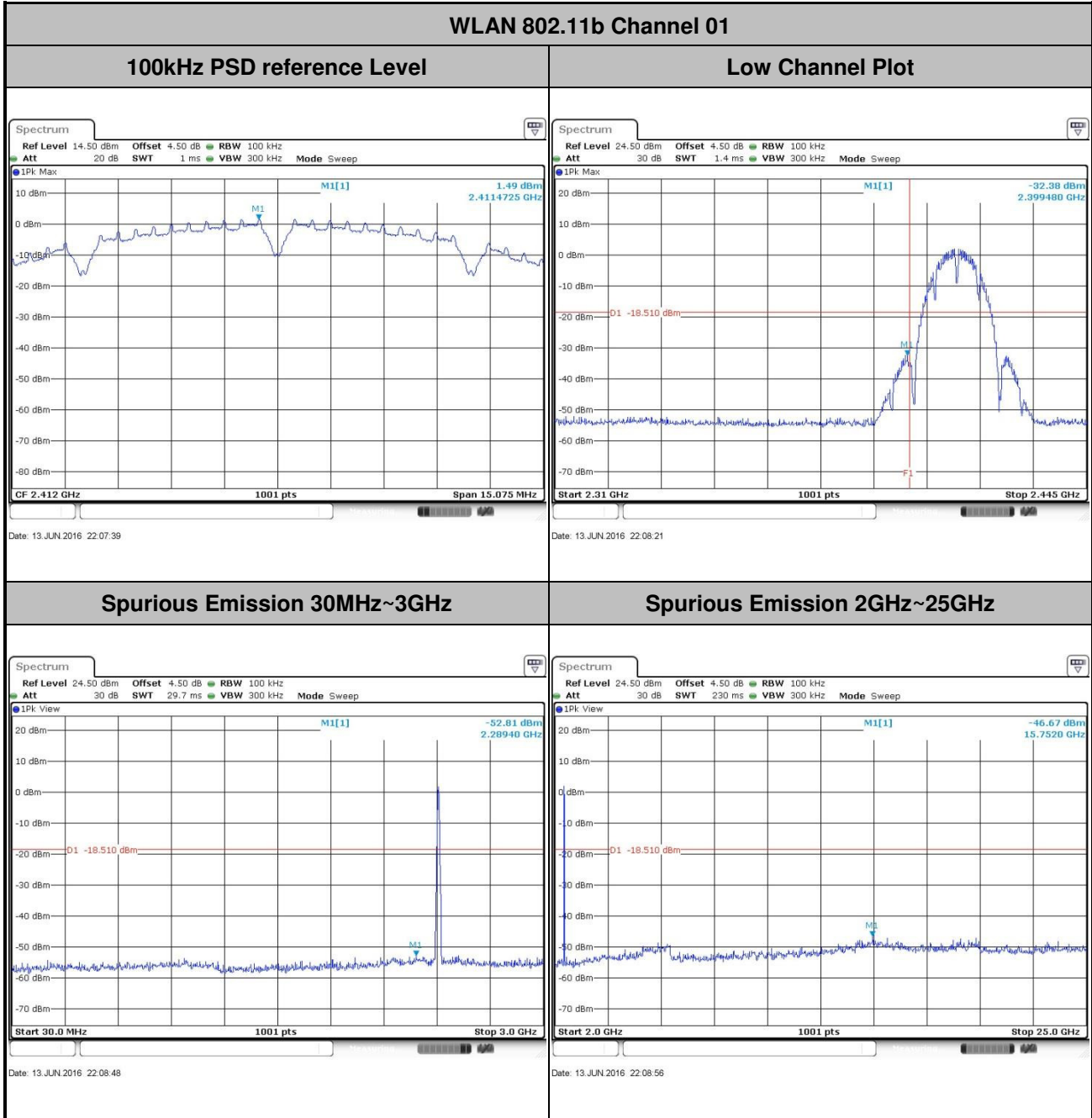



Test Mode :	802.11b	Temperature :	24~25°C
Test Band :	2.4GHz Mid	Relative Humidity :	54~55%
Test Channel :	06	Test Engineer :	Ivan Zhang

WLAN 802.11b Channel 06

100kHz PSD reference Level

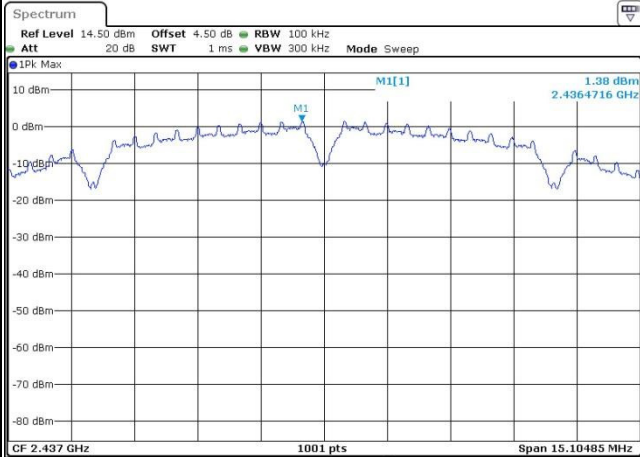

Date: 13 JUN 2016 22:15:39

Spurious Emission 30MHz~3GHz

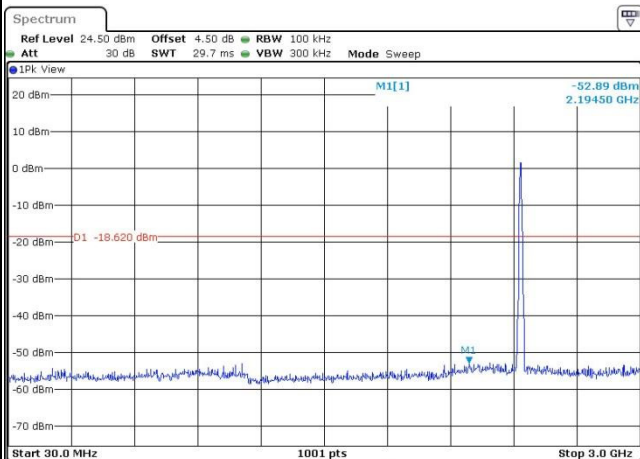

Date: 13 JUN 2016 22:16:05

Spurious Emission 2GHz~25GHz

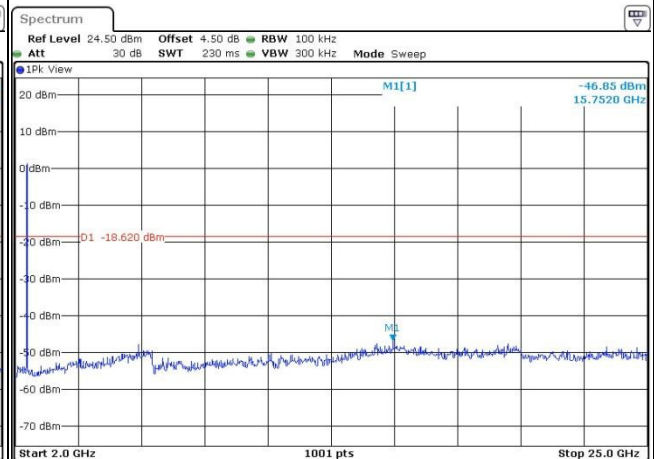

Date: 13 JUN 2016 22:16:14



Test Mode :	802.11b	Temperature :	24~25°C
Test Band :	2.4GHz High	Relative Humidity :	54~55%
Test Channel :	11	Test Engineer :	Ivan Zhang

WLAN 802.11b Channel 11

100kHz PSD reference Level

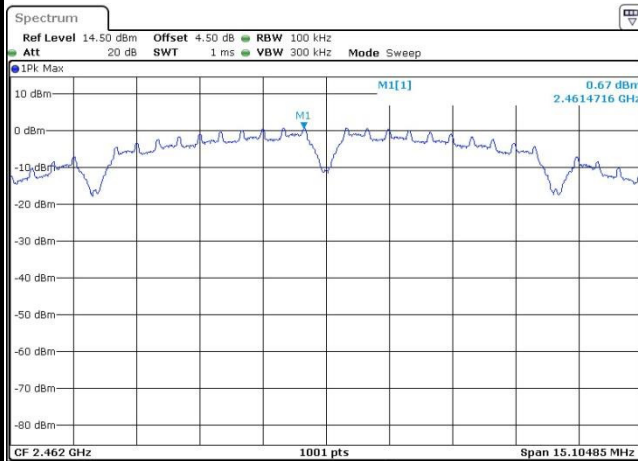

Date: 13 JUN 2016 22:19:50

High Channel Plot

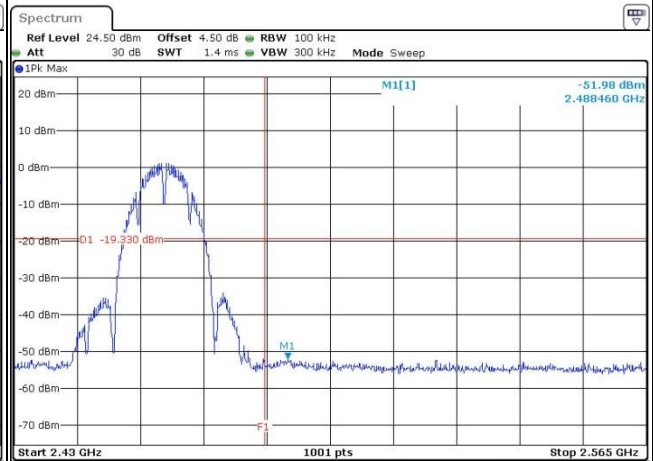

Date: 13 JUN 2016 22:20:16

Spurious Emission 30MHz~3GHz

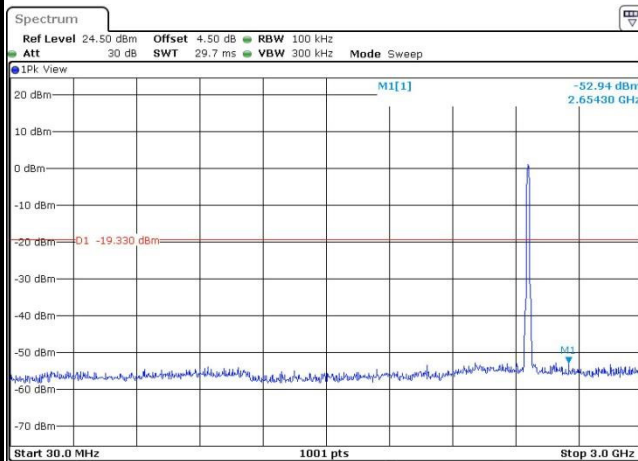

Date: 13 JUN 2016 22:21:01

Spurious Emission 2GHz~25GHz

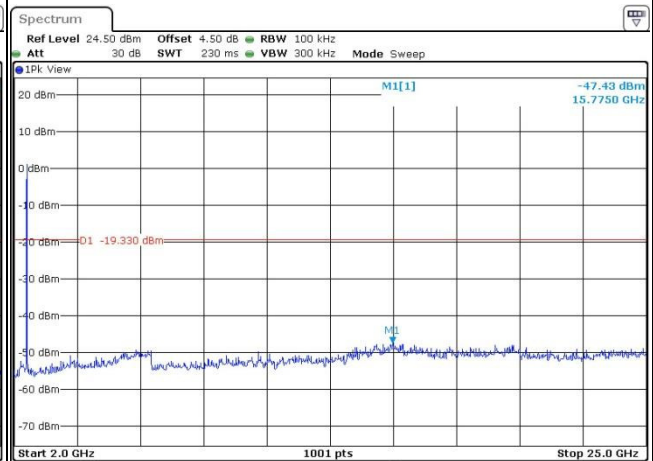

Date: 13 JUN 2016 22:21:09



Test Mode :	802.11g	Temperature :	24~25°C
Test Band :	2.4GHz Low	Relative Humidity :	54~55%
Test Channel :	01	Test Engineer :	Ivan Zhang

WLAN 802.11g Channel 01

100kHz PSD reference Level

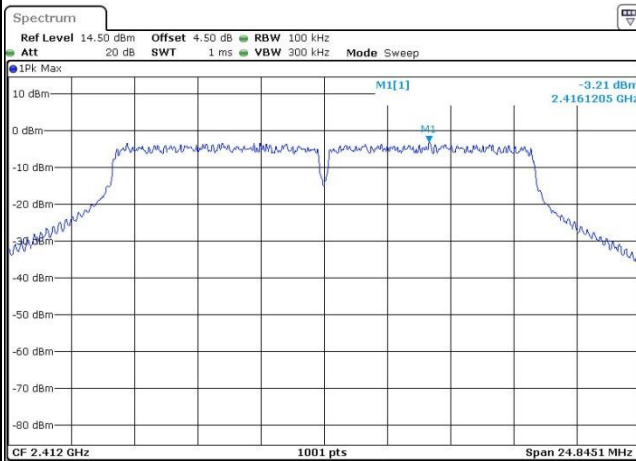

Date: 13 JUN 2016 22:30:58

Low Channel Plot

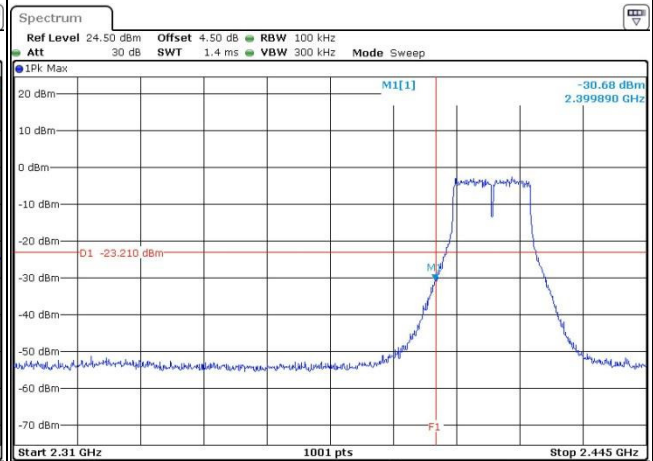

Date: 13 JUN 2016 22:31:31

Spurious Emission 30MHz~3GHz

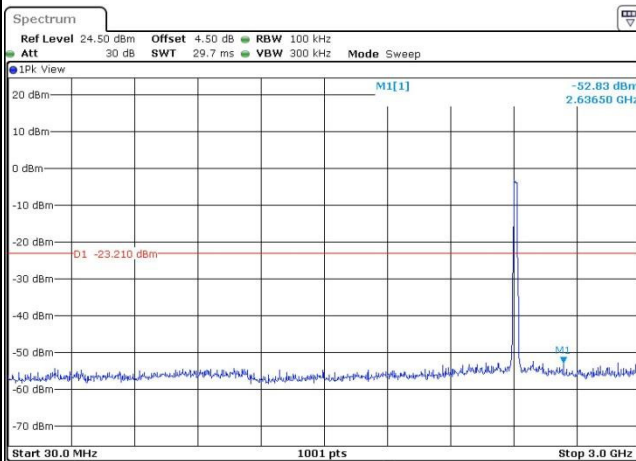

Date: 13 JUN 2016 22:31:42

Spurious Emission 2GHz~25GHz

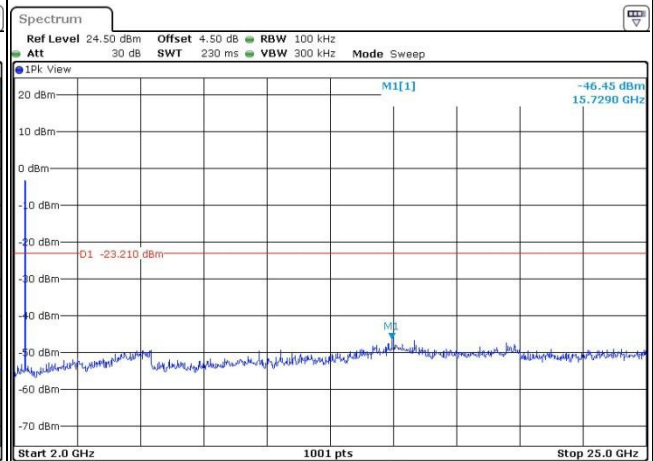

Date: 13 JUN 2016 22:31:51



Test Mode :	802.11g	Temperature :	24~25°C
Test Band :	2.4GHz Mid	Relative Humidity :	54~55%
Test Channel :	06	Test Engineer :	Ivan Zhang

WLAN 802.11g Channel 06

100kHz PSD reference Level

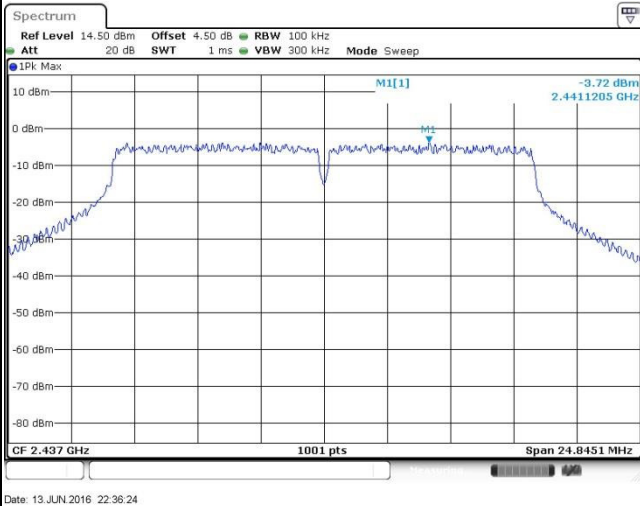

Spurious Emission 30MHz~3GHz

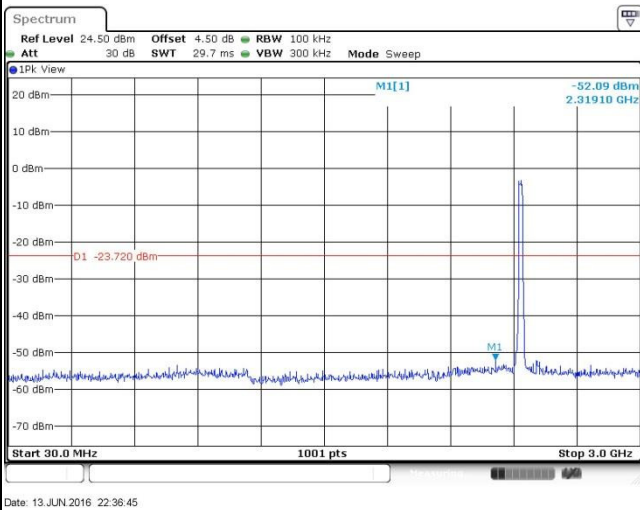

Spurious Emission 2GHz~25GHz

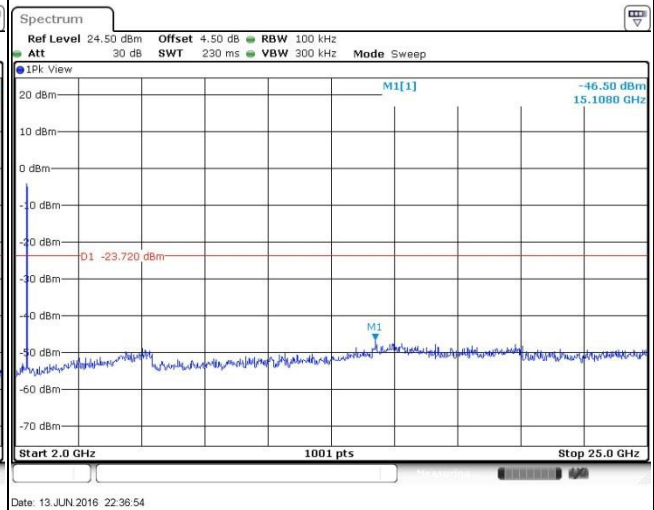



Test Mode :	802.11g	Temperature :	24~25°C
Test Band :	2.4GHz High	Relative Humidity :	54~55%
Test Channel :	11	Test Engineer :	Ivan Zhang

WLAN 802.11g Channel 11

100kHz PSD reference Level

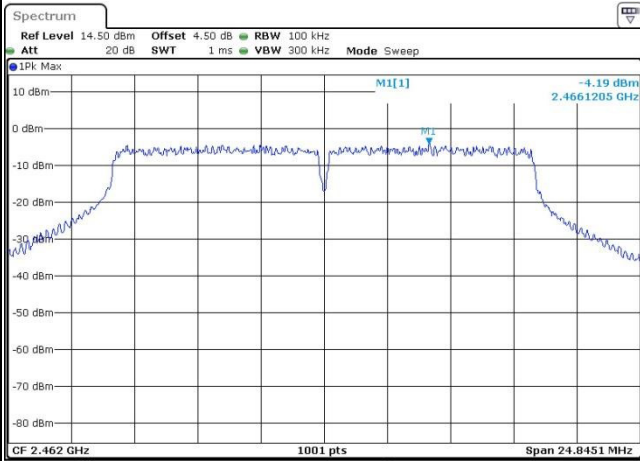

Date: 13 JUN 2016 22:40:06

High Channel Plot

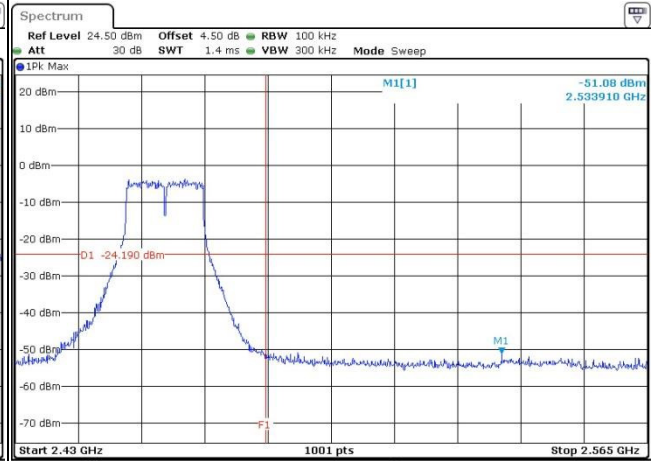

Date: 13 JUN 2016 22:40:39

Spurious Emission 30MHz~3GHz

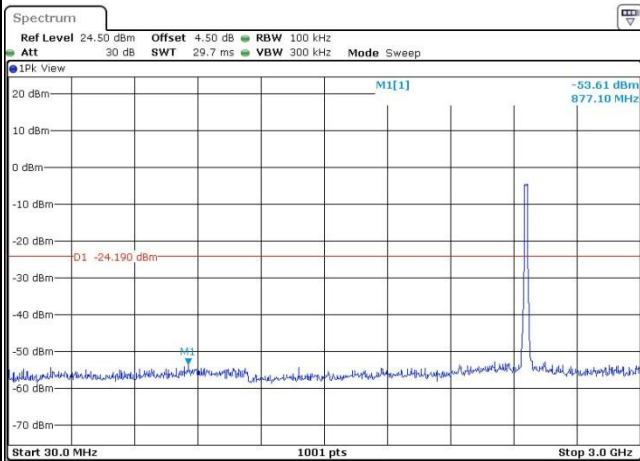

Date: 13 JUN 2016 22:40:56

Spurious Emission 2GHz~25GHz

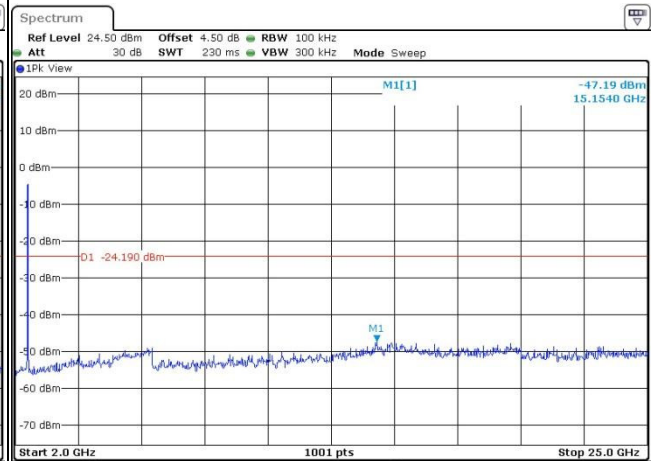

Date: 13 JUN 2016 22:41:05



Test Mode :	802.11n HT20	Temperature :	24~25°C
Test Band :	2.4GHz Low	Relative Humidity :	54~55%
Test Channel :	01	Test Engineer :	Ivan Zhang

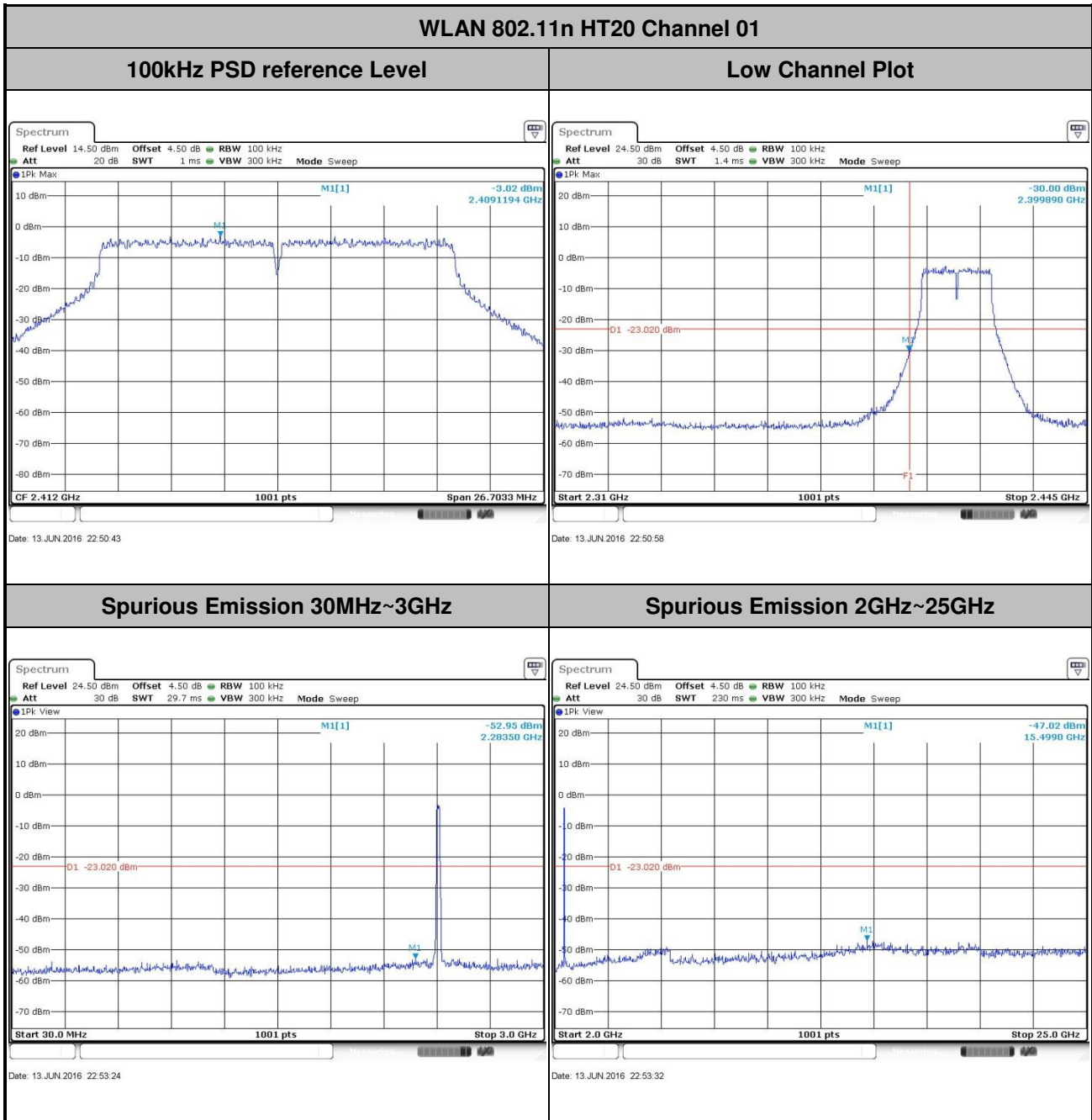



Test Mode :	802.11n HT20	Temperature :	24~25°C
Test Band :	2.4GHz Mid	Relative Humidity :	54~55%
Test Channel :	06	Test Engineer :	Ivan Zhang

WLAN 802.11n HT20 Channel 06

100kHz PSD reference Level

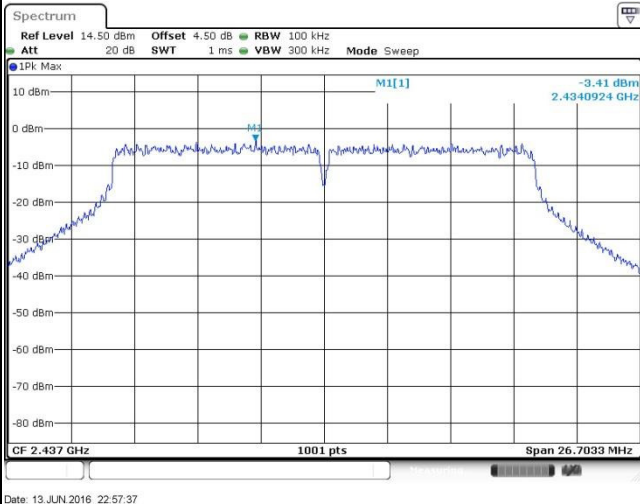

Spurious Emission 30MHz~3GHz

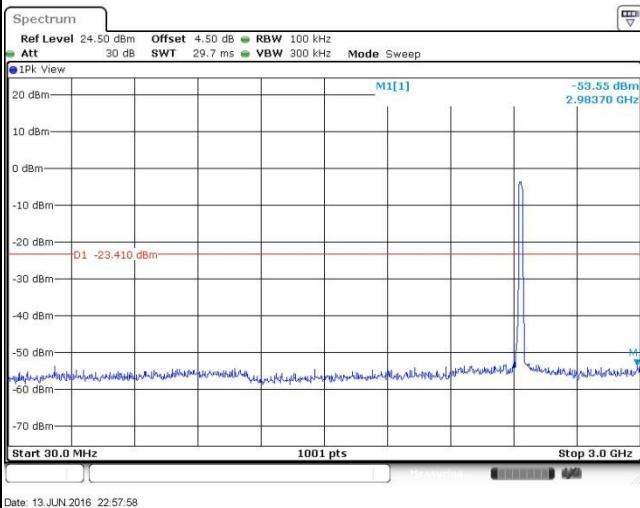

Spurious Emission 2GHz~25GHz

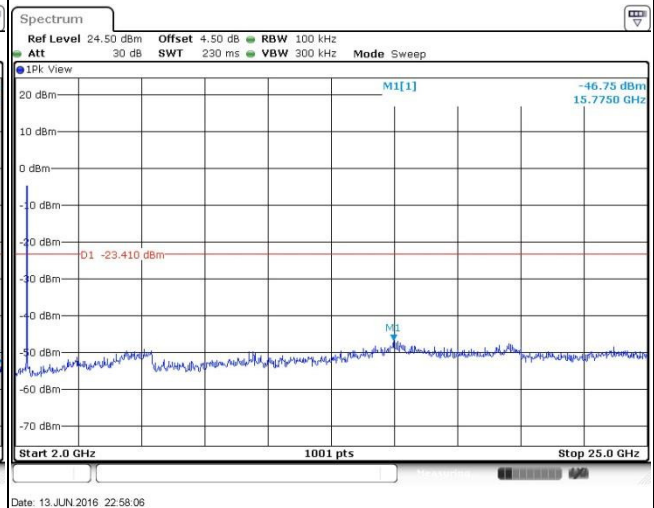



Test Mode :	802.11n HT20	Temperature :	24~25°C
Test Band :	2.4GHz High	Relative Humidity :	54~55%
Test Channel :	11	Test Engineer :	Ivan Zhang

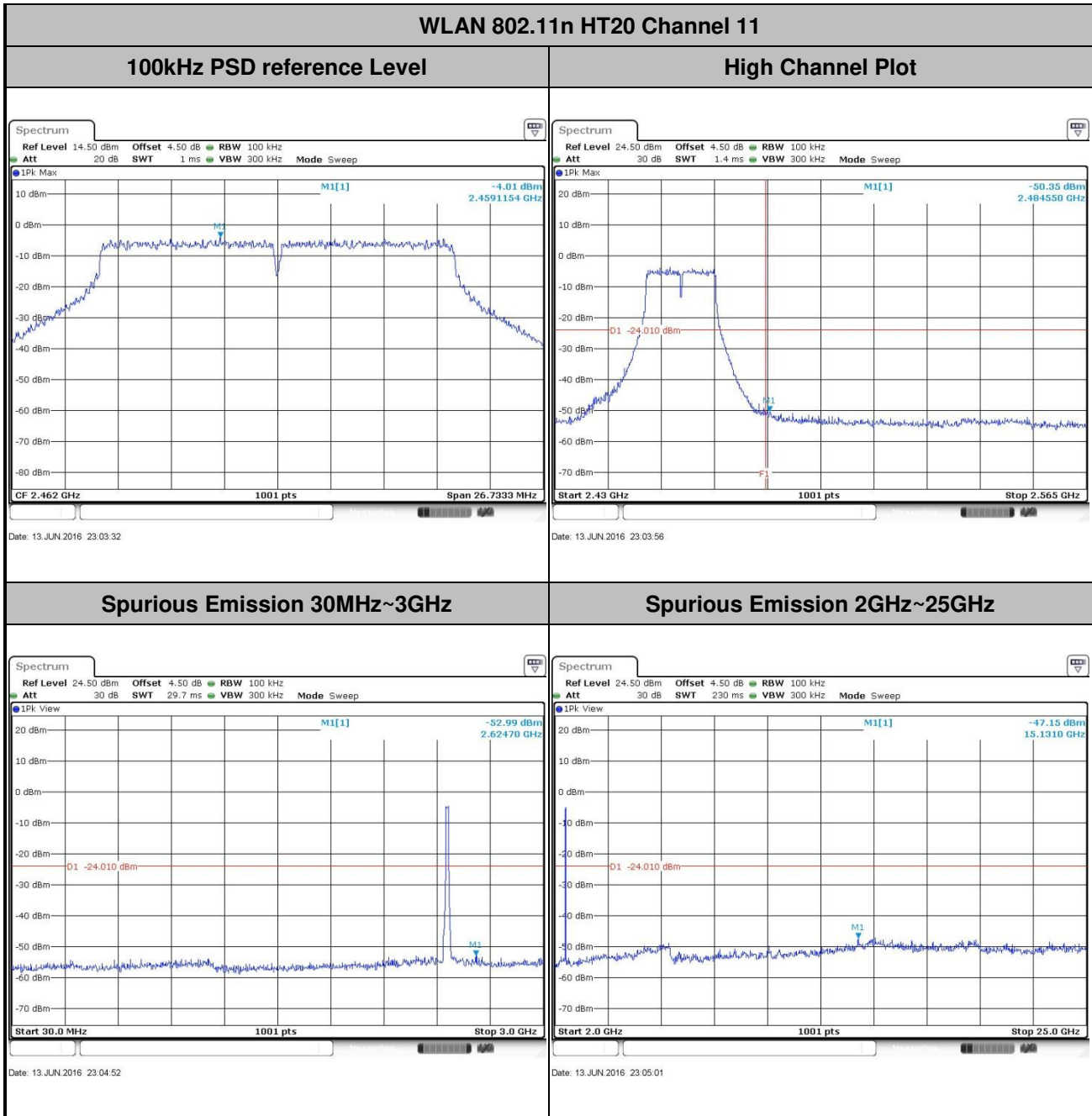



Test Mode :	802.11n HT40	Temperature :	24~25°C
Test Band :	2.4GHz Low	Relative Humidity :	54~55%
Test Channel :	03	Test Engineer :	Ivan Zhang

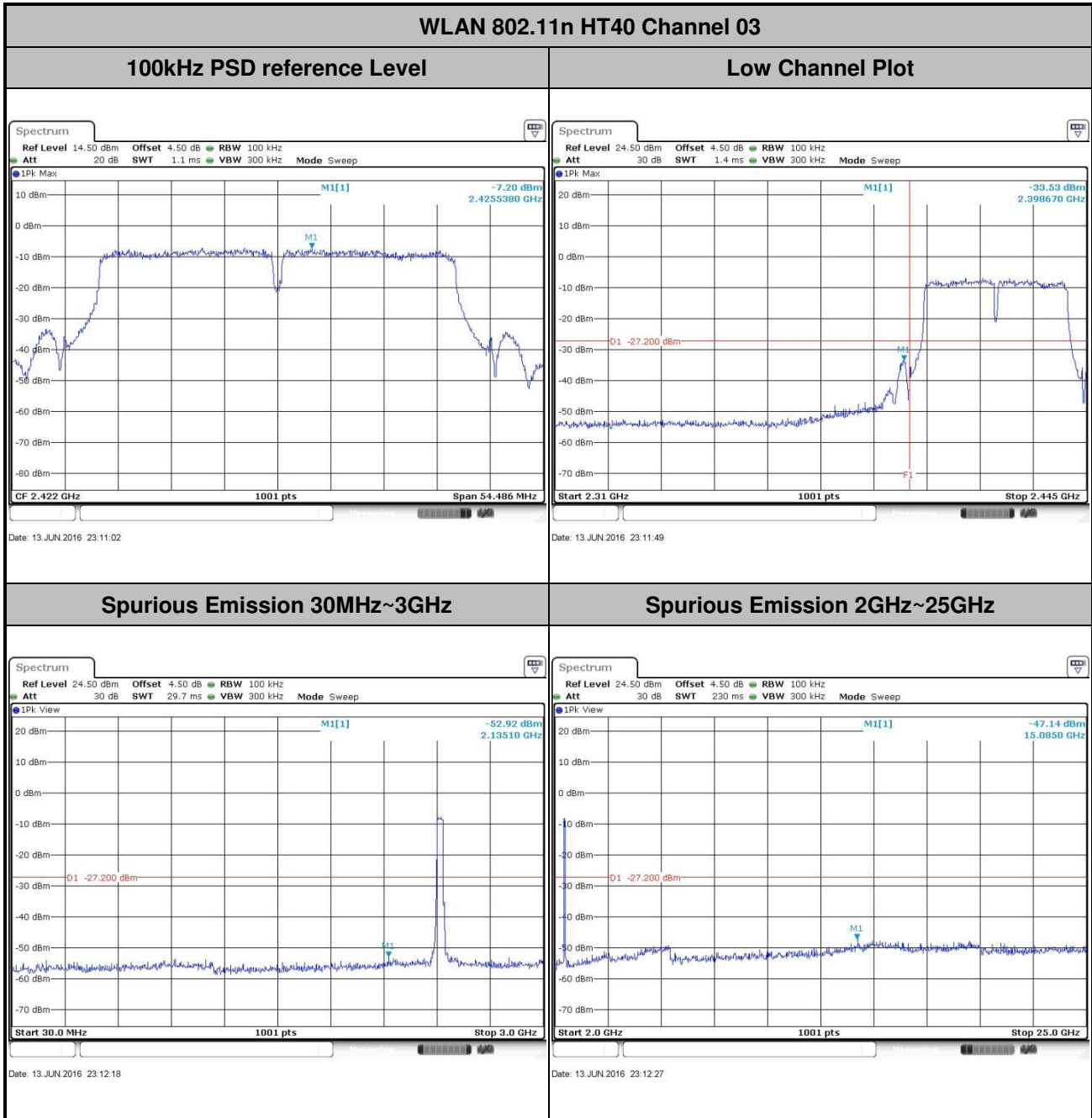



Test Mode :	802.11n HT40	Temperature :	24~25°C
Test Band :	2.4GHz Mid	Relative Humidity :	54~55%
Test Channel :	06	Test Engineer :	Ivan Zhang

WLAN 802.11n HT40 Channel 06

100kHz PSD reference Level

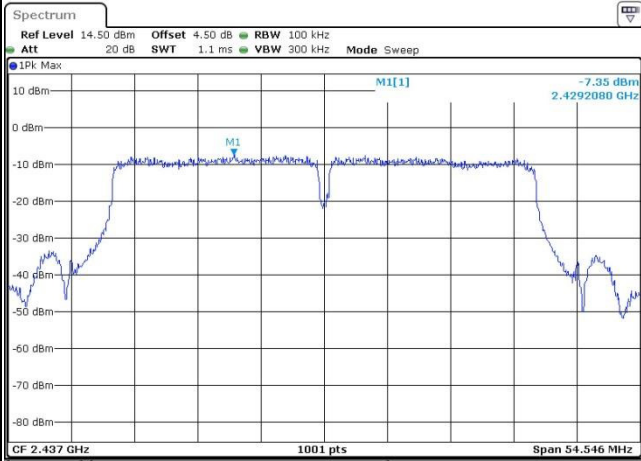

Date: 13 JUN 2016 23:17:44

Spurious Emission 30MHz~3GHz

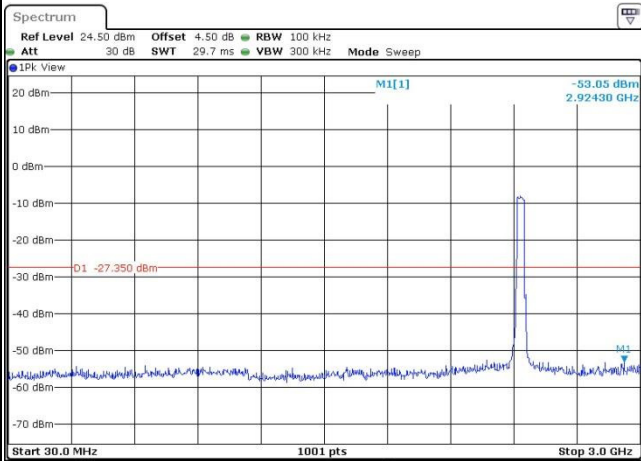

Date: 13 JUN 2016 23:18:11

Spurious Emission 2GHz~25GHz

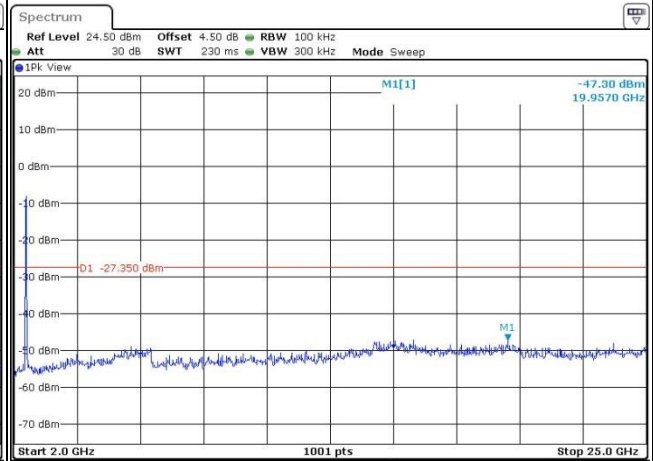

Date: 13 JUN 2016 23:18:19



Test Mode :	802.11n HT40	Temperature :	24~25°C
Test Band :	2.4GHz High	Relative Humidity :	54~55%
Test Channel :	09	Test Engineer :	Ivan Zhang

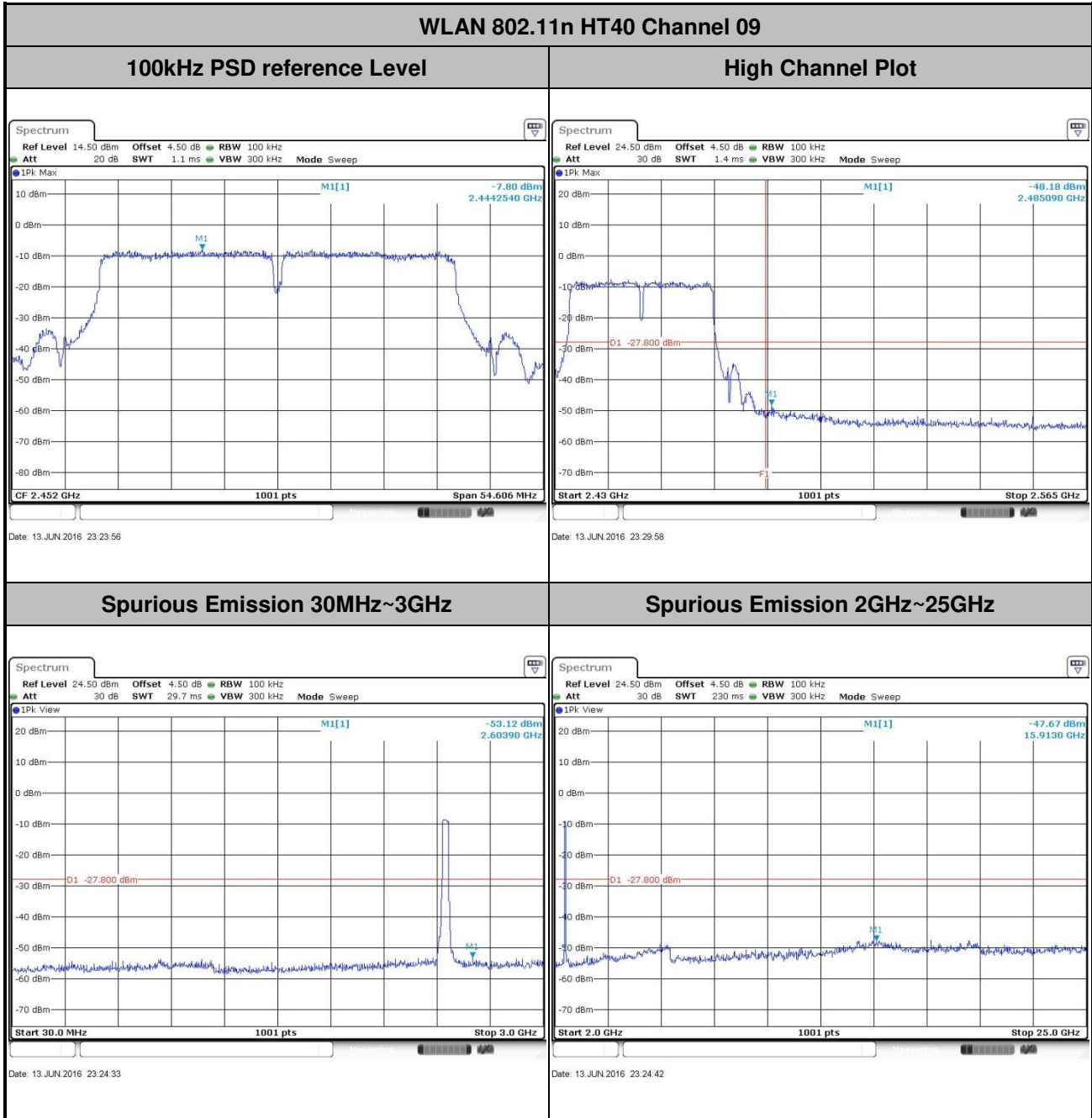



3.5 Radiated Band Edges and Spurious Emission Measurement

3.5.1 Limit of Radiated band edge and Spurious Emission Measurement

In any 100 kHz bandwidth outside the intentional radiator frequency band, all harmonics/spurious must be at least 20 dB below the highest emission level within the authorized band. If the output power of this device was measured by spectrum analyzer, the attenuation under this paragraph shall be 30 dB instead of 20 dB. In addition, radiated emissions which fall in the restricted bands must also comply with the FCC section 15.209 limits as below.

Frequency (MHz)	Field Strength (microvolts/meter)	Measurement Distance (meters)
0.009 – 0.490	2400/F(kHz)	300
0.490 – 1.705	24000/F(kHz)	30
1.705 – 30.0	30	30
30 – 88	100	3
88 – 216	150	3
216 - 960	200	3
Above 960	500	3

3.5.2 Measuring Instruments

The measuring equipment is listed in the section 4 of this test report.



3.5.3 Test Procedures

1. The testing follows FCC KDB Publication No. 558074 D01 DTS Meas. Guidance v03r05.
2. The EUT was arranged to its worst case and then tune the antenna tower (from 1 m to 4 m) and turntable (from 0 degree to 360 degrees) to find the maximum reading. A pre-amp and a high pass filter are used for the test in order to get better signal level.
3. The EUT was placed on a turntable with 0.8 meter for frequency below 1GHz and 1.5 meter for frequency above 1GHz respectively above ground.
4. The EUT was set 3 meters from the interference receiving antenna, which was mounted on the top of a variable height antenna tower.
5. Corrected Reading: Antenna Factor + Cable Loss + Read Level - Preamp Factor = Level
6. For measurement below 1GHz, If the emission level of the EUT measured by the peak detector is 3 dB lower than the applicable limit, the peak emission level will be reported. Otherwise, the emission measurement will be repeated using the quasi-peak detector and reported.
7. Use the following spectrum analyzer settings:
 - (1) Span shall wide enough to fully capture the emission being measured;
 - (2) Set RBW=100 kHz for $f < 1$ GHz; VBW \geq RBW; Sweep = auto; Detector function = peak; Trace = max hold;
 - (3) Set RBW = 1 MHz, VBW= 3MHz for $f \geq 1$ GHz for peak measurement.
For average measurement:
 - VBW = 10 Hz, when duty cycle is no less than 98 percent.
 - VBW $\geq 1/T$, when duty cycle is less than 98 percent where T is the minimum transmission duration over which the transmitter is on and is transmitting at its maximum power control level for the tested mode of operation.

3.5.4 Test Setup

For radiated emissions below 30MHz

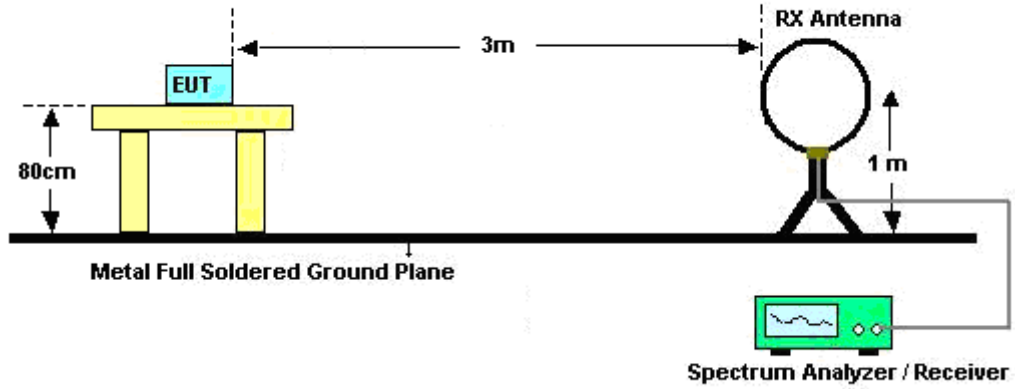

For radiated emissions from 30MHz to 1GHz

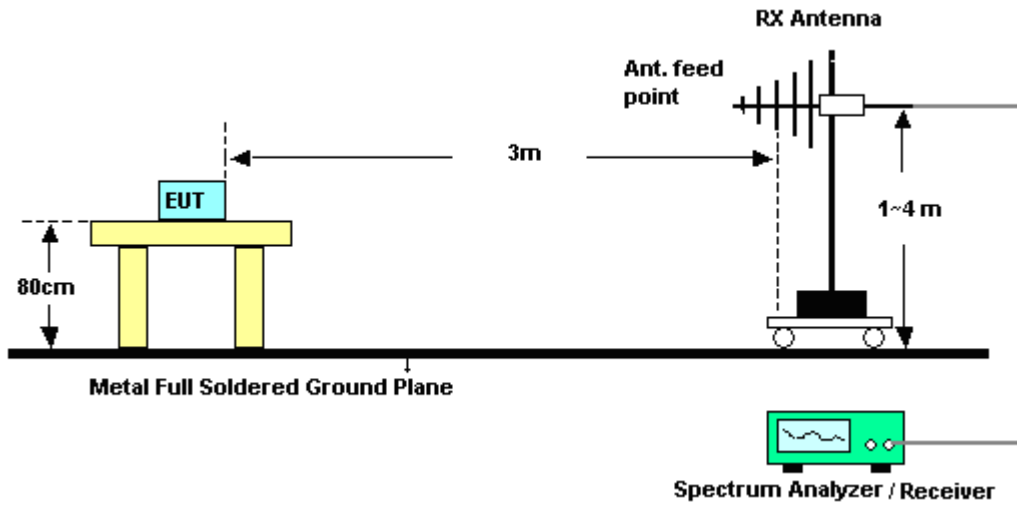

For radiated emissions above 1GHz

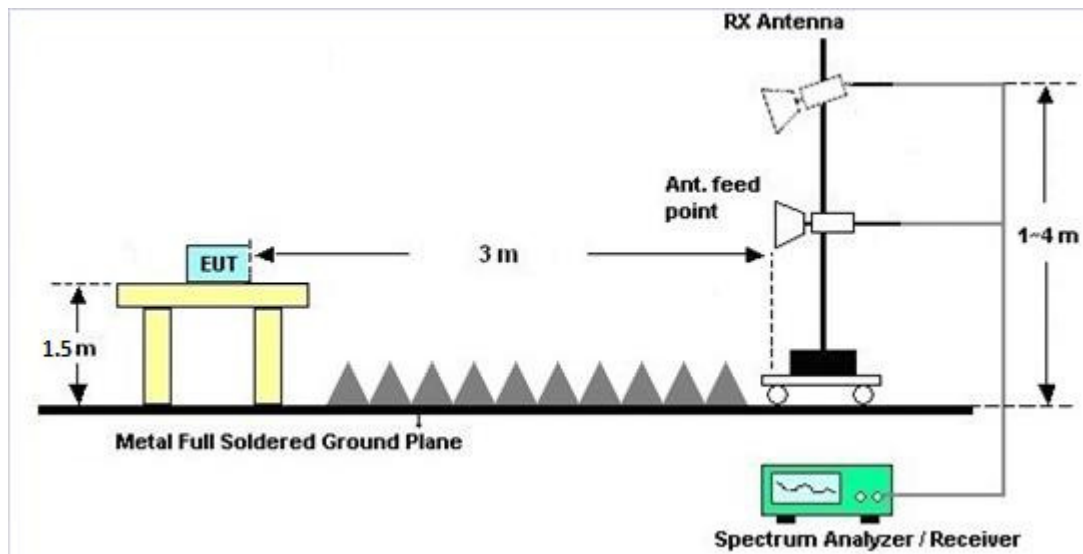

3.5.5 Test Results of Radiated Spurious Emissions (9kHz ~ 30MHz)

The low frequency, which started from 9 kHz to 30MHz, was pre-scanned and the result which was 20dB lower than the limit line per 15.31(o) was not reported.

3.5.6 Test Result of Radiated Spurious at Band Edges

Please refer to Appendix B.

3.5.7 Duty Cycle

Please refer to Appendix C.

3.5.8 Test Result of Radiated Spurious Emission (30MHz ~ 10th Harmonic)

Please refer to Appendix B.



3.6 AC Conducted Emission Measurement

3.6.1 Limit of AC Conducted Emission

For equipment that is designed to be connected to the public utility (AC) power line, the radio frequency voltage that is conducted back onto the AC power line on any frequency or frequencies within the band 150 kHz to 30 MHz shall not exceed the limits in the following table.

Frequency of Emission (MHz)	Conducted Limit (dB μ V)	
	Quasi-Peak	Average
0.15-0.5	66 to 56*	56 to 46*
0.5-5	56	46
5-30	60	50

*Decreases with the logarithm of the frequency.

3.6.2 Measuring Instruments

The measuring equipment is listed in the section 4 of this test report.

3.6.3 Test Procedures

1. The EUT was placed 0.4 meter from the conducting wall of the shielding room, and it was kept at least 80 centimeters from any other grounded conducting surface.
2. Connect EUT to the power mains through a line impedance stabilization network (LISN).
3. All the support units are connecting to the other LISN.
4. The LISN provides 50 ohm coupling impedance for the measuring instrument.
5. The FCC states that a 50 ohm, 50 microhenry LISN should be used.
6. Both sides of AC line were checked for maximum conducted interference.
7. The frequency range from 150 kHz to 30 MHz was searched.
8. Set the test-receiver system to Peak Detect Function and specified bandwidth (IF bandwidth = 9kHz) with Maximum Hold Mode.

3.6.4 Test Setup

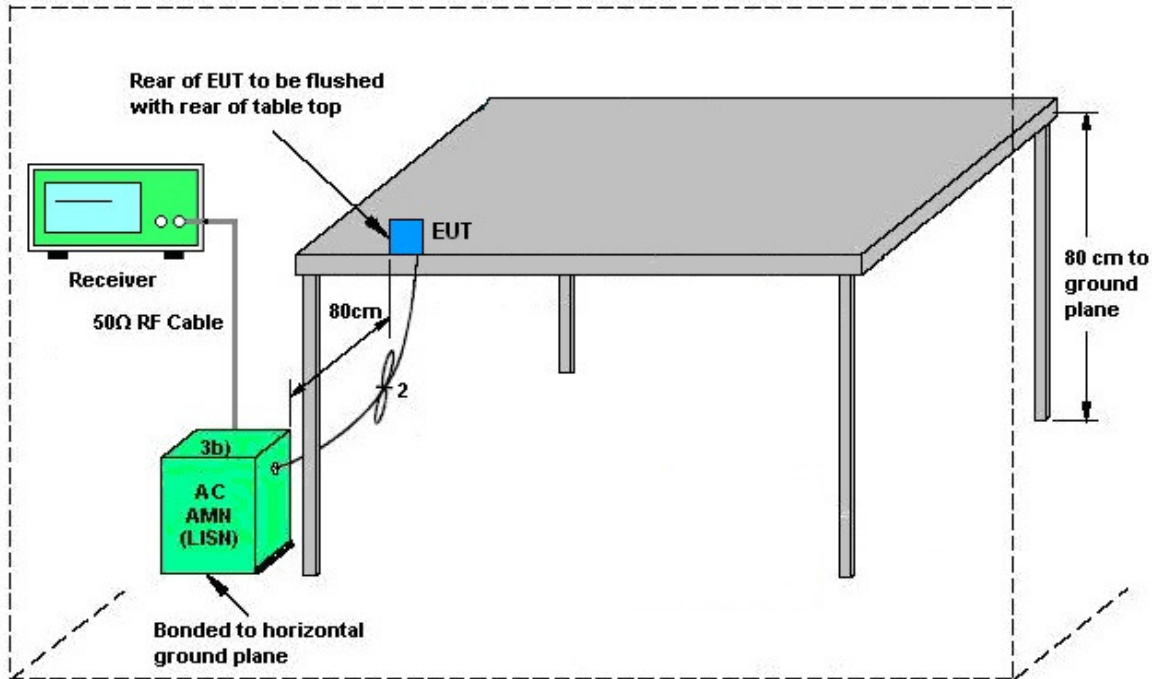

AMN = Artificial mains network (LISH)
 AE = Associated equipment
 EUT = Equipment under test
 ISN = Impedance stabilization network



3.6.5 Test Result of AC Conducted Emission

Test Mode :	Mode 1	Temperature :	22~24°C
Test Engineer :	Amos Zhang	Relative Humidity :	44~46%
Test Voltage :	120Vac / 60Hz	Phase :	Line
Function Type :	Bluetooth Link + WLAN Link + LAN load (RJ-45) + SD Card Play Color Bar + Adapter with Test Jig + USB 1 With U disk + USB 2 With U disk + Earphone + VGA With Monitor		

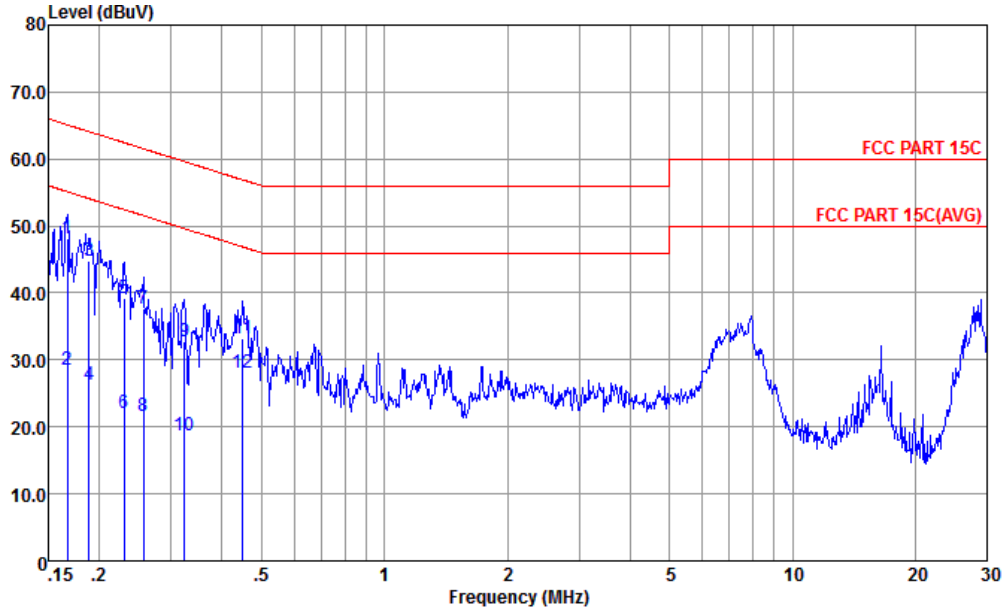

Site : CO01-KS
 Condition : FCC PART 15C LISN-L-20151024 LINE
 mode : Mode 1
 : SN:G2LSKW000015

	Freq	Level	Over Limit	Limit Line	Read Level	LISN Factor	Cable Loss	Remark
	MHz	dBuV	dB	dBuV	dBuV	dB	dB	
1 *	0.17	48.13	-16.99	65.12	37.60	0.41	10.12	QP
2	0.17	28.43	-26.69	55.12	17.90	0.41	10.12	Average
3	0.19	44.90	-19.21	64.11	34.50	0.28	10.12	QP
4	0.19	26.30	-27.81	54.11	15.90	0.28	10.12	Average
5	0.23	39.16	-23.28	62.44	28.80	0.22	10.14	QP
6	0.23	21.96	-30.48	52.44	11.60	0.22	10.14	Average
7	0.26	37.57	-23.99	61.56	27.21	0.22	10.14	QP
8	0.26	21.67	-29.89	51.56	11.31	0.22	10.14	Average
9	0.32	32.68	-26.94	59.62	22.29	0.23	10.16	QP
10	0.32	18.68	-30.94	49.62	8.29	0.23	10.16	Average
11	0.45	33.30	-23.59	56.89	22.90	0.23	10.17	QP
12	0.45	28.00	-18.89	46.89	17.60	0.23	10.17	Average



Test Mode :	Mode 1	Temperature :	22~24°C
Test Engineer :	Amos Zhang	Relative Humidity :	44~46%
Test Voltage :	120Vac / 60Hz	Phase :	Neutral
Function Type :	Bluetooth Link + WLAN Link + LAN load (RJ-45) + SD Card Play Color Bar + Adapter with Test Jig + USB 1 With U disk + USB 2 With U disk + Earphone + VGA With Monitor		

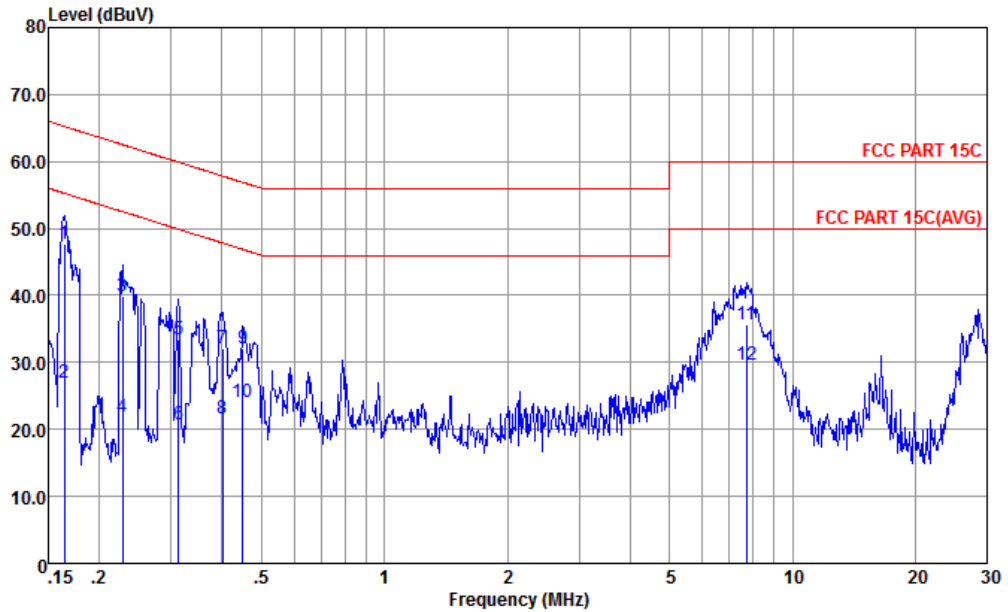

Site : CO01-KS
 Condition : FCC PART 15C LISN-N-20151024 NEUTRAL
 mode : Mode 1
 : SN:G2LSKW000015

	Freq	Level	Over Limit	Limit Line	Read Level	LISN Factor	Cable Loss	Remark
	MHz	dBuV	dB	dBuV	dBuV	dB	dB	
1 *	0.16	47.61	-17.64	65.25	37.20	0.30	10.11	QP
2	0.16	27.01	-28.24	55.25	16.60	0.30	10.11	Average
3	0.23	39.95	-22.57	62.52	29.50	0.31	10.14	QP
4	0.23	21.75	-30.77	52.52	11.30	0.31	10.14	Average
5	0.31	33.36	-26.52	59.88	22.90	0.31	10.15	QP
6	0.31	20.76	-29.12	49.88	10.30	0.31	10.15	Average
7	0.40	32.09	-25.72	57.81	21.60	0.32	10.17	QP
8	0.40	21.69	-26.12	47.81	11.20	0.32	10.17	Average
9	0.45	32.09	-24.80	56.89	21.60	0.32	10.17	QP
10	0.45	24.09	-22.80	46.89	13.60	0.32	10.17	Average
11	7.73	35.72	-24.28	60.00	25.20	0.29	10.23	QP
12	7.73	29.72	-20.28	50.00	19.20	0.29	10.23	Average



3.7 Antenna Requirements

3.7.1 Standard Applicable

If directional gain of transmitting antennas is greater than 6dBi, the power shall be reduced by the same level in dB comparing to gain minus 6dBi. For the fixed point-to-point operation, the power shall be reduced by one dB for every 3 dB that the directional gain of the antenna exceeds 6 dBi. The use of a permanently attached antenna or of an antenna that uses a unique coupling to the intentional radiator shall be considered sufficient to comply with the FCC rule.

3.7.2 Antenna Anti-Replacement Construction

External Antenna connector is used.

3.7.3 Antenna Gain

The antenna peak gain of EUT is less than 6 dBi. Therefore, it is not necessary to reduce maximum peak output power limit.



4 List of Measuring Equipment

Instrument	Manufacturer	Model No.	Serial No.	Characteristics	Calibration Date	Test Date	Due Date	Remark
Spectrum Analyzer	R&S	FSV40	101040	10Hz~40GHz	Sep. 10, 2015	Jun. 13, 2016	Sep. 09, 2016	Conducted (TH01-KS)
Pulse Power Sensor	Anritsu	MA2411B	0917070	300MHz~40GHz	Jan. 20, 2016	Jun. 13, 2016	Jan. 19, 2017	Conducted (TH01-KS)
Power Meter	Anritsu	ML2495A	1005002	50MHz Bandwidth	Jan. 20, 2016	Jun. 13, 2016	Jan. 19, 2017	Conducted (TH01-KS)
EMI Test Receiver	R&S	ESCI	100534	9kHz~3GHz	Oct. 24, 2015	May 07, 2016~ Jun. 21, 2016	Oct. 23, 2016	Radiation (03CH03-KS)
EXA Spectrum Analyzer	Keysight	N9010A	MY55150244	10Hz~44GHz	Apr. 22, 2016	May 07, 2016~ Jun. 21, 2016	Apr. 21, 2017	Radiation (03CH03-KS)
Loop Antenna	R&S	HFH2-Z2	100321	9kHz~30MHz	Nov. 07, 2015	May 07, 2016~ Jun. 21, 2016	Nov. 06, 2016	Radiation (03CH03-KS)
Bilog Antenna	TeseQ	CBL6112D	35406	25MHz~2GHz	Apr. 16, 2016	May 07, 2016~ Jun. 21, 2016	Apr. 15, 2017	Radiation (03CH03-KS)
Horn Antenna	Schwarzbeck	BBHA9120D	9120D-1356	1GHz~18GHz	Apr. 16, 2016	May 07, 2016~ Jun. 21, 2016	Apr. 15, 2017	Radiation (03CH03-KS)
SHF-EHF Horn	com-power	AH-840	101070	18GHz~40GHz	Oct. 10, 2015	May 07, 2016~ Jun. 21, 2016	Oct. 09, 2016	Radiation (03CH03-KS)
Amplifier	Burgeon	BPA-530	102212	0.01MHz~3000MHz	Aug. 10, 2015	May 07, 2016~ Jun. 21, 2016	Aug. 09, 2016	Radiation (03CH03-KS)
Amplifier	MITEQ	TTA1840-35-HG	1887435	18~40GHz	Aug. 27, 2015	May 07, 2016~ Jun. 21, 2016	Aug. 26, 2016	Radiation (03CH03-KS)
high gain Amplifier	MITEQ	AMF-7D-0010 1800-30-10P	1889560	1GHz~18GHz	Aug. 10, 2015	May 07, 2016~ Jun. 21, 2016	Aug. 09, 2016	Radiation (03CH03-KS)
Amplifier	Agilent	8449B	3008A02370	1GHz~26.5GHz	Oct. 24, 2015	May 07, 2016~ Jun. 21, 2016	Oct. 23, 2016	Radiation (03CH03-KS)
AC Power Source	Chroma	61601	F104090004	N/A	NCR	May 07, 2016~ Jun. 21, 2016	NCR	Radiation (03CH03-KS)
Turn Table	ChamPro	EM 1000-T	060762-T	0~360 degree	NCR	May 07, 2016~ Jun. 21, 2016	NCR	Radiation (03CH03-KS)
EMI Receiver	R&S	ESCI7	100768	9kHz~7GHz;	Apr. 29, 2016	May 15, 2016	Apr. 28, 2017	Conduction (CO01-KS)
AC LISN	MessTec	AN3016	060103	9kHz~30MHz	Oct. 24, 2015	May 15, 2016	Oct. 23, 2016	Conduction (CO01-KS)
AC LISN (for auxiliary equipment)	MessTec	AN3016	060105	9kHz~30MHz	Oct. 24, 2015	May 15, 2016	Oct. 23, 2016	Conduction (CO01-KS)
AC Power Source	Chroma	61602	ABP000000811	AC 0V~300V, 45Hz~1000Hz	Oct. 24, 2015	May 15, 2016	Oct. 23, 2016	Conduction (CO01-KS)

NCR: No Calibration Required



5 Uncertainty of Evaluation

Uncertainty of Conducted Emission Measurement (150kHz ~ 30MHz)

Measuring Uncertainty for a Level of Confidence of 95% ($U = 2Uc(y)$)	2.3dB
---	-------

Uncertainty of Radiated Emission Measurement (30 MHz ~ 1000 MHz)

Measuring Uncertainty for a Level of Confidence of 95% ($U = 2Uc(y)$)	4.5dB
---	-------

Uncertainty of Radiated Emission Measurement (1GHz ~ 18GHz)

Measuring Uncertainty for a Level of Confidence of 95% ($U = 2Uc(y)$)	4.5dB
---	-------

Uncertainty of Radiated Emission Measurement (18GHz ~ 40GHz)

Measuring Uncertainty for a Level of Confidence of 95% ($U = 2Uc(y)$)	4.6dB
---	-------



Appendix A. Conducted Test Results

A1 - DTS Part

Test Engineer:	Ivan Zhang	Temperature:	24~25	°C
Test Date:	2016/6/13	Relative Humidity:	54~55	%

TEST RESULTS DATA
6dB and 99% Occupied Bandwidth

2.4GHz Band								
Mod.	Data Rate	NTX	CH.	Freq. (MHz)	99% Occupied BW (MHz)	6dB BW (MHz)	6dB BW Limit (MHz)	Pass/Fail
11b	1Mbps	1	1	2412	15.33	10.05	0.50	Pass
11b	1Mbps	1	6	2437	15.18	10.07	0.50	Pass
11b	1Mbps	1	11	2462	15.23	10.07	0.50	Pass
11g	6Mbps	1	1	2412	18.88	16.56	0.50	Pass
11g	6Mbps	1	6	2437	18.93	16.56	0.50	Pass
11g	6Mbps	1	11	2462	18.93	16.56	0.50	Pass
HT20	MCS0	1	1	2412	19.73	17.80	0.50	Pass
HT20	MCS0	1	6	2437	19.73	17.80	0.50	Pass
HT20	MCS0	1	11	2462	19.78	17.82	0.50	Pass
HT40	MCS0	1	3	2422	36.56	36.32	0.50	Pass
HT40	MCS0	1	6	2437	36.66	36.36	0.50	Pass
HT40	MCS0	1	9	2452	36.76	36.40	0.50	Pass

TEST RESULTS DATA
Peak Power Table

2.4GHz Band										
Mod.	Data Rate	NTX	CH.	Freq. (MHz)	Peak Conducted Power (dBm)	Conducted Power Limit (dBm)	DG (dBi)	EIRP Power (dBm)	EIRP Power Limit (dBm)	Pass /Fail
11b	1Mbps	1	1	2412	13.94	30.00	5.00	18.94	36.00	Pass
11b	1Mbps	1	6	2437	13.93	30.00	5.00	18.93	36.00	Pass
11b	1Mbps	1	11	2462	12.31	30.00	5.00	17.31	36.00	Pass
11g	6Mbps	1	1	2412	21.11	30.00	5.00	26.11	36.00	Pass
11g	6Mbps	1	6	2437	20.67	30.00	5.00	25.67	36.00	Pass
11g	6Mbps	1	11	2462	19.47	30.00	5.00	24.47	36.00	Pass
HT20	MCS0	1	1	2412	20.73	30.00	5.00	25.73	36.00	Pass
HT20	MCS0	1	6	2437	20.14	30.00	5.00	25.14	36.00	Pass
HT20	MCS0	1	11	2462	18.95	30.00	5.00	23.95	36.00	Pass
HT40	MCS0	1	3	2422	20.08	30.00	5.00	25.08	36.00	Pass
HT40	MCS0	1	6	2437	19.73	30.00	5.00	24.73	36.00	Pass
HT40	MCS0	1	9	2452	18.91	30.00	5.00	23.91	36.00	Pass

TEST RESULTS DATA
Average Power Table
(Reporting Only)

2.4GHz Band						
Mod.	Data Rate	NTX	CH.	Freq. (MHz)	Duty Factor (dB)	Average Conducted Power (dBm)
11b	1Mbps	1	1	2412	0.00	11.90
11b	1Mbps	1	6	2437	0.00	11.89
11b	1Mbps	1	11	2462	0.00	10.21
11g	6Mbps	1	1	2412	0.00	11.42
11g	6Mbps	1	6	2437	0.00	11.31
11g	6Mbps	1	11	2462	0.00	9.93
HT20	MCS0	1	1	2412	0.00	11.45
HT20	MCS0	1	6	2437	0.00	11.32
HT20	MCS0	1	11	2462	0.00	9.92
HT40	MCS0	1	3	2422	0.00	10.71
HT40	MCS0	1	6	2437	0.00	10.35
HT40	MCS0	1	9	2452	0.00	9.31

TEST RESULTS DATA
Peak Power Density

2.4GHz Band								
Mod.	Data Rate	NTX	CH.	Freq. (MHz)	Peak PSD (dBm /3kHz)	DG (dBi)	Peak PSD Limit (dBm /3kHz)	Pass/Fail
11b	1Mbps	1	1	2412	-18.64	5.00	8.00	Pass
11b	1Mbps	1	6	2437	-19.26	5.00	8.00	Pass
11b	1Mbps	1	11	2462	-19.44	5.00	8.00	Pass
11g	6Mbps	1	1	2412	-17.78	5.00	8.00	Pass
11g	6Mbps	1	6	2437	-18.31	5.00	8.00	Pass
11g	6Mbps	1	11	2462	-18.82	5.00	8.00	Pass
HT20	MCS0	1	1	2412	-17.30	5.00	8.00	Pass
HT20	MCS0	1	6	2437	-17.32	5.00	8.00	Pass
HT20	MCS0	1	11	2462	-17.96	5.00	8.00	Pass
HT40	MCS0	1	3	2422	-20.45	5.00	8.00	Pass
HT40	MCS0	1	6	2437	-20.23	5.00	8.00	Pass
HT40	MCS0	1	9	2452	-21.43	5.00	8.00	Pass



Appendix B. Radiated Spurious Emission

Antenna A

2.4GHz 2400~2483.5MHz

WIFI 802.11b (Band Edge @ 3m)

WIFI Ant.	Note	Frequency	Level	Over Limit	Limit Line	Read Level	Antenna Factor	Cable Loss	Preamp Factor	Ant Pos	Table Pos	Peak Avg.	Pol.
1		(MHz)	(dBμV/m)	(dB)	(dBμV/m)	(dBμV)	(dB/m)	(dB)	(dB)	(cm)	(deg)	(P/A)	(H/V)
802.11b CH 01 2412MHz		2385.33	51.67	-22.33	74	56.17	26.95	5.57	37.02	117	94	P	H
		2385.87	39.73	-14.27	54	44.16	27	5.59	37.02	117	94	A	H
	*	2412.024	92.37	-	-	96.63	27.13	5.61	37	117	94	P	H
	*	2413.193	89.43	-	-	93.69	27.13	5.61	37	117	94	A	H
		2332.32	52.84	-21.16	74	57.53	26.82	5.5	37.01	100	27	P	V
		2331.06	41.32	-12.68	54	46.01	26.82	5.5	37.01	100	27	A	V
	*	2412.024	101.18	-	-	105.44	27.13	5.61	37	100	27	P	V
	*	2410.938	98.26	-	-	102.52	27.13	5.61	37	100	27	A	V
802.11b CH 06 2437MHz	*	2436.99	92.02	-	-	95.95	27.39	5.65	36.97	106	262	P	H
	*	2435.905	89.11	-	-	93.21	27.26	5.63	36.99	106	262	A	H
	*	2436.99	101.31	-	-	105.24	27.39	5.65	36.97	100	28	P	V
	*	2435.905	98.38	-	-	102.48	27.26	5.63	36.99	100	28	A	V
802.11b CH 11 2462MHz	*	2461.957	92.8	-	-	96.58	27.51	5.67	36.96	100	261	P	H
	*	2463.126	89.91	-	-	93.69	27.51	5.67	36.96	100	261	A	H
		2496.04	52.07	-21.93	74	55.52	27.77	5.71	36.93	100	261	P	H
		2488.52	40.67	-13.33	54	44.12	27.77	5.71	36.93	100	261	A	H
	*	2461.957	102.94	-	-	106.72	27.51	5.67	36.96	139	262	P	V
	*	2463.126	100.03	-	-	103.81	27.51	5.67	36.96	139	262	A	V
		2488.08	53.61	-20.39	74	57.06	27.77	5.71	36.93	139	262	P	V
		2488.28	42.85	-11.15	54	46.3	27.77	5.71	36.93	139	262	A	V
Remark	1. No other spurious found. 2. All results are PASS against Peak and Average limit line.												



2.4GHz 2400~2483.5MHz

WIFI 802.11b (Harmonic @ 3m)

WIFI Ant. 1	Note	Frequency (MHz)	Level (dBμV/m)	Over Limit (dB)	Limit Line (dBμV/m)	Read Level (dBμV)	Antenna Factor (dB/m)	Cable Loss (dB)	Preamp Factor (dB)	Ant Pos (cm)	Table Pos (deg)	Peak Avg. (P/A)	Pol. (H/V)
802.11b CH 01 2412MHz		4824	37.08	-36.92	74	58.54	31.51	9.13	62.1	100	360	P	H
		4824	41.11	-32.89	74	62.57	31.51	9.13	62.1	100	0	P	V
802.11b CH 06 2437MHz		4875	36.84	-37.16	74	58.08	31.59	9.2	62.03	100	360	P	H
		7311	39.36	-34.64	74	53.19	34.03	11.3	59.16	100	0	P	H
		4875	41.56	-32.44	74	62.8	31.59	9.2	62.03	100	0	P	V
		7311	38.14	-35.86	74	51.97	34.03	11.3	59.16	100	360	P	V
802.11b CH 11 2462MHz		4923	35.87	-38.13	74	56.9	31.67	9.27	61.97	100	360	P	H
		7386	38.65	-35.35	74	52.19	34.29	11.29	59.12	100	0	P	H
		4923	40.61	-33.39	74	61.64	31.67	9.27	61.97	100	0	P	V
		7386	38.96	-35.04	74	52.5	34.29	11.29	59.12	100	313	P	V
Remark	1. No other spurious found. 2. All results are PASS against Peak and Average limit line.												



**2.4GHz 2400~2483.5MHz
WIFI 802.11g (Band Edge @ 3m)**

WIFI Ant. 1	Note	Frequency (MHz)	Level (dBμV/m)	Over Limit (dB)	Limit Line (dBμV/m)	Read Level (dBμV)	Antenna Factor (dB/m)	Cable Loss (dB)	Preamp Factor (dB)	Ant Pos (cm)	Table Pos (deg)	Peak Avg. (P/A)	Pol. (H/V)
802.11g CH 01 2412MHz		2383.17	51.87	-22.13	74	56.37	26.95	5.57	37.02	107	258	P	H
		2390	40.1	-13.9	54	44.53	27	5.59	37.02	107	258	A	H
	*	2409.352	93.48	-	-	97.74	27.13	5.61	37	107	258	P	H
	*	2409.519	85.98	-	-	90.24	27.13	5.61	37	107	258	A	H
		2389.56	54.77	-19.23	74	59.2	27	5.59	37.02	166	225	P	V
		2390	42.73	-11.27	54	47.16	27	5.59	37.02	166	225	A	V
	*	2418.621	102.07	-	-	106.33	27.13	5.61	37	166	225	P	V
	*	2416.616	94.66	-	-	98.92	27.13	5.61	37	166	225	A	V
802.11g CH 06 2437MHz	*	2430.728	93.28	-	-	97.38	27.26	5.63	36.99	100	329	P	H
	*	2430.561	85.82	-	-	89.92	27.26	5.63	36.99	100	329	A	H
	*	2438.66	101.43	-	-	105.36	27.39	5.65	36.97	100	358	P	V
	*	2439.746	94.03	-	-	97.96	27.39	5.65	36.97	100	358	A	V
802.11g CH 11 2462MHz	*	2464.796	93.01	-	-	96.79	27.51	5.67	36.96	100	259	P	H
	*	2464.963	85.63	-	-	89.41	27.51	5.67	36.96	100	259	A	H
		2488.8	52.22	-21.78	74	55.67	27.77	5.71	36.93	100	259	P	H
		2483.52	40.71	-13.29	54	44.32	27.64	5.69	36.94	100	259	A	H
	*	2459.368	104.12	-	-	107.9	27.51	5.67	36.96	153	204	P	V
	*	2459.201	96.64	-	-	100.42	27.51	5.67	36.96	153	204	A	V
		2494.68	55.45	-18.55	74	58.9	27.77	5.71	36.93	153	204	P	V
	2483.56	43.96	-10.04	54	47.57	27.64	5.69	36.94	153	204	A	V	
Remark	1. No other spurious found. 2. All results are PASS against Peak and Average limit line.												



**2.4GHz 2400~2483.5MHz
WIFI 802.11g (Harmonic @ 3m)**

WIFI Ant. 1	Note	Frequency (MHz)	Level (dBμV/m)	Over Limit (dB)	Limit Line (dBμV/m)	Read Level (dBμV)	Antenna Factor (dB/m)	Cable Loss (dB)	Preamp Factor (dB)	Ant Pos (cm)	Table Pos (deg)	Peak Avg. (P/A)	Pol. (H/V)
802.11g CH 01 2412MHz		4824	35.78	-38.22	74	57.24	31.51	9.13	62.1	100	360	P	H
		4824	38.52	-35.48	74	59.98	31.51	9.13	62.1	100	0	P	V
802.11g CH 06 2437MHz		4875	35.57	-38.43	74	56.81	31.59	9.2	62.03	100	360	P	H
		7311	38.57	-35.43	74	52.4	34.03	11.3	59.16	100	0	P	H
		4875	37.66	-36.34	74	58.9	31.59	9.2	62.03	100	0	P	V
		7311	40.61	-33.39	74	54.44	34.03	11.3	59.16	100	360	P	V
802.11g CH 11 2462MHz		4923	36.15	-37.85	74	57.18	31.67	9.27	61.97	100	360	P	H
		7386	39.72	-34.28	74	53.26	34.29	11.29	59.12	100	0	P	H
		4923	38.75	-35.25	74	59.78	31.67	9.27	61.97	100	0	P	V
		7386	39.19	-34.81	74	52.73	34.29	11.29	59.12	100	360	P	V
Remark	1. No other spurious found. 2. All results are PASS against Peak and Average limit line.												



**2.4GHz 2400~2483.5MHz
WIFI 802.11n HT20 (Band Edge @ 3m)**

WIFI Ant. 1	Note	Frequency (MHz)	Level (dBμV/m)	Over Limit (dB)	Limit Line (dBμV/m)	Read Level (dBμV)	Antenna Factor (dB/m)	Cable Loss (dB)	Preamp Factor (dB)	Ant Pos (cm)	Table Pos (deg)	Peak Avg. (P/A)	Pol. (H/V)
802.11n HT20 CH 01 2412MHz		2321.25	51.06	-22.94	74	55.75	26.82	5.5	37.01	100	258	P	H
		2390	40.01	-13.99	54	44.44	27	5.59	37.02	100	258	A	H
	*	2408.935	91.71	-	-	95.97	27.13	5.61	37	100	258	P	H
	*	2417.117	83.99	-	-	88.25	27.13	5.61	37	100	258	A	H
		2389.92	58.65	-15.35	74	63.08	27	5.59	37.02	170	207	P	V
		2390	43.62	-10.38	54	48.05	27	5.59	37.02	170	207	A	V
	*	2419.372	102.48	-	-	106.74	27.13	5.61	37	170	207	P	V
	*	2419.623	94.95	-	-	99.05	27.26	5.63	36.99	170	207	A	V
802.11n HT20 CH 06 2437MHz	*	2433.901	91.67	-	-	95.77	27.26	5.63	36.99	100	351	P	H
	*	2433.65	83.74	-	-	87.84	27.26	5.63	36.99	100	351	A	H
	*	2433.901	101.62	-	-	105.72	27.26	5.63	36.99	100	351	P	V
	*	2440.08	93.78	-	-	97.71	27.39	5.65	36.97	100	351	A	V
802.11n HT20 CH 11 2462MHz	*	2458.867	92.22	-	-	96	27.51	5.67	36.96	100	352	P	H
	*	2458.7	84.22	-	-	88	27.51	5.67	36.96	100	352	A	H
		2492.64	52.71	-21.29	74	56.16	27.77	5.71	36.93	100	352	P	H
		2484.12	40.64	-13.36	54	44.25	27.64	5.69	36.94	100	352	A	H
	*	2458.867	102.1	-	-	105.88	27.51	5.67	36.96	100	253	P	V
	*	2458.617	94.14	-	-	97.92	27.51	5.67	36.96	100	253	A	V
		2485.04	54.77	-19.23	74	58.38	27.64	5.69	36.94	100	253	P	V
	2483.52	43.13	-10.87	54	46.74	27.64	5.69	36.94	100	253	A	V	
Remark	1. No other spurious found. 2. All results are PASS against Peak and Average limit line.												



**2.4GHz 2400~2483.5MHz
WIFI 802.11n HT20 (Harmonic @ 3m)**

WIFI Ant. 1	Note	Frequency (MHz)	Level (dBμV/m)	Over Limit (dB)	Limit Line (dBμV/m)	Read Level (dBμV)	Antenna Factor (dB/m)	Cable Loss (dB)	Preamp Factor (dB)	Ant Pos (cm)	Table Pos (deg)	Peak Avg. (P/A)	Pol. (H/V)
802.11n HT20 CH 01 2412MHz		4824	36.87	-37.13	74	58.33	31.51	9.13	62.1	100	360	P	H
		4824	38.76	-35.24	74	60.22	31.51	9.13	62.1	100	0	P	V
802.11n HT20 CH 06 2437MHz		4875	38.4	-35.6	74	59.64	31.59	9.2	62.03	100	360	P	H
		7311	38.78	-35.22	74	52.61	34.03	11.3	59.16	100	0	P	H
		4875	35.68	-38.32	74	56.92	31.59	9.2	62.03	100	0	P	V
		7311	39.16	-34.84	74	52.99	34.03	11.3	59.16	100	360	P	V
802.11n HT20 CH 11 2462MHz		4923	35.57	-38.43	74	56.6	31.67	9.27	61.97	100	360	P	H
		7386	40.06	-33.94	74	53.6	34.29	11.29	59.12	100	0	P	H
		4923	35.11	-38.89	74	56.14	31.67	9.27	61.97	100	0	P	V
		7386	39.14	-34.86	74	52.68	34.29	11.29	59.12	100	360	P	V
Remark	1. No other spurious found. 2. All results are PASS against Peak and Average limit line.												



**2.4GHz 2400~2483.5MHz
WIFI 802.11n HT40 (Band Edge @ 3m)**

WIFI Ant. 1	Note	Frequency (MHz)	Level (dBμV/m)	Over Limit (dB)	Limit Line (dBμV/m)	Read Level (dBμV)	Antenna Factor (dB/m)	Cable Loss (dB)	Preamp Factor (dB)	Ant Pos (cm)	Table Pos (deg)	Peak Avg. (P/A)	Pol. (H/V)	
802.11n HT40 CH 03 2422MHz		2389.74	52.22	-21.78	74	56.65	27	5.59	37.02	100	328	P	H	
		2390	40.78	-13.22	54	45.21	27	5.59	37.02	100	328	A	H	
	*	2419.706	89.21	-	-	93.31	27.26	5.63	36.99	100	328	P	H	
	*	2418.036	81.52	-	-	85.78	27.13	5.61	37	100	328	A	H	
		2487.48	52.77	-21.23	74	56.38	27.64	5.69	36.94	100	328	P	H	
		2491.6	40.46	-13.54	54	43.91	27.77	5.71	36.93	100	328	A	H	
		2385.87	55.81	-18.19	74	60.24	27	5.59	37.02	140	194	P	V	
		2390	44.58	-9.42	54	49.01	27	5.59	37.02	140	194	A	V	
	*	2419.706	98.34	-	-	102.44	27.26	5.63	36.99	140	194	P	V	
	*	2425.05	90.61	-	-	94.71	27.26	5.63	36.99	140	194	A	V	
		2498.12	54.11	-19.89	74	57.56	27.77	5.71	36.93	140	194	P	V	
		2485.08	42.26	-11.74	54	45.87	27.64	5.69	36.94	140	194	A	V	
	802.11n HT40 CH 06 2437MHz		2379.75	51.41	-22.59	74	55.91	26.95	5.57	37.02	100	331	P	H
			2389.83	39.94	-14.06	54	44.37	27	5.59	37.02	100	331	A	H
*		2427.304	89.27	-	-	93.37	27.26	5.63	36.99	100	331	P	H	
*		2427.972	81.6	-	-	85.7	27.26	5.63	36.99	100	331	A	H	
		2486.2	52.54	-21.46	74	56.15	27.64	5.69	36.94	100	331	P	H	
		2487.52	40.48	-13.52	54	43.93	27.77	5.71	36.93	100	331	A	H	
		2390	52.19	-21.81	74	56.62	27	5.59	37.02	100	41	P	V	
		2356.89	41.35	-12.65	54	45.92	26.91	5.54	37.02	100	41	A	V	
*		2434.653	97.43	-	-	101.53	27.26	5.63	36.99	100	41	P	V	
*		2440.08	89.8	-	-	93.73	27.39	5.65	36.97	100	41	A	V	
		2484.52	53.8	-20.2	74	57.41	27.64	5.69	36.94	100	41	P	V	
	2483.52	42.53	-11.47	54	46.14	27.64	5.69	36.94	100	41	A	V		



802.11n HT40 CH 09 2452MHz		2380.56	50.83	-23.17	74	55.33	26.95	5.57	37.02	100	259	P	H
		2388.21	39.44	-14.56	54	43.87	27	5.59	37.02	100	259	A	H
	*	2449.683	88.39	-	-	92.32	27.39	5.65	36.97	100	259	P	H
	*	2455.11	80.8	-	-	84.58	27.51	5.67	36.96	100	259	A	H
		2488.8	51.59	-22.41	74	55.04	27.77	5.71	36.93	100	259	P	H
		2483.56	40.58	-13.42	54	44.19	27.64	5.69	36.94	100	259	A	H
		2382	51.99	-22.01	74	56.49	26.95	5.57	37.02	100	238	P	V
		2371.92	41.18	-12.82	54	45.68	26.95	5.57	37.02	100	238	A	V
	*	2449.683	97.75	-	-	101.68	27.39	5.65	36.97	100	238	P	V
	*	2449.098	89.98	-	-	93.91	27.39	5.65	36.97	100	238	A	V
		2484.56	55.02	-18.98	74	58.63	27.64	5.69	36.94	100	238	P	V
		2483.52	43.7	-10.3	54	47.31	27.64	5.69	36.94	100	238	A	V
Remark	1. No other spurious found. 2. All results are PASS against Peak and Average limit line.												



**2.4GHz 2400~2483.5MHz
WIFI 802.11n HT40 (Harmonic @ 3m)**

WIFI Ant. 1	Note	Frequency (MHz)	Level (dBμV/m)	Over Limit (dB)	Limit Line (dBμV/m)	Read Level (dBμV)	Antenna Factor (dB/m)	Cable Loss (dB)	Preamp Factor (dB)	Ant Pos (cm)	Table Pos (deg)	Peak Avg. (P/A)	Pol. (H/V)
802.11n		4845	35.11	-38.89	74	56.51	31.53	9.15	62.08	100	360	P	H
HT40		7266	39.19	-34.81	74	53.12	33.93	11.31	59.17	100	0	P	H
CH 03		4845	37.29	-36.71	74	58.69	31.53	9.15	62.08	100	0	P	V
2422MHz		7266	39.06	-34.94	74	52.99	33.93	11.31	59.17	100	360	P	V
802.11n		4875	35.88	-38.12	74	57.12	31.59	9.2	62.03	100	360	P	H
HT40		7311	40.01	-33.99	74	53.84	34.03	11.3	59.16	100	0	P	H
CH 06		4875	37.92	-36.08	74	59.16	31.59	9.2	62.03	100	0	P	V
2437MHz		7311	39.12	-34.88	74	52.95	34.03	11.3	59.16	100	360	P	V
802.11n		4905	35.25	-38.75	74	56.35	31.64	9.25	61.99	100	360	P	H
HT40		7356	39.43	-34.57	74	53.08	34.19	11.29	59.13	100	0	P	H
CH 09		4905	37.25	-36.75	74	58.35	31.64	9.25	61.99	100	0	P	V
2452MHz		7356	37.31	-36.69	74	50.96	34.19	11.29	59.13	100	360	P	V
Remark	1. No other spurious found. 2. All results are PASS against Peak and Average limit line.												



Emission below 1GHz
2.4GHz WIFI 802.11g (LF)

WIFI	Note	Frequency	Level	Over	Limit	Read	Antenna	Cable	Preamp	Ant	Table	Peak	Pol.
Ant.				Limit	Line	Level	Factor	Loss	Factor	Pos	Pos	Avg.	
1		(MHz)	(dBμV/m)	(dB)	(dBμV/m)	(dBμV)	(dB/m)	(dB)	(dB)	(cm)	(deg)	(P/A)	(H/V)
2.4GHz 802.11g LF	!	36.79	34.21	-5.79	40	49.56	16.42	0.73	32.5	-	-	P	H
		100.81	29.27	-14.23	43.5	47.24	13.11	1.22	32.3	-	-	P	H
		224	39.65	-6.35	46	58.36	11.9	1.73	32.34	-	-	P	H
	!	320.03	40.69	-5.31	46	55.5	15.26	2.2	32.27	100	307	P	H
		480.08	29.24	-16.76	46	40.79	17.94	2.74	32.23	-	-	P	H
		596.48	24.33	-21.67	46	35.75	17.31	3.06	31.79	-	-	P	H
	!	37.76	35.04	-4.96	40	51.14	15.68	0.74	32.52	100	265	P	V
		92.08	32.7	-10.8	43.5	51.7	12.18	1.16	32.34	-	-	P	V
	!	224	40.89	-5.11	46	59.6	11.9	1.73	32.34	-	-	P	V
		320.03	38.37	-7.63	46	53.18	15.26	2.2	32.27	-	-	P	V
		480.08	33.95	-12.05	46	45.5	17.94	2.74	32.23	-	-	P	V
		595.51	25.91	-20.09	46	37.31	17.33	3.06	31.79	-	-	P	V
Remark	1. No other spurious found. 2. All results are PASS against limit line.												



Antenna B

2.4GHz 2400~2483.5MHz

WIFI 802.11n(40M) (Band Edge @ 3m)

WIFI Ant.	Note	Frequency	Level	Over Limit	Limit Line	Read Level	Antenna Factor	Cable Loss	Preamp Factor	Ant Pos	Table Pos	Peak Avg.	Pol.
1		(MHz)	(dBμV/m)	(dB)	(dBμV/m)	(dBμV)	(dB/m)	(dB)	(dB)	(cm)	(deg)	(P/A)	(H/V)
802.11n (40M) CH 03 2422MHz		2388.12	51.4	-22.6	74	55.83	27	5.59	37.02	253	265	P	H
		2390	40.51	-13.49	54	44.94	27	5.59	37.02	253	265	A	H
	*	2419.79	89.74	-	-	93.84	27.26	5.63	36.99	253	265	P	H
	*	2418.537	81.97	-	-	86.23	27.13	5.61	37	253	265	A	H
		2495.96	52.43	-21.57	74	55.88	27.77	5.71	36.93	253	265	P	H
		2487.36	40.27	-13.73	54	43.88	27.64	5.69	36.94	253	265	A	H
		2388.57	57.93	-16.07	74	62.36	27	5.59	37.02	167	215	P	V
		2390	46.28	-7.72	54	50.71	27	5.59	37.02	167	215	A	V
	*	2419.623	99.85	-	-	103.95	27.26	5.63	36.99	167	215	P	V
	*	2418.454	92.05	-	-	96.31	27.13	5.61	37	167	215	A	V
		2486.8	54.85	-19.15	74	58.46	27.64	5.69	36.94	167	215	P	V
		2484.76	43.11	-10.89	54	46.72	27.64	5.69	36.94	167	215	A	V

2.4GHz 2400~2483.5MHz

WIFI 802.11n(40M) (Harmonic @ 3m)

WIFI Ant.	Note	Frequency	Level	Over Limit	Limit Line	Read Level	Antenna Factor	Cable Loss	Preamp Factor	Ant Pos	Table Pos	Peak Avg.	Pol.
1		(MHz)	(dBμV/m)	(dB)	(dBμV/m)	(dBμV)	(dB/m)	(dB)	(dB)	(cm)	(deg)	(P/A)	(H/V)
802.11n (40M) CH 03 2422MHz		4842	37.42	-36.58	74	58.82	31.53	9.15	62.08	100	123	P	H
		7266	40.91	-33.09	74	54.84	33.93	11.31	59.17	100	123	P	H
		4844	36.7	-37.3	74	58.1	31.53	9.15	62.08	100	177	P	V
		7266	40.39	-33.61	74	54.32	33.93	11.31	59.17	100	177	P	V



Note symbol

*	Fundamental Frequency which can be ignored. However, the level of any unwanted emissions shall not exceed the level of the fundamental frequency.
!	Test result is Less than 6 dB under limit line.
P/A	P eak or A verage
H/V	H orizontal or V ertical



A calculation example for radiated spurious emission is shown as below:

WIFI	Note	Frequency	Level	Over	Limit	Read	Antenna	Cable	Preamp	Ant	Table	Peak	Pol.
Ant.				Limit	Line	Level	Factor	Loss	Factor	Pos	Pos	Avg.	
1		(MHz)	(dBμV/m)	(dB)	(dBμV/m)	(dBμV)	(dB/m)	(dB)	(dB)	(cm)	(deg)	(P/A)	(H/V)
802.11b		2390	55.45	-18.55	74	54.51	32.22	4.58	35.86	103	308	P	H
CH 01													
2412MHz		2390	43.54	-10.46	54	42.6	32.22	4.58	35.86	103	308	A	H

- Level(dBμV/m) =
Antenna Factor(dB/m) + Cable Loss(dB) + Read Level(dBμV) - Preamp Factor(dB)
- Over Limit(dB) = Level(dBμV/m) – Limit Line(dBμV/m)

For Peak Limit @ 2390MHz:

- Level(dBμV/m)
= Antenna Factor(dB/m) + Cable Loss(dB) + Read Level(dBμV) - Preamp Factor(dB)
= 32.22(dB/m) + 4.58(dB) + 54.51(dBμV) – 35.86 (dB)
= 55.45 (dBμV/m)
- Over Limit(dB)
= Level(dBμV/m) – Limit Line(dBμV/m)
= 55.45(dBμV/m) – 74(dBμV/m)
= -18.55(dB)

For Average Limit @ 2390MHz:

- Level(dBμV/m)
= Antenna Factor(dB/m) + Cable Loss(dB) + Read Level(dBμV) - Preamp Factor(dB)
= 32.22(dB/m) + 4.58(dB) + 42.6(dBμV) – 35.86 (dB)
= 43.54 (dBμV/m)
- Over Limit(dB)
= Level(dBμV/m) – Limit Line(dBμV/m)
= 43.54(dBμV/m) – 54(dBμV/m)
= -10.46(dB)

Both peak and average measured complies with the limit line, so test result is “PASS”.



Appendix C. Duty Cycle Plots

Band	Duty Cycle(%)	T(ms)	1/T(kHz)	VBW Setting
802.11b	100.00	-	-	10Hz
802.11g	100.00	-	-	10Hz
2.4GHz 802.11n HT20	100.00	-	-	10Hz
2.4GHz 802.11n HT40	100.00	-	-	10Hz

802.11b

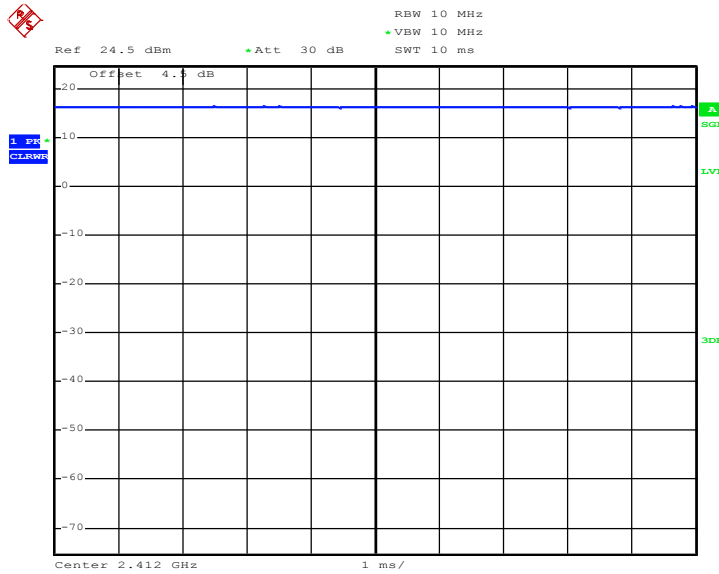

Date: 7.MAY.2016 19:27:09



802.11g

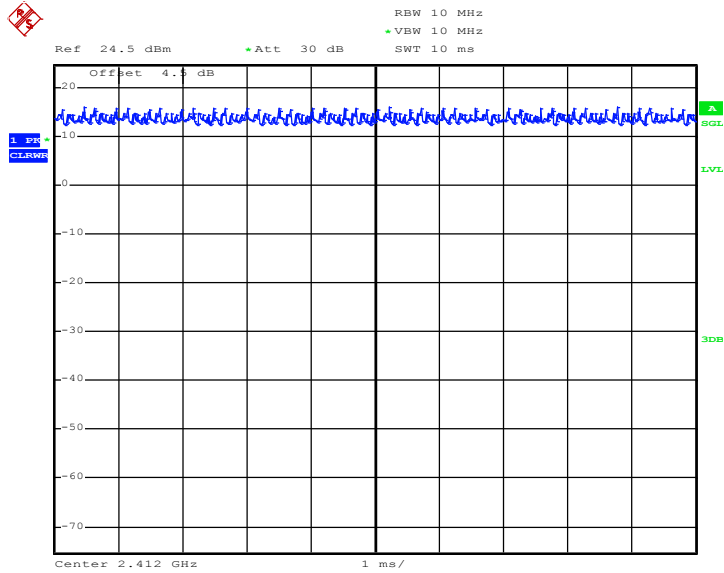

Date: 7.MAY.2016 19:58:05

802.11n HT20

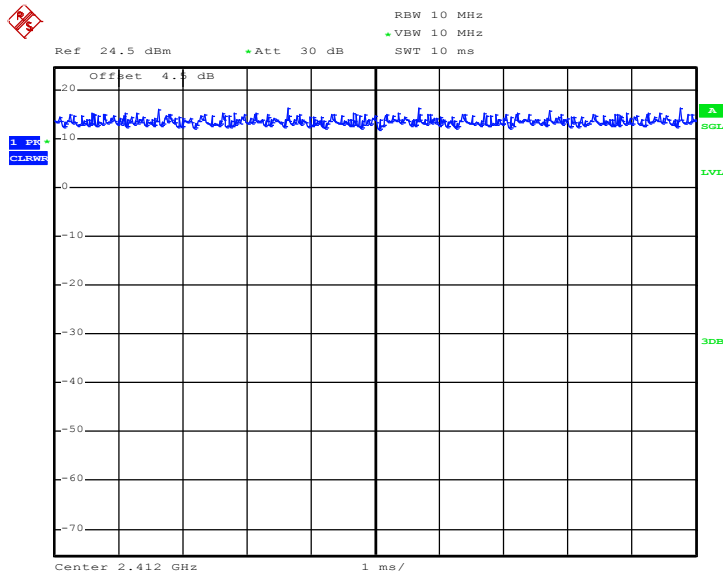

Date: 7.MAY.2016 19:42:20



802.11n HT40

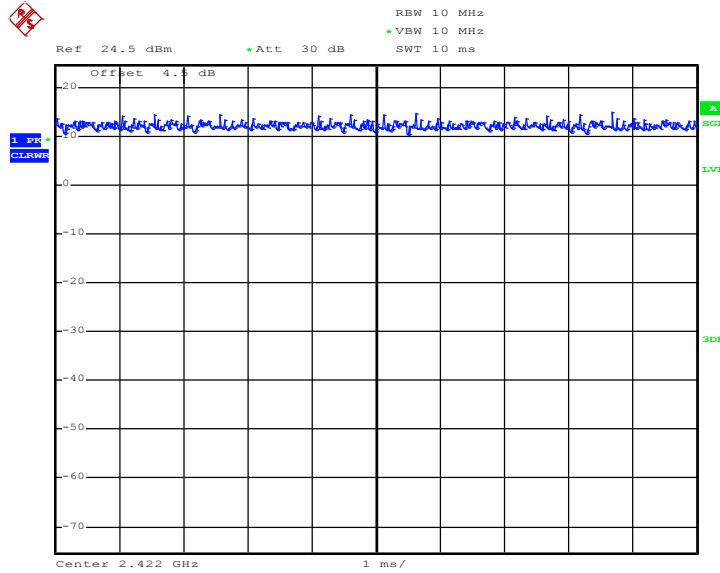

Date: 7.MAY.2016 20:07:47