

MEASUREMENT REPORT

FCC PART 15.247 / RSS-247 Bluetooth-LE

FCC ID: H8N-WH5349
IC: 1353A-WH5349
Applicant: Askey Computer Corp.

Application Type: Certification
Product: Bluetooth + Voice + IR Remote Controller
Model No.: WH-5349
Brand Name: ASKEY
FCC Classification: Digital Transmission System (DTS)
FCC Rule Part(s): Part 15 Subpart C (Section 15.247)
IC Rule(s): RSS-247 Issue 2, RSS-GEN Issue 5
Test Procedure(s): ANSI C63.10-2013, KDB 558074 D01v05r01
Test Date: February 26 ~ March 13, 2019

Reviewed By: 
(Sunny Sun)

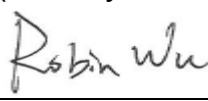
Approved By: 
(Robin Wu)



The test results relate only to the samples tested.

This equipment has been shown to be capable of compliance with the applicable technical standards as indicated in the measurement report and was tested in accordance with the measurement procedures specified in ANSI C63.10-2013. Test results reported herein relate only to the item(s) tested.

The test report shall not be reproduced except in full without the written approval of MRT Technology (Suzhou) Co., Ltd.

Revision History

Report No.	Version	Description	Issue Date	Note
1903RSU004-U1	Rev. 01	Initial Report	03-20-2019	Valid

CONTENTS

Description	Page
1. INTRODUCTION	6
1.1. Scope	6
1.2. MRT Test Location	6
2. PRODUCT INFORMATION	7
2.1. Feature of Equipment under Test	7
2.2. Working Frequencies	7
2.3. Device Capabilities	8
2.4. Test Configuration	8
2.5. EMI Suppression Device(s)/Modifications	8
2.6. Test Software	8
2.7. Labeling Requirements	9
3. DESCRIPTION OF TEST	10
3.1. Evaluation Procedure	10
3.2. AC Line Conducted Emissions	10
3.3. Radiated Emissions	11
4. ANTENNA REQUIREMENTS	12
5. TEST EQUIPMENT CALIBRATION DATE	13
6. MEASUREMENT UNCERTAINTY	14
7. TEST RESULT	15
7.1. Summary	15
7.2. 6dB Bandwidth Measurement	16
7.2.1. Test Limit	16
7.2.2. Test Procedure used	16
7.2.3. Test Setting	16
7.2.4. Test Setup	16
7.2.5. Test Result	17
7.3. Output Power Measurement	18
7.3.1. Test Limit	18
7.3.2. Test Procedure Used	18
7.3.3. Test Setting	18
7.3.4. Test Setup	19
7.3.5. Test Result of Output Power	20
7.4. Power Spectral Density Measurement	21

7.4.1.	Test Limit	21
7.4.2.	Test Procedure Used	21
7.4.3.	Test Setting	21
7.4.4.	Test Setup.....	21
7.4.5.	Test Result.....	22
7.5.	Conducted Band Edge and Out-of-Band Emissions.....	23
7.5.1.	Test Limit	23
7.5.2.	Test Procedure Used	23
7.5.3.	Test Settintg.....	23
7.5.4.	Test Setup.....	24
7.5.5.	Test Result.....	25
7.6.	Radiated Spurious Emission Measurement	28
7.6.1.	Test Limit	28
7.6.2.	Test Procedure Used	28
7.6.3.	Test Setting.....	28
7.6.4.	Test Setup.....	30
7.6.5.	Test Result.....	31
7.7.	Radiated Restricted Band Edge Measurement	36
7.7.1.	Test Limit	36
7.7.2.	Test Procedure Used	39
7.7.3.	Test Setting.....	39
7.7.4.	Test Setup.....	40
7.7.5.	Test Result.....	41
7.8.	AC Conducted Emissions Measurement.....	49
7.8.1.	Test Limit	49
7.8.2.	Test Setup.....	49
7.8.3.	Test Result.....	49
8.	CONCLUSION.....	50
	Appendix A - Test Setup Photograph	51
	Appendix B - EUT Photograph.....	52

§2.1033 General Information

Applicant:	Askey Computer Corp.
Applicant Address:	10F, No.119, JIANKANG RD., ZHONGHE DIST., NEW TAIPEI CITY, TAIWAN
Manufacturer:	Askey Computer Corp.
Manufacturer Address:	10F, No.119, JIANKANG RD., ZHONGHE DIST., NEW TAIPEI CITY, TAIWAN
Test Site:	MRT Technology (Suzhou) Co., Ltd
Test Site Address:	D8 Building, No.2 Tian'edang Rd., Wuzhong Economic Development Zone, Suzhou, China
FCC Registration No.:	893164
IC Registration No.:	11384A-1
Test Device Serial No.:	N/A <input type="checkbox"/> Production <input checked="" type="checkbox"/> Pre-Production <input type="checkbox"/> Engineering

Test Facility / Accreditations

Measurements were performed at MRT Laboratory located in Tian'edang Rd., Suzhou, China.

- MRT facility is a FCC registered (MRT Reg. No. 893164) test facility with the site description report on file and has met all the requirements specified in ANSI C63.4-2014.
- MRT facility is an IC registered (MRT Reg. No. 11384A-1) test laboratory with the site description on file at Industry Canada.
- MRT facility is a VCCI registered (R-20025, G-20034, C-20020, T-20020) test laboratory with the site description on file at VCCI Council.
- MRT Lab is accredited to ISO 17025 by the American Association for Laboratory Accreditation (A2LA) under the American Association for Laboratory Accreditation Program (A2LA Cert. No. 3628.01) in EMC, Telecommunications, Radio and SAR testing.



1. INTRODUCTION

1.1. Scope

Measurement and determination of electromagnetic emissions (EMC) of radio frequency devices including intentional and/or unintentional radiators for compliance with the technical rules and regulations of the Federal Communications Commission and the Industry Canada Certification and Engineering Bureau.

1.2. MRT Test Location

The map below shows the location of the MRT LABORATORY, its proximity to the Taihu Lake. These measurement tests were conducted at the MRT Technology (Suzhou) Co., Ltd. Facility located at D8 Building, No.2 Tian'edang Rd., Wuzhong Economic Development Zone, Suzhou, China. The measurement facility compliant with the test site requirements specified in ANSI C63.4-2014.

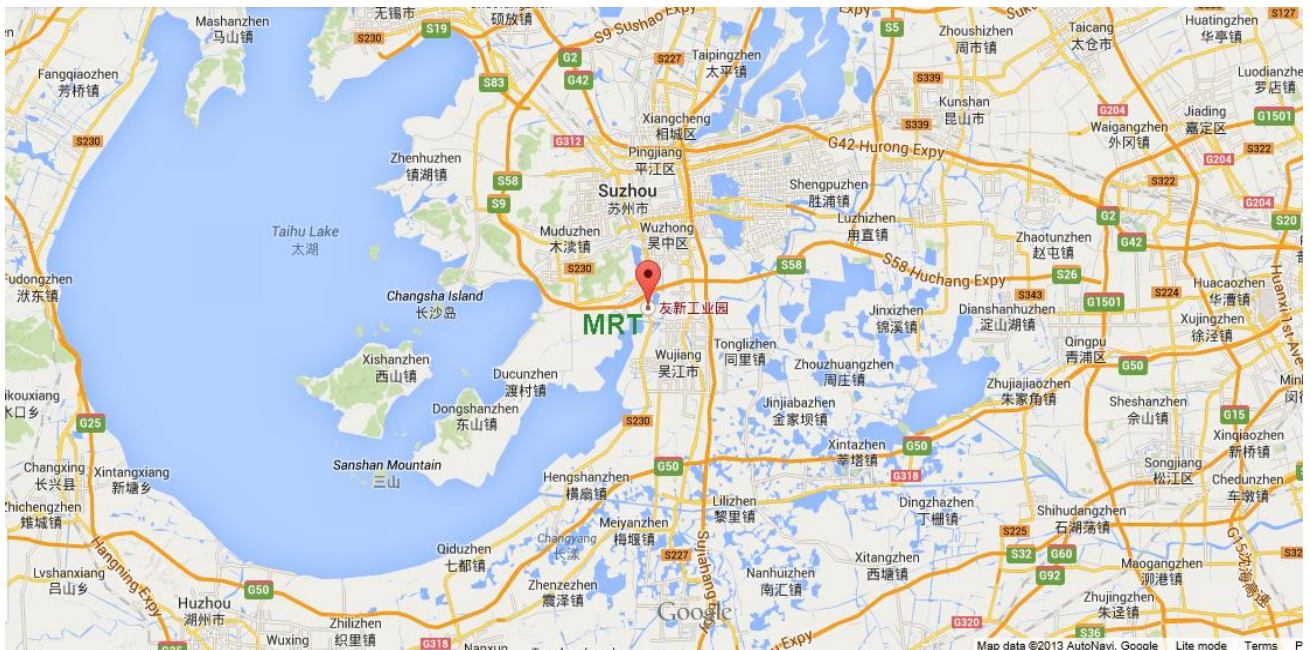

2. PRODUCT INFORMATION

2.1. Feature of Equipment under Test

Product Name:	Bluetooth + Voice + IR Remote Controller
Model No.:	WH-5349
Brand Name:	ASKEY
Bluetooth Specification:	v4.2 (BLE only)
Bluetooth Frequency:	2402~2480MHz
Data Rate:	1Mbps
Antenna Information:	PCB Antenna, 1.92dBi
Power Type:	By Battery

2.2. Working Frequencies

Channel	Frequency	Channel	Frequency	Channel	Frequency
00	2402 MHz	01	2404 MHz	02	2406 MHz
03	2408 MHz	04	2410 MHz	05	2412 MHz
06	2414 MHz	07	2416 MHz	08	2418 MHz
09	2420 MHz	10	2422 MHz	11	2424 MHz
12	2426 MHz	13	2428 MHz	14	2430 MHz
15	2432 MHz	16	2434 MHz	17	2436 MHz
18	2438 MHz	19	2440 MHz	20	2442 MHz
21	2444 MHz	22	2446 MHz	23	2448 MHz
24	2450 MHz	25	2452 MHz	26	2454 MHz
27	2456 MHz	28	2458 MHz	29	2460 MHz
30	2462 MHz	31	2464 MHz	32	2466 MHz
33	2468 MHz	34	2470 MHz	35	2472 MHz
36	2474 MHz	37	2476 MHz	38	2478 MHz
39	2480 MHz	--	--	--	--

2.3. Device Capabilities

This device contains the following capabilities:

Bluetooth LE only

Note: The maximum achievable duty cycles was determined based on measurements performed on a spectrum analyzer in zero-span mode with RBW = 8MHz, VBW = 50MHz. The RBW and VBW were both greater than 50/T, where T is the minimum transmission duration, and the number of sweep points across T was greater than 100. The duty cycles are as follows:

Test Mode	Duty Cycle
BLE	100.0%

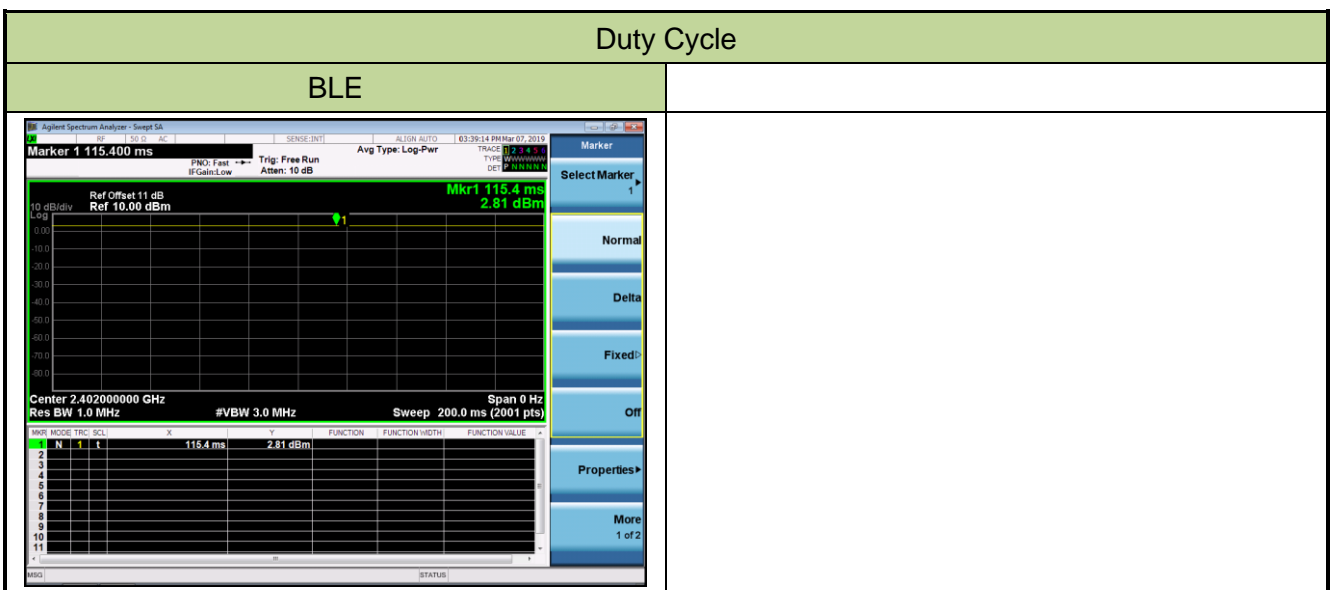

2.4. Test Configuration

The device was tested per the guidance of KDB 558074 D01v05r01. ANSI C63.10-2013 was used to reference the appropriate EUT setup for radiated spurious emissions testing and AC line conducted testing.

2.5. EMI Suppression Device(s)/Modifications

No EMI suppression device(s) were added and/or no modifications were made during testing.

2.6. Test Software

The EUTs used during the test are specially set samples provided by the customer

2.7. Labeling Requirements

Per 2.1074 & 15.19; Docket 95-19

The label shall be permanently affixed at a conspicuous location on the device; instruction manual or pamphlet supplied to the user and be readily visible to the purchaser at the time of purchase.

However, when the device is so small wherein placement of the label with specified statement is not practical, only the FCC ID must be displayed on the device per Section 15.19(a)(5). Please see attachment for FCC ID label and label location.

RSP-100 Issue 11 Section 3

The manufacturer, importer or distributor shall meet the labelling requirements set out in this section for every unit:

(i) prior to marketing in Canada, for products manufactured in Canada

(ii) prior to importation into Canada, for imported products

For information regarding the e-labelling option, see Notice 2014-DRS1003. The label for the certified product represents the manufacturer's or importer's compliance with Innovation, Science and Economic Development Canada's (ISED) regulatory requirements.

Please see attachment for IC label and label location.

3. DESCRIPTION OF TEST

3.1. Evaluation Procedure

The measurement procedures described in the American National Standard for Testing Unlicensed Wireless Devices (ANSI C63.10-2013), and the guidance provided in KDB 558074 D01v05r01 were used in the measurement.

Deviation from measurement procedure.....None

3.2. AC Line Conducted Emissions

The line-conducted facility is located inside an 8'x4'x4' shielded enclosure. A 1m x 2m wooden table 80cm high is placed 40cm away from the vertical wall and 80cm away from the sidewall of the shielded room. Two 10kHz-30MHz, 50Ω/50uH Line-Impedance Stabilization Networks (LISNs) are bonded to the shielded room floor. Power to the LISNs is filtered by external high-current high-insertion loss power line filters. These filters attenuate ambient signal noise from entering the measurement lines. These filters are also bonded to the shielded enclosure.

The EUT is powered from one LISN and the support equipment is powered from the second LISN. All interconnecting cables more than 1 meter were shortened to a 1 meter length by non-inductive bundling (serpentine fashion) and draped over the back edge of the test table. All cables were at least 40cm above the horizontal reference ground-plane. Power cables for support equipment were routed down to the second LISN while ensuring that that cables were not draped over the second LISN.

Sufficient time for the EUT, support equipment, and test equipment was allowed in order for them to warm up to their normal operating condition. The RF output of the LISN was connected to the receiver and exploratory measurements were made to determine the frequencies producing the maximum emission from the EUT. The receiver was scanned from 150kHz to 30MHz. The detector function was set to peak mode for exploratory measurements while the bandwidth of the analyzer was set to 9kHz. The EUT, support equipment, and interconnecting cables were arranged and manipulated to maximize each emission. Each emission was also maximized by varying: power lines, the mode of operation or data exchange speed, or support equipment whichever determined the worst-case emission. Once the worst case emissions have been identified, the one EUT cable configuration/arrangement and mode of operation that produced these emissions were used for final measurements on the same test site. The analyzer is set to CISPR quasi-peak and average detectors with a 9kHz resolution bandwidth for final measurements.

An extension cord was used to connect to a single LISN which powered by EUT. The extension cord was calibrated with LISN, the impedance and insertion loss are compliance with the requirements as stated in ANSI C63.10-2013.

3.3. Radiated Emissions

The radiated test facilities consisted of an indoor 3 meter semi-anechoic chamber used for final measurements and exploratory measurements, when necessary. The measurement area is contained within the semi-anechoic chamber which is shielded from any ambient interference. For measurements above 1GHz absorbers are arranged on the floor between the turn table and the Antenna mast in such a way so as to maximize the reduction of reflections. For measurements below 1GHz, the absorbers are removed. A MF Model 210SS turntable is used for radiated measurement. It is a continuously rotatable, remote controlled, metallic turntable and 2 meters (6.56 ft.) in diameter. The turn table is flush with the raised floor of the chamber in order to maintain its function as a ground plane. An 80cm high PVC support structure is placed on top of the turntable. For all measurements, the spectrum was scanned through all EUT azimuths and from 1 to 4 meter receive Antenna height using a broadband Antenna from 30MHz up to the upper frequency shown in 15.33(b)(1) depending on the highest frequency generated or used in the device or on which the device operates or tunes. For frequencies above 1GHz, linearly polarized double ridge horn Antennas were used. For frequencies below 30MHz, a calibrated loop Antenna was used. When exploratory measurements were necessary, they were performed at 1 meter test distance inside the semi-anechoic chamber using broadband Antennas, broadband amplifiers, and spectrum analyzers to determine the frequencies and modes producing the maximum emissions. Sufficient time for the EUT, support equipment, and test equipment was allowed in order for them to warm up to their normal operating condition. The test set-up for frequencies below 1GHz was placed on top of the 0.8 meter high, 1 x 1.5 meter table; and test set-up for frequencies 1-40GHz was placed on top of the 1.5 meter high, 1 x 1.5 meter table. The EUT, support equipment, and interconnecting cables were arranged and manipulated to maximize each emission. Appropriate precaution was taken to ensure that all emissions from the EUT were maximized and investigated. The system configuration, clock speed, mode of operation or video resolution, if applicable, turntable azimuth, and receive Antenna height was noted for each frequency found.

Final measurements were made in the semi-anechoic chamber using calibrated, linearly polarized broadband and horn Antennas. The test setup was configured to the setup that produced the worst case emissions. The spectrum analyzer was set to investigate all frequencies required for testing to compare the highest radiated disturbances with respect to the specified limits. The turntable containing the EUT was rotated through 360 degrees and the height of the receive Antenna was varied 1 to 4 meters and stopped at the azimuth and height producing the maximum emission. Each emission was maximized by changing the orientation of the EUT through three orthogonal planes and changing the polarity of the receive Antenna, whichever produced the worst-case emissions. According to 3dB Beam-Width of horn Antenna, the horn Antenna should be always directed to the EUT when rising height.

4. ANTENNA REQUIREMENTS

Excerpt from §15.203 of the FCC Rules/Regulations:

“An intentional radiator antenna shall be designed to ensure that no antenna other than that furnished by the responsible party can be used with the device. The use of a permanently attached antenna or of an antenna that uses a unique coupling to the intentional radiator shall be considered sufficient to comply with the provisions of this section.”

- The antenna of the **Bluetooth + Voice + IR Remote Controller** is **permanently attached**.
- There are no provisions for connection to an external antenna.

Conclusion:

The unit complies with the requirement of §15.203.

5. TEST EQUIPMENT CALIBRATION DATE

Conducted Emissions - SR2

Instrument	Manufacturer	Type No.	Asset No.	Cali. Interval	Cali. Due Date
EMI Test Receiver	R&S	ESR7	MRTSUE06001	1 year	2019/04/20
Two-Line V-Network	R&S	ENV216	MRTSUE06002	1 year	2019/06/15
Two-Line V-Network	R&S	ENV216	MRTSUE06003	1 year	2019/06/15
Thermohygrometer	Testo	608-H1	MRTSUE06404	1 year	2019/08/15
Shielding Anechoic Chamber	Mikebang	Chamber-SR2	MRTSUE06215	N/A	N/A

Radiated Disturbance - AC1

Instrument	Manufacturer	Type No.	Asset No.	Cali. Interval	Cali. Due Date
MXE EMI Receiver	Agilent	N9038A	MRTSUE06125	1 year	2019/08/14
PXA Signal Analyzer	Keysight	9030B	MRTSUE06395	1 year	2019/09/05
Loop Antenna	Schwarzbeck	FMZB1519	MRTSUE06025	1 year	2019/11/09
Bilog Period Antenna	Schwarzbeck	VULB 9168	MRTSUE06172	1 year	2019/04/12
Broad Band Horn Antenna	Schwarzbeck	BBHA9120D	MRTSUE06023	1 year	2019/10/20
Microwave System Amplifier	Agilent	83017A	MRTSUE06076	1 year	2019/11/16
Broad Band Horn Antenna	Schwarzbeck	BBHA 9170	MRTSUE06024	1 year	2019/12/17
Preamplifier	Schwarzbeck	BBV 9721	MRTSUE06121	1 year	2019/06/12
Thermohygrometer	Testo	608-H1	MRTSUE06403	1 year	2019/08/15
Anechoic Chamber	TDK	Chamber-AC1	MRTSUE06212	1 year	2019/05/02

Conducted Test Equipment - TR3

Instrument	Manufacturer	Type No.	Asset No.	Cali. Interval	Cali. Due Date
Spectrum Analyzer	Agilent	N9020A	MRTSUE06106	1 year	2019/04/20
EXA Signal Analyzer	Keysight	N9010B	MRTSUE06457	1 year	2019/07/18
Power Meter	Agilent	U2021XA	MRTSUE06030	1 year	2019/11/16
Thermohygrometer	Testo	608-H1	MRTSUE06401	1 year	2019/08/15

Software	Version	Function
e3	V8.3.5	EMI Test Software

6. MEASUREMENT UNCERTAINTY

Where relevant, the following test uncertainty levels have been estimated for tests performed on the EUT as specified in CISPR 16-4-2. This uncertainty represents an expanded uncertainty expressed at approximately the 95% confidence level using a coverage factor of $k = 2$.

AC Conducted Emission Measurement - SR2
Measuring Uncertainty for a Level of Confidence of 95% ($U=2Uc(y)$): 150kHz~30MHz: 3.46dB
Radiated Emission Measurement - AC1
Measuring Uncertainty for a Level of Confidence of 95% ($U=2Uc(y)$): 9kHz ~ 1GHz: 4.18dB 1GHz ~ 25GHz: 4.76dB

7. TEST RESULT

7.1. Summary

Company Name: Askey Computer Corp.

FCC ID: H8N-WH5349

IC: 1353A-WH5349

FCC Section(s)	IC Section(s)	Test Description	Test Limit	Test Condition	Test Result	Reference
15.247(a)(2)	RSS-247 [5.2]	6dB Bandwidth	$\geq 500\text{kHz}$	Conducted	Pass	Section 7.2
15.247(b)(3)	RSS-247 [5.4(4)]	Output Power	$\leq 30\text{dBm}$		Pass	Section 7.3
15.247(e)	RSS-247 [5.2]	Power Spectral Density	$\leq 8\text{dBm}/3\text{kHz}$		Pass	Section 7.4
15.247(d)	RSS-247 [5.5]	Band Edge / Out-of-Band Emissions	$\leq 20\text{dBc(Peak)}$		Pass	Section 7.5
15.205 15.209	RSS-247 [5.5]	General Field Strength Limits (Restricted Bands and Radiated Emission Limits)	Emissions in restricted bands must meet the radiated limits detailed in 15.209	Radiated	Pass	Section 7.6 & 7.7
15.207	RSS-Gen [8.8]	AC Conducted Emissions 150kHz - 30MHz	< FCC 15.207 limits	Line Conducted	Pass	Section 7.8

Notes:

- 1) The analyzer plots shown in this section were all taken with a correction table loaded into the analyzer. The correction table was used to account for the losses of the cables and attenuators used as part of the system to connect the EUT to the analyzer at all frequencies of interest.
- 2) All modes of operation and data rates were investigated. For radiated emission test, every axis (X, Y, Z) was also verified. The test results shown in the following sections represent the worst case emissions.

7.2. 6dB Bandwidth Measurement

7.2.1. Test Limit

The minimum 6dB bandwidth shall be at least 500 kHz.

7.2.2. Test Procedure used

ANSI C63.10-2013 - Section 11.8.2 Option 2

7.2.3. Test Setting

1. The Spectrum's automatic bandwidth measurement capability was used to perform the 6dB bandwidth measurement. The "X" dB bandwidth parameter was set to $X = 6$. The bandwidth measurement was not influenced by any intermediate power nulls in the fundamental emission.
2. Set RBW = 100 kHz
3. VBW $\geq 3 \times$ RBW
4. Detector = Peak
5. Trace mode = max hold
6. Sweep = auto couple
7. Allow the trace was allowed to stabilize

7.2.4. Test Setup

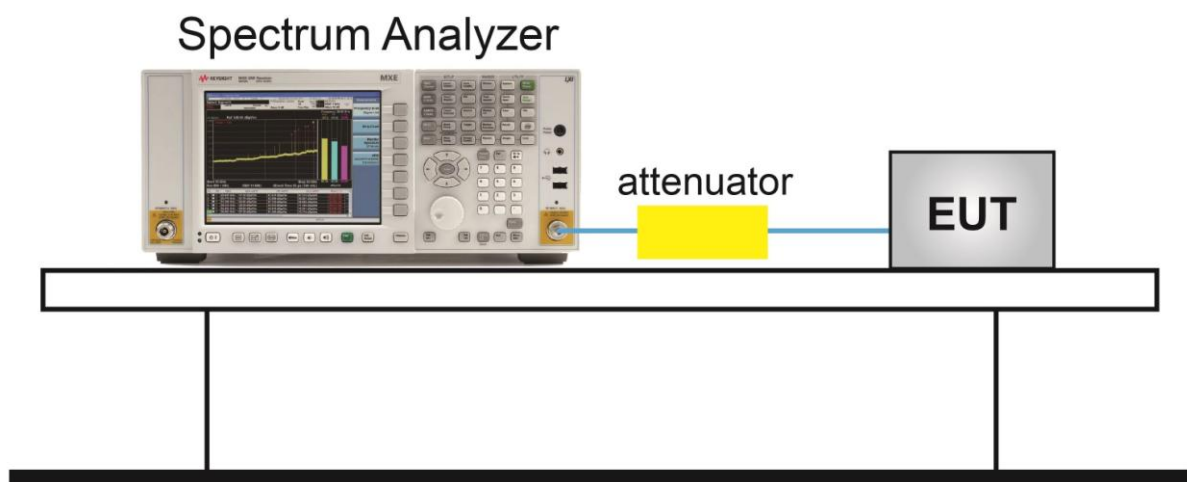

7.2.5. Test Result

Product	Bluetooth + Voice + IR Remote Controller	Temperature	25°C
Test Engineer	Snake Ni	Relative Humidity	54%
Test Site	TR3	Test Date	2019/03/07

Test Mode	Data Rate (Mbps)	Channel No.	Frequency (MHz)	6dB Bandwidth (MHz)	99% Bandwidth (MHz)	Limit (MHz)	Result
BLE	1	00	2402	0.69	1.04	≥ 0.5	Pass
BLE	1	19	2440	0.73	1.07	≥ 0.5	Pass
BLE	1	39	2480	0.69	1.05	≥ 0.5	Pass

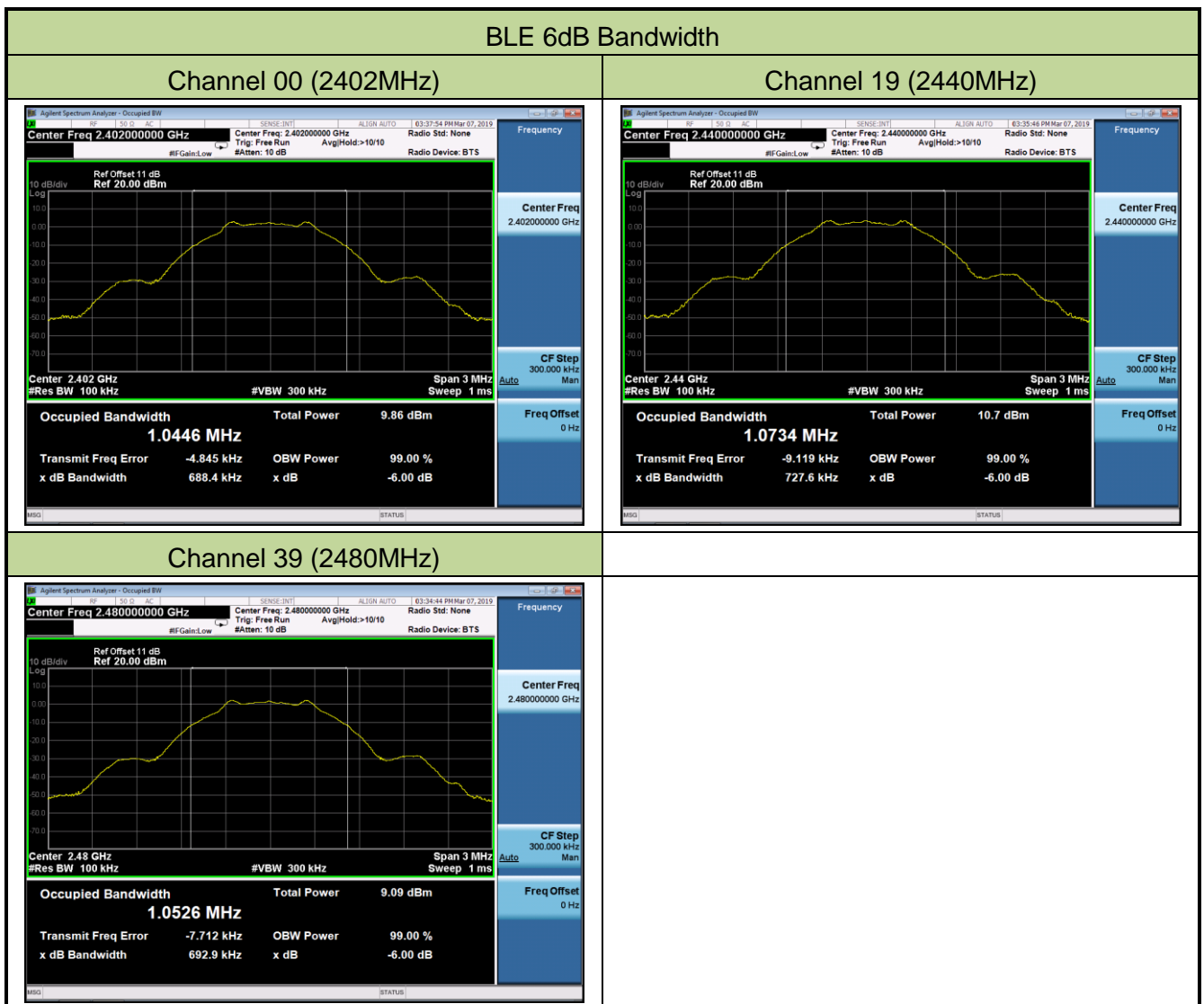

7.3. Output Power Measurement

7.3.1. Test Limit

The maximum out power shall be less 1 Watt (30dBm) and the E.I.R.P shall not exceed 4 Watt (36dBm).

7.3.2. Test Procedure Used

ANSI C63.10-2013 - Section 11.9.2.3

7.3.3. Test Setting

Method PKPM1 (Peak Power Measurement of Signals with DTS BW \leq 50MHz)

Peak power measurements were performed only when the EUT was transmitting at its maximum power control level using a broadband power meter with a pulse sensor. The pulse sensor employs a VBW = 50MHz so this method was only used for signals whose DTS bandwidth was less than or equal to 50MHz.

Method AVGP-M (Measurement using a gated RF average-reading power meter)

Measurements may be performed using a wideband gated RF power meter provided that the gate parameters are adjusted such that the power is measured only when the EUT is transmitting at its maximum power control level. Since this measurement is made only during the ON time of the transmitter, no duty cycle correction is required.

7.3.4. Test Setup

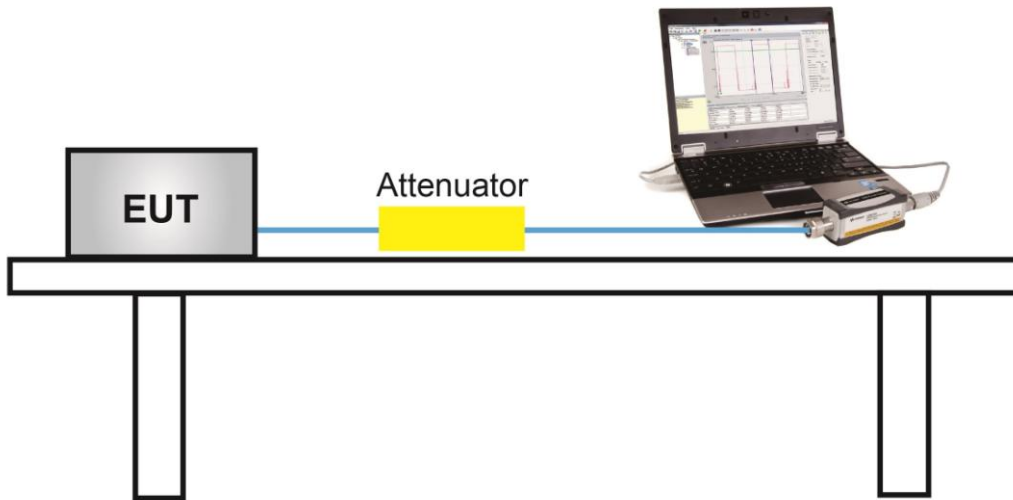

7.3.5. Test Result of Output Power

Product	Bluetooth + Voice + IR Remote Controller	Temperature	25°C
Test Engineer	Snake Ni	Relative Humidity	54%
Test Site	TR3	Test Date	2019/03/07
Test Item	Peak Output Power		

Test Mode	Data Rate (Mbps)	Channel No.	Frequency (MHz)	Peak Power (dBm)	Limit (dBm)	E.I.R.P (dBm)	E.I.R.P Limit (dBm)	Result
BLE	1	00	2402	3.23	≤ 30.00	5.15	≤ 36.00	Pass
BLE	1	19	2440	3.80	≤ 30.00	5.72	≤ 36.00	Pass
BLE	1	39	2480	3.11	≤ 30.00	5.03	≤ 36.00	Pass

Note: E.I.R.P (dBm) = Peak Power (dBm) + Antenna Gain (dBi), Antenna Gain = 1.92dBi.

Product	Bluetooth + Voice + IR Remote Controller	Temperature	25°C
Test Engineer	Snake Ni	Relative Humidity	54%
Test Site	TR3	Test Date	2019/03/07
Test Item	Average Output Power		

Test Mode	Data Rate (Mbps)	Channel No.	Frequency (MHz)	Average Power (dBm)	Limit (dBm)	E.I.R.P (dBm)	E.I.R.P Limit (dBm)	Result
BLE	1	00	2402	3.14	≤ 30.00	5.06	≤ 36.00	Pass
BLE	1	19	2440	3.65	≤ 30.00	5.57	≤ 36.00	Pass
BLE	1	39	2480	2.80	≤ 30.00	4.72	≤ 36.00	Pass

Note: E.I.R.P (dBm) = Average Power (dBm) + Antenna Gain (dBi), Antenna Gain = 1.92dBi.

7.4. Power Spectral Density Measurement

7.4.1. Test Limit

The maximum permissible power spectral density is 8dBm in any 3 kHz band.

7.4.2. Test Procedure Used

ANSI C63.10 Section 11.10.2

7.4.3. Test Setting

1. Analyzer was set to the center frequency of the DTS channel under investigation
2. Span = 1.5 times the DTS channel bandwidth
3. RBW = 3kHz
4. VBW = 10kHz
5. Detector = peak
6. Sweep time = auto couple
7. Trace mode = max hold
8. Trace was allowed to stabilize

7.4.4. Test Setup

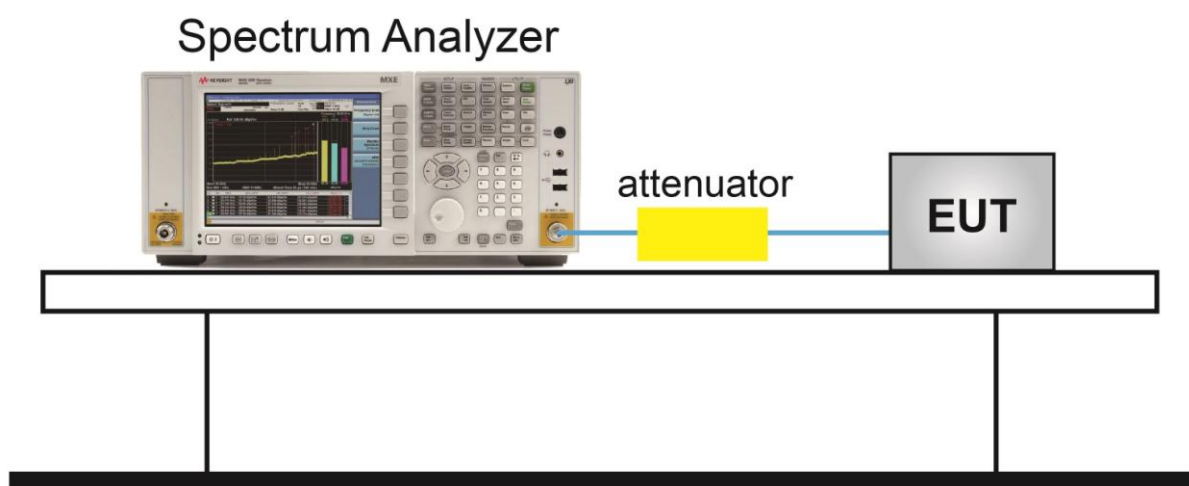

7.4.5. Test Result

Product	Bluetooth + Voice + IR Remote Controller	Temperature	25°C
Test Engineer	Snake Ni	Relative Humidity	54%
Test Site	TR3	Test Date	2019/03/07

Test Mode	Data Rate (Mbps)	Channel No.	Frequency (MHz)	PSD Result (dBm / 3kHz)	Limit (dBm / 3kHz)	Result
BLE	1	00	2402	-8.56	≤ 8.00	Pass
BLE	1	19	2440	-8.34	≤ 8.00	Pass
BLE	1	39	2480	-8.61	≤ 8.00	Pass

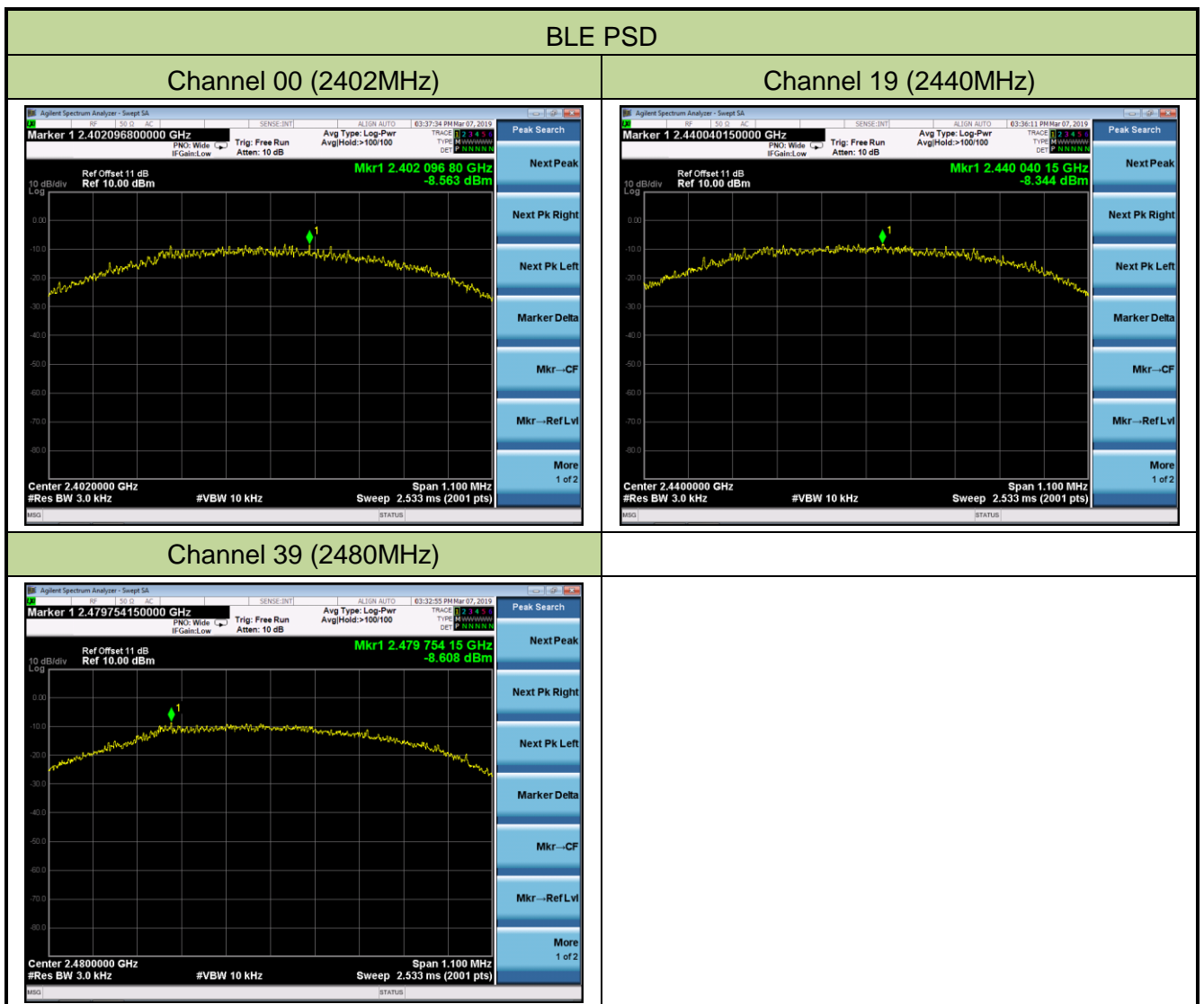

7.5. Conducted Band Edge and Out-of-Band Emissions

7.5.1. Test Limit

The limit for out-of-band spurious emissions at the band edge is 20dB below the fundamental emission level, as determined from the in-band power measurement of the DTS channel performed in a 100kHz bandwidth per the PSD procedure.

7.5.2. Test Procedure Used

ANSI C63.10 Section 11.11

7.5.3. Test Setting

Reference level measurement

1. Set instrument center frequency to DTS channel center frequency
2. Set the span to ≥ 1.5 times the DTS bandwidth
3. Set the RBW = 100 kHz
4. Set the VBW $\geq 3 \times$ RBW
5. Detector = peak
6. Sweep time = auto couple
7. Trace mode = max hold
8. Allow trace to fully stabilize

Emission level measurement

1. Set the center frequency and span to encompass frequency range to be measured
2. RBW = 100kHz
3. VBW = 300kHz
4. Detector = Peak
5. Trace mode = max hold
6. Sweep time = auto couple
7. The trace was allowed to stabilize

Test Notes

1. RBW was set to 1.3MHz rather than 100kHz in order to increase the measurement speed.
2. The display line shown in the following plots denotes the limit at 20dB below the fundamental emission level measured in a 100kHz bandwidth. However, since the traces in the following plots are measured with a 1.3MHz RBW, the display line may not necessarily appear to be 20dB below the level of the fundamental in a 1.3MHz bandwidth.
3. For plots showing conducted spurious emissions near the limit, the frequencies were investigated with a reduced RBW to ensure that no emissions were present.

7.5.4. Test Setup

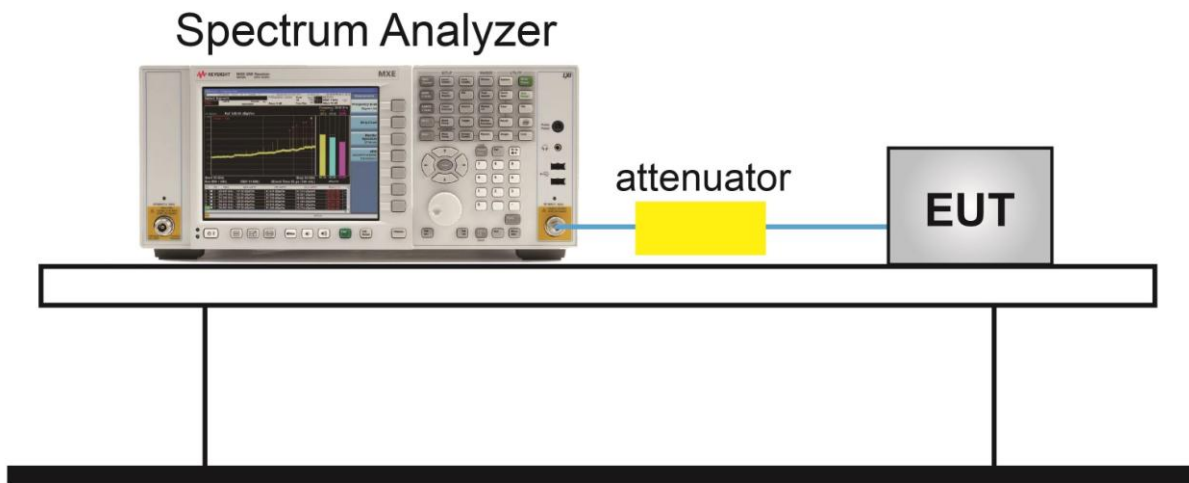

7.5.5. Test Result

Product	Bluetooth + Voice + IR Remote Controller	Temperature	25°C
Test Engineer	Snake Ni	Relative Humidity	54%
Test Site	TR3	Test Date	2019/03/07

Test Mode	Data Rate (Mbps)	Channel No.	Frequency (MHz)	Limit	Result
BLE	1	00	2402	20dBc	Pass
BLE	1	19	2440	20dBc	Pass
BLE	1	39	2480	20dBc	Pass

BLE Out-of-Band Emissions

Channel 00 (2402MHz)

100kHz PSD reference Level



Low Band Edge

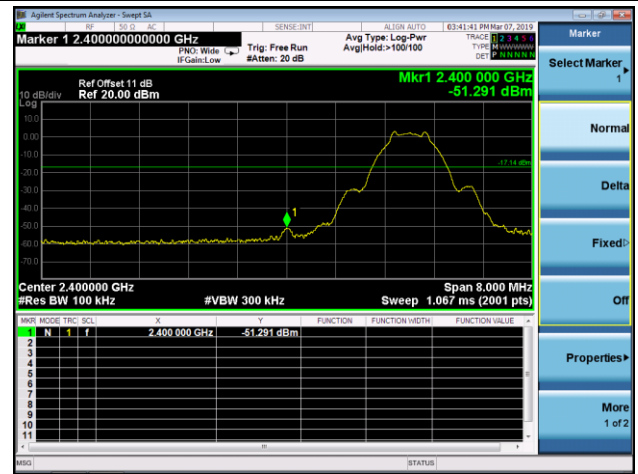

Spurious Emission 30MHz ~ 25GHz

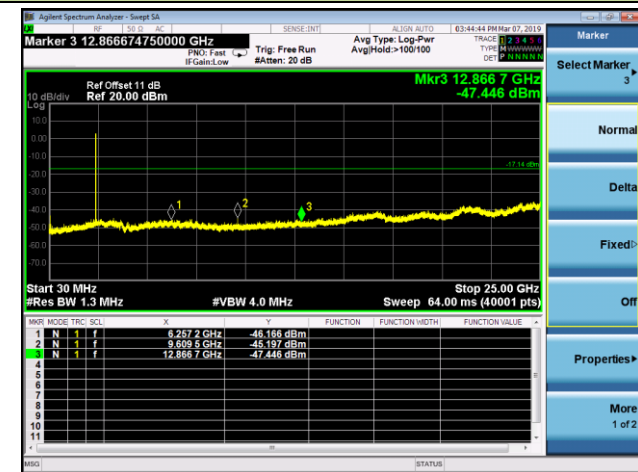

Channel 19 (2440MHz)

100kHz PSD reference Level



Spurious Emission 30MHz ~ 25GHz

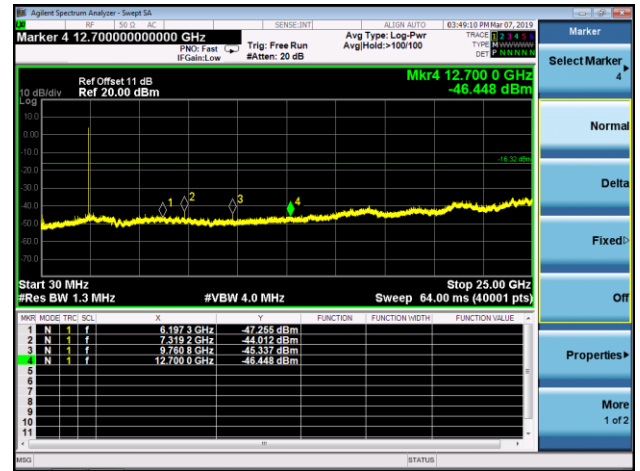

Channel 39 (2480MHz)

100kHz PSD reference Level

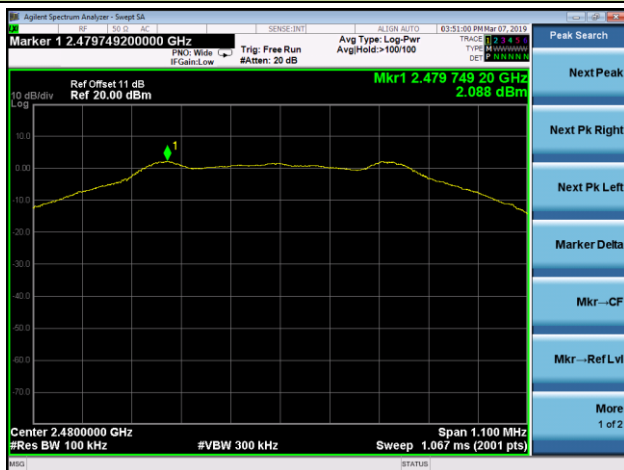

High Band Edge

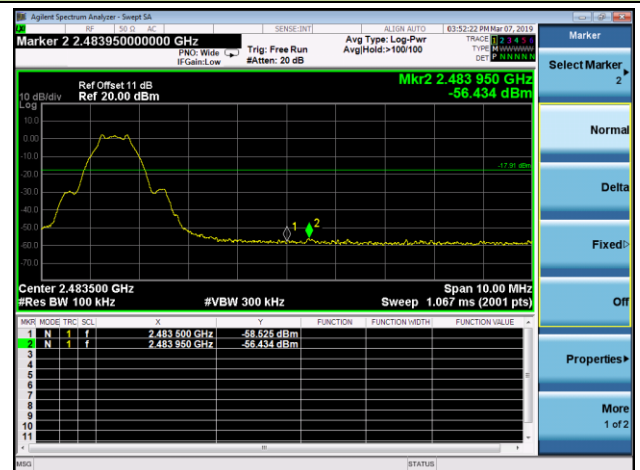

Spurious Emission 30MHz ~ 25GHz

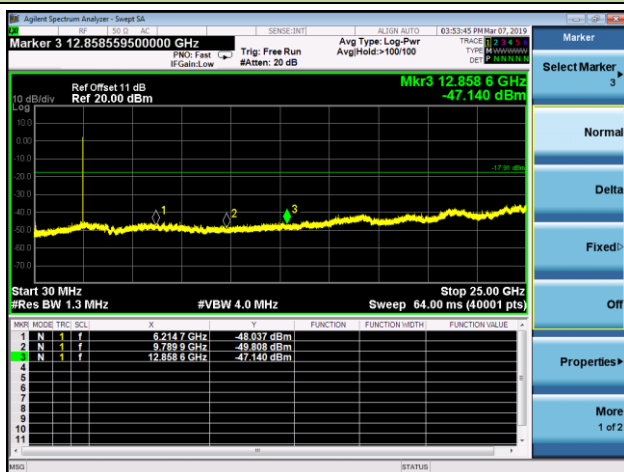

7.6. Radiated Spurious Emission Measurement

7.6.1. Test Limit

All out of band emissions appearing in a restricted band as specified in Section 15.205 of the Title 47 CFR must not exceed the limits shown in Table per Section 15.209.

FCC Part 15 Subpart C Paragraph 15.209		
Frequency [MHz]	Field Strength [V/m]	Measured Distance [Meters]
0.009 - 0.490	2400/F (kHz)	300
0.490 - 1.705	24000/F (kHz)	30
1.705 - 30	30	30
30 - 88	100	3
88 - 216	150	3
216 - 960	200	3
Above 960	500	3

7.6.2. Test Procedure Used

ANSI C63.10 Section 6.3 (General Requirements)

ANSI C63.10 Section 6.4 (Standard test method below 30MHz)

ANSI C63.10 Section 6.5 (Standard test method above 30MHz to 1GHz)

ANSI C63.10 Section 6.6 (Standard test method above 1GHz)

7.6.3. Test Setting

Peak Field Strength Measurements

1. Analyzer center frequency was set to the frequency of the radiated spurious emission of interest
2. RBW = as specified in Table 1
3. VBW = 3MHz
4. Detector = peak
5. Sweep time = auto couple
6. Trace mode = max hold
7. Trace was allowed to stabilize

Table 1 - RBW as a function of frequency

Frequency	RBW
9 ~ 150 kHz	200 ~ 300 Hz
0.15 ~ 30 MHz	9 ~ 10 kHz
30 ~ 1000 MHz	100 ~ 120 kHz
> 1000 MHz	1 MHz

Average Field Strength Measurements

1. Analyzer center frequency was set to the frequency of the radiated spurious emission of interest
2. RBW = 1MHz
3. VBW $\geq 1/T$
4. De As an alternative, the instrument may be set to linear detector mode. Ensure that video filtering is applied in linear voltage domain (rather than in a log or dB domain). Some instruments require linear display mode in order to accomplish this. Others have a setting for Average-VBW Type, which can be set to "Voltage" regardless of the display mode
5. Detector = Peak
6. Sweep time = auto
7. Trace mode = max hold
8. Allow max hold to run for at least 50 times (1/duty cycle) traces

7.6.4. Test Setup

30MHz ~ 1GHz Test Setup:

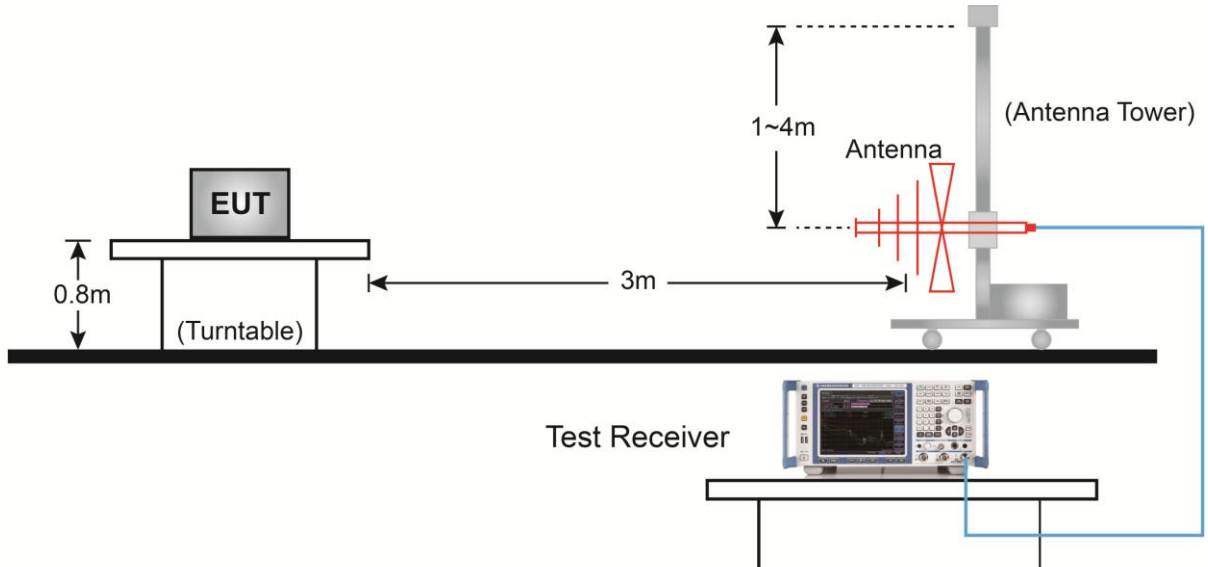

1GHz ~ 18GHz Test Setup:

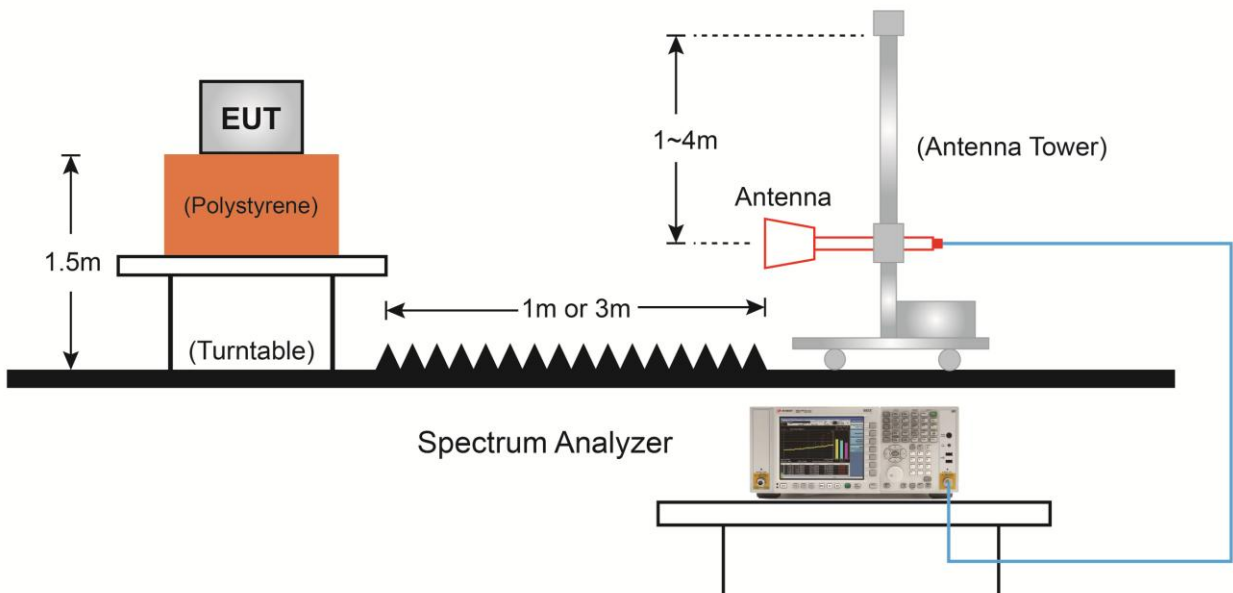

7.6.5. Test Result

Product	Bluetooth + Voice + IR Remote Controller	Temperature	25°C
Test Engineer	Messiah Li	Relative Humidity	56%
Test Site	AC1	Test Date	2019/03/07
Test Mode	BLE	Test Channel	00
Remark:	1. Average measurement was not performed if peak level lower than average limit (54dBμV/m). 2. Other frequency was 20dB below limit line within 1-18GHz, there is not show in the report.		

Mark	Frequency (MHz)	Reading Level (dBμV)	Factor (dB)	Measure Level (dBμV/m)	Limit (dBμV/m)	Margin (dB)	Detector	Polarization
	3788.0	38.6	2.7	41.3	74.0	-32.7	Peak	Horizontal
	4799.5	45.3	5.8	51.1	74.0	-22.9	Peak	Horizontal
*	7205.0	39.1	12.6	51.7	78.9	-27.2	Peak	Horizontal
*	9610.5	38.3	15.3	53.6	78.9	-25.3	Peak	Horizontal
	3822.0	38.3	2.8	41.1	74.0	-32.9	Peak	Vertical
	4808.0	38.8	5.9	44.7	74.0	-29.3	Peak	Vertical
*	6508.0	37.1	9.9	47.0	78.9	-31.9	Peak	Vertical
*	10061.0	35.0	16.9	51.9	78.9	-27.0	Peak	Vertical

Note 1: "*" is not in restricted band, its limit is 20dBc of the fundamental emission level (98.9dBμV/m) or 15.209 which is higher.

Note 2: Measure Level (dBμV/m) = Reading Level (dBμV) + Factor (dB)

Factor (dB) = Cable Loss (dB) + Antenna Factor (dB/m) - Pre_Amplifier Gain (dB)

Product	Bluetooth + Voice + IR Remote Controller	Temperature	25°C
Test Engineer	Messiah Li	Relative Humidity	56%
Test Site	AC1	Test Date	2019/03/07
Test Mode	BLE	Test Channel	19
Remark:	1. Average measurement was not performed if peak level lower than average limit (54dBμV/m). 2. Other frequency was 20dB below limit line within 1-18GHz, there is not show in the report.		

Mark	Frequency (MHz)	Reading Level (dBμV)	Factor (dB)	Measure Level (dBμV/m)	Limit (dBμV/m)	Margin (dB)	Detector	Polarization
	4876.0	44.3	6.0	50.3	74.0	-23.7	Peak	Horizontal
	7315.5	38.3	12.6	50.9	74.0	-23.1	Peak	Horizontal
*	8845.5	35.3	13.3	48.6	80.8	-32.2	Peak	Horizontal
*	9763.5	36.3	16.2	52.5	80.8	-28.3	Peak	Horizontal
	3643.5	38.6	2.1	40.7	74.0	-33.3	Peak	Vertical
	4876.0	38.5	6.0	44.5	74.0	-29.5	Peak	Vertical
*	6516.5	35.8	9.9	45.7	80.8	-35.1	Peak	Vertical
*	9763.5	35.5	16.2	51.7	80.8	-29.1	Peak	Vertical

Note 1: "*" is not in restricted band, its limit is 20dBc of the fundamental emission level (100.8dBμV/m) or 15.209 which is higher.

Note 2: Measure Level (dBμV/m) = Reading Level (dBμV) + Factor (dB)

Factor (dB) = Cable Loss (dB) + Antenna Factor (dB/m) - Pre_Amplifier Gain (dB)

Product	Bluetooth + Voice + IR Remote Controller	Temperature	25°C
Test Engineer	Messiah Li	Relative Humidity	56%
Test Site	AC1	Test Date	2019/03/07
Test Mode	BLE	Test Channel	39
Remark:	1. Average measurement was not performed if peak level lower than average limit (54dBμV/m). 2. Other frequency was 20dB below limit line within 1-18GHz, there is not show in the report.		

Mark	Frequency (MHz)	Reading Level (dBμV)	Factor (dB)	Measure Level (dBμV/m)	Limit (dBμV/m)	Margin (dB)	Detector	Polarization
	4034.5	37.7	3.4	41.1	74.0	-32.9	Peak	Horizontal
	4961.0	44.0	6.1	50.1	74.0	-23.9	Peak	Horizontal
*	6261.5	36.3	8.6	44.9	81.3	-36.4	Peak	Horizontal
*	9916.5	35.0	16.6	51.6	81.3	-29.7	Peak	Horizontal
	4357.5	37.4	4.3	41.7	74.0	-32.3	Peak	Vertical
	4961.0	40.4	6.1	46.5	74.0	-27.5	Peak	Vertical
*	6287.0	36.5	8.7	45.2	81.3	-36.1	Peak	Vertical
*	8012.5	37.0	13.7	50.7	81.3	-30.6	Peak	Vertical

Note 1: "*" is not in restricted band, its limit is 20dBc of the fundamental emission level (101.3dBμV/m) or 15.209 which is higher.

Note 2: Measure Level (dBμV/m) = Reading Level (dBμV) + Factor (dB)

Factor (dB) = Cable Loss (dB) + Antenna Factor (dB/m) - Pre_Amplifier Gain (dB)

The worst case of Radiated Emission below 1GHz:

Site: AC1	Time: 2019/03/18 - 17:01
Limit: FCC_Part15.209_RSE(3m)	Engineer: Messiah Li
Probe: VULB 9168 _20-2000MHz	Polarity: Horizontal
EUT: Bluetooth + Voice + IR Remote Controller	Power: AC 120V/60Hz

Worst Case Mode: There is the worst case within frequency range 30MHz~1GHz.

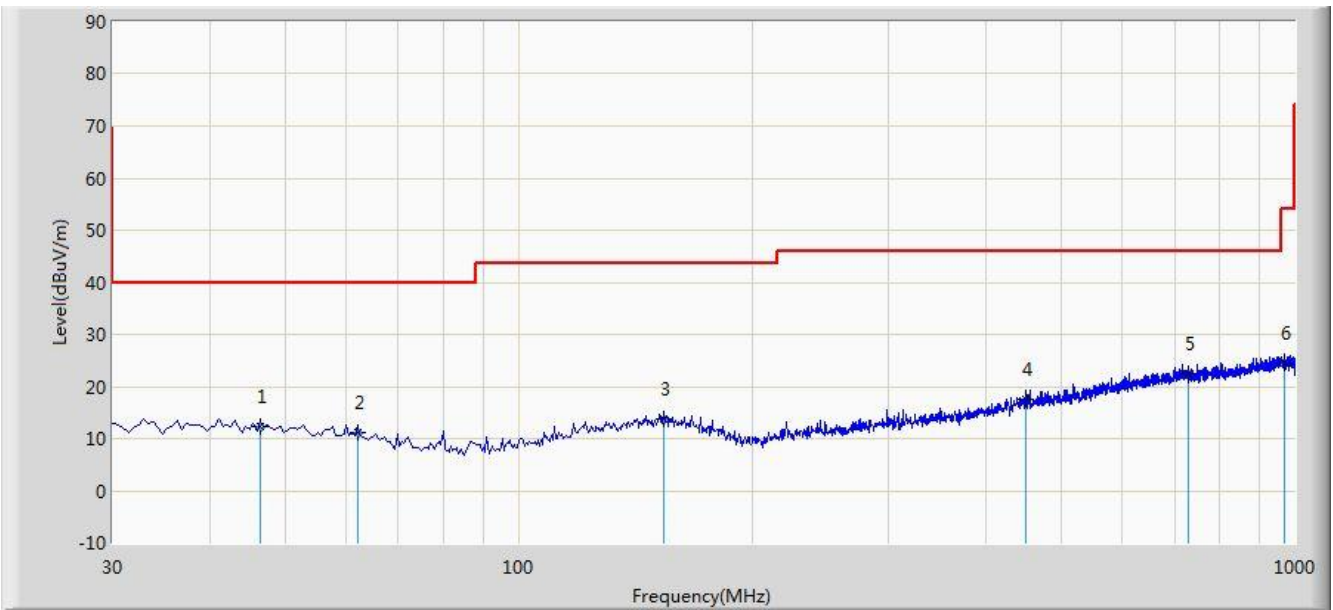

No	Flag	Mark	Frequency (MHz)	Measure Level (dBuV/m)	Reading Level (dBuV)	Over Limit (dB)	Limit (dBuV/m)	Factor (dB)	Type
1			46.490	12.270	-2.040	-27.730	40.000	14.310	QP
2			62.010	11.222	-1.930	-28.778	40.000	13.152	QP
3			153.675	13.782	-1.620	-29.718	43.500	15.402	QP
4			450.980	17.594	-0.500	-28.406	46.000	18.093	QP
5		*	727.920	22.447	-0.390	-23.553	46.000	22.837	QP
6			968.475	24.543	-0.850	-29.457	54.000	25.393	QP

Note 1: Measure Level (dBuV/m) = Reading Level (dBuV) + Factor (dB)

Factor (dB) = Cable Loss (dB) + Antenna Factor (dB/m)

Note 2: The test trace is same as the ambient noise and the amplitude of the emissions are attenuated more than 20dB below the permissible (the test frequency range: 9kHz ~ 30MHz, 18GHz ~ 25GHz), therefore no data appear in the report.

Site: AC1	Time: 2019/03/18 - 17:02
Limit: FCC_Part15.209_RSE(3m)	Engineer: Messiah Li
Probe: VULB 9168 _20-2000MHz	Polarity: Vertical
EUT: Bluetooth + Voice + IR Remote Controller	Power: AC 120V/60Hz

Worst Case Mode: There is the worst case within frequency range 30MHz~1GHz.

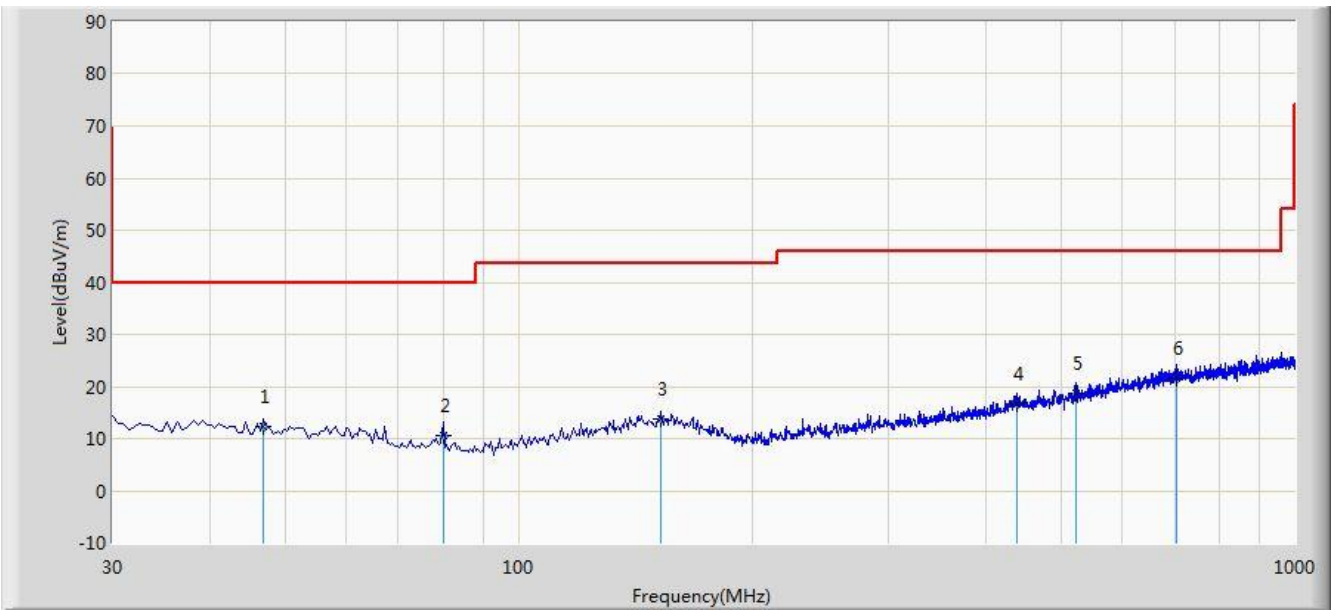

No	Flag	Mark	Frequency (MHz)	Measure Level (dBuV/m)	Reading Level (dBuV)	Over Limit (dB)	Limit (dBuV/m)	Factor (dB)	Type
1			46.975	12.435	-1.860	-27.565	40.000	14.295	QP
2			79.955	10.654	0.390	-29.346	40.000	10.264	QP
3			152.220	13.771	-1.630	-29.729	43.500	15.401	QP
4			438.855	16.550	-1.240	-29.450	46.000	17.790	QP
5			523.730	18.676	-0.710	-27.324	46.000	19.386	QP
6		*	704.640	21.650	-0.840	-24.350	46.000	22.490	QP

Note 1: Measure Level (dBuV/m) = Reading Level (dBuV) + Factor (dB)

Factor (dB) = Cable Loss (dB) + Antenna Factor (dB/m)

Note 2: The test trace is same as the ambient noise and the amplitude of the emissions are attenuated more than 20dB below the permissible (the test frequency range: 9kHz ~ 30MHz, 18GHz ~ 25GHz), therefore no data appear in the report.

7.7. Radiated Restricted Band Edge Measurement

7.7.1. Test Limit

For 15.205 requirement:

Radiated emissions which fall in the restricted bands, as defined in Section 15.205(a) of FCC part 15, must also comply with the radiated emission limits specified in Section 15.209(a).

Frequency (MHz)	Frequency (MHz)	Frequency (MHz)	Frequency (GHz)
0.090 - 0.110	16.42 - 16.423	399.9 - 410	4.5 - 5.15
¹ 0.495 - 0.505	16.69475 - 16.69525	608 - 614	5.35 - 5.46
2.1735 - 2.1905	16.80425 - 16.80475	960 - 1240	7.25 - 7.75
4.125 - 4.128	25.5 - 25.67	1300 - 1427	8.025 - 8.5
4.17725 - 4.17775	37.5 - 38.25	1435 - 1626.5	9.0 - 9.2
4.20725 - 4.20775	73 - 74.6	1645.5 - 1646.5	9.3 - 9.5
6.215 - 6.218	74.8 - 75.2	1660 - 1710	10.6 - 12.7
6.26775 - 6.26825	108 - 121.94	1718.8 - 1722.2	13.25 - 13.4
6.31175 - 6.31225	123 - 138	2200 - 2300	14.47 - 14.5
8.291 - 8.294	149.9 - 150.05	2310 - 2390	15.35 - 16.2
8.362 - 8.366	156.52475 - 156.525	2483.5 - 2500	17.7 - 21.4
8.37625 - 8.38675	156.7 - 156.9	2690 - 2900	22.01 - 23.12
8.41425 - 8.41475	162.0125 - 167.17	3260 - 3267	23.6 - 24.0
12.29 - 12.293	167.72 - 173.2	3332 - 3339	31.2 - 31.8
12.51975 - 12.52025	240 - 285	3345.8 - 3358	36.43 - 36.5
12.57675 - 12.57725	322 - 335.4	3600 - 4400	(²)
13.36 - 13.41	--	--	--

All out of band emissions appearing in a restricted band as specified in Section 15.205 of the Title 47CFR must not exceed the limits shown in Table per Section 15.209.

FCC Part 15 Subpart C Paragraph 15.209		
Frequency [MHz]	Field Strength [uV/m]	Measured Distance [Meters]
0.009 - 0.490	2400/F (kHz)	300
0.490 - 1.705	24000/F (kHz)	30
1.705 - 30	30	30
30 - 88	100	3
88 - 216	150	3
216 - 960	200	3
Above 960	500	3

For RSS-Gen Section 8.10 requirement:

Radiated emissions which fall in the restricted bands, as defined in Section 8.10 of RSS-Gen, must also comply with the radiated emission limits specified in Section 8.9.

Frequency (MHz)	Frequency (MHz)	Frequency (GHz)
0.009 - 0.110	240 - 285	9.0 - 9.2
2.1735 - 2.1905	322 - 335.4	9.3 - 9.5
3.020 - 3.026	399.9 - 410	10.6 - 12.7
4.125 - 4.128	608 - 614	13.25 - 13.4
4.17725 - 4.17775	960 - 1427	14.47 - 14.5
4.20725 - 4.20775	1435 - 1626.5	15.35 - 16.2
5.677 - 5.683	1645.5 - 1646.5	17.7 - 21.4
6.215 - 6.218	1660 - 1710	22.01 - 23.12
6.26775 - 6.26825	1718.8 - 1722.2	23.6 - 24.0
6.31175 - 6.31225	2200 - 2300	31.2 - 31.8
8.291 - 8.294	2310 - 2390	36.43 - 36.5
8.362 - 8.366	2655 - 2900	Above 38.6
8.37625 - 8.38675	3260 - 3267	--
8.41425 - 8.41475	3332 - 3339	
12.29 - 12.293	334.5 - 3358	
12.51975 - 12.52025	3500 - 4400	
12.57675 - 12.57725	4500 - 5150	
13.36 - 13.41	5350 - 5460	
16.42 - 16.423	7250 - 7750	
16.69475 - 16.69525	8025 - 8500	
16.80425 - 16.80475	--	
25.5 - 25.67		
37.5 - 38.25		
73 - 74.6		
74.8 - 75.2		
108 - 138		
156.52475 - 156.525225		
156.7 - 156.9		

All out of band emissions appearing in a restricted band as specified in Section 8.10 of the RSS-Gen must not exceed the limits shown in Table per Section 8.9.

RSS-Gen Section 8.9		
Frequency [MHz]	Field Strength [uV/m]	Measured Distance [Meters]
0.009 - 0.490	2400/F (kHz)	300
0.490 - 1.705	24000/F (kHz)	30
1.705 - 30	30	30
30 - 88	100	3
88 - 216	150	3
216 - 960	200	3
Above 960	500	3

7.7.2. Test Procedure Used

ANSI C63.10 Section 6.3 (General Requirements)

ANSI C63.10 Section 6.6 (Standard test method above 1GHz)

7.7.3. Test Setting

Peak Field Strength Measurements

1. Analyzer center frequency was set to the frequency of the radiated spurious emission of interest
2. RBW = 1MHz
3. VBW = 3MHz
4. Detector = peak
5. Sweep time = auto couple
6. Trace mode = max hold
7. Trace was allowed to stabilize

Average Field Strength Measurements

1. Analyzer center frequency was set to the frequency of the radiated spurious emission of interest
2. RBW = 1MHz
3. VBW $\geq 1/T$
4. De As an alternative, the instrument may be set to linear detector mode. Ensure that video filtering is applied in linear voltage domain (rather than in a log or dB domain). Some instruments require linear display mode in order to accomplish this. Others have a setting for Average-VBW Type, which can be set to "Voltage" regardless of the display mode
5. Detector = Peak
6. Sweep time = auto
7. Trace mode = max hold
8. Allow max hold to run for at least 50 times (1/duty cycle) traces

7.7.4. Test Setup

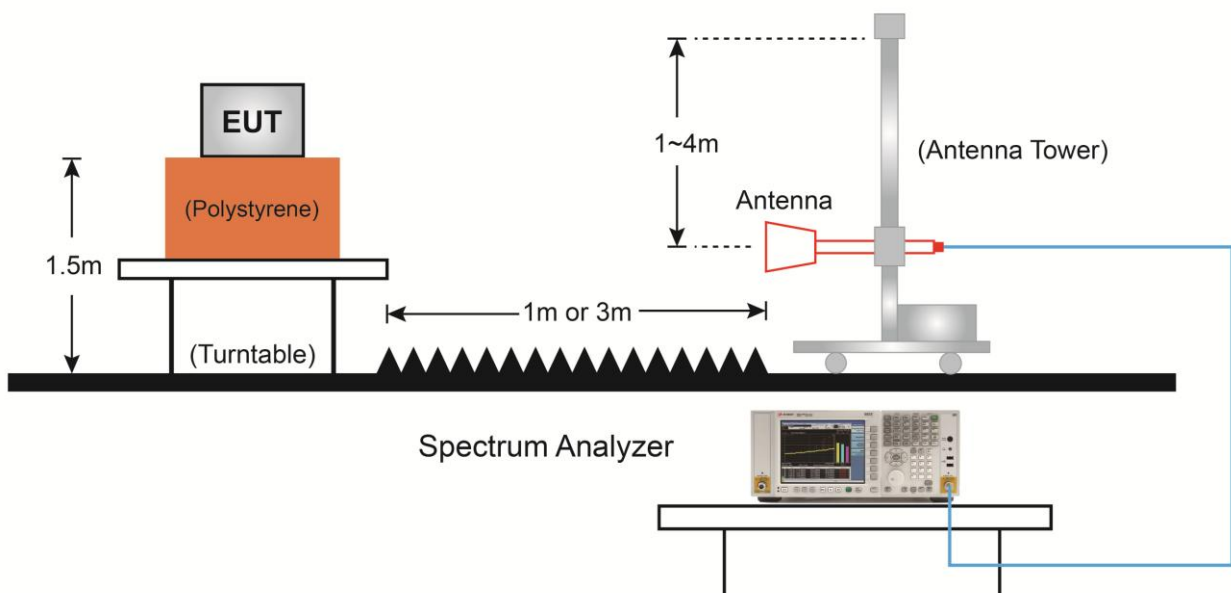

7.7.5. Test Result

Site: AC1	Time: 2019/03/06 - 06:46
Limit: FCC_Part15.209_RE(3m)	Engineer: Messiah Li
Probe: BBHA9120D_1-18GHz	Polarity: Horizontal
EUT: Bluetooth + Voice + IR Remote Controller	Power: By Battery
Test Mode: Transmit by Bluetooth-BLE at channel 2402MHz	

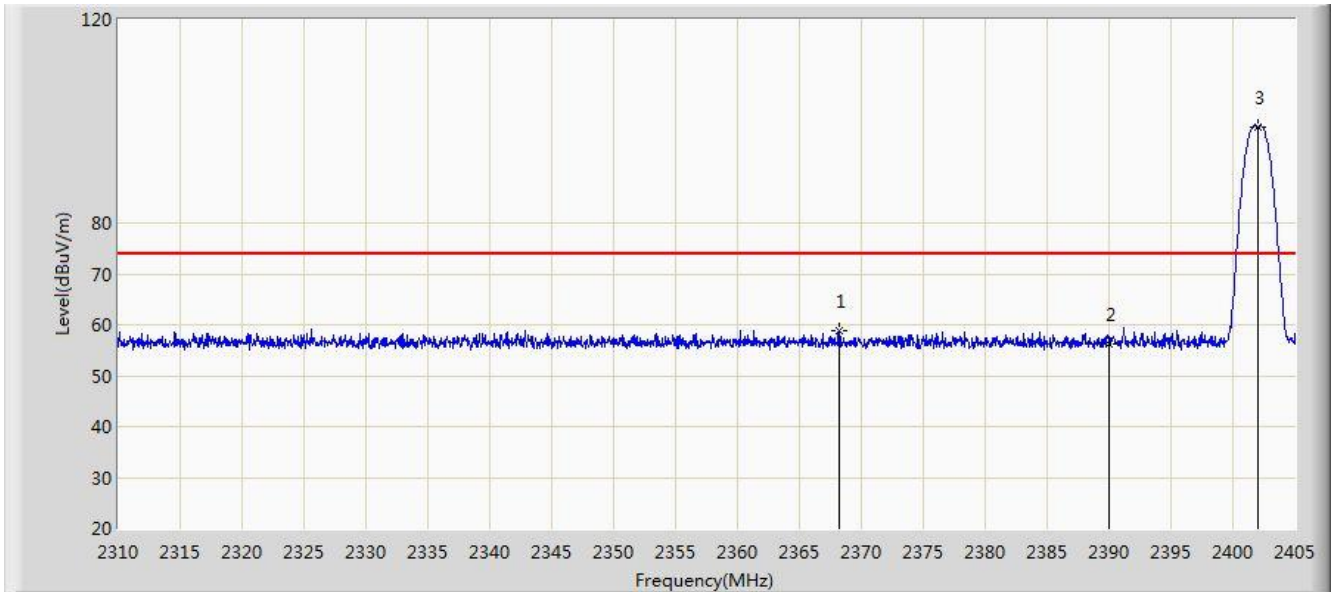

No	Flag	Mark	Frequency (MHz)	Measure Level (dBuV/m)	Reading Level (dBuV)	Over Limit (dB)	Limit (dBuV/m)	Factor (dB)	Type
1			2368.187	58.727	26.366	-15.273	74.000	32.361	PK
2			2390.000	56.374	24.047	-17.626	74.000	32.327	PK
3		*	2402.008	98.908	66.604	N/A	N/A	32.305	PK

Note: Measure Level (dB μ V/m) = Reading Level (dB μ V) + Factor (dB)

Factor (dB) = Cable Loss (dB) + Antenna Factor (dB/m).

Site: AC1	Time: 2019/03/06 - 06:47
Limit: FCC_Part15.209_RE(3m)	Engineer: Messiah Li
Probe: BBHA9120D_1-18GHz	Polarity: Horizontal
EUT: Bluetooth + Voice + IR Remote Controller	Power: By Battery
Test Mode: Transmit by Bluetooth-BLE at channel 2402MHz	

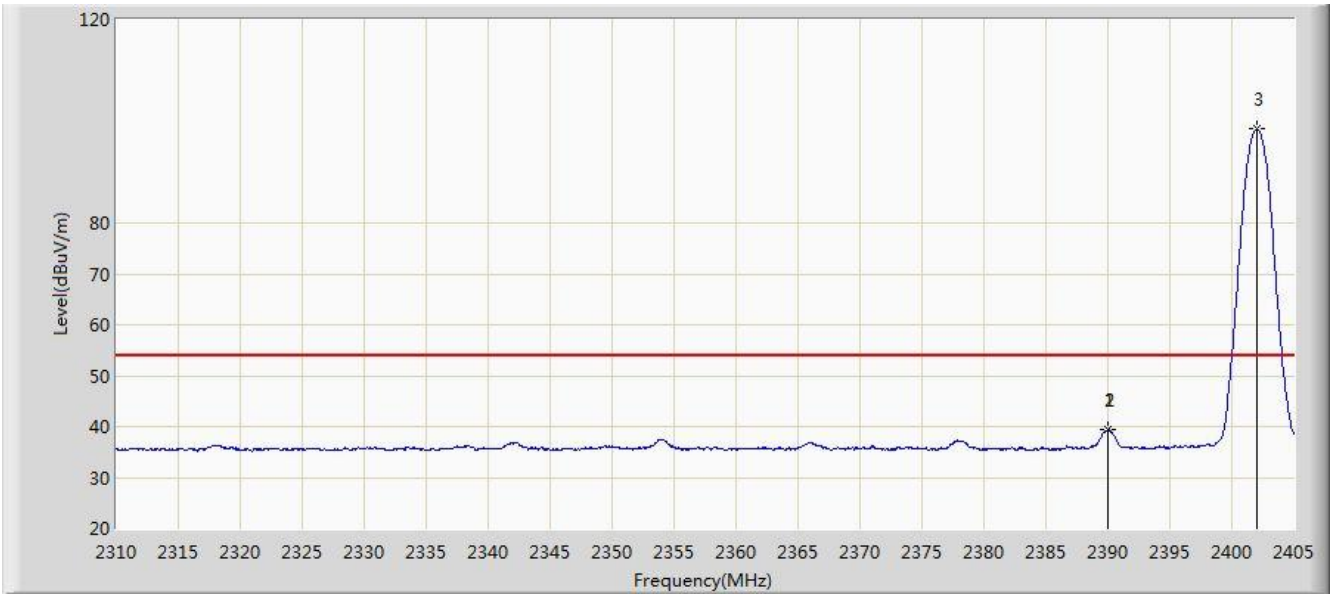

No	Flag	Mark	Frequency (MHz)	Measure Level (dBuV/m)	Reading Level (dBuV)	Over Limit (dB)	Limit (dBuV/m)	Factor (dB)	Type
1			2389.990	39.412	7.085	-14.588	54.000	32.327	AV
2			2390.000	39.406	7.079	-14.594	54.000	32.327	AV
3		*	2402.008	98.432	66.128	N/A	N/A	32.305	AV

Note: Measure Level (dB μ V/m) = Reading Level (dB μ V) + Factor (dB)

Factor (dB) = Cable Loss (dB) + Antenna Factor (dB/m).

Site: AC1	Time: 2019/03/06 - 06:49
Limit: FCC_Part15.209_RE(3m)	Engineer: Messiah Li
Probe: BBHA9120D_1-18GHz	Polarity: Vertical
EUT: Bluetooth + Voice + IR Remote Controller	Power: By Battery
Test Mode: Transmit by Bluetooth-BLE at channel 2402MHz	

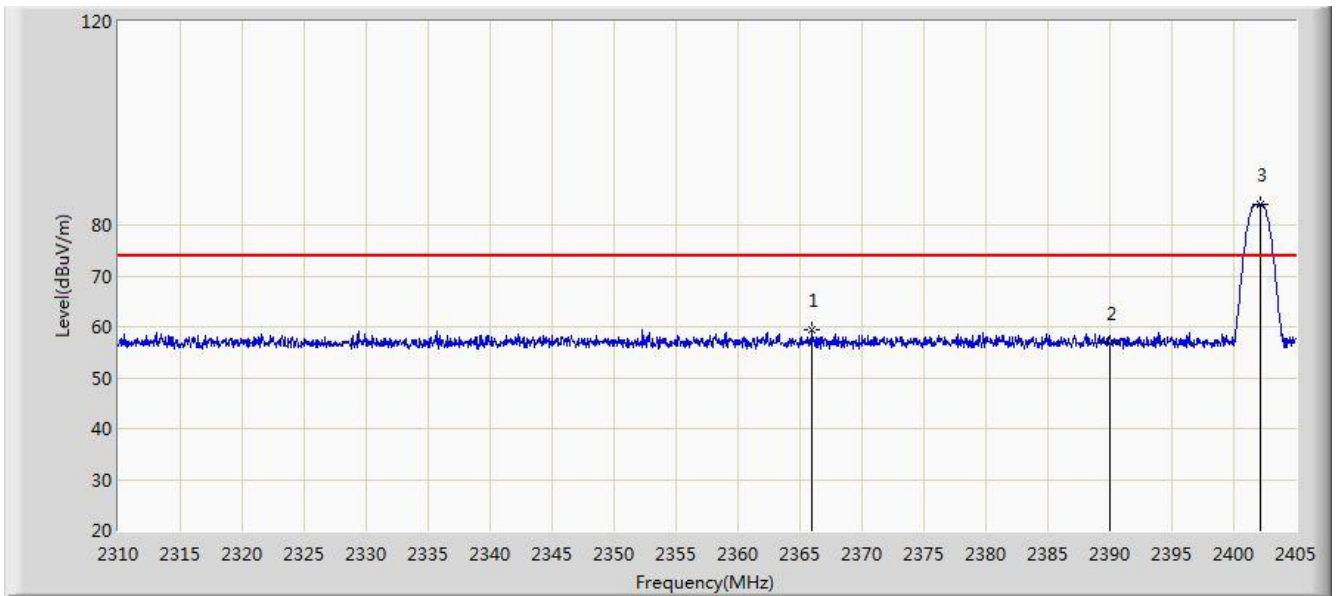

No	Flag	Mark	Frequency (MHz)	Measure Level (dBuV/m)	Reading Level (dBuV)	Over Limit (dB)	Limit (dBuV/m)	Factor (dB)	Type
1			2366.002	59.327	26.962	-14.673	74.000	32.365	PK
2			2390.000	56.712	24.385	-17.288	74.000	32.327	PK
3		*	2402.198	84.196	51.892	N/A	N/A	32.304	PK

Note: Measure Level (dB μ V/m) = Reading Level (dB μ V) + Factor (dB)

Factor (dB) = Cable Loss (dB) + Antenna Factor (dB/m).

Site: AC1	Time: 2019/03/06 - 06:52
Limit: FCC_Part15.209_RE(3m)	Engineer: Messiah Li
Probe: BBHA9120D_1-18GHz	Polarity: Vertical
EUT: Bluetooth + Voice + IR Remote Controller	Power: By Battery
Test Mode: Transmit by Bluetooth-BLE at channel 2402MHz	

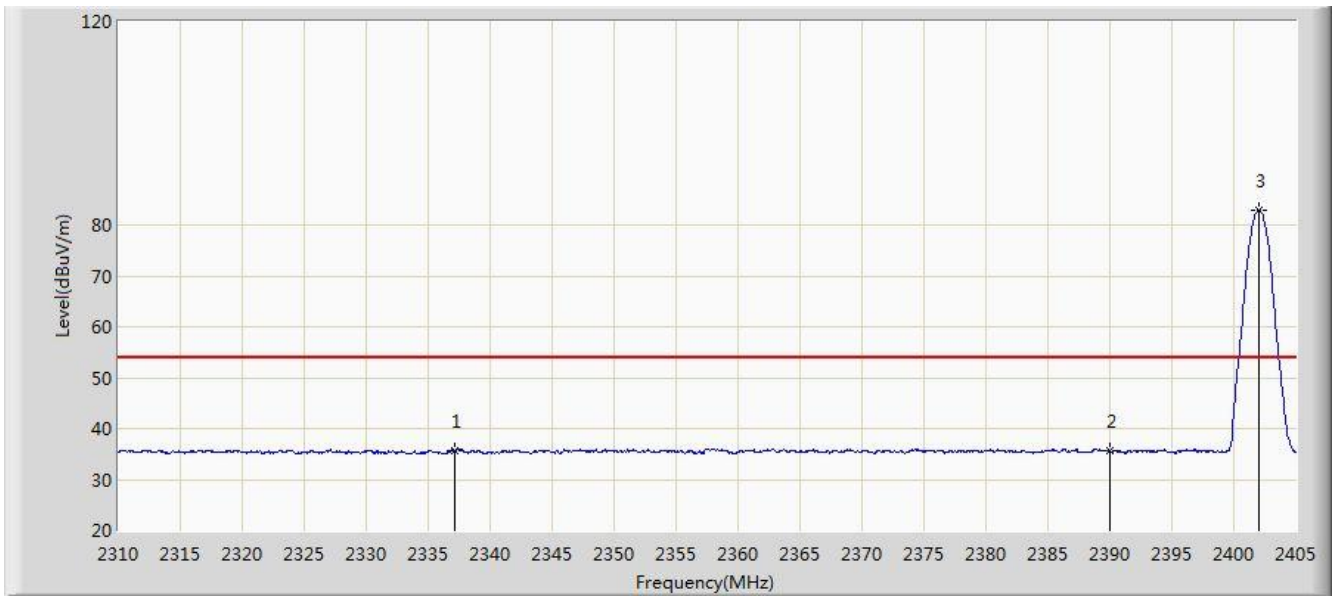

No	Flag	Mark	Frequency (MHz)	Measure Level (dBuV/m)	Reading Level (dBuV)	Over Limit (dB)	Limit (dBuV/m)	Factor (dB)	Type
1			2337.123	35.741	3.298	-18.259	54.000	32.443	AV
2			2390.000	35.574	3.247	-18.426	54.000	32.327	AV
3		*	2402.008	82.903	50.599	N/A	N/A	32.305	AV

Note: Measure Level (dB μ V/m) = Reading Level (dB μ V) + Factor (dB)

Factor (dB) = Cable Loss (dB) + Antenna Factor (dB/m).

Site: AC1	Time: 2019/03/06 - 06:53
Limit: FCC_Part15.209_RE(3m)	Engineer: Messiah Li
Probe: BBHA9120D_1-18GHz	Polarity: Horizontal
EUT: Bluetooth + Voice + IR Remote Controller	Power: By Battery
Test Mode: Transmit by Bluetooth-BLE at channel 2480MHz	

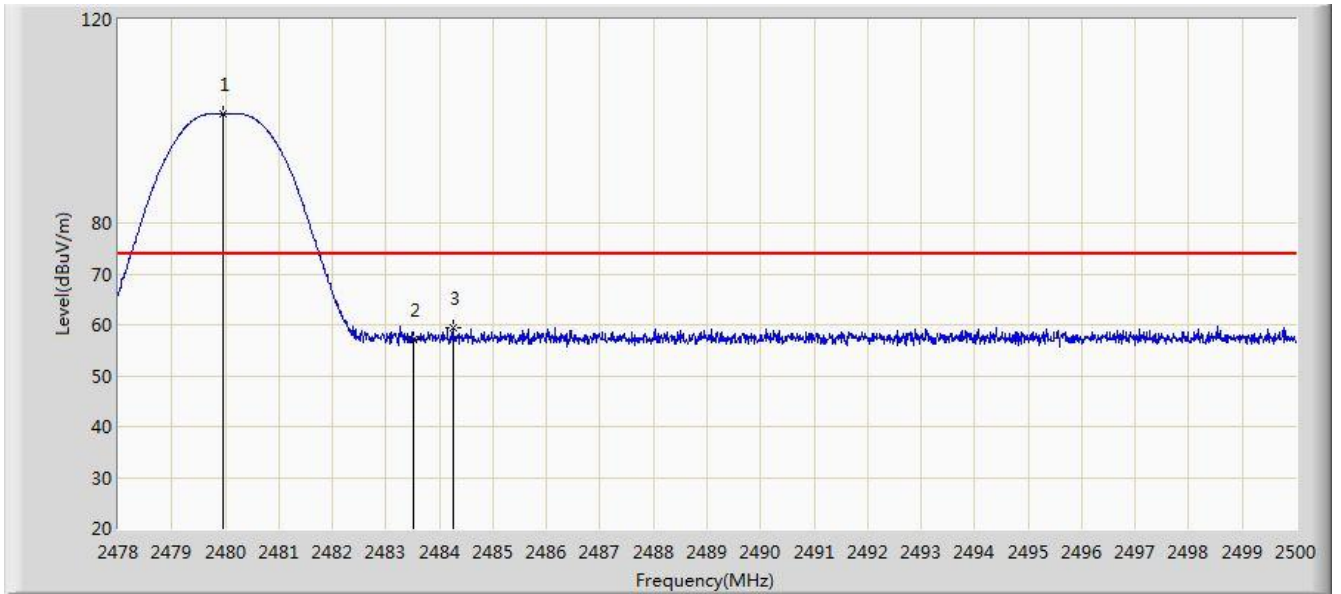

No	Flag	Mark	Frequency (MHz)	Measure Level (dBuV/m)	Reading Level (dBuV)	Over Limit (dB)	Limit (dBuV/m)	Factor (dB)	Type
1		*	2479.969	101.333	69.008	N/A	N/A	32.325	PK
2			2483.500	57.047	24.708	-16.953	74.000	32.340	PK
3			2484.248	59.484	27.142	-14.516	74.000	32.342	PK

Note: Measure Level (dB μ V/m) = Reading Level (dB μ V) + Factor (dB)

Factor (dB) = Cable Loss (dB) + Antenna Factor (dB/m).

Site: AC1	Time: 2019/03/06 - 06:56
Limit: FCC_Part15.209_RE(3m)	Engineer: Messiah Li
Probe: BBHA9120D_1-18GHz	Polarity: Horizontal
EUT: Bluetooth + Voice + IR Remote Controller	Power: By Battery
Test Mode: Transmit by Bluetooth-BLE at channel 2480MHz	

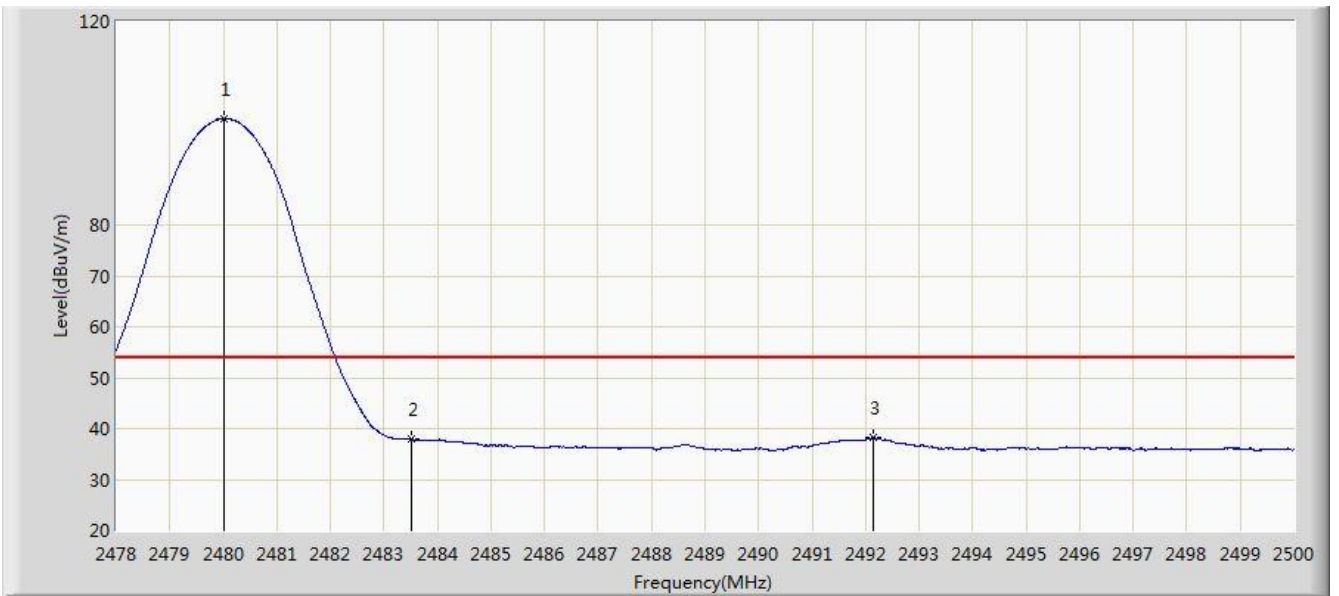

No	Flag	Mark	Frequency (MHz)	Measure Level (dBuV/m)	Reading Level (dBuV)	Over Limit (dB)	Limit (dBuV/m)	Factor (dB)	Type
1		*	2480.002	100.886	68.561	N/A	N/A	32.325	AV
2			2483.500	37.914	5.575	-16.086	54.000	32.340	AV
3			2492.135	38.188	5.815	-15.812	54.000	32.373	AV

Note: Measure Level (dB μ V/m) = Reading Level (dB μ V) + Factor (dB)

Factor (dB) = Cable Loss (dB) + Antenna Factor (dB/m).

Site: AC1	Time: 2019/03/06 - 06:57
Limit: FCC_Part15.209_RE(3m)	Engineer: Messiah Li
Probe: BBHA9120D_1-18GHz	Polarity: Vertical
EUT: Bluetooth + Voice + IR Remote Controller	Power: By Battery
Test Mode: Transmit by Bluetooth-BLE at channel 2480MHz	

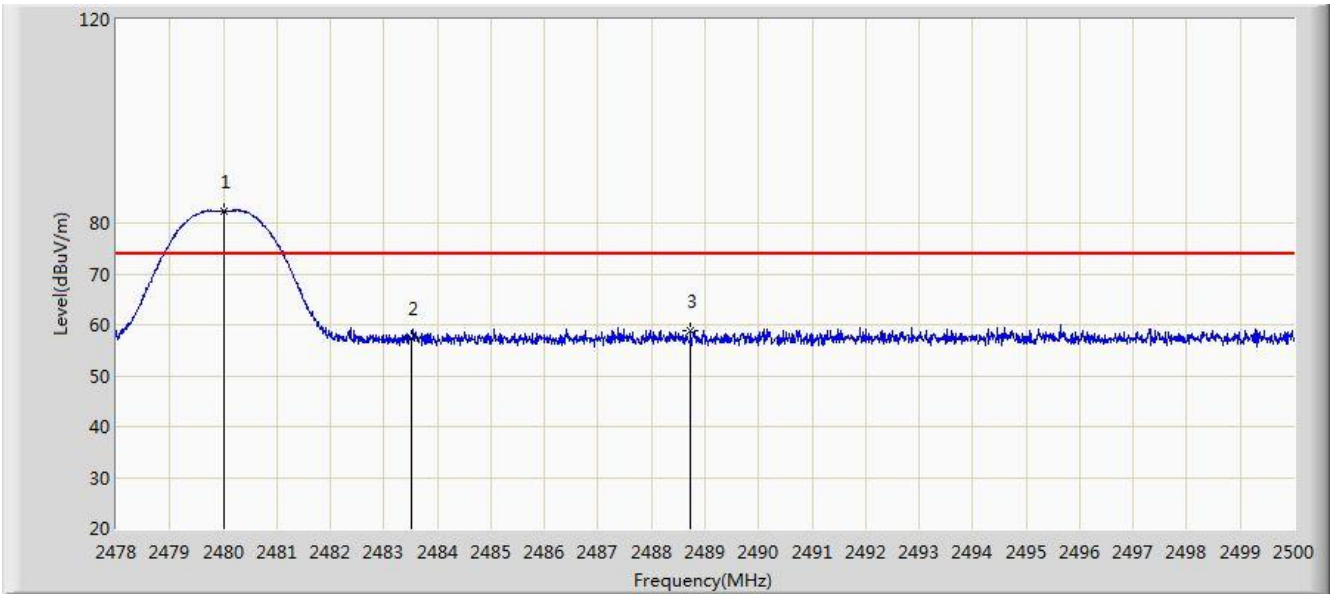

No	Flag	Mark	Frequency (MHz)	Measure Level (dBuV/m)	Reading Level (dBuV)	Over Limit (dB)	Limit (dBuV/m)	Factor (dB)	Type
1		*	2480.013	82.352	50.027	N/A	N/A	32.325	PK
2			2483.500	57.419	25.080	-16.581	74.000	32.340	PK
3			2488.736	58.742	26.382	-15.258	74.000	32.360	PK

Note: Measure Level (dBμV/m) = Reading Level (dBμV) + Factor (dB)

Factor (dB) = Cable Loss (dB) + Antenna Factor (dB/m).

Site: AC1	Time: 2019/03/06 - 07:00
Limit: FCC_Part15.209_RE(3m)	Engineer: Messiah Li
Probe: BBHA9120D_1-18GHz	Polarity: Vertical
EUT: Bluetooth + Voice + IR Remote Controller	Power: By Battery
Test Mode: Transmit by Bluetooth-BLE at channel 2480MHz	

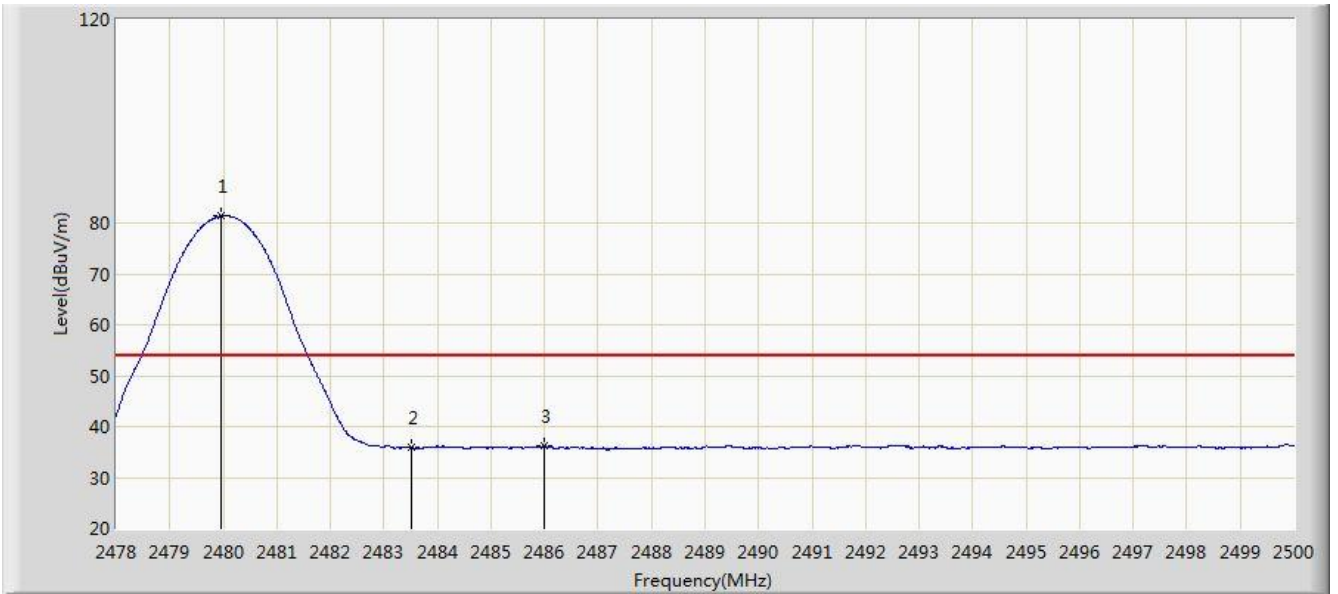

No	Flag	Mark	Frequency (MHz)	Measure Level (dBuV/m)	Reading Level (dBuV)	Over Limit (dB)	Limit (dBuV/m)	Factor (dB)	Type
1		*	2479.947	81.350	49.025	N/A	N/A	32.325	AV
2			2483.500	35.927	3.588	-18.073	54.000	32.340	AV
3			2485.997	36.170	3.821	-17.830	54.000	32.349	AV

Note: Measure Level (dBμV/m) = Reading Level (dBμV) + Factor (dB)

Factor (dB) = Cable Loss (dB) + Antenna Factor (dB/m).

7.8. AC Conducted Emissions Measurement

7.8.1. Test Limit

FCC Part 15 Subpart C Paragraph 15.207 Limits		
Frequency (MHz)	QP (dBuV)	AV (dBuV)
0.15 ~ 0.50	66 ~ 56	56 ~ 46
0.50 ~ 5.0	56	46
5.0 ~ 30	60	50

Note 1: The lower limit shall apply at the transition frequencies.

Note 2: The limit decreases linearly with the logarithm of the frequency in the range 0.15MHz to 0.5MHz.

7.8.2. Test Setup

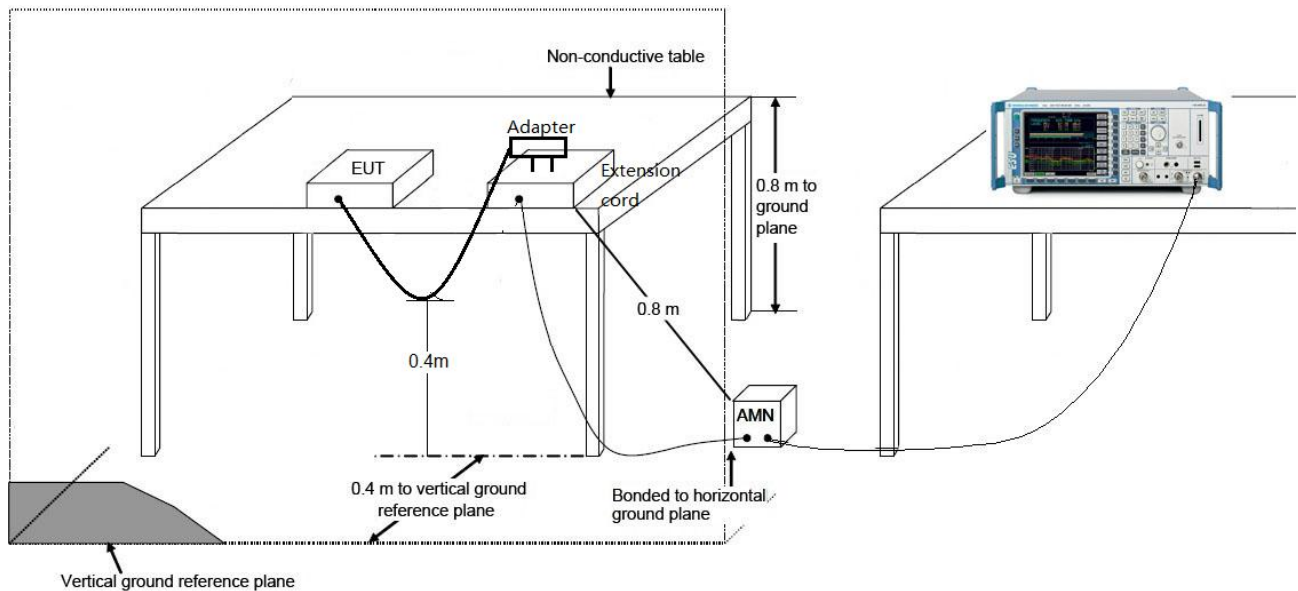

7.8.3. Test Result

The EUT is powered by battery, so this test item is not applicable.

8. CONCLUSION

The data collected relate only the item(s) tested and show that the **Bluetooth + Voice + IR Remote Controller** is in compliance with Part 15C of the FCC rules and ISED rules.

_____ The End _____

Appendix A - Test Setup Photograph

Refer to "1903RSU004-UT" file.

Appendix B - EUT Photograph

Refer to "1903RSU004-UE" file.